

Table of Contents

How To Use	1	Passenger Car Gaskets (Model Related) (Cont.)	
Abbreviation Guide	2	Eagle Chrysler.....	692
Sealing Solutions	7	Ford.....	692
Superflex and Extended Case Timing Cover Seal	39	General Motors Corp.....	708
VIN Code Charts	45	Honda.....	743
Fuel Injection Systems	55	Mazda.....	744
Performance	56	Mitsubishi.....	744
Custom Performance.....	58	Nissan.....	745
American Motors.....	58	Opel.....	746
Chrysler.....	58	Renault.....	747
Ford.....	63	Saab.....	747
General Motors Corp.....	75	Studebaker.....	747
Honda.....	99	Subaru.....	747
Mazda.....	101	Toyota.....	748
Mitsubishi.....	101	Volkswagen.....	749
Subaru.....	102	Light Truck Gaskets (Engine Related)	750
Toyota.....	102	Acura Truck.....	750
Passenger Car Gaskets (Engine Related)	114	Dodge Truck.....	750
Acura.....	114	Ford Truck.....	791
American Motors.....	121	General Motors Truck.....	861
Asuna.....	132	Honda Truck.....	944
Audi.....	133	Hummer.....	948
Austin.....	147	Hyundai Truck.....	949
BMW.....	149	Infiniti Truck.....	950
Checker Motors.....	154	Isuzu Truck.....	950
Chrysler.....	165	Jeep.....	959
Daihatsu.....	221	Kia Truck.....	976
Eagle Chrysler.....	221	Lexus Truck.....	976
Fiat.....	232	Mack.....	977
Ford.....	236	Mazda Truck.....	977
General Motors Corp.....	322	Mercedes Benz Truck.....	987
Honda.....	466	Mitsubishi Truck.....	988
Hudson.....	501	Navistar/International.....	996
Hyundai.....	501	Nissan Truck.....	1030
Infiniti.....	507	Studebaker Truck.....	1040
Isuzu.....	509	Subaru Truck.....	1042
Jaguar.....	514	Suzuki Truck.....	1044
Kaiser-Frazer.....	515	Toyota Truck.....	1046
Kia.....	516	Volkswagen Truck.....	1062
Lexus.....	516	Volvo Truck.....	1071
MG.....	519	Winnebago.....	1071
Mazda.....	520	Light Truck Gaskets (Model Related)	1072
Mercedes Benz.....	537	Dodge Truck.....	1072
Mitsubishi.....	541	Ford Truck.....	1098
Nash.....	559	General Motors Truck.....	1110
Nissan.....	560	Hummer.....	1148
Opel.....	587	Isuzu Truck.....	1148
Passport.....	588	Jeep.....	1149
Peugeot.....	588	Mazda Truck.....	1166
Porsche.....	590	Mitsubishi Truck.....	1166
Renault.....	591	Navistar/International.....	1167
Saab.....	594	Nissan Truck.....	1184
Saturn.....	595	Subaru Truck.....	1184
Sterling.....	596	Toyota Truck.....	1184
Studebaker.....	598	Volkswagen Truck.....	1185
Subaru.....	603	Collector and Muffler Gasket	1186
Suzuki.....	608	Axle Nomenclature	1187
Toyota.....	609	Axle Shaft Gaskets ID Charts	1188
Triumph.....	640	Axle Model and Transmission Identification Pass Car	1190
Volkswagen.....	642	Axle Model and Transmission Identification Light Truck	1196
Volvo.....	667	Exhaust Pipe Gaskets	1201
Yugo.....	674	Valve Stem Seal Specifications	1203
Passenger Car Gaskets (Model Related)	676	Harmonic Balancer and Crankshaft Oil Seal Groove Repair	
American Motors.....	676	Sleeves	1210
Audi.....	677	Cylinder Head Bolt Gasket to Cylinder Head Bolt Interchange	
Chrysler.....	677	1211

Table of Contents (Cont.)

Gasket Hole Punch Set	1212	O Ring Assortments	1217
Gasket Materials	1213	O Ring Size Listing	1218
Bulk Material	1214	Stocking and Merchandising Aids	1220
Assortments	1216	Measurement Equivalents	1223

For Technical Service Call:

1-800-248-9606

Use Of Clevite, Perfect Circle, Victor Reinz and Beck/Arnley Products In Aircraft Or Other Specialty Equipment May Be A Violation Of Local, State or Federal Regulatory Agency Laws, Rules And Regulations.

These products are intended solely for automotive applications. Under absolutely NO circumstances should these products ever be used in non-automotive applications including, without limitation, aircraft engines, medical equipment, atomic energy devices or reactors.

"Federal, State and local laws restrict the removal, rendering inoperative, or in some cases the modification of factory installed emission devices or systems. California restricts the use of parts which could increase emissions in vehicles designed for use on public streets or highways. The sale or installation on emission controlled vehicles of certain emission control components not approved by the California Air Resources Board, which alter or modify the original design or performance of such vehicle's emission control system is prohibited. Some of the parts listed and offered for sale in this catalog may fall within the above restrictions. Such parts are intended only for use on off-road vehicles competing in competitive events or on other types of vehicles which are exempt from the applicable emission control laws. Installation of these parts on vehicles subject to emission control laws may be prohibited. Dana recommends that the applicable emission control laws be reviewed before considering the installation of add-on or modified parts."

Teflon and Viton are registered trademarks of DuPont Corporation.

© 2004 Dana Corporation

How To Use This Gasket Parts Catalog

The Master Gasket Catalog is divided into two main application sections: Passenger Car and Light Truck. Each section is easily located by using the shaded tab areas found on the edge of each catalog page.

Listings are arranged by liter size in ascending order in the main gasket and miscellaneous gasket sections.

Select the appropriate model from the model index and locate the applicable engine. Proceed to the applicable engine in the engine index, which precedes each vehicle listing. Refer to the block shown for that engine, check the "Engine Heading" and select the part by name, the applicable year, the model and then the part number.

VIN CODES

With this catalog you will find late model vehicle identification code listing (VIN Codes) with each catalog listing. These VIN codes will be helpful in identifying late model engines. The VIN codes may be easily identified from the vehicle identification plate located on the dashboard and may be viewed through the windshield on the driver's side of the vehicle.

Each engine listing is divided into the following:

Main Gasket Section

- Includes major gasket sets and related items
Arranged by popularity
 - Head Set
 - Lower Set
 - Full Set
 - Engine Kit Gasket Set
 - Etc.

Miscellaneous Gasket Section

- Includes all engine gaskets and seals not listed in main section
Arranged in alphabetical order
 - Air Cleaner Gasket
 - Carburetor Mounting Gasket
 - Distributor Mounting Gasket
 - Etc.

Chassis related gaskets are located at the back of both the passenger car section and light truck section. They are easily identifiable by the shaded tab areas at the bottom outside edge of each catalog page. These gaskets are listed first by model name and second by product name.

Axle Shaft Gaskets

Arranged by make and model name

Differential Housing Covers Gaskets

Arranged by make and model name

- Axle Housing Cover Gaskets and Differential Carrier Gaskets

Transmission Gaskets

- Includes all transmission gaskets arranged by make and model name
 - Electric Shift Cover Gaskets
 - Power Take Off Cover Gasket
 - Transmission Gasket Set
 - Etc.

Material type is shown to assist part selection.

TRADUCCIÓN

Inglés a Español

above arriba	combination combinacion	faced fresado
abbreviation abreviacion	combustion combustion	felt fieltro
adapter adaptador	commercial comercial	fiber fibra
after despues	complete completo	figure figura
aftercooler post refrigerador	compression compresion	filter filtrar
agricultural agricola	contains contiene	final ultimo
air cleaner depurador de aire	continued continuado	fire dam presa de fuego
air compressor ... compresor de aire	contoured contorno	flange brida
air conditioning acondicionador de aire	conventional convencional	flat plano
air cooled enfriado por aire	converter convertidor	floor piso
airflow sensor detector del flujo de aire	cooler heladera	fluid fluido
all todo	core centro	flywheel volante
alloy aleacion	cork corcho	for por, para
altitude altitud	corner yincon	forklift camion con elevador de horquilla
aluminum aluminio	cover tapa	from desde
application aplicacion	crankcase carter	front frente
asbestos asbesto	crankshaft arbol ciguenal	fuel combustible
aspirate aspirar	crawler dozer	full lieno
assortment variedad	crossflow corriente transversal	full set juego completo
automatic automatico	crossover curva de pase	
auxiliary auxiliar	cylinder head cabeza de cilindros	gasoline gasolina
available desponible	cylinder liner camisa de cilindro	gasket empaquetadura
axle eje		gear engranaje
		generator generador
back parte posterior	damper registro	governor regulador
backing tira de respaldo	data datos	grader niveladora
balance shaft eje de balance	design diseno	grommet arandela
barrel gargantas	diameter diametro	groove estria
bead cuenta	diesel diesel	
beaded steel acero con reborde	differential diferencial	hand mano
bearing cojinete	disc brakes freno de discos	harmonic balancer amortiguador de vibracion
before antes	dispenser dispesar	harvester maquina cochedora
between en medio	displacement desplazamiento	head cabeza
block bloque	distributor distribuidor	head gasket empaque de cabeza
body cuerpo	divider compas de division	head set juego de cabeza
bolt perno	does not contain .. no incluye	heat calor
bore alesaje	double doble	heavy duty servicio pesado
bowl tazon	dozer dozer	heavy truck camion pesado
box cajon	drain desague	hemispherical hemisferico
brake freno	drive propulsion	high alto
built construido	drivetrain tren propulsor	high output alto rendimiento
bulk material material en granel	drum brakes freno de tambor	hole hueco
bypass derivacion	dry arido	housing caja
	dual doble	
cam/camshaft eje de levas	dust polvo	identification identificacion
cap tapa		ignition ignicion
carbon carbono	early temprano	industrial industrial
carburetor carburador	edge borde	injection inyeccion
carrier conductor	elbow codo	inlet admision
cast iron hierro colado	electric electrico	inner interior
catalog catalogo	electronic electronico	install instalar
catalytic catalitico	embossed en relieve	insulator insulador
center centro	emission emanaciones	intake admision
central fuel inj. ... inyector de combustible	encased encajado	interchange intercambio
central	end extremidad	intercooler interenfriador
chamber camara	engine motor	intermediate intermedio
change cambio	equivalent equivalente	internal interno
chart cuando	evaporative evaporativo	inventory inventario
choke estrangulador	excessive excesivo	
clamped fijado	exhaust escape	kit kit (juego)
closed cerrado	explanation explicacion	
clutch embrague	export exportacion	large grande
code codigo	extension extension	last ultimo
column columna	external externo	
combine(d) combinar		

TRADUCCIÓN

Inglés a Español (cont.)

late	tarde	premium	superior	speed	velocidad
left	izquierda	pressed	apretado	spring	resorte
length	longitud	pressure	presion	square	cuadro
light duty	servicio liviano	prior	anterior	stainless steel	acero inoxidable
light truck	camion liviano	protrusion	sobresalir	stamped	estampado
lip	reborde	pump	bomba	standard	estandar
listing	inscripcion	punch	perforacion	steel	acero
liter	litro	push rod	levanta valvula	straight	colcho
loader	cargador			strainer	coladera
long	largo	ratio	relacion	stud	perno
low	bajo	rear	trasero	supercharger	sobrealimentador
lower	inferior	rear main seal	reten del cojinete	swirl	movimiento espiral
lower set	juego inferior		bancada trasero		
		recommend	recomendat	tachometer	tacometro
magneto	magnet	refaced	refrentado	tapered	candela
main	principales	regular	regular	temperature	temperatura
manifold	multiple	related	relatado	thermostat	termostato
manual	manual	relief	relieve	thick	grueso
marine	marino	removed	eliminar	thin	delgado
material	material	repair sleeve	camisa de reparacion	throttle	regulador
medium duty	servicio mediano	replaced	repuesto	timing cover	tapa de regulacion
miscellaneous	miscelaneo	replacement	substitucion	torque	par de torsion
model	modelo	required	requirido	tractor	tractor
molded	moldeado	resonator	resonador	transaxle	transeje
mounting	montaje	resurfaced	repulir	transfer case	caja transferia
muffler	silenciador	retainer	reten	tranmission	transmision
		reverse	reverso	triangular	triangular
nomenclature	nomenclatura	right	derecho	truck	camion
not available	no disponible	ring	anillo	tube	tubo
not included	no incluido	riser	tubo ascendente	turbocharger	turboalimentador
		rocker arm	balancin	twin cam	levas gemelas
"o" ring	aros "o"	rolls	rollos	type	tipo
oil	aceite	rope	cuerda	typical	tipico
oil pan	colector de aceite	rotation	rotacion		
one piece	una pieza	rubber	caucho	umbrella	paraguas
only	solamente			unit	unidad
opposite	opuesto	same	identico	universal	universal
optional	opcional	seal	reten	universal joint	junta universal
other	opuesto	section	seccion	upper	superior
outer	exterior	see	vease	use	uso, empleo
outlet	salida	segmented	segmento		
output	rendimiento	semi-circular	semicircular	vacuum	vacuo
oval	oval	separate	individual	valve	valvula
overbore	sobre calibre	sequence	secuencia	valve cover	tapa balancines de
overhaul	arreglar	serial number	número de serial		valvula
overhead	de culata	set	juego	valve grind set ...	juego para
		shaft	eje	rectificacion de valvulas	
package	paquete	shedder	gotear	valve stem	varilla de valvula
packing	embalaje	sheet	hoja	valve stem seal ..	reten del vastago valvula
page	pagina	shell	casco	vehicle	vehiculo
pan	colector	shield	protector	vent	abertura, escape
part	pieza	shift	cambio	version	version
passenger	pasajero	shim	calzo		
passenger car	automovil	short	corto	washer	arandela / anillo
performance	funcionamiento	shoulder	respaldo	water	agua
pipe	tubo	side	lado	water cooled	enfriado por agua
piston	piston	silencer	silenciador	water outlet	salida del agua
plastic	plastico	single	sencillo	water pump	bomba de agua
plate	placa	sintered metal	metal comprimiso	wear sleeve	camisa de desgaste
plenum	camara de pleno	size	tamano	wet	humedo
plug	tapon	sleeve	manguita	wide	ancho
police car	automovil policia	small	pequeno	width	anchura
port	tubo, puerto	smooth	liso	wipers	limpiaparabrisas
positive	positivo	spacer	espaciador	wound	bobinado
pound	libra	spark plug	bujia de encendido		
power	fuerza	special	especial	year	ano

TRADUCTIONS

Anglais à français

above au-dessus	combustion combustion	fiber fibre
abbreviation abréviation	commercial commercial	figure figure, silhouette
adapter adapteur	complete complète	filter filtre
after après	compression compression	final dernier
after cooler refroidisseur arrière	contains contient	fire dam cloison pare-feu
agricultural agriculture	continued à suivre	flange flasque, bride
air cleaner filtre à air	contoured courbé	flat plat
air compressor ... compresseur d'air	conventional classique	floor plancher
air conditioning climatisation	converter convertisseur	fluid liquide
air cooled refroidi d'air	cooler refroidisseur	flywheel volant-moteur
airflow sensor capteur d'air	core noyau, centre	for pour
all tout	cork liège, bouchon	forklift chariot élévateur
alloy alliage	corner coin	from de
altitude altitude	cover couvercle	front avant
aluminum aluminium	crankcase carter	fuel carburant
application application	crankshaft vilebrequin, arbre moteur	full plein
asbestos amiante	crawler maraudeur	full set jeu complet
aspirate aspirer	crossflow faisceau horizontal	gasoline gaz
assortment assortiment	crossover coude de croisement	gasket joint de culasse
automatic automatique	cylinder head chemise de culasse	gear engrenage
auxiliary auxiliaire	cylinder liner chemise	generator générateur
available disponible	cylindrical cylindrique	governor régulateur
axle arbre de roue		grader niveleuse
	damper amortisseur	grommet oeillet
back arriere	data donnée	groove gorge
backing soutien, renforcement	design dessein	hand main
balance shaft arbre balancé	diameter diamètre	harmonic balancer équilibreuse harmonique
barrel corps(de carburateur)	diesel diesel	harvester moissonneuse
bead bourrelet	differential différentiel	head culasse
beaded steel acier emperlé	disc brakes frein à disc	head set pochette rodage
bearing palier	dispenser distributeur	heat chaleur
before avant	displacement cylindrée	heat riser volet de réchauffer
between entre	distributor distributeur	heavy duty pour service intense
block bloc	divider compas droit	heavy truck camion poids lourd
body carrosserie	does not contain .. ne contient pas	hemispherical hémisphérique
bolt boulon	double double	high haut, élevé
bore alésage	dozer bulldozer, chasse-terre	high output dosage de puissance élevée
bowl cuve	drain vidanger, purger	hole trou
box boîte	drive entraînement	housing carter, carcasse
brake frein	drivetrain groupe propulseur	
built construit	drum brakes tambour de freins	identification identification
bulk material matériel en vrac	dry sec, seche	ignition allumage
bypass conduit de dérivation	dual à deux, double	industrial industriel
	dust poussière	injection injection
cam/camshaft arbre à cames		inlet orifice d'aspiration
cap chapeau	early tôt	inner intérieur
carbon carbone	edge bord, rebord	install installer
carburetor carburateur	elbow coude	insulator isolant
carrier support	electric électrique	intake admission
cast iron fonte	electronic électronique	interchange interchange
catalog catalogue	embossed en bosse, en relief	intercooler refroidisseur intermédiaire
catalytic catalytique	emission échappement	intermediate intermédiaire
center centre	encased renfermé	internal interne
central fuel inj. ... injection centrale de carburant	end extrémité	inventory inventaire
chamber chambre	engine moteur	kit trousse
change changement	equivalent équivalent	large grand, gros
chart tableau	evaporative évaporatif	last dernier
choke volet de départ	excessive trop, excessif	late tard
clamped serré	exhaust échappement	left gauche
closed fermé	explanation explication	length longueur
clutch embrayage	export exportation	light duty pour service légère
code code	extension rallongement	
column colonne	external extérieur	
combination combinaison	faced à garniture	
combine(d) combiné(r)	felt feutre	

TRADUCTIONS

Anglais à français (suite)

light truck camionnette	pressed estampé	speed vitesse
lip rebord, lèvre	pressure pression	spring ressort
listing liste, index	prior avabt, antérieur	square carré
litre litre	protrusion saillie	stainless steel acier inoxydable
loader chargeuse	pump pompe	stamped estampe
long long, longue	punch poinçon	standard standard
low bas, basse	push rod tige de culbuteur	station wagon station-wagon
lower inférieur		stationary fixe
lower set jeu pour bloc-cylindres		steel acier
	ratio proportion, rapport	straight droit, rectiligne
magneto magnétique	rear arrière	strainer tamis
main principal	rear main seal joint d'arrêt d'huile du palier arrière	stud boulon, tige
manifold collecteur	recommend recommander	supercharger compresseur
manual manuel	refaced reusiné	swirl tourbillon
marine marin	regular regulier, normal	
material matériel	related connexe	tachometer tachymètre
medium duty pour service moyenne	relief de sûreté	tapered effilé
miscellaneous varié, divers	removed enlevé	temperature température
model modèle	repair sleeve chemise de réparations	thermostat thermostat
molded moulé	replaced remplacé	thick épais
mounting support	replacement remplacement	thin mince
muffler silencieux	required nécessaire, requis	throttle papillon de gaz
	resonator silencieux auxiliaire	timing cover carter de distribution
nomenclature nomenclature	resurfaced reusiné	torque torque
not available pas disponible	retainer retenue	tractor tracteur
not included pas inclus	reverse marche arrière	transaxle essieu transversal
	right droite	tranfer case boîte de transfer
"o" ring joint torique	ring segment	transmission boîte de vitesses
oil huile	rocker arm calbuteur	triangular triangulaire
oil pan réservoir de l'huile	rolls rouleau	truck camion
one piece d'une pièce	rope corde	tube tuyau
only seulement	rotation rotation	turbocharger turbocompresseur
opposite opposé, contraire	round rond, cercle	twin cam à deux arbres à cames
optional facultatif	rubber caoutchouc	type type
other autre		typical typique
outer extérieur	same même	umbrella parapluie
outlet orifice de sortie	seal joint d'étanchéité	unit unité
output sortie	section segment, partie	universal universel
oval ovale	see voir	universal joint adaptateur cardan
overbore suralésage	segmented segmenté	upper superior
overhaul réfection	semi-circular demi-cercle	use emploi
overhaul set jeu de réfection	separate séparé, individuel	
overhead en tête	sequence suite, ordre	vacuum dépression
	serial number matricule	valve soupape
package paquet	set jeu, ensemble	valve cover couvre-culbuteurs
packing emballage	shaft arbre	valve grind set ... jeu de rectifieuse des soupapes
page page	shedder verseur	valve stem tige de soupape
pan réservoir	sheet tôle	valve stem seal .. joint d'essorage sur queuede soupape
part pièce	shell caisse, paroi	vehicle véhicule
passenger passager	shield protectrice	vent trou d'évent
passenger car automobile	shift changement	version version
performance fonctuinement	shim cale de réglage	
pipe tuyau	short court	washer rondelle
piston piston	shoulder épaule	water eau
plastic plastique	side côté	water cooled refroidi par l'eau
plate plaque	silencer silencieux	water outlet sortie d'eau
plenum plein d'aire	single seul, simple	water pump pompe à eau
plug bouchon	sintered metal métal fritté	wear sleeve bague d'usure
police car voiture de police	size dimension	wet mouillé
port orifice	sleeve manche	wheel roue
positive positif	small petit	wide large
pound livre	smooth lisse	width largeur
power puissance	spacer cale d'écartement	
premium de qualité	spark plug bougie d'allumage	
	special spécial	

ABBREVIATIONS

English to French/Spanish

A/C Air Conditioning Climatiseur Acondicionador de aire	E.G.R. Exhaust gas recirculation Recycle dez gaz d'enchappement Recirculacion de los gases del escape	Man. Manifold Collecteur Multiple	RWD Rear Wheel Drive Propulsion arriere Traccion Trasera
Adptr. ... Adapter Adaptateur Adaptador	Eng. Engine Moteur Motor	Max. Maximum Maximum Maximo	Sed. Sedan Berline Sedan
A.I.R. Air injection reactor Reacteur d'injection d'air Reactor a inyeccion por aire	Exc. Except Sauf Excepto	M/D Medium Duty Service Moyen Servicio Mediano	Ser. Serial, Series Serie Serie
Alum Aluminum Aluminium Alumino	Exh. Exhaust Echappement Escape de gases	Mdl. Model Modele Modelo	Sh. Shaft Arbre Eje
A.O.D. .. Automatic overdrive Surmultiplie automatique Sobremarcha automatico	Ext. Extension Rallongement Extension	Misc. Miscellaneous Divers Varios	SHO Super High Output Super Haute Performance Superior Alto Rendimiento
AR As required Comme necessaire Como sea requerido	Fig. Figure Figure Figura	mm Millimeter Millimetre Milimetro	Sl Sleeve Manche Manga
A/T Automatic transmission Boite de vitesse automatique Transmission automatico	F.I. Fuel injection Inyeccion d'essence Inyeccion de combustible	MFI Multi-Fuel Injection Injection d'essence orlices multiples Inyeccion de combustible de Tubo Multiple	S/N Serial Number N° de serie Numero de Serial
Auto. Automatic Automatique Automatico	Flywhl. . Flywheel Volant Volante	MPI Multi-Port Injection Injection par rampe à orlices multiples Inyección de Tubo Multiple	SOHC ... Single Overhead Cam Came unique en tête Culata de Arbol de Levas Única
B.C. Barrel carburetor Corps carburateur Venturi carburador	FWD Front Wheel Drive Traction avant Tracción Delantera	M/T Manual transmission Boite de vitesse manuel Transmision manual	Spd. Speed Vitesse Velocidad
Bef. Before Avant Antes	Gov. Governor Controleur Regulador	Mtg. Mounting Montage Montaje	Spec. Special Special Especial
Blt. Bolt Boulon Perno	Gskt. Gasket Joint Empaquetadura	Nat. Naturally Aspiration naturelle Naturalmente	Sta. Station Station Estacion
Br. Brake Frein Freno	GVW Gross vehicle weight P.T.C. Peso de Vehiculo Crudo	No. Number Numero Numero	Std. Standard Base Estandar
Brg. Bearing Palier Cojinetes	H/Alt. High altitude Haute altitude Alto altitud	NR Not required Pas necessaire No requerido	Strg. Steering Direction Dirección
Carb. Carburetor Carburateur Carburador	H/D Heavy duty Poids lourds Trabajos pesados	O.D. Outer diameter Diametre extérieur Diametro externo	TBI Throttle Body Injection Injection de melange dans le papillon des gaz Inyeccion de la valvula reguladora
cc Cubic centimeters Centimetre cube Centimetro cubico	H.O. High output Rendement eleve Alto rendimiento	O.E.M. .. Original Equipment Manufacturer Fabricant de matériel d'origine Fabricador de Equipo Original	T/E Thermactor Emission Emission Thermatique Emission Termica
C.F.I. Central fuel injection Injection centralizee Inyeccion central	H.P. Horse power Cheval-vapeur Caballos de fuerza	O.H.C. .. Overhead cam Arbre a cames en haut Culata de arbol de levas	Temp. Temperature Temperature Temperatura
C.I. Cast iron Fonte Hierro colado	HSC High swirl combustion Combustion a tourbillonnement eleve Combustion de alto moviento espiral	O.H.V. ... Overhead valve Soupape en haut Valvula de arbol de levas	Thru. Through A Por
C.I.D. Cubic inch displacement Cylindree Cilindrada en pulgas cubicicas	Hsg. Housing Logement Bastidor	Opt. Optional Facultatif Opcional	Trans. Transmission Transmission Transmision
Comp. .. Compressor Compresseur Compresor	Hvy. Heavy Poids lourds Pesado	O.S. Oversize Plus grand Sobre tamano	Trk. Truck Camion Camion
Cont. ... Continued A suivre Continuado	Hyd. Hydraulic Systeme hydraulique Hidraulico	Pass. Passenger Passager Pasajero	Trl. Trailer Remorque Remolque
Corp. Corporation Société Corporacion	I.D. Inner diameter Diametre interieur Diametro interno	P.C. Police car Voiture de police Automovil policial	Turbo Turbocharged Turbo-compresseur Turboalimentador
Cov. Cover Couvercle Cubierta	Ind. Industrial Industriel Industrial	Perf. Performance Performance Rendimiento	Univ. Universal Universel Uliversal
Ctr. Center Centre Centro	Inj. Injection Inyeccion Inyeccion	Pwr. Power Puissance Poder	VIN Vehicle Identification Number Numero d'identification du vehicule Numero de identificacion del vehiculo
Cyl. Cylinder Cylindre Cilindro	Int. Intake Admission Admision	Req'd Required Necessaire Requerido	w/ With Avec Con
Del. Delivery Livraison Entrega	Interm. .. Intermediate Intermediare Intermedio	Ret. Retainer Dispositif de retenue Reten	w/o Without Sans Sin
Dia. Diameter Diametre Diametro	L/D Light duty Service leger Servicio liviano	R.H. Right hand Cote droit Mano derecha	WD Wheel drive Traction Tracción
Diff. Differential Differentiel Diferencial	L.H. Left hand Cote gauche Mano izquierda	RTV Room temperature vulcanizing rubber (Silicone) Vulcanisation a la temperature de la piece (Silicone) Vulcanization a temperatura ambient (Silicio)	& And Et Y
DOHC ... Dual overhead cam Arbre a cames en haut Doble arboles de levas	Limo. Limousine Limousine Limosina		" Inch Po Pulgada
Dr. Drive Entrainement Propulsion	LPG Liquid petroleum gas Gas de petrole liquifie Gas de petroleo liquido		# Number, Pound Numero Numero
E.F.I. Electronic fuel injection Injection electronique Inyeccion electronica			

SEALING SOLUTIONS

VICTOR REINZ®
G A S K E T S

Chrysler 5.2L and 5.9L Front Timing Cover Gasket

Issue:

The front timing cover gasket on 1957 to 1989 Chrysler 5.2L (318 CID) engines and 1971 to 1980 Chrysler 5.9L (360 CID) engines has a tendency to tear because of the motion caused by the aluminum timing cover as it moves against the cast iron block. Once the gasket tears, coolant will leak from the engine, causing overheating and possible premature engine failure.

Resolution:

Victor Reinz offers a Performaseal® replacement gasket for these engines. The Performaseal gaskets are comprised of a woven, perforated steel core secured to a composition facing with an anti-stick coating. The facing resists oil, gasoline, anti-freeze, and other corrosives. Additionally, these gaskets provide a superior seal for irregular surfaces, minimal torque loss for a consistent load, and excellent radial strength to resist scrubbing and fretting caused by thermal expansion.

Application:

Victor Reinz part number T27787VC is available for 1957 to 1989 Chrysler 5.2L (318 CID) and 1971 to 1980 5.9L (360 CID) engines.

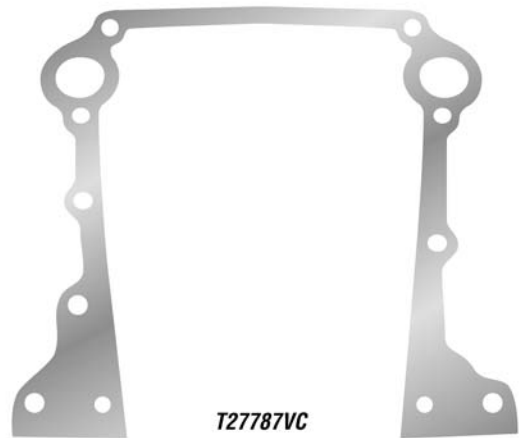

T27787VC

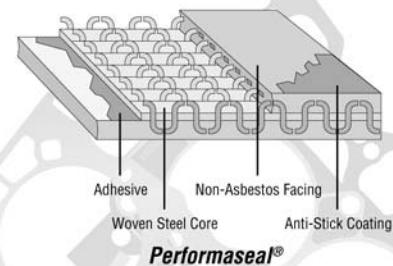

SEALING SOLUTIONS

VICTOR REINZ®
G A S K E T S

Chrysler (Mitsubishi) 3.0L Intake Manifold Gaskets

Issue:

Some Chrysler and Mitsubishi vehicles with 3.0L engines tend to develop coolant leaks in the lifter valley of the intake manifold gasket. These leaks occur because of the thermal expansion and contraction of the block and cylinder head during engine operation.

Resolution:

Victor Reinz has engineered an intake manifold gasket from VR-2000® material that uses mechanical beads in the material to eliminate the coolant leaks. Other gasket brands fail to take into consideration the motion or limited bolt load of the engine hardware, resulting in coolant leakage from the coolant opening after a few thermocycles. The Victor Reinz brand gasket features a perforated steel core clinched to its facing that seals with the limited load and recovers from the hardware's crushing effects. The gasket's design and Teflon® coating extend the life of the gasket, resulting in proven reliability.

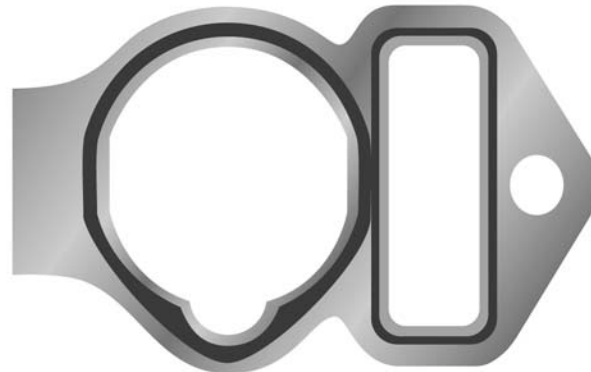

MS15444

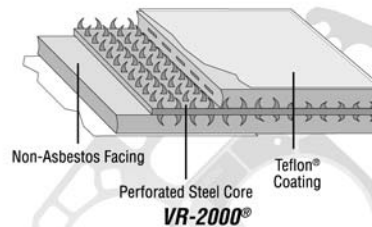

VR-2000®

Application:

Victor Reinz part number MS15444 is available for 1988 to 2000 Chrysler and Mitsubishi engines.

SEALING SOLUTIONS

VICTOR REINZ®
G A S K E T S

Ford Small Block V-8 Head Gasket

Issue:

Installing new head gaskets on late-model Ford small block V-8 engines can be confusing. The tendency is to install the gaskets with the lacing facing the same direction on both banks. This is incorrect because of the location of the coolant holes on the gaskets. Improper installation will lead to engine overheating and premature engine failure.

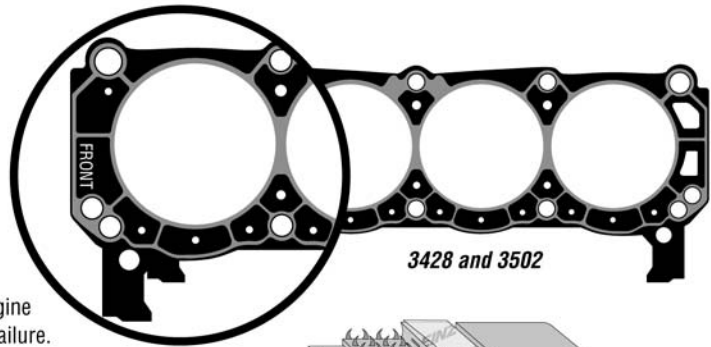

Resolution:

Victor Reinz replacement VR-2000® head gaskets use an "island sealing" concept with metal lacing that results in an improved coolant seal and limits head bending. To install the gaskets properly, the word "front" on the gaskets must be facing the front of the engine on both banks. The gasket lacing should be up on one side and down on the other side. If the gaskets are installed with the lacing in the same orientation on both sides, the rear coolant holes will be blocked, causing the engine to overheat.

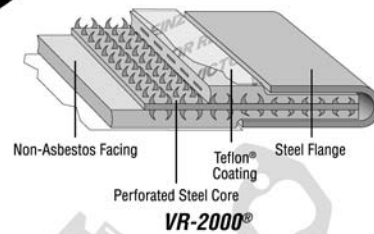

Application:

Victor Reinz part numbers 3428 and 3502 are available for 1968 to 2000 5.0L (302 CID) Ford engines, 1963 to 1968 4.7L (289 CID) Ford engines, 1969 to 1997 5.8L (351W) Ford engines, 1970 to 1974 5.8L (351C) Ford engines, and 1975 to 1982 5.8L (351M) / 6.6L (400M) Ford engines. Please consult your *Victor Reinz Catalog* for specific applications and part numbers.

SEALING SOLUTIONS

VICTOR REINZ®
G A S K E T S

Ford 3.8L Head Gasket

Issue:

Many 1982 to 1995 Ford 3.8L (232 CID) V-6 engines are prone to combustion seal failure. This usually happens when the engine has been remanufactured or when the cylinder head has been repaired. The failure occurs because the cylinder head and engine block have little tolerance for changes in bolt torque, hardware flatness, and surface finish.

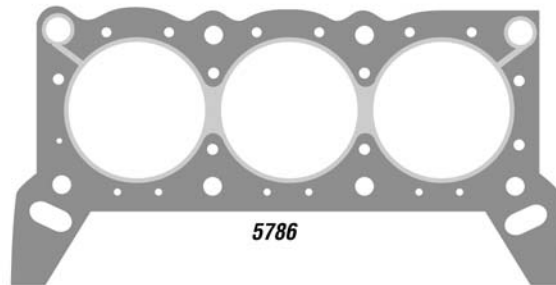

Resolution:

To successfully seal the engine, a controlled density graphite gasket must be used to allow the engine hardware to move without seal loss during thermal expansion of the cylinder head and block. Victor Reinz offers a Nitroseat® replacement head gasket for this engine. The unique gasket will compensate for the changes that occur when resurfacing the engine. The Nitroseat gasket features a Teflon®-coated, high density graphite material clinched to a perforated steel core. The design provides a superior micro-seal and resists gasket fretting.

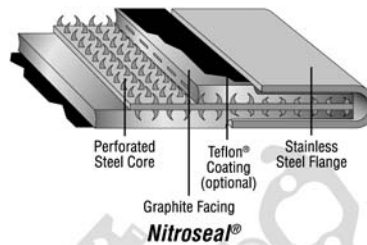

Application:

Victor Reinz part numbers 5816, 5815, and 5786 are available for 1982 to 1995 Ford 3.8L (232 CID) engines. (When installing the gasket, the condition of the sealing surface is critical. Use carbonless impression paper, part number JV311, to determine the engine's flatness.)

Note: Victor Reinz also recommends replacing the torque-to-yield head bolts, Victor Reinz part number GS33317, GS33219, or GS33194 when installing this gasket.

SS-VR-F-02

Printed in U.S.A.

© 2003 Dana Corporation

VICTOR REINZ®
G A S K E T S

Ford 4.6L Head Gasket

Issue:

1991 to 2001 Ford 4.6L (281 CID) engines use a multi-layered steel head gasket that requires an extremely smooth surface finish. Engine block and cylinder head flatness are also critical when replacing this gasket. If the vehicle manufacturer's surface finish and flatness specifications are not adhered to, gasket failure will result.

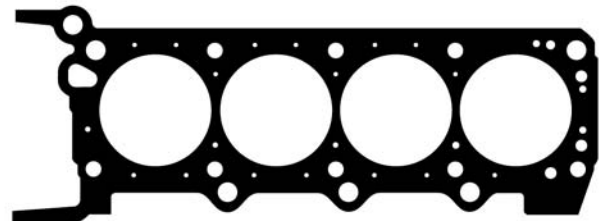

5931

Resolution:

Victor Reinz offers a Nitroseat® replacement head gasket for this engine. This gasket is a Teflon®-coated head gasket composed of solid graphite material clinched to a perforated steel core. This gasket features excellent sealing capabilities. The Teflon coating provides good cold flow sealing and lubricity to ensure a long service life. This Nitroseat gasket also offers thermal conductivity and excellent coolant, oil, and fuel resistance. In addition, it is more accommodating of surface finish and surface irregularities than the original-equipment design.

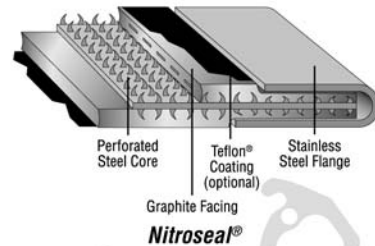

Application:

Victor Reinz Nitroseat head gaskets are available for these applications: 1991 to 2001 SOHC Ford 4.6L (281 CID) engines and 1993 to 1999 DOHC Ford 4.6L (281 CID) engines. To replace the head gasket, use Victor Reinz part numbers 5931 (left side) and 5932 (right side).

Note: Victor Reinz also recommends replacing the torque-to-yield head bolts, Victor Reinz part number GS33269 (two sets per engine), when installing this gasket.

SEALING SOLUTIONS

VICTOR REINZ®
G A S K E T S

Ford 2.3L Valve Cover Gasket

Issue:

When replacing a valve cover on 1986 to 1994 Ford 2.3L (140 CID) engines, it's easy to tear the valve cover seal. This is because the bead is permanently molded to the valve cover and replacement of the complete valve cover assembly is normally required.

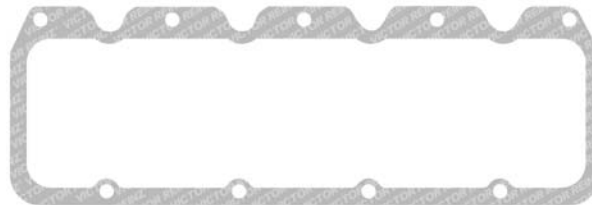

VS50027TC

Resolution:

Victor Reinz manufactures a Tuff-Cork® gasket for use with the vehicle's original valve cover. With Victor Reinz, you don't have to purchase a whole new valve cover just to solve a sealing problem. Just carefully remove the original, molded sealing bead, following the Victor Reinz instructions provided in the packaging. This procedure saves time and money by eliminating the need to buy a new valve cover.

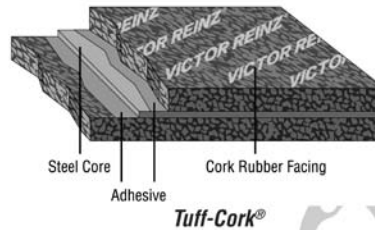

Tuff-Cork®

Application:

Victor Reinz part number VS50152HTC is available for 1989 to 1994 Ford 2.3L (140 CID) HSC OHV pushrod engines, and part number VS50027TC is available for 1985 to 1988 Ford 2.3L (140 CID) engines with aluminum valve cover only.

SEALING SOLUTIONS

VICTOR REINZ®
G A S K E T S

Ford Escort 1.6L and 1.9L Cylinder Head Gaskets

Issue:

Ford uses a two-millimeter thick head gasket on 1981 to 1985 1.6L (98 CID) engines and 1985 to 1996 1.9L engines to avoid piston-to-valve interference. Some replacement gasket manufacturers use additional facing material to achieve the correct gauge. This can make the gasket excessively soft, resulting in torque loss and gasket failure.

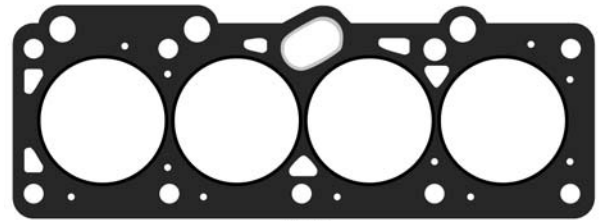

5884

Resolution:

Victor Reinz offers a head gasket manufactured from VR-500® material that uses a unique combination of graphite and three steel cores to increase core size while minimizing the facing thickness. This gasket restores the original-equipment operating thickness, resulting in minimum torque loss while maintaining the balance of the combustion and coolant seals.

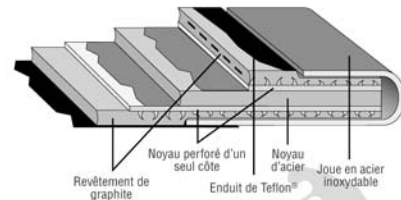

VR-500®

Application:

Victor Reinz part number 5739 is available for 1981 to 1985 Ford 1.6L (98 CID) engines and 1985 to 1990 Ford 1.9L (116 CID) engines, and part number is available for 5884 for 1991 to 1996 Ford 1.9L (116 CID) engines.

SEALING SOLUTIONS

VICTOR REINZ®
G A S K E T S

Ford 5.0L and 5.8L Valve Cover Gasket

Issue:

The original-equipment (OE) gasket design for late-model Ford 5.0L (302 CID) and 5.8L (351 CID) engines is a one-piece metal gasket with a molded rubber sealing bead. Technicians have asked the aftermarket to offer a replacement gasket that is identical to the OE design.



VS50203

Resolution:

Victor Reinz offers a Victo-Tech® replacement valve cover gasket, which consists of a thick steel core with a molded rubber sealing bead. In addition, the Victo-Tech gasket offers superior heat resistance and will not shrink after installation. The thick steel core assists in installation and also acts as a torque limiter.

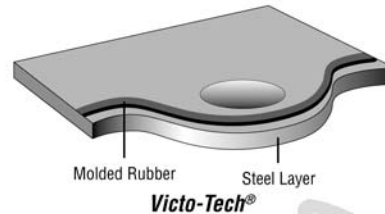

Victo-Tech®

Application:

Victor Reinz part numbers VS50203, a gasket set, and VS50203S, a single gasket for either side, are available for late-model Ford 5.0L (302 CID) and 5.8L (351 CID) engines.

Note: This gasket can be used on earlier Ford 5.0L (302 CID) and 5.8L (351 CID) engines.

SEALING SOLUTIONS

VICTOR REINZ®
G A S K E T S

Ford Timing Cover and Water Pump Gaskets

Issue:

Many late-model performance engines, including the 1965 to 1991 small block Ford engines, have timing cover and water pump gasket applications that are very difficult to seal. The gaskets traditionally used for these applications tend to leak.

Resolution:

Victor Reinz offers a line of Performaseal® gaskets for these tough to seal applications. The material used to make these gaskets was originally developed as head gasket material for industrial engines. The Performaseal gaskets are comprised of a woven, perforated steel core secured to a composition facing with an anti-stick coating. The facing resists oil, gasoline, anti-freeze, and other corrosives. These gaskets provide a superior seal for irregular surfaces, minimal torque loss for a consistent load, and excellent radial strength to resist scrubbing and fretting caused by thermal expansion.

Application:

Victor Reinz part number T27802VC, a timing cover gasket, and part number K27113VC, a water pump gasket, are available for 1965 to 1991 Ford engines.

Note: Victor Reinz also offers Performaseal gaskets for small block Chevrolet and small block Chrysler timing cover and water pump applications.

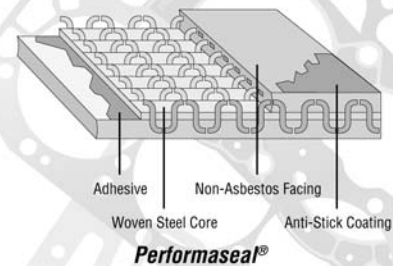
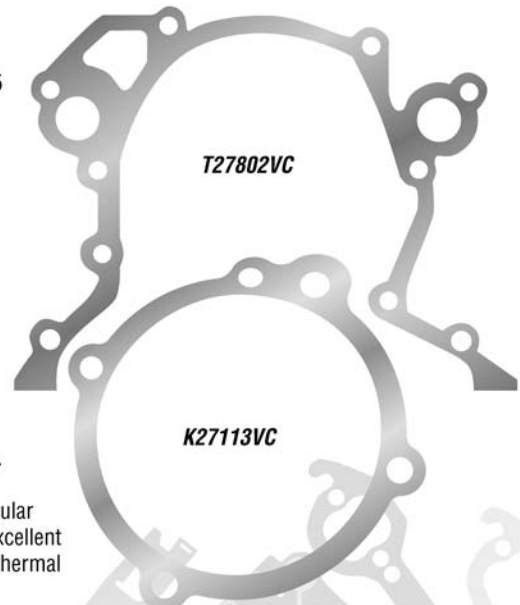

SEALING SOLUTIONS

VICTOR REINZ®
G A S K E T S

Ford 7.3L Power Stroke Head Gasket

Issue:

The Ford/Navistar 7.3L engine was redesigned in 1995 to what is called a "Power Stroke" diesel engine. Many aftermarket gasket suppliers have had difficulty developing gaskets for these engines, forcing installers to purchase original-equipment (OE) service gaskets from the dealer.

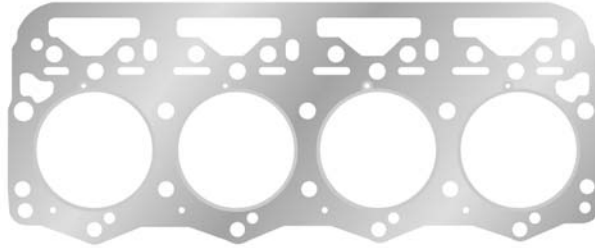

54204

Resolution:

The Victor Reinz Nitroseat® replacement head gasket is identical to the OE design and consists of graphite clinched to a perforated steel core with a wire fire-ring inside the flange to help contain the compression of the Power Stroke diesel.

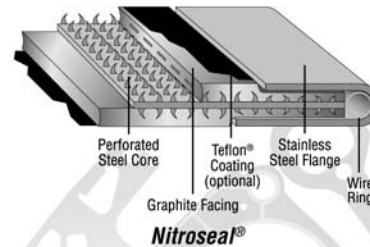

Application:

Victor Reinz head gasket sets are available for 1995 to 1999 Ford 7.3L Power Stroke engines. Lower gasket sets are available through model year 2000. Individual replacement gaskets and seals are also available. Check the *Victor Reinz Catalog* for specific part numbers and availability.

SS-VR-F-08

Printed in U.S.A.

© 2003 Dana Corporation

SEALING SOLUTIONS

VICTOR REINZ®
G A S K E T S

General Motors 2.3L “Quad Four” Head Gasket

Issue:

The original-equipment head gasket on General Motors (GM) 2.3L “Quad Four” engines has a tendency to fail prematurely, between 35,000 and 40,000 miles, due to combustion flange fatigue caused by movement between the head and block.

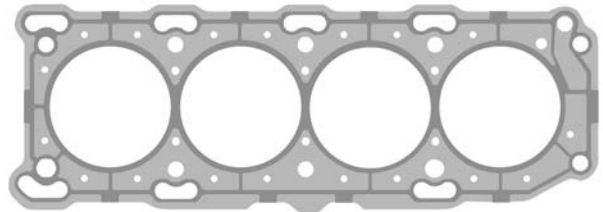

5870

Resolution:

Victor Reinz offers a Nitroseat® replacement cylinder head gasket for this engine. This gasket is made up of solid graphite facing material clinched to a perforated steel core. In testing, the Nitroseat gasket provided a service life up to 40 times longer than other aftermarket replacement head gaskets for the “Quad Four.” This performance is due to a sintered Teflon® metal flange, which greatly enhances the gasket load at its critical sealing areas and resists movement between the head and the block. The graphite composition also helps dissipate heat, preventing hot spots and gasket burnout.

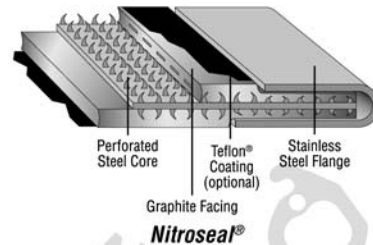

Application:

Victor Reinz part number 5870 is available separately or as part of head set part number HS5870WB for GM 2.3L “Quad Four” engines. The head set also contains new torque-to-yield head bolts.

Note: Victor Reinz recommends that torque-to-yield head bolts always be replaced to ensure the correct clamping force.

SEALING SOLUTIONS

VICTOR REINZ®
G A S K E T S

General Motors 4.5L Head Gasket

Issue:

Coolant leaks may develop around the cylinder head bolts on General Motors (GM) 4.5L (273 CID) engines. These leaks occur when there is an insufficient gasket load on the pushrod side.

Resolution:

Victor Reinz offers a Nitroseat® replacement cylinder head gasket specifically designed for the GM 4.5L (273 CID) engine. This gasket is a Teflon®-coated head gasket composed of solid graphite material clinched to a perforated steel core. In addition, the gasket features a Victocote® coating on the pushrod side of the gasket. This extra coating increases the load on the gasket where it is needed.

The gasket also comes with laced stainless steel flanges, grommets around the bolt holes to distribute the bolt load evenly and to provide a seal around the head bolts. The graphite gasket also maintains a load even during thermal expansion and enhances heat distribution, eliminating hot spots and gasket burnout. Moreover, the Teflon coating resists gasket fretting during thermal expansion and contraction of the aluminum head.

Application:

Victor Reinz part number 5781G is available for 1988 to 1992 GM 4.5L (273 CID) engines.

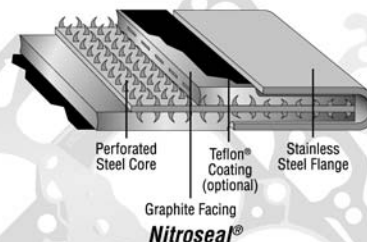
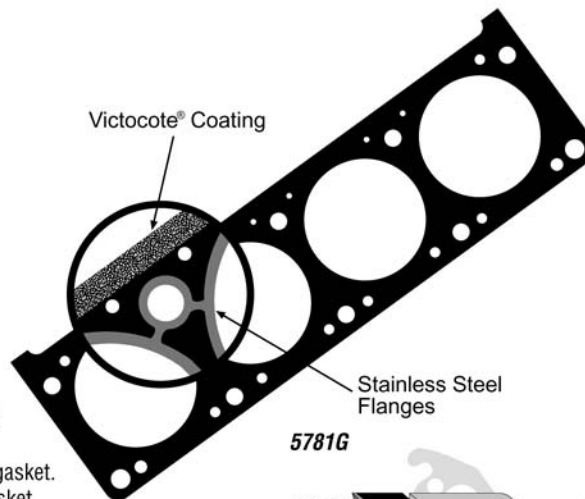

SEALING SOLUTIONS

VICTOR REINZ®
G A S K E T S

General Motors 4.3L Head Gasket

Issue:

General Motors (GM) 4.3L (262 CID) V-6 engines from 1982 to 1995 tend to develop coolant leaks at the spark plug coolant hole between the bolt holes at the exhaust side of the cylinder head. This is usually caused by an insufficient bolt load between the cylinder head and engine block.

Resolution:

Victor Reinz has designed a single-sided Nitroseat® graphite head gasket to replace the original-equipment gasket. This graphite gasket does not require any additional sealant, and the unique "island sealing" design seals the coolant at the spark plug coolant holes at 60 psi, and includes a patented, lace flange for problem sealing applications. The seal also maintains the critical gasket operating thickness of .028". Other aftermarket gaskets are often twice as thick, which may cause combustion and emission problems, including poor engine performance and increased pollution.

Application:

Victor Reinz part number 5744 is available for 1982 to 1995 GM 4.3L (262 CID) engines.

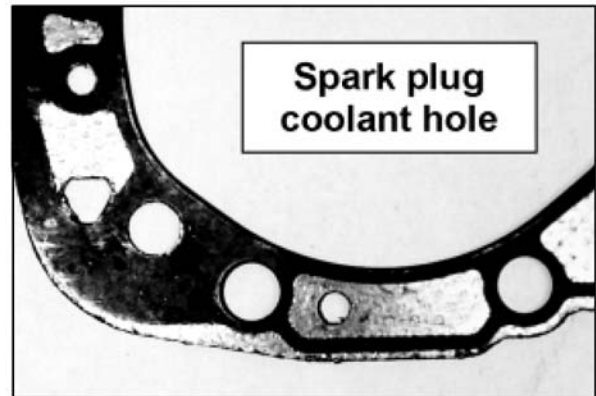

5744

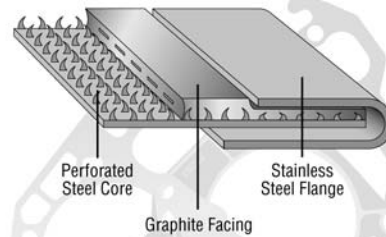

Single-Sided Nitroseat®

SEALING SOLUTIONS

VICTOR REINZ®
G A S K E T S

General Motors LT-4 Head Gasket

Issue:

Some aftermarket replacement head gaskets for 1995 to 1997 General Motors (GM) LT-4 engines have cylindrical shaped combustion openings. However, this particular engine requires a gasket with irregular shaped combustion holes. Using a gasket with round or cylindrical openings will result in increased cylinder volume, which may result in fuel puddling. This can cause the engine to detonate, resulting in burned pistons, damaged head gaskets, and other costly repairs.

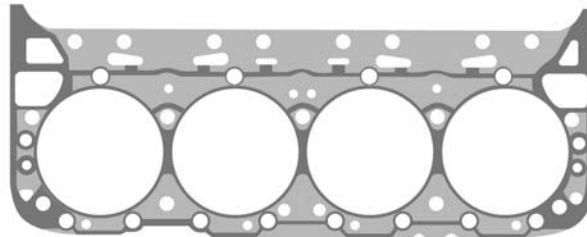

5930

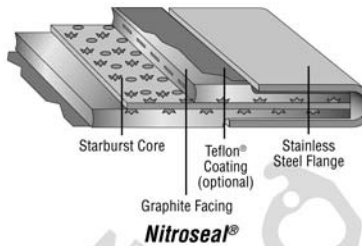

Nitroseal®

Resolution:

Victor Reinz offers a Nitroseal® replacement head gasket for this application. This gasket features a sintered Teflon®-coated sealing flange, and the high-density graphite gasket facing is mechanically clinched to a Starburst core. The Starburst core offers the maximum amount of torque retention for the GM LT-4 and is designed to operate between 0.045" to 0.050" thickness to maintain the required cylinder volume and compression. This gasket features pushrod locating holes for easy assembly and installation.

Application:

Victor Reinz part number 5930 is available for 1995 to 1997 GM LT-4 engines.

SEALING SOLUTIONS



General Motors 7.4L Head Gasket

Issue:

General Motors (GM) 7.4L (454 CID) engines use two types of engine blocks: the Mark IV and Mark V. The Mark IV is found on 7.4L engines in model years from 1965 to 1990, and the Mark V is found on 7.4L engines in model years from 1991 and newer.

Often, installers will attempt to adapt a Mark IV cylinder head for a Mark V block. This conversion can be made if attention is paid to the coolant circulation. Mark IV and Mark V have different coolant flows and were originally designed for different head gaskets. If the conversion is not performed correctly, the engine will overheat, causing premature engine wear and damage.

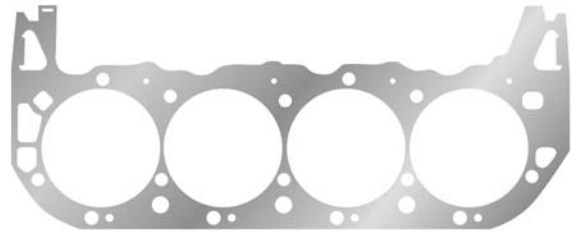

4918 (Right Bank)
4923 (Left Bank)

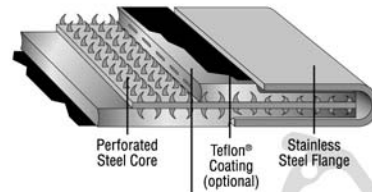

Graphite Facing
Nitroseal®

Resolution:

Victor Reinz has designed two Nitroseal® head gaskets to specifically allow for this conversion. The installation requires Victor Reinz part number 4918 be installed on the right cylinder bank to maintain proper coolant circulation, and part number 4923 to be installed on the left cylinder bank for the correct coolant flow.

Application:

Victor Reinz part numbers 4918 (right bank) and 4923 (left bank), or part number 4886 for conventional Mark V applications and part number 3884SG for conventional Mark IV applications are available for GM 7.4L (454 CID) engines.

SEALING SOLUTIONS

VICTOR REINZ®
G A S K E T S

General Motors Small Block V-8 Front Timing Cover Seal

Issue:

The front timing cover seal on General Motors (GM) 4.3L (262 CID), 5.0L (305 CID), and 5.7L (350 CID) engines has a tendency to leak because of wear grooves in the harmonic balancer.

Resolution:

Victor Reinz now offers an extended-case front timing cover seal. This seal does not require a repair sleeve to cover the wear groove in the harmonic balancer. Using a repair sleeve on a harmonic balancer can cause excessive heat and pressure on the sealing element, resulting in premature wear of the seal. The Victor Reinz extended-case front timing cover seal moves the sealing lip to a new location with the original diameter and surface finish.

Application:

Victor Reinz offers part numbers JV779 for 1969 to 1974 GM 4.3L (262 CID) engines, GM 5.0L (305 CID) engines, and GM 5.7L (350 CID) engines; and JV881 for 1985 to 1993 GM 4.3L (262 CID) engines; 1976 to 1993 GM 5.0L (305 CID) engines; and 1976 to 1996 GM 5.7L (350 CID) engines.

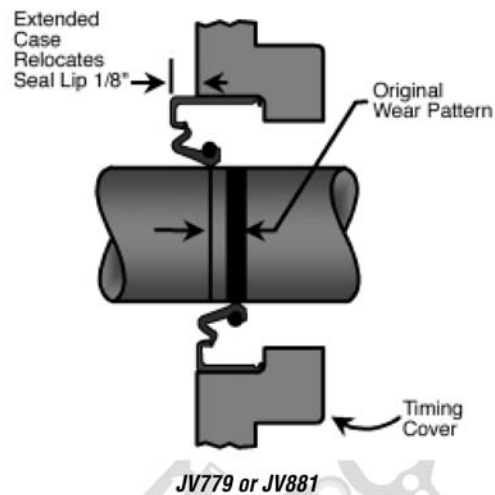

SEALING SOLUTIONS



General Motors 3.8L Front Timing Cover Seal

Issue:

Timing cover alignment problems on many 1975 to 1987 General Motors (GM) 3.8L (231 CID) V-6 engines caused engineers to develop a “shedder and rope” seal instead of the conventional rubber seal found on most engines. However, the original equipment design front timing cover seal on this engine is difficult to install and may not seal if the installation is not completed correctly. Proper timing cover alignment is critical to the engine’s performance or coolant leaks will result.

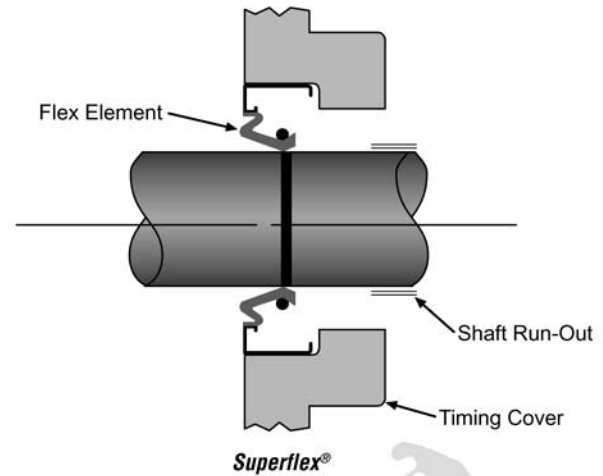

Resolution:

Victor Reinz now offers a front timing cover seal for the GM 3.8L (231 CID) V-6 engine that replaces the original “shedder and rope” design. This Superflex® seal is easy to install and features a unique flex design that allows the seal to compensate for extreme shaft run-out and shaft-to-bore misalignment. The Superflex seal maintains contact with the shaft throughout operation, eliminating potential leaks, and the angle of contact between the Superflex lip and the shaft surface remains constant, regardless of run-out.

Application:

Victor Reinz offers three timing cover sets, which include this Superflex® seal. Part numbers JV1043SF, JV1051SF, and 65025SF are available for 1975 to 1987 GM 3.8L (231 CID) engines.

SEALING SOLUTIONS

VICTOR REINZ[®]
G A S K E T S

General Motors Small Block V-8 Seal Extender

Issue:

Many 1986 to 1996 small block General Motors (GM) engines, including the 4.3L (262 CID), 5.0L (305 CID), and 5.7L (350 CID), experience a worn crankshaft seal area when using a one-piece rear main seal.

Resolution:

Victor Reinz now offers a rear main seal extender for late-model GM 4.3L (262 CID), 5.0L (305 CID), and 5.7L (350 CID) 90 degree engines. This seal extender may be used during an in-frame replacement or a complete overhaul of the engine. This patented seal extender moves the sealing lip to a new unworn surface on the crankshaft. The seal extender also prevents premature seal wear by eliminating the need for a wear sleeve on the crankshaft. Wear sleeves increase the seal deflection angle, causing accelerated seal wear. The extender is designed to fit into the back of the oil seal, making installation easy.

Application:

Victor Reinz part number E-300 is available for 1986 to 1996 GM 4.3L (262 CID), 5.0L (305 CID), and 5.7L (350 CID) engines.

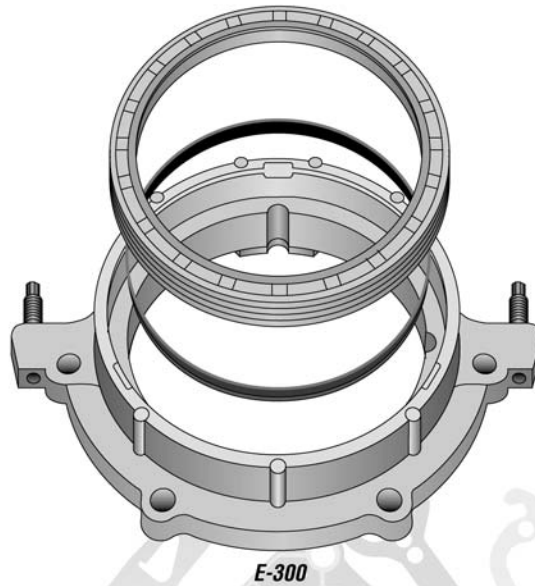

E-300

SS-VR-G-08

Printed in U.S.A.

© 2003 Dana Corporation

SEALING SOLUTIONS



General Motors 6.6L Rear Main Seal

Issue:

When rebuilding a 1970 to 1976 General Motors (GM) 6.6L (400 CID) engine, the crankshaft bore can become oversized during the align boring operation. This causes the original rear main seal to fit poorly and oil to leak past the seal. When align boring this engine, the rear main seal should always be replaced.



JV1603

Resolution:

Victor Reinz offers a rear main seal for this engine that will accommodate the O.D. 2.8406 to 2.8415 seal area. Because it is wider than the original-equipment seal, the replacement rear main seal prevents the oil leaks that can occur in the align boring process.

Application:

Victor Reinz part number JV1603, a rear main seal, is available for 1970 to 1976 GM 6.6L (400 CID) engines.

SEALING SOLUTIONS

VICTOR REINZ®
G A S K E T S

General Motors 7.4L Intake Manifold Gasket

Issue:

Standard composition intake manifold gaskets on late-model General Motors (GM) 7.4L (454 CID) engines tend to fail prematurely due to an insufficient bolt load. These type of gaskets generally leak coolant at the rear of the engine where it is difficult to detect.

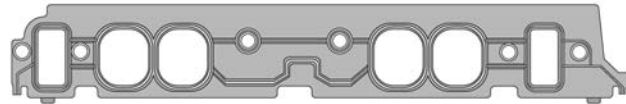

MS16091

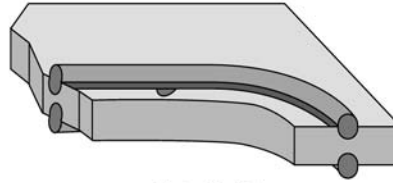

Victo-Tech®

Resolution:

Victor Reinz offers a Victo-Tech® plastic carrier-style gasket with a unique silicone bead to maintain a superior coolant seal.

Application:

Victor Reinz part number MS16091 is available for 1996 and later General Motors 7.4L (454 CID) engines.

SEALING SOLUTIONS



General Motors 3.1L Intake Manifold Gasket

Issue:

On General Motors (GM) 3.1L (189 CID) V-6 engines, coolant leaks have a tendency to develop around the original-equipment, valley-pan-style intake manifold gasket. This leakage occurs when the intake manifold sticks to the gasket as it moves across the gasket surface, causing gasket fretting. Coolant leaks can contaminate the engine oil.

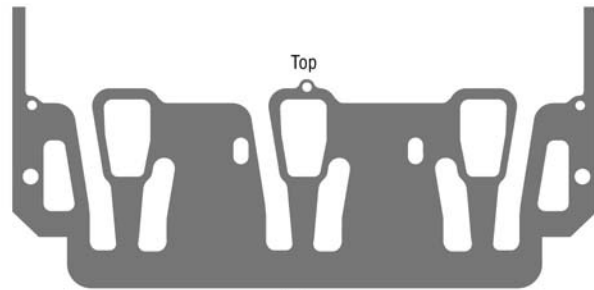

Bottom
MS15704

Resolution:

Victor Reinz offers a Nitroseat[®] replacement intake manifold gasket for this engine. This gasket design is composed of a high-density graphite facing with a Teflon[®] coating mechanically clinched to a perforated steel core. This unique design allows the intake manifold to slide across the gasket surface without damaging the gasket. In testing, the Victor Reinz gasket ran for over 10,000 cycles with no leaks. By comparison, a competitor's gasket ran for an average of 700 cycles.

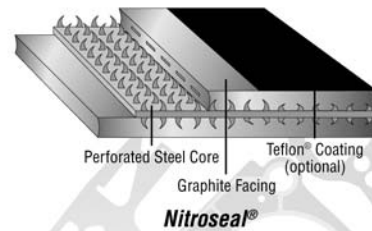

Application:

Victor Reinz part number MS15704 is available for 1988 to 1990 GM 3.1L (189 CID) VIN Code T passenger car engines, and part number MS15704A is available for 1991 to 1994 GM 3.1L (189 CID) VIN Code T passenger car engines. For best results, follow the installation instructions provided with the gasket.

SEALING SOLUTIONS

VICTOR REINZ®
G A S K E T S

General Motors 5.7L Oil Pan Gasket

Issue:

Many technicians have become used to working with a one-piece rubber oil pan gasket, popular on many late-model engines. Consequently, they've asked the aftermarket to provide similar style gaskets for engines like the early model General Motors (GM) 5.7L (350 CID) V-8 engines.

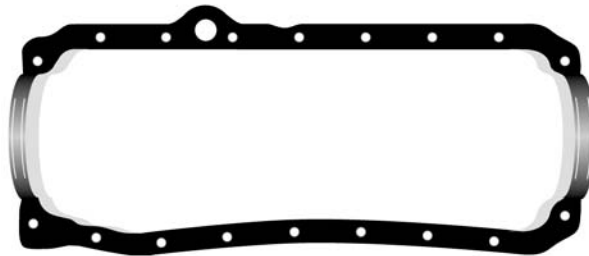

OS30568RLH and OS30568RRH

Resolution:

Victor Reinz offers a Victo-Tech® molded rubber replacement oil pan gasket for GM 5.7L (350 CID) engines. This gasket consists of a revolutionary one-piece design for easy installation. In addition, there are no joints to glue, eliminating potential leak paths. The Victo-Tech gasket's features include load limiters to prevent overtightening, a higher temperature resistance than cork-rubber gaskets, and no torque loss after installation. Victor Reinz also offers two different part numbers, one for the right side and one for the left side, so there is no need for cutting or fabrication.

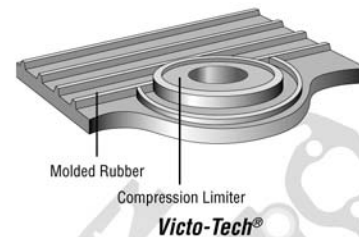

Application:

Victor Reinz part numbers OS30568RLH (left side) and OS30568RRH (right side) are available for 1975 to 1985 GM 5.7L (350 CID) V-8 engines. Victor Reinz also offers one-piece oil pan gaskets for many other small block GM engines.

SS-VR-G-12

Printed in U.S.A.

© 2003 Dana Corporation

SEALING SOLUTIONS

VICTOR REINZ®
G A S K E T S

General Motors 4.3L Oil Pan Gasket

Issue:

Some late-model engines, like the 1986 to 1993 General Motors (GM) 4.3L (262 CID) V-6 engine, are specifically designed to use a molded silicone rubber oil pan gasket.

Resolution:

Victor Reinz offers a Victo-Tech® molded silicone rubber oil pan gasket for the GM 4.3L engine. This one-piece gasket is designed for easy installation. The molded rubber gasket features compression limiters for a secure seal and to prevent over torquing, as well as increased temperature resistance over cork-rubber gaskets. The gasket does not require a sealant, since there are no joints, and after installation, there is no torque loss, which improves sealing. The superior molded rubber design helps eliminate costly comebacks.

Application:

Victor Reinz part number OS32485B is available for 1986 to 1993 GM 4.3L (262 CID) engines. Victor Reinz also offers oil pan and valve cover Victo-Tech gaskets for many other GM, Ford, and import applications.

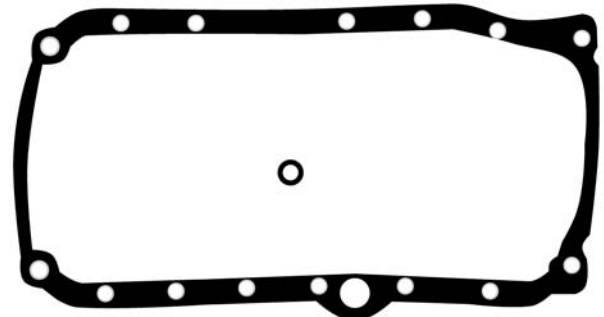

OS32485B

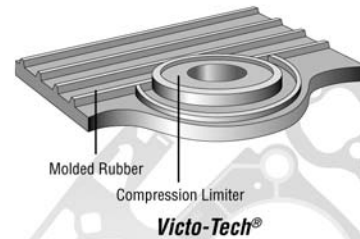

Molded Rubber

Compression Limiter

Victo-Tech®

SEALING SOLUTIONS

VICTOR REINZ®
G A S K E T S

General Motors 5.7L Water Outlet Gasket

Issue:

Water outlet gaskets on 5.7L (350 CID) General Motors (GM) performance engines often fail prematurely because of surface irregularities between the water outlet housing and the intake manifold. This failure can lead to coolant leaks.

Resolution:

Victor Reinz offers a Victo-Tech® water outlet gasket for these engines. This gasket is composed of an aluminum carrier with a molded silicone bead to ensure a secure seal and is unique because it actually seals the housing and holds the thermostat flange in place. The aluminum body prevents overtightening, and is compatible with all manifold materials. The superior tensile strength over existing designs, and higher torque retention, requires a lower bolt load to seal the application.

Application:

Victor Reinz part number C21331 is available for 1967 to 1988 5.7L (350 CID) GM engines.

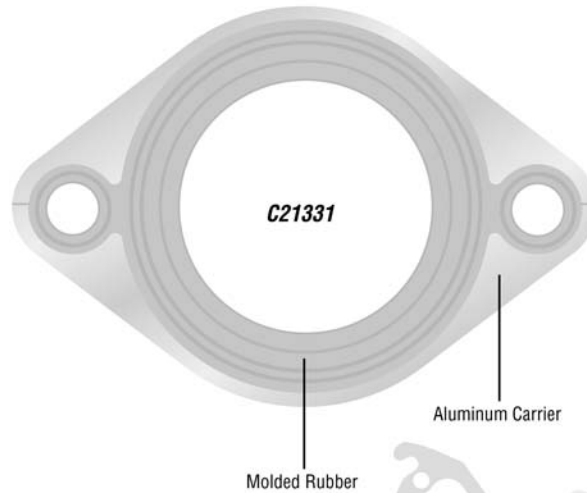

SEALING SOLUTIONS

VICTOR REINZ®
G A S K E T S

General Motors 7.4L Valve Cover Gasket

Issue:

The valve cover on 1991 and later General Motors (GM) 7.4L V-8 (454 CID) engines does not provide for a consistent and uniform load across its sealing surface. If the valve cover gasket cannot provide a secure seal between the valve cover and the cylinder head, engine oil loss and smoking may occur.

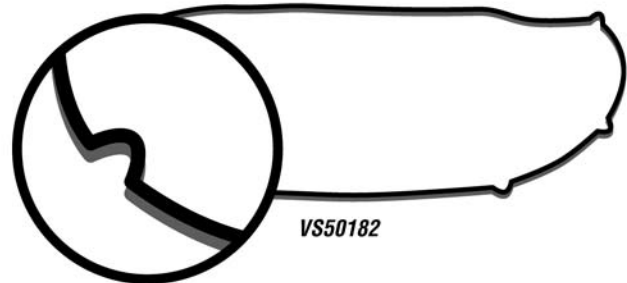

Resolution:

Victor Reinz offers a Victo-Tech® replacement gasket constructed of molded silicone. The gasket fits in the receiver groove, which is an integral part of the valve cover.

Install a dry gasket into the valve cover and tighten to the manufacturer's specifications. When the vehicle is in operation and the engine oil comes in contact with the gasket, it swells approximately 30 percent from its original size, creating the load required to seal the valve cover.

Application:

Victor Reinz part number VS50182, a set, and part number VS50183, a single gasket, are available for most 1991 and later GM 7.4L (454 CID) engines.

SEALING SOLUTIONS

VICTOR REINZ®
G A S K E T S

General Motors 4.8L, 5.3L, and 6.0L Truck Valve Cover Gasket

Issue:

Replacement valve cover gaskets for 4.8L, 5.3L, and 6.0L General Motors (GM) truck engines have not been available in the aftermarket until recently. As a result, many technicians may be unfamiliar with proper gasket replacement procedures. These engines use a silicone rubber gasket, which functions differently than many conventional valve cover gaskets.



Resolution:

Victor Reinz offers a new Victo-Tech® silicone rubber replacement valve cover gasket for these engines. The gasket is installed into a receiver groove molded into the valve cover. Then, the valve cover is installed back into the engine until it bottoms on the engine casting. It is not uncommon for light loading to occur during installation, but technicians must resist the temptation to apply sealants to the gasket. This style of gasket consists of silicone rubber, and swells approximately 30 percent when it comes into contact with oil. Because it's confined in the receiver groove, the swell creates pressure against the casting, which creates the desired seal.

Application:

Victor Reinz part number VS50250 is available for 1999 to 2002 GM Vortec 4.8L engines, 2002 GM Vortec 5.3L engines, and 1999 to 2002 GM Vortec 6.0L engines.

SEALING SOLUTIONS

VICTOR REINZ®
G A S K E T S

General Motors 3.1L and 3.4L Intake Manifold Gaskets

Issue:

Many 1999 to 2002 General Motors (GM) 3.1L engines (VIN Code J) and 1996 to 2002 GM 3.4L engines (VIN Code E) are experiencing premature intake manifold gasket failures. The one-piece plastic carrier/molded silicone style gasket fails around the silicone beading, possibly due to a breakdown of the Organic Acid Technology (OAT) coolant used in these engines, loss of bolt load, or a crack in the carrier caused by overtightening the manifold bolts.

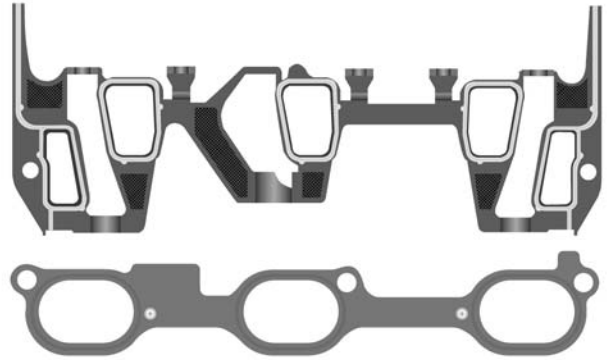

MS16259

Resolution:

Victor Reinz offers a new Victo-Tech® manifold gasket set to solve this problem. The set includes high-quality manifold gaskets and the plenum chamber gasket. Victor Reinz recommends changing the engine coolant when replacing the manifold gaskets. Moreover, the manifold surface and cylinder head surface must be flat (.002 inches in a 6 inch span), smooth (Ra 20-60 micro-inch), and free of oil, coolant, and sealants when the new gaskets are installed. Follow the recommended GM procedure for tightening the manifold fasteners and apply an anaerobic thread lock to the eight lower manifold bolts.

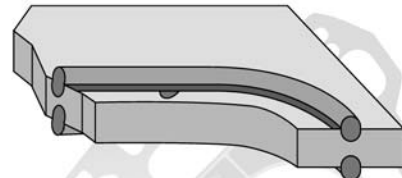

Victo-Tech®

Application:

Victor Reinz part number MS 16259 is available for 1999 to 2002 GM 3.1L (VIN Code J) engines and 1999 to 2002 GM 3.4L (VIN Code E) engines.

SS-VR-G-17

Printed in U.S.A.

© 2003 Dana Corporation

SEALING SOLUTIONS

VICTOR REINZ®
G A S K E T S

Honda 1.3L and 1.5L Head Gasket

Issue:

Many 1984 to 1987 Honda 1.3L and 1.5L engines have a tendency to experience combustion leaks between the two cylinders due to poor coolant circulation.

Resolution:

Victor Reinz offers a Nitroseal® replacement head gasket for Honda 1.3L and 1.5L engines that helps eliminate this problem. This gasket is composed of Teflon®-coated graphite clinched to a perforated steel core with a stainless steel flange. Victor Reinz increased the gauge, or "thickness," of the flange material. This allows for greater flange loading between the engine block and the cylinder head, eliminating the combustion leakage common to these engines. This stainless steel flange will survive this harsh environment, and the graphite facing results in better heat dissipation to reduce the amount of heat directed to the combustion seal.

Application:

Victor Reinz part number 3782 is available for 1984 to 1987 Honda 1.3L and 1.5L engines.

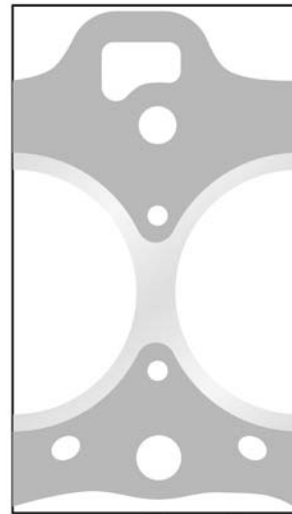

3782

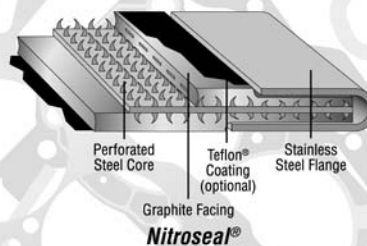

SEALING SOLUTIONS



Toyota 3.4L Truck Head Gasket

Issue:

Multi-layer steel (MLS) cylinder head gaskets on 1995 to 2000 Toyota 3.4L truck engines can cause installation difficulties for many aftermarket technicians. Conventional MLS gaskets require very smooth surface finishes, difficult for many shops and technicians to achieve.

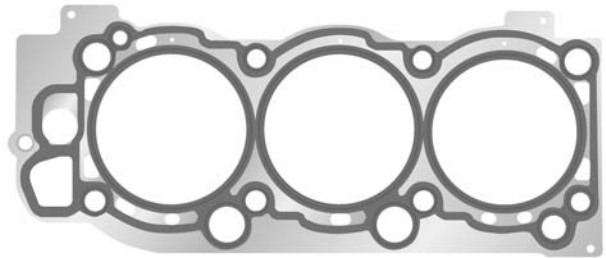

54137

Resolution:

Victor Reinz offers MLS gasket designs that are both state-of-the-art and state-of-the-industry. Special embossed spring steel layers are selectively coated with Intellicoat™, a new polymer coating. Intellicoat (recognized by its bright blue color) is much more forgiving on surface finish than many other MLS gaskets. Rather than the Ra 7-15 micro-inch required for competitors' designs, MLS gaskets with Intellicoat will work in the range of Ra 20-60 micro-inch, with a desirable finish of Ra 30 micro-inch. Most shops can achieve this tolerance with relative ease.

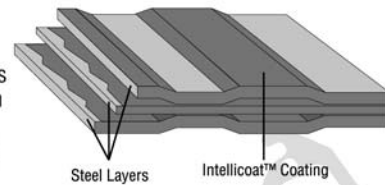

Multi-layer Steel

Application:

Victor Reinz part number 54137, a head gasket set, is available for 1995 to 2000 Toyota 3.4L 5VZFE, DOHC, V-6 truck engines. The set contains both the right and left bank head gaskets.

Note: Head bolts must be replaced when replacing the head gasket. Use Victor Reinz replacement head bolts, part number GS33353 (two required per engine).

SEALING SOLUTIONS

VICTOR REINZ®
G A S K E T S

Carbonless Impression Paper

Issue:

During engine rebuilding, it is critical that the cylinder head and block are checked for warpage. If an inspection is not thorough and accurate, and if any warpage goes undetected, the head gasket cannot adequately seal the engine.

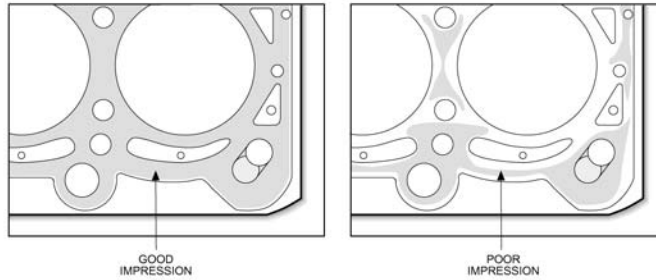

JV311

Resolution:

Carbonless impression paper provides a more consistent and accurate reading than other methods used to detect warpage. The paper can also be used as a visual aid to show a customer where the high and low spots exist. Carbonless impression paper is 0.006" thick, so the lack of an impression indicates a surface that is out-of-flat by at least 0.006".

Application:

Victor Reinz carbonless impression paper comes in sheets 10" by 30" and is available in sets of 2 sheets, part number JV311, or 12 sheets, part number JV312. Use 1 sheet per cylinder head. Follow the instructions included with the paper, and use Victor Reinz punch set TK950.

Note: Victor Reinz does not recommend using carbonless impression paper on engines with liners that protrude above the block. These engines must always have a gasket between the head and the block, or the stress on the liner could crack the engine block.

SS-VR-M-01

Printed in U.S.A.

© 2003 Dana Corporation

SEALING SOLUTIONS



Motorhome Manifold Gaskets

Issue:

Motorhomes are prone to very high manifold temperatures, resulting in unsafe fumes, noise, and the potential for fire. These high temperatures are caused by limited airflow over the exhaust manifold and may cause the gasket to burnout and leak.

Resolution:

Victor Reinz offers Nitroseat[®] manifold gaskets that can withstand temperatures up to 1800° F in a clamped state, preventing gasket burnout. Nitroseat[®] gaskets feature a unique graphite composition that can stand up to this extreme temperature environment without causing torque loss or a failed manifold seal.

Application:

Victor Reinz offers part number 95021SG for 7.4L Chevrolet engines, part number 95091SG for Ford 6.9L engines, part number 95026SG for Chrysler 440 CID engines, or part number 95028SG for 403 CID and 455 CID Oldsmobile engines.



95021SG



95091SG



95026SG



95028SG

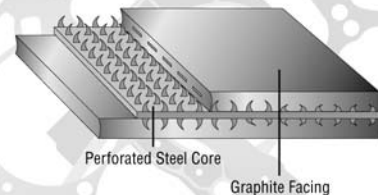

Nitroseat[®]

SEALING SOLUTIONS

VICTOR REINZ®
G A S K E T S

Exhaust Manifold Gasket

Issue:

Installing an exhaust manifold gasket on small block engines during an under hood repair can be difficult. This is because of the limited workspace and the challenge of aligning the gasket, the manifold, and the bolt holes.



95177SG

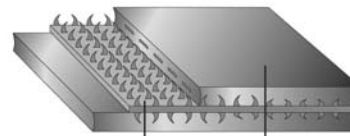

Perforated Steel Core
Graphite Facing

Nitroseat®

Resolution:

Victor Reinz offers Nitroseat® replacement exhaust manifold gaskets to make this type of installation easier. The Victor Reinz design features slotted bolt holes at the ends of the gasket that allow it to be installed over the end bolts that are holding the manifold to the cylinder head.

These gaskets are specially designed with the technician in mind. The two slotted holes aid in the installation process by allowing a consistent clamp to be applied to the gasket, resulting in a permanent seal.

Application:

Victor Reinz part number 95177SG is available for small block Ford engines, and part number 95094SG is available for small block Chevrolet engines. Check the *Victor Reinz Catalog* for specific applications and part numbers.

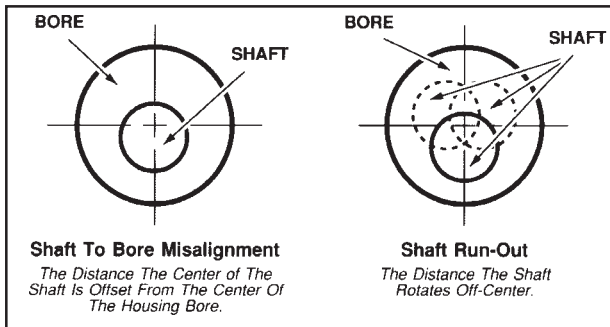
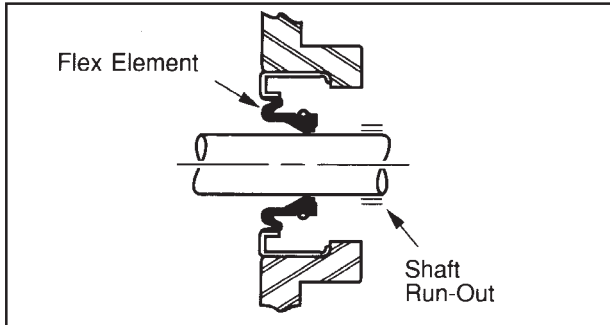
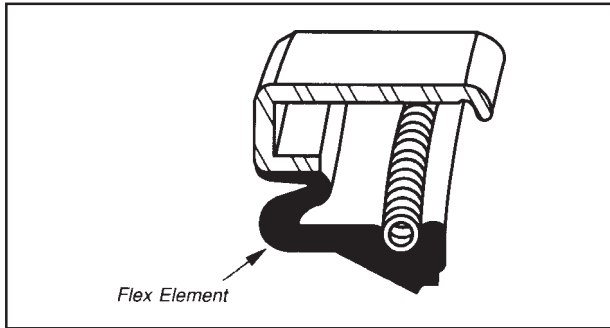

SUPERFLEX

The unique flex design of the Superflex sealing element enables this seal to cope with extreme shaft eccentricity (run-out) and shaft to bore misalignment.

The Superflex sealing element will maintain shaft contact assuring leak-free operation in the most demanding of applications.

The angle of contact between the Superflex lip and the shaft surface remains constant regardless of run-out. This contributes to low wear rates and prolonged seal life.

Superflex seals will be identified with an "SF" suffix on the part number as will all timing cover "JV" sets which contain them.

All full sets which contain Superflex seals will have this indicated on the label.

EXTENDED CASE TIMING COVER SEAL

The extended case timing cover seal 65022 (used on G.M. small block V8 engines) eliminates the need for a shaft repair sleeve on shafts that have a groove worn into them by the timing cover seal. When the new extended case seal is driven into the timing cover bore, the extended case relocates the sealing lip outward 1/8" from the original wear pattern.

The "**Lip Relocator**" is used in JV779, JV881 and in the related Chevrolet full sets.

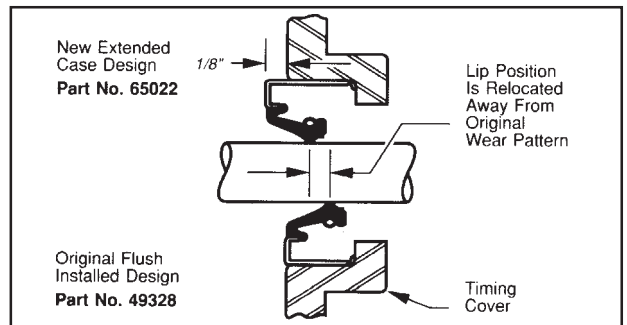
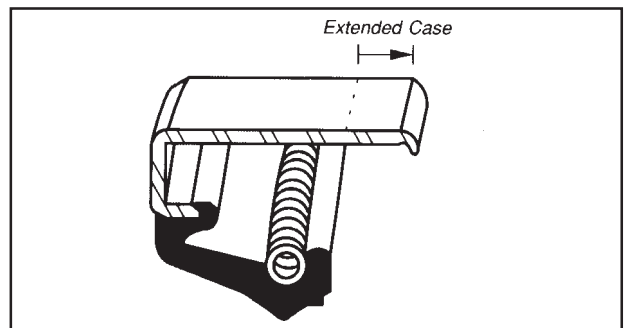

Model Cross Reference List

A100	Dodge Truck	Bermuda	Ford	Classic Sierra 1500, 2500, 3500
A30, A35, A40	Austin	Bermuda	Jeep	General Motors Truck
A4	Audi	Beta	Lancia	Clipper
A4000, A5000	General Motors Truck	Binder	Navistar/International	Club Wagon
A50, A55, A60 Cambridge	Austin	Biscayne	General Motors Corp.	Ford Truck
A6	Audi	Biturbo	Maserati	Colony Park
A60	General Motors Truck	Blackwood	Ford Truck	Colt
A6000, A6500	General Motors Truck	Blazer	General Motors Truck	Colt
A8	Audi	Blitz	Opel	Comanche
AB120	Navistar/International	Bluebird	Nissan	Comet
AMX	American Motors	Bobcat	Ford	Commander
Acadian	General Motors Corp.	Bonneville	General Motors Corp.	Commercial Chassis
Accent	Hyundai	Bora	Maserati	Commodore
Acclaim	Chrysler	Boxster	Porsche	Commuter
Accord	Honda	Brat	Subaru Truck	Concord
Ace	Jeep	Brava	Fiat	Concorde
Achieva	General Motors Corp.	Bravada	General Motors Truck	Conquest
Admiral	Opel	Breeze	Chrysler	Consul
Adventurer	Chrysler	Bronco, Bronco II	Ford Truck	Continental
Aerio	Suzuki	Brooklands	Bentley	Continental
Aero	Jeep	Brookwood	General Motors Corp.	Contour
Aerostar	Ford Truck	Brougham	Chrysler	Cooper
Alero	General Motors Corp.	Brougham	General Motors Corp.	Cooper
Alfetta	Alfa Romeo	Business	Chrysler	Cordia
Allante	General Motors Corp.	C10	General Motors Truck	Cordoba
Alliance	Renault	C1500, C1500 Suburban	General Motors Truck	Corniche
Allroad	Audi	C20	General Motors Truck	Corniche
Allstate	Sears	C2500	General Motors Truck	Corolla
Alpina	BMW	C30	General Motors Truck	Corona
Alpine	Sunbeam	C3500	General Motors Truck	Coronet
Altima	Nissan	CJ2 - 8	Jeep	Corrado
Amanti	Kia	Corsair	Ford	Corsair
Ambassador	American Motors	CR-V	Honda Truck	Corsica
Ambassador	Nash	CRX	Honda	Cortina
America	Austin	Caballero	General Motors Truck	Corvaire
American	American Motors	Cabrio	Volkswagen	Corvette
American	Jeep	Cabriolet	Audi	Cosmo
Amigo	Isuzu Truck	Cabriolet	Volkswagen	Cosmopolitan
Anglia	Ford	Cabstar	Nissan Truck	Cougar
Apollo	General Motors Corp.	Calais	General Motors Corp.	Countach
Appia Series 1, 2, 3	Lancia	Calienta	Ford	Country Sedan
Aprilia	Lancia	Camargue	Rolls-Royce	Country Squire
Aries	Chrysler	Camaro	General Motors Corp.	Coupe DeVille
Arnage	Bentley	Cambridge	Chrysler	Courier
Arrow	Chrysler	Camry	Toyota	Cowley
Arrow	Dodge Truck	Capri	Ford	Cranbrook
Arrow	Sunbeam	Caprice	General Motors Corp.	Cressida
Ascona	Opel	Caravan	Dodge Truck	Crestline
Aspen	Chrysler	Caravelle	Opel	Crickit
Aspire	Ford	Caravelle	Renault	Crossfire
Astra Van	Opel	Caribbean	Packard	Crown
Astre	General Motors Corp.	Carina	Toyota	Crown
Astro	General Motors Truck	Catalina	General Motors Corp.	Crown Imperial
Asuna	Asuna	Catera	General Motors Corp.	Crown Victoria
Aurelia Series	Lancia	Cavalier	General Motors Corp.	Cruiser
Aurora	General Motors Corp.	Cayenne	Porsche Truck	Cultus 1000
Austin	American Motors	Celebrity	General Motors Corp.	Custom
Avalanche 1500, 2500	General Motors Truck	Celica	Mitsubishi	Custom
Avalon	Toyota	Celica	Toyota	Custom
Avanti	Studebaker	Celina	Toyota	Custom Cruiser
Avenger	Chrysler	Celvo	Suzuki	Custom Imperial
Avenger	Hillman	Centurion	General Motors Corp.	Custom Royal
Aviator	Ford Truck	Century	General Motors Corp.	Custom Star Chief
Axion	Isuzu Truck	Challenger	Chrysler	Customline
Axxess	Nissan Truck	Champ	Chrysler	Cutlass
Aztek	General Motors Truck	Champion	Studebaker	Cyclone
Azure	Bentley	Charade	Daihatsu	Dakota
B1600, B1800	Mazda Truck	Charger	Chrysler	Dart
B2000 - B2600	Mazda Truck	Cherokee	Jeep	Dasher
B3000 - B4000	Mazda Truck	Cherry	Nissan	Daytona
BB4 Zagato	Aston Martin	Chevelle	General Motors Corp.	Daytona
Baja	Subaru Truck	Chevette	General Motors Corp.	DeSoto
Barracuda	Chrysler	Chevy II	General Motors Corp.	DeVille
Beauty Winner	Chrysler	Chieftain	General Motors Corp.	Defender
Beauville	General Motors Corp.	Cimarron	General Motors Corp.	Del Ray
Beetle	Volkswagen	Cirrus	Chrysler	Del Rio
Bel Air	General Motors Corp.	Citation	Ford	Del-Sol
Belvedere	Chrysler	Citation	General Motors Corp.	Delmont Eighty-Eight
Beretta	General Motors Corp.	Civic	Honda	Delta 88
Berlina	Alfa Romeo			Delta 88 Royale
Berlina	Fiat			Deluxe
Berlina	Opel			Deluxe

Model Cross Reference List

Deluxe 210	General Motors Corp.	Fiesta	Ford	Highlander	Toyota Truck
Diablo	Lamborghini	Firebird	General Motors Corp.	Hijet	Daihatsu Truck
Diamante	Mitsubishi	Firedome	Chrysler	Hilux	Toyota Truck
Dino	Ferrari	Fireflite	Chrysler	Hombre	Isuzu Truck
Diplomat	Chrysler	Firefly	General Motors Corp.	Horizon	Chrysler
Diplomat	Opel	Firenza	General Motors Corp.	Hornet	American Motors
Discovery	Land Rover	Firesweep	Chrysler	Hornet	Austin
Duetto Spider	Alfa Romeo	Fisher	General Motors Corp.	Hornet	Wolseley
Durango	Dodge Truck	Flaminia	Lancia	Hornet	Hudson
Duster	Chrysler	Flavia	Lancia	Hunter	Hillman
Dyna	Toyota Truck	Fleetline	General Motors Corp.	Husky	Hillman
Dynamic 88	General Motors Corp.	Fleetmaster	General Motors Corp.	I Mark	Passport
Dynamic Seventy	General Motors Corp.	Fleetwood	General Motors Corp.	I-Mark	Isuzu
Dynamic Sixty	General Motors Corp.	Flying Spur	Rolls-Royce	I30, I35	Infiniti
Dynasty	Chrysler	Focus	Ford	IMP	Hillman
E-Class	Chrysler	Forester	Subaru Truck	IMP	Sunbeam
E100 Pickup	Ford Truck	Forsa	Suzuki	IS300	Lexus
E100 Station Bus	Ford Truck	Fox	Audi	Impala	General Motors Corp.
EV Plus	Honda	Fox	Volkswagen	Imperial	Chrysler
EV1	General Motors Corp.	Frazier	Kaiser-Frazer	Imperial	Hummer
EVR	Isuzu Truck	Freelander	Land Rover	Impreza	Subaru
EXP	Ford	Fregate	Renault	Impulse	Isuzu
Eagle	American Motors	Frontier	Nissan Truck	Impulse	Passport
Echo	Toyota	Fuego	Renault	Indy	Maserati
Eclat (Sprint)	Lotus	Fulvia	Lancia	Insight	Honda
Eclipse	Mitsubishi	Fury	Chrysler	Integra	Acura
Econoline	Ford Truck	G10, G20, G30	General Motors Truck	Intrepid	Chrysler
Eight	Bentley	G1500, G2500, G3500	General Motors Truck	Intrigue	General Motors Corp.
Eighty Eight	General Motors Corp.	G20	Infiniti	Invicta	General Motors Corp.
El Camino	General Motors Truck	G35	Infiniti	Ion	Saturn
Elan	Lotus	GS300, GS400, GS430	Lexus	Islero 400GT	Lamborghini
Elantra	Hyundai	GT	Ford	Isuzu	Opel
Eldorado	General Motors Corp.	GT	Opel	Italia Custom Series	Hudson
Electra	General Motors Corp.	GT Coupe	Sunbeam	J10, J20	Jeep
Electra 225	General Motors Corp.	GT Veloce	Alfa Romeo	J2, J4	Morris
Electra Estate Wagon	General Motors Corp.	GT2	Porsche	J2000	General Motors Corp.
Element	Honda Truck	GT6	Triumph	J30	Infiniti
Eleven	Lotus	GTA	American Motors	Jaipa	Lamborghini
Elf	Riley	GTA	Renault	Jamara	Lamborghini
Elite	Lotus	GTI	Volkswagen	Javelin	American Motors
Encore	Renault	GTO	Ferrari	Jeepster	Jeep
Endeavor	Mitsubishi Truck	GTO	General Motors Corp.	Jetstar	General Motors Corp.
Envoy	General Motors Truck	GTV-6	Alfa Romeo	Jetta	Volkswagen
Epic	Vauxhall	GTX	Chrysler	Jimmy	General Motors Truck
Escalade	General Motors Truck	GX470	Lexus Truck	Justy	Subaru
Escape	Ford Truck	GLX	Ford	K10, K10 Suburban	General Motors Truck
Escort	Ford	Galant	Mitsubishi	K10 Fast-Transport	Studebaker Truck
Espada	Lamborghini	Galaxie	Ford	K10, K11 Series	Navistar/International
Esperante	Panoz	Gallardo	Lamborghini	K1500, K1500 Suburban	
Esprit	Lotus	Gazelle	Singer		General Motors Truck
Estate	Moskvitsch	Gemini 8	Suzuki	K2 Series	Navistar/International
Estate Wagon	General Motors Corp.	Ghibli	Maserati	K20, K20 Suburban	General Motors Truck
Esteem	Suzuki	Giulia	Alfa Romeo	K2500, K2500 Suburban	
Europa	Lotus	Giulietta	Alfa Romeo		General Motors Truck
Eurovan	Volkswagen Truck	Gladiator	Jeep	K3 Series	Navistar/International
Excel	Hyundai	Golden Hawk	Studebaker	K30	General Motors Truck
Excursion	Ford Truck	Golden Rocket 88	General Motors Corp.	K3500	General Motors Truck
Executive	General Motors Corp.	Golf	Volkswagen	K3M	Navistar/International
Executive	Packard	Gordini	Renault	K4 Series	Navistar/International
Executive Limousine	Chrysler	Graduate	Alfa Romeo	K4000	General Motors Truck
Executive Sedan	Chrysler	Gran Fury	Chrysler	K5 Coupe-Express	Studebaker Truck
Expedition	Ford Truck	Gran Sport	General Motors Corp.	K5, K6, K7, K8 Series	Navistar/International
Explorer	Ford Truck	Gran Torino	Ford	KB-5, KB-6 Series	Navistar/International
Expo	Chrysler	Granada	Ford	KB Series	Navistar/International
Expo	Mitsubishi Truck	Grand Am	General Motors Corp.	KB1M	Navistar/International
Expo LRV	Mitsubishi Truck	Grand Caravan	Dodge Truck	Kingsway	Chrysler
Express	General Motors Truck	Grand Cherokee	Jeep	KR Series	Navistar/International
Express Truck	Eicher	Grand Marquis	Ford	KS Series	Navistar/International
F Series	General Motors Corp.	Grand Prix	General Motors Corp.	Kadett	Opel
F-85	General Motors Corp.	Grand Truismo Hawk	Studebaker	Kaiser	Kaiser-Frazer
F-Super Duty	Ford Truck	Grand Vitara	Suzuki Truck	Kapitan	Opel
F100, F150, F250, F350	Ford Truck	Grand Voyager	Dodge Truck	Karmann Ghia	Volkswagen
F355	Ferrari	Grand Wagoneer	Jeep	Khamsin	Maserati
F370	General Motors Truck	Grandville	General Motors Corp.	Kyalami	Maserati
F40, F50	Ferrari	Gremlin	American Motors	L Series	General Motors Corp.
F611, F613, F614	Volvo Truck	H1, H2	Hummer	L-160 Series	Navistar/International
FX35, FX45	Infiniti Truck	Hawk	Packard	L Series	Saturn
Fairlane	Ford	Hawk	Studebaker	L6, L7	BMW
Fairmont	Ford	Healey	Austin	L6-226	Jeep
Falcon	Ford	Healey	Jensen	L60, L70	General Motors Truck
Festiva	Ford	Henry J	Kaiser-Frazer	L600, L700	Dodge Truck
Fiero	General Motors Corp.	Herald	Triumph	LHS	Chrysler

Model Cross Reference List

LLV Postal Vehicle	General Motors Truck	Microbus	Toyota Truck	Phaeton	Volkswagen
LM002	Lamborghini	Midget MK I, II, III, IV	MG	Phantom	Rolls-Royce
LN-7	Ford	Mighty Max	Mitsubishi Truck	Phoenix	General Motors Corp.
LS	Audi	Milano	Alfa Romeo	Pilot	Honda Truck
LS	Ford	Millenia	Mazda	Pinto	Ford
LS400	Lexus	Mini Car	Austin	Plaza	Chrysler
LS430	Lexus	Mini Cooper	Austin	Plus 8	Morgan
LSS	General Motors Corp.	Mini Cooper	Morris	Plus Four	Morgan
LTD	Ford	Mini Moke	Austin	Polara	Chrysler
LTD Country Squire	Ford	Mini Ram	Dodge Truck	Pony	Hyundai
LTD II	Ford	Minibus	Morris	Pony	Hyundai Truck
LX450, LX470	Lexus Truck	Minor	Morris	Power Ram	Dodge Truck
Lagonda V-8	Aston Martin	Minx	Hillman	Power Wagon	Dodge Truck
Lancer	Chrysler	Mirada	Chrysler	Powermaster	Chrysler
Lancer	Mitsubishi	Mirage	Mitsubishi	Precis	Mitsubishi
Land Cruiser	Toyota Truck	Mistral	Maserati	Prefect	Ford
Lanos	Daewoo	Miura	Lamborghini	Prelude	Honda
Lark	Studebaker	Monaco	Chrysler	Premier	Eagle Chrysler
Laser	Chrysler	Monarch	Ford	Premier	Ford
Laurentian	General Motors Corp.	Mondial	Ferrari	President	Studebaker
Le Sabre	General Motors Corp.	Montana	General Motors Truck	Previa	Toyota Truck
LeMans	General Motors Corp.	Montclair	Ford	Prius	Toyota
Lebaron	Chrysler	Monte Carlo	General Motors Corp.	Prizm	General Motors Corp.
Legacy	Subaru	Montego	Ford	Probe	Ford
Leganza	Daewoo	Monterey	Ford	Protege	Mazda
Legend	Acura	Montero	Mitsubishi Truck	Prowler	Chrysler
Liberty	Jeep	Montreal	Alfa Romeo	Pulsar	Nissan
Limited	General Motors Corp.	Monza	General Motors Corp.	Q45	Infiniti
Lo Pro	General Motors Truck	Monza	Opel	Quattro	Audi
Loyale	Subaru	Morris Oxford	Austin	QX4	Infiniti Truck
Lumina	General Motors Corp.	Motor Home	Winnebago	Quadrifoglio	Alfa Romeo
Luv	General Motors Truck	Mountaineer	Ford Truck	Quantum	Volkswagen
Lynx	Ford	Mulsanne	Bentley	Quattroporte	Maserati
M-21	Volga	Multi	Nissan	Quest	Nissan Truck
M3, M5, M6	BMW	Multipia	Fiat	R-140, R-150, R-160 Series	
M30, M45	Infiniti	Murano	Nissan	R-Series	Navistar/International
MDX	Acura Truck	Murcielago	Lamborghini	R-Series	Workhorse
MF Series	Dodge Truck	Mustang	Ford	R10, R10 Suburban	General Motors Truck
MGB	MG	Mystique	Ford	R10, R12, R15, R16, R17	Renault
MGC	MG	NSX	Acura	R20, R20 Suburban	General Motors Truck
MPV	Mazda Truck	NX	Nissan	R100	Mazda
MR2	Toyota	Navajo	Mazda Truck	R1500, R1500 Suburban	
MR2 Spyder	Toyota	Navigator	Ford Truck		General Motors Truck
MX3, MX6	Mazda	Neon	Chrysler	R2500, R2500 Suburban	
Magentis	Kia	New Beetle	Volkswagen		General Motors Truck
Magnette	MG	New Yorker	Chrysler	R3500	General Motors Truck
Magnum	Chrysler	Newport	Chrysler	R5, R8	Renault
Mainline	Ford	Ninety Eight	General Motors Corp.	RF Series	Dodge Truck
Malibu	General Motors Corp.	Nomad	General Motors Corp.	RS6	Audi
Mangusta	DeTomaso	Nova	General Motors Corp.	RSX	Acura
Manta	Opel	Nubira	Daewoo	RX2, RX3, RX4, RX7, RX8	Mazda
Marauder	Ford	Oasis	Isuzu Truck	RX300, RX330	Lexus Truck
Marina	Austin	Odyssey	Honda Truck	Rabbit	Volkswagen
Marina	Morris	Olympia	Opel	Racer	Daewoo
Mark	Jaguar	Omega	General Motors Corp.	Raider	Dodge Truck
Mark II, III	Austin	Omni	Chrysler	Ram	Dodge Truck
Mark II, III, IV, V, VI, VII, VIII	Ford	Omni Coach, Minivan, Truck	Austin	Ram Van	Dodge Truck
Mark X	Jaguar	Optima	Kia	Ram Wagon	Dodge Truck
Marlin	American Motors	Optima	Passport	Rambler	American Motors
Marquis	Ford	Outback	Subaru	Rambler	Nash
Master	General Motors Corp.	Outlander	Mitsubishi Truck	Rambler	Hudson
Matador	American Motors	Oxford	Morris	Rambler Classic	American Motors
Matador	Chrysler	P10, 20, 30	General Motors Truck	Ramcharger	Dodge Truck
Matrix	Toyota	P100, 200, 300, 400	Dodge Truck	Rampage	Dodge Truck
Maverick	Ford	P110, 120, 121, 130, 140, 220	Volvo	Ranch Wagon	Ford
Maxima	Nissan	P1500, 2500	General Motors Truck	Ranchero	Ford Truck
Mayflower	Triumph	P3500, P4000	Ford Truck	Range Rover	Land Rover
Meadowbrook	Chrysler	PT Cruiser	Dodge Truck	Ranger	Ford Truck
Medalist	Ford	Pacer	American Motors	Rapier	Sunbeam
Medallion	American Motors	Pacer	Ford	Rav 4	Toyota Truck
Medallion	Eagle Chrysler	Pacifica	Dodge Truck	Reatta	General Motors Corp.
Medium Duty	Dodge Truck	Packard	Packard	Rebel	American Motors
Merak	Maserati	Pantera	DeTomaso	Regal	General Motors Corp.
Mercury	Ford	Parisienne	General Motors Corp.	Regency	General Motors Corp.
Meteor	Ford	Park Avenue	General Motors Corp.	Rekord	Opel
Metro	General Motors Corp.	Park Ward	Rolls-Royce	Reliant	Chrysler
Metropolitan	American Motors	Parklane	Ford	Rendezvous	General Motors Truck
Metropolitan	Hudson	Paseo	Toyota	Renown	Triumph
Metropolitan	Nash	Passat	Volkswagen	Rio	Kia
Mexico	Maserati	Passport	Honda Truck	Riviera	General Motors Corp.
Miata MX5	Mazda	Pathfinder	Nissan Truck	Road Runner	Chrysler
Micra	Nissan	Patrol	Nissan Truck	Roadking	Chrysler

Model Cross Reference List

Roadmaster	General Motors Corp.	Special	Chrysler	Tercel	Toyota
Roadster	Panoz	Special	General Motors Corp.	Testarossa	Ferrari
Rocky	Daihatsu Truck	Spectra	Kia	Thames Trader	Ford Truck
Rodeo	Isuzu Truck	Spectrum	General Motors Corp.	Thing	Volkswagen
Rodeo	Renault	Speedway	Jeep	Thunderbird	Ford
Rotary	Mazda Truck	Spider	Pininfarina	Tiburon	Hyundai
Roundup	Ford	Spider 2000	Fiat	Tiger	Sunbeam
Rover 80	Rover	Spider Veloce	Alfa Romeo	Toledo	Triumph
Royal	Chrysler	Spirit	American Motors	Topaz	Ford
S-Type	Jaguar	Spirit	Chrysler	Torino	Ford
S10	General Motors Truck	Spiritfire	Triumph	Toronado	General Motors Corp.
S15	General Motors Truck	Sport Fury	Chrysler	Torpedo	General Motors Corp.
S2000	Honda	Sport Satellite	Chrysler	Touareg	Volkswagen Truck
S320	Mercedes Benz	Sport Sedan	Alfa Romeo	Touring Limousine I	Rolls-Royce
S350 Turbo Diesel	Mercedes Benz	Sportage	Kia Truck	Town & Country	Dodge Truck
S4, S6, S8	Audi	Sportsman	Standard	Town Car	Ford
S40, S80, S90	Volvo	Sportsman Wagon	Dodge Truck	Townsmen	General Motors Corp.
SC	Saturn	Sprint	General Motors Corp.	Toyo-Ace	Toyota Truck
SC1	Saturn	Sprint	General Motors Truck	Tracer	Ford
SC2	Saturn	Sprint Veloce	Alfa Romeo	Tracker	General Motors Truck
SJ410, SJ413	Suzuki Truck	Sprite	Austin	Traction Avant	Citroen
SL, 1, 2	Saturn	Spyder	Maserati	Trail Blazer	General Motors Truck
SLX	Acura Truck	Spyder	Pininfarina	Trailduster	Dodge Truck
Sable	Ford	St. Regis	Chrysler	Transport	General Motors Truck
Safari	General Motors Truck	Stag	Triumph	Travelall	Navistar/International
Salon	Moskvitsch	Standard	General Motors Corp.	Tredia	Mitsubishi
Saloon	Morris	Stanza	Nissan	Tribute	Mazda Truck
Samurai	Suzuki Truck	Star Chief	General Motors Corp.	Trooper	Isuzu Truck
Santa Fe	Hyundai Truck	Starfire	General Motors Corp.	Tundra	Toyota Truck
Sapporo	Chrysler	Starion	Mitsubishi	Turismo	Chrysler
Saratoga	Chrysler	Starlet	Toyota	Turnpike Cruiser	Ford
Satellite	Chrysler	State Commander	Studebaker	Type 2, 3, 4	Volkswagen Truck
Savana 1500, 2500, 3500	General Motors Truck	Statesman	Nash	Typhoon	General Motors Truck
Savoy	Chrysler	Station Wagon	Chrysler	Urraco	Lamborghini
Scamp	Chrysler	Stealth	Chrysler	V-8 Vantage	Aston Martin
Scamp	Dodge Truck	Stellar	Hyundai	V10, V10 Suburban	General Motors Truck
Sceptre	Humber	Stiletto	Sunbeam	V1500 Suburban	General Motors Truck
Scirocco	Volkswagen	Storm	General Motors Corp.	V20, V20 Suburban	General Motors Truck
Scorpio	Ford	Stout	Toyota Truck	V2500, V2500 Suburban	General Motors Truck
Scorpion	Lancia	Strada	Fiat	V30	General Motors Truck
Scoupe	Hyundai	Stratos	Lancia	V3000	General Motors Truck
Scout	Navistar/International	Stratus	Chrysler	V3500	General Motors Truck
Sebring	Chrysler	Streamliner	General Motors Corp.	V40, V70, V90	Volvo
Sedan DeVille	General Motors Corp.	Stylenmaster	General Motors Corp.	V8	Audi
Sedona	Kia Truck	Stylus	Isuzu	VIP	Chrysler
Senator	Opel	Stylus	Passport	VJ2, VJ3	Jeep
Sentra	Nissan	Suburban 1500, 2500	General Motors Truck	VUE	Saturn Truck
Sephia	Kia	Summit	Eagle Chrysler	Valiant	Chrysler
Sequoia	Toyota Truck	Sunbird	General Motors Corp.	Vanagon	Volkswagen Truck
Series I, II, IIA, III	Land Rover	Sunburst	General Motors Corp.	Vanden Plas	Jaguar
Seven S1, S2, S3, S4	Lotus	Sundance	Chrysler	Vanguard	Standard
Seville	General Motors Corp.	Sunfire	General Motors Corp.	Vantage	Aston Martin
Shadow	Chrysler	Sunfire	Asuna	Vega	General Motors Corp.
Sidekick	Suzuki Truck	Sunrunner	General Motors Truck	Vehi Cross	Isuzu Truck
Sienna	Toyota Truck	Sunrunner	Asuna Truck	Ventura	General Motors Corp.
Sierra 1500, 2500, 3500	General Motors Truck	Super	General Motors Corp.	Venture	General Motors Truck
Sierra Denali	General Motors Truck	Super 5	Renault	Versailles	Ford
Sigma	Mitsubishi	Super 88	General Motors Corp.	Vibe	General Motors Corp.
Silhouette	General Motors Truck	Super 90	Audi	Victor	Vauxhall
Silhouette	Lamborghini	Super Beetle	Volkswagen	Vigor	Acura
Silver Cloud	Rolls-Royce	Super Chief	General Motors Corp.	Villager	Ford Truck
Silver Dawn	Rolls-Royce	Super Deluxe	Ford	Viper	Chrysler
Silver Hawk	Studebaker	Super Minx	Hillman	Virage V-8	Aston Martin
Silver Seraph	Rolls-Royce	Super Wagon	Ford Truck	Vision	Eagle Chrysler
Silver Shadow	Rolls-Royce	Supersnipe	Humber	Vista	Eagle Chrysler
Silver Spirit	Rolls-Royce	Supra	Toyota	Vista Cruiser	General Motors Corp.
Silver Spur	Rolls-Royce	Swift	Suzuki	Vitara	Suzuki Truck
Silver Wraith	Rolls-Royce	Syclone	General Motors Truck	Viva	Vauxhall
Silverado 1500, 2500, 3500	General Motors Truck	T (T1) Series	Bentley	Vogue	Singer
Skyhawk	General Motors Corp.	T100	Toyota Truck	Volante V-8	Aston Martin
Skyhawk	Studebaker	T2 Series	Bentley	Volare	Chrysler
Skyhawk	Studebaker	TJ	Jeep	Voyage	Opel
Skyhawk	Studebaker	TR2, 3, 4, 6, 7, 8, 250	Triumph	Voyager	Dodge Truck
Skyhawk	Studebaker	TSX	Acura	Voyager	Ford
Skyhawk	Studebaker	Tacoma	Toyota Truck	Wagon	Mitsubishi Truck
Societe	Renault	Tahoe	General Motors Truck	Wagon E350	Ford Truck
Solara	Toyota	Talon	Eagle Chrysler	Wagonaire	Studebaker
Somerses	General Motors Corp.	Targa	Porsche	Wagoneer	Jeep
Sonata	Hyundai	Taurus	Ford	Wayfarer	Chrysler
Sonett	Saab	Taurus	Ford	Wild Cat	General Motors Corp.
Sonoma	General Motors Truck	Tempest	General Motors Corp.	Willys 48	Jeep
Sorento	Kia Truck	Tempo	Ford		

Model Cross Reference List

Windsor	Chrysler	280 Series	General Motors Truck	633CSI	BMW
Windstar	Ford Truck	280C, CE, E, S, SE, SEC, SEL, SL		635CSI	BMW
Wrangler	Jeep		Mercedes Benz	710	Nissan
Wyvern	Vauxhall	280Z	Nissan	720	Nissan Truck
X	General Motors Truck	280ZX	Nissan	730Li, d, l	BMW
X-1/9	Bertone	300	Chrysler	733l	BMW
X-1/9	Fiat	300	General Motors Truck	735Li, Li, l	BMW
X-Type	Jaguar	300CD, CE, D, E, SE, SEC, SEL, SL		740, d, l, il	Volvo
X3	BMW Truck		Mercedes Benz	745Li l	BMW
X5	BMW Truck	300ZX	Nissan	750il, Li	BMW
X90	Suzuki Truck	304	Peugeot	760, l, Li	Volvo
XG300	Hyundai	310	Nissan	770	Fiat
XG350	Hyundai	311	Nissan	780	Volvo
XJ	Jaguar	312	Nissan	800	Chrysler
XK	Jaguar	318l, lL, IS, TI, iC	BMW	808	Mazda
XL-7	Suzuki Truck	320l	BMW	810	Nissan
XLC2	Hummer	323	Mazda	840Cl	BMW
XR4Ti	Ford	323Ci, l, IS, iT	BMW	850	Fiat
XT	Subaru	325, Ci, E, ES, IS, Xi	BMW	850	Volvo
Xterra	Nissan Truck	328Ci, l, IC, IS	BMW	850Cl, CSI	BMW
Y	General Motors Truck	330	Chrysler	880	Chrysler
Yeoman	General Motors Corp.	330Ci, Xi, l	BMW	900	Saab
York	Ford	340 America	Ferrari	911, Carrera, 2, 4	Porsche
Yukon	General Motors Truck	342 America	Ferrari	911E, L, S, SC, T, TE, TK	Porsche
Z100	Iveco/Magirus	350	General Motors Truck	912, E	Porsche
Z3, Z4	BMW	350SL	Mercedes Benz	914, 914/6	Porsche
Z600	Honda	350Z	Nissan	924, S	Porsche
Z8	BMW	356, A, B, C	Porsche	928, CS, GT, GTS, S, S4	Porsche
Zagato	Lancia	375 America	Ferrari	929	Mazda
Zephyr	Ford	380SE, SEC, SEL, SL, SLC	Mercedes Benz	930 Turbo	Porsche
2.8 Bavaria	BMW	400	Chrysler	940	Volvo
3.0 Bavaria	BMW	400 GT	Lamborghini	944, S	Porsche
024	Chrysler	400 Superamerica	Ferrari	1100	Austin
3.0CS, CSI, CSL, S, SI	BMW	400 i	Ferrari	1100	MG
4 Runner	Toyota Truck	400E, SE, SEL	Mercedes Benz	1200	General Motors Truck
4CV	Renault	403	Peugeot	1200	Mazda Truck
18i	Renault	404	Peugeot	1200	Nissan
5CV/Dauphine	Renault	405	Peugeot	122S	Volvo
5th Avenue	Chrysler	410	Nissan	1300	Austin
9-3	Saab	410 Superamerica	Ferrari	1300	MG
9-5	Saab	411, SS	Nissan	1300	Mazda Truck
80	Audi	420, G	Jaguar	1300, 1400	Subaru
88 Royale	General Motors Corp.	420SEL	Mercedes Benz	1500	General Motors Truck
90, CS, S	Audi	430	Maserati	1600	Alfa Romeo
95	Saab	440	Chrysler	1600	BMW
96	Saab	440	Jeep	1600	Subaru
99	Saab	441	Jeep	1600 Metro II	Navistar/International
100	Audi	442	General Motors Corp.	1800	Austin
100	Austin	442	Jeep	1800	BMW
110	Land Rover	450	General Motors Truck	1800	Subaru
142S	Volvo	450SE, SEL, SL, SLC	Mercedes Benz	1800	Triumph
144S	Volvo	500 Superfast	Ferrari	1800E, S	Volvo
145S	Volvo	500E, SEC, SEL, SL	Mercedes Benz	1802	BMW
150	General Motors Truck	504	Peugeot	2000	BMW
164	Alfa Romeo	505	Peugeot	2000	Rover
164S	Volvo	510	Nissan	2000 GTX	Chrysler
180	Mercedes Benz	512 BB, Bbi, TR	Ferrari	2000Tii	BMW
190, B, C, D, E, SL	Mercedes Benz	520	BMW	2002, A, Ti, Tii	BMW
200, D	Mercedes Benz	520	Nissan Truck	2500	BMW
200	Audi	521	Nissan Truck	2500	General Motors Truck
200SX	Nissan	524TD	BMW	2600	Mitsubishi Truck
203	Peugeot	525i, IT	BMW	2800, CS	BMW
210	Nissan	528E, l, IT	BMW	3000	Austin
220A, B, D, S, SB, SE, SEB	Mercedes Benz	530i, IT	BMW	3000GT	Mitsubishi
230, S, SL	Mercedes Benz	533l	BMW	3100	General Motors Truck
240D	Mercedes Benz	535i, IS	BMW	3200	General Motors Truck
240SX	Nissan	540i, IA, iT	BMW	3500	General Motors Truck
240Z	Nissan	545i	BMW	3600	General Motors Truck
242	Volvo	550	Ferrari	4000	Audi
244	Volvo	550	General Motors Truck	4000	General Motors Truck
245	Volvo	560SEC, SEL, SL	Mercedes Benz	4000S	Audi
250	General Motors Truck	600	Chrysler	4400	General Motors Truck
250	Mercedes Benz	600	Mercedes Benz	4500	General Motors Truck
250C, S, SC, SE, SEC, SL, U	Mercedes Benz	600	Navistar/International	5000	Audi
	Mercedes Benz	600SEC, SEL, SL	Mercedes Benz	5000	General Motors Truck
260 Series	General Motors Truck	604	Peugeot	5700	General Motors Truck
260E	Mercedes Benz	610	Nissan	6400	General Motors Truck
260Z	Nissan	616	Mazda	9000	Saab
262	Volvo	618	Mazda		
264	Volvo	620	Nissan Truck		
265	Volvo	626	Mazda		
280	Mercedes Benz	630CSI	BMW		

Chrysler Car

Model Year and Engine Identification

1981-03 Model Years

1B3 BD21DX B A 100001

Engine Code Model Year
8th Symbol 10th Symbol

1977-80 Model Years

PM23E 7 123456

Engine Code Model Year
5th Symbol 6th Symbol

Model Year Code			
Code	Year	Code	Year
A	1980	N	1992
B	1981	P	1993
C	1982	R	1994
D	1983	S	1995
E	1984	T	1996
F	1985	V	1997
G	1986	W	1998
H	1987	X	1999
J	1988	Y	2000
K	1989	1	2001
L	1990	2	2002
M	1991	3	2003

VIN	Years	Cyl	CID	Liters	Engine Description
A	83-86	4	97	1.6	2BC OHV
A	78-82	4	105	1.7	2BC SOHC
A	87-89	4	135	2.2	TBI SOHC
A	91-93	4	135	2.2	MPFI DOHC
A	95-98	4	1800cc	1.8	SEFI SOHC
A	84	4	86	1.4	2BC SOHC
A	91-94	4	92	1.5	MPFI SOHC
B	82-83	4	105	1.7	2BC SOHC
B	92-94	4	107	1.8	EFI SOHC
B	81-82	4	135	2.2	2BC SOHC
B	91-92	V6	181	3.0	MPFI SOHC
B	84	4	98	1.6	2BC SOHC
C	93-94	4	112	1.8	MPFI DOHC
C	95-03	4	122	2.0	MPFI SOHC
C	82-88	4	135	2.2	2BC SOHC
C	89-90	4	135	2.2	MPFI TC SOHC
C	91-92	V6	181	3.0	MPFI TC DOHC
C	75-81	6	225	3.7	2BC OHV
D	92	4	112	1.8	MPFI SOHC
D	84-89	4	122	2.0	2BC SOHC
D	83-94	4	135	2.2	TBI SOHC
D	81-82	4	156	2.6	2BC SOHC
D	77-80	6	225	3.7	2BC OHV
E	84-89	4	135	2.2	MPFI TC SOHC
E	81-83	6	225	3.7	1BC OHV
E	92-02	V10	488	8.0	MPFI OHV
F	90-94	4	122	2.0	MPFI TC DOHC
F	01-03	4	122	2.0	MPFI SOHC
F	83-85	4	135	2.2	2BC SOHC

VIN	Years	Cyl	CID	Liters	Engine Description
F	78-83	4	156	2.6	2BC SOHC
F	93-97	V6	215	3.5	MPFI SOHC
F	84-90	4	98	1.6	MPFI TC SOHC
G	93-94	4	144	2.4	MPFI SOHC
G	83-87	4	156	2.6	2BC SOHC
G	99-03	V6	215	3.5	MPFI SOHC
G	01-03	4	143	2.4	EFI DOHC
G	75-81	V8	318	5.2	2BC OHV
G	77-78	V8	400	6.6	2BC OHV
H	90	4	153	2.5	TBI SOHC
H	84-87	4	156	2.6	SFI TC SOHC
H	01-03	V6	181	3.0	MPFI SOHC
H	93-96	V6	181	3.0	MPFI SOHC
H	81-87	6	225	3.7	1BC OHV
H	95-00	V6	153	2.5	MPFI SOHC
H	78-80	V8	318	2.5	4BC OHV
J	89-93	4	153	2.5	TCI MPFI SOHC
J	93	V6	181	3.0	MPFI DOHC
J	93-96	V6	181	3.0	MPFI DOHC
J	98-01	V6	197	3.2	MPFI SOHC
J	74-79	V8	360	5.9	4BC OHV
J	79-84	4	86	1.4	2BC SOHC
J	81	V8	318	5.2	4BC OHV
J	81-82	V8	318	5.2	EFI OHV
K	86-95	4	153	2.5	TBI SOHC
K	93-96	V6	181	3.0	MPFI TC DOHC
K	02-03	V6	215	3.5	MPFI SOHC
K	81-82	V8	318	5.2	2BC OHV
K	75-80	V8	360	5.9	2BC OHV

Chrysler Car

Model Year and Engine Identification (Cont.)

VIN	Years	Cyl	CID	Liters	Engine Description
K	85-91	4	92	1.5	2BC SOHC
K	71-82	4	98	1.6	2BC SOHC
L	91-03	V6	230	3.8	MPFI OHV
L	81-82	V8	318	5.2 *	2BC OHV
L	75-80	V8	360	5.9	4BC ** OHV
M	02-03	V6	215	3.5	MPFI SOHC
M	80-82	V8	318	5.2	4BC OHV
N	95-97	4	122	2.0	MPFI SOHC
N	85-89	4	156	2.6	MPFI TCI SOHC
N	95-00	V6	153	2.5	MPFI SOHC
N	81-82	V8	318	5.2	4BC OHV
N	83	V8	318	5.2	EFI OHV
N	74-78	V8	400	6.6	4BC OHV
P	78-89	V8	318	5.2	2BC OHV
P	74-78	V8	400	6.6	4BC OHV
P	87-88	4	92	1.5	MPFI SOHC
R	98-03	V6	167	2.7	MPFI DOHC
R	90-03	V6	201	3.3	MPFI OHV
R	80-87	V8	318	5.2	4BC OHV
R	89-90	4	135	2.2	MPFI TC DOHC
S	89-92	V6	181	3.0	MPFI SOHC
S	83-89	V8	318	5.2	4BC OHV
S	03	4	148	2.4	MPFI TCI DOHC
T	89-94	4	107	1.8	MPFI SOHC
T	03	V6	167	2.7	MPFI FFV DOHC
T	93-97	V6	201	3.3	MPFI OHV

VIN	Years	Cyl.	CID	Liters	Engine Description
T	72-78	V8	440	7.2	4BC OHV
U	74-81	4	122	2.0	2BC SOHC
U	98-01	V6	167	2.7	SEFI DOHC
U	90-92	V6	182	3.0	MPFI SOHC
U	94-95	V6	201	3.3	MPFI FFV OHV
U	75-78	V8	440	7.2 **	2BC OHV
V	93-94	4	153	2.5	MPFI FFV SOHC
V	90	4	98	1.6	MPFI DOHC
V	01-03	V6	315	3.5	MPFI SOHC
V	89-91	4	122	2.0	MPFI SOHC
W	90-92	4	144	2.4	MPFI SOHC
W	92-95	4	153	2.5	TBI SOHC
X	95-03	4	148	2.4	MPFI DOHC
X	89-90	4	92	1.5	MPFI SOHC
Y	95-99	4	122	2.0	MPFI DOHC
Y	89-90	4	98	1.6	MPFI DOHC
Z	79-80	V8	360	5.9	4BC OHV
Z	03	V10	505	8.3	MPFI OHV
Z	77-79	4	98	1.6	2BC SOHC
Z	89-90	4	98	1.6	MPFI TC DOHC
2	82-83	4	86	1.4	2BC SOHC
3	87-00	V6	181	3.0	MPFI SOHC
3	82-83	4	98	1.6	2BC SOHC
4	83-89	V8	318	5.2	2BC OHV
8	86	4	135	2.2	2BC SOHC

- * Special Order
- ** High Performance
- DI Direct Injection
- EFI Electronic Fuel Injection
- FFV Flex Fuel Vehicle
- MPFI Multi-port Fuel Injection
- SEFI Sequential Electronic Fuel Injection
- TC Turbocharged
- TCI Turbocharged Intercooled
- TBI Throttle Body Injection

Dodge Truck

Model Year and Engine Identification

1981-03 Model Years

1B3 BD21DX B A 100001

Engine Code Model Year
8th Symbol 10th Symbol

1977-80 Model Years

PM23E 7 123456

Engine Code Model Year
5th Symbol 6th Symbol

Model Year Code			
Code	Year	Code	Year
A	1980	N	1992
B	1981	P	1993
C	1982	R	1994
D	1983	S	1995
E	1984	T	1996
F	1985	V	1997
G	1986	W	1998
H	1987	X	1999
J	1988	Y	2000
K	1989	1	2001
L	1990	2	2002
M	1991	3	2003

VIN	Years	Cyl	CID	Liters	Engine Description
A	73-80	V8	440	7.2	4BC OHV
B	82-83	4	105	1.7	2BC SOHC
B	96-03	4	148	2.4	DOHC MPFI
B	70-80	6	225	3.7	2BC OHV
B	74-80	V8	400	6.6	2BC OHV
C	82-88	4	135	2.2	2BC SOHC
C	78-80	6	225	3.7	1BC OHV
C	90-96	6	359	5.9	Diesel TCI OHV
C	03	6	359	5.9	HO Diesel TCI OHV
D	84-89	4	122	2.0	SOHC 3BC
D	03	V8	345	5.7	Hemi SEFI
D	97-98	6	359	5.9	Diesel TCI OHV
D	74-79	V8	440	7.2	4BC OHV
E	81-83	6	225	3.7	1BC OHV
E	80	6	225	3.7	2BC OHV
E	86-89	4	156	2.6	2BC SOHC
E	86-89	4	156	2.6	MPFI SOHC
E	70-81	V8	318	5.2	2BC OHV
E	74-78	V8	440	7.2	4BC OHV
F	71-80	V8	360	5.9	2BC OHV
F	74-78	6	243	4.0	Diesel OHV
G	83-87	4	156	2.6	2BC SOHC
G	93	4	144	2.4	SOHC MPFI
G	03	4	148	2.4	TCI DOHC
G	89-95	4	153	2.5	TBI OHV
G	98-01	V6	201	3.3	Flex Fuel OHV
H	81-87	6	225	3.7	1BC OHV
H	74-79	6	243	4.0	Diesel OHV
J	89-93	4	153	2.5	TCI SOHC

VIN	Years	Cyl	CID	Liters	Engine Description
J	84-85	4	143	2.3	Diesel TC SOHC
J	94-96	V6	201	3.3	CNG OHV
J	72-78	V8	400	6.6	2BC OHV
K	86-95	4	153	2.5	SOHC TBI
K	02-03	V6	226	3.7	SOHC MPFI
K	76-79	V8	360	5.9	2BC OHV
L	91-03	V6	230	3.8	MPFI OHV
M	87	V6	239	3.9	2BC OHV
N	00-03	V8	287	4.7	SOHC MPFI
N	79-80	6	225	3.7	1BC OHV
P	78-89	V8	318	5.2	2BC OHV
P	96-02	4	150	2.5	MPFI OHV
R	90-03	V6	201	3.3	MPFI OHV
R	80-87	V8	318	5.2	4BC OHV
S	89-92	V6	181	3.0	MPFI SOHC
S	83-89	V8	318	5.2	4BC OHV
S	80-82	V8	360	5.9	2BC OHV
T	89-90	4	153	2.5	Turbo SOHC
T	83-87	V8	318	5.2	2BC OHV
T	92-03	V8	318	5.2	CNG OHV
T	78-83	V8	360	5.9	4BC OHV
U	74-81	4	122	2.0	2BC SOHC
U	84-85	V8	318	5.2	4BC OHV
U	80	V8	360	5.9	4BC OHV
V	83-86	V8	360	5.9	2BC OHV
V	74-78	V8	400	6.6	2BC OHV
W	90-92	4	144	2.4	SOHC MPFI
W	92-95	4	153	2.5	TBI SOHC
W	79-80	4	156	2.6	2BC SOHC

Dodge Truck

Model Year and Engine Identification (Cont.)

VIN	Years	Cyl.	CID	Liters	Engine Description
W	82-83	6	225	3.7	2BC OHV
W	83-88	V8	360	5.9	4BC OHV
W	94-03	V10	488	8.0	Iron Block OHV
X	88-91	V6	239	3.9	TBI OHV
X	92-03	V6	239	3.9	MPFI OHV
Y	88-91	V8	318	5.2	TBI OHV
Y	92-03	V8	318	5.2	MPFI OHV
Z	89-92	V8	360	5.9	TBI OHV
Z	93-03	V8	360	5.9	MPFI OHV
1	83-88	V8	360	5.9	4BC OHV
3	87-00	V6	181	3.0	MPFI SOHC

VIN	Years	Cyl.	CID	Liters	Engine Description
3	01-03	V6	201	3.3	Flex Fuel OHV
5	81-83	4	122	2.0	2BC SOHC
5	88	V8	360	5.9	4BC OHV
5	89-92	V8	360	5.9	TBI OHV
5	93-02	V8	360	5.9	MPFI OHV
6	98-03	6	359	5.9	Diesel TCI OHV
7	81-82	4	156	2.6	2BC SOHC
7	01-02	6	359	5.9	Diesel TCI OHV
8	89-93	6	359	5.9	Diesel TC OHV
9	83	4	143	2.3	Diesel TC SOHC

CNG Compressed Natural Gas
 MPFI Multi-port Fuel Injection
 TC Turbocharged
 TCI Turbocharged Intercooled
 TBI Throttle Body Injection

Ford Car

Model Year and Engine Identification

1981-03 Model Years

1ABCD3G @ DA 100,001

Engine Code Model Year
8th Symbol 10th Symbol

1977-80 Model Years

7S62H 123456

Engine Code Model Year
5th Symbol 1st Symbol

Model Year Code			
Code	Year	Code	Year
A or 0	1980	N	1992
B	1981	P	1993
C	1982	R	1994
D	1983	S	1995
E	1984	T	1996
F	1985	V	1997
G	1986	W	1998
H	1987	X	1999
J	1988	Y	2000
K	1989	1	2001
L	1990	2	2002
M	1991	3	2003

VIN	Years	Cyl	CID	Liters	Engine Description
A	80-90	L4	140	2.3	SOHC
A	93-97	L4	122	2.0	DOHC
A	00-03	V8	241	3.9	DOHC
A	99-02	V8	330	5.4	DOHC
B	93-97	V6	153	2.5	DOHC
B	80-82	L6	200	3.3	OHV
C	89-92	L4	134	2.2	SOHC
C	95	V8	351W	5.8	H/O Cobra
D	83	L4	140	2.3	OHC Turbo
D	86-90	L4	153	2.5	OHV
D	80-82	V8	255	4.2	OHV
D	93-95	V8	302	5.0	H/O Cobra
E	87-92	V8	302	5.0	H/O
F	82-91	V8	302	5.0	OHV
G	98-00	V6	155	2.5	DOHC
G	80-91	V8	351W	5.8	OHV
H	89-97	L4	81	1.3	SOHC
H	84-87	L4	122	2.0	Diesel
J	85-96	L4	116	1.9	SOHC/EFI
J	84	L4	140	2.3	OHV
K	88-89	L4	81	1.3	SOHC
K	94-95	L4	116	1.9	H/O
L	89-92	L4	134	2.2	Turbo
L	84-85	L6	149	2.4	Turbo Diesel
L	95-02	V6	155	2.5	DOHC
L	97-03	V8	330	5.4	SOHC
M	91-93	L4	140	2.3	SOHC
M	84-87	V8	302	5.0	H/O
N	90-91	L4	153	2.5	OHV

VIN	Years	Cyl	CID	Liters	Engine Description
N	96-99	V8	207	3.4	DOHC
P	97-03	L4	122	2.0	SOHC
P	93-95	V6	195	3.2	DOHC/SHO
R	89-92	L4	134	2.2	SOHC/Turbo
R	84	L4	140	2.3	OHV/1BC
R	89-90	V6	232	3.8	S/C
R	03	V8	281	4.6	DOHC
S	85-91	L4	140	2.3	OHV H/O
S	96-03	V6	181	3.0	DOHC
S	97-03	10	415	6.8	SOHC
T	81	L4	140	2.3	SOHC/Turbo
T	91-95	V8	302	5.0	H/O
U	86-03	V6	183	3.0	OHV
V	93-03	V8	281	4.6	DOHC
W	79-89	L4	140	2.3	SOHC/Turbo
W	91-03	V8	281	4.6	SOHC
X	85-94	L4	140	2.3	OHV
X	83	L6	200	3.3	OHV
Y	89-95	V6	183	3.0	DOHC/SHO
Y	03	V8	281	4.6	DOHC S/C
Z	91-94	L4	98	1.6	DOHC
Z	96-00	L4	1989cc	2.0	DOHC CNG
1	93-98	V6	183	3.0	OHV
2	81-85	L4	98	1.6	SOHC
2	96-03	V6	183	3.0	OHV Flex Fuel
3	95-03	L4	1989cc	2.0	DOHC
3	83-87	V6	232	3.8	OHV
4	82-85	L4	98	1.6	SOHC H/O
4	87-95	V6	232	3.8	OHV

Ford Car

Model Year and Engine Identification (Cont.)

VIN	Years	Cyl	CID	Liters	Engine Description
5	83-89	L4	98	1.6	SOHC
5	02-03	L4	121	2.0	DOHC
6	91-94	L4	98	1.6	DOHC Turbo
6	84-85	L4	140	2.3	SOHC LP

VIN	Years	Cyl	CID	Liters	Engine Description
6	96	V8	281	4.6	SOHC
8	81-85	L4	98	1.6	SOHC Turbo
9	85-90	L4	116	1.9	SOHC
9	95-03	V8	281	4.6	SOHC CNG

CNG Compressed Natural Gas
 EFI Electronic Fuel Injection
 H/O High Output
 S/C Supercharged
 SHO Super High Output

Ford Truck

Model Year and Engine Identification

1981-03 Model Years

1ABCD3G @ DA 100,001

Engine Code Model Year
8th Symbol 10th Symbol

1977-80 Model Years

7S62H 123456

Engine Code Model Year
5th Symbol 1st Symbol

Model Year Code			
Code	Year	Code	Year
A or 0	1980	N	1992
B	1981	P	1993
C	1982	R	1994
D	1983	S	1995
E	1984	T	1996
F	1985	V	1997
G	1986	W	1998
H	1987	X	1999
J	1988	Y	2000
K	1989	1	2001
L	1990	2	2002
M	1991	3	2003

VIN	Years	Cyl	CID	Liters	Engine Description
A	83-97	L4	140	2.3	SOHC
A	99-03	V8	330	5.4	DOHC
B	83-84	L4	140	2.3	SOHC
C	83-88	L4	121	2.0	SOHC
C	98-01	L4	153	2.5	SOHC
C	92-93	V8	444	7.3	IDI Turbo
D	02-03	L4	140	2.3	DOHC
D	81-82	V8	255	4.2	OHV
E	85-87	L4	140	2.3	SOHC Diesel
E	97-03	V6	244	4.0	SOHC
E	80-82	L6	300	4.9	OHV
F	80-85	V8	302	5.0	OHV
F	94-03	V8	444	7.3	DI Turbo
G	80-85	V8	351W	5.8	OHV
G	87-98	V8	460	7.5	OHV
H	2003	V8	281	4.6	DOHC
H	77-82	V8	351M	5.8	OHV
H	85-96	V8	351W	5.8	OHV
K	94	V8	444	7.3	IDI Turbo
K	2003	V6	244	4.0	SOHC Flex Fuel
L	97-03	V8	330	5.4	SOHC
L	80-87	V8	460	7.5	OHV
M	79-82	L4	122	2.0	SOHC
M	97-03	V8	330	5.4	SOHC CNG
M	88-94	V8	444	7.3	IDI Diesel
N	85-96	V8	302	5.0	OHV
N	97	V8	330	5.4	SOHC

VIN	Years	Cyl	CID	Liters	Engine Description
P	83-84	L4	134	2.2	SOHC
P	96-01	V8	302	5.0	OHV
P	2003	V8	363	6.0	Diesel
R	01-03	V8	281	4.6	DOHC
S	83-86	V6	171	2.8	OHV
S	97-03	V10	415	6.8	SOHC
T	86-92	V6	177	2.9	OHV
T	99-02	V6	3275cc	3.3	SOHC
U	86-03	V6	183	3.0	OHV
V	99-03	V6	183	3.0	OHV Flex Fuel
W	79-82	L4	140	2.3	SOHC
W	97-03	V8	281	4.6	SOHC
X	90-00	V6	244	4.0	OHV
Y	83-96	L6	300	4.9	OHV
Z	94-96	L6	300	4.9	OHV
Z	98-01	V8	330	5.4	SOHC Flex Fuel
Z	80-82	V8	400	6.6	OHV
1	01-03	V6	181	3.0	DOHC
1	83-87	V8	420	6.9	Diesel
2	97-03	V6	256	4.2	OHV
3	83-87	V6	232	3.8	OHV
3	99-03	V8	330	5.4	SOHC S/C
4	95-03	V6	232	3.8	OHV
6	97-03	V8	281	4.6	SOHC
9	97-98	V8	281	4.6	SOHC LP
9	82-96	L6	300	4.9	OHV

CNG Compressed Natural Gas
DI Direct Injection
IDI Indirect Injection
S/C Supercharged

General Motors Car

Model Year and Engine Identification

1981-03 Model Years

1G1GZ37H0GR123456

Engine Code Model Year
8th Symbol 10th Symbol

1978-80 Model Years

2B377AP 100.001

Engine Code Model Year
5th Symbol 6th Symbol

Model Year Code			
Code	Year	Code	Year
A or 0	1980	N	1992
B	1981	P	1993
C	1982	R	1994
D	1983	S	1995
E	1984	T	1996
F	1985	V	1997
G	1986	W	1998
H	1987	X	1999
J	1988	Y	2000
K	1989	1	2001
L	1990	2	2002
M	1991	3	2003

VIN	Years	Cyl	CID	Liters	Engine Description
A	88-89	L4	138	2.3	MPFI DOHC
A	90-94	L4	138	2.3	MPFI DOHC
A	78-87	V6	231	3.8	2BC OHV
A	04	V8	281	4.6	SFI DOHC
B	83-84	L4	121	2.0	2BC OHV
B	86	V6	231	3.8	MPFI OHV
B	91-95	V8	300	4.9	MPFI OHV
C	78-79	V6	196	3.2	2BC OHC
C	88-91	V6	231	3.8	MPFI OHV
C	95-03	V8	244	4.0	MPFI DOHC
D	76-79	L6	250	4.1	1BC OHV
D	82-86	L4	111	1.8	Diesel SOHC
D	87-95	L4	138	2.3	MPFI DOHC
E	82-86	V6	181	3.0	2BC OHV
E	88-93	V8	305	5.0	TBI OHV
E	99-03	V6	207	3.4	MPFI OHV
F	76-81	V8	260	4.3	2BC OHV
F	83-84	L4	151	2.5	2BC OHV
F	88-92	V8	305	5.0	MPFI OHV
F	02-04	L4	134	2.2	MPFI DOHC
G	82	L4	112	1.8	2BC OHV
G	84-88	V8	305	5.0	4BC OHV
G	90-91	L4	134	2.2	TBI OHV
G	97-03	V8	346	5.7	SFI OHV
H	92-94	L4	122	2.0	MPFI SOHC
H	78-88	V8	305	5.0	4BC OHV
H	99-02	V6	212	3.5	MPFI DOHC
J	79-82	V8	267	4.4	2BC OHV
J	84-86	L4	112	1.8	MPFI SOHC
J	89-95	V8	350	5.7	MPFI DOHC
J	99-04	V6	189	3.1	MPFI OHV

VIN	Years	Cyl	CID	Liters	Engine Description
K	77-79	V8	400	6.6	4BC OHV
K	85-86	L4	92	1.5	2BC SOHC
K	80-82	V6	229	3.8	2BC OHV
K	87-91	L4	121	2.0	TBI SOHC
K	97-03	V6	231	3.8	MPFI OHV
L	74-82	V8	350	5.7	4BC OHV
L	83-84	V6	173	2.8	2BC OHV
L	85-88	V6	181	3.0	MPFI OHV
L	90-95	V6	231	3.8	MPFI OHV
L	03-04	L4	110	1.8	MPFI DOHC
M	78-79	V6	200	2.3	2BC OHV
M	85-86	L3	61	1.0	2BC SOHC
M	87-90	L4	121	2.0	MPFI SOHC
M	93-99	V6	189	3.1	MPFI OHV
N	78-85	V8	350	5.7	Diesel OHV
N	88-93	V6	204	3.3	MPFI OHV
N	03-04	V6	196	3.2	MPFI DOHC
O	82-86	L4	112	1.8	TBI SOHC
P	1979	V8	260	4.3	Diesel OHV
P	83-86	L4	121	2.0	TBI OHV
P	92-97	V8	350	5.7	MPFI OHV
P	2004	V8	346	5.7	SFI OHV
R	76-80	V8	350	5.7	4BC OHV
R	82-92	L4	151	2.5	TBI OHV
R	97-03	V6	181	3.0	MPFI DOHC
S	77-79	V8	425	7.0	4BC OHV
S	80-81	V6	265	4.3	2BC OHV
S	1983	V8	305	5.0	TBI OHV
S	85-89	V6	173	2.8	TBI OHV
S	93-95	V6	207	3.4	MPFI OHV
S	01-03	V8	346	5.7	SFI OHV

General Motors Car

Model Year and Engine Identification (Cont.)

VIN	Years	Cyl	CID	Liters	Engine Description
T	77-79	V8	425	7.0	EFI OHV
T	80-81	V8	301	4.9	4BC/Turbo OHV
T	82-85	V6	260	4.3	Diesel OHV
T	88-94	V6	189	3.1	MPFI OHV
T	96-02	L4	146	2.4	MPFI DOHC
U	85-91	L4	151	2.5	TBI OHV
V	78-80	L4	151	2.5	2BC OHV
V	89-90	V6	189	3.1	MPFI/Turbo OHV
V	82-84	V6	260	4.3	Diesel OHV
W	78-81	V8	301	4.9	4BC OHV
W	85-89	V6	173	2.8	MPFI OHV
W	94-96	V8	265	4.3	MPFI OHV
W	1993	V6	189	3.1	MPFI OHV
X	78-80	V8	350	5.7	4BC OHV
X	81-86	V6	173	2.8	2BC OHV
X	91-97	V6	207	3.4	MPFI DOHC
Y	77-79	V8	301	4.9	2BC OHV
Y	80-90	V8	307	5.0	4BC OHV
Y	93-03	V8	281	4.6	MPFI DOHC
Z	76-79	V8	400	6.6	4BC OHV
Z	81-84	V6	173	2.8	2BC OHV
Z	85-93	V6	262	4.2	TBI OHV
0	82-86	L4	112	1.8	TBI SOHC
1	78-79	L4	151	2.5	2BC OHV
1	82-84	V6	173	2.8	2BC OHV
1	87-89	L4	121	2.0	TBI OHV
1	92-03	V6	231	3.8	MPFI/SC OHV
2	78-79	V6	231	3.8	2BC OHV
2	82-86	L4	151	2.5	TBI OHV
2	87-94	L3	61	1.0	EFI SOHC
2	98-01	L4	79	1.3	MPFI SOHC
2	2004	V6	231	3.8	SFI OHV
3	92-94	L4	138	2.3	MPFI SOHC
3	78-84	V6	231	3.8	Turbo OHV
3	1990	V8	273	4.5	MPFI OHV
4	78-79	V8	350	5.7	4BC OHV
4	85-88	L4	98	1.6	2BC SOHC
4	92-02	L4	134	2.2	MPFI OHV
4	80-84	V6	252	4.1	4BC OHV

VIN	Years	Cyl	CID	Liters	Engine Description
4	2004	V6	231	3.8	SFI OHV
5	80-84	L4	151	2.5	2BC OHV
5	86-88	L3	61	1.0	2BC SOHC
5	88-92	L4	98	1.6	MPFI DOHC
5	88-89	V8	275	4.5	TBI OHV
6	80-83	V8	368	6.0	4BC OHV
6	80-88	V8	350	5.7	4BC OHV
6	90-93	L4	98	1.6	TBI DOHC
6	90-01	L3	61	1.0	TBI SOHC
6	03-04	L4	134	2.2	MPFI DOHC
7	1980	V6	173	2.8	2BC OHV
7	1982	V8	305	5.0	2/TBI OHV
7	1983	V8	305	5.0	4BC OHV
7	86-89	L4	92	1.5	2BC SOHC
7	86-87	V6	231	3.8	SFI/Turbo OHV
7	87-88	V8	252	4.1	EFI OHV
7	90-96	V8	350	5.7	TBI OHV
7	91-93	L4	116	1.9	MPFI DOHC
8	79-80	V8	350	5.7	4BC OHV
8	1980	V8	350	5.7	EFI OHV
8	82-92	V8	350	5.7	EFI OHV
8	82-87	V8	252	4.1	EFI OHV
8	1982	V6	260	4.3	2BC OHV
8	1984	V6	231	3.8	4BC/Turbo OHV
8	89-92	V8	273	4.5	MPFI OHV
8	92-03	L4	110	1.8	MPFI DOHC
8	00-04	L4	110	1.8	MPFI DOHC
9	1979	L4	151	2.5	2BC OHV
9	80-81	L4	98	1.6	2BC SOHC
9	80-84	V8	368	6.0	FI OHV
9	83-84	V6	229	3.8	2BC OHV
9	83-90	V8	307	5.0	4BC OHV
9	84-85	V6	231	3.8	MPFI/Turbo OHV
9	85-88	V6	173	2.8	MPFI OHV
9	86-89	L4	92	1.5	MPFI/Turbo SOHC
9	91-99	L4	116	1.9	TBI SOHC
9	92-97	L4	79	1.3	TBI SOHC
9	94-04	V8	281	4.6	MPFI DOHC

EFI Electronic Fuel Injection
 FI Fuel Injected
 MPFI Multi-Port Fuel Injection
 S/C Supercharged
 SFI Sequential Fuel Injection
 TBI Throttle Body Injection

General Motors Truck

Model Year and Engine Identification

1981-03 Model Years	
1G1GZ37H0GR123456	

Engine Code Model Year
8th Symbol 10th Symbol

1978-80 Model Years	
2B377AP 100.001	

Engine Code Model Year
5th Symbol 6th Symbol

Model Year Code			
Code	Year	Code	Year
A or O	1980	N	1992
B	1981	P	1993
C	1982	R	1994
D	1983	S	1995
E	1984	T	1996
F	1985	V	1997
G	1986	W	1998
H	1987	X	1999
J	1988	Y	2000
K	1989	1	2001
L	1990	2	2002
M	1991	3	2003

VIN	Years	Cyl	CID	Liters	Engine Description
A	82-85	L4	119	1.9	2BC SOHC
A	92-94	L4	151	2.5	TBI OHV
A	00-03	L4	134	2.2	MPFI DOHC
B	82-85	V6	173	2.8	2BC OHV
B	90-91	V6	262	4.3	TBI OHV
B	00-03	V6	181	3.0	SFI OHV
C	82-94	V8	379	6.2	Diesel OHV
C	00-03	L4	122	2.0	MPFI DOHC
D	84-85	L6	250	4.1	2BC OHV
D	90-95	V6	189	3.1	MPFI OHV
D	00-03	L4	134	2.2	MPFI DOHC
E	85-91	L4	151	2.5	TBI OHV
E	96-03	V6	207	3.4	MPFI OHV
F	81-86	V8	305	5.0	4BC OHV
F	92-02	V8	396	6.5	Diesel OHV
G	79-81	V8	305	5.0	2BC OHV
G	00-03	V8	496	8.1	MPFI OHV
H	79-87	V8	305	5.0	4BC OHV
H	88-95	V8	305	5.0	TBI OHV
J	82-93	V8	379	6.2	Diesel OHV
J	96-02	V8	454	7.4	MPFI OHV
K	80-82	V6	229	3.8	2BC OHV
K	88-95	V8	350	5.7	TBI OHV
L	82-86	V8	350	5.7	4BC OHV
L	89-91	L4	239	3.9	Diesel OHV
L	92-95	V6	231	3.8	MPFI OHV
M	80-89	V8	350	5.7	4BC OHV
M	96-02	V8	305	5.0	MPFI OHV
N	82-84	V8	350	5.7	Diesel OHV

VIN	Years	Cyl	CID	Liters	Engine Description
N	85-86	V6	262	4.3	4BC OHV
N	87-96	V8	454	7.4	TBI OHV
N	00-03	V8	364	6.0	MPFI OHV
P	81-83	V8	350	5.7	2BC OHV
P	94-96	V8	396	6.5	Diesel OHV
R	86-93	V6	173	2.8	TBI OHV
R	96-02	V8	350	5.7	TBI OHC
S	82-85	L4	137	2.2	Diesel OHV
S	94-01	V8	396	6.5	Diesel OHV
T	73-89	L6	292	4.8	1BC OHV
T	99-03	V8	327	5.3	MPFI OHV
U	89-95	L4	97	1.6	TBI SOHC
U	99-03	V8	366	6.0	MPFI OHV
V	99-03	V8	294	4.8	MPFI OHV
W	80-89	V8	454	7.4	4BC OHV
W	92-95	V6	262	4.3	CPI OHV
W	96-03	V6	262	4.3	MPFI OHV
X	96-03	V6	262	4.3	MPFI OHV
Y	94-02	V8	396	6.5	Diesel OHV
Z	85-95	V6	262	4.3	TBI OHV
Z	00-01	L4	134	2.2	MPFI OHV
Z	02-03	V8	327	5.3	MPFI/FFV OHV
1	01-03	V8	403	6.6	Diesel OHV
4	94-00	L4	134	2.2	MPFI OHV
4	99-03	L4	152	2.5	MPFI DOHC
5	00-02	L4	134	2.2	MPFI OHV
6	96-03	L4	98	1.6	MPFI DOHC
9	83-84	V6	229	3.8	2BC OHV

CPI Center Port Injection
FFV Flex Fuel Vehicle
MPFI Multi-Port Fuel Injection
SFI Sequential Fuel Injection
TBI Throttle Body Injection

Domestic and Import Fuel Injection Systems

Illustrated below is a typical four cylinder fuel injection system and a typical V6 or V8 fuel injection system. Most fuel injection systems consist of the following:

- Throttle Body
- Throttle Body Gasket
- Plenum Chamber
- Plenum Chamber Gasket
- Intake Manifold
- Intake Manifold Gasket

There are some fuel injection systems that also have a center intake manifold gasket or have intake manifold tube gaskets. These are not illustrated

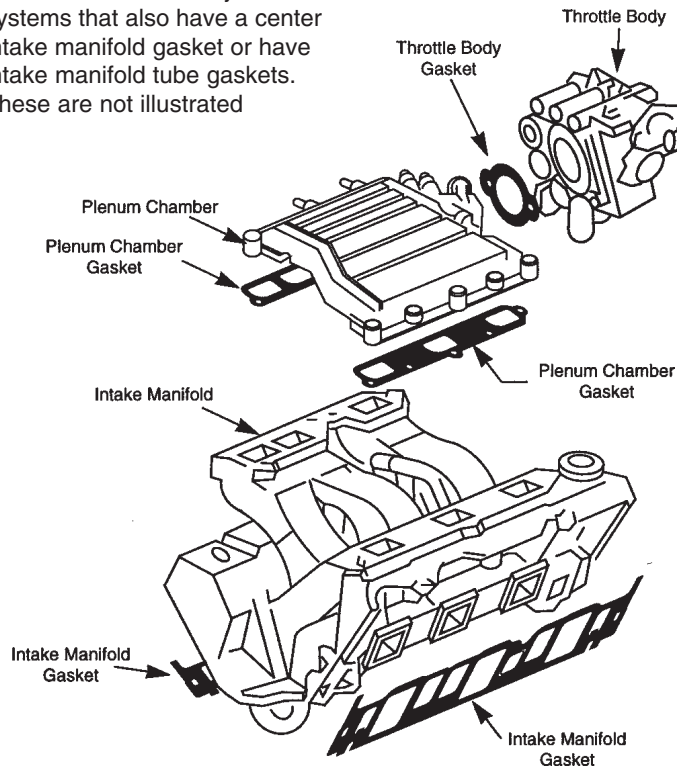

**Typical V6 / V8
E.F.I. System**

Typical 4 Cylinder E.F.I. System

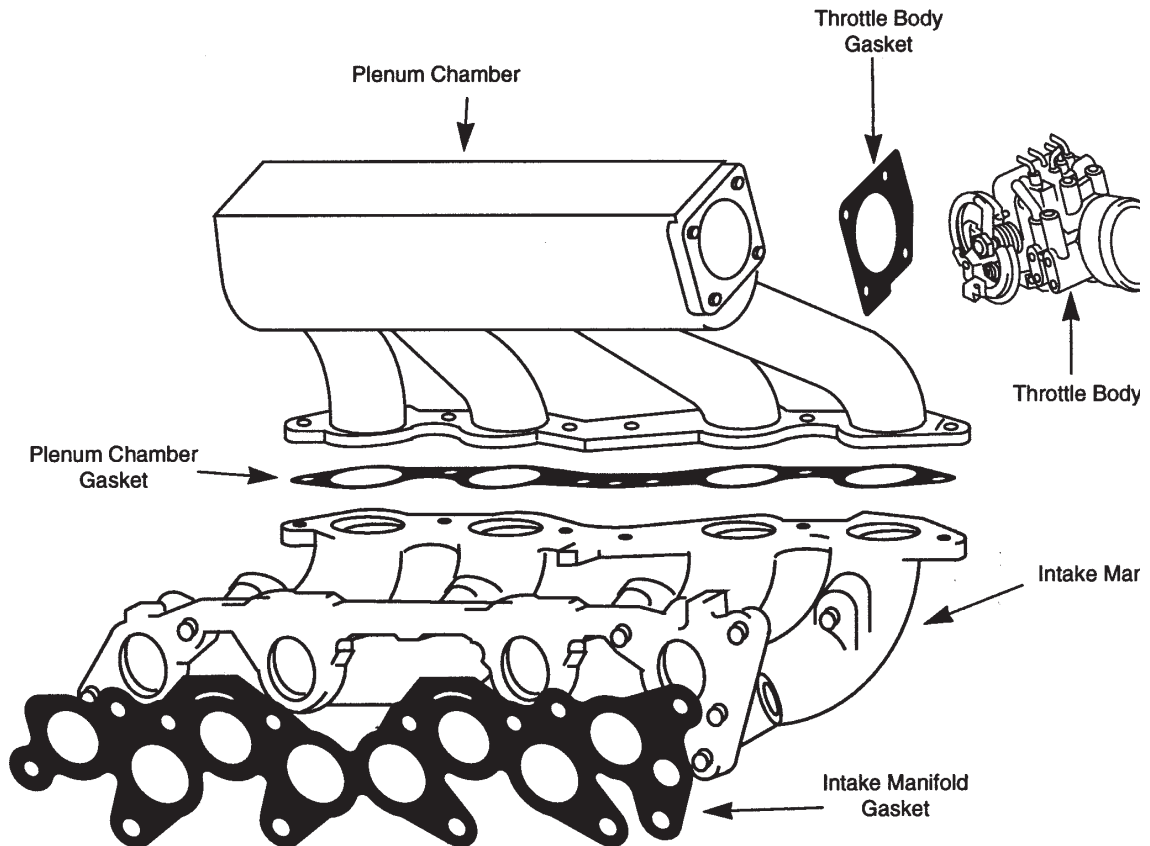

Performance Gaskets

Cylinder Head Gaskets

Nitroseal® by Victor Reinz® is a proven, performance cylinder head gasket. Nitroseal® performance cylinder head gaskets are composed of 100% graphite facing material combined with a perforated steel core and stainless steel combustion flanges. The graphite facing material can withstand the motion of the cylinder head and block and the heat often experienced in a performance engine. The graphite facing material also has a unique property referred to as “thermal conductivity.” That means the material actually transfers heat away from the heat source. One good example of this is the Small Block Chevrolet. The back-to-back exhaust valves on this engine tend to create a lot of heat, often resulting in a burnt gasket. The Nitroseal® performance cylinder head gasket allows the heat to move away from the hot spot to the coolant holes of the gasket, preventing gasket burnout.

Nitroseal® by Victor Reinz® is the perfect choice for a moderate, street performance engine, naturally aspirated and under a 12 to 1 compression ratio. For engines using a turbocharger, supercharger, or nitrous oxide, firing pressure within the combustion chamber is greatly increased. For these applications, look to Solicor® performance cylinder head gaskets for your cylinder head sealing needs.

Solicor® by Victor Reinz® is also a proven, performance cylinder head gasket. The technology that went into Solicor® performance cylinder head gaskets was initially for diesel applications where 20 to 1 and greater compression ratios are necessary. This technology has been applied to the Solicor® performance cylinder head gasket product offering. Solicor® performance cylinder head gaskets are composed of a high-density, non-asbestos facing material laminated to a solid steel core. This core provides radial strength for a wire ring encased in the stainless steel combustion flange. Solicor® performance cylinder head gaskets are coated with a unique fluorocarbon coating to ensure the microseal of fluids and to help resist the scrubbing action of the cylinder head.

Solicor® by Victor Reinz® is designed with the combustion seal in mind. For those applications where 12 to 1 or greater compression ratios are prevalent and for turbo-charged, supercharged, and nitrous oxide engines, Solicor® performance cylinder head gaskets are the gaskets that will perform for you.

Exhaust Header Gaskets

Nitroseal® by Victor Reinz® performance exhaust header gaskets are available for the most popular engine applications. The graphite facing material can withstand the motion of the cylinder head and exhaust header, as well as the heat. The graphite facing material also has a unique property referred to as “thermal conductivity.” That means the material actually transfers heat away from the heat source. Also, it is extremely conformable. Look to Nitroseal® by Victor Reinz® to seal your exhaust headers.

Performance Gaskets

Intake Manifold Gaskets

Two different materials are used for our intake manifold gaskets: Nitroseat graphite material and a premium, non-asbestos composition facing material which can be trimmed to fit. Each has special characteristics, as follows:

Nitroseat® by Victor Reinz® performance intake manifold gaskets are composed of 100% graphite facing material combined with a perforated steel core. The graphite facing material can withstand the motion of the cylinder head and intake manifold, as well as the heat often experienced in a performance engine. The graphite facing material also has a unique property referred to as “Thermal conductivity.” That means the material actually transfers heat away from the heat source. Also, it is extremely conformable.

Nitroseat® by Victor Reinz® performance intake manifold gaskets are available in all the popular port sizes, limiting the amount of trimming when matching ports. Many are available with blocked heat cross-overs for improved performance.

Victor Reinz® Gaskets also offers a premium, non-asbestos facing material for intake manifold applications. This line of intake manifold gaskets is designed for the engine builder and enthusiast who requires trim-to-fit intake manifold gaskets. Some include elastomeric beads to ensure a permanent seal.

Valve Cover and Oil Pan Gaskets

TuffCork® by Victor Reinz® is the premier material to use for valve cover and oil pan applications. It features excellent heat resistance - up to 400° F in the “H” Series, a steel core for excellent torque retention and easy installation, and excellent resistance to engine fluids.

TuffCork® by Victor Reinz® is composed of a cork facing on both sides of a steel core. TuffCork® prevents over-torquing and provides better torque retention than regular cork gaskets. The steel core provides the rigidity needed for easy installation, and prevents gasket blowout.

“**H**” **Series** valve cover gaskets are made using a higher temperature resistant, polyacrylic rubber binder and smaller cork granules. This design combines sustained temperature resistance to 400° F and a denser gasket with even more torque retention. These gaskets are available in various thicknesses for certain applications.

Custom Performance

1	Part	Year	VIN	Model/Application	Part Number	Qty.
ENGINE GASKETS						
	Valve Stem Seal, Int.			.311" Valve Stem Diameter, .500" Valve Guide Outside Diameter <i>Teflon</i>	B45888	8
DIFFERENTIAL HOUSING COVER GASKETS						
	Diff. Carrier Gasket			Ford Axle; 9" Ring Gear <i>Performaseal, 10-3/4" X 11-5/8'</i>	P27929VC	1

American Motors

Engine Index

Engine	Year	Block	Engine	Year	Block
290 CID (4.8L) American Motors Co.	1966-1969	1	360 CID (5.9L) American Motors Co.	1971-1991	2
304 CID (5.0L) American Motors Co.	1971-1981	2	390 CID (6.4L) American Motors Co.	1968-1969	1
343 CID (5.6L) American Motors Co.	1967-1969	1	401 CID (6.6L) American Motors Co.	1973-1978	2
1	290 CID (4.8L) American Motors Co. V8 Cyl, 3.750in./95.3mm (1966-1969)				1
	343 CID (5.6L) American Motors Co. V8 Cyl, 4.080in./103.6mm (1967-1969)				
	390 CID (6.4L) American Motors Co. V8 Cyl, 4.165in./105.8mm (1968-1969)				
Part	Year	VIN	Model/Application	Part Number	Qty.

ENGINE GASKETS						
	Ex Header Gskt			<i>Nitroseal</i>	95042SG	1
2	304 CID (5.0L) American Motors Co. V8 Cyl, 3.750in./95.3mm (1971-1981)				2	
	360 CID (5.9L) American Motors Co. V8 Cyl, 4.080in./103.6mm (1971-1991)					
	401 CID (6.6L) American Motors Co. V8 Cyl, 4.165in./105.8mm (1973-1978)					
Part	Year	VIN	Model/Application	Part Number	Qty.	

ENGINE GASKETS						
	Ex Header Gskt			<i>Nitroseal</i>	95144SG	1

Chrysler

Engine Index

Engine	Year	Block	Engine	Year	Block
122 CID (2.0L) 4G63 DOHC Mitsubishi	1989-1994	1	361 CID (5.9L)	1957-1966	7
122 CID (2.0L) 4G63T DOHC TURBO Mitsubishi	1990-1996	1	383 CID (6.3L)	1959-1971	8
R5-P7 Engine		2	400 CID (6.6L)	1972-1980	8
273 CID (4.5L)	1964-1969	3	413 CID (6.8L)	1959-1965	9
318 CID (5.2L) LA/Magnum	1967-1991	4	426 CID (7.0L) Hemispherical		10
340 CID (5.6L)	1968-1973	5	426 CID (7.0L) Wedge	1963-1965	11
360 CID (5.9L)	1971-1996	6	440 CID (7.2L)	1966-1980	12
			500 CID (8.2L) Pro Stock Big Block		13
1	122 CID (2.0L) 4G63 DOHC Mitsubishi 4 Cyl, 3.346in./85mm (1989-1994)				1
	122 CID (2.0L) 4G63T DOHC TURBO Mitsubishi 4 Cyl, 3.346in./85mm (1990-1996)				
Part	Year	VIN	Model/Application	Part Number	Qty.

ENGINE GASKETS						
	Cylinder Head Gasket			<i>Multi-Layered Steel, 85.5mm Combustion Chamber Opening, .054" Compressed Operating Thickness</i>	54315	1
2	R5-P7 Engine V8 Cyl, in./mm				2	
Part	Year	VIN	Model/Application	Part Number	Qty.	

ENGINE GASKETS						
	Cylinder Head Gasket			<i>Multi-Layered Steel, 9.0cc Combustion Chamber Volume, 4.210" Combustion Chamber Opening, .039" Compressed Operating Thickness</i>	54099	2
				<i>Multi-Layered Steel, 9.1cc Combustion Chamber Volume, 4.240" Combustion Chamber Opening, .039" Compressed Operating Thickness</i>	54159	2

PERFORMANCE

3 273 CID (4.5L) V8 Cyl, 3.625in./92.1mm (1964-1969) 3

Part	Year	VIN	Model/Application	Part Number	Qty.
ENGINE GASKETS					
Cylinder Head Gasket			Nitroseal, 9.4cc Combustion Chamber Volume, 4.090" Combustion Chamber Opening, .045" Compressed Operating Thickness	3536SG	2
			Solicor, 9.2cc Combustion Chamber Volume, 4.180" Combustion Chamber Opening, .042" Compressed Operating Thickness	5961SC	2
Valve Cover Set			High Temperature Cork Rubber	VS39569H	1
			Tuff-Cork	VS39569TC	1
Manifold Set, Intake	1966-1969		4 Barrel Cylinder Heads Nitroseal, 1.16" x 2.27" Ports	95102SG	1
			2 Barrel Cylinder Heads Nitroseal, 1.05" x 2.08" Ports	95142SG	1
Ex Header Gskt	1966-1969		Nitroseal, 1.90" x 4.40" Two Large Ports	95027SG	1
			Nitroseal, 1.14" x 1.59" Ports	95143SG	1
Timing Cover Gasket			Performaseal	T27787VC	1
Fuel Pump Gasket			Performaseal	D27094VC	1
Water Outlet Gasket	1966-1969		Performaseal	C25487VC	1
Water Pump Mount Gasket			Performaseal	K27556VC	1

4 318 CID (5.2L) LA/Magnum V8 Cyl, 3.910in./99.3mm (1967-1991) 4

Part	Year	VIN	Model/Application	Part Number	Qty.
ENGINE GASKETS					
Full Set	1967-1988		(Performer, Contains Nitroseal Head Gasket)	FS3536SG	1
Cylinder Head Gasket			Solicor, 9.2cc Combustion Chamber Volume, 4.180" Combustion Chamber Opening, .042" Compressed Operating Thickness	5961SC	2
			5 Bolt Valve Cover Nitroseal, 9.4cc Combustion Chamber Volume, 4.090" Combustion Chamber Opening, .045" Compressed Operating Thickness	3536SG	2
Valve Cover Set			High Temperature Cork Rubber	VS39569H	1
			Tuff-Cork	VS39569TC	1
Manifold Set, Intake	1967-1988		4 Barrel Cylinder Heads Nitroseal, 1.16" x 2.27" Ports	95102SG	1
			2 Barrel Cylinder Heads Nitroseal, 1.05" x 2.08" Ports	95142SG	1
Ex Header Gskt	1975-1991		Nitroseal, 1.25" x 1.75" Ports	95095SG	1
			Nitroseal, 1.90" x 4.40" Two Large Ports	95027SG	1
	1967-1974		Nitroseal, 1.14" x 1.59" Ports	95143SG	1
Oil Pan Set	1970-1991		Tuff-Cork	OS30520YTC	1
Timing Cover Gasket			Performaseal	T27787VC	1
Fuel Pump Gasket	1967-1987		Performaseal	D27094VC	1
Water Outlet Gasket	1967-1974		Performaseal	C25487VC	1
Water Pump Mount Gasket			Clockwise Rotation Water Pumps Performaseal	K27556VC	1

5 340 CID (5.6L) V8 Cyl, 4.040in./102.6mm (1968-1973) 5

Part	Year	VIN	Model/Application	Part Number	Qty.
ENGINE GASKETS					
Cylinder Head Gasket			Nitroseal, 9.4cc Combustion Chamber Volume, 4.090" Combustion Chamber Opening, .045" Compressed Operating Thickness	3536SG	2
			Solicor, 9.2cc Combustion Chamber Volume, 4.180" Combustion Chamber Opening, .042" Compressed Operating Thickness	5961SC	2
			Multi-Layered Steel, 4.060" Combustion Chamber Opening, .040" Compressed Operating Thickness	54274	2
			Multi-Layered Steel, 4.125" Combustion Chamber Opening, .040" Compressed Operating Thickness	54275	2
			Multi-Layered Steel, 4.180" Combustion Chamber Opening, .040" Compressed Operating Thickness	54276	2
Valve Cover Set			High Temperature Cork Rubber	VS39569H	1
			Tuff-Cork	VS39569TC	1

Chrysler

5 (cont.)	340 CID (5.6L) V8 Cyl, 4.040in./102.6mm (1968-1973)				5 (cont.)
---------------------	--	--	--	--	---------------------

Part	Year	VIN	Model/Application	Part Number	Qty.
ENGINE GASKETS (cont.)					
Manifold Set, Intake			Nitroseal, 1.16" x 2.27" Ports	95102SG	1
Ex Header Gskt			Nitroseal, 1.90" x 4.40" Two Large Ports	95027SG	1
			Nitroseal, 1.25" x 1.75" Ports	95095SG	1
Oil Pan Set	1970-1973		Tuff-Cork	OS30520YTC	1
Timing Cover Gasket			Performaseal	T27787VC	1
Fuel Pump Gasket			Performaseal	D27094VC	1
Water Outlet Gasket			Performaseal	C25487VC	1
Water Pump Mount Gasket			Performaseal	K27556VC	1

6	360 CID (5.9L) V8 Cyl, 4.000in./101.6mm (1971-1996)				6
----------	--	--	--	--	----------

Part	Year	VIN	Model/Application	Part Number	Qty.
ENGINE GASKETS					
Cylinder Head Gasket	1971-1991		Nitroseal, 9.4cc Combustion Chamber Volume, 4.090" Combustion Chamber Opening, .045" Compressed Operating Thickness	3536SG	2
			Solicor, 9.2cc Combustion Chamber Volume, 4.180" Combustion Chamber Opening, .042" Compressed Operating Thickness	5961SC	2
			Multi-Layered Steel, 4.060" Combustion Chamber Opening, .040" Compressed Operating Thickness	54274	2
			Multi-Layered Steel, 4.125" Combustion Chamber Opening, .040" Compressed Operating Thickness	54275	2
			Multi-Layered Steel, 4.180" Combustion Chamber Opening, .040" Compressed Operating Thickness	54276	2
Valve Cover Set	1971-1991		High Temperature Cork Rubber	VS39569H	1
			Tuff-Cork	VS39569TC	1
Manifold Set, Intake	1971-1988		Nitroseal, 1.16" x 2.27" Ports	95102SG	1
Ex Header Gskt	1971-1992		Nitroseal, 1.90" x 4.40" Two Large Ports	95027SG	1
			Nitroseal, 1.25" x 1.75" Ports	95095SG	1
Oil Pan Set	1992-1996		Victo-Tech	OS32115	1
	1971-1991		Tuff-Cork	OS30520ZTC	1
Timing Cover Gasket	1971-1991		Performaseal	T27787VC	1
Fuel Pump Gasket	1971-1987		Performaseal	D27094VC	1
Water Outlet Gasket	1971-1974		Performaseal	C25487VC	1
Water Pump Mount Gasket	1971-1991		Performaseal	K27556VC	1

7	361 CID (5.9L) V8 Cyl, 4.125in./104.8mm (1957-1966)				7
----------	--	--	--	--	----------

Part	Year	VIN	Model/Application	Part Number	Qty.
ENGINE GASKETS					
Cylinder Head Gasket			Nitroseal, 11.1cc Combustion Chamber Volume, 4.430" Combustion Chamber Opening, .045" Compressed Operating Thickness	3464SG	2
			Multi-Layered Steel, 4.250" Combustion Chamber Opening, .040" Compressed Operating Thickness	54277	2
			Multi-Layered Steel, 4.350" Combustion Chamber Opening, .040" Compressed Operating Thickness	54278	2
			Multi-Layered Steel, 4.380" Combustion Chamber Opening, .040" Compressed Operating Thickness	54279	2
			Multi-Layered Steel, 4.410" Combustion Chamber Opening, .040" Compressed Operating Thickness	54280	2
Valve Cover Set	1964-1966		High Temperature Cork Rubber	VS38322H	1
Manifold Set, Intake	1959-1966		Use With Part Number MS15924 1.23" x 2.27" Ports	95011SP	1
Ex Header Gskt			Nitroseal, 1.43" x 1.75" Ports	95026SG	1
Oil Pan Set			(Requires 2 Sets For Use With Windage Tray) Tuff-Cork	OS31416TC	1
Timing Cover Gasket			Performaseal	T18750VC	1
Fuel Pump Gasket			Performaseal	D27094VC	1

PERFORMANCE

7 (cont.)	361 CID (5.9L) V8 Cyl, 4.125in./104.8mm (1957-1966)					7 (cont.)
---------------------	--	--	--	--	--	---------------------

Part	Year	VIN	Model/Application	Part Number	Qty.
------	------	-----	-------------------	-------------	------

ENGINE GASKETS (cont.)

Water Outlet Gasket			Performaseal	C25487VC	1
Water Pump Mount Gasket	1959-1966		Performaseal	K27080VC	1

8	383 CID (6.3L) V8 Cyl, 4.250in./108mm (1959-1971)					8
	400 CID (6.6L) V8 Cyl, 4.342in./110.3mm (1972-1980)					

Part	Year	VIN	Model/Application	Part Number	Qty.
------	------	-----	-------------------	-------------	------

ENGINE GASKETS

Cylinder Head Gasket			Nitroseal, 11.1cc Combustion Chamber Volume, 4.430" Combustion Chamber Opening, .045" Compressed Operating Thickness	3464SG	2
			Multi-Layered Steel, 4.250" Combustion Chamber Opening, .040" Compressed Operating Thickness	54277	2
			Multi-Layered Steel, 4.350" Combustion Chamber Opening, .040" Compressed Operating Thickness	54278	2
			Multi-Layered Steel, 4.380" Combustion Chamber Opening, .040" Compressed Operating Thickness	54279	2
			Multi-Layered Steel, 4.410" Combustion Chamber Opening, .040" Compressed Operating Thickness	54280	2
Valve Cover Set	1964-1980		High Temperature Cork Rubber	VS38322H	1
Manifold Set, Intake			Engines With B-1 Heads Nitroseal, 1.65" x 2.71" Ports	95164SG	1
			Engines With B-1 Heads Composition, 1.65" x 2.71" Ports	95164SP	1
			Use With Part Number MS15924 1.23" x 2.27" Ports	95011SP	1
Ex Header Gskt			Nitroseal, 1.43" x 1.75" Ports	95026SG	1
Oil Pan Set			(Requires 2 Sets For Use With Windage Tray) Tuff-Cork	OS31416TC	1
Timing Cover Gasket			Performaseal	T18750VC	1
Fuel Pump Gasket			Performaseal	D27094VC	1
Water Outlet Gasket	1959-1974		Performaseal	C25487VC	1
Water Pump Mount Gasket			Performaseal	K27080VC	1

9	413 CID (6.8L) V8 Cyl, 4.188in./106.4mm (1959-1965)					9
----------	--	--	--	--	--	----------

Part	Year	VIN	Model/Application	Part Number	Qty.
------	------	-----	-------------------	-------------	------

ENGINE GASKETS

Cylinder Head Gasket			Multi-Layered Steel, 4.250" Combustion Chamber Opening, .040" Compressed Operating Thickness	54277	2
			Multi-Layered Steel, 4.350" Combustion Chamber Opening, .040" Compressed Operating Thickness	54278	2
			Multi-Layered Steel, 4.380" Combustion Chamber Opening, .040" Compressed Operating Thickness	54279	2
			Multi-Layered Steel, 4.410" Combustion Chamber Opening, .040" Compressed Operating Thickness	54280	2
Manifold Set, Intake			Blocked Heat Crossover, Open Heat Crossover, Use With Part Numbers MS15914, MS15916B 1.23" x 2.27" Ports	95011SP	1
Ex Header Gskt			Nitroseal, 1.43" x 1.75" Ports	95026SG	1
Oil Pan Set			(Requires 2 Sets For Use With Windage Tray) Tuff-Cork	OS31416TC	1
Timing Cover Gasket			Performaseal	T18750VC	1
Fuel Pump Gasket			Performaseal	D27094VC	1
Water Outlet Gasket			Performaseal	C25487VC	1
Water Pump Mount Gasket			Performaseal	K27080VC	1

Chrysler

10 426 CID (7.0L) Hemispherical V8 Cyl, 4.250in./108mm 10

Part	Year	VIN	Model/Application	Part Number	Qty.
ENGINE GASKETS					
Cylinder Head Gasket			4.250" Bore, From 1966 Multi-Layered Steel, 4.310" Combustion Chamber Opening, .040" Compressed Operating Thickness	54281	2
			4.280" Bore, From 1966 Multi-Layered Steel, 4.340" Combustion Chamber Opening, .040" Compressed Operating Thickness	54282	2
			4.310" Bore, From 1966 Multi-Layered Steel, 4.370" Combustion Chamber Opening, .040" Compressed Operating Thickness	54283	2
			4.375" Bore, Cast Iron Block Multi-Layered Steel, 4.435" Combustion Chamber Opening, .040" Compressed Operating Thickness	54284	2
			4.500" Bore , Mopar Cast Iron Performance Block P5249804 And P4529850 Multi-Layered Steel, 4.560" Combustion Chamber Opening, .040" Compressed Operating Thickness	54285	2
			Mopar Cast Iron Siamese Cylinders Performance Block P5249345 Multi-Layered Steel, 4.500" Combustion Chamber Opening, .054" Compressed Operating Thickness	54286	2

11 426 CID (7.0L) Wedge V8 Cyl, 4.250in./108mm (1963-1965) 11

Part	Year	VIN	Model/Application	Part Number	Qty.
ENGINE GASKETS					
Cylinder Head Gasket			Nitroseal, 11.1cc Combustion Chamber Volume, 4.430" Combustion Chamber Opening, .045" Compressed Operating Thickness	3464SG	2
			Multi-Layered Steel, 4.250" Combustion Chamber Opening, .040" Compressed Operating Thickness	54277	2
			Multi-Layered Steel, 4.350" Combustion Chamber Opening, .040" Compressed Operating Thickness	54278	2
			Multi-Layered Steel, 4.380" Combustion Chamber Opening, .040" Compressed Operating Thickness	54279	2
			Multi-Layered Steel, 4.410" Combustion Chamber Opening, .040" Compressed Operating Thickness	54280	2
Valve Cover Set	1964-1965		High Temperature Cork Rubber	VS38322H	1
Manifold Set, Intake			Blocked Heat Crossover, Open Heat Crossover, Use With Part Numbers MS15914, MS15916B 1.23" x 2.27" Ports	95011SP	1
			Nitroseal, 1.34" x 2.63" Ports	95155SG	1
			Composition, 1.34" x 2.63" Ports	95155SP	1
Ex Header Gskt			Nitroseal, 1.43" x 1.75" Ports	95026SG	1
Oil Pan Set			(Requires 2 Sets For Use With Windage Tray) Tuff-Cork	OS31416TC	1
Timing Cover Gasket			Performaseal	T18750VC	1
Fuel Pump Gasket			Performaseal	D27094VC	1
Water Outlet Gasket			Performaseal	C25487VC	1
Water Pump Mount Gasket			Performaseal	K27080VC	1

12 440 CID (7.2L) V8 Cyl, 4.320in./109.7mm (1966-1980) 12

Part	Year	VIN	Model/Application	Part Number	Qty.
ENGINE GASKETS					
Cylinder Head Gasket			Nitroseal, 11.1cc Combustion Chamber Volume, 4.430" Combustion Chamber Opening, .045" Compressed Operating Thickness	3464SG	2
			Multi-Layered Steel, 4.410" Combustion Chamber Opening, .040" Compressed Operating Thickness	54280	2
			Mopar Cast Iron Siamese Cylinders Performance Block P4876169 Multi-Layered Steel, 4.500" Combustion Chamber Opening, .040" Compressed Operating Thickness	54287	2
Valve Cover Set			High Temperature Cork Rubber	VS38322H	1

12 440 CID (7.2L) V8 Cyl, 4.320in./109.7mm (1966-1980) **12**
(cont.) (cont.)

Part	Year	VIN	Model/Application	Part Number	Qty.
ENGINE GASKETS (cont.)					
Manifold Set, Intake			Blocked Heat Crossover, Open Heat Crossover, Use With Part Numbers MS15914, MS15916B 1.23" x 2.27" Ports	95011SP	1
			Engines With B-1 Heads Nitroseal, 1.65" x 2.71" Ports	95164SG	1
			Engines With B-1 Heads Composition, 1.65" x 2.71" Ports	95164SP	1
Ex Header Gskt			Nitroseal, 1.43" x 1.75" Ports	95026SG	1
Oil Pan Set			(Requires 2 Sets For Use With Windage Tray) Tuff-Cork	OS31416TC	1
Timing Cover Gasket			Performaseal	T18750VC	1
Fuel Pump Gasket			Performaseal	D27094VC	1
Water Outlet Gasket	1966-1974		Performaseal	C25487VC	1
Water Pump Mount Gasket			Performaseal	K27080VC	1

13 500 CID (8.2L) Pro Stock Big Block V8 Cyl, in./mm **13**

Part	Year	VIN	Model/Application	Part Number	Qty.
ENGINE GASKETS					
Cylinder Head Gasket			B1 "TS" Solicor, 13.9cc Combustion Chamber Volume, 4.620" Combustion Chamber Opening, .051" Compressed Operating Thickness	5972SC	2
			4.900" Bore Center, Mopar Performance Block P4876887 Multi-Layered Steel, 4.700" Combustion Chamber Opening, .054" Compressed Operating Thickness	54288	2
			4.900" Bore Center, Mopar Performance Block P4876887 Multi-Layered Steel, 4.730" Combustion Chamber Opening, .054" Compressed Operating Thickness	54289	2
Valve Cover Set			B1 "TS" High Temperature Cork Rubber	VS50195HTC	1
Manifold Set, Intake			B1 "TS", (No Bolt Holes Or Ports (Universal Trim To Fit)) Composition, 1/16" Thick	95168SP	1
Ex Header Gskt			B1 "TS" Nitroseal, 2.30" Round Ports	95180SG	1
Oil Pan Set			B1 "TS" Tuff-Cork	OS32130TC	1

Ford

Engine Index

Engine	Year	Block	Engine	Year	Block
140 CID (2.3L) SOHC	1974-1988	1	351 CID (5.8L) 351C SVO Ford Cleveland		14
240 CID (4.0L)	1965-1974	2	351 CID (5.8L) 351M	1975-1982	15
4.5 SVO		3	351 CID (5.8L) 351W Ford Windsor	1969-1997	16
300 CID (4.9L)	1965-1997	2	352 CID (5.8L)	1958-1967	17
351W SVO Ford Windsor		4	390 CID (6.4L)	1961-1971	18
221 CID (3.6L)	1962-1963	5	400 CID (6.6L) OHV	1971-1982	15
260 CID (4.3L)	1962-1965	6	406 CID (6.7L)	1962-1964	19
281 CID (4.6L) DOHC Ford	1993-2002	7	427 CID (7.0L)	1963-1968	18
281 CID (4.6L) SOHC	1991-2003	7	428 CID (7.0L) Cobra Jet	1966-1970	20
289 CID (4.7L)	1963-1968	8	428 CID (7.0L) Super Cobra Jet	1969-1970	20
302 CID (5.0L)	1968-1997	9	428 CID (7.0L) Thunderbird	1966-1968	18
302 CID (5.0L) Boss	1969-1971	10	429 CID (7.0L)	1968-1973	21
302 CID (5.0L) SVO		11	460 CID (7.5L)	1968-1995	22
332 CID (5.4L)	1958-1959	12	500 CID (8.2L) Pro Stock Big Block		23
351 CID (5.8L) 351C Ford Cleveland	1970-1974	13			

1 140 CID (2.3L) SOHC 4 Cyl, 3.780in./96mm (1974-1988) **1**

Part	Year	VIN	Model/Application	Part Number	Qty.
ENGINE GASKETS					
Cylinder Head Gasket			Nitroseal, 8.5cc Combustion Chamber Volume, 3.870" Combustion Chamber Opening, .045" Compressed Operating Thickness	4029SG	1
			Multi-Layered Steel, 3.819" Combustion Chamber Opening, .040" Compressed Operating Thickness	54302	1
Valve Cover Set			High Temperature Cork Rubber	VS39751H	1
Manifold Set, Intake	1974-1984		1.81" Round Center Ports And 1.81" x 2.32" Oval End Ports	95122P	1

Ford

1 (cont.)	140 CID (2.3L) SOHC 4 Cyl, 3.780in./96mm (1974-1988)					1 (cont.)
---------------------	---	--	--	--	--	---------------------

Part	Year	VIN	Model/Application	Part Number	Qty.
------	------	-----	-------------------	-------------	------

ENGINE GASKETS (cont.)

Ex Header Gskt			Nitroseal, 1.43" Round Ports	95119SG	1
Oil Pan Set	1974-1986		Thru 2/19/86 Tuff-Cork	OS30546TC	1
Fuel Pump Gasket			Performaseal	D27094VC	1

2	240 CID (4.0L) 6 Cyl, 4.000in./101.6mm (1965-1974) 300 CID (4.9L) 6 Cyl, 4.000in./101.6mm (1965-1997)					2
----------	--	--	--	--	--	----------

Part	Year	VIN	Model/Application	Part Number	Qty.
------	------	-----	-------------------	-------------	------

ENGINE GASKETS

Cylinder Head Gasket			Nitroseal, 9.7cc Combustion Chamber Volume, 4.140" Combustion Chamber Opening, .045" Compressed Operating Thickness	5821SG	1
Valve Cover Set	1968-1997		Tuff-Cork	VS39747TC	1
Manifold Set, Intake	1968-1988		Nitroseal, 1.52" x 1.72" Ports	95135SG	1
Ex Header Gskt	1965-1988		Nitroseal, 1.35" x 1.67" Ports	95136SG	1
Timing Cover Gasket			Performaseal	T27118VC	1
Fuel Pump Gasket	1965-1988		Performaseal	D27094VC	1
Water Outlet Gasket	1965-1984		Performaseal	C24005VC	1
Water Pump Mount Gasket			Performaseal	K27113VC	1

3	4.5 SVO V6 Cyl, 4.080in./103.6mm					3
----------	---	--	--	--	--	----------

Part	Year	VIN	Model/Application	Part Number	Qty.
------	------	-----	-------------------	-------------	------

ENGINE GASKETS

Cylinder Head Gasket			Solicor, 9.1cc Combustion Chamber Volume, 4.170" Combustion Chamber Opening, .042" Compressed Operating Thickness	5953SC	2
Valve Cover Set			High Temperature Tuff-Cork	VS50190HTC	1
Manifold Set, Intake		"J" Head	Composition, 1.45" x 2.27" Ports	95156SP	1
		"H" Head	Nitroseal, 1.40" x 2.20" Ports	95171SG	1
		"H" Head	Composition, 1.40" x 2.20" Ports	95171SP	1
Oil Pan Set			Tuff-Cork	OS32124TC	1

4	351W SVO Ford Windsor V8 Cyl, in./mm					4
----------	---	--	--	--	--	----------

Part	Year	VIN	Model/Application	Part Number	Qty.
------	------	-----	-------------------	-------------	------

ENGINE GASKETS

Cylinder Head Gasket			Except Large Overbore VR2000, 8.8cc Combustion Chamber Volume, 4.100" Combustion Chamber Opening, .042" Compressed Operating Thickness	3446	2
			Large Overbore, Left Solicor, 9.6cc Combustion Chamber Volume, 4.160" Combustion Chamber Opening, .042" Compressed Operating Thickness	5947SC	1
			Large Overbore, Right Solicor, 9.6cc Combustion Chamber Volume, 4.160" Combustion Chamber Opening, .042" Compressed Operating Thickness	5948SC	1
			Solicor, 11.6cc Combustion Chamber Volume, 4.210" Combustion Chamber Opening, .051" Compressed Operating Thickness	54121SCR	2
			Cylindrical Combustion Chamber Multi-Layered Steel, 4.080" Combustion Chamber Opening, .040" Compressed Operating Thickness	54238	2
			Cylindrical Combustion Chamber Multi-Layered Steel, 4.100" Combustion Chamber Opening, .040" Compressed Operating Thickness	54295	2
			Cylindrical Combustion Chamber Multi-Layered Steel, 4.125" Combustion Chamber Opening, .040" Compressed Operating Thickness	54296	2

4 351W SVO Ford Windsor V8 Cyl, in./mm **4**
(cont.) (cont.)

Part	Year	VIN	Model/Application	Part Number	Qty.
ENGINE GASKETS (cont.)					
Cylinder Head Gasket (cont.)			Cylindrical Combustion Chamber Multi-Layered Steel, 4.155" Combustion Chamber Opening, .040" Compressed Operating Thickness	54297	2
			Cylindrical Combustion Chamber Multi-Layered Steel, 4.180" Combustion Chamber Opening, .040" Compressed Operating Thickness	54298	2
			Cylindrical Combustion Chamber Multi-Layered Steel, 4.200" Combustion Chamber Opening, .040" Compressed Operating Thickness	54299	2
Valve Cover Set			High Temperature Cork Rubber	VS38422H	1
			Tuff-Cork	VS50069TC	1
Stabilizer Cover			Tuff-Cork	VS38160TC	1
Manifold Set, Intake			Cylinder Head M6049 A3 Nitroseat, 1.83" x 2.20" Ports	95137SG	1
			Cylinder Head M6049 B351, M3049 C302, M6049 D302 Nitroseat, 1.35" x 2.20" Ports	95139SG	1
			Ford SVO Yates Cylinder Head Number M6049-C3 1/32" Thick	95202-1SP	1
			Ford SVO Yates Cylinder Head Number M6049-C3 1/16" Thick	95202-3SP	1
			Ford SVO Yates Cylinder Head Number M6049-C3 3/32" Thick	95202-4SP	1
			Ford SVO Yates Cylinder Head Number M6049-C3 1/8" Thick	95202-5SP	1
Ex Header Gskt			Cylinder Head M6049 A3 Nitroseat, 1.94" Round Ports	95140SG	1
			Cylinder Head M6049 B351, M3049 C302, M6049 D302 Nitroseat, 1.81" Round Ports	95141SG	1
Oil Pan Set			Tuff-Cork	OS30541TC	1
			(Notched For Main Cap And Trimmed For Stokers) Tuff-Cork	OS32129TC	1
			Victo-Tech	OS32492	1
Timing Cover Gasket			Performaseal	T27802VC	1
Fuel Pump Gasket			Performaseal	D27094VC	1
Water Pump Gasket			Performaseal	C24005VC	1
Water Pump Mount Gasket			Performaseal	K27955VC	1
Water Pump Backing Plate			Performaseal	K27151VC	1

5 221 CID (3.6L) V8 Cyl, 3.500in./88.9mm (1962-1963) **5**

Part	Year	VIN	Model/Application	Part Number	Qty.
ENGINE GASKETS					
Manifold Set, Intake			Nitroseat	95010SG	1
Ex Header Gskt			Square Ports Nitroseat	95025SG	1
			Round Ports Nitroseat	95066SG	1

6 260 CID (4.3L) V8 Cyl, 3.800in./96.5mm (1962-1965) **6**

Part	Year	VIN	Model/Application	Part Number	Qty.
ENGINE GASKETS					
Cylinder Head Gasket			Solicor, 8.8cc Combustion Chamber Volume, 4.080" Combustion Chamber Opening, .042" Compressed Operating Thickness	3428SCR	2
			Nitroseat, 9.4cc Combustion Chamber Volume, 4.080" Combustion Chamber Opening, .045" Compressed Operating Thickness	3428SG	2
			Solicor, 9.0cc Combustion Chamber Volume, 4.100" Combustion Chamber Opening, .042" Compressed Operating Thickness	5956SC	2
Valve Cover Set			High Temperature Cork Rubber	VS38300H	1
			High Temperature Tuff-Cork	VS38300HTC	1

Ford

6 (cont.)	260 CID (4.3L) V8 Cyl, 3.800in./96.5mm (1962-1965)				6 (cont.)
---------------------	---	--	--	--	---------------------

Part	Year	VIN	Model/Application	Part Number	Qty.
------	------	-----	-------------------	-------------	------

ENGINE GASKETS (cont.)

Manifold Set, Intake			Small Rectangular Coolant Ports <i>Nitroseal, 1.28" X 2.10" Ports</i>	95010SG	1
			Large Coolant Ports, Small Race, (Trim To Fit) <i>Nitroseal, 1.20" x 2.00" Ports</i>	95186SG	1
			Large Coolant Ports, Small Race, (Trim To Fit) <i>Composition, 1.20" x 2.00" Ports</i>	95186SP	1
			Small Coolant Ports, Small Race, (Trim To Fit) <i>Nitroseal, 1.20" x 2.00" Ports</i>	95187SG	1
			Small Coolant Ports, Small Race, (Trim To Fit) <i>Composition, 1.20" x 2.00" Ports</i>	95187SP	1
			Large Race, Small Coolant Ports, (Trim To Fit) <i>Nitroseal, 1.28" X 2.10" Ports</i>	95197SG	1
			Large Race, Small Coolant Ports, (Trim To Fit) <i>Composition, 1.28" X 2.10" Ports</i>	95197SP	1
			Large Coolant Ports, Large Race, (Trim To Fit) <i>Composition, 1.28" X 2.10" Ports</i>	95198SP	1
Ex Header Gskt			<i>Nitroseal, 1.13" x 1.53" Ports</i>	95025SG	1
			<i>Nitroseal, 1.41" Round Ports</i>	95066SG	1
			(Dual Bolt Pattern. Stock Ford Inline) <i>Nitroseal, 1.40" x 1.40" Ports</i>	95176SG	1
			(Dual Inline Bolt Patterns. Stock Bolt Pattern) <i>Nitroseal, 1.42" x 1.62" Ports</i>	95177SG	1
Oil Pan Set			<i>Tuff-Cork</i>	OS30531TC	1
			<i>Victo-Tech</i>	OS32491	1
Timing Cover Gasket			<i>Performaseal</i>	T27802VC	1
Fuel Pump Gasket			<i>Performaseal</i>	D27094VC	1
Water Outlet Gasket			<i>Performaseal</i>	C24005VC	1
Water Pump Mount Gasket			<i>Performaseal</i>	K27955VC	1

7	281 CID (4.6L) DOHC Ford V8 Cyl, 3.551in./90.2mm (1993-2002)				7
	281 CID (4.6L) SOHC V8 Cyl, 3.551in./90.2mm (1991-2003)				

Part	Year	VIN	Model/Application	Part Number	Qty.
------	------	-----	-------------------	-------------	------

ENGINE GASKETS

Cylinder Head Gasket			Left <i>Multi-Layered Steel, 94mm Combustion Chamber Opening, .030" Compressed Operating Thickness</i>	54300	2
			Right <i>Multi-Layered Steel, 94mm Combustion Chamber Opening, .030" Compressed Operating Thickness</i>	54301	2

8	289 CID (4.7L) V8 Cyl, 4.000in./101.6mm (1963-1968)				8
----------	--	--	--	--	----------

Part	Year	VIN	Model/Application	Part Number	Qty.
------	------	-----	-------------------	-------------	------

ENGINE GASKETS

Cylinder Head Gasket			<i>Solicor, 8.8cc Combustion Chamber Volume, 4.080" Combustion Chamber Opening, .042" Compressed Operating Thickness</i>	3428SCR	2
			<i>Nitroseal, 9.4cc Combustion Chamber Volume, 4.080" Combustion Chamber Opening, .045" Compressed Operating Thickness</i>	3428SG	2
			<i>Solicor, 9.0cc Combustion Chamber Volume, 4.100" Combustion Chamber Opening, .042" Compressed Operating Thickness</i>	5956SC	2
			<i>Multi-Layered Steel, 4.200" Combustion Chamber Opening, .040" Compressed Operating Thickness</i>	54187	2
			<i>Multi-Layered Steel, 4.030" Combustion Chamber Opening, .040" Compressed Operating Thickness</i>	54290	2
			<i>Multi-Layered Steel, 4.080" Combustion Chamber Opening, .040" Compressed Operating Thickness</i>	54291	2

8 (cont.)	289 CID (4.7L) V8 Cyl, 4.000in./101.6mm (1963-1968)				8 (cont.)
---------------------	--	--	--	--	---------------------

Part	Year	VIN	Model/Application	Part Number	Qty.
ENGINE GASKETS (cont.)					
Cylinder Head Gasket (cont.)			Multi-Layered Steel, 4.100" Combustion Chamber Opening, .040" Compressed Operating Thickness	54292	2
			Multi-Layered Steel, 4.155" Combustion Chamber Opening, .040" Compressed Operating Thickness	54293	2
Valve Cover Set			High Temperature Cork Rubber	VS38300H	1
			High Temperature Tuff-Cork	VS38300HTC	1
Manifold Set, Intake	1968		"L" Shaped Coolant Ports Nitroseal, 1.28" X 2.10" Ports	95103SG	1
			Small Rectangular Coolant Ports Nitroseal, 1.28" X 2.10" Ports	95010SG	1
			Large Coolant Ports, Small Race, (Trim To Fit) Nitroseal, 1.20" x 2.00" Ports	95186SG	1
			Large Coolant Ports, Small Race, (Trim To Fit) Composition, 1.20" x 2.00" Ports	95186SP	1
			Small Coolant Ports, Small Race, (Trim To Fit) Nitroseal, 1.20" x 2.00" Ports	95187SG	1
			Small Coolant Ports, Small Race, (Trim To Fit) Composition, 1.20" x 2.00" Ports	95187SP	1
			Large Race, Small Coolant Ports, (Trim To Fit) Nitroseal, 1.28" X 2.10" Ports	95197SG	1
			Large Race, Small Coolant Ports, (Trim To Fit) Composition, 1.28" X 2.10" Ports	95197SP	1
			Large Coolant Ports, Large Race, (Trim To Fit) Composition, 1.28" X 2.10" Ports	95198SP	1
				Nitroseal, 1.13" x 1.53" Ports	95025SG
Ex Header Gskt			Nitroseal, 1.41" Round Ports	95066SG	1
			(Dual Bolt Pattern. Stock Ford Inline) Nitroseal, 1.40" x 1.40" Ports	95176SG	1
			(Dual Inline Bolt Patterns. Stock Bolt Pattern) Nitroseal, 1.42" x 1.62" Ports	95177SG	1
			Tuff-Cork	OS30531TC	1
Oil Pan Set			Victo-Tech	OS32491	1
			Performaseal	T27802VC	1
Fuel Pump Gasket			Performaseal	D27094VC	1
Water Outlet Gasket			Performaseal	C24005VC	1
Water Pump Mount Gasket			Performaseal	K27955VC	1
Water Pump Backing Plate			Performaseal	K27142VC	1

9	302 CID (5.0L) V8 Cyl, 4.000in./101.6mm (1968-1997)				9
----------	--	--	--	--	----------

Part	Year	VIN	Model/Application	Part Number	Qty.	
ENGINE GASKETS						
Full Set			Except Boss, (Performer, Contains Nitroseal Head Gasket)	FS3530SG	1	
Cylinder Head Gasket			Except Boss Solicor, 8.8cc Combustion Chamber Volume, 4.080" Combustion Chamber Opening, .042" Compressed Operating Thickness	3428SCR	2	
			Except Boss Nitroseal, 9.4cc Combustion Chamber Volume, 4.080" Combustion Chamber Opening, .045" Compressed Operating Thickness	3428SG	2	
			Except Boss Solicor, 9.0cc Combustion Chamber Volume, 4.100" Combustion Chamber Opening, .042" Compressed Operating Thickness	5956SC	2	
	1968-1995			Multi-Layered Steel, 4.200" Combustion Chamber Opening, .040" Compressed Operating Thickness	54187	2
				Multi-Layered Steel, 4.030" Combustion Chamber Opening, .040" Compressed Operating Thickness	54290	2
				Multi-Layered Steel, 4.080" Combustion Chamber Opening, .040" Compressed Operating Thickness	54291	2

Ford

9 302 CID (5.0L) V8 Cyl, 4.000in./101.6mm (1968-1997) **9**
 (cont.) (cont.)

Part Year VIN Model/Application Part Number Qty.

ENGINE GASKETS (cont.)

Cylinder Head Gasket (cont.)	1968-1995		Multi-Layered Steel, 4.100" Combustion Chamber Opening, .040" Compressed Operating Thickness	54292	2
			Multi-Layered Steel, 4.155" Combustion Chamber Opening, .040" Compressed Operating Thickness	54293	2
Valve Cover Set			Except Boss High Temperature Cork Rubber	VS38300H	1
			Except Boss High Temperature Tuff-Cork	VS38300HTC	1
Manifold Set, Intake			Except Boss, Large Square Coolant Ports Nitroseal, 1.28" X 2.10" Ports	95107SG	1
			Large Coolant Ports, Except Boss, Small Race, (Trim To Fit) Nitroseal, 1.20" x 2.00" Ports	95186SG	1
			Large Coolant Ports, Except Boss, Small Race, (Trim To Fit) Composition, 1.20" x 2.00" Ports	95186SP	1
			Small Coolant Ports, Except Boss, Small Race, (Trim To Fit) Nitroseal, 1.20" x 2.00" Ports	95187SG	1
			Small Coolant Ports, Except Boss, Small Race, (Trim To Fit) Composition, 1.20" x 2.00" Ports	95187SP	1
			Small Coolant Ports, Except Boss, Large Race, (Trim To Fit) Nitroseal, 1.28" X 2.10" Ports	95197SG	1
			Small Coolant Ports, Except Boss, Large Race, (Trim To Fit) Composition, 1.28" X 2.10" Ports	95197SP	1
			Large Coolant Ports, Except Boss, Large Race, (Trim To Fit) Composition, 1.28" X 2.10" Ports	95198SP	1
			Except Boss, Small Rectangular Coolant Ports Nitroseal, 1.28" X 2.10" Ports	95010SG	1
			1968-1976	"L" Shaped Coolant Ports, Except Boss Nitroseal, 1.28" X 2.10" Ports	95103SG
Ex Header Gskt			Except Boss Nitroseal, 1.13" x 1.53" Ports	95025SG	1
			Except Boss Nitroseal, 1.41" Round Ports	95066SG	1
			Except Boss, (Dual Bolt Pattern. Stock Ford, Splayed AR) Nitroseal, 1.40" x 1.40" Ports	95176SG	1
			Except Boss, (Dual Inline Bolt Patterns. Stock Bolt Pattern And Spread Bolt Dart And TFS) Nitroseal, 1.42" x 1.62" Ports	95177SG	1
Oil Pan Set			Except Boss Tuff-Cork	OS30531TC	1
			Except Boss Victo-Tech	OS32491	1
Timing Cover Gasket			Except Boss Performaseal	T27802VC	1
Fuel Pump Gasket			Except Boss Performaseal	D27094VC	1
Water Outlet Gasket			Except Boss Performaseal	C24005VC	1
Water Pump Mount Gasket	1996-1997		Explorer And Mountaineer Performaseal	K27988VC	1
	1993-1995		Except Truck Performaseal	K27988VC	1
	1991-1992		Cougar And Thunderbird Performaseal	K27988VC	1
	1991-1992		Except Truck, Cougar And Thunderbird Performaseal	K27955VC	1
	1987-1990		Except Truck Performaseal	K27955VC	1
	1968-1986		Performaseal	K27955VC	1
Water Pump Backing Plate	1996-1997		Truck Performaseal	K30707VC	1
	1992-1995		Performaseal	K30707VC	1
	1990-1991		Except Truck Performaseal	K28004VC	1
			Truck Performaseal	K30707VC	1
	1986-1989		Performaseal	K30707VC	1
	1983-85		Exc. Capri, Cougar XR7, LTD, Marquis Full Size, Mustang & Truck Performaseal	K27151VC	1
			Capri, Cougar XR7, LTD, Marquis Full Size, Mustang & Truck, Exc. Police, Taxi & Trl./Tow Performaseal	K27989VC	1
	1979-82		Exc. Capri, Cougar XR7, LTD, Marquis Full Size, Mustang Performaseal	K27151VC	1
			Capri, Cougar XR7, LTD, Marquis Full Size, Mustang, Exc. Police, Taxi & Trl./Tow Performaseal	K27989VC	1
1970-78		Except Bronco & Econoline Performaseal	K27151VC	1	
		Bronco & Econoline Performaseal	K27142VC	1	

9 302 CID (5.0L) V8 Cyl, 4.000in./101.6mm (1968-1997) **9**
 (cont.) (cont.)

Part Year VIN Model/Application Part Number Qty.

ENGINE GASKETS (cont.)

Water Pump Backing Plate (cont.)	1968-69		Except F100	Performaseal	K27142VC	1
			F100	Performaseal	K27151VC	1

10 302 CID (5.0L) Boss V8 Cyl, 4.000in./101.6mm (1969-1971) **10**

Part Year VIN Model/Application Part Number Qty.

ENGINE GASKETS

Cylinder Head Gasket			VR2000, 8.8cc Combustion Chamber Volume, 4.100" Combustion Chamber Opening, .042" Compressed Operating Thickness		3446	2
Valve Cover Set			High Temperature Cork Rubber		VS38422H	1
			Tuff-Cork		VS38422TC	1
Manifold Set, Intake			Nitroseal, 1.88" X 2.65" Ports		95160SG	1
			Composition, 1.88" X 2.65" Ports		95160SP	1
Ex Header Gskt			Nitroseal, 1.92" x 2.20" Ports		95080SG	1
Oil Pan Set			Tuff-Cork		OS30531TC	1
Timing Cover Gasket				Performaseal	T27802VC	1
Fuel Pump Gasket				Performaseal	D27094VC	1
Water Outlet Gasket				Performaseal	C24005VC	1
Water Pump Mount Gasket				Performaseal	K27955VC	1
Water Pump Backing Plate				Performaseal	K27151VC	1

11 302 CID (5.0L) SVO V8 Cyl, 4.000in./101.6mm **11**

Part Year VIN Model/Application Part Number Qty.

ENGINE GASKETS

Cylinder Head Gasket			Except Large Overbore VR2000, 8.8cc Combustion Chamber Volume, 4.100" Combustion Chamber Opening, .042" Compressed Operating Thickness		3446	2
			Large Overbore, Left Solicor, 9.6cc Combustion Chamber Volume, 4.160" Combustion Chamber Opening, .042" Compressed Operating Thickness		5947SC	1
			Large Overbore, Right Solicor, 9.6cc Combustion Chamber Volume, 4.160" Combustion Chamber Opening, .042" Compressed Operating Thickness		5948SC	1
			Cylindrical Combustion Chamber Multi-Layered Steel, 4.080" Combustion Chamber Opening, .040" Compressed Operating Thickness		54238	2
			Cylindrical Combustion Chamber Multi-Layered Steel, 4.100" Combustion Chamber Opening, .040" Compressed Operating Thickness		54295	2
			Cylindrical Combustion Chamber Multi-Layered Steel, 4.125" Combustion Chamber Opening, .040" Compressed Operating Thickness		54296	2
			Cylindrical Combustion Chamber Multi-Layered Steel, 4.155" Combustion Chamber Opening, .040" Compressed Operating Thickness		54297	2
			Cylindrical Combustion Chamber Multi-Layered Steel, 4.180" Combustion Chamber Opening, .040" Compressed Operating Thickness		54298	2
			Cylindrical Combustion Chamber Multi-Layered Steel, 4.200" Combustion Chamber Opening, .040" Compressed Operating Thickness		54299	2
Valve Cover Set			High Temperature Cork Rubber		VS38422H	1
			Tuff-Cork		VS50069TC	1
Stabilizer Cover			Tuff-Cork		VS38160TC	1

PERFORMANCE

Ford

11 (cont.)	302 CID (5.0L) SVO V8 Cyl, 4.000in./101.6mm					11 (cont.)
----------------------	--	--	--	--	--	----------------------

Part	Year	VIN	Model/Application	Part Number	Qty.
ENGINE GASKETS (cont.)					
Manifold Set, Intake			Cylinder Head M6049 A3 Nitroseal, 1.83" x 2.20" Ports	95137SG	1
			Cylinder Head M6049 B351, M3049 C302, M6049 D302 Nitroseal, 1.35" x 2.20" Ports	95139SG	1
			Ford SVO Yates Cylinder Head Number M6049-C3 1/32" Thick	95202-1SP	1
			Ford SVO Yates Cylinder Head Number M6049-C3 1/16" Thick	95202-3SP	1
			Ford SVO Yates Cylinder Head Number M6049-C3 3/32" Thick	95202-4SP	1
			Ford SVO Yates Cylinder Head Number M6049-C3 1/8" Thick	95202-5SP	1
Ex Header Gskt			Cylinder Head M6049 A3 Nitroseal, 1.94" Round Ports	95140SG	1
			Cylinder Head M6049 B351, M3049 C302, M6049 D302 Nitroseal, 1.81" Round Ports	95141SG	1
Oil Pan Set			Tuff-Cork	OS30531TC	1
			Victo-Tech	OS32491	1
Timing Cover Gasket			Performaseal	T27802VC	1
Fuel Pump Gasket			Performaseal	D27094VC	1
Water Pump Gasket			Performaseal	C24005VC	1
Water Pump Mount Gasket			Performaseal	K27955VC	1
Water Pump Backing Plate			Performaseal	K27151VC	1

12	332 CID (5.4L) V8 Cyl, 4.000in./101.6mm (1958-1959)					12
-----------	--	--	--	--	--	-----------

Part	Year	VIN	Model/Application	Part Number	Qty.
ENGINE GASKETS					
Manifold Set, Intake			Nitroseal	95009SG	1
Ex Header Gskt			Nitroseal	95032SG	1

13	351 CID (5.8L) 351C Ford Cleveland V8 Cyl, 4.000in./101.6mm (1970-1974)					13
-----------	--	--	--	--	--	-----------

Part	Year	VIN	Model/Application	Part Number	Qty.
ENGINE GASKETS					
Cylinder Head Gasket			Solicor, 9.1cc Combustion Chamber Volume, 4.080" Combustion Chamber Opening, .044" Compressed Operating Thickness	3502SCR	2
			Nitroseal, 9.4cc Combustion Chamber Volume, 4.080" Combustion Chamber Opening, .045" Compressed Operating Thickness	3502SG	2
Valve Cover Set			High Temperature Cork Rubber	VS38422H	1
			Tuff-Cork	VS38422TC	1
Manifold Set, Intake			2 Barrel Carburetor Nitroseal, 1.61" x 2.26" Ports	95077SG	1
			4 Barrel Carburetor Nitroseal, 1.85" x 2.62" Ports	95078SG	1
Ex Header Gskt			4 Barrel Carburetor Nitroseal, 1.92" x 2.20" Ports	95080SG	1
			2 Barrel Carburetor Nitroseal, 1.60" x 1.95" Ports	95081SG	1
Oil Pan Set			Tuff-Cork	OS30543TC	1
Timing Cover Gasket			Performaseal	T27150VC	1
Fuel Pump Gasket			Performaseal	D24006VC	1
Water Pump Mount Gasket			Performaseal	K27151VC	1

14	351 CID (5.8L) 351C SVO Ford Cleveland V8 Cyl, 4.000in./101.6mm					14
-----------	--	--	--	--	--	-----------

Part	Year	VIN	Model/Application	Part Number	Qty.
ENGINE GASKETS					
Cylinder Head Gasket			Solicor, 9.1cc Combustion Chamber Volume, 4.080" Combustion Chamber Opening, .044" Compressed Operating Thickness	3502SCR	2

14 351 CID (5.8L) 351C SVO Ford Cleveland V8 Cyl, 4.000in./101.6mm **14**
(cont.) (cont.)

Part	Year	VIN	Model/Application	Part Number	Qty.
ENGINE GASKETS (cont.)					
Cylinder Head Gasket (cont.)			Nitroseal, 9.4cc Combustion Chamber Volume, 4.080" Combustion Chamber Opening, .045" Compressed Operating Thickness	3502SG	2
Valve Cover Set			High Temperature Cork Rubber	VS38422H	1
			Tuff-Cork	VS50069TC	1
Stabilizer Cover			Tuff-Cork	VS38160TC	1
Manifold Set, Intake			Cylinder Head M6049 A3 Nitroseal, 1.83" x 2.20" Ports	95137SG	1
			Cylinder Head M6049 B351, M3049 C302, M6049 D302 Nitroseal, 1.35" x 2.20" Ports	95139SG	1
			Ford SVO Yates Cylinder Head Number M6049-C3 1/32" Thick	95202-1SP	1
			Ford SVO Yates Cylinder Head Number M6049-C3 1/16" Thick	95202-3SP	1
			Ford SVO Yates Cylinder Head Number M6049-C3 3/32" Thick	95202-4SP	1
			Ford SVO Yates Cylinder Head Number M6049-C3 1/8" Thick	95202-5SP	1
	Ex Header Gskt			Cylinder Head M6049 A3 Nitroseal, 1.94" Round Ports	95140SG
			Cylinder Head M6049 B351, M3049 C302, M6049 D302 Nitroseal, 1.81" Round Ports	95141SG	1
Oil Pan Set			Tuff-Cork	OS30543TC	1
Timing Cover Gasket			Performaseal	T27150VC	1
Water Pump Mount Gasket			Performaseal	K27151VC	1

15 351 CID (5.8L) 351M V8 Cyl, 4.000in./101.6mm (1975-1982) **15**
400 CID (6.6L) OHV V8 Cyl, 4.000in./101.6mm (1971-1982)

Part	Year	VIN	Model/Application	Part Number	Qty.
ENGINE GASKETS					
Cylinder Head Gasket			Solicor, 9.1cc Combustion Chamber Volume, 4.080" Combustion Chamber Opening, .044" Compressed Operating Thickness	3502SCR	2
			Nitroseal, 9.4cc Combustion Chamber Volume, 4.080" Combustion Chamber Opening, .045" Compressed Operating Thickness	3502SG	2
Valve Cover Set			High Temperature Cork Rubber	VS38422H	1
			Tuff-Cork	VS38422TC	1
Ex Header Gskt			4 Barrel Carburetor Nitroseal, 1.92" x 2.20" Ports	95080SG	1
			2 Barrel Carburetor Nitroseal, 1.60" x 1.95" Ports	95081SG	1
Oil Pan Set			Tuff-Cork	OS30543TC	1
Timing Cover Gasket			Performaseal	T27150VC	1
Fuel Pump Gasket			Performaseal	D24006VC	1
Water Pump Mount Gasket			Performaseal	K27158VC	1
Water Pump Backing Plate			Performaseal	K27151VC	1

16 351 CID (5.8L) 351W Ford Windsor V8 Cyl, 4.000in./101.6mm (1969-1997) **16**

Part	Year	VIN	Model/Application	Part Number	Qty.
ENGINE GASKETS					
Full Set	1975-1990		(Performer, Contains Nitroseal Head Gasket)	FS3428SG	1
Cylinder Head Gasket	1969-1995		Solicor, 8.8cc Combustion Chamber Volume, 4.080" Combustion Chamber Opening, .042" Compressed Operating Thickness	3428SCR	2
			Nitroseal, 9.4cc Combustion Chamber Volume, 4.080" Combustion Chamber Opening, .045" Compressed Operating Thickness	3428SG	2

Ford

16 (cont.)	351 CID (5.8L) 351W Ford Windsor V8 Cyl, 4.000in./101.6mm (1969-1997)				16 (cont.)
----------------------	--	--	--	--	----------------------

Part	Year	VIN	Model/Application	Part Number	Qty.
ENGINE GASKETS (cont.)					
Cylinder Head Gasket (cont.)	1969-1995		<i>Solicor, 9.0cc Combustion Chamber Volume, 4.100" Combustion Chamber Opening, .042" Compressed Operating Thickness</i>	5956SC	2
			<i>Multi-Layered Steel, 4.200" Combustion Chamber Opening, .040" Compressed Operating Thickness</i>	54187	2
			<i>Multi-Layered Steel, 4.030" Combustion Chamber Opening, .040" Compressed Operating Thickness</i>	54290	2
			<i>Multi-Layered Steel, 4.080" Combustion Chamber Opening, .040" Compressed Operating Thickness</i>	54291	2
			<i>Multi-Layered Steel, 4.100" Combustion Chamber Opening, .040" Compressed Operating Thickness</i>	54292	2
			<i>Multi-Layered Steel, 4.155" Combustion Chamber Opening, .040" Compressed Operating Thickness</i>	54293	2
Valve Cover Set	1969-1995		<i>High Temperature Cork Rubber</i>	VS38300H	1
			<i>High Temperature Tuff-Cork</i>	VS38300HTC	1
Manifold Set, Intake	1975-1995		<i>Nitroseal, 1.28" X 2.10" Ports</i>	95108SG	1
	1969-1995		<i>Large Coolant Ports, Small Race, (Trim To Fit) Nitroseal, 1.20" x 2.00" Ports</i>	95186SG	1
			<i>Large Coolant Ports, Small Race, (Trim To Fit) Composition, 1.20" x 2.00" Ports</i>	95186SP	1
			<i>Small Coolant Ports, Small Race, (Trim To Fit) Nitroseal, 1.20" x 2.00" Ports</i>	95187SG	1
			<i>Small Coolant Ports, Small Race, (Trim To Fit) Composition, 1.20" x 2.00" Ports</i>	95187SP	1
			<i>Large Race, Small Coolant Ports, (Trim To Fit) Nitroseal, 1.28" X 2.10" Ports</i>	95197SG	1
			<i>Large Race, Small Coolant Ports, (Trim To Fit) Composition, 1.28" X 2.10" Ports</i>	95197SP	1
			<i>Large Coolant Ports, Large Race, (Trim To Fit) Composition, 1.28" X 2.10" Ports</i>	95198SP	1
			<i>Nitroseal, 1.28" X 2.10" Ports</i>	95110SG	1
	Ex Header Gskt	1969-1995		<i>Nitroseal, 1.13" x 1.53" Ports</i>	95025SG
			<i>Nitroseal, 1.41" Round Ports</i>	95066SG	1
			<i>(Dual Bolt Pattern. Stock Ford Inline) Nitroseal, 1.40" x 1.40" Ports</i>	95176SG	1
			<i>(Dual Inline Bolt Patterns. Stock Bolt Pattern) Nitroseal, 1.42" x 1.62" Ports</i>	95177SG	1
Oil Pan Set	1969-1995		<i>(Notched For Main Cap And Trimmed For Stokers) Tuff-Cork</i>	OS32129TC	1
			<i>Victo-Tech</i>	OS32492	1
	1969-1992		<i>Tuff-Cork</i>	OS30541TC	1
Timing Cover Gasket	1969-1994		<i>Performaseal</i>	T27802VC	1
Fuel Pump Gasket	1969-1987		<i>Performaseal</i>	D27094VC	1
Water Outlet Gasket	1969-1995		<i>Performaseal</i>	C24005VC	1
Water Pump Mount Gasket	1993-1995	Except Truck	<i>Performaseal</i>	K27988VC	1
	1988-1992	Except Truck	<i>Performaseal</i>	K27955VC	1
	1969-1987		<i>Performaseal</i>	K27955VC	1
Water Pump Backing Plate	1990-1997	Truck	<i>Performaseal</i>	K30707VC	1
	1986-1989		<i>Performaseal</i>	K30707VC	1
	1983-1985	Exc. Grand Marquis, LTD & Truck	<i>Performaseal</i>	K27151VC	1
	1980-1982	Exc. Grand Marquis, Marquis, LTD & Mustang	<i>Performaseal</i>	K27151VC	1
	1979	Truck, Cougar, LTD & Thunderbird	<i>Performaseal</i>	K27151VC	1
	1970-1978		<i>Performaseal</i>	K27151VC	1

PERFORMANCE

17 352 CID (5.8L) V8 Cyl, 4.000in./101.6mm (1958-1967) 17

Part	Year	VIN	Model/Application	Part Number	Qty.
ENGINE GASKETS					
Valve Cover Set	1961-1967		High Temperature Tuff-Cork	VS50194HTC	1
Manifold Set, Intake	1961-1967		Nitroseal, 1.46" x 2.40" Ports	95009SG	1
		Medium Riser	Nitroseal, 1.40" x 2.10" Ports	95159SG	1
		Medium Riser	Composition, 1.40" x 2.10" Ports	95159SP	1
Ex Header Gskt	1966-1967	14 Bolt Head	Nitroseal, 1.43" x 2.12" Ports	95184SG	1
			Nitroseal, 1.38" x 2.16" Ports	95032SG	1
Timing Cover Gasket	1964-1967		Performaseal	T27798VC	1
Fuel Pump Gasket	1961-1967		Performaseal	D27094VC	1
Water Pump Mount Gasket	1961-1967		Performaseal	K26442VC	2

**18 390 CID (6.4L) V8 Cyl, 4.050in./102.9mm (1961-1971)
427 CID (7.0L) V8 Cyl, 4.233in./107.5mm (1963-1968)
428 CID (7.0L) Thunderbird V8 Cyl, 4.130in./104.9mm (1966-1968) 18**

Part	Year	VIN	Model/Application	Part Number	Qty.
ENGINE GASKETS					
Cylinder Head Gasket			Solicor, 10.2cc Combustion Chamber Volume, 4.400" Combustion Chamber Opening, .042" Compressed Operating Thickness	5959SC	2
Valve Cover Set			High Temperature Tuff-Cork	VS50194HTC	1
Manifold Set, Intake			Nitroseal, 1.46" x 2.40" Ports	95009SG	1
		Medium Riser	Nitroseal, 1.40" x 2.10" Ports	95159SG	1
		Medium Riser	Composition, 1.40" x 2.10" Ports	95159SP	1
Ex Header Gskt	1966-1969	14 Bolt Head	Nitroseal, 1.38" x 2.16" Ports	95032SG	1
			Nitroseal, 1.43" x 2.12" Ports	95184SG	1
Timing Cover Gasket	1964-1971		Performaseal	T27798VC	1
Fuel Pump Gasket			Performaseal	D27094VC	1
Water Pump Mount Gasket			Performaseal	K26442VC	2

19 406 CID (6.7L) V8 Cyl, 4.130in./104.9mm (1962-1964) 19

Part	Year	VIN	Model/Application	Part Number	Qty.
ENGINE GASKETS					
Cylinder Head Gasket			Solicor, 10.2cc Combustion Chamber Volume, 4.400" Combustion Chamber Opening, .042" Compressed Operating Thickness	5959SC	2
Valve Cover Set			High Temperature Tuff-Cork	VS50194HTC	1
Manifold Set, Intake			Nitroseal, 1.46" x 2.40" Ports	95009SG	1
		Medium Riser	Nitroseal, 1.40" x 2.10" Ports	95159SG	1
		Medium Riser	Composition, 1.40" x 2.10" Ports	95159SP	1
Ex Header Gskt			Nitroseal, 1.38" x 2.16" Ports	95032SG	1
Timing Cover Gasket	1964		Performaseal	T27798VC	1
Fuel Pump Gasket			Performaseal	D27094VC	1
Water Pump Mount Gasket			Performaseal	K26442VC	2

**20 428 CID (7.0L) Cobra Jet V8 Cyl, 4.130in./104.9mm (1966-1970)
428 CID (7.0L) Super Cobra Jet V8 Cyl, 4.130in./104.9mm (1969-1970) 20**

Part	Year	VIN	Model/Application	Part Number	Qty.
ENGINE GASKETS					
Cylinder Head Gasket			Solicor, 10.2cc Combustion Chamber Volume, 4.400" Combustion Chamber Opening, .042" Compressed Operating Thickness	5959SC	2
Valve Cover Set			High Temperature Tuff-Cork	VS50194HTC	1
Manifold Set, Intake			Nitroseal, 1.46" x 2.40" Ports	95009SG	1
		Standard And Low Riser	Nitroseal, 1.40" x 2.34" Ports	95158SG	1
		Standard And Low Riser	Composition, 1.40" x 2.34" Ports	95158SP	1

Ford

20 (cont.)	428 CID (7.0L) Cobra Jet V8 Cyl, 4.130in./104.9mm (1966-1970)				20 (cont.)
	428 CID (7.0L) Super Cobra Jet V8 Cyl, 4.130in./104.9mm (1969-1970)				

Part	Year	VIN	Model/Application	Part Number	Qty.
ENGINE GASKETS (cont.)					
Manifold Set, Intake (cont.)			Medium Riser <i>Nitroseal, 1.40" x 2.10" Ports</i>	95159SG	1
			Medium Riser <i>Composition, 1.40" x 2.10" Ports</i>	95159SP	1
Ex Header Gskt			<i>Nitroseal, 1.38" x 2.16" Ports</i>	95032SG	1
	1966-1969		14 Bolt Head <i>Nitroseal, 1.43" x 2.12" Ports</i>	95184SG	1
Timing Cover Gasket			<i>Performaseal</i>	T27798VC	1
Fuel Pump Gasket			<i>Performaseal</i>	D27094VC	1
Water Pump Mount Gasket			<i>Performaseal</i>	K26442VC	2

21	429 CID (7.0L) V8 Cyl, 4.360in./110.7mm (1968-1973)				21
-----------	--	--	--	--	-----------

Part	Year	VIN	Model/Application	Part Number	Qty.
ENGINE GASKETS					
Cylinder Head Gasket			Except Boss <i>Nitroseal, 11.5cc Combustion Chamber Volume, 4.500" Combustion Chamber Opening, .045" Compressed Operating Thickness</i>	3978SG	2
			Except Boss <i>Solicor, 11.5cc Combustion Chamber Volume, 4.670" Combustion Chamber Opening, .042" Compressed Operating Thickness</i>	5952SC	2
Valve Cover Set			Except Boss <i>High Temperature Cork Rubber</i>	VS38421H	1
			<i>Tuff-Cork</i>	VS38421TC	1
Manifold Set, Intake			Except Boss, Except Cobra Jet, Except Super Cobra Jet <i>Nitroseal, 1.98" x 2.26" Ports</i>	95109SG	1
	1970-1971		Cobra Jet, Except Boss, Super Cobra Jet <i>Nitroseal, 2.23" x 2.60" Ports</i>	95074SG	1
Ex Header Gskt			Except Boss, Except Cobra Jet, Except Super Cobra Jet <i>Nitroseal, 1.50" x 2.10" Ports</i>	95091SG	1
	1970-1971		Cobra Jet, Except Boss, Super Cobra Jet <i>Nitroseal, 1.55" x 2.35" Ports</i>	95075SG	1
Oil Pan Set			Except Boss <i>Tuff-Cork</i>	OS30540TC	1
Fuel Pump Gasket			Except Boss <i>Performaseal</i>	D27094VC	1
Water Pump Mount Gasket			Except Boss <i>Performaseal</i>	K27147VC	1
Water Pump Backing Plate			Except Boss <i>Performaseal</i>	K27148VC	1

22	460 CID (7.5L) V8 Cyl, 4.360in./110.7mm (1968-1995)				22
-----------	--	--	--	--	-----------

Part	Year	VIN	Model/Application	Part Number	Qty.
ENGINE GASKETS					
Cylinder Head Gasket	1968-1990		<i>Nitroseal, 11.5cc Combustion Chamber Volume, 4.500" Combustion Chamber Opening, .045" Compressed Operating Thickness</i>	3978SG	2
			<i>Solicor, 11.5cc Combustion Chamber Volume, 4.670" Combustion Chamber Opening, .042" Compressed Operating Thickness</i>	5952SC	2
Valve Cover Set	1968-1987		<i>High Temperature Cork Rubber</i>	VS38421H	1
			<i>Tuff-Cork</i>	VS38421TC	1
Manifold Set, Intake	1968-1987		<i>Nitroseal, 1.98" x 2.26" Ports</i>	95109SG	1
Ex Header Gskt	1968-1987		<i>Nitroseal, 1.50" x 2.10" Ports</i>	95091SG	1
Oil Pan Set	1968-1988		<i>Tuff-Cork</i>	OS30540TC	1
Fuel Pump Gasket	1968-1988		<i>Performaseal</i>	D27094VC	1
Water Pump Mount Gasket			<i>Performaseal</i>	K27147VC	1
Water Pump Backing Plate			<i>Performaseal</i>	K27148VC	1

23 500 CID (8.2L) Pro Stock Big Block V8 Cyl, in./mm 23

Part	Year	VIN	Model/Application	Part Number	Qty.
ENGINE GASKETS					
Cylinder Head Gasket			10 Bolt Pattern, Wedge Head Engine, (For Ford Hemi) <i>Solicor, 14.0cc Combustion Chamber Volume, 4.670"</i> <i>Combustion Chamber Opening, .051" Compressed</i> <i>Operating Thickness</i>	5973SC	2
			18 Bolt Pattern, Wedge Head Engine <i>Solicor, 14.0cc Combustion Chamber Volume, 4.670"</i> <i>Combustion Chamber Opening, .051" Compressed</i> <i>Operating Thickness</i>	5974SC	2
Valve Cover Set			Wedge Head Engine <i>High Temperature Tuff-Cork</i>	VS50187HTC	1
			Boss <i>High Temperature Tuff-Cork</i>	VS50189HTC	1
Manifold Set, Intake			(No Bolt Holes Or Ports (Universal Trim To Fit)) <i>Composition, 1/16" Thick</i>	95168SP	1
Ex Header Gskt			Wedge Head Engine <i>Nitroseal, 1.50" x 2.20" Ports</i>	95181SG	1
Oil Pan Set			Wedge Head Engine <i>Tuff-Cork</i>	OS32127TC	1

General Motors Corp.

Engine Index

Engine	Year	Block	Engine	Year	Block
151 CID (2.5L) Crossflow Head & Super Duty Pontiac	1977-1990	1	346 CID (5.7L) Generation III Chevrolet	1997-2003	15
173 CID (2.8L) 60 Degree Chevrolet	1980-1986	2	350 CID (5.7L) Oldsmobile	1968-1980	16
194 CID (3.2L) Chevrolet	1962-1967	3	350 CID (5.7L) Pontiac	1968-1977	17
196 CID (3.2L) Buick	1978-1979	4	350 CID (5.7L) Generation I Chevrolet	1967-2001	18
200 CID (3.3L) Chevrolet	1978-1979	5	350 CID (5.7L) Generation II Chevrolet	1992-1997	19
229 CID (3.8L) 90 Degree Chevrolet	1980-1984	5	356 CID (5.8L) Batten Oldsmobile	1978-1985	20
230 CID (3.8L) Chevrolet	1963-1970	3	389 CID (6.4L) Pontiac	1959-1966	14
231 CID (3.8L) Buick	1975-1987	6	396 CID (6.6L) Chevrolet	1965-1970	21
250 CID (4.1L) Chevrolet	1966-1979	3	400 CID (6.6L) Chevrolet	1970-1980	22
252 CID (4.1L) Buick	1980-1984	4	400 CID (6.6L) Oldsmobile	1968-1969	16
262 CID (4.3L) 90 Degree Chevrolet	1985-1993	7	400 CID (6.6L) Oldsmobile	1965-1967	16
CID SB2 Small Block Chevrolet		8	400 CID (6.6L) Pontiac	1967-1979	23
262 CID (4.3L) Chevrolet	1975-1976	9	402 CID (6.6L) Chevrolet	1970-1972	21
267 CID (4.4L) Chevrolet	1979-1982	10	421 CID (6.9L) Pontiac	1963-1966	24
283 CID (4.6L) Chevrolet	1957-1967	11	425 CID (7.0L) Oldsmobile	1965-1967	16
302 CID (5.0L) Large Journal Chevrolet	1968-1969	12	427 CID (7.0L) Chevrolet	1966-1990	21
302 CID (5.0L) Small Journal Chevrolet	1967	12	428 CID (7.0L) Pontiac	1967-1969	25
305 CID (5.0L) Chevrolet	1976-2001	13	454 CID (7.4L) Chevrolet	1970-1998	26
307 CID (5.0L) Chevrolet	1968-1973	11	455 CID (7.5L) Oldsmobile	1968-1976	16
326 CID (5.3L) Pontiac	1963-1967	14	455 CID (7.5L) Pontiac	1970-1976	27
327 CID (5.4L) Large Journal Chevrolet	1968-1969	12	500 CID (8.2L) Pro Stock Big Block		28
327 CID (5.4L) Small Journal Chevrolet	1962-1967	12	502 CID (8.2L) Chevrolet		29

1 151 CID (2.5L) Crossflow Head & Super Duty Pontiac 4 Cyl, 4.000in./101.6mm (1977-1990) 1

Part	Year	VIN	Model/Application	Part Number	Qty.
ENGINE GASKETS					
Cylinder Head Gasket	1979-1986		<i>Solicor, 8.8cc Combustion Chamber Volume, 4.100"</i> <i>Combustion Chamber Opening, .042" Compressed</i> <i>Operating Thickness</i>	5955SC	1
	1977-1986		<i>Nitroseal, 9.3cc Combustion Chamber Volume, 4.066"</i> <i>Combustion Chamber Opening, .045" Compressed</i> <i>Operating Thickness</i>	3684SG	1
Valve Cover Set	1979-1986		<i>High Temperature Tuff-Cork</i>	VS39354HTC	1
Manifold Set, Intake			Except Super Duty Engine <i>Nitroseal, 1.30" x 1.90" Ports</i>	95104SG	1
			Super Duty, Except Cast Iron EGR Head <i>Nitroseal, 1.46" x 2.24" Ports</i>	95133SG	1
Ex Header Gskt			Except Super Duty Engine <i>Nitroseal, 1.50" x 1.55" Ports</i>	95097SG	1
	1979-1986		Super Duty Cylinder Heads Part Number 10031322 Cast Iron And Part Number 10038433 Aluminum <i>Nitroseal, 1.15" x 1.64" Ports</i>	95134SG	1
Oil Pan Set			Except Super Duty Engine <i>Tuff-Cork</i>	OS30539XTC	1
	1979-1984		Super Duty <i>Tuff-Cork</i>	OS32125TC	1
Timing Cover Gasket			<i>Performaseal</i>	T27634VC	1

PERFORMANCE

General Motors Corp.

1	151 CID (2.5L) Crossflow Head & Super Duty Pontiac 4 Cyl, 4.000in./101.6mm (1977-1990)	1
(cont.)		(cont.)

Part	Year	VIN	Model/Application	Part Number	Qty.
ENGINE GASKETS (cont.)					
Fuel Pump Gasket	1979-1986			Performaseal D27094VC	1
Water Pump Gasket	1979-1989		Adapter To Block	Performaseal K26284VC	1
Water Pump Mount Gasket	1984-1989			Performaseal K27454VC	1
	1977-1983			Performaseal K26545VC	1

2	173 CID (2.8L) 60 Degree Chevrolet V6 Cyl, 3.504in./89mm (1980-1986)	2
----------	---	----------

Part	Year	VIN	Model/Application	Part Number	Qty.
ENGINE GASKETS					
Cylinder Head Gasket			Solicor, 7.0cc Combustion Chamber Volume, 3.620" Combustion Chamber Opening, .042" Compressed Operating Thickness	5958SC	2
Manifold Set, Intake			Except Fuel Injection, Stock 1.09" X 1.77" Ports	MS15221	1
Ex Header Gskt			Stock And Small Race Nitroseal, 1.25" Round Ports	95183SG	1

3	194 CID (3.2L) Chevrolet 6 Cyl, 3.563in./90.5mm (1962-1967) 230 CID (3.8L) Chevrolet 6 Cyl, 3.875in./98.4mm (1963-1970) 250 CID (4.1L) Chevrolet 6 Cyl, 3.875in./98.4mm (1966-1979)	3
----------	--	----------

Part	Year	VIN	Model/Application	Part Number	Qty.
ENGINE GASKETS					
Manifold Set, Int. & Exh.			Separate Head And Intake Manifold Nitroseal	95000SG	1
Water Pump Gasket				Performaseal K26545VC	1

4	196 CID (3.2L) Buick V6 Cyl, 3.500in./88.9mm (1978-1979) 252 CID (4.1L) Buick V6 Cyl, 3.965in./100.7mm (1980-1984)	4
----------	---	----------

Part	Year	VIN	Model/Application	Part Number	Qty.
ENGINE GASKETS					
Cylinder Head Gasket			Nitroseal, 9.2cc Combustion Chamber Volume, 4.025" Combustion Chamber Opening, .045" Compressed Operating Thickness	5820SG	2
Valve Cover Set			High Temperature Cork Rubber	VS39763H	1
			Tuff-Cork	VS39763TC	1
Manifold Set, Intake	1979-1984		Nitroseal, 1.10" X 2.05" Ports	95105SG	1
Ex Header Gskt	1979-1984		Nitroseal, 1.09" X 1.39" Ports	95092SG	1
Oil Pan Set			14 Bolt Oil Pan, Stage I And II Tuff-Cork	OS32131TC	1
Timing Cover Set			(Contains Superflex Seal)	JV1051SF	1
Timing Cover Gasket				Performaseal T27960VC	1
Fuel Pump Gasket				Performaseal D27094VC	1
Water Pump Gasket				Performaseal K27571VC	1

5	200 CID (3.3L) Chevrolet V6 Cyl, 3.500in./88.9mm (1978-1979) 229 CID (3.8L) 90 Degree Chevrolet V6 Cyl, 3.736in./95mm (1980-1984)	5
----------	--	----------

Part	Year	VIN	Model/Application	Part Number	Qty.
ENGINE GASKETS					
Cylinder Head Gasket			Nitroseal, 8.4cc Combustion Chamber Volume, 3.840" Combustion Chamber Opening, .045" Compressed Operating Thickness	3925SG	2
Valve Cover Set			High Temperature Cork Rubber	VS39766H	1
Manifold Set, Intake			Stock Nitroseal, 1.28" X 2.10" Ports	95106SG	1
			Race Nitroseal, 1.34" X 2.21" Ports	95126SG	1
			(Top Gasket Second Design Manifold Box) Composition	95188SP	1
			High Port Composition, 1.15" X 2.18" Ports	95194SP	1
Ex Header Gskt			Stock Nitroseal, 1.50" X 1.50" Square Ports	95093SG	1
			Race Nitroseal, 1.55" X 1.55" Square Ports	95127SG	1

PERFORMANCE

5	200 CID (3.3L) Chevrolet V6 Cyl, 3.500in./88.9mm (1978-1979)	5
(cont.)	229 CID (3.8L) 90 Degree Chevrolet V6 Cyl, 3.736in./95mm (1980-1984)	(cont.)

Part	Year	VIN	Model/Application	Part Number	Qty.
ENGINE GASKETS (cont.)					
Ex Header Gskt (cont.)			18 Degree Cylinder Heads Nitroseal, 1.77" X 1.85" Ports	95185SG	1
Oil Pan Set				Tuff-Cork OS30934TC	1
Timing Cover Set				Tuff-Cork JV881TC	1
Timing Cover Gasket				Performaseal T27781VC	1
			(Full Circle Design (Quick Change Timing Covers And Gear Drive))	Performaseal T31488VC	1
Fuel Pump Gasket			Pump To Plate	Performaseal D27094VC	1
Water Outlet Gasket			(Aluminum Carrier With Rubber Bead)	C21331	1
Water Pump Mount Gasket				Performaseal K25935VC	2

6	231 CID (3.8L) Buick V6 Cyl, 3.800in./96.5mm (1975-1987)	6
----------	---	----------

Part	Year	VIN	Model/Application	Part Number	Qty.
ENGINE GASKETS					
Cylinder Head Gasket			Except Stage II Nitroseal, 9.2cc Combustion Chamber Volume, 4.025" Combustion Chamber Opening, .045" Compressed Operating Thickness	5820SG	2
	1975-1984		Stage I And II Solicor, 8.8cc Combustion Chamber Volume, 4.090" Combustion Chamber Opening, .042" Compressed Operating Thickness	5957SC	2
Valve Cover Set			Except Stage II High Temperature Cork Rubber	VS39763H	1
			Except Stage II Tuff-Cork	VS39763TC	1
	1977-1987		Stage II High Temperature Tuff-Cork	VS50196HTC	1
Manifold Set, Intake			Except Stage II Nitroseal, 1.10" X 2.05" Ports	95105SG	1
	1979-1987		Stage II Nitroseal, 1.32" X 2.35" Ports	95124SG	1
Ex Header Gskt			Except Stage II Nitroseal, 1.09" X 1.39" Ports	95092SG	1
	1979-1987		Stage II Nitroseal, 1.52" X 1.62" Ports	95125SG	1
Oil Pan Set	1975-1984		14 Bolt Oil Pan, Stage I And II Tuff-Cork	OS32131TC	1
Timing Cover Set	1975-1984		(Contains Superflex Seal)	JV1051SF	1
Timing Cover Gasket	1975-1984			Performaseal T27960VC	1
Fuel Pump Gasket	1975-1985			Performaseal D27094VC	1
Water Pump Gasket	1975-1983			Performaseal K27571VC	1

7	262 CID (4.3L) 90 Degree Chevrolet V6 Cyl, 4.000in./101.6mm (1985-1993)	7
----------	--	----------

Part	Year	VIN	Model/Application	Part Number	Qty.
ENGINE GASKETS					
Cylinder Head Gasket	1987-1989		Solicor, 9.3cc Combustion Chamber Volume, 4.200" Combustion Chamber Opening, .042" Compressed Operating Thickness	5954SC	2
Manifold Set, Intake	1985-1989		(Top Gasket Second Design Manifold Box) Composition	95188SP	1
			High Port Composition, 1.15" X 2.18" Ports	95194SP	1
	1985-1988		Stock Nitroseal, 1.28" X 2.10" Ports	95106SG	1
			Race Nitroseal, 1.34" X 2.21" Ports	95126SG	1
Ex Header Gskt	1985-1989		Stock Nitroseal, 1.50" X 1.50" Square Ports	95093SG	1
			Race Nitroseal, 1.55" X 1.55" Square Ports	95127SG	1
			18 Degree Cylinder Heads Nitroseal, 1.77" X 1.85" Ports	95185SG	1
Timing Cover Gasket				Performaseal T27781VC	1
			(Full Circle Design (Quick Change Timing Covers And Gear Drive))	Performaseal T31488VC	1
Water Pump Mount Gasket				Performaseal K25935VC	2

General Motors Corp.

8 CID SB2 Small Block Chevrolet V8 Cyl, in./mm 8

Part	Year	VIN	Model/Application	Part Number	Qty.
ENGINE GASKETS					
Cylinder Head Gasket			8.9cc Combustion Chamber Volume, 4.200" Combustion Chamber Opening, .039" Compressed Operating Thickness	54198	2
			Multi-Layered Steel, 4.125" Combustion Chamber Opening, .040" Compressed Operating Thickness	54260	2
			Multi-Layered Steel, 4.165" Combustion Chamber Opening, .040" Compressed Operating Thickness	54261	2
			Multi-Layered Steel, 4.190" Combustion Chamber Opening, .040" Compressed Operating Thickness	54262	2
Oil Pan Set				OS32214	1

9 262 CID (4.3L) Chevrolet V8 Cyl, 3.670in./93.2mm (1975-1976) 9

Part	Year	VIN	Model/Application	Part Number	Qty.
ENGINE GASKETS					
Cylinder Head Gasket			Nitroseal, 8.4cc Combustion Chamber Volume, 3.840" Combustion Chamber Opening, .045" Compressed Operating Thickness	3514SG	2
Valve Cover Set			Except Buick/Dart Cylinder Heads High Temperature Cork Rubber, 5/16" Thickness	VS38110H	1
			Except Buick/Dart Cylinder Heads High Temperature Cork Rubber, 5/32" Thickness	VS38110HA	1
			Except Buick/Dart Cylinder Heads High Temperature Tuff-Cork, 5/32" Thickness	VS38110HTC	1
			Buick/Dart Cylinder Heads Tuff-Cork	VS38161TC	1
			Chevrolet 18 Degree And Brodix -12 Cylinder Heads High Temperature Tuff-Cork, 5/16" Thickness	VS50188HTC	1
			Splayed Valve General Motors High Temperature Tuff-Cork, 5/16" Thickness	VS50192HTC	1
Manifold Set, Intake			Small Race Nitroseal, 1.31" x 2.16" Ports	95005SG	1
			Stock And Small Race Nitroseal, 1.23" x 1.99" Ports	95070SG	1
			Stock And Small Race Composition, 1.28" x 2.09" Ports	95070SP	1
			Extra Large Race Nitroseal, 1.38" x 2.38" Ports	95111SG	1
			Large Race Nitroseal, 1.38" x 2.28" Ports	95112SG	1
			Medium Race Nitroseal, 1.34" X 2.21" Ports	95113SG	1
			Blocked Heat Crossover, Stock Nitroseal, 1.23" x 1.99" Ports	95128SG	1
			Open Heat Crossover, Stock Nitroseal, 1.23" x 1.99" Ports	95129SG	1
			Buick/Dart Cylinder Heads Nitroseal, 1.38" x 1.85" To 1.66" x 3.03" Ports	95130SG	1
			18 Degree Cylinder Heads, High Port Composition, 1.25" x 2.15", .030" Thickness	95165SP	1
			18 Degree Cylinder Heads, High Port Composition, 1.25" x 2.15", .045" Thickness	95166SP	1
			18 Degree Cylinder Heads, High Port Composition, .060" Thick, 1.25" x 2.15"	95167SP	1
			Splayed Valve General Motors Nitroseal, 1.60" x 2.00" Port	95169SG	1
			Splayed Valve General Motors Composition, 1.60" x 2.00" Port	95169SP	1
			Large Coolant Ports, (Trim To Fit, Gaskets Cutout For Brodix Water Fitting) Nitroseal, 1/16" Thick, 1.25" x 1.90" To 1.40" x 2.30" Ports	95189SG	1
			Large Coolant Ports, (Trim To Fit, Gaskets Cutout For Brodix Water Fitting) Composition, 1/16" Thick, 1.25" x 1.90" To 1.40" x 2.30" Ports	95189SP	1
			Small Coolant Ports, (Trim To Fit, Gaskets Cutout For Brodix Water Fitting) Nitroseal, 1/16" Thick, 1.25" x 1.90" To 1.40" x 2.30" Ports	95190SG	1
		Small Coolant Ports, (Trim To Fit, Gaskets Cutout For Brodix Water Fitting) Composition, 1/16" Thick, 1.25" x 1.90" To 1.40" x 2.30" Ports	95190SP	1	

PERFORMANCE

9 (cont.)	262 CID (4.3L) Chevrolet V8 Cyl, 3.670in./93.2mm (1975-1976)				9 (cont.)
---------------------	---	--	--	--	---------------------

Part	Year	VIN	Model/Application	Part Number	Qty.
------	------	-----	-------------------	-------------	------

ENGINE GASKETS (cont.)

Manifold Set, Intake (cont.)			Also Fits 867 Pontiac Head, High Port, (Trim To Fit, Gaskets Cutout For Brodix Water Fitting) <i>Nitroseal, 1/16" Thick, 1.31" x 2.02" Rectangular Ports</i>	95191SG	1
			Also Fits 867 Pontiac Head, High Port, (Trim To Fit, Gaskets Cutout For Brodix Water Fitting) <i>Composition, 1/16" Thick, 1.31" x 2.02" Rectangular Ports</i>	95191SP	1
			18 Degree Cylinder Heads, High Port <i>Composition, 1.25" x 2.15", .090" Thickness</i>	95192SP	1
			18 Degree Cylinder Heads, High Port <i>Composition, .120" Thick, 1.25" x 2.15"</i>	95193SP	1
			Small Coolant Ports, (Trim To Fit) <i>Composition, 1/8" Thick, 1.25" x 1.90" To 1.40" x 2.30" Ports</i>	95195SP	1
			Also Fits 867 Pontiac Head, High Port, (Trim To Fit) <i>Composition, 1/8" Thick, 1.31" x 2.02" Rectangular Ports</i>	95196SP	1
			Buick/Dart Cylinder Heads <i>Composition, .060" Thick, 1.38" x 2.125" Ports</i>	95199SP	1
			Buick/Dart Cylinder Heads <i>Composition, .120" Thick, 1.38" x 2.125" Ports</i>	95200SP	1
Ex Header Gskt			<i>Nitroseal, 1.63" Round Ports</i>	95016SG	1
			Large Race <i>Nitroseal, 1.55" x 1.63" Rectangular Port</i>	95065SG	1
			<i>Nitroseal, 1.37" x 1.40" Rectangular Ports</i>	95090SG	1
			Stock And Small Race <i>Nitroseal, 1.50" X 1.50" Square Ports</i>	95094SG	1
			Hooker Headers, Stahl Headers <i>Nitroseal, 1.94" Round Ports</i>	95096SG	1
			<i>Nitroseal, 1.55" x 1.63" D Shape Ports</i>	95098SG	1
			Brodix, Split Ports <i>Nitroseal, 1.94" Round Ports</i>	95099SG	1
			Hooker Headers <i>Nitroseal, 2.19" Round Ports</i>	95101SG	1
			Buick/Dart Cylinder Heads <i>Nitroseal, 1.45" x 1.60" Rectangular Ports</i>	95131SG	1
			Large Race <i>Nitroseal, 1.55" X 1.55" Square Ports</i>	95172SG	1
			18 Degree Cylinder Heads <i>Nitroseal, 1.60" x 1.74" Rectangular Ports</i>	95173SG	1
			18 Degree Adapter Plate <i>Nitroseal, 2.00" Round Ports</i>	95174SG	1
			Splayed Valve General Motors <i>Nitroseal, 1.94" Round Ports</i>	95175SG	1
Oil Pan Set			Left Hand Dip Stick <i>Victo-Tech</i>	OS30568RLH	1
			Left Hand Dip Stick, (Contains 3/8" Thick Front End Strips) <i>Tuff-Cork</i>	OS30568ZTC	1
			Left Hand Dip Stick, (Contains Both 1/4" And 3/8" Thick Front End Strips, Special Construction Side Rails Trimmed For Rod Clearance) <i>Tuff-Cork</i>	OS32126TC	1
Timing Cover Set			(Contains 3/8" Thick Front End Strips) <i>Tuff-Cork</i>	JV881TC	1
Timing Cover Gasket			<i>Performaseal</i>	T27781VC	1
			(Full Circle Design (Quick Change Timing Covers And Gear Drive)) <i>Performaseal</i>	T31488VC	1
Dist. Mounting Gasket			<i>Performaseal</i>	B25934VC	1
Fuel Pump Gasket			Plate To Block <i>Performaseal</i>	D25932VC	1
			Pump To Plate <i>Performaseal</i>	D27094VC	1
Water Outlet Gasket			(Aluminum Carrier With Rubber Bead)	C21331	1
Water Pump Mount Gasket			<i>Performaseal</i>	K25935VC	2

10	267 CID (4.4L) Chevrolet V8 Cyl, 3.500in./88.9mm (1979-1982)				10
-----------	---	--	--	--	-----------

Part	Year	VIN	Model/Application	Part Number	Qty.
------	------	-----	-------------------	-------------	------

ENGINE GASKETS

Cylinder Head Gasket			<i>Nitroseal, 8.4cc Combustion Chamber Volume, 3.840" Combustion Chamber Opening, .045" Compressed Operating Thickness</i>	3514SG	2
-----------------------------	--	--	--	---------------	---

General Motors Corp.

10 267 CID (4.4L) Chevrolet V8 Cyl, 3.500in./88.9mm (1979-1982) **10**
 (cont.) (cont.)

Part Year VIN Model/Application Part Number Qty.

ENGINE GASKETS (cont.)

Cylinder Head Gasket (cont.)		Aluminum Cylinder Heads, (Contoured Combustion Chamber Openings) <i>Solicor, 9.8cc Combustion Chamber Volume, 4.166" Combustion Chamber Opening, .044" Compressed Operating Thickness</i>	54108SCR	2
Valve Cover Set		Except Buick/Dart Cylinder Heads <i>High Temperature Cork Rubber, 5/16" Thickness</i>	VS38110H	1
		Except Buick/Dart Cylinder Heads <i>High Temperature Cork Rubber, 5/32" Thickness</i>	VS38110HA	1
		Except Buick/Dart Cylinder Heads <i>High Temperature Tuff-Cork, 5/32" Thickness</i>	VS38110HTC	1
		Buick/Dart Cylinder Heads <i>Tuff-Cork</i>	VS38161TC	1
		Chevrolet 18 Degree And Brodix -12 Cylinder Heads <i>High Temperature Tuff-Cork, 5/16" Thickness</i>	VS50188HTC	1
		Splayed Valve General Motors <i>High Temperature Tuff-Cork, 5/16" Thickness</i>	VS50192HTC	1
Manifold Set, Intake		Small Race <i>Nitroseal, 1.31" x 2.16" Ports</i>	95005SG	1
		Stock And Small Race <i>Nitroseal, 1.28" x 2.09" Ports</i>	95070SG	1
		Stock And Small Race <i>Composition, 1.28" x 2.09" Ports</i>	95070SP	1
		Extra Large Race <i>Nitroseal, 1.38" x 2.38" Ports</i>	95111SG	1
		Large Race <i>Nitroseal, 1.38" x 2.28" Ports</i>	95112SG	1
		Medium Race <i>Nitroseal, 1.34" X 2.21" Ports</i>	95113SG	1
		Blocked Heat Crossover, Stock <i>Nitroseal, 1.23" x 1.99" Ports</i>	95128SG	1
		Open Heat Crossover, Stock <i>Nitroseal, 1.23" x 1.99" Ports</i>	95129SG	1
		Buick/Dart Cylinder Heads <i>Nitroseal, 1.38" x 1.85" To 1.66" x 3.03" Ports</i>	95130SG	1
		18 Degree Cylinder Heads, High Port <i>Composition, 1.25" x 2.15", .030" Thickness</i>	95165SP	1
		18 Degree Cylinder Heads, High Port <i>Composition, 1.25" x 2.15", .045" Thickness</i>	95166SP	1
		18 Degree Cylinder Heads, High Port <i>Composition, .060" Thick, 1.25" x 2.15"</i>	95167SP	1
		Splayed Valve General Motors <i>Nitroseal, 1.60" x 2.00" Port</i>	95169SG	1
		Splayed Valve General Motors <i>Composition, 1.60" x 2.00" Port</i>	95169SP	1
		Large Coolant Ports, (Trim To Fit, Gaskets Cutout For Brodix Water Fitting) <i>Nitroseal, 1/16" Thick, 1.25" x 1.90" To 1.40" x 2.30" Ports</i>	95189SG	1
		Large Coolant Ports, (Trim To Fit, Gaskets Cutout For Brodix Water Fitting) <i>Composition, 1/16" Thick, 1.25" x 1.90" To 1.40" x 2.30" Ports</i>	95189SP	1
		Small Coolant Ports, (Trim To Fit, Gaskets Cutout For Brodix Water Fitting) <i>Nitroseal, 1/16" Thick, 1.25" x 1.90" To 1.40" x 2.30" Ports</i>	95190SG	1
		Small Coolant Ports, (Trim To Fit, Gaskets Cutout For Brodix Water Fitting) <i>Composition, 1/16" Thick, 1.25" x 1.90" To 1.40" x 2.30" Ports</i>	95190SP	1
		Also Fits 867 Pontiac Head, High Port, (Trim To Fit, Gaskets Cutout For Brodix Water Fitting) <i>Nitroseal, 1/16" Thick, 1.31" x 2.02" Rectangular Ports</i>	95191SG	1
		Also Fits 867 Pontiac Head, High Port, (Trim To Fit, Gaskets Cutout For Brodix Water Fitting) <i>Composition, 1/16" Thick, 1.31" x 2.02" Rectangular Ports</i>	95191SP	1
	18 Degree Cylinder Heads, High Port <i>Composition, 1.25" x 2.15", .090" Thickness</i>	95192SP	1	
	18 Degree Cylinder Heads, High Port <i>Composition, .120" Thick, 1.25" x 2.15"</i>	95193SP	1	
	Small Coolant Ports, (Trim To Fit) <i>Composition, 1/8" Thick, 1.25" x 1.90" To 1.40" x 2.30" Ports</i>	95195SP	1	

PERFORMANCE

10 (cont.)	267 CID (4.4L) Chevrolet V8 Cyl, 3.500in./88.9mm (1979-1982)				10 (cont.)
----------------------	---	--	--	--	----------------------

Part	Year	VIN	Model/Application	Part Number	Qty.	
ENGINE GASKETS (cont.)						
Manifold Set, Intake (cont.)			Also Fits 867 Pontiac Head, High Port, (Trim To Fit) <i>Composition, 1/8" Thick, 1.31" x 2.02" Rectangular Ports</i>	95196SP	1	
			Buick/Dart Cylinder Heads <i>Composition, .060" Thick, 1.38" x 2.125" Ports</i>	95199SP	1	
			Buick/Dart Cylinder Heads <i>Composition, .120" Thick, 1.38" x 2.125" Ports</i>	95200SP	1	
Ex Header Gskt			<i>Nitroseal, 1.63" Round Ports</i>	95016SG	1	
			Large Race <i>Nitroseal, 1.55" x 1.63" Rectangular Port</i>	95065SG	1	
			<i>Nitroseal, 1.37" x 1.40" Rectangular Ports</i>	95090SG	1	
			Stock And Small Race <i>Nitroseal, 1.50" X 1.50" Square Ports</i>	95094SG	1	
			Hooker Headers, Stahl Headers <i>Nitroseal, 1.94" Round Ports</i>	95096SG	1	
			<i>Nitroseal, 1.55" x 1.63" D Shape Ports</i>	95098SG	1	
			Brodix, Split Ports <i>Nitroseal, 1.94" Round Ports</i>	95099SG	1	
			Hooker Headers <i>Nitroseal, 2.19" Round Ports</i>	95101SG	1	
			Buick/Dart Cylinder Heads <i>Nitroseal, 1.45" x 1.60" Rectangular Ports</i>	95131SG	1	
			Large Race <i>Nitroseal, 1.55" X 1.55" Square Ports</i>	95172SG	1	
			18 Degree Cylinder Heads <i>Nitroseal, 1.60" x 1.74" Rectangular Ports</i>	95173SG	1	
			18 Degree Adapter Plate <i>Nitroseal, 2.00" Round Ports</i>	95174SG	1	
			Splayed Valve General Motors <i>Nitroseal, 1.94" Round Ports</i>	95175SG	1	
	Oil Pan Set	1980-1982		Right Hand Dip Stick <i>Victo-Tech</i>	OS30568RRH	1
				Right Hand Dip Stick, (Contains 3/8" Thick Front End Strips) <i>Tuff-Cork</i>	OS30572TC	1
			High Performance Aftermarket "Bow Tie" Blocks Using 2 Piece Rear Main Seal, And No Dipstick, (Contains Gasket With Pre-inserted Grommets)	OS32174GR	1	
1979			Left Hand Dip Stick <i>Victo-Tech</i>	OS30568RLH	1	
			Left Hand Dip Stick, (Contains 3/8" Thick Front End Strips) <i>Tuff-Cork</i>	OS30568ZTC	1	
			Left Hand Dip Stick, (Contains Both 1/4" And 3/8" Thick Front End Strips, Special Construction Side Rails Trimmed For Rod Clearance) <i>Tuff-Cork</i>	OS32126TC	1	
Timing Cover Set		(Contains 3/8" Thick Front End Strips) <i>Tuff-Cork</i>	JV881TC	1		
Timing Cover Gasket			<i>Performaseal</i>	T27781VC	1	
			(Full Circle Design (Quick Change Timing Covers And Gear Drive)) <i>Performaseal</i>	T31488VC	1	
Dist. Mounting Gasket			<i>Performaseal</i>	B25934VC	1	
Fuel Pump Gasket			Plate To Block <i>Performaseal</i>	D25932VC	1	
			Pump To Plate <i>Performaseal</i>	D27094VC	1	
Water Outlet Gasket			(Aluminum Carrier With Rubber Bead)	C21331	1	
Water Pump Mount Gasket			<i>Performaseal</i>	K25935VC	2	

11	283 CID (4.6L) Chevrolet V8 Cyl, 3.875in./98.4mm (1957-1967)				11
	307 CID (5.0L) Chevrolet V8 Cyl, 3.875in./98.4mm (1968-1973)				

Part	Year	VIN	Model/Application	Part Number	Qty.
ENGINE GASKETS					
Cylinder Head Gasket			(Contoured Combustion Chamber Openings) <i>Nitroseal, 9.8cc Combustion Chamber Volume, 4.160" Combustion Chamber Opening, .045" Compressed Operating Thickness</i>	1178SG	2
			(Contoured Combustion Chamber Openings) <i>Stainless Steel, 4.1cc Combustion Chamber Volume, 4.100" Combustion Chamber Opening, .020" Compressed Operating Thickness</i>	1178SSB	2

PERFORMANCE

General Motors Corp.

11 (cont.)	283 CID (4.6L) Chevrolet V8 Cyl, 3.875in./98.4mm (1957-1967)	11 (cont.)
307 CID (5.0L) Chevrolet V8 Cyl, 3.875in./98.4mm (1968-1973)		

Part	Year	VIN	Model/Application	Part Number	Qty.
------	------	-----	-------------------	-------------	------

ENGINE GASKETS (cont.)

Cylinder Head Gasket (cont.)			Aluminum Cylinder Heads, (Contoured Combustion Chamber Openings) <i>Solicor, 9.8cc Combustion Chamber Volume, 4.166" Combustion Chamber Opening, .044" Compressed Operating Thickness</i>	54108SCR	2
Valve Cover Set			Except Buick/Dart Cylinder Heads <i>High Temperature Cork Rubber, 5/16" Thickness</i>	VS38110H	1
			Except Buick/Dart Cylinder Heads <i>High Temperature Cork Rubber, 5/32" Thickness</i>	VS38110HA	1
			Except Buick/Dart Cylinder Heads <i>High Temperature Tuff-Cork, 5/32" Thickness</i>	VS38110HTC	1
			Buick/Dart Cylinder Heads <i>Tuff-Cork</i>	VS38161TC	1
			Chevrolet 18 Degree And Brodix -12 Cylinder Heads <i>High Temperature Tuff-Cork, 5/16" Thickness</i>	VS50188HTC	1
			Splayed Valve General Motors <i>High Temperature Tuff-Cork, 5/16" Thickness</i>	VS50192HTC	1
	Manifold Set, Intake			Small Race <i>Nitroseal, 1.31" x 2.16" Ports</i>	95005SG
			Stock And Small Race <i>Nitroseal, 1.23" x 1.99" Ports</i>	95070SG	1
			Stock And Small Race <i>Composition, 1.28" x 2.09" Ports</i>	95070SP	1
			Extra Large Race <i>Nitroseal, 1.38" x 2.38" Ports</i>	95111SG	1
			Large Race <i>Nitroseal, 1.38" x 2.28" Ports</i>	95112SG	1
			Medium Race <i>Nitroseal, 1.34" X 2.21" Ports</i>	95113SG	1
			Blocked Heat Crossover, Stock <i>Nitroseal, 1.23" x 1.99" Ports</i>	95128SG	1
			Open Heat Crossover, Stock <i>Nitroseal, 1.23" x 1.99" Ports</i>	95129SG	1
			Buick/Dart Cylinder Heads <i>Nitroseal, 1.38" x 1.85" To 1.66" x 3.03" Ports</i>	95130SG	1
			18 Degree Cylinder Heads, High Port <i>Composition, 1.25" x 2.15", .030" Thickness</i>	95165SP	1
			18 Degree Cylinder Heads, High Port <i>Composition, 1.25" x 2.15", .045" Thickness</i>	95166SP	1
			18 Degree Cylinder Heads, High Port <i>Composition, .060" Thick, 1.25" x 2.15"</i>	95167SP	1
			Splayed Valve General Motors <i>Nitroseal, 1.60" x 2.00" Port</i>	95169SG	1
			Splayed Valve General Motors <i>Composition, 1.60" x 2.00" Port</i>	95169SP	1
			Large Coolant Ports, (Trim To Fit, Gaskets Cutout For Brodix Water Fitting) <i>Nitroseal, 1/16" Thick, 1.25" x 1.90" To 1.40" x 2.30" Ports</i>	95189SG	1
			Large Coolant Ports, (Trim To Fit, Gaskets Cutout For Brodix Water Fitting) <i>Composition, 1/16" Thick, 1.25" x 1.90" To 1.40" x 2.30" Ports</i>	95189SP	1
			Small Coolant Ports, (Trim To Fit, Gaskets Cutout For Brodix Water Fitting) <i>Nitroseal, 1/16" Thick, 1.25" x 1.90" To 1.40" x 2.30" Ports</i>	95190SG	1
			Small Coolant Ports, (Trim To Fit, Gaskets Cutout For Brodix Water Fitting) <i>Composition, 1/16" Thick, 1.25" x 1.90" To 1.40" x 2.30" Ports</i>	95190SP	1
			Also Fits 867 Pontiac Head, High Port, (Trim To Fit, Gaskets Cutout For Brodix Water Fitting) <i>Nitroseal, 1/16" Thick, 1.31" x 2.02" Rectangular Ports</i>	95191SG	1
			Also Fits 867 Pontiac Head, High Port, (Trim To Fit, Gaskets Cutout For Brodix Water Fitting) <i>Composition, 1/16" Thick, 1.31" x 2.02" Rectangular Ports</i>	95191SP	1
		18 Degree Cylinder Heads, High Port <i>Composition, 1.25" x 2.15", .090" Thickness</i>	95192SP	1	
		18 Degree Cylinder Heads, High Port <i>Composition, .120" Thick, 1.25" x 2.15"</i>	95193SP	1	

PERFORMANCE

11 (cont.)	283 CID (4.6L) Chevrolet V8 Cyl, 3.875in./98.4mm (1957-1967)	11 (cont.)
307 CID (5.0L) Chevrolet V8 Cyl, 3.875in./98.4mm (1968-1973)		

Part	Year	VIN	Model/Application	Part Number	Qty.
ENGINE GASKETS (cont.)					
Manifold Set, Intake (cont.)			Small Coolant Ports, (Trim To Fit) <i>Composition, 1/8" Thick, 1.25" x 1.90" To 1.40" x 2.30" Ports</i>	95195SP	1
			Also Fits 867 Pontiac Head, High Port, (Trim To Fit) <i>Composition, 1/8" Thick, 1.31" x 2.02" Rectangular Ports</i>	95196SP	1
			Buick/Dart Cylinder Heads <i>Composition, .060" Thick, 1.38" x 2.125" Ports</i>	95199SP	1
			Buick/Dart Cylinder Heads <i>Composition, .120" Thick, 1.38" x 2.125" Ports</i>	95200SP	1
Ex Header Gskt			<i>Nitroseal, 1.63" Round Ports</i>	95016SG	1
			Large Race <i>Nitroseal, 1.55" x 1.63" Rectangular Port</i>	95065SG	1
			<i>Nitroseal, 1.37" x 1.40" Rectangular Ports</i>	95090SG	1
			Stock And Small Race <i>Nitroseal, 1.50" X 1.50" Square Ports</i>	95094SG	1
			Hooker Headers, Stahl Headers <i>Nitroseal, 1.94" Round Ports</i>	95096SG	1
			<i>Nitroseal, 1.55" x 1.63" D Shape Ports</i>	95098SG	1
			Brodix, Split Ports <i>Nitroseal, 1.94" Round Ports</i>	95099SG	1
			Hooker Headers <i>Nitroseal, 2.19" Round Ports</i>	95101SG	1
			Buick/Dart Cylinder Heads <i>Nitroseal, 1.45" x 1.60" Rectangular Ports</i>	95131SG	1
			Large Race <i>Nitroseal, 1.55" X 1.55" Square Ports</i>	95172SG	1
			18 Degree Cylinder Heads <i>Nitroseal, 1.60" x 1.74" Rectangular Ports</i>	95173SG	1
			18 Degree Adapter Plate <i>Nitroseal, 2.00" Round Ports</i>	95174SG	1
			Splayed Valve General Motors <i>Nitroseal, 1.94" Round Ports</i>	95175SG	1
	Oil Pan Set			Left Hand Dip Stick, (Contains 1/4" Thick Front End Strips) <i>Tuff-Cork</i>	OS30568XTC
			Left Hand Dip Stick, (Contains Both 1/4" And 3/8" Thick Front End Strips, Special Construction Side Rails Trimmed For Rod Clearance) <i>Tuff-Cork</i>	OS32126TC	1
Timing Cover Set			(Contains 1/4" Thick Front End Strips) <i>Tuff-Cork</i>	JV779TC	1
Timing Cover Gasket	1959-1973		(Full Circle Design (Quick Change Timing Covers And Gear Drive)) <i>Performaseal</i>	T31488VC	1
			<i>Performaseal</i>	T27781VC	1
Dist. Mounting Gasket			<i>Performaseal</i>	B25934VC	1
Fuel Pump Gasket			Plate To Block <i>Performaseal</i>	D25932VC	1
			Pump To Plate <i>Performaseal</i>	D27094VC	1
Water Outlet Gasket			(Aluminum Carrier With Rubber Bead)	C21331	1
Water Pump Mount Gasket			<i>Performaseal</i>	K25935VC	2

12	302 CID (5.0L) Large Journal Chevrolet V8 Cyl, 4.000in./101.6mm (1968-1969)	12
302 CID (5.0L) Small Journal Chevrolet V8 Cyl, 4.000in./101.6mm (1967)		
327 CID (5.4L) Large Journal Chevrolet V8 Cyl, 4.000in./101.6mm (1968-1969)		
327 CID (5.4L) Small Journal Chevrolet V8 Cyl, 4.000in./101.6mm (1962-1967)		

Part	Year	VIN	Model/Application	Part Number	Qty.
ENGINE GASKETS					
Cylinder Head Gasket			(Cylindrical Combustion Chamber Openings, Gasket Has Steam Holes Required For Street Operation) <i>Solicor, 9.8cc Combustion Chamber Volume, 4.190" Combustion Chamber Opening, .044" Compressed Operating Thickness</i>	1178SCR	2
			(Contoured Combustion Chamber Openings) <i>Nitroseal, 9.8cc Combustion Chamber Volume, 4.160" Combustion Chamber Opening, .045" Compressed Operating Thickness</i>	1178SG	2

General Motors Corp.

12 (cont.)	302 CID (5.0L) Large Journal Chevrolet V8 Cyl, 4.000in./101.6mm (1968-1969)	12 (cont.)
	302 CID (5.0L) Small Journal Chevrolet V8 Cyl, 4.000in./101.6mm (1967)	
	327 CID (5.4L) Large Journal Chevrolet V8 Cyl, 4.000in./101.6mm (1968-1969)	
	327 CID (5.4L) Small Journal Chevrolet V8 Cyl, 4.000in./101.6mm (1962-1967)	

Part Year VIN Model/Application Part Number Qty.

ENGINE GASKETS (cont.)

Cylinder Head Gasket (cont.)	(Contoured Combustion Chamber Openings) <i>Stainless Steel, 4.1cc Combustion Chamber Volume, 4.100" Combustion Chamber Opening, .020" Compressed Operating Thickness</i>	1178SSB	2
	(Cylindrical Combustion Chamber Openings, Gasket Has Steam Holes Required For Street Operation) <i>Nitroseal, 10.0cc Combustion Chamber Volume, 4.190" Combustion Chamber Opening, .045" Compressed Operating Thickness</i>	3432SG	2
	(Cylindrical Combustion Chamber Openings, Gasket Has Steam Holes Required For Street Operation) <i>Stainless Steel, 8.8cc Combustion Chamber Volume, 4.190" Combustion Chamber Opening, .040" Compressed Operating Thickness</i>	3512	2
	<i>Nitroseal, 5.4cc Combustion Chamber Volume, 4.100" Combustion Chamber Opening, .026" Compressed Operating Thickness</i>	5746	2
	Aluminum Cylinder Heads, (Contoured Combustion Chamber Openings) <i>Solicor, 9.8cc Combustion Chamber Volume, 4.166" Combustion Chamber Opening, .044" Compressed Operating Thickness</i>	54108SCR	2
	<i>Multi-Layered Steel, 4.065" Combustion Chamber Opening, .040" Compressed Operating Thickness</i>	54256	2
	<i>Multi-Layered Steel, 4.125" Combustion Chamber Opening, .040" Compressed Operating Thickness</i>	54257	2
	<i>Multi-Layered Steel, 4.165" Combustion Chamber Opening, .040" Compressed Operating Thickness</i>	54258	2
	<i>Multi-Layered Steel, 4.200" Combustion Chamber Opening, .040" Compressed Operating Thickness</i>	54259	2
Valve Cover Set	Except Buick/Dart Cylinder Heads <i>High Temperature Cork Rubber, 5/16" Thickness</i>	VS38110H	1
	Except Buick/Dart Cylinder Heads <i>High Temperature Cork Rubber, 5/32" Thickness</i>	VS38110HA	1
	Except Buick/Dart Cylinder Heads <i>High Temperature Tuff-Cork, 5/32" Thickness</i>	VS38110HTC	1
	Buick/Dart Cylinder Heads <i>Tuff-Cork</i>	VS38161TC	1
	Chevrolet 18 Degree And Brodix -12 Cylinder Heads <i>High Temperature Tuff-Cork, 5/16" Thickness</i>	VS50188HTC	1
	Splayed Valve General Motors <i>High Temperature Tuff-Cork, 5/16" Thickness</i>	VS50192HTC	1
Manifold Set, Intake	Small Race <i>Nitroseal, 1.31" x 2.16" Ports</i>	95005SG	1
	Stock And Small Race <i>Nitroseal, 1.23" x 1.99" Ports</i>	95070SG	1
	Stock And Small Race <i>Composition, 1.28" x 2.09" Ports</i>	95070SP	1
	Extra Large Race <i>Nitroseal, 1.38" x 2.38" Ports</i>	95111SG	1
	Large Race <i>Nitroseal, 1.38" x 2.28" Ports</i>	95112SG	1
	Medium Race <i>Nitroseal, 1.34" X 2.21" Ports</i>	95113SG	1
	Blocked Heat Crossover, Stock <i>Nitroseal, 1.23" x 1.99" Ports</i>	95128SG	1
	Open Heat Crossover, Stock <i>Nitroseal, 1.23" x 1.99" Ports</i>	95129SG	1
	Buick/Dart Cylinder Heads <i>Nitroseal, 1.38" x 1.85" To 1.66" x 3.03" Ports</i>	95130SG	1
	18 Degree Cylinder Heads, High Port <i>Composition, 1.25" x 2.15", .030" Thickness</i>	95165SP	1
	18 Degree Cylinder Heads, High Port <i>Composition, 1.25" x 2.15", .045" Thickness</i>	95166SP	1
	18 Degree Cylinder Heads, High Port <i>Composition, .060" Thick, 1.25" x 2.15"</i>	95167SP	1
	Splayed Valve General Motors <i>Nitroseal, 1.60" x 2.00" Port</i>	95169SG	1

PERFORMANCE

12 <small>(cont.)</small>	302 CID (5.0L) Large Journal Chevrolet V8 Cyl, 4.000in./101.6mm (1968-1969)	12 <small>(cont.)</small>
	302 CID (5.0L) Small Journal Chevrolet V8 Cyl, 4.000in./101.6mm (1967)	
	327 CID (5.4L) Large Journal Chevrolet V8 Cyl, 4.000in./101.6mm (1968-1969)	
	327 CID (5.4L) Small Journal Chevrolet V8 Cyl, 4.000in./101.6mm (1962-1967)	

<i>Part</i>	<i>Year</i>	<i>VIN</i>	<i>Model/Application</i>	<i>Part Number</i>	<i>Qty.</i>	
ENGINE GASKETS (cont.)						
Manifold Set, Intake (cont.)			Splayed Valve General Motors <i>Composition, 1.60" x 2.00" Port</i>	95169SP	1	
			Large Coolant Ports, (Trim To Fit, Gaskets Cutout For Brodix Water Fitting) <i>Nitroseal, 1/16" Thick, 1.25" x 1.90" To 1.40" x 2.30" Ports</i>	95189SG	1	
			Large Coolant Ports, (Trim To Fit, Gaskets Cutout For Brodix Water Fitting) <i>Composition, 1/16" Thick, 1.25" x 1.90" To 1.40" x 2.30" Ports</i>	95189SP	1	
			Small Coolant Ports, (Trim To Fit, Gaskets Cutout For Brodix Water Fitting) <i>Nitroseal, 1/16" Thick, 1.25" x 1.90" To 1.40" x 2.30" Ports</i>	95190SG	1	
			Small Coolant Ports, (Trim To Fit, Gaskets Cutout For Brodix Water Fitting) <i>Composition, 1/16" Thick, 1.25" x 1.90" To 1.40" x 2.30" Ports</i>	95190SP	1	
			Also Fits 867 Pontiac Head, High Port, (Trim To Fit, Gaskets Cutout For Brodix Water Fitting) <i>Nitroseal, 1/16" Thick, 1.31" x 2.02" Rectangular Ports</i>	95191SG	1	
			Also Fits 867 Pontiac Head, High Port, (Trim To Fit, Gaskets Cutout For Brodix Water Fitting) <i>Composition, 1/16" Thick, 1.31" x 2.02" Rectangular Ports</i>	95191SP	1	
			18 Degree Cylinder Heads, High Port <i>Composition, 1.25" x 2.15", .090" Thickness</i>	95192SP	1	
			18 Degree Cylinder Heads, High Port <i>Composition, .120" Thick, 1.25" x 2.15"</i>	95193SP	1	
			Small Coolant Ports, (Trim To Fit) <i>Composition, 1/8" Thick, 1.25" x 1.90" To 1.40" x 2.30" Ports</i>	95195SP	1	
			Also Fits 867 Pontiac Head, High Port, (Trim To Fit) <i>Composition, 1/8" Thick, 1.31" x 2.02" Rectangular Ports</i>	95196SP	1	
			Buick/Dart Cylinder Heads <i>Composition, .060" Thick, 1.38" x 2.125" Ports</i>	95199SP	1	
			Buick/Dart Cylinder Heads <i>Composition, .120" Thick, 1.38" x 2.125" Ports</i>	95200SP	1	
	Ex Header Gskt			<i>Nitroseal, 1.63" Round Ports</i>	95016SG	1
				Large Race <i>Nitroseal, 1.55" x 1.63" Rectangular Port</i>	95065SG	1
			<i>Nitroseal, 1.37" x 1.40" Rectangular Ports</i>	95090SG	1	
			Stock And Small Race <i>Nitroseal, 1.50" X 1.50" Square Ports</i>	95094SG	1	
			Hooker Headers, Stahl Headers <i>Nitroseal, 1.94" Round Ports</i>	95096SG	1	
			<i>Nitroseal, 1.55" x 1.63" D Shape Ports</i>	95098SG	1	
			Brodix, Split Ports <i>Nitroseal, 1.94" Round Ports</i>	95099SG	1	
			Hooker Headers <i>Nitroseal, 2.19" Round Ports</i>	95101SG	1	
			Buick/Dart Cylinder Heads <i>Nitroseal, 1.45" x 1.60" Rectangular Ports</i>	95131SG	1	
			Large Race <i>Nitroseal, 1.55" X 1.55" Square Ports</i>	95172SG	1	
			18 Degree Cylinder Heads <i>Nitroseal, 1.60" x 1.74" Rectangular Ports</i>	95173SG	1	
			18 Degree Adapter Plate <i>Nitroseal, 2.00" Round Ports</i>	95174SG	1	
			Splayed Valve General Motors <i>Nitroseal, 1.94" Round Ports</i>	95175SG	1	
Oil Pan Set				Left Hand Dip Stick, (Contains 1/4" Thick Front End Strips) <i>Tuff-Cork</i>	OS30568XTC	1
				Left Hand Dip Stick, (Contains Both 1/4" And 3/8" Thick Front End Strips, Special Construction Side Rails Trimmed For Rod Clearance) <i>Tuff-Cork</i>	OS32126TC	1
Timing Cover Set		(Contains 1/4" Thick Front End Strips) <i>Tuff-Cork</i>	JV779TC	1		
Timing Cover Gasket			<i>Performaseal</i>	T27781VC	1	

General Motors Corp.

12 <small>(cont.)</small>	302 CID (5.0L) Large Journal Chevrolet V8 Cyl, 4.000in./101.6mm (1968-1969)	12 <small>(cont.)</small>
12 <small>(cont.)</small>	302 CID (5.0L) Small Journal Chevrolet V8 Cyl, 4.000in./101.6mm (1967)	12 <small>(cont.)</small>
12 <small>(cont.)</small>	327 CID (5.4L) Large Journal Chevrolet V8 Cyl, 4.000in./101.6mm (1968-1969)	12 <small>(cont.)</small>
12 <small>(cont.)</small>	327 CID (5.4L) Small Journal Chevrolet V8 Cyl, 4.000in./101.6mm (1962-1967)	12 <small>(cont.)</small>

Part	Year	VIN	Model/Application	Part Number	Qty.
ENGINE GASKETS (cont.)					
Timing Cover Gasket (cont.)			(Full Circle Design (Quick Change Timing Covers And Gear Drive))	<i>Performaseal</i> T31488VC	1
Dist. Mounting Gasket				<i>Performaseal</i> B25934VC	1
Fuel Pump Gasket			Plate To Block	<i>Performaseal</i> D25932VC	1
			Pump To Plate	<i>Performaseal</i> D27094VC	1
Water Outlet Gasket			(Aluminum Carrier With Rubber Bead)	C21331	1
Water Pump Mount Gasket				<i>Performaseal</i> K25935VC	2

13	305 CID (5.0L) Chevrolet V8 Cyl, 3.736in./95mm (1976-2001)	13
-----------	--	-----------

Part	Year	VIN	Model/Application	Part Number	Qty.
------	------	-----	-------------------	-------------	------

ENGINE GASKETS					
Full Set	1976-1985		(Contains Nitroseal Head Gasket)	FS3514SG	1
Cylinder Head Gasket			<i>Nitroseal, 8.4cc Combustion Chamber Volume, 3.840" Combustion Chamber Opening, .045" Compressed Operating Thickness</i>	3514SG	2
			Aluminum Cylinder Heads, (Contoured Combustion Chamber Openings) <i>Solicor, 9.8cc Combustion Chamber Volume, 4.166" Combustion Chamber Opening, .044" Compressed Operating Thickness</i>	54108SCR	2
Valve Cover Set			Buick/Dart Cylinder Heads <i>Tuff-Cork</i>	VS38161TC	1
			Chevrolet 18 Degree And Brodix -12 Cylinder Heads <i>High Temperature Tuff-Cork, 5/16" Thickness</i>	VS50188HTC	1
			Splayed Valve General Motors <i>High Temperature Tuff-Cork, 5/16" Thickness</i>	VS50192HTC	1
			Except Buick/Dart Cylinder Heads <i>High Temperature Cork Rubber, 5/16" Thickness</i>	VS38110H	1
			Except Buick/Dart Cylinder Heads <i>High Temperature Cork Rubber, 5/32" Thickness</i>	VS38110HA	1
			Except Buick/Dart Cylinder Heads <i>High Temperature Tuff-Cork, 5/32" Thickness</i>	VS38110HTC	1
Manifold Set, Intake			Small Race <i>Nitroseal, 1.31" x 2.16" Ports</i>	95005SG	1
			Stock And Small Race <i>Nitroseal, 1.28" x 2.09" Ports</i>	95070SG	1
			Stock And Small Race <i>Composition, 1.28" x 2.09" Ports</i>	95070SP	1
			Extra Large Race <i>Nitroseal, 1.38" x 2.38" Ports</i>	95111SG	1
			Large Race <i>Nitroseal, 1.38" x 2.28" Ports</i>	95112SG	1
			Medium Race <i>Nitroseal, 1.34" X 2.21" Ports</i>	95113SG	1
			Blocked Heat Crossover, Stock <i>Nitroseal, 1.23" x 1.99" Ports</i>	95128SG	1
			Open Heat Crossover, Stock <i>Nitroseal, 1.23" x 1.99" Ports</i>	95129SG	1
			Buick/Dart Cylinder Heads <i>Nitroseal, 1.38" x 1.85" To 1.66" x 3.03" Ports</i>	95130SG	1
			18 Degree Cylinder Heads, High Port <i>Composition, 1.25" x 2.15", .030" Thickness</i>	95165SP	1
			18 Degree Cylinder Heads, High Port <i>Composition, 1.25" x 2.15", .045" Thickness</i>	95166SP	1
			18 Degree Cylinder Heads, High Port <i>Composition, .060" Thick, 1.25" x 2.15"</i>	95167SP	1
			Splayed Valve General Motors <i>Nitroseal, 1.60" x 2.00" Port</i>	95169SG	1
			Splayed Valve General Motors <i>Composition, 1.60" x 2.00" Port</i>	95169SP	1
			Large Coolant Ports, (Trim To Fit, Gaskets Cutout For Brodix Water Fitting) <i>Nitroseal, 1/16" Thick, 1.25" x 1.90" To 1.40" x 2.30" Ports</i>	95189SG	1

PERFORMANCE

13 (cont.)	305 CID (5.0L) Chevrolet V8 Cyl, 3.736in./95mm (1976-2001)	13 (cont.)
----------------------	---	----------------------

Part	Year	VIN	Model/Application	Part Number	Qty.
------	------	-----	-------------------	-------------	------

ENGINE GASKETS (cont.)

Manifold Set, Intake (cont.)			Large Coolant Ports, (Trim To Fit, Gaskets Cutout For Brodix Water Fitting) <i>Composition, 1/16" Thick, 1.25" x 1.90" To 1.40" x 2.30" Ports</i>	95189SP	1	
			Small Coolant Ports, (Trim To Fit, Gaskets Cutout For Brodix Water Fitting) <i>Nitroseal, 1/16" Thick, 1.25" x 1.90" To 1.40" x 2.30" Ports</i>	95190SG	1	
			Small Coolant Ports, (Trim To Fit, Gaskets Cutout For Brodix Water Fitting) <i>Composition, 1/16" Thick, 1.25" x 1.90" To 1.40" x 2.30" Ports</i>	95190SP	1	
			Also Fits 867 Pontiac Head, High Port, (Trim To Fit, Gaskets Cutout For Brodix Water Fitting) <i>Nitroseal, 1/16" Thick, 1.31" x 2.02" Rectangular Ports</i>	95191SG	1	
			Also Fits 867 Pontiac Head, High Port, (Trim To Fit, Gaskets Cutout For Brodix Water Fitting) <i>Composition, 1/16" Thick, 1.31" x 2.02" Rectangular Ports</i>	95191SP	1	
			18 Degree Cylinder Heads, High Port <i>Composition, 1.25" x 2.15", .090" Thickness</i>	95192SP	1	
			18 Degree Cylinder Heads, High Port <i>Composition, .120" Thick, 1.25" x 2.15"</i>	95193SP	1	
			Small Coolant Ports, (Trim To Fit) <i>Composition, 1/8" Thick, 1.25" x 1.90" To 1.40" x 2.30" Ports</i>	95195SP	1	
			Also Fits 867 Pontiac Head, High Port, (Trim To Fit) <i>Composition, 1/8" Thick, 1.31" x 2.02" Rectangular Ports</i>	95196SP	1	
			Buick/Dart Cylinder Heads <i>Composition, .060" Thick, 1.38" x 2.125" Ports</i>	95199SP	1	
			Buick/Dart Cylinder Heads <i>Composition, .120" Thick, 1.38" x 2.125" Ports</i>	95200SP	1	
	Ex Header Gskt			<i>Nitroseal, 1.63" Round Ports</i>	95016SG	1
				Large Race <i>Nitroseal, 1.55" x 1.63" Rectangular Port</i>	95065SG	1
			<i>Nitroseal, 1.37" x 1.40" Rectangular Ports</i>	95090SG	1	
			Stock And Small Race <i>Nitroseal, 1.50" X 1.50" Square Ports</i>	95094SG	1	
			Hooker Headers, Stahl Headers <i>Nitroseal, 1.94" Round Ports</i>	95096SG	1	
			<i>Nitroseal, 1.55" x 1.63" D Shape Ports</i>	95098SG	1	
			Brodix, Split Ports <i>Nitroseal, 1.94" Round Ports</i>	95099SG	1	
			Hooker Headers <i>Nitroseal, 2.19" Round Ports</i>	95101SG	1	
			Buick/Dart Cylinder Heads <i>Nitroseal, 1.45" x 1.60" Rectangular Ports</i>	95131SG	1	
			Large Race <i>Nitroseal, 1.55" X 1.55" Square Ports</i>	95172SG	1	
			18 Degree Cylinder Heads <i>Nitroseal, 1.60" x 1.74" Rectangular Ports</i>	95173SG	1	
			18 Degree Adapter Plate <i>Nitroseal, 2.00" Round Ports</i>	95174SG	1	
			Splayed Valve General Motors <i>Nitroseal, 1.94" Round Ports</i>	95175SG	1	
Oil Pan Set		1986-2001		(Original Equipment Style Steel Backbone) <i>Victo-Tech</i>	OS32496B	1
				High Performance Aftermarket "Bow Tie" Blocks Using 2 Piece Rear Main Seal, And No Dipstick, (Contains Gasket With Pre-inserted Grommets)	OS32174GR	1
	1980-1985		Right Hand Dip Stick <i>Victo-Tech</i>	OS30568RRH	1	
			Right Hand Dip Stick, (Contains 3/8" Thick Front End Strips) <i>Tuff-Cork</i>	OS30572TC	1	
	1976-1979		Left Hand Dip Stick <i>Victo-Tech</i>	OS30568RLH	1	
			Left Hand Dip Stick, (Contains 3/8" Thick Front End Strips) <i>Tuff-Cork</i>	OS30568ZTC	1	
			Left Hand Dip Stick, (Contains Both 1/4" And 3/8" Thick Front End Strips, Special Construction Side Rails Trimmed For Rod Clearance) <i>Tuff-Cork</i>	OS32126TC	1	
Timing Cover Set	1976-1986		(Contains 3/8" Thick Front End Strips) <i>Tuff-Cork</i>	JV881TC	1	
Timing Cover Gasket	1976-1995		<i>Performaseal</i>	T27781VC	1	

PERFORMANCE

General Motors Corp.

13	305 CID (5.0L) Chevrolet V8 Cyl, 3.736in./95mm (1976-2001)	13
(cont.)		(cont.)

Part	Year	VIN	Model/Application	Part Number	Qty.
ENGINE GASKETS (cont.)					
Timing Cover Gasket (cont.)	1976-1985		(Full Circle Design (Quick Change Timing Covers And Gear Drive))	Performaseal T31488VC	1
Dist. Mounting Gasket	1976-1992			Performaseal B25934VC	1
Fuel Pump Gasket	1976-1988		Plate To Block	Performaseal D25932VC	1
			Pump To Plate	Performaseal D27094VC	1
Water Outlet Gasket	1976-1988		(Aluminum Carrier With Rubber Bead)	C21331	1
Water Pump Mount Gasket				Performaseal K25935VC	2

14	326 CID (5.3L) Pontiac V8 Cyl, 3.719in./94.5mm (1963-1967) 389 CID (6.4L) Pontiac V8 Cyl, 4.063in./103.2mm (1959-1966)	14
-----------	---	-----------

Part	Year	VIN	Model/Application	Part Number	Qty.
ENGINE GASKETS					
Manifold Set, Intake	1965-1967		Nitroseal, 1.18" x 2.20" Ports	95157SG	1
			Composition, 1.18" x 2.20" Ports	95157SP	1
Ex Header Gskt			(Split Center Ports)	Nitroseal 95038SG	1
			(Open Center Ports)	Nitroseal 95039SG	1
Timing Cover Gasket	1961-1967			Performaseal T27806VC	1
Water Pump Gasket	1965-1967		Late Design	Performaseal K27818VC	1
	1961-1965		Early Design	Performaseal K27540VC	1

15	346 CID (5.7L) Generation III Chevrolet V8 Cyl, 3.898in./99mm (1997-2003)	15
-----------	--	-----------

Part	Year	VIN	Model/Application	Part Number	Qty.
ENGINE GASKETS					
Cylinder Head Gasket			Multi-Layered Steel, 4.130" Combustion Chamber Opening, .054" Compressed Operating Thickness	54263	2
			Multi-Layered Steel, 4.160" Combustion Chamber Opening, .054" Compressed Operating Thickness	54264	2
			Multi-Layered Steel, 4.190" Combustion Chamber Opening, .054" Compressed Operating Thickness	54265	2

16	350 CID (5.7L) Oldsmobile V8 Cyl, 4.057in./103mm (1968-1980) 400 CID (6.6L) Oldsmobile V8 Cyl, 3.875in./98.4mm (1968-1969) 400 CID (6.6L) Oldsmobile V8 Cyl, 4.000in./101.6mm (1965-1967) 425 CID (7.0L) Oldsmobile V8 Cyl, 4.125in./104.8mm (1965-1967) 455 CID (7.5L) Oldsmobile V8 Cyl, 4.125in./104.8mm (1968-1976)	16
-----------	--	-----------

Part	Year	VIN	Model/Application	Part Number	Qty.
ENGINE GASKETS					
Valve Cover Set			High Temperature Cork Rubber	VS38305H	1
			Tuff-Cork	VS38305TC	1
Manifold Set, Intake	1965-1972			Nitroseal 95014SG	1
Ex Header Gskt	1965-1972			Nitroseal 95028SG	1
Timing Cover Gasket				Performaseal T27823VC	1
Water Pump Gasket			Air Conditioning, Heavy Duty Cooling	Performaseal K27156VC	1
			Except Air Conditioning, Except Heavy Duty Cooling	Performaseal K27821VC	1

17	350 CID (5.7L) Pontiac V8 Cyl, 3.875in./98.4mm (1968-1977)	17
-----------	---	-----------

Part	Year	VIN	Model/Application	Part Number	Qty.
ENGINE GASKETS					
Manifold Set, Intake			Nitroseal, 1.18" x 2.20" Ports	95157SG	1
			Composition, 1.18" x 2.20" Ports	95157SP	1
Ex Header Gskt			(Split Center Ports)	Nitroseal 95038SG	1

PERFORMANCE

17 350 CID (5.7L) Pontiac V8 Cyl, 3.875in./98.4mm (1968-1977) **17**
(cont.) (cont.)

Part	Year	VIN	Model/Application	Part Number	Qty.
ENGINE GASKETS (cont.)					
Ex Header Gskt (cont.)			(Open Center Ports) Nitroseal	95039SG	1
Timing Cover Gasket			Performaseal	T27812VC	1
Water Pump Gasket	1969-1977		Performaseal	K27149VC	1
	1968		Performaseal	K27818VC	1

18 350 CID (5.7L) Generation I Chevrolet V8 Cyl, 4.000in./101.6mm (1967-2001) **18**

Part	Year	VIN	Model/Application	Part Number	Qty.	
ENGINE GASKETS						
Full Set	1967-1985		(Contains Nitroseal Head Gasket)	FS1178SG	1	
Cylinder Head Gasket			(Cylindrical Combustion Chamber Openings, Gasket Has Steam Holes Required For Street Operation) <i>Solicor, 9.8cc Combustion Chamber Volume, 4.190" Combustion Chamber Opening, .044" Compressed Operating Thickness</i>	1178SCR	2	
			(Contoured Combustion Chamber Openings) <i>Nitroseal, 9.8cc Combustion Chamber Volume, 4.160" Combustion Chamber Opening, .045" Compressed Operating Thickness</i>	1178SG	2	
			(Contoured Combustion Chamber Openings) <i>Stainless Steel, 4.1cc Combustion Chamber Volume, 4.100" Combustion Chamber Opening, .020" Compressed Operating Thickness</i>	1178SSB	2	
			(Cylindrical Combustion Chamber Openings, Gasket Has Steam Holes Required For Street Operation) <i>Nitroseal, 10.0cc Combustion Chamber Volume, 4.190" Combustion Chamber Opening, .045" Compressed Operating Thickness</i>	3432SG	2	
			(Cylindrical Combustion Chamber Openings, Gasket Has Steam Holes Required For Street Operation) <i>Stainless Steel, 8.8cc Combustion Chamber Volume, 4.190" Combustion Chamber Opening, .040" Compressed Operating Thickness</i>	3512	2	
			<i>Nitroseal, 5.4cc Combustion Chamber Volume, 4.100" Combustion Chamber Opening, .026" Compressed Operating Thickness</i>	5746	2	
			Aluminum Cylinder Heads, (Contoured Combustion Chamber Openings) <i>Solicor, 9.8cc Combustion Chamber Volume, 4.166" Combustion Chamber Opening, .044" Compressed Operating Thickness</i>	54108SCR	2	
			<i>Multi-Layered Steel, 4.065" Combustion Chamber Opening, .040" Compressed Operating Thickness</i>	54256	2	
			<i>Multi-Layered Steel, 4.125" Combustion Chamber Opening, .040" Compressed Operating Thickness</i>	54257	2	
			<i>Multi-Layered Steel, 4.165" Combustion Chamber Opening, .040" Compressed Operating Thickness</i>	54258	2	
			<i>Multi-Layered Steel, 4.200" Combustion Chamber Opening, .040" Compressed Operating Thickness</i>	54259	2	
	Valve Cover Set			Buick/Dart Cylinder Heads Tuff-Cork	VS38161TC	1
				Chevrolet 18 Degree And Brodix -12 Cylinder Heads <i>High Temperature Tuff-Cork, 5/16" Thickness</i>	VS50188HTC	1
			Splayed Valve General Motors <i>High Temperature Tuff-Cork, 5/16" Thickness</i>	VS50192HTC	1	
			Except Buick/Dart Cylinder Heads <i>High Temperature Cork Rubber, 5/16" Thickness</i>	VS38110H	1	
			Except Buick/Dart Cylinder Heads <i>High Temperature Cork Rubber, 5/32" Thickness</i>	VS38110HA	1	
			Except Buick/Dart Cylinder Heads <i>High Temperature Tuff-Cork, 5/32" Thickness</i>	VS38110HTC	1	
Manifold Set, Intake			Small Race Nitroseal, 1.31" x 2.16" Ports	95005SG	1	
			Stock And Small Race Nitroseal, 1.28" x 2.09" Ports	95070SG	1	
			Stock And Small Race Composition, 1.28" x 2.09" Ports	95070SP	1	
			Extra Large Race Nitroseal, 1.38" x 2.38" Ports	95111SG	1	

PERFORMANCE

General Motors Corp.

18 350 CID (5.7L) Generation I Chevrolet V8 Cyl, 4.000in./101.6mm (1967-2001) **18**
 (cont.) (cont.)

Part	Year	VIN	Model/Application	Part Number	Qty.	
ENGINE GASKETS (cont.)						
Manifold Set, Intake (cont.)			Large Race <i>Nitroseal, 1.38" x 2.28" Ports</i>	95112SG	1	
			Medium Race <i>Nitroseal, 1.34" X 2.21" Ports</i>	95113SG	1	
			Blocked Heat Crossover, Stock <i>Nitroseal, 1.23" x 1.99" Ports</i>	95128SG	1	
			Open Heat Crossover, Stock <i>Nitroseal, 1.23" x 1.99" Ports</i>	95129SG	1	
			Buick/Dart Cylinder Heads <i>Nitroseal, 1.38" x 1.85" To 1.66" x 3.03" Ports</i>	95130SG	1	
			18 Degree Cylinder Heads, High Port <i>Composition, 1.25" x 2.15", .030" Thickness</i>	95165SP	1	
			18 Degree Cylinder Heads, High Port <i>Composition, 1.25" x 2.15", .045" Thickness</i>	95166SP	1	
			18 Degree Cylinder Heads, High Port <i>Composition, .060" Thick, 1.25" x 2.15"</i>	95167SP	1	
			Splayed Valve General Motors <i>Nitroseal, 1.60" x 2.00" Port</i>	95169SG	1	
			Splayed Valve General Motors <i>Composition, 1.60" x 2.00" Port</i>	95169SP	1	
			Large Coolant Ports, (Trim To Fit, Gaskets Cutout For Brodix Water Fitting) <i>Nitroseal, 1/16" Thick, 1.25" x 1.90" To 1.40" x 2.30" Ports</i>	95189SG	1	
			Large Coolant Ports, (Trim To Fit, Gaskets Cutout For Brodix Water Fitting) <i>Composition, 1/16" Thick, 1.25" x 1.90" To 1.40" x 2.30" Ports</i>	95189SP	1	
			Small Coolant Ports, (Trim To Fit, Gaskets Cutout For Brodix Water Fitting) <i>Nitroseal, 1/16" Thick, 1.25" x 1.90" To 1.40" x 2.30" Ports</i>	95190SG	1	
			Small Coolant Ports, (Trim To Fit, Gaskets Cutout For Brodix Water Fitting) <i>Composition, 1/16" Thick, 1.25" x 1.90" To 1.40" x 2.30" Ports</i>	95190SP	1	
			Also Fits 867 Pontiac Head, High Port, (Trim To Fit, Gaskets Cutout For Brodix Water Fitting) <i>Nitroseal, 1/16" Thick, 1.31" x 2.02" Rectangular Ports</i>	95191SG	1	
			Also Fits 867 Pontiac Head, High Port, (Trim To Fit, Gaskets Cutout For Brodix Water Fitting) <i>Composition, 1/16" Thick, 1.31" x 2.02" Rectangular Ports</i>	95191SP	1	
			18 Degree Cylinder Heads, High Port <i>Composition, 1.25" x 2.15", .090" Thickness</i>	95192SP	1	
			18 Degree Cylinder Heads, High Port <i>Composition, .120" Thick, 1.25" x 2.15"</i>	95193SP	1	
			Small Coolant Ports, (Trim To Fit) <i>Composition, 1/8" Thick, 1.25" x 1.90" To 1.40" x 2.30" Ports</i>	95195SP	1	
			Also Fits 867 Pontiac Head, High Port, (Trim To Fit) <i>Composition, 1/8" Thick, 1.31" x 2.02" Rectangular Ports</i>	95196SP	1	
			Buick/Dart Cylinder Heads <i>Composition, .060" Thick, 1.38" x 2.125" Ports</i>	95199SP	1	
			Buick/Dart Cylinder Heads <i>Composition, .120" Thick, 1.38" x 2.125" Ports</i>	95200SP	1	
	Ex Header Gskt			<i>Nitroseal, 1.63" Round Ports</i>	95016SG	1
				Large Race <i>Nitroseal, 1.55" x 1.63" Rectangular Port</i>	95065SG	1
				<i>Nitroseal, 1.37" x 1.40" Rectangular Ports</i>	95090SG	1
				Stock And Small Race <i>Nitroseal, 1.50" X 1.50" Square Ports</i>	95094SG	1
				Hooker Headers, Stahl Headers <i>Nitroseal, 1.94" Round Ports</i>	95096SG	1
				<i>Nitroseal, 1.55" x 1.63" D Shape Ports</i>	95098SG	1
			Brodix, Split Ports <i>Nitroseal, 1.94" Round Ports</i>	95099SG	1	
			Hooker Headers <i>Nitroseal, 2.19" Round Ports</i>	95101SG	1	
			Buick/Dart Cylinder Heads <i>Nitroseal, 1.45" x 1.60" Rectangular Ports</i>	95131SG	1	

PERFORMANCE

18 350 CID (5.7L) Generation I Chevrolet V8 Cyl, 4.000in./101.6mm (1967-2001) **18**
(cont.) (cont.)

Part	Year	VIN	Model/Application	Part Number	Qty.
ENGINE GASKETS (cont.)					
Ex Header Gskt (cont.)			Large Race Nitroseal, 1.55" X 1.55" Square Ports	95172SG	1
			18 Degree Cylinder Heads Nitroseal, 1.60" x 1.74" Rectangular Ports	95173SG	1
			18 Degree Adapter Plate Nitroseal, 2.00" Round Ports	95174SG	1
			Splayed Valve General Motors Nitroseal, 1.94" Round Ports	95175SG	1
Oil Pan Set	1986-2001		(Original Equipment Style Steel Backbone) Victo-Tech	OS32496B	1
			High Performance Aftermarket "Bow Tie" Blocks Using 2 Piece Rear Main Seal, And No Dipstick, (Contains Gasket With Pre-inserted Grommets)	OS32174GR	1
	1980-1985		Right Hand Dip Stick Victo-Tech	OS30568RRH	1
			Right Hand Dip Stick, (Contains 3/8" Thick Front End Strips) Tuff-Cork	OS30572TC	1
	1975-1979		Left Hand Dip Stick Victo-Tech	OS30568RLH	1
			Left Hand Dip Stick, (Contains 3/8" Thick Front End Strips) Tuff-Cork	OS30568ZTC	1
	1967-1979		Left Hand Dip Stick, (Contains Both 1/4" And 3/8" Thick Front End Strips, Special Construction Side Rails Trimmed For Rod Clearance) Tuff-Cork	OS32126TC	1
1967-1974		Left Hand Dip Stick, (Contains 1/4" Thick Front End Strips) Tuff-Cork	OS30568XTC	1	
Timing Cover Set	1975-1986		(Contains 3/8" Thick Front End Strips) Tuff-Cork	JV881TC	1
	1967-1974		(Contains 1/4" Thick Front End Strips) Tuff-Cork	JV779TC	1
Timing Cover Gasket	1967-1995		Performaseal	T27781VC	1
	1967-1985		(Full Circle Design (Quick Change Timing Covers And Gear Drive)) Performaseal	T31488VC	1
Dist. Mounting Gasket	1967-1992		Performaseal	B25934VC	1
Fuel Pump Gasket	1967-1988		Plate To Block Performaseal	D25932VC	1
			Pump To Plate Performaseal	D27094VC	1
Water Outlet Gasket	1967-1988		(Aluminum Carrier With Rubber Bead)	C21331	1
Water Pump Mount Gasket			Performaseal	K25935VC	2

19 350 CID (5.7L) Generation II Chevrolet V8 Cyl, 4.000in./101.6mm (1992-1997) **19**

Part	Year	VIN	Model/Application	Part Number	Qty.
ENGINE GASKETS					
Cylinder Head Gasket			Except LT4 Nitroseal, 5.4cc Combustion Chamber Volume, 4.100" Combustion Chamber Opening, .026" Compressed Operating Thickness	5898	2
			LT4 Nitroseal, 10.4cc Combustion Chamber Volume, 4.120" Combustion Chamber Opening, .046" Compressed Operating Thickness	5930	2
Oil Pan Set			(Original Equipment Style Steel Backbone) Victo-Tech	OS32496B	1

20 356 CID (5.8L) Batten Oldsmobile V8 Cyl, 4.057in./103mm (1978-1985) **20**

Part	Year	VIN	Model/Application	Part Number	Qty.
ENGINE GASKETS					
Cylinder Head Gasket			Solicor, 10.0cc Combustion Chamber Volume, 4.130" Combustion Chamber Opening, .047" Compressed Operating Thickness	3685SCR	2
			.010" Thicker And .030" Overbore Cylinder Head Gasket Nitroseal, 11.8cc Combustion Chamber Volume, 4.185" Combustion Chamber Opening, .057" Compressed Operating Thickness	3736	2
Valve Cover Set			High Temperature Cork Rubber	VS38305H	1
			Tuff-Cork	VS38305TC	1
Manifold Set, Intake			Nitroseal, 1.37" x 2.23" Ports	95120SG	1
Ex Header Gskt			Nitroseal, 2.27" Round Ports	95121SG	1

General Motors Corp.

20 (cont.)	356 CID (5.8L) Batten Oldsmobile V8 Cyl, 4.057in./103mm (1978-1985)					20 (cont.)
----------------------	--	--	--	--	--	----------------------

Part	Year	VIN	Model/Application	Part Number	Qty.
ENGINE GASKETS (cont.)					
Oil Pan Set			Tuff-Cork	OS30534TC	1
Timing Cover Gasket			Performaseal	T27823VC	1
Fuel Pump Gasket			Tuff-Cork	D26606TC	1
Water Pump Mount Gasket			Performaseal	K27156VC	1

21	396 CID (6.6L) Chevrolet V8 Cyl, 4.094in./104mm (1965-1970)					21
	402 CID (6.6L) Chevrolet V8 Cyl, 4.125in./104.8mm (1970-1972)					
	427 CID (7.0L) Chevrolet V8 Cyl, 4.250in./108mm (1966-1990)					

Part	Year	VIN	Model/Application	Part Number	Qty.
------	------	-----	-------------------	-------------	------

ENGINE GASKETS

Cylinder Head Gasket	(Has Contoured Combustion Chamber Flanges For Open Chamber Head) <i>Nitroseal, 11.5cc Combustion Chamber Volume, 4.520" Combustion Chamber Opening, .045" Compressed Operating Thickness</i>	3884SG	2
	Mark V Engine, (Stainless Steel Core, Stainless Steel Flanges) <i>Nitroseal, 11.0cc Combustion Chamber Volume, 4.578" Combustion Chamber Opening, .042" Compressed Operating Thickness</i>	4886	2
	Extra Large Bore Engines, But Not Recommended for 4.625" Or Larger Bore <i>Solicor, 11.2cc Combustion Chamber Volume, 4.630" Combustion Chamber Opening, .042" Compressed Operating Thickness</i>	5946SC	2
	<i>Solicor, 10.0cc Combustion Chamber Volume, 4.370" Combustion Chamber Opening, .042" Compressed Operating Thickness</i>	5950SC	2
	Extra Large Bore Engines, But Not Recommended for 4.625" Or Larger Bore, Mark V Engine <i>Solicor, 11.2cc Combustion Chamber Volume, 4.630" Combustion Chamber Opening, .042" Compressed Operating Thickness</i>	54228SC	2
	(Head Gasket Has 2 Coolant Holes On Each End And 3 Lower Open Coolant Holes) <i>Multi-Layered Steel, 4.375" Combustion Chamber Opening, .040" Compressed Operating Thickness</i>	54266	2
	(Head Gasket Has 2 Coolant Holes On Each End And 3 Lower Open Coolant Holes) <i>Multi-Layered Steel, 4.540" Combustion Chamber Opening, .040" Compressed Operating Thickness</i>	54267	2
	(Head Gasket Has 2 Coolant Holes On Each End And 3 Lower Open Coolant Holes) <i>Multi-Layered Steel, 4.630" Combustion Chamber Opening, .040" Compressed Operating Thickness</i>	54268	2
Valve Cover Set	Except Super Duty Pontiac/Brodix Head/Dart Big Chief <i>High Temperature Cork Rubber</i>	VS38420H	1
	Except Super Duty Pontiac/Brodix Head/Dart Big Chief <i>Tuff-Cork</i>	VS38420TC	1
	Except Super Duty Pontiac/Brodix Head/Dart Big Chief <i>Victo-Tech</i>	VS50169	1
	Super Duty Pontiac/Brodix Head/Dart Big Chief <i>High Temperature Tuff-Cork</i>	VS50191HTC	1
Manifold Set, Intake	Blocked Heat Crossover, Except Super Duty Pontiac/Brodix Head/Dart Big Chief <i>Nitroseal, 1.84" x 2.05" Oval Ports</i>	95007SG	1
	Blocked Heat Crossover, Except Super Duty Pontiac/Dart Big Chief <i>Nitroseal, 1.80" x 2.52" Rectangular Ports</i>	95008SG	1
	Except Super Duty Pontiac/Brodix Head/Dart Big Chief, Open Heat Crossover <i>Nitroseal, 1.84" x 2.05" Oval Ports</i>	95132SG	1
	Super Duty Pontiac/Brodix Head, (Trim To Fit) <i>Nitroseal, 1.90" x 2.70" Ports</i>	95161SG	1

21 (cont.)	396 CID (6.6L) Chevrolet V8 Cyl, 4.094in./104mm (1965-1970)	21 (cont.)
	402 CID (6.6L) Chevrolet V8 Cyl, 4.125in./104.8mm (1970-1972)	
	427 CID (7.0L) Chevrolet V8 Cyl, 4.250in./108mm (1966-1990)	

Part	Year	VIN	Model/Application	Part Number	Qty.
ENGINE GASKETS (cont.)					
Manifold Set, Intake (cont.)			Super Duty Pontiac/Brodix Head, (Trim To Fit) <i>Composition, 1.90" x 2.70" Ports</i>	95161SP	1
			Except Super Duty Pontiac/Dart Big Chief, (Trim To Fit, Does Not Have Top Bolt Hole Between Siamesed Intake Ports) <i>Nitroseal, 1.64" x 2.36" Ports</i>	95162SG	1
			Except Super Duty Pontiac/Dart Big Chief, (Trim To Fit, Does Not Have Top Bolt Hole Between Siamesed Intake Ports) <i>Composition, 1.64" x 2.36" Ports</i>	95162SP	1
			Except Super Duty Pontiac/Dart Big Chief, Open Heat Crossover <i>Nitroseal, 1.80" x 2.52" Rectangular Ports</i>	95163SG	1
			Except Super Duty Pontiac/Dart Big Chief, Open Heat Crossover <i>Composition, 1.80" x 2.52" Rectangular Ports</i>	95163SP	1
			(No Bolt Holes Or Ports (Universal Trim To Fit)) <i>Composition</i>	95168SP	1
			Dart "Big Chief" <i>Nitroseal, 1.86" x 2.46" Ports</i>	95170SG	1
			Dart "Big Chief" <i>Composition, 1.86" x 2.46" Ports</i>	95170SP	1
Ex Header Gskt			Stock Aluminum Heads <i>Nitroseal, 1.87" Round Ports</i>	95020SG	1
			<i>Nitroseal, 1.82" x 1.88" Stock Ports</i>	95021SG	1
			<i>Nitroseal, 2.12" x 2.12" Square Ports</i>	95022SG	1
			<i>Nitroseal, 2.13" Round Ports</i>	95100SG	1
Oil Pan Set			<i>Tuff-Cork</i>	OS30931XTC	1
			(Special Construction Side Rails Trimmed For Rod Clearance) <i>Tuff-Cork</i>	OS32123TC	1
Timing Cover Set			<i>Tuff-Cork</i>	JV866TC	1
Timing Cover Gasket			<i>Performaseal</i>	T27119VC	1
Dist. Mounting Gasket			<i>Performaseal</i>	B25934VC	1
Fuel Pump Gasket			<i>Performaseal</i>	D27094VC	1
Water Outlet Gasket			(Aluminum Carrier With Rubber Bead)	C21331	1
Water Pump Mount Gasket			<i>Performaseal</i>	K26632VC	2

22	400 CID (6.6L) Chevrolet V8 Cyl, 4.125in./104.8mm (1970-1980)	22
-----------	--	-----------

Part	Year	VIN	Model/Application	Part Number	Qty.
ENGINE GASKETS					
Cylinder Head Gasket			(Cylindrical Combustion Chamber Openings, Gasket Has Steam Holes Required For Street Operation) <i>Solicor, 9.8cc Combustion Chamber Volume, 4.190"</i> <i>Combustion Chamber Opening, .044" Compressed</i> <i>Operating Thickness</i>	1178SCR	2
			(Cylindrical Combustion Chamber Openings, Gasket Has Steam Holes Required For Street Operation) <i>Nitroseal, 10.0cc Combustion Chamber Volume, 4.190"</i> <i>Combustion Chamber Opening, .045" Compressed</i> <i>Operating Thickness</i>	3432SG	2
			(Cylindrical Combustion Chamber Openings, Gasket Has Steam Holes Required For Street Operation) <i>Stainless Steel, 8.8cc Combustion Chamber Volume, 4.190"</i> <i>Combustion Chamber Opening, .040" Compressed</i> <i>Operating Thickness</i>	3512	1
			(Gasket Does Not Have Steam Holes Required For Street Operation) <i>Solicor, 9.3cc Combustion Chamber Volume, 4.220"</i> <i>Combustion Chamber Opening, .042" Compressed</i> <i>Operating Thickness</i>	5944SC	2
			(Gasket Has Steam Holes Required For Street Operation) <i>Solicor, 9.3cc Combustion Chamber Volume, 4.220"</i> <i>Combustion Chamber Opening, .042" Compressed</i> <i>Operating Thickness</i>	5945SC	2

General Motors Corp.

22 (cont.)	400 CID (6.6L) Chevrolet V8 Cyl, 4.125in./104.8mm (1970-1980)	22 (cont.)
----------------------	--	----------------------

Part	Year	VIN	Model/Application	Part Number	Qty.
------	------	-----	-------------------	-------------	------

ENGINE GASKETS (cont.)

Cylinder Head Gasket (cont.)		4.155" Maximum Bore With Minimal Chamfer, Aluminum Cylinder Heads, (Contoured Combustion Chamber Openings, Gasket Does Not Have Steam Holes Required For Street Operation) <i>Solicor, 9.8cc Combustion Chamber Volume, 4.166" Combustion Chamber Opening, .044" Compressed Operating Thickness</i>	54108SCR	2
		(Gasket Has Steam Holes Required For Street Operation) <i>Multi-Layered Steel, 4.065" Combustion Chamber Opening, .040" Compressed Operating Thickness</i>	54256	2
		(Gasket Has Steam Holes Required For Street Operation) <i>Multi-Layered Steel, 4.125" Combustion Chamber Opening, .040" Compressed Operating Thickness</i>	54257	2
		(Gasket Has Steam Holes Required For Street Operation) <i>Multi-Layered Steel, 4.165" Combustion Chamber Opening, .040" Compressed Operating Thickness</i>	54258	2
		(Gasket Has Steam Holes Required For Street Operation) <i>Multi-Layered Steel, 4.200" Combustion Chamber Opening, .040" Compressed Operating Thickness</i>	54259	2
Valve Cover Set		Except Buick/Dart Cylinder Heads <i>High Temperature Cork Rubber, 5/16" Thickness</i>	VS38110H	1
		Except Buick/Dart Cylinder Heads <i>High Temperature Cork Rubber, 5/32" Thickness</i>	VS38110HA	1
		Except Buick/Dart Cylinder Heads <i>High Temperature Tuff-Cork, 5/32" Thickness</i>	VS38110HTC	1
		Buick/Dart Cylinder Heads <i>Tuff-Cork</i>	VS38161TC	1
		Chevrolet 18 Degree And Brodix -12 Cylinder Heads <i>High Temperature Tuff-Cork, 5/16" Thickness</i>	VS50188HTC	1
		Splayed Valve General Motors <i>High Temperature Tuff-Cork, 5/16" Thickness</i>	VS50192HTC	1
Manifold Set, Intake		Small Race <i>Nitroseal, 1.31" x 2.16" Ports</i>	95005SG	1
		Stock And Small Race <i>Nitroseal, 1.23" x 1.99" Ports</i>	95070SG	1
		Stock And Small Race <i>Composition, 1.28" x 2.09" Ports</i>	95070SP	1
		Extra Large Race <i>Nitroseal, 1.38" x 2.38" Ports</i>	95111SG	1
		Large Race <i>Nitroseal, 1.38" x 2.28" Ports</i>	95112SG	1
		Medium Race <i>Nitroseal, 1.34" X 2.21" Ports</i>	95113SG	1
		Blocked Heat Crossover, Stock <i>Nitroseal, 1.23" x 1.99" Ports</i>	95128SG	1
		Open Heat Crossover, Stock <i>Nitroseal, 1.23" x 1.99" Ports</i>	95129SG	1
		Buick/Dart Cylinder Heads <i>Nitroseal, 1.38" x 1.85" To 1.66" x 3.03" Ports</i>	95130SG	1
		18 Degree Cylinder Heads, High Port <i>Composition, 1.25" x 2.15", .030" Thickness</i>	95165SP	1
		18 Degree Cylinder Heads, High Port <i>Composition, 1.25" x 2.15", .045" Thickness</i>	95166SP	1
		18 Degree Cylinder Heads, High Port <i>Composition, .060" Thick, 1.25" x 2.15"</i>	95167SP	1
		Splayed Valve General Motors <i>Nitroseal, 1.60" x 2.00" Port</i>	95169SG	1
		Splayed Valve General Motors <i>Composition, 1.60" x 2.00" Port</i>	95169SP	1
		Large Coolant Ports, (Trim To Fit, Gaskets Cutout For Brodix Water Fitting) <i>Nitroseal, 1/16" Thick, 1.25" x 1.90" To 1.40" x 2.30" Ports</i>	95189SG	1
		Large Coolant Ports, (Trim To Fit, Gaskets Cutout For Brodix Water Fitting) <i>Composition, 1/16" Thick, 1.25" x 1.90" To 1.40" x 2.30" Ports</i>	95189SP	1
	Small Coolant Ports, (Trim To Fit, Gaskets Cutout For Brodix Water Fitting) <i>Nitroseal, 1/16" Thick, 1.25" x 1.90" To 1.40" x 2.30" Ports</i>	95190SG	1	

22 (cont.)	400 CID (6.6L) Chevrolet V8 Cyl, 4.125in./104.8mm (1970-1980)				22 (cont.)
----------------------	--	--	--	--	----------------------

Part	Year	VIN	Model/Application	Part Number	Qty.
------	------	-----	-------------------	-------------	------

ENGINE GASKETS (cont.)

Manifold Set, Intake (cont.)			Small Coolant Ports, (Trim To Fit, Gaskets Cutout For Brodix Water Fitting) <i>Composition, 1/16" Thick, 1.25" x 1.90" To 1.40" x 2.30" Ports</i>	95190SP	1	
			Also Fits 867 Pontiac Head, High Port, (Trim To Fit, Gaskets Cutout For Brodix Water Fitting) <i>Nitroseal, 1/16" Thick, 1.31" x 2.02" Rectangular Ports</i>	95191SG	1	
			Also Fits 867 Pontiac Head, High Port, (Trim To Fit, Gaskets Cutout For Brodix Water Fitting) <i>Composition, 1/16" Thick, 1.31" x 2.02" Rectangular Ports</i>	95191SP	1	
			18 Degree Cylinder Heads, High Port <i>Composition, 1.25" x 2.15", .090" Thickness</i>	95192SP	1	
			18 Degree Cylinder Heads, High Port <i>Composition, .120" Thick, 1.25" x 2.15"</i>	95193SP	1	
			Small Coolant Ports, (Trim To Fit) <i>Composition, 1/8" Thick, 1.25" x 1.90" To 1.40" x 2.30" Ports</i>	95195SP	1	
			Also Fits 867 Pontiac Head, High Port, (Trim To Fit) <i>Composition, 1/8" Thick, 1.31" x 2.02" Rectangular Ports</i>	95196SP	1	
			Buick/Dart Cylinder Heads <i>Composition, .060" Thick, 1.38" x 2.125" Ports</i>	95199SP	1	
			Buick/Dart Cylinder Heads <i>Composition, .120" Thick, 1.38" x 2.125" Ports</i>	95200SP	1	
	Ex Header Gskt			<i>Nitroseal, 1.63" Round Ports</i>	95016SG	1
			Large Race <i>Nitroseal, 1.55" x 1.63" Rectangular Port</i>	95065SG	1	
			<i>Nitroseal, 1.37" x 1.40" Rectangular Ports</i>	95090SG	1	
			Stock And Small Race <i>Nitroseal, 1.50" X 1.50" Square Ports</i>	95094SG	1	
			Hooker Headers, Stahl Headers <i>Nitroseal, 1.94" Round Ports</i>	95096SG	1	
			<i>Nitroseal, 1.55" x 1.63" D Shape Ports</i>	95098SG	1	
			Brodix, Split Ports <i>Nitroseal, 1.94" Round Ports</i>	95099SG	1	
			Hooker Headers <i>Nitroseal, 2.19" Round Ports</i>	95101SG	1	
			Buick/Dart Cylinder Heads <i>Nitroseal, 1.45" x 1.60" Rectangular Ports</i>	95131SG	1	
			Large Race <i>Nitroseal, 1.55" X 1.55" Square Ports</i>	95172SG	1	
			18 Degree Cylinder Heads <i>Nitroseal, 1.60" x 1.74" Rectangular Ports</i>	95173SG	1	
			18 Degree Adapter Plate <i>Nitroseal, 2.00" Round Ports</i>	95174SG	1	
			Splayed Valve General Motors <i>Nitroseal, 1.94" Round Ports</i>	95175SG	1	
Oil Pan Set		1975-1980		Left Hand Dip Stick <i>Victo-Tech</i>	OS30568RLH	1
				Left Hand Dip Stick, (Contains 3/8" Thick Front End Strips) <i>Tuff-Cork</i>	OS30568ZTC	1
			Left Hand Dip Stick, (Contains Both 1/4" And 3/8" Thick Front End Strips, Special Construction Side Rails Trimmed For Rod Clearance) <i>Tuff-Cork</i>	OS32126TC	1	
	1970-1974		Left Hand Dip Stick, (Contains 1/4" Thick Front End Strips) <i>Tuff-Cork</i>	OS30568XTC	1	
Timing Cover Set	1975-1980		(Contains 3/8" Thick Front End Strips) <i>Tuff-Cork</i>	JV881TC	1	
	1970-1974		(Contains 1/4" Thick Front End Strips) <i>Tuff-Cork</i>	JV779TC	1	
Timing Cover Gasket			<i>Performaseal</i>	T27781VC	1	
			(Full Circle Design (Quick Change Timing Covers And Gear Drive)) <i>Performaseal</i>	T31488VC	1	
Rear Main Seal Set			Align Bored Engine, (Oversize) <i>2.8406" To 2.8415" Outside Diameter</i>	JV1603	1	
Dist. Mounting Gasket			<i>Performaseal</i>	B25934VC	1	
Fuel Pump Gasket			Plate To Block <i>Performaseal</i>	D25932VC	1	
			Pump To Plate <i>Performaseal</i>	D27094VC	1	
Water Outlet Gasket			(Aluminum Carrier With Rubber Bead)	C21331	1	
Water Pump Mount Gasket			<i>Performaseal</i>	K25935VC	2	

General Motors Corp.

23 400 CID (6.6L) Pontiac V8 Cyl, 4.120in./104.6mm (1967-1979) 23

Part	Year	VIN	Model/Application	Part Number	Qty.
ENGINE GASKETS					
Manifold Set, Intake			Nitroseal, 1.18" x 2.20" Ports	95157SG	1
			Composition, 1.18" x 2.20" Ports	95157SP	1
Ex Header Gskt			Except Ram Air, Except Ram Air IV, Except Ram Air V, (Split Center Ports) Nitroseal	95038SG	1
			Except Ram Air, Except Ram Air IV, Except Ram Air V, (Open Center Ports) Nitroseal	95039SG	1
			1968-1969	Ram Air Engine, Ram Air IV Nitroseal	95182SG
Timing Cover Gasket	1975-1979		Performaseal	T27812VC	1
	1967-1974		Performaseal	T27806VC	1
Water Pump Gasket	1969-1979		Performaseal	K27149VC	1
	1967-1968		Performaseal	K27818VC	1

24 421 CID (6.9L) Pontiac V8 Cyl, 4.094in./104mm (1963-1966) 24

Part	Year	VIN	Model/Application	Part Number	Qty.
ENGINE GASKETS					
Manifold Set, Intake	1965-1966		Nitroseal, 1.18" x 2.20" Ports	95157SG	1
			Composition, 1.18" x 2.20" Ports	95157SP	1
Ex Header Gskt			(Split Center Ports) Nitroseal	95038SG	1
			(Open Center Ports) Nitroseal	95039SG	1
Timing Cover Gasket			Performaseal	T27806VC	1

25 428 CID (7.0L) Pontiac V8 Cyl, 4.120in./104.6mm (1967-1969) 25

Part	Year	VIN	Model/Application	Part Number	Qty.
ENGINE GASKETS					
Manifold Set, Intake			Nitroseal, 1.18" x 2.20" Ports	95157SG	1
			Composition, 1.18" x 2.20" Ports	95157SP	1
Ex Header Gskt			(Split Center Ports) Nitroseal	95038SG	1
			(Open Center Ports) Nitroseal	95039SG	1
Timing Cover Gasket			Performaseal	T27806VC	1
Water Pump Gasket	1969		Performaseal	K27149VC	1
	1967-1968		Performaseal	K27818VC	1

26 454 CID (7.4L) Chevrolet V8 Cyl, 4.250in./108mm (1970-1998) 26

Part	Year	VIN	Model/Application	Part Number	Qty.
ENGINE GASKETS					
Cylinder Head Gasket			Mark IV Engine, (Has Contoured Combustion Chamber Flanges For Open Chamber Head) Nitroseal, 11.5cc Combustion Chamber Volume, 4.520" Combustion Chamber Opening, .045" Compressed Operating Thickness	3884SG	2
			Mark V Engine, (Stainless Steel Core, Stainless Steel Flanges) Nitroseal, 11.0cc Combustion Chamber Volume, 4.578" Combustion Chamber Opening, .042" Compressed Operating Thickness	4886	2
			Mark V Block Using Mark IV Heads, Right Nitroseal, 11.0cc Combustion Chamber Volume, 4.578" Combustion Chamber Opening, .042" Compressed Operating Thickness	4918	1
			Mark V Block Using Mark IV Heads, Left Nitroseal, 11.0cc Combustion Chamber Volume, 4.578" Combustion Chamber Opening, .042" Compressed Operating Thickness	4923	1
			Mark IV Engine, Extra Large Bore Engines, But Not Recommended For 4.625" Or Larger Bore Solicor, 11.2cc Combustion Chamber Volume, 4.630" Combustion Chamber Opening, .042" Compressed Operating Thickness	5946SC	2

26 (cont.)	454 CID (7.4L) Chevrolet V8 Cyl, 4.250in./108mm (1970-1998)	26 (cont.)
----------------------	--	----------------------

Part	Year	VIN	Model/Application	Part Number	Qty.
ENGINE GASKETS (cont.)					
Cylinder Head Gasket (cont.)			Mark V Engine <i>Solicor, 10.8cc Combustion Chamber Volume, 4.540" Combustion Chamber Opening, .042" Compressed Operating Thickness</i>	5949SC	2
			Mark IV Engine <i>Solicor, 10.0cc Combustion Chamber Volume, 4.370" Combustion Chamber Opening, .042" Compressed Operating Thickness</i>	5950SC	2
			Mark V Engine <i>Solicor, 10.6cc Combustion Chamber Volume, 4.370" Combustion Chamber Opening, .042" Compressed Operating Thickness</i>	5951SC	2
			Mark V Engine, Extra Large Bore Engines, But Not Recommended For 4.625" Or Larger Bore <i>Solicor, 11.2cc Combustion Chamber Volume, 4.630" Combustion Chamber Opening, .042" Compressed Operating Thickness</i>	54228SC	2
			Mark IV (Head Gasket Has 2 Coolant Holes On Each End And 3 Lower Open Coolant Holes) <i>Multi-Layered Steel, 4.375" Combustion Chamber Opening, .040" Compressed Operating Thickness</i>	54266	2
			Mark IV (Head Gasket Has 2 Coolant Holes On Each End And 3 Lower Open Coolant Holes) <i>Multi-Layered Steel, 4.540" Combustion Chamber Opening, .040" Compressed Operating Thickness</i>	54267	2
			Mark IV (Head Gasket Has 2 Coolant Holes On Each End And 3 Lower Open Coolant Holes) <i>Multi-Layered Steel, 4.630" Combustion Chamber Opening, .040" Compressed Operating Thickness</i>	54268	2
			Mark IV And V (Head Gasket Has 1 Coolant Holes On Each End And 3 Lower Open Coolant Holes) <i>Multi-Layered Steel, 4.375" Combustion Chamber Opening, .040" Compressed Operating Thickness</i>	54269	2
			Mark IV And V (Head Gasket Has 1 Coolant Holes On Each End And 3 Lower Open Coolant Holes) <i>Multi-Layered Steel, 4.540" Combustion Chamber Opening, .040" Compressed Operating Thickness</i>	54270	2
			Mark IV And V (Head Gasket Has 1 Coolant Holes On Each End And 3 Lower Open Coolant Holes) <i>Multi-Layered Steel, 4.630" Combustion Chamber Opening, .040" Compressed Operating Thickness</i>	54271	2
			Mark IV, V And VI Blocks With Big Brodix Or Big Brodie Heads <i>4.530 Combustion Chamber Opening, .040" Compressed Operating Thickness</i>	54366	2
Valve Cover Set			Except Super Duty Pontiac/Brodix Head/Dart Big Chief <i>High Temperature Cork Rubber</i>	VS38420H	1
			Except Super Duty Pontiac/Brodix Head/Dart Big Chief <i>Tuff-Cork</i>	VS38420TC	1
			Except Super Duty Pontiac/Brodix Head/Dart Big Chief <i>Victo-Tech</i>	VS50169	1
	1970-1990		Super Duty Pontiac/Brodix Head/Dart Big Chief <i>High Temperature Tuff-Cork</i>	VS50191HTC	1
Manifold Set, Intake			Blocked Heat Crossover, Except Super Duty Pontiac/Brodix Head/Dart Big Chief <i>Nitroseal, 1.84" x 2.05" Oval Ports</i>	95007SG	1
			Blocked Heat Crossover, Except Super Duty Pontiac/Dart Big Chief <i>Nitroseal, 1.80" x 2.52" Rectangular Ports</i>	95008SG	1
			Except Super Duty Pontiac/Brodix Head/Dart Big Chief, Open Heat Crossover <i>Nitroseal, 1.84" x 2.05" Oval Ports</i>	95132SG	1
			Super Duty Pontiac/Brodix Head, (Trim To Fit) <i>Nitroseal, 1.90" x 2.70" Ports</i>	95161SG	1
			Super Duty Pontiac/Brodix Head, (Trim To Fit) <i>Composition, 1.90" x 2.70" Ports</i>	95161SP	1
			Except Super Duty Pontiac/Dart Big Chief, (Trim To Fit, Does Not Have Top Bolt Hole Between Siamesed Intake Ports) <i>Nitroseal, 1.64" x 2.36" Ports</i>	95162SG	1

PERFORMANCE

General Motors Corp.

26 (cont.)	454 CID (7.4L) Chevrolet V8 Cyl, 4.250in./108mm (1970-1998)				26 (cont.)
----------------------	--	--	--	--	----------------------

Part	Year	VIN	Model/Application	Part Number	Qty.
ENGINE GASKETS (cont.)					
Manifold Set, Intake (cont.)			Except Super Duty Pontiac/Dart Big Chief, (Trim To Fit, Does Not Have Top Bolt Hole Between Siamesed Intake Ports) <i>Composition, 1.64" x 2.36" Ports</i>	95162SP	1
			Except Super Duty Pontiac/Dart Big Chief, Open Heat Crossover <i>Nitroseal, 1.80" x 2.52" Rectangular Ports</i>	95163SG	1
			Except Super Duty Pontiac/Dart Big Chief, Open Heat Crossover <i>Composition, 1.80" x 2.52" Rectangular Ports</i>	95163SP	1
			(No Bolt Holes Or Ports (Universal Trim To Fit)) <i>Composition</i>	95168SP	1
			Dart "Big Chief" <i>Nitroseal, 1.86" x 2.46" Ports</i>	95170SG	1
			Dart "Big Chief" <i>Composition, 1.86" x 2.46" Ports</i>	95170SP	1
	Ex Header Gskt			Stock Aluminum Heads <i>Nitroseal, 1.87" Round Ports</i>	95020SG
			<i>Nitroseal, 1.82" x 1.88" Stock Ports</i>	95021SG	1
			<i>Nitroseal, 2.12" x 2.12" Square Ports</i>	95022SG	1
			<i>Nitroseal, 2.13" Round Ports</i>	95100SG	1
Oil Pan Set	1991-1998		<i>Victo-Tech</i>	OS32121	1
	1970-1990		<i>Tuff-Cork</i>	OS30931XTC	1
			(Special Construction Side Rails Trimmed For Rod Clearance) <i>Tuff-Cork</i>	OS32123TC	1
Timing Cover Set	1970-1990		<i>Tuff-Cork</i>	JV866TC	1
Timing Cover Gasket	1970-1990		<i>Performaseal</i>	T27119VC	1
Dist. Mounting Gasket	1970-1990		<i>Performaseal</i>	B25934VC	1
Fuel Pump Gasket	1970-1990		<i>Performaseal</i>	D27094VC	1
Water Outlet Gasket	1970-1990		(Aluminum Carrier With Rubber Bead)	C21331	1
Water Pump Mount Gasket	1970-1996		<i>Performaseal</i>	K26632VC	2

27	455 CID (7.5L) Pontiac V8 Cyl, 4.151in./105.4mm (1970-1976)				27
-----------	--	--	--	--	-----------

Part	Year	VIN	Model/Application	Part Number	Qty.
ENGINE GASKETS					
Manifold Set, Intake			<i>Nitroseal, 1.18" x 2.20" Ports</i>	95157SG	1
			<i>Composition, 1.18" x 2.20" Ports</i>	95157SP	1
Ex Header Gskt	1970-1976		Except High Output Engine, Except Super Duty Engine, (Split Center Ports) <i>Nitroseal</i>	95038SG	1
			Except High Output Engine, Except Super Duty Engine, (Open Center Ports) <i>Nitroseal</i>	95039SG	1
	1971-1974		High Output Engine, Super Duty Engine <i>Nitroseal</i>	95182SG	1
Timing Cover Gasket	1975-1976		<i>Performaseal</i>	T27812VC	1
	1970-1974		<i>Performaseal</i>	T27806VC	1
Water Pump Gasket			<i>Performaseal</i>	K27149VC	1

28	500 CID (8.2L) Pro Stock Big Block V8 Cyl				28
-----------	--	--	--	--	-----------

Part	Year	VIN	Model/Application	Part Number	Qty.
ENGINE GASKETS					
Cylinder Head Gasket			Chevrolet Bolt Pattern, (Cylindrical Combustion Chamber Openings) <i>Solicor, 13.9cc Combustion Chamber Volume, 4.620" Combustion Chamber Opening, .051" Compressed Operating Thickness</i>	5969SC	2
			Pontiac, Drag Race Only <i>Solicor, 13.9cc Combustion Chamber Volume, 4.620" Combustion Chamber Opening, .051" Compressed Operating Thickness</i>	5970SC	2
			Oldsmobile DRCE <i>Solicor, 13.9cc Combustion Chamber Volume, 4.620" Combustion Chamber Opening, .051" Compressed Operating Thickness</i>	5971SC	2

PERFORMANCE

28 500 CID (8.2L) Pro Stock Big Block V8 Cyl **28**
(cont.) (cont.)

Part	Year	VIN	Model/Application	Part Number	Qty.
ENGINE GASKETS (cont.)					
Cylinder Head Gasket (cont.)			4.900" Bore Center, Oldsmobile DRCE 2 Multi-Layered Steel, 4.700" Combustion Chamber Opening, .054" Compressed Operating Thickness	54272	2
			4.900" Bore Center, Oldsmobile DRCE 2 Multi-Layered Steel, 4.780" Combustion Chamber Opening, .054" Compressed Operating Thickness	54273	2
			Cylindrical Combustion Chamber Multi-Layered Steel, 4.620" Combustion Chamber Opening, .040" Compressed Operating Thickness	54346	2
Valve Cover Set			Chevrolet Bolt Pattern Tuff-Cork	VS38420TC	1
			Pontiac Head With Special Coolant Pattern And Drag Racing Only High Temperature Tuff-Cork	VS50191HTC	1
			Oldsmobile DRCE High Temperature Tuff-Cork	VS50193HTC	1
Manifold Set, Intake			(No Bolt Holes Or Ports (Universal Trim To Fit)) Composition, 1/16" Thick	95168SP	1
Ex Header Gskt			Chevrolet Bolt Pattern, Except Oldsmobile DRCE Nitroseal, 2.40" Round Ports	95178SG	1
			Oldsmobile DRCE Nitroseal, 2.40" Round Ports	95179SG	1
Oil Pan Set			Mark V 502 Victo-Tech	OS32121	1
			Except Oldsmobile DRCE, (Special Construction Side Rails Trimmed For Rod Clearance) Tuff-Cork	OS32123TC	1
			Oldsmobile DRCE Tuff-Cork	OS32128TC	1

29 502 CID (8.2L) Chevrolet V8 Cyl, 4.470in./113.5mm **29**

Part	Year	VIN	Model/Application	Part Number	Qty.
ENGINE GASKETS					
Cylinder Head Gasket			(Head Gasket Has 1 Coolant Hole On Each End And 3 Lower Open Coolant Holes) Multi-Layered Steel, 4.375" Combustion Chamber Opening, .040" Compressed Operating Thickness	54269	2
			(Head Gasket Has 1 Coolant Hole On Each End And 3 Lower Open Coolant Holes) Multi-Layered Steel, 4.540" Combustion Chamber Opening, .040" Compressed Operating Thickness	54270	2
			(Head Gasket Has 1 Coolant Hole On Each End And 3 Lower Open Coolant Holes) Multi-Layered Steel, 4.630" Combustion Chamber Opening, .040" Compressed Operating Thickness	54271	2
			Mark IV, V And VI Blocks With Big Brodix Or Big Brodie Heads 4.530 Combustion Chamber Opening, .040" Compressed Operating Thickness	54366	2

Honda

Engine Index

Engine	Year	Block	Engine	Year	Block
1493CC (1.5L) D15B1/D15B2	1988-1991	1	1590CC (1.6L) D16Z6 V-TEC SOHC	1992-1995	2
1493CC (1.5L) D15B6 SOHC	1988-1991	1	1595CC (1.6L) B16A2 V-TEC DOHC	1996-2000	3
1493CC (1.5L) D15B7 SOHC	1992-1995	1	1595CC (1.6L) B16A3 V-TEC DOHC	1994-1995	3
1493CC (1.5L) D15B8 SOHC	1992-1995	1	1678CC (1.7L) B17A1 V-TEC DOHC Acura	1992-1993	4
1493CC (1.5L) D15Z1 V-TEC SOHC	1992-1995	2	1797CC (1.8L) B18C1 V-TEC DOHC Acura	1994-2001	5
1590CC (1.6L) D16A6 SOHC	1988-1991	1	1834CC (1.8L) B18A1 DOHC Acura	1990-1993	6
1590CC (1.6L) D16Y5 V-TEC-2 SOHC	1996-2000	2	1834CC (1.8L) B18B1 DOHC Acura	1994-2001	6
1590CC (1.6L) D16Y7 SOHC	1996-2000	2	2157CC (2.2L) H22A1 V-TEC DOHC	1993-1996	7
1590CC (1.6L) D16Y8 V-TEC SOHC	1996-2000	2	2157CC (2.2L) H22A4 V-TEC DOHC	1997-2001	8

PERFORMANCE

Honda

1	1493CC (1.5L) D15B1/D15B2, D15B6 SOHC 4 Cyl, 2.953in./75mm (1988-1991) 1493CC (1.5L) D15B7 SOHC, D15B8 SOHC 4 Cyl, 2.953in./75mm (1992-1995) 1590CC (1.6L) D16A6 SOHC 4 Cyl, 2.953in./75mm (1988-1991)				1
----------	---	--	--	--	----------

Part	Year	VIN	Model/Application	Part Number	Qty.
------	------	-----	-------------------	-------------	------

ENGINE GASKETS

Cylinder Head Gasket			Multi-Layered Steel, 76mm Combustion Chamber Opening, .030" Compressed Operating Thickness	54303	1
			Multi-Layered Steel, 79mm Combustion Chamber Opening, .030" Compressed Operating Thickness	54304	1

2	1493CC (1.5L) D15Z1 V-TEC SOHC 4 Cyl, 2.953in./75mm (1992-1995) 1590CC (1.6L) D16Y5 V-TEC-2 SOHC, D16Y8 V-TEC SOHC 4 Cyl, 2.953in./75mm (1996-2000) 1590CC (1.6L) D16Y7 SOHC 4 Cyl, 2.953in./75mm (1996-2000) 1590CC (1.6L) D16Z6 V-TEC SOHC 4 Cyl, 2.953in./75mm (1992-1995)				2
----------	--	--	--	--	----------

Part	Year	VIN	Model/Application	Part Number	Qty.
------	------	-----	-------------------	-------------	------

ENGINE GASKETS

Cylinder Head Gasket			(Compressed Operating Thickness Is Adjustable) Victo-Stack	54096VS	1
----------------------	--	--	---	---------	---

3	1595CC (1.6L) B16A2 V-TEC DOHC 4 Cyl, 3.189in./81mm (1996-2000) 1595CC (1.6L) B16A3 V-TEC DOHC 4 Cyl, 3.189in./81mm (1994-1995)				3
----------	--	--	--	--	----------

Part	Year	VIN	Model/Application	Part Number	Qty.
------	------	-----	-------------------	-------------	------

ENGINE GASKETS

Cylinder Head Gasket			Multi-Layered Steel, 82mm Combustion Chamber Opening, .030" Compressed Operating Thickness	54305	1
			Multi-Layered Steel, 85mm Combustion Chamber Opening, .030" Compressed Operating Thickness	54306	1
			(Bore Flange For High Cylinder Pressure) Multi-Layered Steel, 84mm Combustion Chamber Opening, .030" Compressed Operating Thickness	54342	1

4	1678CC (1.7L) B17A1 V-TEC DOHC Acura 4 Cyl, 3.189in./81mm (1992-1993)				4
----------	--	--	--	--	----------

Part	Year	VIN	Model/Application	Part Number	Qty.
------	------	-----	-------------------	-------------	------

ENGINE GASKETS

Cylinder Head Gasket			Multi-Layered Steel, 82mm Combustion Chamber Opening, .030" Compressed Operating Thickness	54305	1
			Multi-Layered Steel, 85mm Combustion Chamber Opening, .030" Compressed Operating Thickness	54306	1

5	1797CC (1.8L) B18C1 V-TEC DOHC Acura 4 Cyl, 3.189in./81mm (1994-2001)				5
----------	--	--	--	--	----------

Part	Year	VIN	Model/Application	Part Number	Qty.
------	------	-----	-------------------	-------------	------

ENGINE GASKETS

Cylinder Head Gasket			Multi-Layered Steel, 82mm Combustion Chamber Opening, .030" Compressed Operating Thickness	54305	1
			Multi-Layered Steel, 85mm Combustion Chamber Opening, .030" Compressed Operating Thickness	54306	1
			(Bore Flange For High Cylinder Pressure) Multi-Layered Steel, 84mm Combustion Chamber Opening, .030" Compressed Operating Thickness	54342	1
Manifold Set, Intake			Stainless Steel, 1.335" X 1.85" Ports	MS15679	1

6	1834CC (1.8L) B18A1 DOHC Acura 4 Cyl, 3.189in./81mm (1990-1993) 1834CC (1.8L) B18B1 DOHC Acura 4 Cyl, 3.189in./81mm (1994-2001)				6
----------	--	--	--	--	----------

Part	Year	VIN	Model/Application	Part Number	Qty.
------	------	-----	-------------------	-------------	------

ENGINE GASKETS

Cylinder Head Gasket			Multi-Layered Steel, 82mm Combustion Chamber Opening, .030" Compressed Operating Thickness	54307	1
----------------------	--	--	--	-------	---

6	1834CC (1.8L) B18A1 DOHC Acura 4 Cyl, 3.189in./81mm (1990-1993)				6
(cont.)	1834CC (1.8L) B18B1 DOHC Acura 4 Cyl, 3.189in./81mm (1994-2001)				(cont.)

Part	Year	VIN	Model/Application	Part Number	Qty.
------	------	-----	-------------------	-------------	------

ENGINE GASKETS (cont.)

Cylinder Head Gasket (cont.)			Multi-Layered Steel, 84mm Combustion Chamber Opening, .030" Compressed Operating Thickness	54308	1
			Requires V-TEC Cylinder Head Multi-Layered Steel, 82mm Combustion Chamber Opening, .030" Compressed Operating Thickness	54312	1
			Requires V-TEC Cylinder Head Multi-Layered Steel, 85mm Combustion Chamber Opening, .030" Compressed Operating Thickness	54313	1

7	2157CC (2.2L) H22A1 V-TEC DOHC 4 Cyl, 3.425in./87mm (1993-1996)				7
----------	--	--	--	--	----------

Part	Year	VIN	Model/Application	Part Number	Qty.
------	------	-----	-------------------	-------------	------

ENGINE GASKETS

Cylinder Head Gasket			Multi-Layered Steel, 88mm Combustion Chamber Opening, .030" Compressed Operating Thickness	54309	1
			Multi-Layered Steel, 90mm Combustion Chamber Opening, .030" Compressed Operating Thickness	54310	1

8	2157CC (2.2L) H22A4 V-TEC DOHC 4 Cyl, 3.425in./87mm (1997-2001)				8
----------	--	--	--	--	----------

Part	Year	VIN	Model/Application	Part Number	Qty.
------	------	-----	-------------------	-------------	------

ENGINE GASKETS

Cylinder Head Gasket			Multi-Layered Steel, 87mm Combustion Chamber Opening, .030" Compressed Operating Thickness	54311	1
----------------------	--	--	---	-------	---

Mazda

Engine Index

Engine	Year	Block
1597CC (1.6L) B6E DOHC 16 Valve Turbo	1988-1989	1
1597CC (1.6L) B6ZE DOHC 16 Valve	1990-1993	1

1	1597CC (1.6L) B6E DOHC 16 Valve Turbo 4 Cyl, 3.071in./78mm (1988-1989)				1
	1597CC (1.6L) B6ZE DOHC 16 Valve 4 Cyl, 3.071in./78mm (1990-1993)				

Part	Year	VIN	Model/Application	Part Number	Qty.
------	------	-----	-------------------	-------------	------

ENGINE GASKETS

Cylinder Head Gasket			Multi-Layered Steel, 80mm Combustion Chamber Opening, .040" Compressed Operating Thickness	54314	1
----------------------	--	--	---	-------	---

Mitsubishi

Engine Index

Engine	Year	Block	Engine	Year	Block
1997CC (2.0L) 4G63 DOHC	1989-1994	1	2972CC (3.0L) 6G72 DOHC	1991-1999	2
1997CC (2.0L) 4G63T DOHC TURBO	1989-1996	1			

1	1997CC (2.0L) 4G63 DOHC 4 Cyl, 3.346in./85mm (1989-1994)				1
	1997CC (2.0L) 4G63T DOHC TURBO 4 Cyl, 3.346in./85mm (1989-1996)				

Part	Year	VIN	Model/Application	Part Number	Qty.
------	------	-----	-------------------	-------------	------

ENGINE GASKETS

Cylinder Head Gasket			Multi-Layered Steel, 85.5mm Combustion Chamber Opening, .054" Compressed Operating Thickness	54315	1
----------------------	--	--	---	-------	---

2	2972CC (3.0L) 6G72 DOHC V6 Cyl, 3.587in./91.1mm (1991-1999)				2
----------	--	--	--	--	----------

Part	Year	VIN	Model/Application	Part Number	Qty.
------	------	-----	-------------------	-------------	------

ENGINE GASKETS

Cylinder Head Gasket			Multi-Layered Steel, 95mm Combustion Chamber Opening, .054" Compressed Operating Thickness	54316	2
----------------------	--	--	---	-------	---

Subaru

Engine Index

Engine	Year	Block	Engine	Year	Block
1994CC (2.0L) EJ20T DOHC 16 Valve		1	2457CC (2.5L) EJ25D DOHC		3
2212CC (2.2L) EJ22T Turbo		2			

1	1994CC (2.0L) EJ20T DOHC 16 Valve 4 Cyl, 3.622in./92mm					1
----------	---	--	--	--	--	----------

Part	Year	VIN	Model/Application	Part Number	Qty.
------	------	-----	-------------------	-------------	------

ENGINE GASKETS

Cylinder Head Gasket			Multi-Layered Steel, 93mm Combustion Chamber Opening, .054" Compressed Operating Thickness	54317	1
----------------------	--	--	--	-------	---

2	2212CC (2.2L) EJ22T Turbo 4 Cyl, 3.815in./96.9mm					2
----------	---	--	--	--	--	----------

Part	Year	VIN	Model/Application	Part Number	Qty.
------	------	-----	-------------------	-------------	------

ENGINE GASKETS

Cylinder Head Gasket			Multi-Layered Steel, 98mm Combustion Chamber Opening, .054" Compressed Operating Thickness	54318	1
----------------------	--	--	--	-------	---

3	2457CC (2.5L) EJ25D DOHC 4 Cyl, 3.917in./99.5mm					3
----------	--	--	--	--	--	----------

Part	Year	VIN	Model/Application	Part Number	Qty.
------	------	-----	-------------------	-------------	------

ENGINE GASKETS

Cylinder Head Gasket			Multi-Layered Steel, 100mm Combustion Chamber Opening, .040" Compressed Operating Thickness	54319	1
----------------------	--	--	---	-------	---

Toyota

Engine Index

Engine	Year	Block	Engine	Year	Block
1587CC (1.6L) 4AGE/4AGEC/4AGELC DOHC		1	2366CC (2.4L) 22RTEC SOHC		2

1	1587CC (1.6L) 4AGE/4AGEC/4AGELC DOHC 4 Cyl, 3.189in./81mm					1
----------	--	--	--	--	--	----------

Part	Year	VIN	Model/Application	Part Number	Qty.
------	------	-----	-------------------	-------------	------

ENGINE GASKETS

Cylinder Head Gasket			Multi-Layered Steel, 81mm Combustion Chamber Opening, .040" Compressed Operating Thickness	54320	1
----------------------	--	--	--	-------	---

2	2366CC (2.4L) 22RTEC SOHC 4 Cyl, 3.622in./92mm					2
----------	---	--	--	--	--	----------



Part	Year	VIN	Model/Application	Part Number	Qty.
------	------	-----	-------------------	-------------	------

ENGINE GASKETS

Cylinder Head Gasket			Turbocharged Multi-Layered Steel, 95mm Combustion Chamber Opening, .040" Compressed Operating Thickness	54321	1
----------------------	--	--	--	-------	---

Air Cleaner Gaskets

Carter		Holley	
AFB 4-7/32" Dia. Air Horn	G27175	2 Barrel 2-1/2" x 4-7/8" Oval	G27176
Thermoquad 5-1/8" Dia., 1/16" Thick Air Horn	G27098	4 Barrel 5-1/8" Dia., 1/16" Thick Air Horn	G27098
Thermoquad 5-1/8" Dia., 3/32" Thick Air Horn	G31315	4 Barrel 5-1/8" Dia., 3/32" Thick Air Horn	G31315
Thermoquad 7-9/32" Dia., 3/32" Thick Air Horn	G31316	4 Barrel 7-9/32" Dia., 3/32" Thick Air Horn	G31316

Rochester			
Quadrajets 5-1/8" Dia., 1/16" Thick Air Horn	G27098		
Quadrajets 5-1/8" Dia., 3/32" Thick Air Horn	G31315		
Quadrajets 7-9/32" Dia., 3/32" Thick Air Horn	G31316		



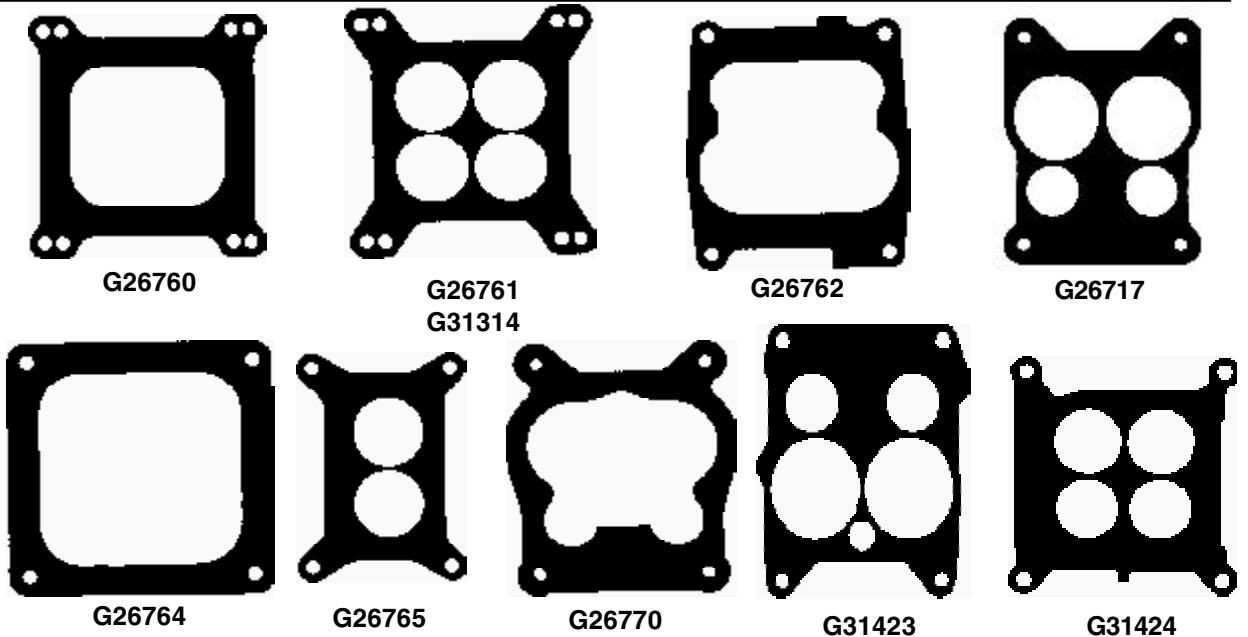

Carburetor Mounting Gaskets

Carter		Holley	
AFB, Open Center	G26760	2 Barrel, 2 Hole	G26765
4 Hole, 1-3/4" Dia.	G26761	4 Barrel, Ex. Spread Bore and 4500,	
4 Hole, 1-31/64" Dia.	G31314		
Thermoquad, Open Center	G26762	Open Center	G26760
Insulator	G26770	4 Hole, 1-3/4" Dia.	G26761
4 Hole, Insulator	G26717	4 Hole, 1-31/64" Dia.	G31314
Chevrolet		Spread Bore, Open Center	G26762
Holley, 4-Barrel	G31424	Insulator	G26770
Quadrajets	G31423	4500, Open Center	G26764
		4 Hole, Insulator	G26717
Rochester			
Quadrajets, Open Center	G26762		
Insulator	G26770		
4 Hole, Insulator	G26717		



Nitroseal® Collector Gaskets

PERFORMANCE

TRIANGULAR - 3 BOLT	Inside Dia.	Bolt Circle	Bolt Hole	Part No.	Application
	2-3/8"	3-1/2"	3/8"	F20412SG	Hush Thrush Muffler #510
	2-1/2"	3-1/2"	3/8"	F20410SG	Hooker, Hedman
	2-3/4"	3-1/2"	3/8"	F12381SG	Hooker, Hedman
	3"	3-3/4"	3/8"	F20417SG	Thorley, Hooker, Hedman
	3-1/2"	4-7/16"	3/8"	F20416SG	Thorley, Hooker, Hedman
SQUARE - 4 BOLT	Inside Dia.	Bolt Circle	Bolt Hole	Part No.	Application
	2-1/2"	3-5/16"	3/8"	F20411SG	Blackjack and Others
	3"	4-1/16"	3/8"	F20421SG	Blackjack and Others
	3"	4-1/16"	7/16"	F20418SG	Blackjack and Others
	3-1/2"	4-9/16"	3/8"	F20422SG	Blackjack and Others
	3-1/2"	5"	3/8"	F20419SG	Blackjack and Others
ROUND - 4 BOLT	Inside Dia.	Bolt Circle	Bolt Hole	Part No.	Application
	3"	3-5/8"	3/8"	F20415SG	---
	3-1/2"	4-1/8"	3/8"	F20420SG	---
ROUND - MULTI-BOLT	Inside Dia.	Bolt Circle	Bolt Hole	Part No.	Application
	2-7/8"	3-3/4"	7/16"	F20413SG	Hush Thrush Muffler #513
	2-7/8"	4"	7/16"	F20413SG	Hush Thrush Muffler #513
	3-3/8"	4-3/8"	3/8"	F20414SG	Hush Thrush Muffler #514
	3-3/8"	4-1/2"	3/8"	F20414SG	Hush Thrush Muffler #514

Nitroseal® Sheet Material (One Sheet Per Package)

Size	Part No.
1/32" X 10-1/4" X 36"	JV222SG
3/64" X 10-1/4" X 36"	JV313SG
1/16" X 10-1/4" X 36"	JV314SG
3/64" X 20" X 40"	JV315SG
1/16" X 20" X 40"	JV316SG

Tuff-Cork® Sheet Material (One Sheet Per Package)

Size	Part No.
3/32" X 12" X 24"	JV300TC
3/32" X 18" X 36"	JV301TC

Carbonless Impression Paper

There is an easy and accurate method to check the flatness of mating surfaces sealed by gaskets—carbonless impression paper. This method is particularly useful for checking the flatness of the cylinder head and block where the sealing is critical.

JV311 (Two Sheets)	—	10" X 30" Sheet
JV312 (Twelve Sheets)	—	10" X 30" Sheet

Super Kit Full Sets

Super Kit Full Sets contain Nitroseal® head gaskets, Viton valve stem seals, Plastigage, Tuff-Cork® valve cover gaskets, Tuff-Cork oil pan gaskets timing cover and other Tuff-Cork gaskets which may be available for the application.	Super Kit No.	Application	Year
		FS1178SG	Chevrolet 350
	FS3514SG	Chevrolet 305	1975-85
	FS3536SG	Chrysler 318	1967-88
	FS3428SG	Ford 351W	1975-90
	FS3530SG	Ford 302	1977-90

Performance Gaskets

VICTO - STACK CHART
Guide to Gasket Thickness and its
effects on Compression Ratio.

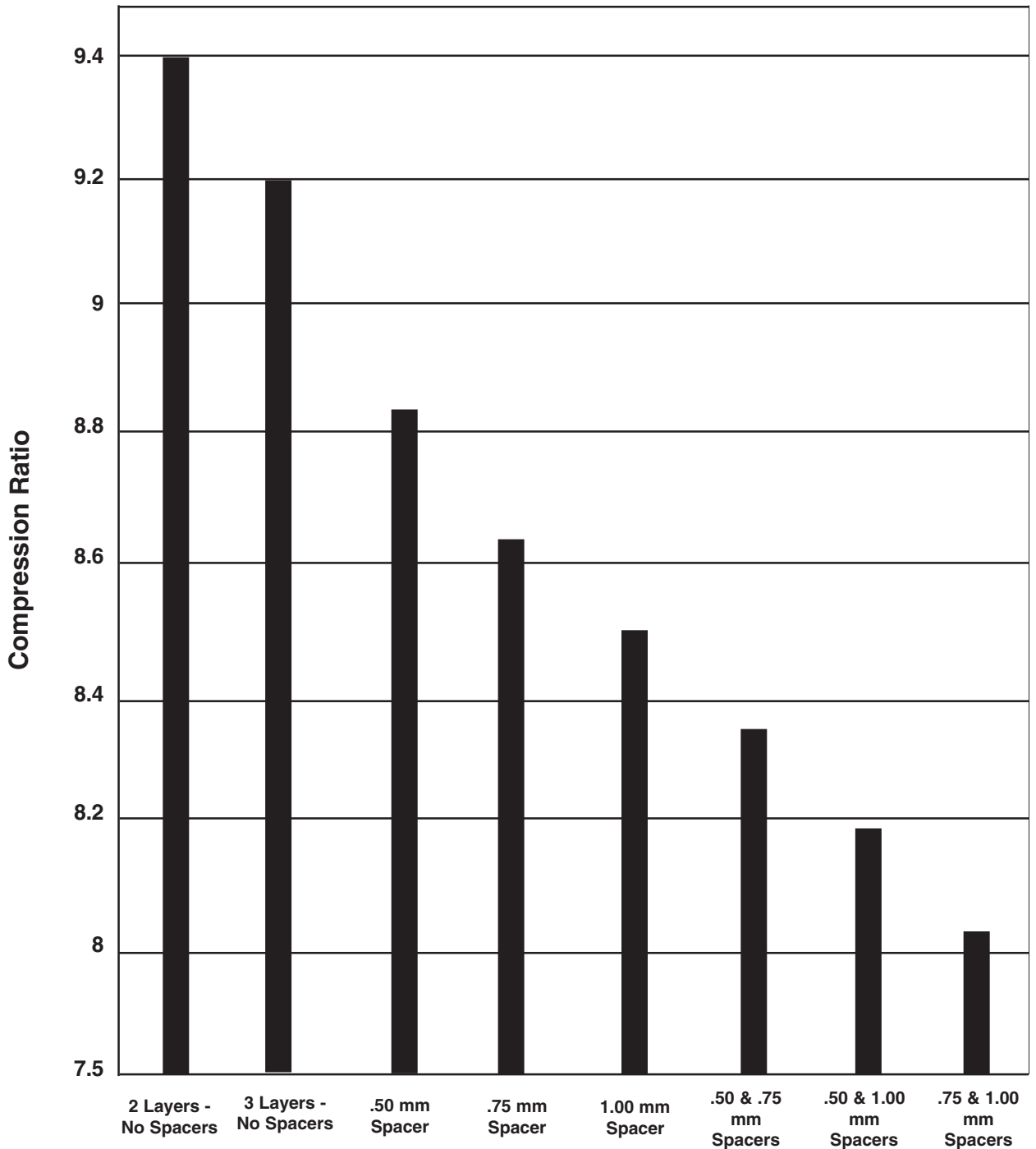

PERFORMANCE

Spacer Guide

Note: Figures are “approximate and based on calculations made on a standard bore, standard deck height, 1995 Honda 1.6L V-TEC”. If your engine has had modifications to the bore, deck, or head, you will need to factor these into your selection process.

Performance Gaskets

Big Block Chevrolet Identification Information

Chevrolet Big Block V8 engines manufactured since 1965 can be broken down into two distinct groups. Engines manufactured between 1965 & 1990 are known as Mark IV or Gen IV engines. During this period of manufacturing, there has been a variety of changes to the head gasket due to engine modifications. Engines manufactured from 1991 to present are classified as Mark V or Gen V engines. The change from the Mark IV to the Mark V design has forced another change in the head gasket design. This is all very confusing due to the fact that the overall bolt pattern and bore spacing of the head and block has remained unchanged from the beginning. The design differences between the Mark IV and the Mark V engines causes interchangeability problems with hardware and head gaskets. Please pay special attention to the items listed when selecting the proper head gasket.

The primary area of concern is a coolant opening on the intake (valley) side of the engine. There may be certain combinations of Mark IV and Mark V cylinder heads and blocks which may not have enough material present to seal fluids. To determine if enough material is present, make a carbon impression (*per the instructions on the following page*) If the impression does not reveal at least 1/4" (.250") of contact around the coolant holes leakage may occur. Special welding and or machining may be necessary for this combination of hardware to properly seal (Contact a qualified engine machinist for details).

The gaskets for the Mark V, Mark IV truck and the Mark IV Bow Tie have one set of coolant holes removed from both ends of the gasket to match the block. While the Mark IV passenger and High Performance block have the additional holes at both ends.

Part numbers 4918 and 4923 were designed to accommodate some of the passenger car and high performance blocks and heads when the lower coolant holes are available or drilled. Head gasket #4918 is used on the right bank of the engine because it locates the extra coolant hole in the rear of the engine. While #4923 is used on the left side of the engine to locate the coolant hole in the rear of the engine.

For additional information, refer to the instructions supplied with the gasket, or contact a qualified engine machinist.

Gen V (5) Block and Mark IV (4) Head Installation

CAUTION!

As this is a unique installation, Gen V Block using Mark IV heads, extra care should be taken to insure the proper loading of head gasket around certain water openings along the top of the block.

As with any cylinder head, various revisions and casting changes have taken place, so it is with Mark IV heads. Some cylinder heads may require additional material to be added to the cylinder head machined surface.

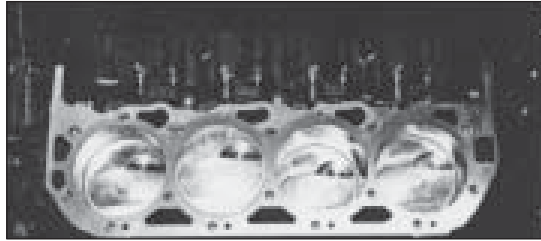

GEN V (5) BLOCK

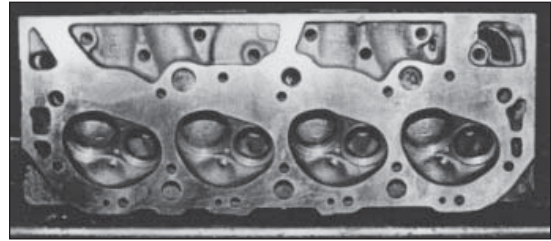

MARK IV (4) HEAD

<p>— Using Carbonless Impression Paper, JV311 (2 pcs.) or JV312 (12 pcs.) and TK950 Punch Set, place impression paper on block and install head.</p>	
<p>— A minimum of 1/4" of contact should be evident on paper. If not, material may be added as shown.</p>	
<p>— Braze or weld material to possible critical sealing areas.</p>	
<p>— Detail of added material approximately 1/4" to edge of head.</p>	
<p>— Test was repeated with "modified" Mark IV head. Note area around coolant passage which clearly shows 1/4" contact between head and block.</p>	

Complete instructions on the use of the Carbonless Impression Paper are included in JV311 or JV312

Performance Gaskets

Performance Head Gasket Installation

Before installing any head gasket, make sure the engine hardware has been thoroughly checked (cracks, scratches, threaded holes, etc.). Clean all threaded holes in the engine, taps are available for the cleaning of threads. Remove any previous bolt sealer, carbon, or rust below the line of previous engagement.

The head and block must be smooth and flat, Carbon Impression paper is the best way to determine hardware condition. Recommended smoothness for cast iron is 60-100 Ra and 20-50 Ra for aluminum.

When possible, replace the dowel pins when installing a head gasket. Dowel pins provide the only reference point for the fit of the gasket.

Once the gasket is placed onto the engine, recheck the alignment and check the combustion seal. The inside diameter of the gasket should not fall into the combustion opening or lay on the chamfered area of the block.

Torquing Procedure

When studs are being used, follow the procedures recommended by the stud manufacturer. Use thread sealant when necessary, or thread lock if required. Check to insure that the studs remain perpendicular to the block when they are installed, to avoid any potential interference through the head bolt holes.

It is recommended that hardened washers be used for both bolts or studs after installation. When using head bolts, lubrication under the head and at the threads is critical to attain proper load on the bolt, (If studs are used lubricate under the nut). Using the proper lubrication is very important, follow the recommended procedure from the fastener supplier.

Following the recommended sequence for head installation is crucial to insure gasket reliability. During the multi-step torquing procedure, continue to follow the recommended sequence. A smooth continuous motion is important when applying bolt torque, for every step.

In extreme cases (racing), a re-torque can be used. When the engine has maintained operating and returned to room temperature, retorquing can then be done. To achieve maximum amount of clamping force, loosen each fastener then tighten back to the original torque value.

Performance Gaskets

Performance Intake Manifold Installation

Make certain that the mating surfaces of the manifold and cylinder head are clean, dry and flat. Be sure to check aluminum component surfaces closely, as the scraping and cleaning process could possibly damage the mating surfaces.

Carefully check the gaskets and hardware to insure that you have sized the components correctly. (Port alignment and bolt centers are the most critical dimensions).

A quality adhesive should be used to place the intake manifold gasket on to the cylinder head. In the narrow wall between the ports a thin film of adhesive is appropriate.

If RTV type products are used as a sealer on the gaskets be sure to use only the necessary amount. Any uncured RTV will act as a lubricant causing gasket damage. The gasket may extrude or split when excessive RTV is used.

Place the intake manifold on the engine and finger tighten the bolts in sequence to set the gasket permanently in place. (If working on a V-type engine, do not use the end strips while setting the adhesive.)

After the adhesive has dried, remove the intake manifold and check the gasket for alignment. At this time, trim away any gasket material that reaches inside the ports.

After completing any necessary trimming, reinstall the intake manifold and torque to the recommended specifications. **For best intake clamp load, use at least a three step torquing procedure.**

End Strip Installation for V-Type Engines

Make sure that the mounting surface on the block has been degreased before beginning to install the end strips.

Use a quality sealant to place the end strips in their proper position. When surfaces are dry, use silicone sealant (RTV) on the four corners. *If intake motion has been a problem, a thin film of anti-seize on top of the cork rubber end strip will allow movement yet continue to seal.*

If RTV is to be used to seal the ends, place a continuous bead across the engine, then install the intake manifold. Be sure to wait for the RTV to completely cure to avoid leakage problems.

Performance Gaskets

Carbonless Impression Paper

(Order Part No. JV311 (2 sheets) or JV312 (12 sheets))

There is an easy and accurate method to check the flatness of mating surfaces sealed by gaskets - carbonless impression paper. This method is particularly useful for checking the flatness of the cylinder head and block where the sealing is critical. The maximum allowable out-of-flat is .002" per 6" span and approximately .004" overall. Since the total paper thickness is .006", lack of a clear impression indicates warpage.

Directions: Do Not Separate The Two Papers

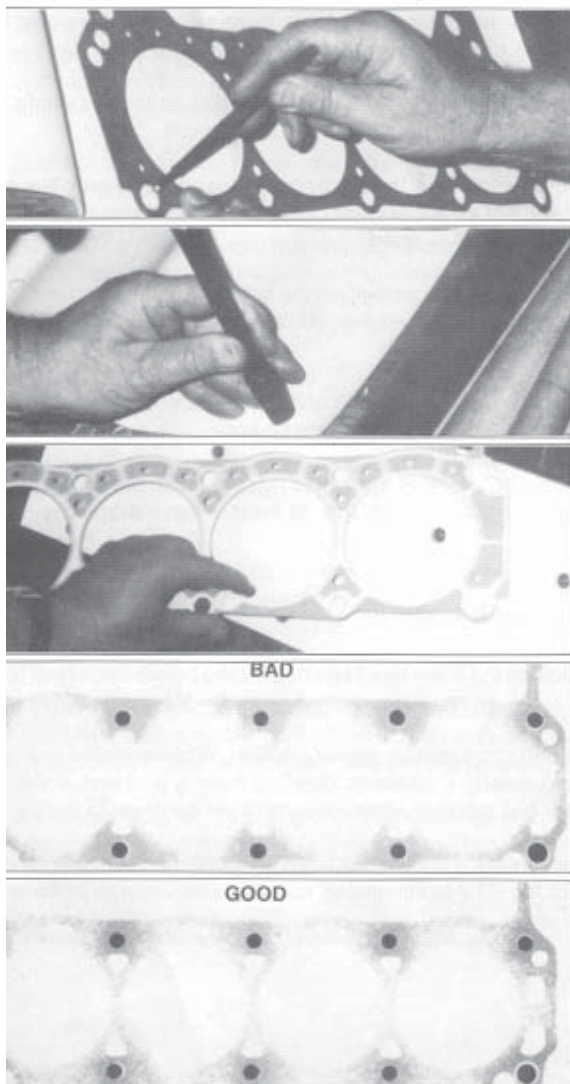

The paper is pre-cut but may be trimmed to size slightly larger than the gasket.

Punch out all bolt holes and dowel locations using the tools found in Punch Set TK950.

Install the bolts and torque the assembly in the proper sequence and torque specifications.

Wait five (5) minutes.

Disassemble using reverse sequence.

If the surfaces are true, a clear impression of the sealing surface will be visible. Little or no impression indicates warpage.

NOTE: Do not use this paper on engines with liners that protrude above the block.

Head Bolt Torque Specifications

(Torque In Three Steps)

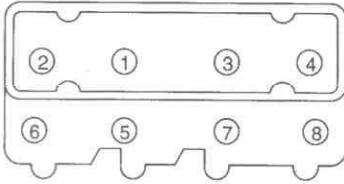
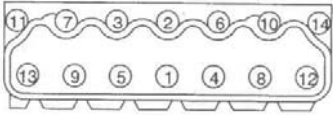
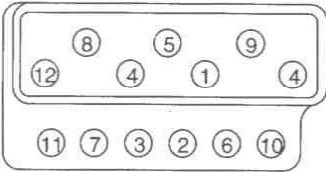
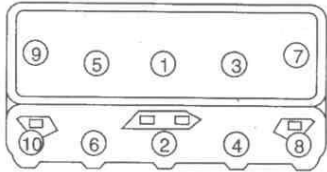
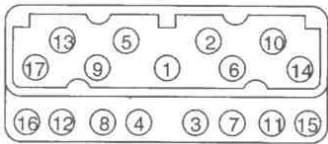
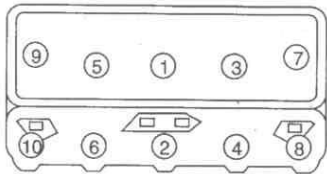
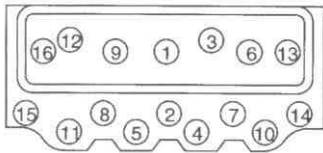
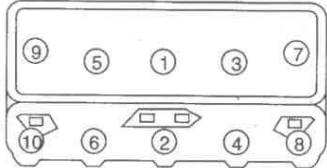
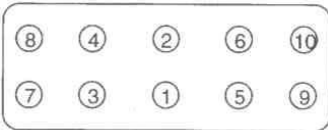
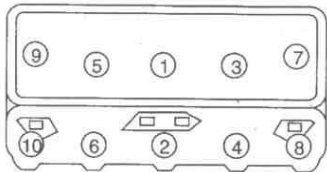
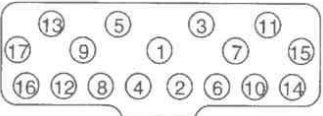
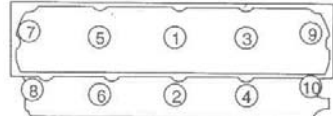
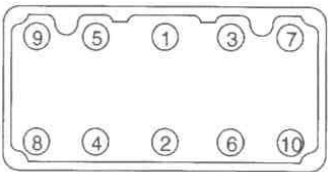
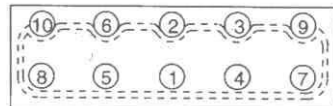
<p>BUICK V6 196, 231, 252 Stage I and II</p> <p>Short Bolts: 33-49-65 Ft.-Lbs. Long Bolts: 35-53-70 Ft.-Lbs.</p> 	<p>FORD 6 Cyl. 240,330</p> <p>240 CID: 55-65-75 Ft.-Lbs. 300 CID: 55-65-85 Ft.-Lbs.</p> 
<p>CHEVROLET 90° V6 200,229</p> <p>33-49-65 Ft.-Lbs.</p> 	<p>FORD V8 260,289,302 Except Boss, 351W</p> <p>35-53-70 Ft.-Lbs.</p> 
<p>CHEVROLET V8 262,267,283 302,305,307 327,350,400</p> <p>33-49-65 Ft.-Lbs.</p> 	<p>FORD V8 351C,351M,400</p> <p>53-79-105 Ft.-Lbs.</p> 
<p>CHEVROLET V8 396,402,427,454</p> <p>Cast Iron Heads: 40-60-80 Ft.-Lbs. Alum. Short Bolts: 33-49-65 Ft.-Lbs. Alum. Long Bolts: 38-56-75 Ft.-Lbs.</p> 	<p>FORD SVO V8 302 SVO, 351C SVO, 351W SVO</p> <p>53-79-105 Ft.-Lbs.</p> 
<p>CHRYSLER V8 273,318,340,360</p> <p>50-75-100 Ft.-Lbs.</p> 	<p>FORD V8 429 Except Boss, 460</p> <p>70-105-140 Ft.-Lbs.</p> 
<p>CHRYSLER V8 361,383,400, 426 Wedge,440</p> <p>38-56-75 Ft.-Lbs.</p> 	<p>OLDS / BATTEN V8 356</p> <p>65-98-130 Ft.-Lbs.</p> 
<p>FORD 4 Cyl. 140</p> <p>40-60-80 Ft.-Lbs.</p> 	<p>PONTIAC 4 Cyl. 151, Crossflow Head and Super Duty</p> <p>11mm Bolts (79-84) 43-64-85 Ft.-Lbs. 1/2" Bolts (77-78) 53-79-105 Ft.-Lbs.</p> 

Performance Gaskets

Performance Assortment

MA100A – Nitroseal Head Gaskets

Part No.	Qty.	Application
1178SG	2	Chevrolet 283,302,307,327,350 (57-90)
3428SG	2	Ford 260,289,302 (Exc. Boss),351W (62-94)
3432SG	2	Chevrolet 302,327,350,400 (68-93)
3502SG	2	Ford 351,400 (70-79)
3536SG	2	Chrysler 273,318,340,360 (67-89)
3884SG	2	Chevrolet 96,402,427,454 (65-79)
JV311	1	Carbonless Impression Paper 2 Sheets 10" x 30" x .003"
MA137	1	Nitroseal Performance Header
MA90RK	1	High Performance Store Display Kit

MA152 – Solicor Head Gaskets

Part No.	Qty.	Application
1178SCR	2	Chevrolet 283,302,327,350 (68-90)
3428SCR	2	Ford 260,289,302 (Exc. Boss),351W (62-94)
5956SC	2	Ford 260,289,302 (Exc. Boss),351W (62-94)
5950SC	2	Chevrolet 396,402,427,454 (65-90) (4.370" Gasket Bore)
5946SC	2	Chevrolet 396,402,427,454 (65-90) (4.630" Gasket Bore)
JV311	1	Carbonless Impression Paper 2 Sheets 10" x 30" x .003"
MA146	1	Solicor Performance Header
MA90RK	1	High Performance Store Display Kit

MA88 – Performance Valve Cover Gaskets

Part No.	Qty.	Application
VS38110H	1	Chevrolet 262,283,302,305,307,327,350,400 (57-87)
VS38110HTC	1	Chevrolet 262,283,302,305,307,327,350,400 (57-87)
VS38110TC	2	Chevrolet 262,283,302,305,307,327,350,400 (57-87)
VS38300TC	2	Ford 221,255,260,289,302,351W (62-92)
VS38305TC	1	Oldsmobile 350,356,400,425,455 (65-85)
VS38322H	1	Chrysler 361,383,400,413,426,440 (63-80)
VS38420TC	1	Chevrolet 396,402,427,454 (65-90)
VS38421TC	1	Ford 429,460 (68-87)
VS39354TC	1	Pontiac 151 (2.5L) Crossflow Eng. (79-86)
VS39569TC	1	Chrysler 273,318,340,360 (64-91)
VS39763TC	1	Buick 196,231,252 (77-87)
MA138	1	Tuff-Cork Performance Header
MA90RK	1	High Performance Store Display Kit

Performance Gaskets

Performance Assortment

MA86A – Nitroseat Exhaust Gaskets

Part No.	Qty.	Application
95020SG	1	Chevrolet 396,402,427,454 1.87" Round Ports, Aluminum Heads (65-88)
95021SG	1	Chevrolet 396,402,427,454 1.82" x 1.88" Stock Ports (65-88)
95025SG	1	Ford 260,289,302 Exc. Boss,351W 1.13" x 1.53" Ports (62-88)
95026SG	1	Chrysler 361,383,400,413,426 Wedge,440 1.43" x 1.75" Ports (57-80)
95032SG	1	Ford 332,352,390,406,427,428 1.38" x 2.16" Ports (58-76)
95065SG	1	Chevrolet 262,267,283,302,305,307,327,350,400 1.55" x 1.63" Rectangular Ports 57-88)
95081SG	1	Ford 351C,351M,400 1.60" x 1.95" Ports, 2 Bbl. (70-82)
95090SG	2	Chevrolet 262,267,283,302,305,307,327,350,400 1.37" x 1.40" Stock Ports (57-88)
95091SG	1	Ford 429 Exc. Boss, 460 1.50" x 2.10" Ports, Exc. Cobra Jet & Super Cobra Jet (68-88)
95094SG	2	Chevrolet 262,267,283,302,305,307,327,350,400 1.50" x 1.50" Square Ports (57-88)
95095SG	1	Chrysler 273,318,340,360 1.25" x 1.75" Ports (66-88)
95098SG	1	Chevrolet 262,267,283,302,305,307,327,350,400 1.55" x 1.63" "D" Shaped Ports (57-88)
95100SG	1	Chevrolet 396,402,427,454 2.13" Round Ports (65-88)
F12381SG	2	Hooker, Hedman (Collector & Muffler Gasket)
F20410SG	2	Hooker, Hedman (Collector & Muffler Gasket)
F20412SG	2	Hush Thrush Muffler #510 (Collector & Muffler Gasket)
F20413SG	2	Hush Thrush Muffler #513 (Collector & Muffler Gasket)
F20416SG	2	Thorley, Hooker, Hedman (Collector & Muffler Gasket)
F20417SG	2	Thorley, Hooker, Hedman (Collector & Muffler Gasket)
MA137	1	Nitroseat Performance Header
MA90RK	1	High Performance Store Display Kit

MA87A – Nitroseat Intake Gaskets

Part No.	Qty.	Application
95005SG	1	Chevrolet 262,267,283,302,305,307,327,350,400 1.31" x 2.16" Rectangular Ports (57-88)
95007SG	1	Chevrolet 396,402,427,454 1.84" x 2.05" Oval Ports (65-88)
95008SG	1	Chevrolet 396,402,427,454 1.82" x 2.54" Rectangular Ports (65-88)
95016SG	2	Chevrolet 262,267,283,302,305,307,327,350,400 1.63" Round Ports (57-88)
95070SG	2	Chevrolet 262,267,283,302,305,307,327,350,400 1.28" x 2.10" Ports (57-88)
95074SG	1	Ford 429 Exc. Boss, 460 2.23" x 2.60" Ports, Cobra Jet & Super Cobra Jet (68-88)
95077SG	1	Ford 351C,351M,400 1.61" x 2.26" Ports, 2 Bbl. (70-82)
95078SG	1	Ford 351C 1.85" x 2.62" Ports, 4 Bbl. (70-74)
95102SG	1	Chrysler 273,318,340,360 1.16" x 2.27" Ports, 4 Bbl. (66-88)
95109SG	1	Ford 429 Exc. Boss, 460 1.98" x 2.26" Ports, Cobra Jet & Super Cobra Jet (57-88)
95112SG	1	Chevrolet 262,267,283,302,305,307,327,350,400 1.38" x 2.28" Rectangular Ports (57-88)
95113SG	1	Chevrolet 262,267,283,302,305,307,327,350,400 1.34" x 2.21" Rectangular Ports (57-88)
95128SG	2	Chevrolet Small Block, w/Blocked Heat Crossover 1.23" x 1.99" (57-85)
95129SG	1	Chevrolet Small Block, w/Open Heat Crossover 1.23" x 1.99" (57-85)
MA137	1	Nitroseat Performance Header
MA90RK	1	High Performance Store Display Kit

Acura

Engine Index

Engine	Year	Block
1590CC (1.6L) D16A1 DOHC 16 Valve	1986-1989	1
1678CC (1.7L) B17A1 V-TEC DOHC	1992-1993	2
1797CC (1.8L) B18C1 V-TEC DOHC	1994-2001	3
1797CC (1.8L) B18C5 DOHC	1997-2001	4
1834CC (1.8L) B18A1 DOHC	1990-1993	5
1834CC (1.8L) B18B1 DOHC	1994-2001	6
2156CC (2.2L) F22B1 V-TEC SOHC	1997	7
2254CC (2.3L) F23A1 V-TEC SOHC	1998-1999	8
2451CC (2.5L) G25A1 SOHC	1992-1994	9

Engine	Year	Block
2451CC (2.5L) G25A4 SOHC	1995-1997	10
2494CC (2.5L) C25A1 SOHC	1986-1987	11
2675CC (2.7L) C27A1 SOHC	1987-1990	12
2997CC (3.0L) J30A1 V-TEC SOHC Honda	1997-1999	13
3206CC (3.2L) C32A1 SOHC	1991-1995	14
3206CC (3.2L) C32A6 SOHC	1996-1998	15
3210CC (3.2L) J32A1 V-TEC SOHC	1999-2003	16
3210CC (3.2L) J32A2 V-TEC SOHC	2001-2003	17

Model Index

Model	Engine	Year	Block
2.2CL	2156CC (2.2L) F22B1 V-TEC SOHC	1997	7
2.3CL	2254CC (2.3L) F23A1 V-TEC SOHC	1998-1999	8
2.5TL	2451CC (2.5L) G25A4 SOHC	1995-1997	10
3.0CL	2997CC (3.0L) J30A1 V-TEC SOHC Honda	1997-1999	13
3.2CL	3210CC (3.2L) J32A1 V-TEC SOHC	2001-2004	16
3.2CL	3210CC (3.2L) J32A2 V-TEC SOHC	2001-2004	17
3.2TL	3206CC (3.2L) C32A6 SOHC	1996-1998	15
3.2TL	3210CC (3.2L) J32A1 V-TEC SOHC	1999-2003	16
3.2TL	3210CC (3.2L) J32A2 V-TEC SOHC	2002-2003	17

Model	Engine	Year	Block
Integra	1590CC (1.6L) D16A1 DOHC 16 Valve	1986-1989	1
Integra	1678CC (1.7L) B17A1 V-TEC DOHC	1992-1993	2
Integra	1797CC (1.8L) B18C5 DOHC	1997-2001	4
Integra	1797CC (1.8L) B18C1 V-TEC DOHC	1994-2001	3
Integra	1834CC (1.8L) B18B1 DOHC	1994-2001	6
Integra	1834CC (1.8L) B18A1 DOHC	1990-1993	5
Legend	2494CC (2.5L) C25A1 SOHC	1986	11
Legend	2675CC (2.7L) C27A1 SOHC	1987-1990	12
Legend	3206CC (3.2L) C32A1 SOHC	1991-1995	14
Vigor	2451CC (2.5L) G25A1 SOHC	1992-1994	9

1 1590CC (1.6L) D16A1 DOHC 16 Valve 4 Cyl, 2.953in./75mm (1986-1989) 1

Part	Year	VIN	Model/Application	Part Number	Qty.
------	------	-----	-------------------	-------------	------

ENGINE GASKETS

Head Set	1988-1989			HS5825	1
	1986-1987			HS5774	1
Lower Set	1988-1989		(Requires Head Set To Make Full Set)	CS5825	1
Cylinder Head Gasket	1988-1989			Nitroseal 5825	1
	1986-1987			Nitroseal 5774	1
Valve Cover Set	1986-1989		(Contains Valve Cover Washers, Contains Spark Plug Tube Seals)	Cork Rubber VS50050	1
Valve Stem Seal, Exh.	1988-1989			B45595	8
	1986-1987			B45521	8
Valve Stem Seal, Int.	1988-1989			B45634	8
	1986-1987			B45594	8
Manifold Set, Exhaust	1986-1989			MS15545	1
Manifold Set, Intake	1986-1989			MS15544	1
Oil Pan Set	1986-1989			Victo-Tech OS38142	1
Rear Main Seal	1986-1989			Rubber 67121	1
Timing Cover Set	1986-1989		(Camshaft Seals Not Included)	JV1059	1
Timing Cover Seal	1986-1989			66932	1

MISCELLANEOUS GASKETS

Camshaft Seal	1986-1989			66580	2
Exhaust Pipe Gasket	1989		(Ring Type 'A'), Catalytic Converter To Exhaust Pipe, Front	F7464	1
	1988-1989		(Ring Type 'A'), Catalytic Converter To Exhaust Pipe, Rear	F7412	1
	1986-1989		(Ring Type 'A'), Pipe To Manifold	F7413	1
	1988		(Ring Type 'F'), Catalytic Converter To Exhaust Pipe, Front	F7469	1
Throttle Body Gasket	1988-1989			G31062	1
	1986-1987			G31063	1
Water Outlet Gasket	1986-1989			Victo-Tech C24173	1
Water Pump Mount Gasket	1986-1989			Victo-Tech K31057	1

2	1678CC (1.7L) B17A1 V-TEC DOHC 4 Cyl, 3.189in./81mm (1992-1993)	2
----------	--	----------

Part	Year	VIN	Model/Application	Part Number	Qty.
ENGINE GASKETS					
Valve Cover Set	1992-1993			VS50299	1

3	1797CC (1.8L) B18C1 V-TEC DOHC 4 Cyl, 3.189in./81mm (1994-2001)	3
----------	--	----------

Part	Year	VIN	Model/Application	Part Number	Qty.
ENGINE GASKETS					
Head Set	1994-2001			HS54254A	1
Lower Set	1994-2001		(Requires Head Set To Make Full Set)	CS54254A	1
Cylinder Head Gasket	1994-2001		<i>Multi-Layered Steel</i>	54254	1
Valve Cover Set	1994-2001			VS50299	1
Valve Stem Seal, Exh.	1994-2001			B45627	8
Valve Stem Seal, Int.	1994-2001			B45626	8
Manifold Set, Exhaust	1994-2001		<i>Multi-Layered Steel</i>	MS15679	1
Manifold Set, Intake	1994-2001		(Contains Plenum Chamber Gasket)	MS16299	1
Oil Pan Set	1994-2001		<i>Victo-Tech</i>	OS32101	1
Rear Main Seal	1994-2001			67121	1
Timing Cover Seal	1994-2001			67152	1

MISCELLANEOUS GASKETS

Camshaft Seal Set	1994-2001			67640	1
Exhaust Pipe Gasket	1994-2001		(Ring Type 'A'), Pipe To Manifold	F7464	1
			(Ring Type 'A'), Pipe To Manifold	F7467	1
Therm. Mount Gasket	1994-2001		<i>Victo-Tech</i>	C31051	1
Throttle Body Gasket	1996-2001			G31636	1
	1994-1995		Integra	G31186	1
Valve Cover Grommet	1994-2001			B45689	8
Water Pump Mount Gasket	1994-2001			K31158	1

4	1797CC (1.8L) B18C5 DOHC 4 Cyl, 3.189in./81mm (1997-2001)	4
----------	--	----------

Part	Year	VIN	Model/Application	Part Number	Qty.
ENGINE GASKETS					
Cylinder Head Gasket	1997-2001		<i>Multi-Layered Steel</i>	54254	1
Valve Stem Seal, Exh.	1997-2001			B45627	8
Valve Stem Seal, Int.	1997-2001			B45626	8
Manifold Set, Exhaust	1997-2001		<i>Multi-Layered Steel</i>	MS15679	1
Rear Main Seal	1997-2001			67121	1
Timing Cover Seal	1997-2001			67152	1

MISCELLANEOUS GASKETS

Camshaft Seal Set	1997-2001			67640	1
Exhaust Pipe Gasket	1997-2001		(Ring Type 'A'), Pipe To Manifold	F7464	1
Therm. Mount Gasket	1997-2001		<i>Victo-Tech</i>	C31051	1
Valve Cover Grommet	1997-2001			B45689	8
Water Pump Mount Gasket	1997-2001			K31158	1

5	1834CC (1.8L) B18A1 DOHC 4 Cyl, 3.189in./81mm (1990-1993)	5
----------	--	----------

Part	Year	VIN	Model/Application	Part Number	Qty.
ENGINE GASKETS					
Head Set	1990-1993		(Exhaust Pipe Gasket Not Included)	HS5889	1
Lower Set	1990-1993		(Requires Head Set To Make Full Set)	CS5889	1
Cylinder Head Gasket	1990-1993		<i>Stainless Steel</i>	5889	1
Valve Cover Set	1990-1993		(Contains Spark Plug Tube Seals, Valve Cover Washers Not Included) <i>Victo-Tech</i>	VS50138	1
Valve Stem Seal, Exh.	1990-1993			B45678	8
Valve Stem Seal, Int.	1990-1993			B45634	8
Manifold Set, Exhaust	1990-1993		<i>Multi-Layered Steel</i>	MS15679	1

Acura

5 (cont.)	1834CC (1.8L) B18A1 DOHC 4 Cyl, 3.189in./81mm (1990-1993)				5 (cont.)
---------------------	--	--	--	--	---------------------

<i>Part</i>	<i>Year</i>	<i>VIN</i>	<i>Model/Application</i>	<i>Part Number</i>	<i>Qty.</i>
ENGINE GASKETS (cont.)					
Manifold Set, Intake	1990-1993			MS15678	1
Oil Pan Set	1990-1993		<i>Victo-Tech</i>	OS32101	1
Rear Main Seal	1990-1993		<i>Rubber</i>	67121	1
Timing Cover Set	1990-1993		(Camshaft Seals Not Included)	JV1121	1
Timing Cover Seal	1990-1993			67152	1

MISCELLANEOUS GASKETS					
Camshaft Seal	1990-1993			66580	2
E.G.R. Gasket	1990-1993			G30797	1
Exhaust Pipe Gasket	1992-1993		(Ring Type 'A'), Pipe To Manifold	F7467	1
	1990-1993		(Ring Type 'A'), Catalytic Converter To Exhaust Pipe, Rear	F7412	1
				Manual Transmission, (Ring Type 'A'), Catalytic Converter To Exhaust Pipe, Front	F7413
	1990-1991		(Ring Type 'A'), Pipe To Manifold	F14616	1
Therm. Mount Gasket	1990-1993		<i>Victo-Tech</i>	C31051	1
Throttle Body Gasket	1990-1993			G31159	1
Valve Cover Grommet	1990-1993			B45689	7
Water Outlet Gasket	1990-1993		To Be Replaced By C31051	C31157	1
Water Pump Mount Gasket	1990-1993			K31158	1

6	1834CC (1.8L) B18B1 DOHC 4 Cyl, 3.189in./81mm (1994-2001)				6
----------	--	--	--	--	----------

<i>Part</i>	<i>Year</i>	<i>VIN</i>	<i>Model/Application</i>	<i>Part Number</i>	<i>Qty.</i>
ENGINE GASKETS					
Cylinder Head Gasket	1994-2001		<i>Stainless Steel</i>	5889	1
Valve Cover Set	1994-2001		(Contains Spark Plug Tube Seals, Valve Cover Washers Not Included) <i>Victo-Tech</i>	VS50138	1
Valve Stem Seal, Exh.	1994-2001			B45678	8
Valve Stem Seal, Int.	1994-2001			B45634	8
Manifold Set, Exhaust	1994-2001		<i>Multi-Layered Steel</i>	MS15679	1
Oil Pan Set	1994-2001		<i>Victo-Tech</i>	OS32101	1
Rear Main Seal	1994-2001		<i>Rubber</i>	67121	1
Timing Cover Set	1994-2001			JV1079	1
	1994-1995		(Camshaft Seals Not Included)	JV1121	1
Timing Cover Seal	1994-2001			67152	1

MISCELLANEOUS GASKETS					
Camshaft Seal	1994-1998			66580	2
Exhaust Pipe Gasket	1994-2001		(Ring Type 'A'), Pipe To Manifold	F7467	1
Therm. Mount Gasket	1994-2001		<i>Victo-Tech</i>	C31051	1
Throttle Body Gasket	1996-2001		Automatic Transaxle	G31186	1
			Manual Transaxle	G31636	1
	1994-1995			G31186	1
Valve Cover Grommet	1994-2001			B45689	7
Water Outlet Gasket	1994-1998			C31051	1
Water Pump Mount Gasket	1994-2001			K31158	1

7	2156CC (2.2L) F22B1 V-TEC SOHC 4 Cyl, 3.346in./85mm (1997)				7
----------	---	--	--	--	----------

<i>Part</i>	<i>Year</i>	<i>VIN</i>	<i>Model/Application</i>	<i>Part Number</i>	<i>Qty.</i>
ENGINE GASKETS					
Head Set	1997		(Requires Lower Set To Make Full Set)	HS4051W	1
Lower Set	1997		(Requires Head Set To Make Full Set)	CS4051	1
Cylinder Head Gasket	1997		<i>Multi-Layered Steel</i>	4051	1
Valve Cover Set	1997		(Contains Valve Cover Grommets, Contains Spark Plug Tube Seals) <i>Victo-Tech</i>	VS50222	1
Valve Stem Seal, Exh.	1997			B45627	8

7 (cont.)	2156CC (2.2L) F22B1 V-TEC SOHC 4 Cyl, 3.346in./85mm (1997)				7 (cont.)
---------------------	---	--	--	--	---------------------

Part	Year	VIN	Model/Application	Part Number	Qty.
ENGINE GASKETS (cont.)					
Valve Stem Seal, Int.	1997			B45626	8
Manifold Set, Exhaust	1997			MS16163	1
Manifold Set, Intake	1997		(Contains Plenum Chamber Gasket)	MS16161	1
Plenum Chamber Gasket	1997			MS16162	1
Oil Pan Set	1997		Victo-Tech	OS32055	1
Rear Main Seal	1997		Rubber	67121	1
Timing Cover Set	1997		(Requires Oil Pan Set)	JV1187	1
Timing Cover Seal	1997			67591	1

MISCELLANEOUS GASKETS

Camshaft Seal	1997			67032	1
Exhaust Pipe Gasket	1997		Pipe To Manifold	F7467	2
			Catalytic Converter To Center Pipe	F12387	1
Therm. Mount Gasket	1997		Victo-Tech	C31051	1
Water Outlet Gasket	1997		Victo-Tech	C31052	1

8	2254CC (2.3L) F23A1 V-TEC SOHC 4 Cyl, 3.386in./86mm (1998-1999)				8
----------	--	--	--	--	----------

Part	Year	VIN	Model/Application	Part Number	Qty.
ENGINE GASKETS					
Head Set	1998-1999			HS54216	1
Lower Set	1998-1999		Requires Head Set To Make Full Set	CS54216	1
Cylinder Head Gasket	1998-1999		Multi-Layered Steel	54216	1
Valve Stem Seal, Exh.	1998-1999			B45627	8
Valve Stem Seal, Int.	1998-1999			B45626	8
Manifold Set, Exhaust	1998-1999			MS17846	1
Manifold Set, Intake	1998-1999		(Contains Plenum Chamber Gasket)	MS16319	1
Plenum Chamber Gasket	1998-1999		Beaded Steel	MS17800	1
Oil Pan Set	1998-1999			JV6	1
Rear Main Seal	1998-1999			67121	1
Timing Cover Set	1998-1999		(Contains Spark Plug Tube Seals) Victo-Tech	VS50222	1
Timing Cover Seal	1998-1999			67030	1

MISCELLANEOUS GASKETS

Aux. Shaft Seal	1998-1999			67031	1
Camshaft Seal	1998-1999			67032	1
E.G.R. Gasket	1998-1999			G30797	1
Therm. Mount Gasket	1998-1999		Victo-Tech	C31051	1
Throttle Body Gasket	1998-1999			G17801	1
Water Outlet Gasket	1998-1999		Victo-Tech	C31052	1
Water Pump Gasket	1998-1999		Victo-Tech	GS31184	1

9	2451CC (2.5L) G25A1 SOHC 5 Cyl, 3.346in./85mm (1992-1994)				9
----------	--	--	--	--	----------

Part	Year	VIN	Model/Application	Part Number	Qty.
ENGINE GASKETS					
Oil Pan Set	1992-1994		Silicone	JV6	1

10	2451CC (2.5L) G25A4 SOHC 5 Cyl, 3.346in./85mm (1995-1997)				10
-----------	--	--	--	--	-----------

Part	Year	VIN	Model/Application	Part Number	Qty.
ENGINE GASKETS					
Valve Cover Set	1995-1997			VS50298	1

Acura

11 2494CC (2.5L) C25A1 SOHC V6 Cyl, 3.307in./84mm (1986-1987) 11

Part	Year	VIN	Model/Application	Part Number	Qty.
ENGINE GASKETS					
Head Set	1986-1987			HS5760	1
Lower Set	1986-1987		(Requires Head Set To Make Full Set)	CS5760	1
Cylinder Head Gasket	1986-1987		<i>Nitroseal</i>	5760	2
Valve Cover Set	1986-1987		(Contains Valve Cover Washers, Valve Cover End Plugs Not Included) <i>Victo-Tech</i>	VS50276	1
Valve Stem Seal, Exh.	1986-1987			B45595	12
Valve Stem Seal, Int.	1986-1987			B45594	12
Manifold Set, Exhaust	1986-1987			MS15437	1
Manifold Set, Intake	1986-1987		(Contains Plenum Chamber Gasket)	MS15436	1
Plenum Chamber Gasket	1986-1987			MS12349	1
Oil Pan Set	1986-1987		<i>Victo-Tech</i>	OS32047	1
Rear Main Seal	1986-1987		<i>Rubber</i>	66986	1
Timing Cover Set	1986-1987		(Camshaft Seal Not Included)	JV1054	1
Timing Cover Seal	1986-1987			66984	1

MISCELLANEOUS GASKETS					
Camshaft Seal	1986-1987			66985	2
E.G.R. Gasket	1986-1987			G30797	1
Exhaust Pipe Gasket	1986-1987		(Ring Type 'A'), Pipe To Manifold	F7413	1
			(Ring Type 'A'), Resonator	F7468	1
			(Ring Type 'A'), Catalytic Converter To Exhaust Pipe	F14616	2
Push Rod Cover Set	1986-1987			PS39131	1
Vlv. Cover Plug Gasket	1986-1987			B45620	1
Water Outlet Gasket	1986-1987		<i>Victo-Tech</i>	C24173	1
Water Pump Mount Gasket	1986-1987			K31030	1

12 2675CC (2.7L) C27A1 SOHC V6 Cyl, 3.425in./87mm (1987-1990) 12

Part	Year	VIN	Model/Application	Part Number	Qty.
ENGINE GASKETS					
Head Set	1987-1990			HS5773	1
Lower Set	1987-1990		(Requires Head Set To Make Full Set)	CS5760	1
Cylinder Head Gasket	1987-1990		<i>Nitroseal</i>	5773	2
Valve Cover Set	1987-1990		(Contains Grommets, Contains Valve Cover End Plugs) <i>Victo-Tech</i>	VS50276	1
Valve Stem Seal, Exh.	1987-1990			B45595	12
Valve Stem Seal, Int.	1987-1990			B45594	12
Manifold Set, Exhaust	1987-1990			MS15437	1
Manifold Set, Intake	1987-1990		(Contains Plenum Chamber Gasket)	MS12341	1
Plenum Chamber Gasket	1987-1990			MS12351	1
Oil Pan Set	1987-1990		<i>Victo-Tech</i>	OS32047	1
Rear Main Seal	1987-1990		<i>Rubber</i>	66986	1
Timing Cover Set	1987-1990		(Camshaft Seal Not Included)	JV1054	1
Timing Cover Seal	1987-1990			66984	1

MISCELLANEOUS GASKETS					
Camshaft Seal	1987-1990			66985	2
E.G.R. Gasket	1987-1990			G30797	1
Exhaust Pipe Gasket	1987-1990		(Ring Type 'A'), Pipe To Manifold	F7413	1
			(Ring Type 'A'), Resonator	F7468	1
			(Ring Type 'A'), Catalytic Converter To Exhaust Pipe	F14616	2
Push Rod Cover Set	1987-1990			PS39131	1
Vlv. Cover Plug Gasket	1987-1990			B45620	1
Water Outlet Gasket	1987-1990		<i>Victo-Tech</i>	C24173	1

12 (cont.)	2675CC (2.7L) C27A1 SOHC V6 Cyl, 3.425in./87mm (1987-1990)				12 (cont.)
----------------------	---	--	--	--	----------------------

Part	Year	VIN	Model/Application	Part Number	Qty.
MISCELLANEOUS GASKETS (cont.)					
Water Pump Mount Gasket	1987-1990			K31030	1

13	2997CC (3.0L) J30A1 V-TEC SOHC Honda V6 Cyl, 3.386in./86mm (1997-1999)				13
-----------	---	--	--	--	-----------

Part	Year	VIN	Model/Application	Part Number	Qty.	
ENGINE GASKETS						
Head Set	1997-1999			HS54217	1	
Lower Set	1997-1999		Requires Head Set To Make Full Set	CS54217	1	
Cylinder Head Gasket	1997-1999		<i>Multi-Layered Steel</i>	54217	2	
Valve Cover Set	1997-1999		<i>Victo-Tech</i>	VS17822	1	
Valve Stem Seal, Exh.	1997-1999			B45627	12	
Valve Stem Seal, Int.	1997-1999			B45626	12	
Manifold Set, Exhaust	1997-1999		<i>Steel</i>	MS17814	1	
Manifold Set, Intake	1997-1999		<i>Multi-Layered Steel</i>	MS17808	1	
Plenum Chamber Gasket	1997-1999		Boost Chamber Vacuum Plate To Plenum	B17806	1	
			Plenum To Manifold	<i>Multi-Layered Steel</i>	MS17810	1
			Boost Chamber To Plenum	<i>Multi-Layered Steel</i>	MS17811	1
Oil Pan Set	1997-1999			JV6	1	
Rear Main Seal	1997-1999			66986	1	
Timing Cover Seal	1997-1999			66984	1	

MISCELLANEOUS GASKETS

Camshaft Seal	1997-1999			67617	2
E.G.R. Gasket	1997-1999			G30797	1
Exhaust Pipe Gasket	1997-1999		(Ring Type 'A'), Pipe To Manifold	F7413	2
Throttle Body Gasket	1997-1999			G17807	1
Water By-Pass Gasket	1997-1999			C17813	1
Water Outlet Gasket	1997-1999			C31207	1
Water Pump Gasket	1997-1999			K17818	1

14	3206CC (3.2L) C32A1 SOHC V6 Cyl, 3.543in./90mm (1991-1995)				14
-----------	---	--	--	--	-----------

Part	Year	VIN	Model/Application	Part Number	Qty.	
ENGINE GASKETS						
Head Set	1991-1995			HS5915	1	
Lower Set	1991-1995		(Requires Head Set To Make Full Set)	CS5915	1	
Engine Kit Gasket Set	1991-1995			95-3498VR	1	
Cylinder Head Gasket	1991-1995		Left	<i>Nitroseal</i>	5915	1
			Right	<i>Nitroseal</i>	5916	1
Cyl. Head Spacer Shim	1991-1995		Requires Sealing Compound, Left	<i>Steel</i>	5915S	1
			Requires Sealing Compound, Right	<i>Steel</i>	5916S	1
Sealing Compound	1991-1995		(4 Ounce Brush Top Can)		JV66B	1
			(12 Ounce Spray Can)		JV66S	1
Valve Cover Set	1991-1995		(Contains Spark Plug Tube Seals And Washers)	<i>Cork Rubber</i>	VS50156	1
Valve Stem Seal, Exh.	1991-1995			B45627	12	
Valve Stem Seal, Int.	1991-1995			B45626	12	
Manifold Set, Exhaust	1991-1995		(Contains Exhaust Pipe Gasket)	MS16071	1	
Manifold Set, Intake	1991-1995		(Contains Plenum Chamber Gasket)	MS16069	1	
Oil Pan Set	1991-1995		Original Equipment Uses RTV	<i>Silicone</i>	JV6	1
Rear Main Seal	1991-1995			<i>Rubber</i>	66986	1
Timing Cover Set	1991-1995			JV1138	1	
Timing Cover Seal	1991-1995			66984	1	

MISCELLANEOUS GASKETS

Cam. Circular Plug	1991-1995		Rear	B45782	2
--------------------	-----------	--	------	--------	---

Acura

14 (cont.)	3206CC (3.2L) C32A1 SOHC V6 Cyl, 3.543in./90mm (1991-1995)	14 (cont.)
----------------------	---	----------------------

Part	Year	VIN	Model/Application	Part Number	Qty.
MISCELLANEOUS GASKETS (cont.)					
Camshaft Seal	1991-1995		Front	67238	2
E.G.R. Gasket	1991-1995			G30797	1
Exhaust Pipe Gasket	1991-1995		Catalytic Converter To Exhaust Pipe, Front	F7505	1
			Catalytic Converter To Exhaust Pipe, Rear	F7506	1
			(Ring Type 'A'), Pipe To Manifold	F14616	1
Therm. Housing Gasket	1991-1995			C31208	1
Therm. Mount Gasket	1991-1995			C31207	1
Throttle Body Gasket	1991-1995			G31210	1
Timing Cover Plate Set	1991-1995			JV1152	1
Water Pump Mount Gasket	1991-1995			GS31209	1

15	3206CC (3.2L) C32A6 SOHC V6 Cyl, 3.543in./90mm (1996-1998)	15
-----------	---	-----------

Part	Year	VIN	Model/Application	Part Number	Qty.
ENGINE GASKETS					
Lower Set	1996-1998		(Requires Head Set To Make Full Set)	CS5915	1
Cylinder Head Gasket	1996-1998		Left	Nitroseal 5915	1
			Right	Nitroseal 5916	1
Cyl. Head Spacer Shim	1996-1998		Requires Sealing Compound, Left	Steel 5915S	1
			Requires Sealing Compound, Right	Steel 5916S	1
Sealing Compound	1996-1998		(4 Ounce Brush Top Can)	JV66B	1
			(12 Ounce Spray Can)	JV66S	1
Valve Cover Set	1996-1998		(Contains Spark Plug Tube Seals And Washers)	Cork Rubber VS50156	1
Valve Stem Seal, Exh.	1996-1998			B45627	12
Valve Stem Seal, Int.	1996-1998			B45626	12
Manifold Set, Exhaust	1996-1998		(Contains Exhaust Pipe Gasket)	MS16071	1
Oil Pan Set	1996-1998		Original Equipment Uses RTV	Silicone JV6	1
Rear Main Seal	1996-1998			Rubber 66986	1
Timing Cover Set	1996-1998			JV1138	1
Timing Cover Seal	1996-1998			66984	1

MISCELLANEOUS GASKETS					
Cam. Circular Plug	1996-1998		Rear	B45782	2
Camshaft Seal	1996-1998		Front	67238	2
E.G.R. Gasket	1996-1998			G30797	1
Exhaust Pipe Gasket	1996-1998		Catalytic Converter To Exhaust Pipe, Front	F7505	1
			Catalytic Converter To Exhaust Pipe, Rear	F7506	1
			(Ring Type 'A'), Pipe To Manifold	F14616	1
Therm. Housing Gasket	1996-1997			C31208	1
Therm. Mount Gasket	1996-1998			C31207	1
Timing Cover Plate Set	1996-1998			JV1152	1

16	3210CC (3.2L) J32A1 V-TEC SOHC V6 Cyl, 3.504in./89mm (1999-2003)	16
-----------	---	-----------

Part	Year	VIN	Model/Application	Part Number	Qty.
ENGINE GASKETS					
Cylinder Head Gasket	1999			Multi-Layered Steel 54217	2
Valve Cover Set	1999-2003			Victo-Tech VS17822	1
Valve Stem Seal, Exh.	1999-2003			B45627	12
Valve Stem Seal, Int.	1999-2003			B45626	12
Manifold Set, Exhaust	2000-2003			Steel MS17814	1
Manifold Set, Intake	1999			Multi-Layered Steel MS17808	

16 3210CC (3.2L) J32A1 V-TEC SOHC V6 Cyl, 3.504in./89mm (1999-2003) **16**
(cont.) (cont.)

Part Year VIN Model/Application Part Number Qty.

ENGINE GASKETS (cont.)

Plenum Chamber Gasket	1999		Boost Chamber Vacuum Plate To Plenum	B17806	1
			Plenum To Manifold	Multi-Layered Steel	MS17810

MISCELLANEOUS GASKETS

Camshaft Seal	1999-2003			67617	2
E.G.R. Gasket	1999-2003			G30797	1
Exhaust Pipe Gasket	1999-2003		(Ring Type 'A'), Pipe To Manifold	F7413	2
			(Ring Type 'A'), Catalytic Converter To Exhaust Pipe	F12387	1
Water By-Pass Gasket	1999-2003			C17813	1
Water Outlet Gasket	1999-2003			C31207	1
Water Pump Gasket	1999-2003			K17818	1

17 3210CC (3.2L) J32A2 V-TEC SOHC V6 Cyl, 3.504in./89mm (2001-2003) **17**

Part Year VIN Model/Application Part Number Qty.

ENGINE GASKETS

Valve Cover Set	2002-2003			Victo-Tech	VS17822	1
Valve Stem Seal, Exh.	2001-2003				B45627	12
Valve Stem Seal, Int.	2001-2003				B45626	12
Manifold Set, Exhaust	2002-2003			Steel	MS17814	1

MISCELLANEOUS GASKETS

Camshaft Seal	2001-2003				67617	2
E.G.R. Gasket	2001-2003				G30797	1
Exhaust Pipe Gasket	2001-2003		(Ring Type 'A'), Pipe To Manifold	F7413	2	
			(Ring Type 'A'), Catalytic Converter To Exhaust Pipe	F12387	1	
Water By-Pass Gasket	2001-2003				C17813	1
Water Outlet Gasket	2001-2003				C31207	1
Water Pump Gasket	2001-2003				K17818	1

American Motors

Engine Index

<i>Engine</i>	<i>Year</i>	<i>Block</i>	<i>Engine</i>	<i>Year</i>	<i>Block</i>
121 CID (2.0L) OHV Audi	1977-1979	1	287 CID (4.7L) American Motors Co.	1963-1966	9
150 CID (2.5L) OHV American Motors Co.	1983-1986	2	290 CID (4.8L) American Motors Co.	1966-1969	10
151 CID (2.5L) Carbureted Pontiac	1980-1983	3	304 CID (5.0L) American Motors Co.	1970-1979	11
196 CID (3.2L) L-Head American Motors Co.	1957-1965	4	327 CID (5.4L) American Motors Co.	1958-1966	12
196 CID (3.2L) OHV American Motors Co.	1957-1965	5	343 CID (5.6L) American Motors Co.	1967-1969	13
199 CID (3.3L) American Motors Co.	1965-1970	6	360 CID (5.9L) American Motors Co.	1970-1978	14
232 CID (3.8L) American Motors Co.	1964-1979	7	390 CID (6.4L) American Motors Co.	1968-1970	15
258 CID (4.2L) American Motors Co.	1971-1988	8	401 CID (6.6L) American Motors Co.	1971-1976	16

Model Index

<i>Model</i>	<i>Engine</i>	<i>Year</i>	<i>Block</i>	<i>Model</i>	<i>Engine</i>	<i>Year</i>	<i>Block</i>
AMX	258 CID (4.2L) American Motors Co.	1978-1980	8	Ambassador	287 CID (4.7L) American Motors Co.	1965	9
AMX	290 CID (4.8L) American Motors Co.	1968-1969	10	Ambassador	290 CID (4.8L) American Motors Co.	1967-1969	10
AMX	304 CID (5.0L) American Motors Co.	1978-1979	11	Ambassador	304 CID (5.0L) American Motors Co.	1970-1974	11
AMX	343 CID (5.6L) American Motors Co.	1968-1969	13	Ambassador	327 CID (5.4L) American Motors Co.	1957-1966	12
AMX	360 CID (5.9L) American Motors Co.	1970	14	Ambassador	343 CID (5.6L) American Motors Co.	1967-1969	13
AMX	390 CID (6.4L) American Motors Co.	1968-1970	15	Ambassador	360 CID (5.9L) American Motors Co.	1970-1974	14
Ambassador	232 CID (3.8L) American Motors Co.	1965-1971	7	Ambassador	390 CID (6.4L) American Motors Co.	1968-1970	15
Ambassador	258 CID (4.2L) American Motors Co.	1971	8	Ambassador	401 CID (6.6L) American Motors Co.	1971-1974	16

American Motors

Model Index (cont.)

Model	Engine	Year	Block	Model	Engine	Year	Block
American	196 CID (3.2L) L-Head American Motors Co.	1957-1965	4	Javelin	401 CID (6.6L) American Motors Co.	1971-1974	16
American	196 CID (3.2L) OHV American Motors Co.	1960-1965	5	Marlin	232 CID (3.8L) American Motors Co.	1965-1966	7
American	199 CID (3.3L) American Motors Co.	1967-1970	6	Marlin	287 CID (4.7L) American Motors Co.	1965-1966	9
American	232 CID (3.8L) American Motors Co.	1964-1969	7	Marlin	290 CID (4.8L) American Motors Co.	1967	10
American	290 CID (4.8L) American Motors Co.	1967-1969	10	Marlin	327 CID (5.4L) American Motors Co.	1965-1966	12
American	343 CID (5.6L) American Motors Co.	1967	13	Marlin	343 CID (5.6L) American Motors Co.	1967	13
Concord	121 CID (2.0L) OHV Audi	1978-1979	1	Matador	232 CID (3.8L) American Motors Co.	1971-1974	7
Concord	151 CID (2.5L) Carbureted Pontiac	1980-1983	3	Matador	258 CID (4.2L) American Motors Co.	1971-1978	8
Concord	232 CID (3.8L) American Motors Co.	1978-1979	7	Matador	304 CID (5.0L) American Motors Co.	1971-1978	11
Concord	258 CID (4.2L) American Motors Co.	1978-1983	8	Matador	360 CID (5.9L) American Motors Co.	1971-1978	14
Concord	304 CID (5.0L) American Motors Co.	1978-1979	11	Matador	401 CID (6.6L) American Motors Co.	1972-1976	16
Eagle	150 CID (2.5L) OHV American Motors Co.	1983-1986	2	Pacer	232 CID (3.8L) American Motors Co.	1975-1978	7
Eagle	151 CID (2.5L) Carbureted Pontiac	1980-1983	3	Pacer	258 CID (4.2L) American Motors Co.	1975-1980	8
Eagle	258 CID (4.2L) American Motors Co.	1980-1988	8	Pacer	304 CID (5.0L) American Motors Co.	1975-1979	11
Eagle	151 CID (2.5L) Carbureted Pontiac	1981-1982	3	Rambler	196 CID (3.2L) OHV American Motors Co.	1958-1960	5
Kammback Eagle	258 CID (4.2L) American Motors Co.	1981-1982	8	Rambler	232 CID (3.8L) American Motors Co.	1969	7
Kammback Eagle SX/4	151 CID (2.5L) Carbureted Pontiac	1981-1983	3	Rambler	290 CID (4.8L) American Motors Co.	1969	10
Eagle SX/4	258 CID (4.2L) American Motors Co.	1981-1983	8	Rambler	390 CID (6.4L) American Motors Co.	1969	15
Gremlin	121 CID (2.0L) OHV Audi	1977-1978	1	Rambler	196 CID (3.2L) OHV American Motors Co.	1961-1964	5
Gremlin	199 CID (3.3L) American Motors Co.	1970	6	Rambler Classic	199 CID (3.3L) American Motors Co.	1965-1966	6
Gremlin	232 CID (3.8L) American Motors Co.	1970-1978	7	Rambler Classic	232 CID (3.8L) American Motors Co.	1964-1966	7
Gremlin	258 CID (4.2L) American Motors Co.	1971-1978	8	Rambler Classic	287 CID (4.7L) American Motors Co.	1963-1966	9
Gremlin	304 CID (5.0L) American Motors Co.	1970-1978	11	Rambler Classic	290 CID (4.8L) American Motors Co.	1966	10
Hornet	199 CID (3.3L) American Motors Co.	1970	6	Rambler Classic	327 CID (5.4L) American Motors Co.	1963-1966	12
Hornet	232 CID (3.8L) American Motors Co.	1970-1978	7	Rebel	232 CID (3.8L) American Motors Co.	1967	7
Hornet	258 CID (4.2L) American Motors Co.	1971-1978	8	Rebel	290 CID (4.8L) American Motors Co.	1967-1969	10
Hornet	304 CID (5.0L) American Motors Co.	1970-1978	11	Rebel	343 CID (5.6L) American Motors Co.	1967-1969	13
Hornet	360 CID (5.9L) American Motors Co.	1970-1977	14	Rebel	360 CID (5.9L) American Motors Co.	1970	14
Javelin	232 CID (3.8L) American Motors Co.	1968-1969	7	Rebel	390 CID (6.4L) American Motors Co.	1968-1970	15
Javelin	258 CID (4.2L) American Motors Co.	1971-1972	8	Spirit	151 CID (2.5L) Carbureted Pontiac	1980-1982	3
Javelin	304 CID (5.0L) American Motors Co.	1970-1974	11	Spirit	232 CID (3.8L) American Motors Co.	1979	7
Javelin	343 CID (5.6L) American Motors Co.	1968-1969	13	Spirit	258 CID (4.2L) American Motors Co.	1979-1983	8
Javelin	360 CID (5.9L) American Motors Co.	1970-1974	14	Spirit	304 CID (5.0L) American Motors Co.	1979	11
Javelin	390 CID (6.4L) American Motors Co.	1968-1970	15				

1 121 CID (2.0L) OHV Audi 4 Cyl, 3.406in./86.5mm (1977-1979) 1

Part	Year	VIN	Model/Application	Part Number	Qty.
ENGINE GASKETS					
Head Set	1977-1979		(Exhaust Pipe Gasket Not Included)	HS3649W	1

1 121 CID (2.0L) OHV Audi 4 Cyl, 3.406in./86.5mm (1977-1979) **1**
(cont.) (cont.)

Part Year VIN Model/Application Part Number Qty.

ENGINE GASKETS (cont.)

Lower Set	1977-1979		(Requires Head Set To Make Full Set)	CS3649W	1
Cylinder Head Gasket	1977-1979		VR2000	3649	1
Valve Cover Set	1977-1979		Cork Rubber	VS38426	1
Valve Stem Seal, Exh.	1977-1979			B20169	4
Valve Stem Seal, Int.	1977-1979			B20169	4
Manifold Set, Exhaust	1977-1979			MS15253	1
Manifold Set, Intake	1977-1979			MS15319	1
Oil Pan Set	1977-1979		Cork Rubber	OS30301	1
Rear Main Seal Set	1977-1979			JV510	1
Timing Cover Set	1977-1979			JV956	1
Timing Cover Seal	1977-1979			66637	1

MISCELLANEOUS GASKETS

Carb. Mount Gasket	1977-1979		2 Barrel Carburetor	G26786	3
E.G.R. Gasket	1977-1979			G26315	1
Exhaust Pipe Gasket	1977-1979		(Ring Type 'D'), Pipe To Manifold	F7171	1
			Catalytic Converter	F10076	1
Fuel Pump Gasket	1977-1979			D20286	1
Water Outlet Gasket	1977-1979			C20315	1
Water Pump Mount Gasket	1977-1979			K27256	1

2 150 CID (2.5L) OHV American Motors Co. 4 Cyl, 3.875in./98.4mm (1983-1986) **2**

Part Year VIN Model/Application Part Number Qty.

ENGINE GASKETS

Head Set	1983-1986			HS3799	1
Full Set	1983-1986			FS3799	1
Engine Kit Gasket Set	1983-1986		1 Barrel Carburetor, (Valve Stem Seals Not Included), Use With Part Numbers B45410 (4), B45411 (4)	95-3341VR	1
Cylinder Head Gasket	1983-1986			3799	1
Valve Cover Set	1983-1986		Victo-Tech	VS50001	1
Valve Stem Seal, Exh.	1983-1986			B45411	4
Valve Stem Seal, Int.	1983-1986			B45410	4
Manifold Set, Int. & Exh.	1983-1986			MS15963X	1
Oil Pan Set	1983-1986		Cork Rubber	OS32030	1
Rear Main Seal Set	1983-1986			JV553	1
Timing Cover Set	1983-1986			JV878	1
Timing Cover Seal	1983-1986			46134	1

MISCELLANEOUS GASKETS

E.G.R. Gasket	1984-1986			G26315	1
Exhaust Pipe Gasket	1983-1986		Catalytic Converter	F10076	1
				Tuff-Cork	D27094TC
Fuel Pump Gasket	1983-1986			D27094	1
Water Outlet Gasket	1983-1986			C24003	1
Water Pump Mount Gasket	1983-1986			K27110	1

3 151 CID (2.5L) Carbureted Pontiac 4 Cyl, 4.000in./101.6mm (1980-1983) **3**

Part Year VIN Model/Application Part Number Qty.

ENGINE GASKETS

Head Set	1980-1983		(Exhaust Pipe Gasket Not Included)	HS3684	1
Full Set	1980-1983		(Exhaust Pipe Gasket Not Included)	FS3684	1
Engine Kit Gasket Set	1980-1983			95-3399VR	1
Cylinder Head Gasket	1980-1983		VR2000	3684	1

American Motors

3 (cont.)	151 CID (2.5L) Carbureted Pontiac 4 Cyl, 4.000in./101.6mm (1980-1983)				3 (cont.)
---------------------	--	--	--	--	---------------------

Part	Year	VIN	Model/Application	Part Number	Qty.
ENGINE GASKETS (cont.)					
Cylinder Head Gasket (cont.)	1980-1981		Field Fix For Excessive Carbon Build Up, (Thicker Head Gasket)		
			<i>VR2000</i>	CH3548T	1
Valve Cover Set	1980-1983		<i>Cork Rubber</i>	VS39354	1
			<i>High Temperature Tuff-Cork</i>	VS39354HTC	1
			<i>Victo-Tech</i>	VS39354R	1
Valve Stem Seal, Exh.	1980-1983			B45229	4
Valve Stem Seal, Int.	1980-1983			B45229	4
Manifold Set, Exhaust	1980-1983			MS15303	1
Manifold Set, Intake	1980-1983			MS15304	1
Oil Pan Set	1980-1983		<i>Cork Rubber</i>	OS30539X	1
			<i>Tuff-Cork</i>	OS30539XTC	1
Rear Main Seal Set	1980-1983			JV553	1
Crank Repair Sleeve	1980-1983		Use With Part Number A510, Rear <i>Nickel Plated Formed Steel</i>	A339	1
Timing Cover Set	1980-1983			JV883	1
			(Contains Repair Sleeve)	JV1136	1
Timing Cover Seal	1980-1983			48277SF	1
Harmonic Balancer Repair Sleeve	1980-1983		Use With Part Number A504 <i>Nickel Plated Formed Steel, .013" Thickness</i>	A228	1

MISCELLANEOUS GASKETS

Air Cleaner Mount Gasket	1980-1983		2 Barrel Carburetor	G26672	1
Carb. Mount Gasket	1980-1983		2 Barrel Carburetor	G14147	1
E.G.R. Gasket	1980-1983			G17797	1
Exhaust Pipe Gasket	1983		(Ring Type 'F'), Pipe To Manifold	F7398	1
	1980-1983		Catalytic Converter	F10076	1
	1982		(Ring Type 'F'), Front Pipe To Front Intermediate Pipe	F7209	1
			(Ring Type 'E'), Pipe To Manifold	F7270	1
	1980-1982		(Ring Type 'F'), Front Pipe To Front Intermediate Pipe, Pipe To Manifold	F7209	1
1980-1981		(Flange Type), Pipe To Manifold	F20401	1	
Fuel Pump Gasket	1980-1983			D27094	1
			<i>Tuff-Cork</i>	D27094TC	1
Push Rod Cover Set	1980-1983		<i>Cork Rubber</i>	PS38792	1
Water Outlet Gasket	1980-1983			C24109	1
Water Pump Mount Gasket	1980-1983			K26545	1

4	196 CID (3.2L) L-Head American Motors Co. 6 Cyl, 3.125in./79.4mm (1957-1965)				4
----------	---	--	--	--	----------

Part	Year	VIN	Model/Application	Part Number	Qty.
------	------	-----	-------------------	-------------	------

ENGINE GASKETS

Head Set	1957-1965		(Exhaust Pipe Gasket Not Included)	HS1151	1
Cylinder Head Gasket	1957-1965		<i>VR2000</i>	1151	1
Rear Main Seal Set	1964-1965			JV741	1
Timing Cover Seal	1957-1965			46134	1

MISCELLANEOUS GASKETS

Air Cleaner Mount Gasket	1963-1965		1 Barrel Carburetor	G26540	1
Carb. Mount Gasket	1957-1965		1 Barrel Carburetor	G5260EK	1
Exhaust Pipe Gasket	1964-1965		(Ring Type 'D'), Pipe To Manifold	F7171	1
Fuel Pump Gasket	1957-1965			D27094	1
Push Rod Cover Set	1957-1965		<i>Cork Rubber</i>	VS38009	1
Water Outlet Gasket	1957-1965			C25487	1

5 196 CID (3.2L) OHV American Motors Co. 6 Cyl, 3.125in./79.4mm (1957-1965) 5

Part	Year	VIN	Model/Application	Part Number	Qty.
ENGINE GASKETS					
Valve Cover Set	1957-1965		Cast Iron Engine <i>Victo-Tech</i>	VS29477	1
Rear Main Seal Set	1964-1965		Cast Iron Engine	JV741	1
Timing Cover Seal	1957-1965		Cast Iron Engine	46134	1

MISCELLANEOUS GASKETS					
Air Cleaner Mount Gasket	1957-1962		Cast Iron Engine, 1 Barrel Carburetor	G26540	1
Carb. Mount Gasket	1957-1965		Cast Iron Engine, 1 Barrel Carburetor	G5260EK	1
Exhaust Pipe Gasket	1964-1965		Cast Iron Engine, (Ring Type 'D'), Pipe To Manifold	F7171	1
Fuel Pump Gasket	1957-1965		Cast Iron Engine	D27094	1
Push Rod Cover Set	1957-1965		Cast Iron Engine <i>Cork Rubber</i>	VS38009	1
Water Outlet Gasket	1957-1965		Cast Iron Engine	C25487	1

6 199 CID (3.3L) American Motors Co. 6 Cyl, 3.750in./95.3mm (1965-1970) 6

Part	Year	VIN	Model/Application	Part Number	Qty.
------	------	-----	-------------------	-------------	------

ENGINE GASKETS					
Head Set	1965-1970		(Exhaust Pipe Gasket Not Included)	HS1199VC	1
Full Set	1965-1970		(Exhaust Pipe Gasket Not Included)	FS1199VC	1
Engine Kit Gasket Set	1965-1970			95-3020VR	1
Cylinder Head Gasket	1965-1970		<i>VR2000</i>	1199	1
Valve Cover Set	1965-1970		<i>Cork Rubber</i>	VS39695	1
			<i>High Temperature Cork Rubber</i>	VS39695H	1
Valve Stem Seal, Exh.	1965-1970			B45323	6
Valve Stem Seal, Int.	1965-1970			B45323	6
Manifold Set, Int. & Exh.	1965-1970			MS15510	1
Oil Pan Set	1965-1970		<i>Cork Rubber</i>	OS30990	1
Rear Main Seal Set	1965-1970			JV1611	1
Timing Cover Set	1965-1970			JV878	1
			(Contains Repair Sleeve)	JV1130	1
Timing Cover Seal	1965-1970			46134	1
Harmonic Balancer Repair Sleeve	1965-1970		Use With Part Number A504 <i>Nickel Plated Formed Steel, .013" Thickness</i>	A221	1

MISCELLANEOUS GASKETS					
Air Cleaner Mount Gasket	1965-1970		1 Barrel Carburetor	G26540	1
Carb. Mount Gasket	1965-1970		1 Barrel Carburetor	G26639	2
Exhaust Pipe Gasket	1965-1970		(Ring Type 'D'), Pipe To Manifold	F7171	1
Fuel Pump Gasket	1965-1970			D27094	1
Water Outlet Gasket	1968-1970			C24003	1
	1965-1967			C26618	1
Water Pump Mount Gasket	1965-1970			K27110	1

7 232 CID (3.8L) American Motors Co. 6 Cyl, 3.750in./95.3mm (1964-1979) 7

Part	Year	VIN	Model/Application	Part Number	Qty.
------	------	-----	-------------------	-------------	------

ENGINE GASKETS					
Head Set	1964-1979		(Exhaust Pipe Gasket Not Included)	HS1199VC	1
Full Set	1965-1979		(Exhaust Pipe Gasket Not Included)	FS1199VC	1
	1964		Water Pump Gasket Not Included, (Exhaust Pipe Gasket Not Included)	FS1199VC	1
Engine Kit Gasket Set	1964-1979			95-3020VR	1
Cylinder Head Gasket	1964-1979		<i>VR2000</i>	1199	1
Valve Cover Set	1964-1979		<i>Cork Rubber</i>	VS39695	1
			<i>High Temperature Cork Rubber</i>	VS39695H	1
Valve Stem Seal, Exh.	1964-1979			B45323	6
Valve Stem Seal, Int.	1964-1979			B45323	6

American Motors

7 (cont.)	232 CID (3.8L) American Motors Co. 6 Cyl, 3.750in./95.3mm (1964-1979)				7 (cont.)
---------------------	--	--	--	--	---------------------

Part	Year	VIN	Model/Application	Part Number	Qty.
ENGINE GASKETS (cont.)					
Manifold Set, Int. & Exh.	1964-1979			MS15510	1
Oil Pan Set	1964-1979		Cork Rubber	OS30990	1
Rear Main Seal Set	1964-1979			JV1611	1
Timing Cover Set	1964-1979			JV878	1
			(Contains Repair Sleeve)	JV1130	1
Timing Cover Seal	1967-1979			46134	1
Harmonic Balancer Repair Sleeve	1964-1979		Use With Part Number A504 Nickel Plated Formed Steel, .013" Thickness	A221	1

MISCELLANEOUS GASKETS

Air Cleaner Mount Gasket	1964-1979		1 Barrel Carburetor	G26540	1
	1964-1971		2 Barrel Carburetor	G25936	1
Carb. Mount Gasket	1964-1979		1 Barrel Carburetor	G26639	2
E.G.R. Gasket	1973-1979			G26315	1
Exhaust Pipe Gasket	1975-1979		Catalytic Converter	F10076	1
	1964-1979		(Ring Type 'D'), Pipe To Manifold	F7171	1
Fuel Pump Gasket	1964-1979			D27094	1
			Tuff-Cork	D27094TC	1
Water Outlet Gasket	1968-1979			C24003	1
	1964-1967			C26618	1
Water Pump Mount Gasket	1965-1979			K27110	1

8	258 CID (4.2L) American Motors Co. 6 Cyl, 3.750in./95.3mm (1971-1988)				8
----------	--	--	--	--	----------

Part	Year	VIN	Model/Application	Part Number	Qty.
ENGINE GASKETS					
Head Set	1986-1988			HS1199W	1
	1981-1985		Except Engine Build Code Stamped On Right Side Of Block with 4th Digit M, (Exhaust Pipe Gasket Not Included)	HS3957	1
	1971-1980		(Exhaust Pipe Gasket Not Included)	HS1199VC	1
Full Set	1986-1988			FS1199W	1
	1981-1985		Except Engine Build Code Stamped On Right Side Of Block with 4th Digit M, (Exhaust Pipe Gasket Not Included)	FS3957	1
	1971-1980		(Exhaust Pipe Gasket Not Included)	FS1199VC	1
Engine Kit Gasket Set	1986-1988		Plastic Valve Cover	95-3100VR	1
			Aluminum Valve Cover	95-3342VR	1
	1981-1985		(Valve Cover Set Not Included), Use With Part Number VS50061	95-3437VR	1
	1971-1980			95-3020VR	1
Cylinder Head Gasket	1986-1988		VR2000	1199	1
	1981-1985		Except Engine Build Code Stamped On Right Side Of Block with 4th Digit M VR2000	3957	1
	1971-1980		VR2000	1199	1
Valve Cover Set	1981-1988		Tuff-Cork	VS50000TC	1
			Cork Rubber	VS50061	1
	1971-1980		Cork Rubber	VS39695	1
			High Temperature Cork Rubber	VS39695H	1
Valve Stem Seal, Exh.	1971-1988			B45323	6
Valve Stem Seal, Int.	1971-1988			B45323	6
Manifold Set, Int. & Exh.	1971-1988			MS15510	1
Oil Pan Set	1971-1988		Cork Rubber	OS30990	1
Rear Main Seal Set	1971-1988			JV1611	1
Timing Cover Set	1971-1988			JV878	1
			(Contains Repair Sleeve)	JV1130	1
Timing Cover Seal	1971-1988			46134	1

8 258 CID (4.2L) American Motors Co. 6 Cyl, 3.750in./95.3mm (1971-1988) **8**
(cont.) (cont.)

Part Year VIN Model/Application Part Number Qty.

ENGINE GASKETS (cont.)

Harmonic Balancer Repair Sleeve	1971-1988		Use With Part Number A504 <i>Nickel Plated Formed Steel, .013" Thickness</i>	A221	1
---------------------------------	-----------	--	---	------	---

MISCELLANEOUS GASKETS

Air Cleaner Mount Gasket	1976-1988		2 Barrel Carburetor	G25936	1
	1971-1979		1 Barrel Carburetor	G26540	1
Carb. Mount Gasket	1979-1988		2 Barrel Carburetor	G26827	2
	1979		1 Barrel Carburetor	G26826	1
	1976-1978		2 Barrel Carburetor	G25509	2
	1971-1978		1 Barrel Carburetor	G26639	2
E.G.R. Gasket	1973-1988			G26315	1
Exhaust Pipe Gasket	1975-1988		Catalytic Converter	F10076	1
	1971-1985		(Ring Type 'D'), Pipe To Manifold	F7171	1
Fuel Pump Gasket	1971-1988			D27094	1
				<i>Tuff-Cork</i> D27094TC	1
Water Outlet Gasket	1971-1988			C24003	1
Water Pump Mount Gasket	1971-1988			K27110	1

9 287 CID (4.7L) American Motors Co. V8 Cyl, 3.750in./95.3mm (1963-1966) **9**

Part Year VIN Model/Application Part Number Qty.

ENGINE GASKETS

Head Set	1963-1966		(Exhaust Pipe Gasket Not Included)	HS1137VX	1
Full Set	1963-1966		(Exhaust Pipe Gasket Not Included)	FS1137BX	1
Cylinder Head Gasket	1963-1966			<i>VR2000</i> 1137VC	2
Valve Cover Set	1963-1966			<i>Victo-Tech</i> VS27546	1
Valve Stem Seal, Exh.	1963-1966			B45323	8
Valve Stem Seal, Int.	1963-1966			B45323	8
Manifold Set, Exhaust	1963-1966			MS15228	1
Manifold Set, Intake	1963-1966			MS15054	1
Oil Pan Set	1963-1966			<i>Cork Rubber</i> OS30569	1
Rear Main Seal Set	1963-1966			JV696	1
Timing Cover Set	1963-1966			JV796	1
Timing Cover Seal	1963-1966			46019	1

MISCELLANEOUS GASKETS

Air Cleaner Mount Gasket	1964-1966		2 Barrel Carburetor	G25936	1
Exhaust Pipe Gasket	1963-1966		(Ring Type 'D'), Pipe To Manifold	F5360C	1
Fuel Pump Gasket	1963-1966			D27094	1
Push Rod Cover Set	1963-1966			PS38754	1
Water Manifold Gasket	1963-1966		To Block	C24110	2
Water Outlet Gasket	1963-1966			C25487	1

10 290 CID (4.8L) American Motors Co. V8 Cyl, 3.750in./95.3mm (1966-1969) **10**

Part Year VIN Model/Application Part Number Qty.

ENGINE GASKETS

Head Set	1966-1969		(Exhaust Pipe Gasket Not Included, Intake Manifold Gasket Not Included, Exhaust Manifold Gasket Not Included)	HS3484VC	1
Full Set	1966-1969		(Exhaust Pipe Gasket Not Included, Intake Manifold Gasket Not Included, Exhaust Manifold Gasket Not Included)	FS3484VC	1
Engine Kit Gasket Set	1966-1969		(Intake Manifold Gasket Not Included), Use With Part Number MS15922	95-3340VR	1
Cylinder Head Gasket	1966-1969			<i>VR2000</i> 3484VC	2
Valve Cover Set	1966-1969			<i>Cork Rubber</i> VS28317	1
Valve Stem Seal, Exh.	1966-1969			B45298	8
Valve Stem Seal, Int.	1966-1969			B45298	8

American Motors

10 290 CID (4.8L) American Motors Co. V8 Cyl, 3.750in./95.3mm (1966-1969) **10**
(cont.) (cont.)

Part	Year	VIN	Model/Application	Part Number	Qty.
ENGINE GASKETS (cont.)					
Manifold Set, Exhaust	1966-1969			MS14743	1
Manifold Set, Intake	1966-1969			MS15922	1
Oil Pan Set	1966-1969		Cork Rubber	OS30538	1
Rear Main Seal Set	1966-1969			JV638	1
Timing Cover Set	1966-1969		(Repair Sleeve Not Included)	JV870	1
			(Contains Repair Sleeve)	JV928	1
Timing Cover Seal	1966-1969			46483	1
Harmonic Balancer Repair Sleeve	1966-1969		Ground Steel, .020" Thickness	66590RS	1
			Use With Part Number A500 Nickel Plated Formed Steel, .013" Thickness	A222	1

MISCELLANEOUS GASKETS					
Air Cleaner Mount Gasket	1967-1969		4 Barrel Carburetor	G27098	1
	1966-1967		2 Barrel Carburetor	G25936	1
Carb. Mount Gasket	1968-1969		2 Barrel Carburetor, Carburetor To Insulator	G26043	1
	1967-1969		4 Barrel Carburetor	G14569	2
Exhaust Pipe Gasket	1966-1969		(Ring Type 'D'), Pipe To Manifold	F7171	2
Fuel Pump Gasket	1966-1969			D27094	1
Water Manifold Gasket	1966-1967		To Block	C24110	2
Water Outlet Gasket	1966-1969			C24111	1
Water Pump Mount Gasket	1966-1969			K14740	1

11 304 CID (5.0L) American Motors Co. V8 Cyl, 3.750in./95.3mm (1970-1979) **11**

Part	Year	VIN	Model/Application	Part Number	Qty.
ENGINE GASKETS					
Head Set	1971-1979		(Exhaust Pipe Gasket Not Included, Intake Manifold Gasket Not Included)	HS3484VC	1
	1970		Exhaust Manifold Gasket Not Included, (Exhaust Pipe Gasket Not Included, Intake Manifold Gasket Not Included)	HS3484VC	1
Full Set	1971-1979		(Exhaust Pipe Gasket Not Included, Intake Manifold Gasket Not Included)	FS3484VC	1
	1970		Exhaust Manifold Gasket Not Included, (Exhaust Pipe Gasket Not Included, Intake Manifold Gasket Not Included)	FS3484VC	1
Engine Kit Gasket Set	1970-1979		(Intake Manifold Gasket Not Included), Use With Part Number MS15922	95-3340VR	1
Cylinder Head Gasket	1970-1979		VR2000	3484VC	2
Valve Cover Set	1970-1979		Cork Rubber	VS28317	1
Valve Stem Seal, Exh.	1970-1979			B45298	8
Valve Stem Seal, Int.	1970-1979			B45298	8
Manifold Set, Exhaust	1971-1979			MS14143	1
	1970			MS14743	1
Manifold Set, Intake	1970-1979			MS15922	1
Oil Pan Set	1970-1979		Cork Rubber	OS30538	1
			Tuff-Cork	OS30538TC	1
Rear Main Seal Set	1970-1979			JV638	1
Timing Cover Set	1970-1979		(Repair Sleeve Not Included)	JV870	1
			(Contains Repair Sleeve)	JV928	1
Timing Cover Seal	1970-1979			46483	1
Harmonic Balancer Repair Sleeve	1970-1979		Ground Steel, .020" Thickness	66590RS	1
			Use With Part Number A500 Nickel Plated Formed Steel, .013" Thickness	A222	1

MISCELLANEOUS GASKETS					
Air Cleaner Mount Gasket	1970-1979		2 Barrel Carburetor	G27098	1

PASSENGER CAR

11 304 CID (5.0L) American Motors Co. V8 Cyl, 3.750in./95.3mm (1970-1979) **11**
(cont.) (cont.)

Part	Year	VIN	Model/Application	Part Number	Qty.
MISCELLANEOUS GASKETS (cont.)					
Carb. Mount Gasket	1974-1979		2 Barrel Carburetor, Carburetor To Insulator	G26044	1
	1971-1979		2 Barrel Carburetor, Insulator To Manifold	G26043	1
	1970-1972		2 Barrel Carburetor	G26043	1
Choke Tube Gasket	1973-1979			B45780	1
E.G.R. Gasket	1973-1979			G26315	1
Exhaust Pipe Gasket	1979		2.4" Pipe, (Ring Type 'D')	F7171	1
			2.8" Pipe, (Ring Type 'B')	F7201	1
	1978-1979		2.94" Pipe, (Ring Type 'B')	F7204	1
	1975-1979		Catalytic Converter	F10076	1
	1970-1979		2.4" Pipe, (Ring Type 'D'), Pipe To Manifold	F7171	1
			2.8" Pipe, (Ring Type 'B'), Pipe To Manifold	F7201	1
		2.94" Pipe, (Ring Type 'B'), Pipe To Manifold	F7204	1	
Fuel Pump Gasket	1970-1979			D27094	1
				<i>Tuff-Cork</i> D27094TC	1
Heat Riser Gasket	1971-1972			G12262	1
Water Outlet Gasket	1970-1979			C24111	1
Water Pump Mount Gasket	1970-1979			K14740	1

12 327 CID (5.4L) American Motors Co. V8 Cyl, 4.000in./101.6mm (1958-1966) **12**

Part	Year	VIN	Model/Application	Part Number	Qty.
ENGINE GASKETS					
Head Set	1958-1966		(Exhaust Pipe Gasket Not Included)	HS1137VX	1
Full Set	1958-1966		(Exhaust Pipe Gasket Not Included)	FS1137BX	1
Cylinder Head Gasket	1958-1966			<i>VR2000</i> 1137VC	2
Valve Cover Set	1958-1966			<i>Victo-Tech</i> VS27546	1
Valve Stem Seal, Exh.	1958-1966			B45323	8
Valve Stem Seal, Int.	1958-1966			B45323	8
Manifold Set, Exhaust	1958-1966			MS15228	1
Manifold Set, Intake	1958-1966			MS15054	1
Oil Pan Set	1958-1966			<i>Cork Rubber</i> OS30569	1
Rear Main Seal Set	1958-1966			JV696	1
Timing Cover Set	1958-1966			JV796	1
Timing Cover Seal	1958-1966			46019	1

MISCELLANEOUS GASKETS					
Carb. Mount Gasket	1958-1966		4 Barrel Carburetor	G14560	2
Exhaust Pipe Gasket	1958-1966		Pipe To Manifold	F5360C	2
Fuel Pump Gasket	1958-1966			D27094	1
Heat Riser Gasket	1958-1966			G5436BK	1
Push Rod Cover Set	1958-1966			PS38754	1
Water Manifold Gasket	1958-1966		To Block	C24110	2
Water Outlet Gasket	1958-1966			C25487	1

13 343 CID (5.6L) American Motors Co. V8 Cyl, 4.080in./103.6mm (1967-1969) **13**

Part	Year	VIN	Model/Application	Part Number	Qty.
ENGINE GASKETS					
Head Set	1967-1969		(Exhaust Pipe Gasket Not Included, Intake Manifold Gasket Not Included, Exhaust Manifold Gasket Not Included)	HS3467	1
Full Set	1967-1969		(Exhaust Pipe Gasket Not Included, Intake Manifold Gasket Not Included, Exhaust Manifold Gasket Not Included)	FS3467	1
Engine Kit Gasket Set	1967-1969		(Intake Manifold Gasket Not Included), Use With Part Number MS15922	95-3339VR	1
Cylinder Head Gasket	1967-1969			<i>VR2000</i> 3467	2
Valve Cover Set	1967-1969			<i>Cork Rubber</i> VS28317	1
Valve Stem Seal, Exh.	1967-1969			B45298	8

American Motors

13 343 CID (5.6L) American Motors Co. V8 Cyl, 4.080in./103.6mm (1967-1969) **13**
 (cont.) (cont.)

Part	Year	VIN	Model/Application	Part Number	Qty.	
ENGINE GASKETS (cont.)						
Valve Stem Seal, Int.	1967-1969			B45298	8	
Manifold Set, Exhaust	1967-1969			MS14743	1	
Manifold Set, Intake	1967-1969			MS15922	1	
Oil Pan Set	1967-1969			Cork Rubber	OS30538	1
				Tuff-Cork	OS30538TC	1
Rear Main Seal Set	1967-1969			JV638	1	
Timing Cover Set	1967-1969		(Repair Sleeve Not Included)	JV870	1	
			(Contains Repair Sleeve)	JV928	1	
Timing Cover Seal	1967-1969			46483	1	
Harmonic Balancer Repair Sleeve	1967-1969		Ground Steel, .020" Thickness	66590RS	1	
			Use With Part Number A500 Nickel Plated Formed Steel, .013" Thickness	A222	1	

MISCELLANEOUS GASKETS					
Air Cleaner Mount Gasket	1967-1969		4 Barrel Carburetor	G27098	1
	1967		2 Barrel Carburetor	G25936	1
Carb. Mount Gasket	1968-1969		2 Barrel Carburetor, Carburetor To Insulator	G26043	1
	1967-1969		4 Barrel Carburetor	G14569	1
Exhaust Pipe Gasket	1967-1969		(Ring Type 'D'), Pipe To Manifold	F7171	2
Fuel Pump Gasket	1967-1969			D27094	1
Heat Riser Gasket	1967-1969			G5436BK	1
Water Manifold Gasket	1967		To Block	C24110	2
Water Outlet Gasket	1967-1969			C24111	1
Water Pump Mount Gasket	1967-1969			K14740	1

14 360 CID (5.9L) American Motors Co. V8 Cyl, 4.080in./103.6mm (1970-1978) **14**

Part	Year	VIN	Model/Application	Part Number	Qty.	
ENGINE GASKETS						
Head Set	1971-1978		(Exhaust Pipe Gasket Not Included, Intake Manifold Gasket Not Included)	HS3467	1	
	1970		Exhaust Manifold Gasket Not Included, (Exhaust Pipe Gasket Not Included, Intake Manifold Gasket Not Included)	HS3467	1	
Full Set	1971-1978		(Exhaust Pipe Gasket Not Included, Intake Manifold Gasket Not Included)	FS3467	1	
	1970		Exhaust Manifold Gasket Not Included, (Exhaust Pipe Gasket Not Included, Intake Manifold Gasket Not Included)	FS3467	1	
Engine Kit Gasket Set	1970-1978		(Intake Manifold Gasket Not Included), Use With Part Number MS15922	95-3339VR	1	
Cylinder Head Gasket	1970-1978		VR2000	3467	2	
Valve Cover Set	1970-1978		Cork Rubber	VS28317	1	
Valve Stem Seal, Exh.	1970-1978			B45298	8	
Valve Stem Seal, Int.	1970-1978			B45298	8	
Manifold Set, Exhaust	1971-1978			MS14143	1	
	1970			MS14743	1	
Manifold Set, Intake	1970-1978			MS15922	1	
Oil Pan Set	1970-1978			Cork Rubber	OS30538	1
				Tuff-Cork	OS30538TC	1
Rear Main Seal Set	1970-1978			JV638	1	
Timing Cover Set	1970-1978		(Repair Sleeve Not Included)	JV870	1	
			(Contains Repair Sleeve)	JV928	1	
Timing Cover Seal	1970-1978			46483	1	
Harmonic Balancer Repair Sleeve	1970-1978		Ground Steel, .020" Thickness	66590RS	1	
			Use With Part Number A500 Nickel Plated Formed Steel, .013" Thickness	A222	1	

PASSENGER CAR

14 360 CID (5.9L) American Motors Co. V8 Cyl, 4.080in./103.6mm (1970-1978) **14**
(cont.) (cont.)

Part	Year	VIN	Model/Application	Part Number	Qty.
MISCELLANEOUS GASKETS					
Air Cleaner Mount Gasket	1970-1978		2 Barrel Carburetor	G27098	1
Carb. Mount Gasket	1973-1978		2 Barrel Carburetor, Insulator To Manifold	G26043	1
	1975-1976		4 Barrel Carburetor, Insulator To Manifold	G25504	1
	1970-1974		4 Barrel Carburetor, Insulator To Manifold	G25503	1
	1970-1972		2 Barrel Carburetor, Carburetor To Insulator	G26043	1
Choke Tube Gasket	1973-1978			B45780	1
E.G.R. Gasket	1973-1978			G26315	1
Exhaust Pipe Gasket	1975-1978		Catalytic Converter	F10076	1
	1970-1978		2.4" Pipe, (Ring Type 'D'), Pipe To Manifold	F7171	1
			2.8" Pipe, (Ring Type 'B'), Pipe To Manifold	F7201	1
			2.94" Pipe, (Ring Type 'B'), Pipe To Manifold	F7204	1
Fuel Pump Gasket	1970-1978			D27094	1
				<i>Tuff-Cork</i> D27094TC	1
Heat Riser Gasket	1971-1972			G12262	1
Water Outlet Gasket	1970-1978			C24111	1
Water Pump Mount Gasket	1970-1978			K14740	1

15 390 CID (6.4L) American Motors Co. V8 Cyl, 4.165in./105.8mm (1968-1970) **15**

Part	Year	VIN	Model/Application	Part Number	Qty.
------	------	-----	-------------------	-------------	------

ENGINE GASKETS					
Head Set	1968-1970		(Exhaust Pipe Gasket Not Included, Intake Manifold Gasket Not Included, Exhaust Manifold Gasket Not Included)	HS3467	1
Full Set	1968-1970		(Exhaust Pipe Gasket Not Included, Intake Manifold Gasket Not Included, Exhaust Manifold Gasket Not Included)	FS3467	1
Engine Kit Gasket Set	1968-1970		(Intake Manifold Gasket Not Included), Use With Part Number MS15922	95-3339VR	1
Cylinder Head Gasket	1968-1970		<i>VR2000</i>	3467	2
Valve Cover Set	1968-1970		<i>Cork Rubber</i>	VS28317	1
Valve Stem Seal, Exh.	1968-1970			B45298	8
Valve Stem Seal, Int.	1968-1970			B45298	8
Manifold Set, Exhaust	1968-1970			MS14743	1
Manifold Set, Intake	1968-1970			MS15922	1
Oil Pan Set	1968-1970		<i>Cork Rubber</i>	OS30538	1
			<i>Tuff-Cork</i>	OS30538TC	1
Rear Main Seal Set	1968-1970			JV638	1
Timing Cover Set	1968-1970		(Repair Sleeve Not Included)	JV870	1
			(Contains Repair Sleeve)	JV928	1
Timing Cover Seal	1968-1970			46483	1
Harmonic Balancer Repair Sleeve	1968-1970		<i>Ground Steel, .020" Thickness</i>	66590RS	1
			Use With Part Number A500 <i>Nickel Plated Formed Steel, .013" Thickness</i>	A222	1

MISCELLANEOUS GASKETS					
Air Cleaner Mount Gasket	1968-1970		4 Barrel Carburetor	G27098	1
Carb. Mount Gasket	1970		4 Barrel Carburetor	G25503	1
	1968-1969		4 Barrel Carburetor	G14569	1
Exhaust Pipe Gasket	1968-1970		(Ring Type 'D'), Pipe To Manifold	F7171	2
Fuel Pump Gasket	1968-1970			D27094	1
Heat Riser Gasket	1968-1970			G5436BK	1
Water Outlet Gasket	1968-1970			C24111	1
Water Pump Mount Gasket	1968-1970			K14740	1

American Motors

16 401 CID (6.6L) American Motors Co. V8 Cyl, 4.165in./105.8mm (1971-1976)

16

Part	Year	VIN	Model/Application	Part Number	Qty.
ENGINE GASKETS					
Head Set	1971-1976		(Exhaust Pipe Gasket Not Included, Intake Manifold Gasket Not Included)	HS3467	1
Full Set	1971-1976		(Exhaust Pipe Gasket Not Included, Intake Manifold Gasket Not Included)	FS3467	1
Engine Kit Gasket Set	1971-1976		(Intake Manifold Gasket Not Included), Use With Part Number MS15922	95-3339VR	1
Cylinder Head Gasket	1971-1976		VR2000	3467	2
Valve Cover Set	1971-1976		Cork Rubber	VS28317	1
Valve Stem Seal, Exh.	1971-1975			B45298	8
Valve Stem Seal, Int.	1971-1976			B45298	8
Manifold Set, Exhaust	1971-1976			MS14143	1
Manifold Set, Intake	1971-1976			MS15922	1
Oil Pan Set	1971-1976		Cork Rubber	OS30538	1
			Tuff-Cork	OS30538TC	1
Rear Main Seal Set	1971-1976			JV638	1
Timing Cover Set	1971-1976		(Repair Sleeve Not Included)	JV870	1
			(Contains Repair Sleeve)	JV928	1
Timing Cover Seal	1971-1976			46483	1
Harmonic Balancer Repair Sleeve	1971-1976		Ground Steel, .020" Thickness	66590RS	1
			Use With Part Number A500 Nickel Plated Formed Steel, .013" Thickness	A222	1

MISCELLANEOUS GASKETS

Air Cleaner Mount Gasket	1971-1976		4 Barrel Carburetor	G27098	1
Carb. Mount Gasket	1975-1976		4 Barrel Carburetor, Insulator To Manifold	G25504	1
	1974		4 Barrel Carburetor, Insulator To Manifold	G25503	1
	1971-1972		4 Barrel Carburetor	G25503	2
Choke Tube Gasket	1973-1976			B45780	1
E.G.R. Gasket	1973-1976			G26315	1
Exhaust Pipe Gasket	1975-1976		Catalytic Converter	F10076	1
	1971-1976		2.4" Pipe, (Ring Type 'D'), Pipe To Manifold	F7171	1
			2.8" Pipe, (Ring Type 'B'), Pipe To Manifold	F7201	1
			2.94" Pipe, (Ring Type 'B'), Pipe To Manifold	F7204	1
Fuel Pump Gasket	1971-1976			D27094	1
			Tuff-Cork	D27094TC	1
Heat Riser Gasket	1971-1972			G12262	1
Water Outlet Gasket	1971-1976			C24111	1
Water Pump Mount Gasket	1971-1976			K14740	1

Asuna

Engine Index

Engine	Year	Block
110 CID (1.8L) LV6 DOHC Isuzu	1992-1993	1

Model Index

Model	Engine	Year	Block
Sunfire	110 CID (1.8L) LV6 DOHC Isuzu	1992-1994	1

1 110 CID (1.8L) LV6 DOHC Isuzu 4 Cyl, 3.150in./80mm (1992-1993)

1

Part	Year	VIN	Model/Application	Part Number	Qty.
ENGINE GASKETS					
Manifold Set, Exhaust	1992-1993			MS16065	1
Manifold Set, Intake	1992-1993		(Contains Plenum Chamber Gasket)	MS16066	1
Oil Pan Set	1992-1993		Silicone	JV6	1

1 110 CID (1.8L) LV6 DOHC Isuzu 4 Cyl, 3.150in./80mm (1992-1993) **1**
(cont.) (cont.)

Part	Year	VIN	Model/Application	Part Number	Qty.
MISCELLANEOUS GASKETS					
Exhaust Pipe Gasket	1992-1993		(Flange Type), Exhaust Pipe To Converter	F10086	2
Therm. Housing Gasket	1992-1993			C31214	1

Audi

Engine Index

Engine	Year	Block	Engine	Year	Block
1471CC (1.5L) ZD SOHC	1973	1	1984CC (2.0L) 3A SOHC	1988-1991	15
1471CC (1.5L) ZE SOHC	1973	2	1986CC (2.0L) CN SOHC Diesel	1979-1982	16
1471CC (1.5L) XV/XW/XY/XZ Gas	1974	3	2144CC (2.2L) KH SOHC	1984-1985	17
Volkswagen			2144CC (2.2L) WK SOHC	1980-1983	18
1588CC (1.6L) CR Volkswagen Diesel	1982-1983	4	2144CC (2.2L) WU SOHC	1984	19
1588CC (1.6L) JK Volkswagen Diesel	1983	5	2144CC (2.2L) WX SOHC	1983-1985	20
1588CC (1.6L) CY Turbo Volkswagen Diesel	1982-1983	6	2144CC (2.2L) WD SOHC Volkswagen	1978-1983	21
1588CC (1.6L) YG Volkswagen	1975-1980	7	2144CC (2.2L) WE Volkswagen	1978-1984	22
1588CC (1.6L) YH Volkswagen	1975-1980	8	2226CC (2.2L) KZ SOHC	1985-1987	23
1588CC (1.6L) YK Volkswagen	1975-1980	9	2226CC (2.2L) MC SOHC	1986-1988	24
1715CC (1.7L) WT Volkswagen	1981-1984	10	2226CC (2.2L) JT/KX Volkswagen	1984-1987	25
1760CC (1.8L) OHV	1970-1972	11	2309CC (2.3L) 7A DOHC	1989-1991	26
1780CC (1.8L) MG	1985-1987	12	2309CC (2.3L) NF SOHC	1987-1991	27
1780CC (1.8L) JN Volkswagen	1984	13	2309CC (2.3L) NG SOHC	1987-1992	28
1871CC (1.9L) OHV	1972-1977	14	2771CC (2.8L) AAH SOHC	1992-1995	29

Model Index

Model	Engine	Year	Block	Model	Engine	Year	Block
80	1588CC (1.6L) YH Volkswagen	1973-1975	8	4000	2226CC (2.2L) JT/KX Volkswagen	1984-1987	25
80	1984CC (2.0L) 3A SOHC	1988-1991	15	4000S	1715CC (1.7L) WT Volkswagen	1981-1983	10
80	2309CC (2.3L) NG SOHC	1988-1992	28	5000	1986CC (2.0L) CN SOHC Diesel	1977-1983	16
90	1984CC (2.0L) 3A SOHC	1988-1989	15	5000	2144CC (2.2L) KH SOHC	1984-1985	17
90	2309CC (2.3L) 7A DOHC	1989-1991	26	5000	2144CC (2.2L) WU SOHC	1984	19
90	2309CC (2.3L) NG SOHC	1988-1992	28	5000	2144CC (2.2L) WK SOHC	1980-1983	18
90	2771CC (2.8L) AAH SOHC	1993-1995	29	5000	2144CC (2.2L) WD SOHC Volkswagen	1977-1983	21
90CS	2771CC (2.8L) AAH SOHC	1993-1994	29	5000	2144CC (2.2L) WE Volkswagen	1977-1981	22
90S	2771CC (2.8L) AAH SOHC	1993-1995	29	5000	2226CC (2.2L) MC SOHC	1986-1988	24
100	1588CC (1.6L) YH Volkswagen	1973-1975	8	5000	2226CC (2.2L) KZ SOHC	1985-1987	23
100	1760CC (1.8L) OHV	1966-1972	11	5000	2309CC (2.3L) NF SOHC	1987-1988	27
100	1871CC (1.9L) OHV	1972-1977	14	5000 Coupe	2144CC (2.2L) WE Volkswagen	1981-1984	22
100	2309CC (2.3L) NF SOHC	1989-1991	27	5000 Coupe	2226CC (2.2L) JT/KX Volkswagen	1984-1987	25
100	2771CC (2.8L) AAH SOHC	1992-1994	29	5000 Coupe	2309CC (2.3L) NG SOHC	1987	28
4000	1588CC (1.6L) JK Volkswagen Diesel	1983	5	5000 Fox	1471CC (1.5L) XV/XW/XY/XZ Gas Volkswagen	1974	3
4000	1588CC (1.6L) CR Volkswagen Diesel	1982	4	5000 Fox	1471CC (1.5L) ZD SOHC	1973	1
4000	1588CC (1.6L) CY Turbo Volkswagen Diesel	1982-1983	6	5000 Fox	1471CC (1.5L) ZE SOHC	1973	2
4000	1588CC (1.6L) YK Volkswagen	1975-1980	9	5000 Fox	1588CC (1.6L) YG Volkswagen	1975-1979	7
4000	1588CC (1.6L) YG Volkswagen	1975-1980	7	5000 Fox	1588CC (1.6L) YH Volkswagen	1975-1979	8
4000	1588CC (1.6L) YH Volkswagen	1975-1980	8	5000 Fox	1588CC (1.6L) YK Volkswagen	1975-1979	9
4000	1715CC (1.7L) WT Volkswagen	1981-1984	10	5000 Fox	1588CC (1.6L) JN Volkswagen	1984	13
4000	1780CC (1.8L) MG Volkswagen	1985-1987	12	5000 Fox	2144CC (2.2L) WE Volkswagen	1980-1984	22
4000	1780CC (1.8L) JN Volkswagen	1984	13	5000 Fox	1780CC (1.8L) JN Volkswagen	1984	13
4000	2144CC (2.2L) WE Volkswagen	1980-1984	22	5000 Fox	1780CC (1.8L) MG Volkswagen	1985-1987	12
				5000 Fox	1780CC (1.8L) JN Volkswagen	1984	13
				5000 Fox	1780CC (1.8L) MG Volkswagen	1985-1987	12
				5000 Fox	1780CC (1.8L) JN Volkswagen	1984	13
				5000 Fox	1780CC (1.8L) MG Volkswagen	1985-1987	12
				5000 Fox	1780CC (1.8L) JN Volkswagen	1984	13
				5000 Fox	1780CC (1.8L) MG Volkswagen	1985-1987	12
				5000 Fox	1780CC (1.8L) JN Volkswagen	1984	13
				5000 Fox	1780CC (1.8L) MG Volkswagen	1985-1987	12
				5000 Fox	1780CC (1.8L) JN Volkswagen	1984	13
				5000 Fox	1780CC (1.8L) MG Volkswagen	1985-1987	12
				5000 Fox	1780CC (1.8L) JN Volkswagen	1984	13
				5000 Fox	1780CC (1.8L) MG Volkswagen	1985-1987	12
				5000 Fox	1780CC (1.8L) JN Volkswagen	1984	13
				5000 Fox	1780CC (1.8L) MG Volkswagen	1985-1987	12
				5000 Fox	1780CC (1.8L) JN Volkswagen	1984	13
				5000 Fox	1780CC (1.8L) MG Volkswagen	1985-1987	12
				5000 Fox	1780CC (1.8L) JN Volkswagen	1984	13
				5000 Fox	1780CC (1.8L) MG Volkswagen	1985-1987	12
				5000 Fox	1780CC (1.8L) JN Volkswagen	1984	13
				5000 Fox	1780CC (1.8L) MG Volkswagen	1985-1987	12
				5000 Fox	1780CC (1.8L) JN Volkswagen	1984	13
				5000 Fox	1780CC (1.8L) MG Volkswagen	1985-1987	12
				5000 Fox	1780CC (1.8L) JN Volkswagen	1984	13
				5000 Fox	1780CC (1.8L) MG Volkswagen	1985-1987	12
				5000 Fox	1780CC (1.8L) JN Volkswagen	1984	13
				5000 Fox	1780CC (1.8L) MG Volkswagen	1985-1987	12
				5000 Fox	1780CC (1.8L) JN Volkswagen	1984	13
				5000 Fox	1780CC (1.8L) MG Volkswagen	1985-1987	12
				5000 Fox	1780CC (1.8L) JN Volkswagen	1984	13
				5000 Fox	1780CC (1.8L) MG Volkswagen	1985-1987	12
				5000 Fox	1780CC (1.8L) JN Volkswagen	1984	13
				5000 Fox	1780CC (1.8L) MG Volkswagen	1985-1987	12
				5000 Fox	1780CC (1.8L) JN Volkswagen	1984	13
				5000 Fox	1780CC (1.8L) MG Volkswagen	1985-1987	12
				5000 Fox	1780CC (1.8L) JN Volkswagen	1984	13
				5000 Fox	1780CC (1.8L) MG Volkswagen	1985-1987	12
				5000 Fox	1780CC (1.8L) JN Volkswagen	1984	13
				5000 Fox	1780CC (1.8L) MG Volkswagen	1985-1987	12
				5000 Fox	1780CC (1.8L) JN Volkswagen	1984	13
				5000 Fox	1780CC (1.8L) MG Volkswagen	1985-1987	12
				5000 Fox	1780CC (1.8L) JN Volkswagen	1984	13
				5000 Fox	1780CC (1.8L) MG Volkswagen	1985-1987	12
				5000 Fox	1780CC (1.8L) JN Volkswagen	1984	13
				5000 Fox	1780CC (1.8L) MG Volkswagen	1985-1987	12
				5000 Fox	1780CC (1.8L) JN Volkswagen	1984	13
				5000 Fox	1780CC (1.8L) MG Volkswagen	1985-1987	12
				5000 Fox	1780CC (1.8L) JN Volkswagen	1984	13
				5000 Fox	1780CC (1.8L) MG Volkswagen	1985-1987	12
				5000 Fox	1780CC (1.8L) JN Volkswagen	1984	13
				5000 Fox	1780CC (1.8L) MG Volkswagen	1985-1987	12
				5000 Fox	1780CC (1.8L) JN Volkswagen	1984	13
				5000 Fox	1780CC (1.8L) MG Volkswagen	1985-1987	12
				5000 Fox	1780CC (1.8L) JN Volkswagen	1984	13
				5000 Fox	1780CC (1.8L) MG Volkswagen	1985-1987	12
				5000 Fox	1780CC (1.8L) JN Volkswagen	1984	13
				5000 Fox	1780CC (1.8L) MG Volkswagen	1985-1987	12
				5000 Fox	1780CC (1.8L) JN Volkswagen	1984	13
				5000 Fox	1780CC (1.8L) MG Volkswagen	1985-1987	12
				5000 Fox	1780CC (1.8L) JN Volkswagen	1984	13
				5000 Fox	1780CC (1.8L) MG Volkswagen	1985-1987	12
				5000 Fox	1780CC (1.8L) JN Volkswagen	1984	13
				5000 Fox	1780CC (1.8L) MG Volkswagen	1985-1987	12
				5000 Fox	1780CC (1.8L) JN Volkswagen	1984	13
				5000 Fox	1780CC (1.8L) MG Volkswagen	1985-1987	12
				5000 Fox	1780CC (1.8L) JN Volkswagen	1984	13
				5000 Fox	1780CC (1.8L) MG Volkswagen	1985-1987	12
				5000 Fox	1780CC (1.8L) JN Volkswagen	1984	13
				5000 Fox	1780CC (1.8L) MG Volkswagen	1985-1987	12
				5000 Fox	1780CC (1.8L) JN Volkswagen	1984	13
				5000 Fox	1780CC (1.8L) MG Volkswagen	1985-1987	12
				5000 Fox	1780CC (1.8L) JN Volkswagen	1984	13
				5000 Fox	1780CC (1.8L) MG Volkswagen	1985-1987	12
				5000 Fox	1780CC (1.8L) JN Volkswagen	1984	13
				5000 Fox	1780CC (1.8L) MG Volkswagen	1985-1987	12
				5000 Fox	1780CC (1.8L) JN Volkswagen	1984	13
				5000 Fox	1780CC (1.8L) MG Volkswagen	1985-1987	12
				5000 Fox	1780CC (1.8L) JN Volkswagen	1984	13
				5000 Fox	1780CC (1.8L) MG Volkswagen	1985-1987	12
				5000 Fox	1780CC (1.8L) JN Volkswagen	1984	13
				5000 Fox	1780CC (1.8L) MG Volkswagen	1985-1987	12
				5000 Fox	1780CC (1.8L) JN Volkswagen	1984	13
				5000 Fox	1780CC (1.8L) MG Volkswagen	1985-1987	12
				5000 Fox	1780CC (1.8L) JN Volkswagen	1984	13
				5000 Fox	1780CC (1.8L) MG Volkswagen	1985-1987	12
				5000 Fox	1780CC (1.8L) JN Volkswagen	1984	13
				5000 Fox	1780CC (1.8L) MG Volkswagen	1985-1987	12
				5000 Fox	1780CC (1.8L) JN Volkswagen	1984	13
				5000 Fox	1780CC (1.8L) MG Volkswagen	1985-1987	12
				5000 Fox	1780CC (1.8L) JN Volkswagen	1984	13
				5000 Fox	1780CC (1.8L) MG Volkswagen	1985-1987	12
				5000 Fox	1780CC (1.8L) JN Volkswagen	1984	13
				5000 Fox	1780CC (1.8L) MG Volkswagen	1985-1987	12
				5000 Fox	1780CC (1.8L) JN Volkswagen	1984	13
				5000 Fox	1780CC (1.8L) MG Volkswagen	1985-1987	12
				5000 Fox	1780CC (1.8L) JN Volkswagen	1984	13
				5000 Fox	1780CC (1.8L) MG Volkswagen	1985-1987	12
				5000 Fox	1780CC (1.8L) JN Volkswagen	1984	13
				5000 Fox	1780CC (1.8L) MG Volkswagen	1985-1987	

Audi

1 (cont.)	1471CC (1.5L) ZD SOHC 4 Cyl, 3.012in./76.5mm (1973)				1 (cont.)
---------------------	--	--	--	--	---------------------

Part	Year	VIN	Model/Application	Part Number	Qty.
------	------	-----	-------------------	-------------	------

ENGINE GASKETS (cont.)

Valve Stem Seal, Exh.	1973			<i>Teflon</i>	B45423	4
				<i>Fluoroelastomer</i>	B45546	4
Valve Stem Seal, Int.	1973			<i>Teflon</i>	B45423	4
				<i>Fluoroelastomer</i>	B45546	4
Manifold Set, Exhaust	1973		To Be Replaced By MS12375		MS10030W	1
					MS12375	1
Manifold Set, Intake	1973				MS12278	1
Oil Pan Set	1973			<i>Victo-Tech</i>	OS20056	1
Rear Main Seal Set	1973		Thru Engine Serial Number FC008938		JV643	1
			From Engine Serial Number FC008938		JV644	1
Timing Cover Set	1973				JV982	1

MISCELLANEOUS GASKETS

Camshaft Seal	1973				66960	3
Dist. Mounting Gasket	1973				B25941	1
E.G.R. Gasket	1973				G20270	1
Exhaust Pipe Gasket	1973		(Flange Type), Pipe To Manifold		F14603	1
Fuel Pump Gasket	1973				D24097	2
Intermediate Shaft Set	1973				JV983	1
Water Outlet Gasket	1973			<i>Victo-Tech</i>	C20119	1
Water Pump Mount Gasket	1973				K20118	1

2	1471CC (1.5L) ZE SOHC 4 Cyl, 3.012in./76.5mm (1973)				2
----------	--	--	--	--	----------

Part	Year	VIN	Model/Application	Part Number	Qty.
------	------	-----	-------------------	-------------	------

ENGINE GASKETS

Head Set	1973				HS3608	1
Full Set	1973				FS3608	1
Cylinder Head Gasket	1973			<i>VR2000</i>	3608	1
Valve Cover Set	1973		(Contains Valve Cover End Plug)	<i>Cork Rubber</i>	VS30024	1
			(Contains Valve Cover End Plug)	<i>Tuff-Cork</i>	VS30024TC	1
Valve Stem Seal, Exh.	1973			<i>Teflon</i>	B45423	4
				<i>Fluoroelastomer</i>	B45546	4
Valve Stem Seal, Int.	1973			<i>Teflon</i>	B45423	4
				<i>Fluoroelastomer</i>	B45546	4
Manifold Set, Exhaust	1973		To Be Replaced By MS12375		MS10030W	1
					MS12375	1
Manifold Set, Intake	1973				MS12278	1
Oil Pan Set	1973			<i>Victo-Tech</i>	OS20056	1
Rear Main Seal Set	1973		Thru Engine Serial Number FC008938		JV643	1
			From Engine Serial Number FC008938		JV644	1
Timing Cover Set	1973				JV982	1

MISCELLANEOUS GASKETS

Camshaft Seal	1973				66960	3
Dist. Mounting Gasket	1973				B25941	1
E.G.R. Gasket	1973				G20270	1
Exhaust Pipe Gasket	1973		(Flange Type), Pipe To Manifold		F14603	1
Fuel Pump Gasket	1973				D24097	2
Intermediate Shaft Set	1973				JV983	1
Water Outlet Gasket	1973			<i>Victo-Tech</i>	C20119	1
Water Pump Mount Gasket	1973				K20118	1

3 1471CC (1.5L) XV/XW/XY/XZ Gas Volkswagen 4 Cyl, 3.012in./76.5mm (1974)**3**

<i>Part</i>	<i>Year</i>	<i>VIN</i>	<i>Model/Application</i>	<i>Part Number</i>	<i>Qty.</i>
ENGINE GASKETS					
Head Set	1974			HS3608	1
Full Set	1974			FS3608	1
Cylinder Head Gasket	1974		VR2000	3608	1
Valve Cover Set	1974		(Contains Valve Cover End Plug) Cork Rubber	VS30024	1
			(Contains Valve Cover End Plug) Tuff-Cork	VS30024TC	1
Valve Stem Seal, Exh.	1974		Teflon	B45423	4
			Fluoroelastomer	B45546	4
Valve Stem Seal, Int.	1974		Teflon	B45423	4
			Fluoroelastomer	B45546	4
Manifold Set, Exhaust	1974		To Be Replaced By MS12375	MS10030W	1
				MS12375	1
Manifold Set, Intake	1974			MS12278	1
Oil Pan Set	1974		Victo-Tech	OS20056	1
Rear Main Seal Set	1974		Thru Engine Serial Number FC008938	JV643	1
			From Engine Serial Number FC008938	JV644	1
Timing Cover Set	1974			JV982	1

MISCELLANEOUS GASKETS

Camshaft Seal	1974			66960	3
Dist. Mounting Gasket	1974			B25941	1
E.G.R. Gasket	1974			G20270	1
Exhaust Pipe Gasket	1974		(Flange Type), Pipe To Manifold	F14603	1
Fuel Pump Gasket	1974			D24097	2
Intermediate Shaft Set	1974			JV983	1
Water Outlet Gasket	1974		Victo-Tech	C20119	1
Water Pump Mount Gasket	1974			K20118	1

4 1588CC (1.6L) CR Volkswagen Diesel 4 Cyl, 3.012in./76.5mm (1982-1983)**4**

<i>Part</i>	<i>Year</i>	<i>VIN</i>	<i>Model/Application</i>	<i>Part Number</i>	<i>Qty.</i>
ENGINE GASKETS					
Head Set	1982-1983		(Head Gasket Not Included, Thickness Is Identified By Groove In Edge Of Gasket, Replacement Gasket Must Be Of Same Thickness As One Removed)	HS3664W	1
Full Set	1982-1983		(Head Gasket Not Included, Thickness Is Identified By Groove In Edge Of Gasket, Replacement Gasket Must Be Of Same Thickness As One Removed)	FS3664W	1
Cylinder Head Gasket	1982-1983		(1 Groove) 1.4mm Thickness	3728	1
			(2 Grooves) 1.5mm Thickness	3729	1
			(3 Grooves) 1.6mm Thickness	3730	1
Valve Cover Set	1982-1983		(Contains Valve Cover End Plug) Cork Rubber	VS30024	1
			(Contains Valve Cover End Plug) Tuff-Cork	VS30024TC	1
Valve Stem Seal, Exh.	1982-1983		Teflon	B45423	4
			Fluoroelastomer	B45546	4
Valve Stem Seal, Int.	1982-1983		Teflon	B45423	4
			Fluoroelastomer	B45546	4
Manifold Set, Exhaust	1982-1983		To Be Replaced By MS12375	MS10030W	1
	1982			MS12375	1
Manifold Set, Intake	1982-1983			MS12278	1
Oil Pan Set	1982-1983		Victo-Tech	OS20056	1
Rear Main Seal Set	1982-1983			JV567	1
Timing Cover Set	1982-1983			JV982	1

MISCELLANEOUS GASKETS

E.G.R. Gasket	1982-1983			G20269	1
Exhaust Pipe Gasket	1982-1983		(Flange Type), Pipe To Manifold	F7426	1
Intermediate Shaft Set	1982-1983			JV983	1
Water Outlet Gasket	1982-1983		Victo-Tech	C20119	1

Audi

4 (cont.)	1588CC (1.6L) CR Volkswagen Diesel 4 Cyl, 3.012in./76.5mm (1982-1983)					4 (cont.)
--------------	---	--	--	--	--	--------------

Part	Year	VIN	Model/Application	Part Number	Qty.
------	------	-----	-------------------	-------------	------

MISCELLANEOUS GASKETS (cont.)

Water Pump Mount Gasket	1982-1983			K20118	1
-------------------------	-----------	--	--	--------	---

5	1588CC (1.6L) JK Volkswagen Diesel 4 Cyl, 3.012in./76.5mm (1983)					5
---	--	--	--	--	--	---

Part	Year	VIN	Model/Application	Part Number	Qty.
------	------	-----	-------------------	-------------	------

ENGINE GASKETS

Head Set	1983		(Head Gasket Not Included, Thickness Is Identified By Groove In Edge Of Gasket, Replacement Gasket Must Be Of Same Thickness As One Removed)	HS3664W	1
Full Set	1983		(Head Gasket Not Included, Thickness Is Identified By Groove In Edge Of Gasket, Replacement Gasket Must Be Of Same Thickness As One Removed)	FS3664W	1
Cylinder Head Gasket	1983		(1 Groove) <i>1.4mm Thickness</i>	3728	1
			(2 Grooves) <i>1.5mm Thickness</i>	3729	1
			(3 Grooves) <i>1.6mm Thickness</i>	3730	1
Valve Cover Set	1983		(Contains Valve Cover End Plug) <i>Cork Rubber</i>	VS30024	1
			(Contains Valve Cover End Plug) <i>Tuff-Cork</i>	VS30024TC	1
Valve Stem Seal, Exh.	1983		<i>Teflon</i>	B45423	4
			<i>Fluoroelastomer</i>	B45546	4
Valve Stem Seal, Int.	1983		<i>Teflon</i>	B45423	4
			<i>Fluoroelastomer</i>	B45546	4
Manifold Set, Exhaust	1983		To Be Replaced By MS12375	MS10030W	1
				MS12375	1
Manifold Set, Intake	1983			MS12278	1
Oil Pan Set	1983		<i>Victo-Tech</i>	OS20056	1
Rear Main Seal Set	1983			JV567	1
Timing Cover Set	1983			JV982	1

MISCELLANEOUS GASKETS

E.G.R. Gasket	1983			G20269	1
Exhaust Pipe Gasket	1983		(Flange Type), Pipe To Manifold	F7426	1
Intermediate Shaft Set	1983			JV983	1
Water Outlet Gasket	1983		<i>Victo-Tech</i>	C20119	1
Water Pump Mount Gasket	1983			K20118	1

6	1588CC (1.6L) CY Turbo Volkswagen Diesel 4 Cyl, 3.130in./79.5mm (1982-1983)					6
---	---	--	--	--	--	---

Part	Year	VIN	Model/Application	Part Number	Qty.
------	------	-----	-------------------	-------------	------

ENGINE GASKETS

Head Set	1982-1983		(Head Gasket Not Included, Thickness Is Identified By Groove In Edge Of Gasket, Replacement Gasket Must Be Of Same Thickness As One Removed)	HS3664W	1
Full Set	1982-1983		(Head Gasket Not Included, Thickness Is Identified By Groove In Edge Of Gasket, Replacement Gasket Must Be Of Same Thickness As One Removed)	FS3664W	1
Cylinder Head Gasket	1982-1983		(2 Grooves) <i>1.5mm Thickness</i>	3765	1
			(3 Grooves) <i>1.6mm Thickness</i>	3766	1
Valve Cover Set	1982-1983		(Contains Valve Cover End Plug) <i>Cork Rubber</i>	VS30024	1
			(Contains Valve Cover End Plug) <i>Tuff-Cork</i>	VS30024TC	1
Valve Stem Seal, Exh.	1982-1983		<i>Teflon</i>	B45423	4
Valve Stem Seal, Int.	1982-1983		<i>Teflon</i>	B45423	4
Manifold Set, Exhaust	1982-1983		To Be Replaced By MS12375	MS10030W	1
				MS12375	1
Manifold Set, Intake	1982-1983			MS12278	1
Oil Pan Set	1982-1983		<i>Victo-Tech</i>	OS20056	1
Rear Main Seal Set	1982-1983			JV567	1
Timing Cover Set	1982-1983			JV982	1

6 (cont.)	1588CC (1.6L) CY Turbo Volkswagen Diesel 4 Cyl, 3.130in./79.5mm (1982-1983)				6 (cont.)
---------------------	--	--	--	--	---------------------

<i>Part</i>	<i>Year</i>	<i>VIN</i>	<i>Model/Application</i>	<i>Part Number</i>	<i>Qty.</i>
MISCELLANEOUS GASKETS					
Camshaft Seal	1982-1983			66960	3
Dist. Mounting Gasket	1982-1983			B25941	1
E.G.R. Gasket	1982-1983			G20269	1
Exhaust Pipe Gasket	1982-1983		(Flange Type), Pipe To Manifold	F10049	1
Intermediate Shaft Set	1982-1983			JV983	1
Water Outlet Gasket	1982-1983		<i>Victo-Tech</i>	C20119	1
Water Pump Mount Gasket	1982-1983			K20118	1

7	1588CC (1.6L) YG Volkswagen 4 Cyl, 3.130in./79.5mm (1975-1980)				7
----------	---	--	--	--	----------

<i>Part</i>	<i>Year</i>	<i>VIN</i>	<i>Model/Application</i>	<i>Part Number</i>	<i>Qty.</i>
ENGINE GASKETS					
Head Set	1975-1980			HS3609	1
Full Set	1975-1980			FS3609	1
Engine Kit Gasket Set	1975-1980			95-3095VR	1
Cylinder Head Gasket	1975-1980		<i>VR2000</i>	3609	1
Cyl. Head Spacer Shim	1975-1980		Requires Sealing Compound <i>Steel</i>	3609S	1
Sealing Compound	1975-1980		(4 Ounce Brush Top Can)	JV66B	1
			(12 Ounce Spray Can)	JV66S	1
Valve Cover Set	1975-1980		(Contains Valve Cover End Plug) <i>Cork Rubber</i>	VS30024	1
			(Contains Valve Cover End Plug) <i>Tuff-Cork</i>	VS30024TC	1
Valve Stem Seal, Exh.	1975-1980		<i>Teflon</i>	B45423	4
			<i>Fluoroelastomer</i>	B45546	4
Valve Stem Seal, Int.	1975-1980		<i>Teflon</i>	B45423	4
			<i>Fluoroelastomer</i>	B45546	4
Manifold Set, Exhaust	1975-1980		To Be Replaced By MS12375	MS10030W	1
				MS12375	1
Manifold Set, Intake	1975-1980			MS12278	1
Oil Pan Set	1975-1980		<i>Victo-Tech</i>	OS20056	1
Rear Main Seal Set	1975-1980			JV644	1
Timing Cover Set	1975-1980			JV982	1

<i>Part</i>	<i>Year</i>	<i>VIN</i>	<i>Model/Application</i>	<i>Part Number</i>	<i>Qty.</i>
MISCELLANEOUS GASKETS					
Camshaft Seal	1975-1980			66960	3
Dist. Mounting Gasket	1975-1980			B25941	1
E.G.R. Gasket	1975-1980			G20269	1
Exhaust Pipe Gasket	1975-1980		(Flange Type), Pipe To Manifold	F14603	1
Fuel Pump Gasket	1975-1980			D24097	2
Intermediate Shaft Set	1975-1980			JV983	1
Water Outlet Gasket	1975-1980		<i>Victo-Tech</i>	C20119	1
Water Pump Mount Gasket	1975-1980			K20118	1

8	1588CC (1.6L) YH Volkswagen 4 Cyl, 3.130in./79.5mm (1975-1980)				8
----------	---	--	--	--	----------

<i>Part</i>	<i>Year</i>	<i>VIN</i>	<i>Model/Application</i>	<i>Part Number</i>	<i>Qty.</i>
ENGINE GASKETS					
Head Set	1975-1980			HS3609	1
Full Set	1975-1980			FS3609	1
Engine Kit Gasket Set	1975-1980			95-3095VR	1
Cylinder Head Gasket	1975-1980		<i>VR2000</i>	3609	1
Cyl. Head Spacer Shim	1975-1980		Requires Sealing Compound <i>Steel</i>	3609S	1
Sealing Compound	1975-1980		(4 Ounce Brush Top Can)	JV66B	1
			(12 Ounce Spray Can)	JV66S	1
Valve Cover Set	1975-1980		(Contains Valve Cover End Plug) <i>Cork Rubber</i>	VS30024	1

Audi

8 (cont.)	1588CC (1.6L) YH Volkswagen 4 Cyl, 3.130in./79.5mm (1975-1980)				8 (cont.)
---------------------	---	--	--	--	---------------------

<i>Part</i>	<i>Year</i>	<i>VIN</i>	<i>Model/Application</i>	<i>Part Number</i>	<i>Qty.</i>
ENGINE GASKETS (cont.)					
Valve Cover Set (cont.)	1975-1980		(Contains Valve Cover End Plug) <i>Tuff-Cork</i>	VS30024TC	1
Valve Stem Seal, Exh.	1975-1980		<i>Teflon</i>	B45423	4
			<i>Fluoroelastomer</i>	B45546	4
Valve Stem Seal, Int.	1975-1980		<i>Teflon</i>	B45423	4
			<i>Fluoroelastomer</i>	B45546	4
Manifold Set, Exhaust	1975-1980		To Be Replaced By MS12375	MS10030W	1
				MS12375	1
Manifold Set, Intake	1975-1980			MS12278	1
Oil Pan Set	1975-1980		<i>Victo-Tech</i>	OS20056	1
Rear Main Seal Set	1975-1980			JV644	1
Timing Cover Set	1975-1980			JV982	1

MISCELLANEOUS GASKETS					
Camshaft Seal	1975-1980			66960	3
Dist. Mounting Gasket	1975-1980			B25941	1
E.G.R. Gasket	1975-1980			G20269	1
Exhaust Pipe Gasket	1975-1980		(Flange Type), Pipe To Manifold	F14603	1
Fuel Pump Gasket	1975-1980			D24097	2
Intermediate Shaft Set	1975-1980			JV983	1
Water Outlet Gasket	1975-1980		<i>Victo-Tech</i>	C20119	1
Water Pump Mount Gasket	1975-1980			K20118	1

9	1588CC (1.6L) YK Volkswagen 4 Cyl, 3.130in./79.5mm (1975-1980)				9
<i>Part</i>	<i>Year</i>	<i>VIN</i>	<i>Model/Application</i>	<i>Part Number</i>	<i>Qty.</i>

MISCELLANEOUS GASKETS					
E.G.R. Gasket	1975-1980			G20269	1

10	1715CC (1.7L) WT Volkswagen 4 Cyl, 3.130in./79.5mm (1981-1984)				10
<i>Part</i>	<i>Year</i>	<i>VIN</i>	<i>Model/Application</i>	<i>Part Number</i>	<i>Qty.</i>

ENGINE GASKETS					
Head Set	1981-1984			HS3609	1
Full Set	1981-1984			FS3609	1
Engine Kit Gasket Set	1981-1984		Multi-Port Fuel Injection	95-3095VR	1
Cylinder Head Gasket	1981-1984		<i>VR2000</i>	3609	1
Cyl. Head Spacer Shim	1981-1984		Requires Sealing Compound	<i>Steel</i>	3609S
Sealing Compound	1981-1984		(4 Ounce Brush Top Can)	JV66B	1
			(12 Ounce Spray Can)	JV66S	1
Valve Cover Set	1981-1984		(Contains Valve Cover End Plug) <i>Cork Rubber</i>	VS30024	1
			(Contains Valve Cover End Plug) <i>Tuff-Cork</i>	VS30024TC	1
Valve Stem Seal, Exh.	1981-1984		<i>Teflon</i>	B45423	4
			<i>Fluoroelastomer</i>	B45546	4
Valve Stem Seal, Int.	1981-1984		<i>Teflon</i>	B45423	4
			<i>Fluoroelastomer</i>	B45546	4
Manifold Set, Exhaust	1981-1984		To Be Replaced By MS12375	MS10030W	1
				MS12375	1
Manifold Set, Intake	1981-1984			MS12278	1
Oil Pan Set	1981-1984		<i>Victo-Tech</i>	OS20056	1
Rear Main Seal Set	1981-1984			JV644	1
Timing Cover Set	1981-1984			JV982	1

MISCELLANEOUS GASKETS					
Camshaft Seal	1981-1984			66960	3
Dist. Mounting Gasket	1981-1984			B25941	1
E.G.R. Gasket	1981-1984			G20269	1
Exhaust Pipe Gasket	1981-1984		(Flange Type), Pipe To Manifold	F14603	1

10 1715CC (1.7L) WT Volkswagen 4 Cyl, 3.130in./79.5mm (1981-1984) **10**
(cont.) (cont.)

Part	Year	VIN	Model/Application	Part Number	Qty.
MISCELLANEOUS GASKETS (cont.)					
Fuel Pump Gasket	1981-1984			D24097	2
Intermediate Shaft Set	1981-1984			JV983	1
Water Outlet Gasket	1981-1984		Victo-Tech	C20119	1
Water Pump Mount Gasket	1981-1984			K20118	1

11 1760CC (1.8L) OHV 4 Cyl, 3.208in./81.5mm (1970-1972) **11**

Part	Year	VIN	Model/Application	Part Number	Qty.
ENGINE GASKETS					
Valve Stem Seal, Exh.	1970-1972		ZT, ZY Engine	B20169	4
Valve Stem Seal, Int.	1970-1972		ZT, ZY Engine	B20169	4
Manifold Set, Exhaust	1970-1972		ZT, ZY Engine	MS15268	1
Manifold Set, Intake	1970-1972		ZT, ZY Engine	MS15273	1
Rear Main Seal	1970-1972		ZT, ZY Engine Rubber	66691	1
Timing Cover Seal	1970-1972		ZT, ZY Engine	66709	1

MISCELLANEOUS GASKETS					
Exhaust Pipe Gasket	1970-1972		ZT, ZY Engine, (Flange Type), Pipe To Manifold	F20168	1
Water Outlet Gasket	1970-1972		ZT, ZY Engine Victo-Tech	C20119	1

12 1780CC (1.8L) MG 4 Cyl, 3.189in./81mm (1985-1987) **12**

Part	Year	VIN	Model/Application	Part Number	Qty.
ENGINE GASKETS					
Head Set	1985-1987			HS3758	1
Full Set	1985-1987			FS3758	1
Engine Kit Gasket Set	1985-1987		Multi-Port Fuel Injection	95-3157VR	1
Cylinder Head Gasket	1985-1987		VR2000	3758	1
Valve Cover Set	1985-1987		(Contains Valve Cover End Plug) Cork Rubber	VS30024	1
			(Contains Valve Cover End Plug) Tuff-Cork	VS30024TC	1
Valve Stem Seal, Exh.	1985-1987		Teflon	B45423	4
			Fluoroelastomer	B45546	4
			Teflon	B45423	4
Valve Stem Seal, Int.	1985-1987		Teflon	B45423	4
			Fluoroelastomer	B45546	4
Manifold Set, Exhaust	1985-1987		To Be Replaced By MS12375	MS10030W	1
				MS12375	1
Manifold Set, Intake	1985-1987			MS12278	1
Oil Pan Set	1985-1987		Victo-Tech	OS20056	1
Rear Main Seal Set	1985-1987			JV567	1
Timing Cover Set	1985-1987			JV982	1

MISCELLANEOUS GASKETS					
Camshaft Seal	1985-1987			66960	3
Dist. Mounting Gasket	1985-1987			B25941	1
Exhaust Pipe Gasket	1985-1987		Single Pipe, (Flange Type), Pipe To Manifold	F7487	1
			Twin Pipe, (Flange Type), Pipe To Manifold	F14603	1
			(Flange Type), Catalytic Converter, Rear	F14604	1
Intermediate Shaft Set	1985-1987			JV983	1
Water Outlet Gasket	1985-1987		Victo-Tech	C20119	1
Water Pump Mount Gasket	1985-1987			K20118	1

13 1780CC (1.8L) JN Volkswagen 4 Cyl, 3.189in./81mm (1984) **13**

Part	Year	VIN	Model/Application	Part Number	Qty.
ENGINE GASKETS					
Head Set	1984			HS3758	1
Full Set	1984			FS3758	1

Audi

13 (cont.)	1780CC (1.8L) JN Volkswagen 4 Cyl, 3.189in./81mm (1984)	13 (cont.)
----------------------	--	----------------------

Part	Year	VIN	Model/Application	Part Number	Qty.
ENGINE GASKETS (cont.)					
Engine Kit Gasket Set	1984		Multi-Port Fuel Injection	95-3157VR	1
Cylinder Head Gasket	1984		VR2000	3758	1
Cyl. Head Spacer Shim	1984		Requires Sealing Compound	Steel 3758S	1
Valve Cover Set	1984		(Contains Valve Cover End Plug) Cork Rubber	VS30024	1
			(Contains Valve Cover End Plug) Tuff-Cork	VS30024TC	1
Valve Stem Seal, Exh.	1984		Teflon	B45423	4
			Fluoroelastomer	B45546	4
Valve Stem Seal, Int.	1984		Teflon	B45423	4
			Fluoroelastomer	B45546	4
Manifold Set, Exhaust	1984		To Be Replaced By MS12375	MS10030W	1
				MS12375	1
Manifold Set, Intake	1984			MS12278	1
Oil Pan Set	1984		Victo-Tech	OS20056	1
Rear Main Seal Set	1984			JV567	1
Timing Cover Set	1984			JV982	1

MISCELLANEOUS GASKETS					
Camshaft Seal	1984			66960	3
Dist. Mounting Gasket	1984			B25941	1
Exhaust Pipe Gasket	1984		Single Pipe, (Flange Type), Pipe To Manifold	F7487	1
			Twin Pipe, (Flange Type), Pipe To Manifold	F14603	1
			(Flange Type), Catalytic Converter, Rear	F14604	1
Intermediate Shaft Set	1984			JV983	1
Water Outlet Gasket	1984		Victo-Tech	C20119	1
Water Pump Mount Gasket	1984			K20118	1

14	1871CC (1.9L) OHV 4 Cyl, 3.307in./84mm (1972-1977)	14
-----------	---	-----------

Part	Year	VIN	Model/Application	Part Number	Qty.
ENGINE GASKETS					
Valve Stem Seal, Exh.	1975-1977		YA, YB, YC, YD Engine	B20169	4
	1972-1974		ZG, ZH, ZL, ZK, ZW, XT, XU Engine	B20169	4
Valve Stem Seal, Int.	1975-1977		YA, YB, YC, YD Engine	B20169	4
	1972-1974		ZG, ZH, ZL, ZK, ZW, XT, XU Engine	B20169	4
Manifold Set, Exhaust	1975-1977		YA, YB, YC, YD Engine	MS15268	1
	1972-1974		ZG, ZH, ZL, ZK, ZW, XT, XU Engine	MS15268	1
Manifold Set, Intake	1972-1974		ZG, ZH, ZL, ZK, ZW, XT, XU Engine, 2 Barrel Carburetor	MS15273	1
Rear Main Seal	1975-1977		YA, YB, YC, YD Engine Rubber	66691	1
	1972-1974		ZG, ZH, ZL, ZK, ZW, XT, XU Engine Rubber	66691	1
Timing Cover Seal	1975-1977		YA, YB, YC, YD Engine	66709	1
	1972-1974		ZG, ZH, ZL, ZK, ZW, XT, XU Engine	66709	1

MISCELLANEOUS GASKETS					
Exhaust Pipe Gasket	1975-1977		YA, YB, YC, YD Engine, (Flange Type), Pipe To Manifold	F20168	1
	1972-1974		ZG, ZH, ZL, ZK, ZW, XT, XU Engine, (Flange Type), Pipe To Manifold	F20168	1
Water Outlet Gasket	1975-1977		YA, YB, YC, YD Engine Victo-Tech	C20119	1
	1972-1974		ZG, ZH, ZL, ZK, ZW, XT, XU Engine Victo-Tech	C20119	1

15	1984CC (2.0L) 3A SOHC 4 Cyl, 3.248in./82.5mm (1988-1991)	15
-----------	---	-----------

Part	Year	VIN	Model/Application	Part Number	Qty.
ENGINE GASKETS					
Head Set	1988-1991			HS5872	1
Lower Set	1988-1991		(Requires Head Set To Make Full Set)	CS3758	1
Cylinder Head Gasket	1988-1991			5872	1
Valve Cover Set	1988-1991		(Contains Valve Cover End Plug) Cork Rubber	VS30024	1

15 (cont.)	1984CC (2.0L) 3A SOHC 4 Cyl, 3.248in./82.5mm (1988-1991)				15 (cont.)
----------------------	---	--	--	--	----------------------

<i>Part</i>	<i>Year</i>	<i>VIN</i>	<i>Model/Application</i>	<i>Part Number</i>	<i>Qty.</i>
ENGINE GASKETS (cont.)					
Valve Cover Set (cont.)	1988-1991		(Contains Valve Cover End Plug) <i>Tuff-Cork</i>	VS30024TC	1
Valve Stem Seal, Exh.	1988-1991		<i>Teflon</i>	B45423	4
			<i>Fluoroelastomer</i>	B45546	4
Valve Stem Seal, Int.	1988-1991		<i>Teflon</i>	B45423	4
			<i>Fluoroelastomer</i>	B45546	4
Manifold Set, Exhaust	1988-1991			MS12375	1
Manifold Set, Intake	1988-1991			MS15637	1
Oil Pan Set	1988-1991		<i>Victo-Tech</i>	OS20056	1
Rear Main Seal Set	1988-1991			JV567	1
Timing Cover Set	1988-1991			JV982	1

MISCELLANEOUS GASKETS					
Camshaft Seal	1988-1991			66960	3
Dist. Mounting Gasket	1988-1990			B25941	1
E.G.R. Gasket	1988-1991			G20269	1
Exhaust Pipe Gasket	1988-1991		California, Single Port Exhaust, (Flange Type), Pipe To Manifold	F7487	1
			Automatic Transmission, (Flange Type), Catalytic Converter To Exhaust Pipe, Rear	F14604	1
			Dual Port Exhaust, Except California, (Flange Type), Pipe To Manifold	F20173	1
	1988-1989		Dual Port Exhaust, (Flange Type), Pipe To Manifold	F20173	1
Intermediate Shaft Set	1988-1991			JV983	1
Throttle Body Gasket	1988-1991			G31123	1
Water Outlet Gasket	1988-1991		<i>Victo-Tech</i>	C20119	1
Water Pump Mount Gasket	1988-1991			K20118	1

16	1986CC (2.0L) CN SOHC Diesel 5 Cyl, 3.012in./76.5mm (1979-1982)				16
-----------	--	--	--	--	-----------

<i>Part</i>	<i>Year</i>	<i>VIN</i>	<i>Model/Application</i>	<i>Part Number</i>	<i>Qty.</i>
ENGINE GASKETS					
Head Set	1979-1981		(Head Gasket Not Included, Replacement Gasket Must Be Of Same Thickness As One Removed)	HS3692	1
Lower Set	1979-1982		(Thickness Is Identified By Groove In Edge Of Gasket, Requires Head Set And Cylinder Head Gasket To Make Full Set)	CS3657	1
Cylinder Head Gasket	1979-1981		(1 Groove) <i>1.4mm Thickness</i>	3692	1
			(2 Grooves) <i>1.5mm Thickness</i>	3692W	1
			(3 Grooves) <i>1.6mm Thickness</i>	3692X	1
Valve Cover Set	1979-1982		(Requires Head Set To Make Full Set)	VS20347	1
Valve Stem Seal, Exh.	1979-1982		<i>Teflon</i>	B20174	5
Valve Stem Seal, Int.	1979-1982		<i>Teflon</i>	B20174	5
Manifold Set, Exhaust	1979-1982			MS10030	1
Manifold Set, Intake	1979-1982			MS15283	1
Oil Pan Set	1979-1982		<i>Tuff-Cork</i>	OS30171TC	1
Rear Main Seal Set	1979-1982			JV567	1
Timing Cover Set	1979-1982		(Oil Pan Gasket Must Be Replaced)	JV984	1
MISCELLANEOUS GASKETS					
Exhaust Pipe Gasket	1979-1982		Except California, (Flange Type), Pipe To Manifold	F7487	1
			California, (Flange Type), Pipe To Manifold	F20173	1
Water Outlet Gasket	1979-1982		<i>Victo-Tech</i>	C20172	1
Water Pump Mount Gasket	1979-1982			K27407	1

Audi

17 2144CC (2.2L) KH SOHC 5 Cyl, 3.130in./79.5mm (1984-1985)

17

Part	Year	VIN	Model/Application	Part Number	Qty.
ENGINE GASKETS					
Head Set	1984-1985			HS3657Y	1
Lower Set	1984-1985			CS3657	1
Valve Cover Set	1984-1985		(Contains Valve Cover End Plug) <i>Cork Rubber</i>	VS50010	1
Valve Stem Seal, Exh.	1984-1985		<i>Teflon</i>	B20174	5
Valve Stem Seal, Int.	1984-1985		<i>Teflon</i>	B20174	5
Manifold Set, Exhaust	1984-1985			MS10030	1
Manifold Set, Intake	1984-1985			MS15317	1
Oil Pan Set	1984-1985		<i>Tuff-Cork</i>	OS30171TC	1
Rear Main Seal Set	1984-1985			JV567	1
Timing Cover Seal	1984-1985		(Requires Oil Pan Set)	66806	1

MISCELLANEOUS GASKETS

Exhaust Pipe Gasket	1984-1985		(Flange Type), Pipe To Manifold	F7492	1
Vlv. Cover Plug Gasket	1984-1985		(Semi Circular)	B45491	1
Water Outlet Gasket	1984-1985		Water Outlet Flange <i>Victo-Tech</i>	C20172	1
Water Pump Mount Gasket	1984-1985			K27407	1

18 2144CC (2.2L) WK SOHC 5 Cyl, 3.130in./79.5mm (1980-1983)

18

Part	Year	VIN	Model/Application	Part Number	Qty.
ENGINE GASKETS					
Head Set	1981-1983			HS3657Y	1
	1980			HS3657W	1
Lower Set	1980-1983		(Requires Head Set To Make Full Set)	CS3657	1
Valve Cover Set	1981-1983		(Contains Valve Cover End Plug) <i>Cork Rubber</i>	VS50010	1
	1980		(Contains Valve Cover End Plug)	VS20346	1
Valve Stem Seal, Exh.	1980-1983		<i>Teflon</i>	B20174	5
Valve Stem Seal, Int.	1980-1983		<i>Teflon</i>	B20174	5
Manifold Set, Exhaust	1980-1983			MS10030	1
Manifold Set, Intake	1980-1983			MS15317	1
Oil Pan Set	1980-1983		<i>Tuff-Cork</i>	OS30171TC	1
Rear Main Seal Set	1980-1983			JV567	1
Timing Cover Seal	1983		(Requires Oil Pan Set)	66806	1

MISCELLANEOUS GASKETS

Exhaust Pipe Gasket	1980-1983		(Flange Type), Pipe To Manifold	F7492	1
Vlv. Cover Plug Gasket	1980-1983		(Semi Circular)	B45491	1
Water Outlet Gasket	1980-1983		Water Outlet Flange <i>Victo-Tech</i>	C20172	1
Water Pump Mount Gasket	1980-1983			K27407	1

19 2144CC (2.2L) WU SOHC 5 Cyl, 3.130in./79.5mm (1984)

19

Part	Year	VIN	Model/Application	Part Number	Qty.
ENGINE GASKETS					
Head Set	1984			HS3657X	1
Lower Set	1984		(Requires Head Set To Make Full Set)	CS3657	1
Valve Cover Set	1984		(Contains Valve Cover End Plug) <i>Cork Rubber</i>	VS50010	1
Valve Stem Seal, Exh.	1984		<i>Teflon</i>	B20174	5
Valve Stem Seal, Int.	1984		<i>Teflon</i>	B20174	5
Manifold Set, Exhaust	1984			MS10030	1
Manifold Set, Intake	1984			MS15317	1
Oil Pan Set	1984		<i>Tuff-Cork</i>	OS30171TC	1
Rear Main Seal Set	1984			JV567	1
Timing Cover Seal	1984		(Requires Oil Pan Set)	66806	1

19	2144CC (2.2L) WU SOHC 5 Cyl, 3.130in./79.5mm (1984)	19
(cont.)		(cont.)

Part	Year	VIN	Model/Application	Part Number	Qty.
MISCELLANEOUS GASKETS					
Exhaust Pipe Gasket	1984		(Flange Type), Pipe To Manifold	F20173	1
Thermostat O-Ring	1984			B45684	1
Throttle Body Gasket	1984			G31123	1
Vlv. Cover Plug Gasket	1984		(Semi Circular)	B45491	1
Water Outlet Gasket	1984		Water Outlet Flange	<i>Victo-Tech</i> C20172	1
Water Pump Mount Gasket	1984			K27407	1

20	2144CC (2.2L) WX SOHC 5 Cyl, 3.130in./79.5mm (1983-1985)	20
-----------	---	-----------

Part	Year	VIN	Model/Application	Part Number	Qty.
ENGINE GASKETS					
Head Set	1983-1985			HS3657Y	1
Lower Set	1983-1985		(Requires Head Set To Make Full Set)	CS3657	1
Valve Cover Set	1983-1985		(Contains Valve Cover End Plug)	<i>Cork Rubber</i> VS50010	1
Valve Stem Seal, Exh.	1983-1985			<i>Teflon</i> B20174	5
Valve Stem Seal, Int.	1983-1985			<i>Teflon</i> B20174	5
Manifold Set, Exhaust	1983-1985			MS10030	1
Manifold Set, Intake	1983-1985			MS15317	1
Oil Pan Set	1983-1985			<i>Tuff-Cork</i> OS30171TC	1
Rear Main Seal Set	1983-1985			JV567	1
Timing Cover Seal	1983-1985		(Requires Oil Pan Set)	66806	1

MISCELLANEOUS GASKETS					
Exhaust Pipe Gasket	1983-1985		(Flange Type), Pipe To Manifold	F7492	1
Vlv. Cover Plug Gasket	1983-1985			B45491	1
Water Outlet Gasket	1983-1985			<i>Victo-Tech</i> C20172	1
Water Pump Mount Gasket	1983-1985			K27407	1

21	2144CC (2.2L) WD SOHC Volkswagen 5 Cyl, 3.130in./79.5mm (1978-1983)	21
-----------	--	-----------

Part	Year	VIN	Model/Application	Part Number	Qty.
ENGINE GASKETS					
Head Set	1981-1983			HS3657X	1
	1978-1980			HS3657	1
Lower Set	1978-1983		(Requires Head Set To Make Full Set)	CS3657	1
Valve Cover Set	1981-1983		(Contains Valve Cover End Plug)	<i>Cork Rubber</i> VS50010	1
	1978-1980		(Contains Valve Cover End Plug)	VS30170	1
Valve Stem Seal, Exh.	1978-1983			<i>Teflon</i> B20174	5
Valve Stem Seal, Int.	1978-1983			<i>Teflon</i> B20174	5
Manifold Set, Exhaust	1978-1983			MS10030	1
Manifold Set, Intake	1981-1983			MS15317	1
	1978-1980			MS15283	1
Oil Pan Set	1978-1983			<i>Tuff-Cork</i> OS30171TC	1
Rear Main Seal Set	1978-1983			JV567	1
Timing Cover Seal	1978-1983		(Requires Oil Pan Set)	66806	1

MISCELLANEOUS GASKETS					
Exhaust Pipe Gasket	1978-1983		(Flange Type), Pipe To Manifold	F7487	1
Thermostat O-Ring	1978-1983			B45684	1
Throttle Body Gasket	1978-1983			G31123	1
Vlv. Cover Plug Gasket	1978-1983		(Semi Circular)	B45491	1
Water Outlet Gasket	1978-1983		Water Outlet Flange	<i>Victo-Tech</i> C20172	1
Water Pump Mount Gasket	1978-1983			K27407	1

Audi

22 2144CC (2.2L) WE Volkswagen 5 Cyl, 3.130in./79.5mm (1978-1984)

22

Part	Year	VIN	Model/Application	Part Number	Qty.
ENGINE GASKETS					
Head Set	1981-1984			HS3657X	1
	1978-1980			HS3657	1
Lower Set	1978-1984		(Requires Head Set To Make Full Set)	CS3657	1
Valve Cover Set	1980-1984		Cork Rubber	VS50010	1
	1978-1979		(Contains Valve Cover End Plug)	VS30170	1
Valve Stem Seal, Exh.	1978-1984		Teflon	B20174	5
Valve Stem Seal, Int.	1978-1984		Teflon	B20174	5
Manifold Set, Exhaust	1978-1984			MS10030	1
Manifold Set, Intake	1981-1984			MS15317	1
	1978-1980			MS15283	1
Oil Pan Set	1978-1984		Tuff-Cork	OS30171TC	1
Rear Main Seal Set	1978-1984			JV567	1
Timing Cover Seal	1978-1984		(Requires Oil Pan Set)	66806	1

MISCELLANEOUS GASKETS

Exhaust Pipe Gasket	1984		(Flange Type), Pipe To Manifold	F20173	1
	1978-1983		(Flange Type), Pipe To Manifold	F7487	1
Thermostat O-Ring	1978-1984			B45684	1
Throttle Body Gasket	1978-1984			G31123	1
Vlv. Cover Plug Gasket	1978-1984		(Semi Circular)	B45491	1
	1978-1981		Gasoline, (Semi Circular)	B45491	1
Water Outlet Gasket	1978-1984		Water Outlet Flange	Victo-Tech C20172	1
Water Pump Mount Gasket	1978-1984			K27407	1

23 2226CC (2.2L) KZ SOHC 5 Cyl, 3.189in./81mm (1985-1987)

23

Part	Year	VIN	Model/Application	Part Number	Qty.
ENGINE GASKETS					
Head Set	1985-1987			HS5711	1
Lower Set	1985-1987		(Requires Head Set To Make Full Set)	CS3657	1
Cylinder Head Gasket	1985-1987			5711	1
Valve Cover Set	1985-1987		(Contains Valve Cover End Plug) Cork Rubber	VS50010	1
Valve Stem Seal, Exh.	1985-1987		Teflon	B20174	5
Valve Stem Seal, Int.	1985-1987		Teflon	B20174	5
Manifold Set, Exhaust	1985-1987			MS10030	1
Manifold Set, Intake	1985-1987			MS15283	1
Oil Pan Set	1985-1987		Tuff-Cork	OS30171TC	1
Rear Main Seal Set	1985-1987			JV567	1
Timing Cover Seal	1985-1987		(Requires Oil Pan Set)	66806	1

MISCELLANEOUS GASKETS

Exhaust Pipe Gasket	1986-1987		(Flange Type), Catalytic Converter, Rear	F10110	2
			(Flange Type), Catalytic Converter, Front	F14604	1
	1985-1987		(Flange Type), Pipe To Manifold	F20173	1
Throttle Body Gasket	1985-1987			G31123	1
Vlv. Cover Plug Gasket	1985-1987		(Semi Circular)	B45491	1
Water Outlet Gasket	1985-1987		Water Outlet Flange	Victo-Tech C20172	1
Water Pump Mount Gasket	1985-1987			K27407	1

24 2226CC (2.2L) MC SOHC 5 Cyl, 3.189in./81mm (1986-1988)

24

Part	Year	VIN	Model/Application	Part Number	Qty.
ENGINE GASKETS					
Lower Set	1986-1988		(Requires Head Set To Make Full Set)	CS3657	1
Cylinder Head Gasket	1986-1988			5711	1
Valve Cover Set	1986-1988		(Contains Valve Cover End Plug) Cork Rubber	VS50010	1

24 2226CC (2.2L) MC SOHC 5 Cyl, 3.189in./81mm (1986-1988) **24**
(cont.) (cont.)

Part	Year	VIN	Model/Application	Part Number	Qty.
ENGINE GASKETS (cont.)					
Manifold Set, Exhaust	1986-1988			MS10030	1
Manifold Set, Intake	1986-1988			MS15317	1
Oil Pan Set	1986-1988		Tuff-Cork	OS30171TC	1
Rear Main Seal Set	1986-1988			JV567	1
Timing Cover Seal	1986-1988		(Requires Oil Pan Set)	66806	1

MISCELLANEOUS GASKETS					
Exhaust Pipe Gasket	1986-1988		(Flange Type), Catalytic Converter, Rear	F10110	2
			(Flange Type), Catalytic Converter, Front	F14604	1
			(Flange Type), Pipe To Manifold	F20173	1
Thermostat O-Ring	1986-1988			B45684	1
Throttle Body Gasket	1986-1988			G31123	1
Vlv. Cover Plug Gasket	1986-1987		(Semi Circular)	B45491	1
Water Outlet Gasket	1986-1988		Water Outlet Flange Victo-Tech	C20172	1
Water Pump Mount Gasket	1986-1988			K27407	1

25 2226CC (2.2L) JT/KX Volkswagen 5 Cyl, 3.189in./81mm (1984-1987) **25**

Part	Year	VIN	Model/Application	Part Number	Qty.
------	------	-----	-------------------	-------------	------

ENGINE GASKETS					
Head Set	1984-1987			HS5711	1
Lower Set	1984-1987		(Requires Head Set To Make Full Set)	CS3657	1
Cylinder Head Gasket	1984-1987			5711	1
Valve Cover Set	1984-1987		(Contains Valve Cover End Plug) Cork Rubber	VS50010	1
Valve Stem Seal, Exh.	1984-1987		Teflon	B20174	5
Valve Stem Seal, Int.	1984-1987		Teflon	B20174	5
Manifold Set, Exhaust	1984-1987			MS10030	1
Manifold Set, Intake	1984-1987			MS15283	1
Oil Pan Set	1984-1987		Tuff-Cork	OS30171TC	1
Rear Main Seal Set	1984-1987			JV567	1
Timing Cover Seal	1984-1987		(Requires Oil Pan Set)	66806	1

MISCELLANEOUS GASKETS					
Exhaust Pipe Gasket	1986-1987		(Flange Type), Catalytic Converter, Rear	F10110	2
			(Flange Type), Catalytic Converter, Front	F14604	1
			(Flange Type), Pipe To Manifold	F20173	1
Throttle Body Gasket	1984-1987			G31123	1
Vlv. Cover Plug Gasket	1984-1987		(Semi Circular)	B45491	1
Water Outlet Gasket	1984-1987		Water Outlet Flange Victo-Tech	C20172	1
Water Pump Mount Gasket	1984-1987			K27407	1

26 2309CC (2.3L) 7A DOHC 5 Cyl, 3.248in./82.5mm (1989-1991) **26**

Part	Year	VIN	Model/Application	Part Number	Qty.
------	------	-----	-------------------	-------------	------

ENGINE GASKETS					
Head Set	1989-1991			HS5873W	1
Valve Cover Set	1989-1991		Cork Rubber	VS50010	1
Valve Stem Seal, Int.	1989-1991		Teflon	B20174	10
Rear Main Seal Set	1989-1991			JV567	1

MISCELLANEOUS GASKETS					
E.G.R. Gasket	1989-1991			G20269	1
Throttle Body Gasket	1989-1991			G31123	1
Water Pump Mount Gasket	1989-1991			K27407	1

Audi

27 2309CC (2.3L) NF SOHC 5 Cyl, 3.248in./82.5mm (1987-1991)

27

Part	Year	VIN	Model/Application	Part Number	Qty.
ENGINE GASKETS					
Head Set	1989-1991		100	HS5873W	1
	1987-1988		5000	HS5873	1
Lower Set	1987-1991		(Requires Head Set To Make Full Set)	CS3657	1
Valve Cover Set	1987-1991		(Contains Valve Cover End Plug) <i>Cork Rubber</i>	VS50010	1
Valve Stem Seal, Exh.	1987-1991		<i>Teflon</i>	B20174	5
Valve Stem Seal, Int.	1987-1991		<i>Teflon</i>	B20174	5
Manifold Set, Exhaust	1987-1991			MS10030	1
Manifold Set, Intake	1989-1991			MS15638	1
	1987-1988			MS15317	1
Oil Pan Set	1987-1991		<i>Tuff-Cork</i>	OS30171TC	1
Rear Main Seal Set	1987-1991			JV567	1
Timing Cover Seal	1987-1991		(Oil Pan Gasket Must Be Replaced)	66806	1

MISCELLANEOUS GASKETS

Camshaft Seal	1987-1988			66960	3
E.G.R. Gasket	1989-1991			G20269	1
Exhaust Pipe Gasket	1987-1988		Canadian Models, (Flange Type), Catalytic Converter, Rear	F10110	2
Thermostat O-Ring	1987-1988			B45684	1
Water Pump Mount Gasket	1987-1991			K27407	1

28 2309CC (2.3L) NG SOHC 5 Cyl, 3.248in./82.5mm (1987-1992)

28

Part	Year	VIN	Model/Application	Part Number	Qty.
ENGINE GASKETS					
Head Set	1988-1992			HS5873W	1
Lower Set	1987-1992		(Requires Head Set To Make Full Set)	CS3657	1
Valve Cover Set	1987-1992		(Contains Valve Cover End Plug) <i>Cork Rubber</i>	VS50010	1
Valve Stem Seal, Exh.	1987-1992		<i>Teflon</i>	B20174	5
Valve Stem Seal, Int.	1987-1992		<i>Teflon</i>	B20174	5
Manifold Set, Exhaust	1987-1992			MS10030	1
Manifold Set, Intake	1987-1992			MS15638	1
Oil Pan Set	1987-1992		<i>Tuff-Cork</i>	OS30171TC	1
Rear Main Seal Set	1987-1992			JV567	1
Timing Cover Seal	1987-1992		(Requires Oil Pan Set)	66806	1

MISCELLANEOUS GASKETS

Camshaft Seal	1987-1992			66960	3
E.G.R. Gasket	1989-1992			G20269	1
Throttle Body Gasket	1987-1992			G31123	1
Water Pump Mount Gasket	1987-1992			K27407	1

29 2771CC (2.8L) AAH SOHC V6 Cyl, 3.248in./82.5mm (1992-1995)

29

Part	Year	VIN	Model/Application	Part Number	Qty.
ENGINE GASKETS					
Head Set	1992-1995			HS54042	1
Lower Set	1992-1995		(Requires Head Set To Make Full Set)	CS54042	1
Cylinder Head Gasket	1992-1995			54042	2
Valve Cover Set	1992-1995		<i>Victo-Tech</i>	VS50233	1
Valve Stem Seal, Exh.	1992-1995			B45618	6
Valve Stem Seal, Int.	1992-1995			B45618	6
Manifold Set, Exhaust	1992-1995			MS16195	1
Manifold Set, Intake	1992-1995		(Contains Plenum Chamber Gasket)	MS16193	1
Plenum Chamber Gasket	1992-1995			MS16194	1
Oil Pan Set	1992-1995		Upper	OS32148	1
			Lower	OS32149	1
Rear Main Seal Set	1992-1995			JV1631	1

29 2771CC (2.8L) AAH SOHC V6 Cyl, 3.248in./82.5mm (1992-1995) **29**
(cont.) (cont.)

Part	Year	VIN	Model/Application	Part Number	Qty.
------	------	-----	-------------------	-------------	------

ENGINE GASKETS (cont.)

Timing Cover Seal	1992-1995			66806	1
-------------------	-----------	--	--	-------	---

MISCELLANEOUS GASKETS

Camshaft Seal	1992-1995			66960	2
E.G.R. Gasket	1992-1995			G31494	1
Thermostat O-Ring	1992-1995			B45684	1
Throttle Body Gasket	1992-1995			G31493	1
Water Pump Mount Gasket	1992-1995			K31492	1

Austin

Engine Index

Engine	Year	Block	Engine	Year	Block
848CC (0.8L)	1959-1967	1	1098CC (1.1L)	1962-1966	4
948CC (0.9L)	1952-1963	2	1275CC (1.3L)	1967-1972	5
998CC (1.0L)	1963-1965	3	1798CC (1.8L)	1968-1975	6

Model Index

Model	Engine	Year	Block	Model	Engine	Year	Block
1800	1798CC (1.8L)	1966-1978	6	Mini Car	848CC (0.8L)	1959-1978	1
	1798CC (1.8L)	1964-1978	6	Mini Cooper	998CC (1.0L)	1965-1970	3
America	1275CC (1.3L)	1968-1972	5	Mini Cooper	998CC (1.0L)	1963-1969	3
Cooper	998CC (1.0L)	1963-1969	3	S			
Healey	1275CC (1.3L)	1967-1970	5	Sprite	948CC (0.9L)	1958-1962	2
Marina	1798CC (1.8L)	1968-1978	6	Sprite	1098CC (1.1L)	1962-1970	4
Mark II	1098CC (1.1L)	1962-1970	4	Sprite	1275CC (1.3L)	1966-1970	5
Mark III	1098CC (1.1L)	1962-1970	4				

1 848CC (0.8L) 4 Cyl, 2.480in./63mm (1959-1967) **1**

Part	Year	VIN	Model/Application	Part Number	Qty.
------	------	-----	-------------------	-------------	------

ENGINE GASKETS

Head Set	1959-1967			HS3611	1
Valve Cover Set	1959-1967			VS30025	1
Manifold Set, Int. & Exh.	1959-1967			MS15243	1
Timing Cover Seal	1959-1967			66550	1

MISCELLANEOUS GASKETS

Water Outlet Gasket	1959-1967			C24093	1
---------------------	-----------	--	--	--------	---

2 948CC (0.9L) 4 Cyl, 2.478in./62.9mm (1952-1963) **2**

Part	Year	VIN	Model/Application	Part Number	Qty.
------	------	-----	-------------------	-------------	------

ENGINE GASKETS

Head Set	1952-1963			HS3611	1
Valve Cover Set	1952-1963			VS30025	1
Manifold Set, Int. & Exh.	1952-1963			MS15243	1
Timing Cover Seal	1952-1963			66550	1

MISCELLANEOUS GASKETS

Water Outlet Gasket	1952-1963			C24093	1
---------------------	-----------	--	--	--------	---

3 998CC (1.0L) 4 Cyl, 2.542in./64.6mm (1963-1965) **3**

Part	Year	VIN	Model/Application	Part Number	Qty.
------	------	-----	-------------------	-------------	------

ENGINE GASKETS

Head Set	1963-1965			HS3611	1
Valve Cover Set	1963-1965			VS30025	1

Austin

3 (cont.)	998CC (1.0L) 4 Cyl, 2.542in./64.6mm (1963-1965)					3 (cont.)
---------------------	--	--	--	--	--	---------------------

<i>Part</i>	<i>Year</i>	<i>VIN</i>	<i>Model/Application</i>	<i>Part Number</i>	<i>Qty.</i>
-------------	-------------	------------	--------------------------	--------------------	-------------

ENGINE GASKETS (cont.)

Manifold Set, Int. & Exh.	1963-1965			MS15243	1
Timing Cover Seal	1963-1965			66550	1

MISCELLANEOUS GASKETS

Water Outlet Gasket	1963-1965			C24093	1
---------------------	-----------	--	--	--------	---

4	1098CC (1.1L) 4 Cyl, 2.542in./64.6mm (1962-1966)					4
----------	---	--	--	--	--	----------

<i>Part</i>	<i>Year</i>	<i>VIN</i>	<i>Model/Application</i>	<i>Part Number</i>	<i>Qty.</i>
-------------	-------------	------------	--------------------------	--------------------	-------------

ENGINE GASKETS

Head Set	1962-1966			HS3611	1
Valve Cover Set	1962-1966			VS30025	1
Manifold Set, Int. & Exh.	1962-1966			MS15243	1
Timing Cover Seal	1962-1966			66550	1

MISCELLANEOUS GASKETS

Push Rod Cover Set	1962-1966			PS20316	1
Water Outlet Gasket	1962-1966			C24093	1

5	1275CC (1.3L) 4 Cyl, 2.780in./70.6mm (1967-1972)					5
----------	---	--	--	--	--	----------

<i>Part</i>	<i>Year</i>	<i>VIN</i>	<i>Model/Application</i>	<i>Part Number</i>	<i>Qty.</i>
-------------	-------------	------------	--------------------------	--------------------	-------------

ENGINE GASKETS

Head Set	1970-1972		America	HS3612	1
	1967-1970		Sprite	HS3611	1
			Healey	HS3612	1
Lower Set	1967-1970		(Requires Head Set To Make Full Set)	CS3612	1
Cylinder Head Gasket	1967-1972			3612	1
Valve Cover Set	1967-1972			VS30025	1
Manifold Set, Int. & Exh.	1967-1972			MS15243	1
Oil Pan Set	1967-1970		Healey	OS20059	1
Timing Cover Seal	1967-1972			66550	1

MISCELLANEOUS GASKETS

Water Outlet Gasket	1967-1972			C24093	1
---------------------	-----------	--	--	--------	---

6	1798CC (1.8L) 4 Cyl, 3.160in./80.3mm (1968-1975)					6
----------	---	--	--	--	--	----------

<i>Part</i>	<i>Year</i>	<i>VIN</i>	<i>Model/Application</i>	<i>Part Number</i>	<i>Qty.</i>
-------------	-------------	------------	--------------------------	--------------------	-------------

ENGINE GASKETS

Head Set	1968-1975			HS3614	1
Lower Set	1968-1975		(Requires Head Set And Timing Cover Set And Rear Main Seal To Make Full Set)	CS3614	1
Cylinder Head Gasket	1968-1975			3614	1
Valve Cover Set	1968-1975			VS30026	1
Manifold Set, Int. & Exh.	1968-1975			MS15234	1
Oil Pan Set	1968-1975			OS20063	1
Rear Main Seal	1968-1975		<i>Rubber</i>	66746	1
Timing Cover Seal	1968-1975			66550	1

MISCELLANEOUS GASKETS

Water Outlet Gasket	1968-1975			C24093	1
---------------------	-----------	--	--	--------	---

Engine Index

Engine	Year	Block
1766CC (1.8L) SOHC 8 Valve	1980-1985	1
1990CC (2.0L) SOHC 8 Valve	1968-1979	2
2443CC (2.4L) SOHC 12 Valve Diesel	1985-1986	3
2494CC (2.5L) SOHC 12 Valve	1987-1991	4
2494CC (2.5L) SOHC 12 Valve	1969-1971	5

Engine	Year	Block
2693CC (2.7L) SOHC 12 Valve	1982-1988	6
2788CC (2.8L) SOHC 12 Valve	1969-1981	7
2985CC (3.0L) SOHC 12 Valve	1975-1978	8
3210CC (3.2L) SOHC 12 Valve	1978-1984	9
3430CC (3.4L) SOHC 12 Valve	1985-1993	10

Model Index

Model	Engine	Year	Block
2.8 Bavaria	2788CC (2.8L) SOHC 12 Valve	1971	7
3.0SI	2985CC (3.0L) SOHC 12 Valve	1975-1976	8
318I	1766CC (1.8L) SOHC 8 Valve	1984-1985	1
320I	1766CC (1.8L) SOHC 8 Valve	1980-1983	1
320I	1990CC (2.0L) SOHC 8 Valve	1977-1979	2
325	2693CC (2.7L) SOHC 12 Valve	1986-1988	6
325E	2693CC (2.7L) SOHC 12 Valve	1984-1987	6
325ES	2693CC (2.7L) SOHC 12 Valve	1986-1987	6
325IS	2494CC (2.5L) SOHC 12 Valve	1987-1990	4
325i	2494CC (2.5L) SOHC 12 Valve	1987-1991	4
325iC	2494CC (2.5L) SOHC 12 Valve	1990-1992	4
325iX	2494CC (2.5L) SOHC 12 Valve	1988-1991	4
524TD	2443CC (2.4L) SOHC 12 Valve Diesel	1985-1986	3
525i	2494CC (2.5L) SOHC 12 Valve	1989-1991	4
528E	2693CC (2.7L) SOHC 12 Valve	1982-1988	6
528I	2788CC (2.8L) SOHC 12 Valve	1979-1981	7
530i	2985CC (3.0L) SOHC 12 Valve	1975-1978	8
533I	3210CC (3.2L) SOHC 12 Valve	1980-1984	9
535I	3430CC (3.4L) SOHC 12 Valve	1985-1993	10

Model	Engine	Year	Block
535IS	3430CC (3.4L) SOHC 12 Valve	1987-1988	10
630CSI	2985CC (3.0L) SOHC 12 Valve	1977	8
633CSI	3210CC (3.2L) SOHC 12 Valve	1978-1984	9
635CSI	3430CC (3.4L) SOHC 12 Valve	1985-1989	10
733I	3210CC (3.2L) SOHC 12 Valve	1978-1984	9
735IL	3430CC (3.4L) SOHC 12 Valve	1988-1992	10
735i	3430CC (3.4L) SOHC 12 Valve	1985-1992	10
2000	1990CC (2.0L) SOHC 8 Valve	1966-1972	2
2000Tii	1990CC (2.0L) SOHC 8 Valve	1969-1972	2
2002	1990CC (2.0L) SOHC 8 Valve	1968-1976	2
2002A	1990CC (2.0L) SOHC 8 Valve	1976	2
2002Ti	1990CC (2.0L) SOHC 8 Valve	1971	2
2002Tii	1990CC (2.0L) SOHC 8 Valve	1971-1974	2
2500	2494CC (2.5L) SOHC 12 Valve	1969-1971	5
2800	2788CC (2.8L) SOHC 12 Valve	1971-1974	7
2800CS	2788CC (2.8L) SOHC 12 Valve	1971	7
	2788CC (2.8L) SOHC 12 Valve	1969-1976	7
	2985CC (3.0L) SOHC 12 Valve	1971-1976	8
L6	3430CC (3.4L) SOHC 12 Valve	1987	10
L7	3430CC (3.4L) SOHC 12 Valve	1986-1987	10

1 1766CC (1.8L) SOHC 8 Valve 4 Cyl, 3.504in./89mm (1980-1985) 1

Part	Year	VIN	Model/Application	Part Number	Qty.
-------------	-------------	------------	--------------------------	--------------------	-------------

ENGINE GASKETS

Head Set	1980-1985			HS3651Z	1
Lower Set	1980-1985		(Lower Oil Pan Gasket Not Included, Requires Head Set To Make Full Set)	CS3651	1
Cylinder Head Gasket	1980-1984			3651	1
Valve Cover Set	1980-1985			VS30177	1
Valve Stem Seal, Exh.	1980-1985			B45544	4
Valve Stem Seal, Int.	1980-1985			B45544	4
Manifold Set, Exhaust	1980-1985			MS15534	1
Manifold Set, Intake	1980-1985			MS15260	1
Oil Pan Set	1984-1985		Pan	OS32050	1
	1980-1985		Pan To Block	<i>Cork Rubber</i> OS30176	1
Rear Main Seal	1980-1985			<i>Rubber</i> 66707	1

MISCELLANEOUS GASKETS

Exhaust Pipe Gasket	1980-1985		(Flange Type), Pipe To Manifold	F20178	1
Water Pump Mount Gasket	1980-1985			K31013	1

BMW

2 1990CC (2.0L) SOHC 8 Valve 4 Cyl, 3.504in./89mm (1968-1979) 2

Part	Year	VIN	Model/Application	Part Number	Qty.
ENGINE GASKETS					
Head Set	1979			HS3651Y	1
	1977-1978			HS3651X	1
	1973-1976			HS3651W	1
	1968-1972			HS3651	1
Lower Set	1973-1979		(Requires Head Set To Make Full Set)	CS3651	1
Cylinder Head Gasket	1968-1979			3651	1
Valve Cover Set	1968-1979			VS30177	1
Valve Stem Seal, Exh.	1977-1979			B45544	4
	1968-1976			B45445	4
Valve Stem Seal, Int.	1977-1979			B45544	4
	1968-1976			B45445	4
Manifold Set, Exhaust	1968-1979			MS15262	1
Manifold Set, Intake	1968-1979			MS15260	1
Oil Pan Set	1968-1979		Cork Rubber	OS30176	1
Rear Main Seal	1973-1979		Rubber	66707	1
	1968-1972		Rubber	66748	1

MISCELLANEOUS GASKETS

Exhaust Pipe Gasket	1977-1979		(Flange Type)	F20178	1
	1968-1976		(Flange Type), Pipe To Manifold	F20178	1
Water Pump Mount Gasket	1968-1979			K31013	1

3 2443CC (2.4L) SOHC 12 Valve Diesel 6 Cyl, 3.150in./80mm (1985-1986) 3

Part	Year	VIN	Model/Application	Part Number	Qty.
ENGINE GASKETS					
Head Set	1985-1986		(Head Gasket Not Included, Replacement Gasket Must Be Of Same Thickness As One Removed)	HS4828LH	1
Lower Set	1985-1986		(Requires Head Set And Cylinder Head Gasket To Make Full Set)	CS4828	1
Cylinder Head Gasket	1985-1986		1.43mm Thickness	4828	1
			1.54mm Thickness	4829	1
			1.70mm Thickness	4830	1
Valve Cover Set	1985-1986		Victo-Tech	VS38431	1
Valve Stem Seal, Exh.	1985-1986			B45498	6
Valve Stem Seal, Int.	1985-1986			B45498	6
Manifold Set, Exhaust	1985-1986			MS10052	1
Manifold Set, Intake	1985-1986			MS10058	1
Oil Pan Set	1985-1986		Cork Rubber	OS30992	1

MISCELLANEOUS GASKETS

Thermostat O-Ring	1985-1986		Victo-Tech	C45551	1
Water Outlet Gasket	1985-1986		(Inlet)	C26943	1
			Front	C26944	1
			Rear	C26945	1
Water Pump Mount Gasket	1985-1986		(Ring Type 'F')	K27876	1

4 2494CC (2.5L) SOHC 12 Valve 6 Cyl, 3.307in./84mm (1987-1991) 4

Part	Year	VIN	Model/Application	Part Number	Qty.
ENGINE GASKETS					
Head Set	1987-1991		Single Overhead Camshaft Engine	HS4839W	1
Lower Set	1987-1991		(Requires Head Set To Make Full Set)	CS4839	1
Cylinder Head Gasket	1987-1991			4839	1
Valve Cover Set	1987-1991			VS38432	1
Valve Stem Seal, Exh.	1987-1991			B45498	6
Valve Stem Seal, Int.	1987-1991			B45498	6
Manifold Set, Exhaust	1987-1991			MS15674	1

4 2494CC (2.5L) SOHC 12 Valve 6 Cyl, 3.307in./84mm (1987-1991) **4**
(cont.) (cont.)

Part *Year* *VIN* *Model/Application* *Part Number* *Qty.*

ENGINE GASKETS (cont.)

Manifold Set, Intake	1987-1991			MS12376	1
Oil Pan Set	1987-1991			Cork Rubber OS30992	1
Rear Main Seal Set	1987-1991			JV548	1
Timing Cover Set	1987-1991			JV1023	1

MISCELLANEOUS GASKETS

Camshaft Seal	1987-1991			67151	1
Exhaust Pipe Gasket	1987-1991		Catalytic Converter	F10109	2
			Pipe To Manifold	F20314	1
Inter Shaft Seal	1987-1991			67151	1
Water Pump Mount Gasket	1987-1991			K27876	1

5 2494CC (2.5L) SOHC 12 Valve 6 Cyl, 3.386in./86mm (1969-1971) **5**

Part *Year* *VIN* *Model/Application* *Part Number* *Qty.*

ENGINE GASKETS

Valve Cover Set	1969-1971			VS38137	1
Valve Stem Seal, Exh.	1969-1971			B45445	6
Valve Stem Seal, Int.	1969-1971			B45445	6
Manifold Set, Intake	1969-1971			MS16711	1
Oil Pan Set	1969-1971			OS30313	1
Rear Main Seal	1969-1971			Rubber 66707	1
Timing Cover Set	1969-1971			JV962	1

6 2693CC (2.7L) SOHC 12 Valve 6 Cyl, 3.307in./84mm (1982-1988) **6**

Part *Year* *VIN* *Model/Application* *Part Number* *Qty.*

ENGINE GASKETS

Head Set	1988		528E, (Requires Intake Manifold Gasket)	HS4839	1
	1986-1988		325	HS4839	1
	1987		528E, From 3/87, (Requires Intake Manifold Gasket)	HS4839	1
	1986-1987		325ES	HS4839	1
	1984-1987		325E	HS4839	1
Lower Set	1982-1988		(Requires Head Set To Make Full Set)	CS4839	1
Cylinder Head Gasket	1982-1988			4839	1
Valve Cover Set	1982-1988			VS38432	1
Valve Stem Seal, Exh.	1982-1988			B45498	6
Valve Stem Seal, Int.	1982-1988			B45498	6
Manifold Set, Exhaust	1982-1988			MS12315	1
Manifold Set, Intake	1988		528E	MS12376	1
	1986-1988		325	MS12314	1
	1987		528E, Thru 3/87	MS12314	1
			528E, From 3/87	MS12376	1
	1986-1987		325ES	MS12314	1
	1984-1987		325E	MS12314	1
	1982-1986		528E	MS12314	1
Oil Pan Set	1982-1988			Cork Rubber OS30992	1
Rear Main Seal Set	1982-1988			JV548	1
Timing Cover Set	1982-1988			JV1023	1

MISCELLANEOUS GASKETS

Camshaft Seal	1982-1988			67151	1
Exhaust Pipe Gasket	1982-1988			F20314	1
Water Pump Mount Gasket	1982-1988			K27876	1

BMW

7 2788CC (2.8L) SOHC 12 Valve 6 Cyl, 3.386in./86mm (1969-1981) 7

Part	Year	VIN	Model/Application	Part Number	Qty.
ENGINE GASKETS					
Head Set	1979-1981			HS3650	1
Lower Set	1979-1981		(Requires Head Set To Make Full Set)	CS3650	1
Valve Cover Set	1979-1981			VS38137	1
	1969-1971			VS38137	1
Valve Stem Seal, Exh.	1979-1981			B45544	6
	1969-1971			B45445	6
Valve Stem Seal, Int.	1979-1981			B45544	6
	1969-1971			B45445	6
Manifold Set, Exhaust	1979-1981			MS12313	1
Manifold Set, Intake	1979-1981			MS16711	1
	1969-1971			MS16711	1
Oil Pan Set	1979-1981			OS30313	1
	1969-1971			OS30313	1
Rear Main Seal	1979-1981		Rubber	66707	1
	1969-1971		Rubber	66707	1
Timing Cover Set	1979-1981			JV962	1
	1969-1971			JV962	1

MISCELLANEOUS GASKETS

Exhaust Pipe Gasket	1979-1981		Pipe To Manifold	F7214	1
Water Pump Mount Gasket	1979-1981			K31015	1

8 2985CC (3.0L) SOHC 12 Valve 6 Cyl, 3.504in./89mm (1975-1978) 8

Part	Year	VIN	Model/Application	Part Number	Qty.
ENGINE GASKETS					
Head Set	1975-1978		530i	HS3652	1
	1977		630CSI	HS3652	1
	1975-1976		3.0SI	HS3652	1
Lower Set	1975-1978		530i, (Requires Head Set To Make Full Set)	CS3650	1
	1977		630CSI, (Requires Head Set To Make Full Set)	CS3650	1
	1975-1976		3.0SI, (Requires Head Set To Make Full Set)	CS3650	1
Cylinder Head Gasket	1975-1978		530i	3652	1
	1977		630CSI	3652	1
	1975-1976		3.0SI	3652	1
Valve Cover Set	1975-1978		530i	VS38137	1
	1977		630CSI	VS38137	1
	1975-1976		3.0SI	VS38137	1
Valve Stem Seal, Exh.	1975-1978		530i	B45445	6
	1977		630CSI	B45445	6
	1975-1976		3.0SI	B45445	6
Valve Stem Seal, Int.	1975-1978		530i	B45445	6
	1977		630CSI	B45445	6
	1975-1976		3.0SI	B45445	6
Manifold Set, Exhaust	1975-1978		530i	MS12313	1
	1977		630CSI	MS12313	1
	1975-1976		3.0SI	MS12313	1
Manifold Set, Intake	1975-1978		530i	MS16711	1
	1977		630CSI	MS16711	1
	1975-1976		3.0SI	MS16711	1
Oil Pan Set	1975-1978		530i	OS30313	1
	1977		630CSI	OS30313	1
	1975-1976		3.0SI	OS30313	1
Rear Main Seal	1975-1978		530i Rubber	66707	1
	1977		630CSI Rubber	66707	1
	1975-1976		3.0SI Rubber	66707	1
Timing Cover Set	1975-1978		530i	JV962	1
	1977		630CSI	JV962	1

8 2985CC (3.0L) SOHC 12 Valve 6 Cyl, 3.504in./89mm (1975-1978) **8**
(cont.) (cont.)

Part Year VIN Model/Application Part Number Qty.

ENGINE GASKETS (cont.)

Timing Cover Set (cont.)	1975-1976		3.0SI	JV962	1
--------------------------	-----------	--	-------	-------	---

MISCELLANEOUS GASKETS

Exhaust Pipe Gasket	1975-1978		530i, Pipe To Manifold	F20314	1
	1977		630CSI, Pipe To Manifold	F20314	1
	1975-1976		3.0SI, Pipe To Manifold	F20314	1
				F20314	1
Water Outlet Gasket	1975-1978		530i	C20323	1
	1977		630CSI	C20323	1
	1975-1976		3.0SI	C20323	1
Water Pump Mount Gasket	1975-1978		530i	K31014	1
	1977		630CSI	K31014	1
	1975-1976		3.0SI	K31014	1

9 3210CC (3.2L) SOHC 12 Valve 6 Cyl, 3.504in./89mm (1978-1984) **9**

Part Year VIN Model/Application Part Number Qty.

ENGINE GASKETS

Head Set	1982-1984			HS3652X	1
	1979-1981			HS3652W	1
	1978			HS3652	1
Lower Set	1978-1984		(Requires Head Set To Make Full Set)	CS3650	1
Cylinder Head Gasket	1978-1984			3652	1
Valve Cover Set	1982-1984			VS38387	1
	1978-1981			VS38137	1
Valve Stem Seal, Exh.	1979-1984			B45544	6
	1978			B45445	6
					B45545
Valve Stem Seal, Int.	1979-1984			B45544	6
	1978			B45445	6
					B45545
Manifold Set, Exhaust	1978-1984			MS12313	1
Manifold Set, Intake	1978-1984			MS16711	1
Oil Pan Set	1978-1984			OS30313	1
Rear Main Seal	1978		Rubber	66707	1
Rear Main Seal Set	1979-1984			JV540	1
Timing Cover Set	1979-1984			JV1007	1
	1978			JV962	1

MISCELLANEOUS GASKETS

Camshaft Seal	1978-1984			66627	1
Exhaust Pipe Gasket	1978-1984		Pipe To Manifold	F20314	1
Water Outlet Gasket	1978			C20323	1
Water Pump Mount Gasket	1979-1984			K31015	1
	1978			K31014	1

10 3430CC (3.4L) SOHC 12 Valve 6 Cyl, 3.622in./92mm (1985-1993) **10**

Part Year VIN Model/Application Part Number Qty.

ENGINE GASKETS

Head Set	1987-1993		535I	HS4863W	1
	1988-1992		735IL, 735i	HS4863W	1
	1987-1988		535IS, 635CSI	HS4863W	1
	1987		L6, L7	HS4863W	1
	1986		L7	HS4863	1
	1985-1986		535I, 635CSI, 735i	HS4863	1

BMW

10 (cont.)	3430CC (3.4L) SOHC 12 Valve 6 Cyl, 3.622in./92mm (1985-1993)	10 (cont.)
----------------------	---	----------------------

<i>Part</i>	<i>Year</i>	<i>VIN</i>	<i>Model/Application</i>	<i>Part Number</i>	<i>Qty.</i>
ENGINE GASKETS (cont.)					
Lower Set	1987-1993		535I, (Requires Head Set To Make Full Set)	CS4863	1
	1988-1992		735IL, 735i, (Requires Head Set To Make Full Set)	CS4863	1
	1987-1988		535IS, 635CSI, (Requires Head Set To Make Full Set)	CS4863	1
	1987		L6, L7, (Requires Head Set To Make Full Set)	CS4863	1
	1986		L7, (Requires Head Set To Make Full Set)	CS3650	1
	1985-1986		535I, 635CSI, 735i, (Requires Head Set To Make Full Set)	CS3650	1
Cylinder Head Gasket	1985-1993			4863	1
Valve Cover Set	1985-1993			VS38387	1
Valve Stem Seal, Exh.	1985-1992			B45544	6
Valve Stem Seal, Int.	1985-1992			B45544	6
Manifold Set, Exhaust	1987-1993		535I, (Contains Heat Shield)	MS14756	1
	1988-1992		735IL, 735i, (Contains Heat Shield)	MS14756	1
	1987-1988		535IS, 635CSI, (Contains Heat Shield)	MS14756	1
	1987		L6, L7, (Contains Heat Shield)	MS14756	1
	1986		L7	MS12313	1
	1985-1986		535I, 635CSI, 735i	MS12313	1
Manifold Set, Intake	1987-1993		535I	MS10078	1
	1988-1992		735IL, 735i	MS10078	1
	1987-1988		535IS, 635CSI	MS10078	1
	1987		L6, L7	MS10078	1
	1986		L7	MS10071	1
	1985-1986		535I, 635CSI, 735i	MS10071	1
Oil Pan Set	1987-1993		535I	OS32102	1
	1988-1992		735IL, 735i	OS32102	1
	1987-1988		535IS, 635CSI	OS32102	1
	1987		L6, L7	OS32102	1
	1986		L7	OS30313	1
	1985-1986		535I, 635CSI, 735i	OS30313	1
Rear Main Seal Set	1985-1993			JV540	1
Timing Cover Set	1985-1993			JV1007	1

MISCELLANEOUS GASKETS

Camshaft Seal	1985-1993			66627	1
Exhaust Pipe Gasket	1985-1988		Catalytic Converter	F10117	1
	1986		L7, Pipe To Manifold	F20314	1
	1985-1986		535I, 635CSI, 735i, Pipe To Manifold	F20314	1
Water Pump Mount Gasket	1985-1986			K31015	1

Checker Motors

Engine Index

<i>Engine</i>	<i>Year</i>	<i>Block</i>	<i>Engine</i>	<i>Year</i>	<i>Block</i>
229 CID (3.8L) Chevrolet	1980	1	305 CID (5.0L) Chevrolet	1978-1980	6
230 CID (3.8L) Chevrolet	1964-1968	2	307 CID (5.0L) Chevrolet	1968-1969	7
250 CID (4.1L) Chevrolet	1969-1979	3	318 CID (5.2L) Chrysler	1959-1966	8
267 CID (4.4L) Chevrolet	1980	4	327 CID (5.4L) Chevrolet	1965-1969	9
283 CID (4.6L) Chevrolet	1965-1967	5	350 CID (5.7L) Carbureted Chevrolet	1969-1979	10

Model Index

<i>Model</i>	<i>Engine</i>	<i>Year</i>	<i>Block</i>	<i>Model</i>	<i>Engine</i>	<i>Year</i>	<i>Block</i>
	229 CID (3.8L) Chevrolet	1980	1		307 CID (5.0L) Chevrolet	1968-1969	7
	230 CID (3.8L) Chevrolet	1964-1968	2		318 CID (5.2L) Chrysler	1959-1966	8
	250 CID (4.1L) Chevrolet	1969-1979	3		327 CID (5.4L) Chevrolet	1965-1969	9
	267 CID (4.4L) Chevrolet	1980	4		350 CID (5.7L) Carbureted Chevrolet	1969-1979	10
	283 CID (4.6L) Chevrolet	1965-1967	5				
	305 CID (5.0L) Chevrolet	1978-1980	6				

1 229 CID (3.8L) Chevrolet V6 Cyl, 3.736in./95mm (1980) 1

Part	Year	VIN	Model/Application	Part Number	Qty.
ENGINE GASKETS					
Head Set	1980		(Exhaust Pipe Gasket Not Included, Contains Beaded Steel Cylinder Head Gasket)	HS3564BS	1
			(Exhaust Pipe Gasket Not Included)	HS3564VC	1
Full Set	1980		(Exhaust Pipe Gasket Not Included, Contains Beaded Steel Cylinder Head Gasket)	FS3564BS	1
			(Exhaust Pipe Gasket Not Included)	FS3564VC	1
Cylinder Head Gasket	1980		<i>Beaded Steel</i>	3564BS	2
			<i>VR2000</i>	3564VC	2
			<i>Nitroseal</i>	3925SG	2
Cyl. Head Bolt Set	1980			GS33286	2
Valve Cover Set	1980		<i>Cork Rubber</i>	VS39766	1
			<i>High Temperature Cork Rubber</i>	VS39766H	1
Valve Stem Seal, Exh.	1980		(O-Ring Type)	B45229	6
Valve Stem Seal, Int.	1980		(O-Ring Type)	B45229	6
Manifold Set, Exhaust	1980			MS15251	1
Manifold Set, Intake	1980			MS15224	1
Oil Pan Set	1980		<i>Cork Rubber</i>	OS30934	1
			<i>Tuff-Cork</i>	OS30934TC	1
Rear Main Seal Set	1980		(Lip Relocator Type)	JV1627	1
Timing Cover Set	1980			JV881	1
			<i>Tuff-Cork</i>	JV881TC	1
			(Contains Repair Sleeve)	JV926	1
Timing Cover Gasket	1980			T27781	1
Timing Cover Seal	1980		<i>3/8" Wide</i>	49328	1
			(Lip Relocator Type) <i>1/2" Wide</i>	65022	1
Harmonic Balancer Repair Sleeve	1980		<i>Ground Steel, .020" Thickness</i>	66597RS	1
			Use With Part Number A504 <i>Nickel Plated Formed Steel, .013" Thickness</i>	A228	1

MISCELLANEOUS GASKETS

Air Cleaner Mount Gasket	1980		2 Barrel Carburetor	G26906	1
Carb. Mount Gasket	1980		2 Barrel Carburetor	G26693	1
Dist. Mounting Gasket	1980			B25934	1
E.G.R. Gasket	1980			G17797	1
Exhaust Pipe Gasket	1980		(Ring Type 'C'), Pipe To Manifold	F17250	1
			(Ring Type 'B'), Pipe To Manifold <i>Sintered Metal</i>	F17250S	1
Fuel Pump Gasket	1980		Pump To Plate	D27094	1
			Pump To Plate <i>Tuff-Cork</i>	D27094TC	1
			Plate To Block	D27211	1
Oil Pan Drain Plug Gst.	1980			2051	1
Oil Pump Shaft Retainer	1980			H31354	1
Water Outlet Gasket	1980		(Universal Type)	C24109	1
				C25930	1
Water Pump Mount Gasket	1980			K25935	2

2 230 CID (3.8L) Chevrolet 6 Cyl, 3.875in./98.4mm (1964-1968) 2

Part	Year	VIN	Model/Application	Part Number	Qty.
ENGINE GASKETS					
Head Set	1964-1968			HS1185E	1
Lower Set	1964-1968		(Requires Head Set To Make Full Set)	CS1185	1
Full Set	1964-1968			FS1185E	1
Cylinder Head Gasket	1964-1968		<i>VR2000</i>	3829	1
Valve Cover Set	1964-1968		<i>Cork Rubber</i>	VS39693	1
Valve Stem Seal, Exh.	1964-1968		(O-Ring Type)	B45229	6

Checker Motors

2 (cont.)	230 CID (3.8L) Chevrolet 6 Cyl, 3.875in./98.4mm (1964-1968)				2 (cont.)
---------------------	--	--	--	--	---------------------

Part	Year	VIN	Model/Application	Part Number	Qty.
ENGINE GASKETS (cont.)					
Valve Stem Seal, Int.	1964-1968		(O-Ring Type)	B45229	6
Manifold Gasket	1964-1968		Intake To Exhaust	B7354	1
Manifold Set, Int. & Exh.	1964-1968			MS16033X	1
Oil Pan Set	1964-1968		<i>Cork Rubber</i>	OS30988X	1
Rear Main Seal Set	1968		Except Distributor Boss Stamped F0623 With "R" Under Date, (Lip Relocator Type)	JV1627	1
	1964-1968		Distributor Boss Stamped F0623 With "R" Under Date	JV728	1
Timing Cover Set	1964-1968			JV862	1
			(Contains Repair Sleeve)	JV925	1
Timing Cover Gasket	1964-1968			T14744	1
Timing Cover Seal	1964-1968		<i>3/8" Wide</i>	49328	1
Harmonic Balancer Repair Sleeve	1964-1968		Use With Part Number A504 <i>Nickel Plated Formed Steel, .013" Thickness</i>	A228	1

MISCELLANEOUS GASKETS					
Air Cleaner Mount Gasket	1964-1968		1 Barrel Carburetor	G25936	1
Carb. Mount Gasket	1964-1968		1 Barrel Carburetor	G5349AD	1
Dist. Mounting Gasket	1964-1968			B26466	1
Exhaust Pipe Gasket	1964-1968		(Ring Type 'C'), Pipe To Manifold	F17250	1
			(Ring Type 'B'), Pipe To Manifold <i>Sintered Metal</i>	F17250S	1
Fuel Pump Gasket	1964-1968			D27094	1
			<i>Tuff-Cork</i>	D27094TC	1
Oil Pan Drain Plug Gst.	1964-1968			2051	1
Push Rod Cover Set	1964-1968		<i>Cork Rubber</i>	PS38113	1
Therm. Housing Gasket	1964-1968			C26544	1
Water Outlet Gasket	1964-1968		(Universal Type)	C24109	1
Water Pump Mount Gasket	1964-1968			K26545	1

3	250 CID (4.1L) Chevrolet 6 Cyl, 3.875in./98.4mm (1969-1979)				3
----------	--	--	--	--	----------

Part	Year	VIN	Model/Application	Part Number	Qty.
ENGINE GASKETS					
Head Set	1975-1979		Integral Head And Intake Manifold, (Exhaust Pipe Gasket Not Included)	HS3829	1
	1969-1979		Separate Head And Intake Manifold, (Exhaust Pipe Gasket Not Included)	HS1185E	1
Lower Set	1969-1979		Separate Head And Intake Manifold, (Requires Head Set To Make Full Set)	CS1185	1
Full Set	1975-1979		Integral Head And Intake Manifold, (Exhaust Pipe Gasket Not Included)	FS3829	1
	1969-1979		Separate Head And Intake Manifold, (Exhaust Pipe Gasket Not Included)	FS1185E	1
Cylinder Head Gasket	1969-1979		<i>VR2000</i>	3829	1
Valve Cover Set	1975-1979		Integral Head And Intake Manifold <i>Cork Rubber</i>	VS39755	1
	1969-1979		Separate Head And Intake Manifold <i>Cork Rubber</i>	VS39693	1
Valve Stem Seal, Exh.	1969-1979		(O-Ring Type)	B45229	6
Valve Stem Seal, Int.	1969-1979		(O-Ring Type)	B45229	6
Manifold Gasket	1969-1979		Separate Head And Intake Manifold, Intake To Exhaust	B7354	1
Manifold Set, Exhaust	1975-1979		Integral Head And Intake Manifold	MS15750	1
Manifold Set, Int. & Exh.	1969-1979		Separate Head And Intake Manifold	MS16033X	1
Oil Pan Set	1969-1979		<i>Cork Rubber</i>	OS30988X	1
Rear Main Seal Set	1969-1979		(Lip Relocator Type)	JV1627	1
Timing Cover Set	1969-1979			JV862	1
			(Contains Repair Sleeve)	JV925	1

3 250 CID (4.1L) Chevrolet 6 Cyl, 3.875in./98.4mm (1969-1979) **3**
(cont.) (cont.)

Part Year VIN Model/Application Part Number Qty.

ENGINE GASKETS (cont.)

Timing Cover Gasket	1969-1979			T14744	1
Timing Cover Seal	1969-1979		3/8" Wide	49328	1
			(Lip Relocator Type) 1/2" Wide	65022	1
Harmonic Balancer Repair Sleeve	1969-1979		Ground Steel, .020" Thickness	66597RS	1
			Use With Part Number A504 Nickel Plated Formed Steel, .013" Thickness	A228	1

MISCELLANEOUS GASKETS

Air Cleaner Mount Gasket	1969-1975		2 Barrel Carburetor	G25936	1
Carb. Mount Gasket	1976-1979		2 Barrel Carburetor	G26711	1
Dist. Mounting Gasket	1969-1979			B26466	1
E.G.R. Gasket	1975-1979		Integral Head And Intake Manifold	G17797	1
			Separate Head And Intake Manifold	G26338	1
	1973-1974			G26338	1
Exhaust Pipe Gasket	1969-1979		(Ring Type 'C'), Pipe To Manifold	F17250	1
			(Ring Type 'B'), Pipe To Manifold Sintered Metal	F17250S	1
Fuel Pump Gasket	1969-1979			D27094	1
				Tuff-Cork D27094TC	1
Oil Pan Drain Plug Gsk.	1969-1976			2051	1
Push Rod Cover Set	1969-1979		Cork Rubber	PS38113	1
Therm. Housing Gasket	1969-1979			C26544	1
Water Outlet Gasket	1969-1979		(Universal Type)	C24109	1
				C25930	1
Water Pump Mount Gasket	1969-1979			K26545	1

4 267 CID (4.4L) Chevrolet V8 Cyl, 3.500in./88.9mm (1980) **4**

Part Year VIN Model/Application Part Number Qty.

ENGINE GASKETS

Head Set	1980			HS3514VJ	1
			(Contains Positive Type Valve Stem Seals)	HS3514VK	1
Full Set	1980			FS3514VJ	1
			(Contains Positive Type Valve Stem Seals)	FS3514VK	1
Cylinder Head Gasket	1980		Nitroseal	3514SG	2
			VR2000	3514VC	2
			(Single Sided Graphite) Nitroseal	5745	2
Valve Cover Set	1980		Cork Rubber	VS38110	1
			High Temperature Cork Rubber	VS38110HA	1
			High Temperature Tuff-Cork	VS38110HTC	1
			Victo-Tech	VS38110R	1
			Tuff-Cork	VS38110TC	1
Valve Stem Seal, Exh.	1980		(O-Ring Type)	B45229	8
Valve Stem Seal, Int.	1980		(O-Ring Type)	B45229	8
Manifold Set, Exhaust	1980			MS7110X	1
Manifold Set, Intake	1980			MS15315	1
Oil Pan Set	1980		Right Hand Dip Stick Victo-Tech	OS30568RRH	1
				Cork Rubber OS30568Z	1
				Tuff-Cork OS30572TC	1
Rear Main Seal Set	1980		(Lip Relocator Type)	JV1627	1
Timing Cover Set	1980			JV881	1
			(Contains Repair Sleeve)	JV926	1
Timing Cover Gasket	1980			T27781	1
Timing Cover Seal	1980		3/8" Wide	49328	1
			(Lip Relocator Type) 1/2" Wide	65022	1

Checker Motors

4 (cont.)	267 CID (4.4L) Chevrolet V8 Cyl, 3.500in./88.9mm (1980)				4 (cont.)
--------------	---	--	--	--	--------------

Part	Year	VIN	Model/Application	Part Number	Qty.
------	------	-----	-------------------	-------------	------

ENGINE GASKETS (cont.)

Harmonic Balancer Repair Sleeve	1980		Ground Steel, .020" Thickness	66597RS	1
			Use With Part Number A504 Nickel Plated Formed Steel, .013" Thickness	A228	1

MISCELLANEOUS GASKETS

Air Cleaner Mount Gasket	1980		2 Barrel Carburetor	G26906	1
Carb. Mount Gasket	1980		2 Barrel Carburetor	G26693	1
Dist. Mounting Gasket	1980			B25934	1
E.G.R. Gasket	1980			G17797	1
Fuel Pump Gasket	1980		Plate To Block	D25932	1
			Plate To Block	Tuff-Cork D25932TC	1
			Pump To Plate	D27094	1
			Pump To Plate	Tuff-Cork D27094TC	1
Oil Pan Drain Plug Gst.	1980			2051	1
Oil Pump Shaft Retainer	1980			H31354	6
Water Outlet Gasket	1980		(Universal Type)	C24109	1
				C25930	1
Water Pump Backing Plate	1980			K27091	1
Water Pump Mount Gasket	1980			K25935	2

5	283 CID (4.6L) Chevrolet V8 Cyl, 3.875in./98.4mm (1965-1967)				5
---	--	--	--	--	---

Part	Year	VIN	Model/Application	Part Number	Qty.
------	------	-----	-------------------	-------------	------

ENGINE GASKETS

Head Set	1965-1967		(Exhaust Pipe Gasket Not Included, Contains Beaded Steel Cylinder Head Gasket)	HS1178BJ	1
			(Exhaust Pipe Gasket Not Included)	HS1178VJ	1
Lower Set	1965-1967		(Requires Head Set To Make Full Set)	CS1178	1
Full Set	1965-1967		(Exhaust Pipe Gasket Not Included, Contains Beaded Steel Cylinder Head Gasket)	FS1178BJ	1
			(Exhaust Pipe Gasket Not Included)	FS1178VJ	1
Cylinder Head Gasket	1965-1967		Beaded Steel	1178BS	2
			Nitroseal, 4.160" Combustion Chamber Opening	1178SG	2
			VR2000	1178VC	2
			Nitroseal, 4.100" Combustion Chamber Opening	54052	2
Cyl. Head Bolt Set	1965-1967			GS33285	2
Valve Cover Set	1965-1967		Cork Rubber	VS38110	1
			High Temperature Cork Rubber	VS38110HA	1
			High Temperature Tuff-Cork	VS38110HTC	1
			Victo-Tech	VS38110R	1
			Tuff-Cork	VS38110TC	1
Valve Stem Seal, Exh.	1965-1967		(O-Ring Type)	B45229	8
				B45264	8
			(High Temperature)	B45779	8
Valve Stem Seal, Int.	1965-1967		(O-Ring Type)	B45229	8
Manifold Set, Exhaust	1965-1967			MS7110X	1
Manifold Set, Intake	1965-1967			MS15315	1
Oil Pan Set	1965-1967		Cork Rubber	OS30568X	1
			Tuff-Cork	OS30568XTC	1
Rear Main Seal Set	1965-1967		(Lip Relocator Type)	JV1627	1
Timing Cover Set	1965-1967			JV779	1
			(Contains Repair Sleeve)	JV919	1
Timing Cover Gasket	1965-1967			T27781	1

5 283 CID (4.6L) Chevrolet V8 Cyl, 3.875in./98.4mm (1965-1967) **5**
(cont.) (cont.)

Part	Year	VIN	Model/Application	Part Number	Qty.
ENGINE GASKETS (cont.)					
Timing Cover Seal	1965-1967		3/8" Wide	49328	1
			(Lip Relocator Type) 1/2" Wide	65022	1
Harmonic Balancer Repair Sleeve	1965-1967		Ground Steel, .020" Thickness	66597RS	1
			Use With Part Number A504 Nickel Plated Formed Steel, .013" Thickness	A228	1

MISCELLANEOUS GASKETS

Air Cleaner Mount Gasket	1965-1967		2 Barrel Carburetor	G25936	1
Carb. Mount Gasket	1965-1967		2 Barrel Carburetor	G12216	1
Dist. Mounting Gasket	1965-1967			B25934	1
Exhaust Pipe Gasket	1965-1967		2.5" Pipe, Crossover Pipe	F7139	2
			2" Pipe, (Ring Type 'C'), Crossover Pipe, Pipe To Manifold	F17250	2
			2" Pipe, (Ring Type 'B'), Pipe To Manifold Sintered Metal	F17250S	2
			1.875" Pipe, (Ring Type 'C'), Pipe To Manifold	F17355	1
Fuel Pump Gasket	1965-1967		Plate To Block	D25932	1
			Plate To Block Tuff-Cork	D25932TC	1
			Pump To Plate	D27094	1
			Pump To Plate Tuff-Cork	D27094TC	1
Heat Riser Gasket	1965-1967		3 Bolt 2.125" Inside Diameter	F7135	1
			3 Bolt 2.437" Inside Diameter	F7192	1
Oil Pan Drain Plug Gst.	1965-1967			2051	1
Water Outlet Gasket	1965-1967		(Universal Type)	C24109	1
				C25930	1
Water Pump Backing Plate	1965-1967			K27091	1
Water Pump Mount Gasket	1965-1967			K25935	2

6 305 CID (5.0L) Chevrolet V8 Cyl, 3.736in./95mm (1978-1980) **6**

Part	Year	VIN	Model/Application	Part Number	Qty.
ENGINE GASKETS					
Head Set	1980			HS3514VK	1
	1978-1979			HS3514VJ	1
Lower Set	1978-1980		(Requires Head Set To Make Full Set)	CS1178	1
Full Set	1980			FS3514VK	1
	1978-1979			FS3514VJ	1
Engine Kit Gasket Set	1978-1980			95-3045VR	1
Cylinder Head Gasket	1978-1980		Nitroseal	3514SG	2
			VR2000	3514VC	2
			(Single Sided Graphite) Nitroseal	5745	2
Cyl. Head Bolt Set	1978-1980			GS33285	2
Valve Cover Set	1978-1980		Cork Rubber	VS38110	1
			High Temperature Cork Rubber	VS38110HA	1
			High Temperature Tuff-Cork	VS38110HTC	1
			Victo-Tech	VS38110R	1
			Tuff-Cork	VS38110TC	1
Valve Stem Seal, Exh.	1978-1980		(O-Ring Type)	B45229	8
				B45264	8
			(High Temperature)	B45779	8
Valve Stem Seal, Int.	1978-1980		(O-Ring Type)	B45229	8
Manifold Set, Exhaust	1978-1980			MS7110X	1
Manifold Set, Intake	1978-1980		Liquid Propane Gas	MS15219BF	1
				MS15315	1
Oil Pan Set	1980		Right Hand Dip Stick Victo-Tech	OS30568RRH	1
				Tuff-Cork	OS30572TC

Checker Motors

6 (cont.)	305 CID (5.0L) Chevrolet V8 Cyl, 3.736in./95mm (1978-1980)				6 (cont.)
---------------------	---	--	--	--	---------------------

Part	Year	VIN	Model/Application	Part Number	Qty.
ENGINE GASKETS (cont.)					
Oil Pan Set (cont.)	1978-1980			<i>Cork Rubber</i> OS30568Z	1
	1978-1979		Left Hand Dip Stick	<i>Victo-Tech</i> OS30568RLH	1
					<i>Tuff-Cork</i> OS30568ZTC
Rear Main Seal Set	1978-1980		(Lip Relocator Type)	JV1627	1
Timing Cover Set	1978-1980			JV881	1
			(Contains Repair Sleeve)	JV926	1
Timing Cover Gasket	1978-1980			T27781	1
Timing Cover Seal	1978-1980			<i>3/8" Wide</i> 49328	1
			(Lip Relocator Type)	<i>1/2" Wide</i> 65022	1
Harmonic Balancer Repair Sleeve	1978-1980			<i>Ground Steel, .020" Thickness</i> 66597RS	1
			Use With Part Number A504 <i>Nickel Plated Formed Steel, .013" Thickness</i>	A228	1

MISCELLANEOUS GASKETS					
Air Cleaner Mount Gasket	1979-1980		2 Barrel Carburetor	G26906	1
	1978		2 Barrel Carburetor	G26617	1
Carb. Mount Gasket	1979		2 Barrel Carburetor	G26693	1
	1978		2 Barrel Carburetor	G26711	1
Choke Tube Gasket	1979		2 Barrel Carburetor	B45784	1
	1978		2 Barrel Carburetor, 4 Barrel Carburetor	B45787	1
Dist. Mounting Gasket	1978-1980			B25934	1
E.G.R. Gasket	1980			G26748	2
	1979		2 Bolt In-Line Pattern	G17797	1
	1978			G26748	2
Exhaust Pipe Gasket	1978-1979		(Ring Type 'C'), Pipe To Manifold	F17250	1
			(Ring Type 'B'), Pipe To Manifold	<i>Sintered Metal</i> F17250S	1
Fuel Pump Gasket	1978-1980		Plate To Block	D25932	1
			Plate To Block	<i>Tuff-Cork</i> D25932TC	1
			Pump To Plate	D27094	1
			Pump To Plate	<i>Tuff-Cork</i> D27094TC	1
Oil Pan Drain Plug Gst.	1978-1980			2051	1
Oil Pump Shaft Retainer	1978-1980			H31354	1
Water Outlet Gasket	1978-1980			C25930	1
Water Pump Backing Plate	1978-1980			K27091	1
Water Pump Mount Gasket	1978-1980			K25935	2

7	307 CID (5.0L) Chevrolet V8 Cyl, 3.875in./98.4mm (1968-1969)				7
----------	---	--	--	--	----------

Part	Year	VIN	Model/Application	Part Number	Qty.
ENGINE GASKETS					
Head Set	1968-1969		(Exhaust Pipe Gasket Not Included, Contains Beaded Steel Cylinder Head Gasket)	HS1178BJ	1
			(Exhaust Pipe Gasket Not Included)	HS1178VJ	1
Lower Set	1968-1969		(Requires Head Set To Make Full Set)	CS1178	1
Full Set	1968-1969		(Exhaust Pipe Gasket Not Included, Contains Beaded Steel Cylinder Head Gasket)	FS1178BJ	1
			(Exhaust Pipe Gasket Not Included)	FS1178VJ	1
Engine Kit Gasket Set	1968-1969			95-3033VR	1
Cylinder Head Gasket	1968-1969			<i>Beaded Steel</i> 1178BS	2
			<i>Nitroseal, 4.160" Combustion Chamber Opening</i>	1178SG	2
				<i>VR2000</i> 1178VC	2
			<i>Nitroseal, 4.100" Combustion Chamber Opening</i>	54052	2
Cyl. Head Bolt Set	1968-1969			GS33285	2

7 307 CID (5.0L) Chevrolet V8 Cyl, 3.875in./98.4mm (1968-1969) **7**
 (cont.) (cont.)

Part	Year	VIN	Model/Application	Part Number	Qty.
ENGINE GASKETS (cont.)					
Valve Cover Set	1968-1969		Cork Rubber	VS38110	1
			High Temperature Cork Rubber	VS38110HA	1
			High Temperature Tuff-Cork	VS38110HTC	1
			Victo-Tech	VS38110R	1
			Tuff-Cork	VS38110TC	1
Valve Stem Seal, Exh.	1968-1969		(O-Ring Type)	B45229	8
				B45264	8
			(High Temperature)	B45779	8
Valve Stem Seal, Int.	1968-1969		(O-Ring Type)	B45229	8
Manifold Set, Exhaust	1968-1969			MS7110X	1
Manifold Set, Intake	1968-1969			MS15315	1
Oil Pan Set	1968-1969		Cork Rubber	OS30568X	1
			Tuff-Cork	OS30568XTC	1
Rear Main Seal Set	1968-1969		(Lip Relocator Type)	JV1627	1
Timing Cover Set	1968-1969			JV779	1
			(Contains Repair Sleeve)	JV919	1
Timing Cover Gasket	1968-1969			T27781	1
Timing Cover Seal	1968-1969		3/8" Wide	49328	1
			(Lip Relocator Type) 1/2" Wide	65022	1
Harmonic Balancer Repair Sleeve	1968-1969		Ground Steel, .020" Thickness	66597RS	1
			Use With Part Number A504 Nickel Plated Formed Steel, .013" Thickness	A228	1

MISCELLANEOUS GASKETS

Carb. Mount Gasket	1968-1969		2 Barrel Carburetor	G12216	1
Dist. Mounting Gasket	1968-1969			B25934	1
Exhaust Pipe Gasket	1968-1969		2.5" Pipe, (Ring Type 'C'), Pipe To Manifold	F7139	2
			2.5" Pipe, (Ring Type 'B'), Pipe To Manifold Sintered Metal	F7139S	1
			2" Pipe, (Ring Type 'C'), Pipe To Manifold	F17250	1
			2" Pipe, (Ring Type 'B'), Pipe To Manifold Sintered Metal	F17250S	1
			1.875" Pipe, (Ring Type 'E'), Pipe To Manifold	F17355	1
Fuel Pump Gasket	1968-1969		Plate To Block	D25932	1
			Plate To Block Tuff-Cork	D25932TC	1
			Pump To Plate	D27094	1
			Pump To Plate Tuff-Cork	D27094TC	1
Heat Riser Gasket	1968-1969		3 Bolt 2.125" Inside Diameter	F7135	1
			3 Bolt 2.437" Inside Diameter	F7192	1
Oil Pan Drain Plug Gst.	1968-1969			2051	1
Water Outlet Gasket	1968-1969		(Universal Type)	C24109	1
				C25930	1
Water Pump Backing Plate	1968-1969			K27091	1
Water Pump Mount Gasket	1968-1969			K25935	2

8 318 CID (5.2L) Chrysler V8 Cyl, 3.910in./99.3mm (1959-1966) **8**

Part	Year	VIN	Model/Application	Part Number	Qty.
ENGINE GASKETS					
Head Set	1959-1966			HS1134TC	1
Full Set	1959-1966			FS1134TC	1
Engine Kit Gasket Set	1959-1966		3 Stud Valve Cover	95-3012VR	1
Cylinder Head Gasket	1959-1966		VR2000	1134TC	2
Valve Cover Set	1959-1966		Cork Rubber	VS38282	1
Valve Stem Seal, Exh.	1959-1966			B45298	8
Valve Stem Seal, Int.	1959-1966		(Shedder Type)	B45298	8

Checker Motors

8 (cont.)	318 CID (5.2L) Chrysler V8 Cyl, 3.910in./99.3mm (1959-1966)				8 (cont.)
---------------------	--	--	--	--	---------------------

Part	Year	VIN	Model/Application	Part Number	Qty.
------	------	-----	-------------------	-------------	------

ENGINE GASKETS (cont.)

Valve Stem Seal, Int. (cont.)	1959-1966		(Positive Type) <i>Nitrile</i>	B45403	8
Manifold Gasket, Exh.	1959-1966		(Flange Type), To Valve Body	F5438AK	2
Manifold Set, Exhaust	1962-1966			MS15059	1
	1959-1961			MS15058	1
Manifold Set, Intake	1959-1966			MS15063	1
Oil Pan Set	1959-1966		<i>Cork Rubber</i>	OS30520X	1
Rear Main Seal Set	1959-1966			JV606	1
Timing Cover Set	1959-1966			JV806X	1
Timing Cover Gasket	1959-1966			T27787	1
Timing Cover Seal	1959-1966			64573	1
Harmonic Balancer Repair Sleeve	1959-1966		<i>Ground Steel, .020" Thickness</i>	66592RS	1
			Use With Part Number A501 <i>Nickel Plated Formed Steel, .013" Thickness</i>	A224-1	1

MISCELLANEOUS GASKETS

Air Cleaner Mount Gasket	1960-1966		2 Barrel Carburetor	G25936	1
Carb. Mount Gasket	1965-1966		2 Barrel Carburetor	G12220	1
Dist. Mounting Gasket	1959-1966			B17926	1
Exhaust Pipe Gasket	1959-1966		(Flange Type), Pipe To Manifold	F5438AK	1
Fuel Pump Gasket	1959-1966			D27094	1
			<i>Tuff-Cork</i>	D27094TC	1
Oil Filter Cover Seal	1965-1966			72239	1
Oil Pan Drain Plug Gst.	1959-1966			2051	1
Oil Pump Cover Gasket	1963-1966			B45558	1
Water Outlet Gasket	1959-1966			C25487	1
Water Pump Mount Gasket	1959-1966			K27556	1

9	327 CID (5.4L) Chevrolet V8 Cyl, 4.000in./101.6mm (1965-1969)				9
----------	--	--	--	--	----------

Part	Year	VIN	Model/Application	Part Number	Qty.
------	------	-----	-------------------	-------------	------

ENGINE GASKETS

Head Set	1965-1969		(Exhaust Pipe Gasket Not Included, Contains Beaded Steel Cylinder Head Gasket) <i>Beaded Steel</i>	HS1178BJ	1
			(Exhaust Pipe Gasket Not Included)	HS1178VJ	1
Full Set	1965-1969		(Exhaust Pipe Gasket Not Included, Contains Beaded Steel Cylinder Head Gasket) <i>Beaded Steel</i>	FS1178BJ	1
			(Exhaust Pipe Gasket Not Included)	FS1178VJ	1
Cylinder Head Gasket	1965-1969		<i>Beaded Steel</i>	1178BS	2
			Contoured Combustion Chamber <i>Nitroseal, 4.160" Combustion Chamber Opening</i>	1178SG	2
			<i>VR2000</i>	1178VC	2
			Cylindrical Combustion Chamber <i>Nitroseal</i>	3432SG	2
		Contoured Combustion Chamber <i>Nitroseal, 4.100" Combustion Chamber Opening</i>	54052	2	
Cyl. Head Bolt Set	1965-1969			GS33285	2
Valve Cover Set	1965-1969		<i>Cork Rubber</i>	VS38110	1
			<i>High Temperature Cork Rubber</i>	VS38110HA	1
			<i>High Temperature Tuff-Cork</i>	VS38110HTC	1
			<i>Victo-Tech</i>	VS38110R	1
			<i>Tuff-Cork</i>	VS38110TC	1
Valve Stem Seal, Exh.	1965-1969		(O-Ring Type)	B45229	8
			<i>Nitroseal</i>	B45264	8
			(High Temperature)	B45779	8
Valve Stem Seal, Int.	1965-1969		(O-Ring Type)	B45229	8

9 327 CID (5.4L) Chevrolet V8 Cyl, 4.000in./101.6mm (1965-1969) **9**
 (cont.) (cont.)

Part	Year	VIN	Model/Application	Part Number	Qty.
ENGINE GASKETS (cont.)					
Manifold Set, Exhaust	1965-1969			MS7110X	1
Manifold Set, Intake	1965-1969			MS15315	1
Oil Pan Set	1965-1969		<i>Cork Rubber</i>	OS30568X	1
			<i>Tuff-Cork</i>	OS30568XTC	1
Rear Main Seal Set	1965-1969		(Lip Relocator Type)	JV1627	1
Timing Cover Set	1965-1969			JV779	1
			(Contains Repair Sleeve)	JV919	1
Timing Cover Gasket	1965-1969			T27781	1
Timing Cover Seal	1965-1969		<i>3/8" Wide</i>	49328	1
			(Lip Relocator Type) <i>1/2" Wide</i>	65022	1
Harmonic Balancer Repair Sleeve	1965-1969		<i>Ground Steel, .020" Thickness</i>	66597RS	1
			Use With Part Number A504 <i>Nickel Plated Formed Steel, .013" Thickness</i>	A228	1

MISCELLANEOUS GASKETS

Air Cleaner Mount Gasket	1965-1969		4 Barrel Carburetor	G27098	1
Carb. Mount Gasket	1966-1969		4 Barrel Carburetor, Heat Baffle	G12270	1
			4 Barrel Carburetor	G14579	1
	1965		4 Barrel Carburetor	G14112	1
Dist. Mounting Gasket	1965-1969			B25934	1
Exhaust Pipe Gasket	1965-1969		2.5" Pipe, (Ring Type 'C'), Crossover Pipe, Pipe To Manifold	F7139	2
			2.5" Pipe, (Ring Type 'B'), Pipe To Manifold <i>Sintered Metal</i>	F7139S	2
			2" Pipe, (Ring Type 'C'), Crossover Pipe, Pipe To Manifold	F17250	2
			2" Pipe, (Ring Type 'B'), Pipe To Manifold <i>Sintered Metal</i>	F17250S	2
			1.875" Pipe, (Ring Type 'E'), Pipe To Manifold	F17355	2
Fuel Pump Gasket	1965-1969		Plate To Block	D25932	1
			Plate To Block <i>Tuff-Cork</i>	D25932TC	1
			Pump To Plate	D27094	1
			Pump To Plate <i>Tuff-Cork</i>	D27094TC	1
Heat Riser Gasket	1965-1969		3 Bolt <i>2.125" Inside Diameter</i>	F7135	1
			3 Bolt <i>2.437" Inside Diameter</i>	F7192	1
Water Outlet Gasket	1965-1969		(Universal Type)	C24109	1
				C25930	1
Water Pump Backing Plate	1965-1969			K27091	1
Water Pump Mount Gasket	1965-1969			K25935	2

10 350 CID (5.7L) Carbureted Chevrolet V8 Cyl, 4.000in./101.6mm (1969-1979) **10**

Part	Year	VIN	Model/Application	Part Number	Qty.
ENGINE GASKETS					
Head Set	1969-1974		(Exhaust Pipe Gasket Not Included, Contains Beaded Steel Cylinder Head Gasket)	HS1178BJ	1
			(Exhaust Pipe Gasket Not Included)	HS1178VJ	1
Lower Set	1969-1979		(Requires Head Set To Make Full Set)	CS1178	1
Full Set	1969-1974		(Exhaust Pipe Gasket Not Included, Contains Beaded Steel Cylinder Head Gasket)	FS1178BJ	1
			(Exhaust Pipe Gasket Not Included)	FS1178VJ	1
Cylinder Head Gasket	1969-1979		<i>Beaded Steel</i>	1178BS	2
			Contoured Combustion Chamber <i>Nitroseal, 4.160" Combustion Chamber Opening</i>	1178SG	2
			<i>VR2000</i>	1178VC	2
			Cylindrical Combustion Chamber <i>Nitroseal</i>	3432SG	2
			Contoured Combustion Chamber <i>Nitroseal, 4.100" Combustion Chamber Opening</i>	54052	2
Cyl. Head Bolt Set	1969-1979			GS33285	2

Checker Motors

10 350 CID (5.7L) Carbureted Chevrolet V8 Cyl, 4.000in./101.6mm (1969-1979) **10**
 (cont.) (cont.)

Part	Year	VIN	Model/Application	Part Number	Qty.
ENGINE GASKETS (cont.)					
Valve Cover Set	1969-1979		Cork Rubber	VS38110	1
			High Temperature Cork Rubber	VS38110HA	1
			High Temperature Tuff-Cork	VS38110HTC	1
			Victo-Tech	VS38110R	1
			Tuff-Cork	VS38110TC	1
Valve Stem Seal, Exh.	1969-1979		(O-Ring Type)	B45229	8
			(Shedder Type)	B45264	8
			(Shedder Type, High Temperature)	B45779	8
Valve Stem Seal, Int.	1969-1979		(O-Ring Type)	B45229	8
			(Positive Type) Fluoroelastomer	B45418	8
Manifold Set, Exhaust	1969-1979		Stainless Steel Exhaust Manifold	MS7110SS	1
			Except Stainless Steel Manifold	MS7110X	1
Manifold Set, Intake	1969-1974			MS15315	1
Oil Pan Set	1975-1979		Left Hand Dip Stick Victo-Tech	OS30568RLH	1
			Cork Rubber	OS30568Z	1
			Tuff-Cork	OS30568ZTC	1
	1969-1974		Cork Rubber	OS30568X	1
			Tuff-Cork	OS30568XTC	1
Rear Main Seal Set	1969-1979		(Lip Relocator Type)	JV1627	1
Timing Cover Set	1975-1979			JV881	1
			(Contains Repair Sleeve)	JV926	1
	1969-1974			JV779	1
			(Contains Repair Sleeve)	JV919	1
Timing Cover Seal	1969-1979		3/8" Wide	49328	1
			(Lip Relocator Type) 1/2" Wide	65022	1
Harmonic Balancer Repair Sleeve	1969-1979		Ground Steel, .020" Thickness	66597RS	1
			Use With Part Number A504 Nickel Plated Formed Steel, .013" Oversize	A228	1
MISCELLANEOUS GASKETS					
Air Cleaner Mount Gasket	1969-1978		2 Barrel Carburetor	G26617	1
Carb. Mount Gasket	1974-1977		2 Barrel Carburetor	G26711	1
	1972-1973		2 Barrel Carburetor	G25488	1
	1969-1970		Except Exhaust Emission Control, 2 Barrel Carburetor	G12261	1
Choke Tube Gasket	1976-1979			B45787	1
Dist. Mounting Gasket	1976-1979			B25934	1
E.G.R. Gasket	1973-1974			G26338	1
Exhaust Pipe Gasket	1969-1977		2" Pipe, (Ring Type 'B'), Pipe To Manifold Sintered Metal	F17250S	2
	1969-1976		2" Pipe, (Ring Type 'C'), Pipe To Manifold	F17250	2
	1969-1974		2.5" Pipe, (Ring Type 'C'), Pipe To Manifold	F7139	2
			1.875" Pipe, (Ring Type 'E'), Pipe To Manifold	F17355	1
Fuel Pump Gasket	1969-1979		Plate To Block	D25932	1
			Plate To Block Tuff-Cork	D25932TC	1
			Pump To Plate	D27094	1
			Pump To Plate Tuff-Cork	D27094TC	1
Heat Riser Gasket	1969-1974		3 Bolt 2.125" Inside Diameter	F7135	1
			3 Bolt 2.437" Inside Diameter	F7192	1
Oil Pan Drain Plug Gst.	1969-1979			2051	1
Oil Pump Shaft Retainer	1975-1979			H31354	1
Water Outlet Gasket	1969-1979			C25930	1
Water Pump Backing Plate	1969-1979			K27091	1
Water Pump Mount Gasket	1969-1979			K25935	2

PASSENGER CAR

Engine Index

Engine	Year	Block
86 CID (1.4L) SOHC "J" Mitsubishi	1979-1984	1
92 CID (1.5L) 12 Valve "Q" Mitsubishi	1991-1994	2
92 CID (1.5L) SOHC 8 Valve "Q" Fuel Injected Mitsubishi	1987-1990	3
92 CID (1.5L) SOHC Jet Valve "Q" Carbureted Mitsubishi	1985-1991	4
97 CID (1.6L) OHV Peugeot	1983-1986	5
98 CID (1.6L) SOHC K & Z Mitsubishi	1971-1988	6
98 CID (1.6L) DOHC Mitsubishi	1989-1990	7
105 CID (1.7L) SOHC Volkswagen	1978-1983	8
107 CID (1.8L) 8 Valve (4G37) Mitsubishi	1989-1994	9
112 CID (1.8L) 16 Valve (4G93) Mitsubishi	1992-1994	10
122 CID (2.0L) DOHC	1995-1999	11
122 CID (2.0L) SOHC	1995-2003	12
122 CID (2.0L) 4G63 DOHC Mitsubishi	1989-1994	13
122 CID (2.0L) 4G63T DOHC TURBO Mitsubishi	1990-1994	14
122 CID (2.0L) SOHC "A" Mitsubishi	1984-1991	15
122 CID/1997CC (2.0L) SOHC "U" Mitsubishi	1974-1979	16
135 CID (2.2L) SOHC	1981-1994	17
144 CID (2.4L) 4G64 SOHC 16 Valve Mitsubishi	1993-1994	18
144 CID (2.4L) 4G64 SOHC 8 Valve Mitsubishi	1992	19
148 CID/2429CC (2.4L) DOHC	1995-2003	20
153 CID (2.5L) SOHC	1986-1995	21
153 CID (2.5L) SOHC Flex Fuel	1993-1994	22
2497CC (2.5L) EEB Mitsubishi	1995-2000	23
156 CID (2.6L) SOHC "F" Mitsubishi	1978-1989	24
167 CID/2736CC (2.7L) DOHC	1998-2003	25
167 CID/2736CC (2.7L) DOHC Flex Fuel	2003	26
170 CID (2.8L) OHV	1960-1969	27
181 CID (3.0L) DOHC Mitsubishi	1991-1996	28
181 CID (3.0L) SOHC Mitsubishi	1988-1996	29
181 CID/2972CC (3.0L) EF7 SOHC Mitsubishi	2001-2003	30

Model Index

Model	Engine	Year	Block
5th Avenue	225 CID (3.7L) OHV	1983	38
5th Avenue	318 CID (5.2L)	1983-1989	49
024	105 CID (1.7L) SOHC Volkswagen	1981	8
024	135 CID (2.2L) SOHC	1981	17
300	383 CID (6.3L) OHV	1963-1965	58
300	413 CID (6.8L) OHV	1962-1965	60
300	440 CID (7.2L) OHV	1966-1971	63
300E	413 CID (6.8L) OHV	1959	60
300F	413 CID (6.8L) OHV	1960	60
300G	413 CID (6.8L) OHV	1961	60
300H	413 CID (6.8L) OHV	1962	60
300J	413 CID (6.8L) OHV	1963	60
300K	413 CID (6.8L) OHV	1964	60
300L	413 CID (6.8L) OHV	1965	60
300M	215 CID (3.5L) SOHC	1999-2004	36
330	225 CID (3.7L) OHV	1963-1964	38
330	318 CID (5.2L)	1963-1964	49
330	383 CID (6.3L) OHV	1963-1964	58
330	426 CID (7.0L) Hemispherical	1964	61
330	426 CID (7.0L) Wedge	1963-1964	62
400	135 CID (2.2L) SOHC	1982	17
400	156 CID (2.6L) SOHC "F" Mitsubishi	1982	24
440	225 CID (3.7L) OHV	1963-1964	38
440	318 CID (5.2L)	1963-1964	49
440	383 CID (6.3L) OHV	1963-1964	58
440	426 CID (7.0L) Hemispherical	1964	61
440	426 CID (7.0L) Wedge	1963-1964	62
600	135 CID (2.2L) SOHC	1983-1988	17
600	153 CID (2.5L) SOHC	1986-1988	21

Engine	Year	Block
197 CID (3.2L) EGW SOHC	1998-2001	31
198 CID (3.2L) OHV	1970-1974	32
201 CID (3.3L)	1990-1997	33
201 CID (3.3L) Flex Fuel	1994-1995	34
201 CID (3.3L) L-Head Dodge	1935-1941	35
215 CID (3.5L) SOHC	1993-2003	36
218 CID (3.6L) L-Head	1934-1954	37
225 CID (3.7L) OHV	1960-1983	38
230 CID (3.8L) L-Head	1949-1959	39
230 CID (3.8L)	1991-1993	40
251 CID (4.1L) L-Head	1942-1952	41
265 CID (4.3L) L-Head	1953-1954	42
270 CID (4.4L) OHV	1956	43
273 CID (4.5L) OHV	1964-1969	44
277 CID (4.5L) OHV	1956-1957	45
301 CID (4.9L)	1956-1957	46
303 CID (5.0L) OHV	1956	47
315 CID (5.2L) Hemispherical	1956	48
318 CID (5.2L)	1957-1989	49
325 CID (5.3L) Hemispherical	1957	50
326 CID (5.3L) OHV	1959	51
340 CID (5.6L) OHV	1968-1973	52
350 CID (5.7L) OHV	1958	53
360 CID (5.9L)	1971-1980	54
360 CID (5.9L) LPG	1971-1980	55
361 CID (5.9L) OHV	1957-1966	56
383 CID (6.3L) LPG	1963-1971	57
383 CID (6.3L) OHV	1959-1971	58
400 CID (6.6L) OHV	1972-1978	59
413 CID (6.8L) OHV	1959-1965	60
426 CID (7.0L) Hemispherical	1964-1971	61
426 CID (7.0L) Wedge	1963-1965	62
440 CID (7.2L) OHV	1966-1978	63

Model	Engine	Year	Block
600	156 CID (2.6L) SOHC "F" Mitsubishi	1983-1985	24
800	426 CID (7.0L) Hemispherical	1964	61
800	426 CID (7.0L) Wedge	1964	62
880	361 CID (5.9L) OHV	1962-1964	56
880	383 CID (6.3L) OHV	1962-1965	58
880	413 CID (6.8L) OHV	1965	60
880	426 CID (7.0L) Hemispherical	1964	61
880	426 CID (7.0L) Wedge	1964-1965	62
2000 GTX	122 CID (2.0L) 4G63 DOHC Mitsubishi	1989-1990	13
2000 GTX	122 CID (2.0L) SOHC "A" Mitsubishi	1989-1990	15
	360 CID (5.9L)	1971-1980	55
	383 CID (6.3L)	1959-1971	57
Acclaim	153 CID (2.5L) SOHC	1993-1994	22
Acclaim	153 CID (2.5L) SOHC	1989-1995	21
Acclaim	181 CID (3.0L) SOHC Mitsubishi	1989-1995	29
Adventurer	383 CID (6.3L) OHV	1959	58
Aries	135 CID (2.2L) SOHC	1981-1989	17
Aries	153 CID (2.5L) SOHC	1986-1989	21
Aries	156 CID (2.6L) SOHC "F" Mitsubishi	1981-1985	24
Arrow	98 CID (1.6L) SOHC K & Z Mitsubishi	1977-1980	6
Arrow	122 CID/1997CC (2.0L) SOHC "U" Mitsubishi	1976-1979	16
Arrow	156 CID (2.6L) SOHC "F" Mitsubishi	1979-1980	24
Aspen	225 CID (3.7L) OHV	1976-1980	38

Chrysler

Model Index (cont.)

Model	Engine	Year	Block	Model	Engine	Year	Block
Aspen	318 CID (5.2L)	1976-1978	49	Challenger	198 CID (3.2L) OHV	1970-1971	32
Aspen	360 CID (5.9L)	1976-1980	54	Challenger	225 CID (3.7L) OHV	1970-1971	38
Avenger	122 CID (2.0L) DOHC	1995-1999	11	Challenger	318 CID (5.2L)	1970-1971	49
Avenger	2497CC (2.5L) EEB Mitsubishi	1995-2000	23	Challenger	340 CID (5.6L) OHV	1968-1973	52
Barracuda	225 CID (3.7L) OHV	1967-1972	38	Challenger	360 CID (5.9L)	1974	54
Barracuda	273 CID (4.5L) OHV	1967	44	Challenger	383 CID (6.3L) OHV	1970-1971	58
Barracuda	318 CID (5.2L)	1968-1974	49	Challenger	426 CID (7.0L) Hemispherical	1970-1971	61
Barracuda	340 CID (5.6L) OHV	1968-1973	52	Challenger	440 CID (7.2L) OHV	1970-1971	63
Barracuda	360 CID (5.9L)	1974	54	Champ	86 CID (1.4L) SOHC "J"	1979-1982	1
Barracuda	383 CID (6.3L) OHV	1967-1971	58	Mitsubishi			
Barracuda	426 CID (7.0L) Hemispherical	1970-1971	61	Champ	98 CID (1.6L) SOHC K & Z	1979-1982	6
Barracuda	440 CID (7.2L) OHV	1970-1971	63	Mitsubishi			
Beauty Winner	218 CID (3.6L) L-Head	1936	37	Charger	97 CID (1.6L) OHV Peugeot	1983-1986	5
Belvedere	218 CID (3.6L) L-Head	1954	37	Charger	105 CID (1.7L) SOHC	1983	8
Belvedere	225 CID (3.7L) OHV	1960-1969	38	Volkswagen			
Belvedere	230 CID (3.8L) L-Head	1954-1958	39	Charger	135 CID (2.2L) SOHC	1983-1987	17
Belvedere	270 CID (4.4L) OHV	1956	43	Charger	225 CID (3.7L) OHV	1969-1974	38
Belvedere	273 CID (4.5L) OHV	1967	44	Charger	273 CID (4.5L) OHV	1966	44
Belvedere	277 CID (4.5L) OHV	1956-1957	45	Charger	318 CID (5.2L)	1966-1974	49
Belvedere	301 CID (4.9L)	1956-1957	46	Charger	340 CID (5.6L) OHV	1972-1973	52
Belvedere	303 CID (5.0L) OHV	1956	47	Charger	360 CID (5.9L)	1974	54
Belvedere	318 CID (5.2L)	1957-1969	49	Charger	361 CID (5.9L) OHV	1966	56
Belvedere	350 CID (5.7L) OHV	1958	53	Charger	383 CID (6.3L) OHV	1966-1971	58
Belvedere	361 CID (5.9L) OHV	1959-1964	56	Charger	400 CID (6.6L) OHV	1972-1973	59
Belvedere	383 CID (6.3L) OHV	1960-1969	58	Charger	426 CID (7.0L) Hemispherical	1966-1971	61
Belvedere	413 CID (6.8L) OHV	1961	60	Charger	440 CID (7.2L) OHV	1968-1971	63
Belvedere	426 CID (7.0L) Hemispherical	1964	61	Cirrus	148 CID/2429CC (2.4L) DOHC	1995-1997	20
Belvedere	426 CID (7.0L) Wedge	1963-1964	62	Cirrus	2497CC (2.5L) EEB Mitsubishi	1995-2000	23
Belvedere	440 CID (7.2L) OHV	1969	63	Colt	86 CID (1.4L) SOHC "J"	1979-1984	1
Belvedere I	225 CID (3.7L) OHV	1965-1967	38	Mitsubishi			
Belvedere I	273 CID (4.5L) OHV	1965-1967	44	Colt	92 CID (1.5L) 12 Valve "Q"	1991-1994	2
Belvedere I	318 CID (5.2L)	1965	49	Mitsubishi			
Belvedere I	361 CID (5.9L) OHV	1965	56	Colt	92 CID (1.5L) SOHC 8 Valve	1987-1990	3
Belvedere I	383 CID (6.3L) OHV	1965-1967	58	"Q" Fuel Injected Mitsubishi			
Belvedere I	426 CID (7.0L) Hemispherical	1965	61	Colt	92 CID (1.5L) SOHC Jet Valve	1985-1990	4
Belvedere I	426 CID (7.0L) Wedge	1965	62	"Q" Carbureted Mitsubishi			
Belvedere II	225 CID (3.7L) OHV	1965	38	Colt	98 CID (1.6L) DOHC	1989-1990	7
Belvedere II	273 CID (4.5L) OHV	1965	44	Mitsubishi			
Belvedere II	318 CID (5.2L)	1965	49	Colt	98 CID (1.6L) SOHC K & Z	1971-1988	6
Belvedere II	361 CID (5.9L) OHV	1965	56	Mitsubishi			
Belvedere II	383 CID (6.3L) OHV	1965	58	Colt	107 CID (1.8L) 8 Valve (4G37)	1989-1990	9
Belvedere II	426 CID (7.0L) Hemispherical	1965	61	Mitsubishi			
Belvedere II	426 CID (7.0L) Wedge	1965	62	Colt	112 CID (1.8L) 16 Valve	1993-1994	10
Belvedere	273 CID (4.5L) OHV	1965	44	(4G93) Mitsubishi			
Satellite				Colt	122 CID/1997CC (2.0L) SOHC	1974-1981	16
Belvedere Satellite	318 CID (5.2L)	1965	49	"U" Mitsubishi			
Belvedere Satellite	361 CID (5.9L) OHV	1965	56	Colt	156 CID (2.6L) SOHC "F"	1978-1980	24
Belvedere Satellite	383 CID (6.3L) OHV	1965	58	Mitsubishi			
Belvedere Satellite	426 CID (7.0L) Hemispherical	1966	61	Colt 100	92 CID (1.5L) 12 Valve "Q"	1992	2
Belvedere Satellite	426 CID (7.0L) Wedge	1965	62	Mitsubishi			
Breeze	122 CID (2.0L) SOHC	1996-2000	12	Colt 100	92 CID (1.5L) SOHC Jet Valve	1989-1991	4
Breeze	148 CID/2429CC (2.4L) DOHC	1996-2000	20	"Q" Carbureted Mitsubishi			
Brougham	360 CID (5.9L)	1977	54	Colt 200	92 CID (1.5L) 12 Valve "Q"	1991-1992	2
Brougham	400 CID (6.6L) OHV	1977	59	Mitsubishi			
Business	201 CID (3.3L) L-Head Dodge	1935-1937	35	Colt 200	92 CID (1.5L) SOHC 8 Valve	1989-1990	3
Cambridge	218 CID (3.6L) L-Head	1951-1953	37	"Q" Fuel Injected Mitsubishi			
Caravelle	135 CID (2.2L) SOHC	1983-1988	17	Colt 200	98 CID (1.6L) DOHC	1989-1990	7
Caravelle	153 CID (2.5L) SOHC	1986-1988	21	Mitsubishi			
Caravelle	156 CID (2.6L) SOHC "F"	1983-1985	24	Colt Premier	92 CID (1.5L) SOHC Jet Valve	1985-1988	4
Mitsubishi				"Q" Carbureted Mitsubishi			
Caravelle	318 CID (5.2L)	1978-1984	49	Colt Vista	112 CID (1.8L) 16 Valve	1992	10
Caravelle	360 CID (5.9L)	1978-1979	54	(4G93) Mitsubishi			
Challenger	98 CID (1.6L) SOHC K & Z	1978-1979	6	Colt Vista	122 CID (2.0L) SOHC "A"	1984-1991	15
Mitsubishi				Mitsubishi			
Challenger	156 CID (2.6L) SOHC "F"	1978-1983	24	Colt Vista	144 CID (2.4L) 4G64 SOHC	1993-1994	18
Mitsubishi				16 Valve Mitsubishi			
Challenger	156 CID (2.6L) SOHC "F"	1978-1983	24	Colt Vista	144 CID (2.4L) 4G64 SOHC 8	1992	19
Mitsubishi				Valve Mitsubishi			
Challenger	156 CID (2.6L) SOHC "F"	1978-1983	24	Concord	218 CID (3.6L) L-Head	1951-1952	37
Mitsubishi				Concorde	167 CID/2736CC (2.7L) DOHC	1998-2004	25
Challenger	156 CID (2.6L) SOHC "F"	1978-1983	24	Concorde	197 CID (3.2L) EGW SOHC	1998-2001	31
Mitsubishi				Concorde	201 CID (3.3L)	1994-1995	34

Model Index (cont.)

Model	Engine	Year	Block	Model	Engine	Year	Block
Concorde	201 CID (3.3L)	1993-1996	33	Dynasty	181 CID (3.0L) SOHC	1988-1993	29
Concorde	215 CID (3.5L) SOHC	1993-2004	36		Mitsubishi		
Conquest	156 CID (2.6L) SOHC "F"	1984-1989	24	Dynasty	201 CID (3.3L)	1990-1993	33
	Mitsubishi			E-Class	135 CID (2.2L) SOHC	1983-1984	17
Cordoba	225 CID (3.7L) OHV	1980-1983	38	E-Class	156 CID (2.6L) SOHC "F"	1983-1984	24
Cordoba	318 CID (5.2L)	1975-1983	49		Mitsubishi		
Cordoba	360 CID (5.9L)	1976-1979	54	Executive	135 CID (2.2L) SOHC	1986	17
Cordoba	400 CID (6.6L) OHV	1975-1978	59	Limousine			
Coronet	225 CID (3.7L) OHV	1965-1973	38	Executive	156 CID (2.6L) SOHC "F"	1983-1985	24
Coronet	230 CID (3.8L) L-Head	1949-1959	39	Limousine	Mitsubishi		
Coronet	270 CID (4.4L) OHV	1955-1956	43	Executive	156 CID (2.6L) SOHC "F"	1983-1984	24
Coronet	273 CID (4.5L) OHV	1965-1968	44	Sedan	Mitsubishi		
Coronet	315 CID (5.2L) Hemispherical	1956	48	Expo	135 CID (2.2L) SOHC	1987-1988	17
Coronet	318 CID (5.2L)	1965-1976	49	Fire dome	361 CID (5.9L) OHV	1958	56
Coronet	325 CID (5.3L) Hemispherical	1957-1958	50	Fire dome	383 CID (6.3L) OHV	1959	58
Coronet	326 CID (5.3L) OHV	1959	51	Fireflite	361 CID (5.9L) OHV	1958	56
Coronet	340 CID (5.6L) OHV	1973	52	Fireflite	383 CID (6.3L) OHV	1959	58
Coronet	360 CID (5.9L)	1974-1976	54	Firesweep	325 CID (5.3L) Hemispherical	1957	50
Coronet	361 CID (5.9L) OHV	1965	56	Firesweep	350 CID (5.7L) OHV	1958	53
Coronet	383 CID (6.3L) OHV	1959-1970	58	Firesweep	361 CID (5.9L) OHV	1959	56
Coronet	400 CID (6.6L) OHV	1972-1976	59	Fury	225 CID (3.7L) OHV	1960-1978	38
Coronet	413 CID (6.8L) OHV	1965	60	Fury	318 CID (5.2L)	1959-1978	49
Coronet	426 CID (7.0L) Hemispherical	1965-1969	61	Fury	360 CID (5.9L)	1975-1978	54
Coronet	426 CID (7.0L) Wedge	1965	62	Fury	361 CID (5.9L) OHV	1959	56
Coronet	440 CID (7.2L) OHV	1967-1976	63	Fury	383 CID (6.3L) OHV	1960-1961	58
Cranbrook	218 CID (3.6L) L-Head	1951-1953	37	Fury	400 CID (6.6L) OHV	1975-1978	59
Crown	413 CID (6.8L) OHV	1959-1965	60	Fury	413 CID (6.8L) OHV	1961	60
Crown	440 CID (7.2L) OHV	1966-1970	63	Fury	426 CID (7.0L) Hemispherical	1964	61
Crown	413 CID (6.8L) OHV	1958-1961	60	Fury	426 CID (7.0L) Wedge	1963	62
Imperial				Fury	440 CID (7.2L) OHV	1975-1978	63
Custom	218 CID (3.6L) L-Head	1941-1942	37	Fury Custom	225 CID (3.7L) OHV	1971	38
Custom	251 CID (4.1L) L-Head	1951-1952	41	Fury Custom	318 CID (5.2L)	1971	49
Custom	413 CID (6.8L) OHV	1959-1963	60	Fury Custom	340 CID (5.6L) OHV	1971	52
Custom	315 CID (5.2L) Hemispherical	1956	48	Fury Custom	360 CID (5.9L)	1971	54
Royal				Fury Custom	383 CID (6.3L) OHV	1971	58
Custom	325 CID (5.3L) Hemispherical	1957	50	Fury Custom	440 CID (7.2L) OHV	1971	63
Royal				Fury Grand	318 CID (5.2L)	1970	49
Custom	361 CID (5.9L) OHV	1958	56	Coupe			
Royal				Fury Grand	360 CID (5.9L)	1972	54
D3 Series	218 CID (3.6L) L-Head	1936	37	Coupe			
D4 Series	218 CID (3.6L) L-Head	1936	37	Fury Grand	383 CID (6.3L) OHV	1970	58
D5 Series	218 CID (3.6L) L-Head	1937	37	Coupe			
D8 Series	218 CID (3.6L) L-Head	1938	37	Fury Grand	400 CID (6.6L) OHV	1972	59
DU Series	218 CID (3.6L) L-Head	1935	37	Coupe			
Dart	170 CID (2.8L) OHV	1963-1969	27	Fury Grand	440 CID (7.2L) OHV	1970	63
Dart	198 CID (3.2L) OHV	1970-1974	32	Coupe			
Dart	225 CID (3.7L) OHV	1960-1976	38	Fury Grand	318 CID (5.2L)	1972	49
Dart	273 CID (4.5L) OHV	1964-1969	44	Sedan			
Dart	318 CID (5.2L)	1960-1976	49	Fury Grand	360 CID (5.9L)	1972	54
Dart	340 CID (5.6L) OHV	1968-1972	52	Sedan			
Dart	360 CID (5.9L)	1974	54	Fury Grand	400 CID (6.6L) OHV	1972	59
Dart	361 CID (5.9L) OHV	1961	56	Sedan			
Dart	383 CID (6.3L) OHV	1960	58	Fury I	225 CID (3.7L) OHV	1965-1971	38
Dart	413 CID (6.8L) OHV	1961	60	Fury I	273 CID (4.5L) OHV	1967	44
Daytona	135 CID (2.2L) SOHC	1984-1990	17	Fury I	318 CID (5.2L)	1965-1973	49
Daytona	153 CID (2.5L) SOHC	1986-1993	21	Fury I	340 CID (5.6L) OHV	1971	52
Daytona	181 CID (3.0L) SOHC	1990-1993	29	Fury I	360 CID (5.9L)	1971-1974	54
	Mitsubishi			Fury I	361 CID (5.9L) OHV	1965	56
DeSoto	361 CID (5.9L) OHV	1961	56	Fury I	383 CID (6.3L) OHV	1965-1971	58
Deluxe	201 CID (3.3L) L-Head Dodge	1935-1941	35	Fury I	400 CID (6.6L) OHV	1972-1973	59
Deluxe	218 CID (3.6L) L-Head	1934-1950	37	Fury I	426 CID (7.0L) Wedge	1965	62
Deluxe	251 CID (4.1L) L-Head	1951-1952	41	Fury I	440 CID (7.2L) OHV	1966-1974	63
Diplomat	225 CID (3.7L) OHV	1978-1982	38	Fury II	225 CID (3.7L) OHV	1965-1971	38
Diplomat	318 CID (5.2L)	1977-1989	49	Fury II	318 CID (5.2L)	1965-1971	49
Diplomat	360 CID (5.9L)	1978-1979	54	Fury II	340 CID (5.6L) OHV	1971	52
Duster	198 CID (3.2L) OHV	1970-1973	32	Fury II	360 CID (5.9L)	1971	54
Duster	225 CID (3.7L) OHV	1970-1976	38	Fury II	361 CID (5.9L) OHV	1965	56
Duster	318 CID (5.2L)	1970-1976	49	Fury II	383 CID (6.3L) OHV	1965-1971	58
Duster	340 CID (5.6L) OHV	1970-1973	52	Fury II	400 CID (6.6L) OHV	1972	59
Duster	360 CID (5.9L)	1974-1976	54	Fury II	426 CID (7.0L) Wedge	1965	62
Dynasty	153 CID (2.5L) SOHC	1988-1993	21	Fury II	440 CID (7.2L) OHV	1966-1969	63

Chrysler

Model Index (cont.)

Model	Engine	Year	Block	Model	Engine	Year	Block
Fury III	225 CID (3.7L) OHV	1965-1969	38	Neon	122 CID (2.0L) SOHC	1995-2004	12
Fury III	318 CID (5.2L)	1965-1973	49	New Yorker	135 CID (2.2L) SOHC	1983-1988	17
Fury III	340 CID (5.6L) OHV	1971	52	New Yorker	153 CID (2.5L) SOHC	1986-1987	21
Fury III	360 CID (5.9L)	1971-1974	54	New Yorker	156 CID (2.6L) SOHC "F"	1983-1985	24
Fury III	361 CID (5.9L) OHV	1965	56		Mitsubishi		
Fury III	383 CID (6.3L) OHV	1965-1969	58	New Yorker	181 CID (3.0L) SOHC	1988-1990	29
Fury III	400 CID (6.6L) OHV	1972-1973	59		Mitsubishi		
Fury III	426 CID (7.0L) Wedge	1965	62	New Yorker	201 CID (3.3L)	1990-1993	33
Fury III	440 CID (7.2L) OHV	1966-1974	63	New Yorker	215 CID (3.5L) SOHC	1994-1996	36
GTX	426 CID (7.0L) Hemispherical	1968-1969	61	New Yorker	225 CID (3.7L) OHV	1982	38
GTX	440 CID (7.2L) OHV	1967-1969	63	New Yorker	230 CID (3.8L)	1991-1993	40
Gran Fury	225 CID (3.7L) OHV	1980-1982	38	New Yorker	318 CID (5.2L)	1979-1982	49
Gran Fury	318 CID (5.2L)	1973-1989	49	New Yorker	360 CID (5.9L)	1977-1980	54
Gran Fury	360 CID (5.9L)	1973-1976	54	New Yorker	400 CID (6.6L) OHV	1975-1978	59
Gran Fury	400 CID (6.6L) OHV	1973-1978	59	New Yorker	413 CID (6.8L) OHV	1959-1965	60
Gran Fury	440 CID (7.2L) OHV	1973-1977	63	New Yorker	440 CID (7.2L) OHV	1966-1978	63
Horizon	97 CID (1.6L) OHV Peugeot	1983-1986	5	Newport	225 CID (3.7L) OHV	1979	38
Horizon	105 CID (1.7L) SOHC	1978-1982	8	Newport	318 CID (5.2L)	1979-1980	49
	Volkswagen			Newport	360 CID (5.9L)	1971-1980	54
Horizon	135 CID (2.2L) SOHC	1981-1990	17	Newport	361 CID (5.9L) OHV	1961-1964	56
Imperial	201 CID (3.3L)	1990-1991	33	Newport	383 CID (6.3L) OHV	1965-1971	58
Imperial	230 CID (3.8L)	1991-1993	40	Newport	400 CID (6.6L) OHV	1972-1978	59
Imperial	318 CID (5.2L)	1981-1982	49	Newport	440 CID (7.2L) OHV	1966-1978	63
Imperial	440 CID (7.2L) OHV	1967	63	Omni	97 CID (1.6L) OHV Peugeot	1983-1986	5
Intrepid	167 CID/2736CC (2.7L) DOHC	1998-2004	25	Omni	105 CID (1.7L) SOHC	1978-1982	8
Intrepid	197 CID (3.2L) EGW SOHC	1998-2001	31		Volkswagen		
Intrepid	201 CID (3.3L)	1994-1995	34	Omni	135 CID (2.2L) SOHC	1981-1990	17
Intrepid	201 CID (3.3L)	1993-1997	33	Plaza	218 CID (3.6L) L-Head	1954	37
Intrepid	215 CID (3.5L) SOHC	1993-2004	36	Plaza	230 CID (3.8L) L-Head	1954-1958	39
KINGSWAY	218 CID (3.6L) L-Head	1940-1942	37	Plaza	270 CID (4.4L) OHV	1956	43
LHS	215 CID (3.5L) SOHC	1994-2001	36	Plaza	277 CID (4.5L) OHV	1956-1957	45
Lancer	135 CID (2.2L) SOHC	1985-1989	17	Plaza	301 CID (4.9L)	1957	46
Lancer	153 CID (2.5L) SOHC	1986-1989	21	Plaza	318 CID (5.2L)	1958	49
Lancer	170 CID (2.8L) OHV	1961-1962	27	Polara	225 CID (3.7L) OHV	1963-1964	38
Lancer	225 CID (3.7L) OHV	1961-1962	38	Polara	318 CID (5.2L)	1963-1973	49
Laser	107 CID (1.8L) 8 Valve (4G37)	1989-1994	9	Polara	360 CID (5.9L)	1971-1973	54
	Mitsubishi			Polara	361 CID (5.9L) OHV	1961	56
Laser	122 CID (2.0L) 4G63T DOHC	1990-1994	14	Polara	383 CID (6.3L) OHV	1960-1971	58
	TURBO Mitsubishi			Polara	400 CID (6.6L) OHV	1972-1973	59
Laser	122 CID (2.0L) 4G63 DOHC	1990-1994	13	Polara	413 CID (6.8L) OHV	1962	60
	Mitsubishi			Polara	426 CID (7.0L) Hemispherical	1964	61
Laser	135 CID (2.2L) SOHC	1984-1986	17	Polara	426 CID (7.0L) Wedge	1963-1964	62
Laser	153 CID (2.5L) SOHC	1986	21	Polara	440 CID (7.2L) OHV	1966-1972	63
Lebaron	135 CID (2.2L) SOHC	1982-1990	17	Prowler	215 CID (3.5L) SOHC	1997-2002	36
Lebaron	153 CID (2.5L) SOHC	1986-1995	21	Reliant	135 CID (2.2L) SOHC	1981-1988	17
Lebaron	156 CID (2.6L) SOHC "F"	1982-1985	24	Reliant	153 CID (2.5L) SOHC	1986-1988	21
	Mitsubishi			Reliant	156 CID (2.6L) SOHC "F"	1981-1985	24
Lebaron	181 CID (3.0L) SOHC	1990-1995	29		Mitsubishi		
	Mitsubishi			Road Runner	318 CID (5.2L)	1972-1975	49
Lebaron	225 CID (3.7L) OHV	1978-1980	38	Road Runner	340 CID (5.6L) OHV	1971-1973	52
Lebaron	318 CID (5.2L)	1977-1981	49	Road Runner	360 CID (5.9L)	1974-1975	54
Lebaron	360 CID (5.9L)	1978-1979	54	Road Runner	383 CID (6.3L) OHV	1968-1971	58
Lebaron	413 CID (6.8L) OHV	1959-1963	60	Road Runner	400 CID (6.6L) OHV	1972-1975	59
Lebaron	440 CID (7.2L) OHV	1966-1975	63	Road Runner	426 CID (7.0L) Hemispherical	1968-1971	61
Magnum	318 CID (5.2L)	1978	49	Road Runner	440 CID (7.2L) OHV	1970-1974	63
Magnum	360 CID (5.9L)	1978	54	Roadking	201 CID (3.3L) L-Head Dodge	1938-1940	35
Magnum	400 CID (6.6L) OHV	1978	59	Royal	251 CID (4.1L) L-Head	1942-1948	41
Matador	361 CID (5.9L) OHV	1960	56	Royal	270 CID (4.4L) OHV	1955-1956	43
Matador	383 CID (6.3L) OHV	1960	58	Royal	315 CID (5.2L) Hemispherical	1956	48
Meadowbrook	230 CID (3.8L) L-Head	1949-1954	39	Royal	325 CID (5.3L) Hemispherical	1957-1958	50
Mirada	225 CID (3.7L) OHV	1980-1982	38	Royal	350 CID (5.7L) OHV	1958	53
Mirada	318 CID (5.2L)	1980-1982	49	Royal	361 CID (5.9L) OHV	1958	56
Mirada	360 CID (5.9L)	1980	54	Royal	383 CID (6.3L) OHV	1958-1959	58
Monaco	225 CID (3.7L) OHV	1977-1978	38	Royal	318 CID (5.2L)	1975	49
Monaco	318 CID (5.2L)	1975-1978	49	Monaco			
Monaco	360 CID (5.9L)	1972-1978	54	Royal	360 CID (5.9L)	1975-1977	54
Monaco	383 CID (6.3L) OHV	1965-1971	58	Monaco			
Monaco	400 CID (6.6L) OHV	1972-1978	59	Royal	400 CID (6.6L) OHV	1975-1976	59
Monaco	413 CID (6.8L) OHV	1965	60	Monaco			
Monaco	426 CID (7.0L) Wedge	1965	62	Royal	440 CID (7.2L) OHV	1975-1978	63
Monaco	440 CID (7.2L) OHV	1966-1978	63	Monaco			
Neon	122 CID (2.0L) DOHC	1995-1999	11	SX 2.0	122 CID (2.0L) SOHC	2003-2004	12

Model Index (cont.)

Model	Engine	Year	Block	Model	Engine	Year	Block
Sapporo	98 CID (1.6L) SOHC K & Z Mitsubishi	1978-1979	6	Sport Fury GT	383 CID (6.3L) OHV	1971	58
Sapporo	156 CID (2.6L) SOHC "F" Mitsubishi	1978-1983	24	Sport Fury GT	440 CID (7.2L) OHV	1970-1971	63
Satellite	225 CID (3.7L) OHV	1968-1974	38	Sport	318 CID (5.2L)	1968-1969	49
Satellite	273 CID (4.5L) OHV	1967	44	Satellite	383 CID (6.3L) OHV	1968-1969	58
Satellite	318 CID (5.2L)	1967-1974	49	Sport	440 CID (7.2L) OHV	1969	63
Satellite	340 CID (5.6L) OHV	1973	52	Satellite	225 CID (3.7L) OHV	1979	38
Satellite	360 CID (5.9L)	1974	54	St. Regis	318 CID (5.2L)	1979	49
Satellite	383 CID (6.3L) OHV	1967-1969	58	St. Regis	360 CID (5.9L)	1979	54
Satellite	400 CID (6.6L) OHV	1972-1974	59	Station Wagon	350 CID (5.7L) OHV	1958	53
Satellite	426 CID (7.0L) Hemispherical	1967	61	Station Wagon	361 CID (5.9L) OHV	1958	56
Satellite	440 CID (7.2L) OHV	1969	63	Stealth	181 CID (3.0L) DOHC Mitsubishi	1991-1996	28
Satellite GTX	426 CID (7.0L) Hemispherical	1970	61	Stealth	181 CID (3.0L) SOHC Mitsubishi	1991-1996	29
Satellite GTX	440 CID (7.2L) OHV	1970	63	Stratus	122 CID (2.0L) SOHC	1995-1999	12
Satellite	318 CID (5.2L)	1968	49	Stratus	148 CID/2429CC (2.4L) DOHC	1995-2004	20
Sport Wagon				Stratus	167 CID/2736CC (2.7L) DOHC	2003-2004	26
Satellite	383 CID (6.3L) OHV	1968	58	Stratus	167 CID/2736CC (2.7L) DOHC	2001-2004	25
Sport Wagon				Stratus	181 CID/2972CC (3.0L) EF7 SOHC Mitsubishi	2001-2004	30
Savoy	218 CID (3.6L) L-Head	1954	37	Stratus	2497CC (2.5L) EEB Mitsubishi	1995-2000	23
Savoy	225 CID (3.7L) OHV	1960-1964	38	Suburbans	318 CID (5.2L)	1972	49
Savoy	230 CID (3.8L) L-Head	1954-1958	39	Suburbans	360 CID (5.9L)	1972-1974	54
Savoy	270 CID (4.4L) OHV	1956	43	Suburbans	400 CID (6.6L) OHV	1972-1973	59
Savoy	277 CID (4.5L) OHV	1956-1957	45	Suburbans	440 CID (7.2L) OHV	1973-1974	63
Savoy	301 CID (4.9L)	1957	46	Sundance	135 CID (2.2L) SOHC	1987-1994	17
Savoy	318 CID (5.2L)	1958-1964	49	Sundance	153 CID (2.5L) SOHC	1988-1995	21
Savoy	361 CID (5.9L) OHV	1959-1964	56	Sundance	181 CID (3.0L) SOHC Mitsubishi	1992-1994	29
Savoy	383 CID (6.3L) OHV	1960-1964	58	TC3	105 CID (1.7L) SOHC Volkswagen	1981-1982	8
Savoy	413 CID (6.8L) OHV	1961	60	TC3	135 CID (2.2L) SOHC	1981	17
Savoy	426 CID (7.0L) Hemispherical	1964	61	TC	181 CID (3.0L) SOHC Mitsubishi	1990-1991	29
Savoy	426 CID (7.0L) Wedge	1964	62	Turismo	97 CID (1.6L) OHV Peugeot	1983-1986	5
Scamp	198 CID (3.2L) OHV	1971-1973	32	Turismo	105 CID (1.7L) SOHC Volkswagen	1983	8
Scamp	225 CID (3.7L) OHV	1971-1973	38	Turismo	135 CID (2.2L) SOHC	1983-1987	17
Scamp	318 CID (5.2L)	1971-1976	49	VIP	318 CID (5.2L)	1966-1969	49
Scamp	360 CID (5.9L)	1975	54	VIP	361 CID (5.9L) OHV	1966	56
Sebring	122 CID (2.0L) DOHC	1995-1999	11	VIP	383 CID (6.3L) OHV	1966-1969	58
Sebring	148 CID/2429CC (2.4L) DOHC	1996-2004	20	VIP	440 CID (7.2L) OHV	1966-1969	63
Sebring	167 CID/2736CC (2.7L) DOHC	2003	26	Valiant	170 CID (2.8L) OHV	1960-1969	27
Sebring	167 CID/2736CC (2.7L) DOHC	2001-2004	25	Valiant	198 CID (3.2L) OHV	1970-1973	32
Sebring	181 CID/2972CC (3.0L) EF7 SOHC Mitsubishi	2001-2003	30	Valiant	225 CID (3.7L) OHV	1961-1973	38
Sebring	2497CC (2.5L) EEB Mitsubishi	1995-2000	23	Valiant	273 CID (4.5L) OHV	1964-1969	44
Shadow	135 CID (2.2L) SOHC	1987-1994	17	Valiant	318 CID (5.2L)	1968-1976	49
Shadow	153 CID (2.5L) SOHC	1988-1995	21	Volare	225 CID (3.7L) OHV	1975	54
Shadow	181 CID (3.0L) SOHC Mitsubishi	1992-1994	29	Volare	318 CID (5.2L)	1976-1980	49
Special	218 CID (3.6L) L-Head	1934	37	Volare	360 CID (5.9L)	1976-1980	54
Special	218 CID (3.6L) L-Head	1942-1950	37	Wayfarer	230 CID (3.8L) L-Head	1949-1952	39
Deluxe				Windsor	251 CID (4.1L) L-Head	1946-1952	41
Spirit	153 CID (2.5L) SOHC	1989-1995	21	Windsor	265 CID (4.3L) L-Head	1951-1954	42
Spirit	181 CID (3.0L) SOHC Mitsubishi	1989-1995	29				
Sport Fury	225 CID (3.7L) OHV	1976	38				
Sport Fury	318 CID (5.2L)	1959-1971	49				
Sport Fury	340 CID (5.6L) OHV	1971	52				
Sport Fury	360 CID (5.9L)	1971	54				
Sport Fury	361 CID (5.9L) OHV	1959-1965	56				
Sport Fury	383 CID (6.3L) OHV	1963-1971	58				
Sport Fury	400 CID (6.6L) OHV	1976	59				
Sport Fury	426 CID (7.0L) Hemispherical	1964	61				
Sport Fury	426 CID (7.0L) Wedge	1963-1965	62				
Sport Fury	440 CID (7.2L) OHV	1966-1971	63				

1 86 CID (1.4L) SOHC "J" Mitsubishi 4 Cyl, 2.913in./74mm (1979-1984) 1

Part	Year	VIN	Model/Application	Part Number	Qty.
------	------	-----	-------------------	-------------	------

ENGINE GASKETS

Head Set	1979-1984			HS3798	1
Full Set	1979-1984			FS3798	1
Engine Kit Gasket Set	1979-1984		(Contains Seals And O-rings For Jet Valves)	95-3349VR	1
Cylinder Head Gasket	1979-1984			3675	1

Chrysler

1 (cont.)	86 CID (1.4L) SOHC "J" Mitsubishi 4 Cyl, 2.913in./74mm (1979-1984)					1 (cont.)
---------------------	---	--	--	--	--	---------------------

Part	Year	VIN	Model/Application	Part Number	Qty.
ENGINE GASKETS (cont.)					
Valve Cover Set	1979-1984		<i>Victo-Tech</i>	VS38425	1
Valve Stem Seal, Exh.	1979-1984			B45442	4
Valve Stem Seal, Int.	1979-1984			B45442	4
Manifold Set, Exhaust	1979-1984			MS15524	1
Manifold Set, Intake	1979-1984			MS7391	1
Oil Pan Set	1979-1984		<i>Cork Rubber</i>	OS20674	1
Rear Main Seal Set	1979-1984			JV506	1
Timing Cover Set	1979-1984			JV944	1
Timing Cover Gasket	1979-1984			T26806	1
Timing Cover Seal	1979-1984			47738	1

MISCELLANEOUS GASKETS					
Air Cleaner Mount Gasket	1984		Except Canadian Models, 2 Barrel Carburetor	G24965	1
	1983-1984		Canadian, Front Wheel Drive, 2 Barrel Carburetor	G24964	1
	1979-1982		Front Wheel Drive, 2 Barrel Carburetor	G24964	1
Camshaft Seal	1979-1984			47918	1
Carb. Mount Gasket	1983-1984		Except Canadian Models, 2 Barrel Carburetor	G25784	1
	1982-1984		Canadian, 2 Barrel Carburetor	G24966	1
	1979-1981		2 Barrel Carburetor	G25784	1
E.G.R. Gasket	1979-1984			G24078	1
Exhaust Pipe Gasket	1981-1984		(Flange Type), Pipe To Converter	F7422	1
Fuel Pump Gasket	1979-1984			D24085	2
Jet Valve Seal	1979-1984			B45471	4
Water Outlet Gasket	1979-1984			C24082	1

2	92 CID (1.5L) 12 Valve "Q" Mitsubishi 4 Cyl, 2.972in./75.5mm (1991-1994)					2
----------	---	--	--	--	--	----------

Part	Year	VIN	Model/Application	Part Number	Qty.
ENGINE GASKETS					
Head Set	1991-1994		(Exhaust Pipe Gasket Not Included)	HS5907A	1
Full Set	1991-1994		(Exhaust Pipe Gasket Not Included)	FS5907	1
Engine Kit Gasket Set	1991-1994			95-3352VR	1
Cylinder Head Gasket	1991-1994		<i>Nitroseal</i>	5907	1
Valve Cover Set	1991-1994			VS50151	1
Valve Stem Seal, Exh.	1991-1994			B45622	4
Valve Stem Seal, Int.	1991-1994			B45622	8
Manifold Set, Exhaust	1991-1994			MS12395	1
Manifold Set, Intake	1991-1994			MS15983	1
Oil Pan Set	1991-1994		<i>Cork Rubber</i>	OS20674	1
Rear Main Seal Set	1991-1994			JV506	1
Timing Cover Set	1991-1994			JV944	1
Timing Cover Gasket	1991-1994			T26806	1
Timing Cover Seal	1991-1994			47738	1

MISCELLANEOUS GASKETS					
Air Flow Sensor	1991-1992			G30807	1
Camshaft Seal	1991-1994			47918	1
E.G.R. Gasket	1991-1994		<i>Nitroseal</i>	G30714	1
Exhaust Pipe Gasket	1993-1994		(Flange Type), Catalytic Converter To Front Exhaust Pipe	F7409	1
			(Flange Type), Catalytic Converter To Center Pipe, Pipe To Manifold	F7422	2
	1991-1994		(Flange Type), Center Pipe To Muffler	F7464	1
	1991-1992		(Flange Type), Catalytic Converter To Center Pipe, Catalytic Converter To Front Exhaust Pipe	F7422	2
Fuel Pump Gasket	1991-1994		(Flange Type), Pipe To Manifold	F12336	1
			Cover To Cylinder Head	D24085	1
Injector Nozzle O-Ring	1991-1994			GS33277	1
Throttle Body Gasket	1991-1992			G31116	1

2 (cont.)	92 CID (1.5L) 12 Valve "Q" Mitsubishi 4 Cyl, 2.972in./75.5mm (1991-1994)				2 (cont.)
---------------------	---	--	--	--	---------------------

Part	Year	VIN	Model/Application	Part Number	Qty.
MISCELLANEOUS GASKETS (cont.)					
Water Outlet Gasket	1991-1994			C24082	1
Water Pipe O-Ring	1991-1994			B45797	1
Water Pump Mount Gasket	1991-1994			K26379	1

3	92 CID (1.5L) SOHC 8 Valve "Q" Fuel Injected Mitsubishi 4 Cyl, 2.972in./75.5mm (1987-1990)				3
----------	---	--	--	--	----------

Part	Year	VIN	Model/Application	Part Number	Qty.
ENGINE GASKETS					
Head Set	1987-1990		(Exhaust Pipe Gasket Not Included)	HS3798X	1
Full Set	1987-1990		(Exhaust Pipe Gasket Not Included)	FS3798X	1
Engine Kit Gasket Set	1987-1990		(Intake Manifold Gasket Not Included), Use With Part Number MS15439	95-3349VR	1
Cylinder Head Gasket	1987-1990			3675	1
Valve Cover Set	1987-1990		<i>Victo-Tech</i>	VS38425	1
Valve Stem Seal, Exh.	1987-1990			B45622	4
Valve Stem Seal, Int.	1987-1990			B45622	4
Manifold Set, Exhaust	1987-1990			MS12340	1
Manifold Set, Intake	1987-1990		(Contains Plenum Chamber Gasket)	MS15439	1
Plenum Chamber Gasket	1987-1990			MS12338	1
Oil Pan Set	1987-1990		<i>Cork Rubber</i>	OS20674	1
Rear Main Seal Set	1987-1990			JV506	1
Timing Cover Set	1987-1990			JV944	1
Timing Cover Gasket	1987-1990			T26806	1
Timing Cover Seal	1987-1990			47738	1

MISCELLANEOUS GASKETS					
Air Flow Sensor	1987-1990			G30807	1
Camshaft Seal	1987-1990			47918	1
E.G.R. Gasket	1987-1990		<i>Nitroseal</i>	G30714	1
Exhaust Pipe Gasket	1989-1990		Except Station Wagon, (Flange Type), Catalytic Converter To Center Pipe, Catalytic Converter To Front Exhaust Pipe	F7422	2
			Except Station Wagon, (Flange Type), Center Pipe To Muffler	F7464	1
	1987-1990		Station Wagon, (Flange Type), Catalytic Converter To Front Exhaust Pipe	F7422	1
			Station Wagon, (Flange Type), Center Pipe To Muffler	F7423	1
			(Flange Type), Pipe To Manifold	F12336	1
Fuel Pump Gasket	1987-1990		Cover To Cylinder Head	D24085	1
Injector Nozzle O-Ring	1987-1990			GS33277	1
Throttle Body Gasket	1990			G31116	1
	1987-1989			G30808	1
Water Outlet Gasket	1987-1990			C24082	1
Water Pump Mount Gasket	1987-1990			K26379	1

4	92 CID (1.5L) SOHC Jet Valve "Q" Carbureted Mitsubishi 4 Cyl, 2.972in./75.5mm (1985-1991)				4
----------	--	--	--	--	----------

Part	Year	VIN	Model/Application	Part Number	Qty.
ENGINE GASKETS					
Head Set	1987-1991		(Exhaust Pipe Gasket Not Included)	HS3798W	1
	1985-1986		(Exhaust Pipe Gasket Not Included)	HS3798	1
Full Set	1987-1991		(Exhaust Pipe Gasket Not Included)	FS3798W	1
	1985-1986		(Exhaust Pipe Gasket Not Included)	FS3798	1
Engine Kit Gasket Set	1985-1991		(Contains Seals And O-rings For Jet Valves)	95-3349VR	1
Cylinder Head Gasket	1985-1991			3675	1

Chrysler

4 (cont.)	92 CID (1.5L) SOHC Jet Valve "Q" Carbureted Mitsubishi 4 Cyl, 2.972in./75.5mm (1985-1991)				4 (cont.)
---------------------	--	--	--	--	---------------------

Part	Year	VIN	Model/Application	Part Number	Qty.
------	------	-----	-------------------	-------------	------

ENGINE GASKETS (cont.)

Valve Cover Set	1985-1991		<i>Victo-Tech</i>	VS38425	1
Valve Stem Seal, Exh.	1985-1991			B45442	4
Valve Stem Seal, Int.	1985-1991			B45442	4
Manifold Set, Exhaust	1987-1991			MS12340	1
	1985-1986			MS15524	1
Manifold Set, Intake	1985-1991			MS7391	1
Oil Pan Set	1985-1991		<i>Cork Rubber</i>	OS20674	1
Rear Main Seal Set	1985-1991			JV506	1
Timing Cover Set	1985-1991			JV944	1
Timing Cover Gasket	1985-1991			T26806	1
Timing Cover Seal	1985-1991			47738	1

MISCELLANEOUS GASKETS

Air Cleaner Mount Gasket	1985-1991			G30652	1
Camshaft Seal	1985-1991			47918	1
Carb. Mount Gasket	1987-1991		(Cold Mixture Heater), Top	G30805	1
			(Cold Mixture Heater), Bottom	G30806	1
	1986		Except Canadian Models	G30713	1
	1985-1986		Canadian	G30619	1
	1985		Except Canadian Models	G25771	1
E.G.R. Gasket	1987-1991		<i>Nitroseal</i>	G30714	1
	1985-1986			G24078	1
Exhaust Pipe Gasket	1987-1991		(Flange Type), Pipe To Manifold	F12336	1
	1985-1991		(Flange Type), Catalytic Converter To Front Exhaust Pipe	F7422	1
	1985-1986		Canadian Models, (Flange Type), Exhaust Pipe To Muffler	F7423	1
			(Flange Type), Manifold To Converter	F14761	1
Fuel Pump Gasket	1985-1991			D24085	2
Jet Valve Seal	1985-1991			B45471	4
Water Outlet Gasket	1985-1991			C24082	1
Water Pump Mount Gasket	1985-1991			K26379	1

5	97 CID (1.6L) OHV Peugeot 4 Cyl, 3.175in./80.65mm (1983-1986)				5
----------	--	--	--	--	----------

Part	Year	VIN	Model/Application	Part Number	Qty.
------	------	-----	-------------------	-------------	------

ENGINE GASKETS

Head Set	1983-1986		(Exhaust Pipe Gasket Not Included)	HS3791	1
Full Set	1983-1986		(Exhaust Pipe Gasket Not Included)	FS3791	1
Engine Kit Gasket Set	1983-1986			95-3101VR	1
Cylinder Head Gasket	1983-1986			3791	1
Valve Cover Set	1983-1986		<i>Cork Rubber</i>	VS38337	1
Valve Stem Seal, Exh.	1983-1986		<i>Fluoroelastomer</i>	B45546	4
Valve Stem Seal, Int.	1983-1986		<i>Fluoroelastomer</i>	B45546	4
Manifold Set, Exhaust	1983-1986			MS12305	1
Manifold Set, Intake	1983-1986			MS15377	1
Oil Pan Set	1983-1986		<i>Cork Rubber</i>	OS31250	1
			Upper	OS32049	1
Rear Main Seal Set	1983-1986			JV533	1
Timing Cover Set	1983-1986			JV993	1
Timing Cover Seal	1983-1986			48044	1

MISCELLANEOUS GASKETS

Air Cleaner Mount Gasket	1983-1986		2 Barrel Carburetor	G26129	1
Carb. Mount Gasket	1983-1986		2 Barrel Carburetor	G25769	1
E.G.R. Gasket	1983-1986			G24091	1
Exhaust Pipe Gasket	1983-1986			F7395	1
Fuel Pump Gasket	1983-1986			D24076	2

5 (cont.)	97 CID (1.6L) OHV Peugeot 4 Cyl, 3.175in./80.65mm (1983-1986)				5 (cont.)
---------------------	--	--	--	--	---------------------

Part	Year	VIN	Model/Application	Part Number	Qty.
MISCELLANEOUS GASKETS (cont.)					
Water Outlet Gasket	1983-1986			C25163	1
Water Pump Mount Gasket	1983-1986			K30616	1

6	98 CID (1.6L) SOHC K & Z Mitsubishi 4 Cyl, 3.028in./76.9mm (1971-1988)				6
----------	---	--	--	--	----------

Part	Year	VIN	Model/Application	Part Number	Qty.
ENGINE GASKETS					
Head Set	1984-1988		(Exhaust Pipe Gasket Not Included), Turbocharged	HS3735T	1
	1983-1984		Except Turbocharged, (Exhaust Manifold Gasket For Canada Not Included)	HS3735	1
	1982		Except Turbocharged, From 3/1/82, Triangular Cooling Holes, (Exhaust Manifold Gasket For Canada Not Included)	HS3735	1
			Round Cooling Holes, Thru 3/1/82, (Exhaust Manifold Gasket For Canada Not Included)	HS3773	1
	1981		Round Cooling Holes, (Exhaust Manifold Gasket For Canada Not Included)	HS3773	1
	1978-1980			HS3485W	1
	1976-1977		Balance Shaft Engine	HS3485	1
			Except Balance Shaft Engine	HS3648	1
	1971-1973			HS3517	1
Full Set	1984-1988		(Exhaust Pipe Gasket Not Included), Turbocharged	FS3735T	1
	1983-1984		Except Turbocharged, (Exhaust Manifold Gasket For Canada Not Included)	FS3735	1
	1982		Except Turbocharged, From 3/1/82, (Exhaust Manifold Gasket For Canada Not Included)	FS3735	1
			Round Cooling Holes, Thru 3/1/82, (Exhaust Manifold Gasket For Canada Not Included)	FS3773	1
	1981		(Exhaust Manifold Gasket For Canada Not Included)	FS3773	1
	1978-1980			FS3485W	1
	1976-1977		Balance Shaft Engine	FS3485	1
			Except Balance Shaft Engine	FS3648	1
	1971-1973			FS3517	1
Engine Kit Gasket Set	1971-1977	K	(Exhaust Manifold Gasket Not Included), Use With Part Number MS15309	95-3347VR	1
Cylinder Head Gasket	1983-1988		Triangular Cooling Holes	3735	1
	1982		From 3/1/82, Triangular Cooling Holes	3735	1
			Round Cooling Holes, Thru 3/1/82	3773	1
	1981		Round Cooling Holes	3773	1
	1976-1980		Balance Shaft Engine	3485	1
	1976-1977		Except Balance Shaft Engine	3648	1
	1971-1975			3648	1
Valve Cover Set	1978-1988		<i>Victo-Tech</i>	VS39797	1
	1976-1978		Balance Shaft Engine <i>Victo-Tech</i>	VS39797	1
	1971-1975		<i>Victo-Tech</i>	VS39753	1
Valve Stem Seal, Exh.	1976-1988		(Original Equipment Type)	B45441	8
			Premium	B45806	8
	1971-1973		(Original Equipment Type)	B45441	8
			Premium	B45806	8
Valve Stem Seal, Int.	1976-1988		(Original Equipment Type)	B45441	8
			Premium	B45806	8
	1971-1973		(Original Equipment Type)	B45441	8
			Premium	B45806	8
			Premium	B45806	8
Manifold Set, Exhaust	1984-1988		Turbocharged	MS15388	1
	1981-1984		Canadian Models	MS15309	1
			Except Canadian Models, Except Turbocharged	MS15532	1
	1978-1980			MS15308	1
	1971-1977			MS15309	1
Manifold Set, Intake	1984-1988		Turbocharged	MS15386	1

Chrysler

6 (cont.)	98 CID (1.6L) SOHC K & Z Mitsubishi 4 Cyl, 3.028in./76.9mm (1971-1988)	6 (cont.)
---------------------	---	---------------------

Part	Year	VIN	Model/Application	Part Number	Qty.
------	------	-----	-------------------	-------------	------

ENGINE GASKETS (cont.)

Manifold Set, Intake (cont.)	1977-1984		Except Turbocharged	MS15294	1
	1971-1973		Except Turbocharged	MS15294	1
Oil Pan Set	1979-1988		Cork Rubber	OS20673	1
	1976-1978		Balance Shaft Engine Cork Rubber	OS20673	1
	1976-1977		Except Balance Shaft Engine Cork Rubber	OS30549	1
Rear Main Seal Set	1976-1988			JV506	1
	1971-1973			JV506	1
Timing Cover Set	1981-1988			JV942	1
	1978-1980		Except Balance Shaft Engine, K Engine	JV942	1
	1976-1980		Balance Shaft Engine, Z Engine	JV1038	1
	1976-1977		Except Balance Shaft Engine	JV941	1
Timing Cover Gasket	1981-1988			T26587	1
	1976-1980		Balance Shaft Engine	T26808	1
	1971-1977		Except Balance Shaft Engine	T26807	1
Timing Cover Seal	1976-1988		Balance Shaft Engine, Z Engine	47730	1
	1976-1977		Except Balance Shaft Engine, K Engine	47734	1

MISCELLANEOUS GASKETS

Air Cleaner Mount Gasket	1984		Canadian Models, Multi-Port Fuel Injection	G24964	1
	1983-1984		Canadian Models, Front Wheel Drive, 2 Barrel Carburetor	G24964	1
	1983		Rear Wheel Drive, 2 Barrel Carburetor	G24090	1
	1971-1983		Front Wheel Drive, 2 Barrel Carburetor	G24964	1
	1976-1981		Rear Wheel Drive, 2 Barrel Carburetor	G24090	1
	1971-1973		Rear Wheel Drive, 2 Barrel Carburetor	G24090	1
Balance Shaft Seal	1976-1980		Balance Shaft Engine, Z Engine	47914	1
Camshaft Seal	1976-1988			47918	1
Cam. Semi-Circular Plug	1976-1988			B24180	1
Carb. Mount Gasket	1982-1984		Canadian Models, 2 Barrel Carburetor	G24966	1
			Except Canadian Models, 2 Barrel Carburetor	G25784	1
	1976-1977		2 Barrel Carburetor	G24967	1
	1971-1973		2 Barrel Carburetor	G24967	1
E.G.R. Gasket	1987-1988		Nitroseal	G30714	1
	1976-1986			G24078	1
	1972-1973			G24092	1
Exhaust Pipe Gasket	1987-1988		(Flange Type), Pipe To Converter	F7422	1
			(Flange Type), Pipe To Manifold	F7422	1
	1985-1986		(Flange Type), Pipe To Manifold	F7409	1
	1981-1984		(Flange Type), Pipe To Converter	F7422	1
	1971-1973		(Flange Type), Pipe To Manifold	F20333	1
Fuel Inj. Mixer Gasket	1984-1988			G30639	1
Fuel Pump Gasket	1976-1988		Balance Shaft Engine	D24077	2
	1971-1977		Except Balance Shaft Engine, K Engine	D24076	2
	1971-1973			D24076	2
Injector Nozzle O-Ring	1984-1988			GS33277	1
Jet Valve Seal	1978-1988		(Original Equipment Type)	B45471	4
Valve Cover Grommet	1976-1988			B45729	2
	1971-1973			B45729	2
Water Outlet Gasket	1976-1988			C24082	1
	1971-1973			C24082	1
Water Pump Mount Gasket	1979-1988			K26376	1
	1976-1981		Balance Shaft Engine, Z Engine	K26376	1
	1978-1980			K26376	1
	1976-1977		Except Balance Shaft Engine, K Engine	K26239	1
	1971-1975			K26239	1

7 98 CID (1.6L) DOHC Mitsubishi 4 Cyl, 3.240in./82.3mm (1989-1990)**7**

<i>Part</i>	<i>Year</i>	<i>VIN</i>	<i>Model/Application</i>	<i>Part Number</i>	<i>Qty.</i>
ENGINE GASKETS					
Head Set	1989-1990		(Exhaust Pipe Gasket Not Included)	HS5811	1
Lower Set	1989-1990		(Requires Head Set To Make Full Set)	CS5875	1
Full Set	1989-1990		(Exhaust Pipe Gasket Not Included)	FS5811	1
Engine Kit Gasket Set	1990		Multi-Port Fuel Injection	95-3353VR	1
				95-3353VR	1
	1989		Turbocharged	95-3353VR	1
Cylinder Head Gasket	1989-1990			Nitroseal 5875	1
Valve Cover Set	1989-1990			Victo-Tech VS50066	1
Valve Stem Seal, Exh.	1989-1990			B45622	8
Valve Stem Seal, Int.	1989-1990			B45622	8
Manifold Set, Exhaust	1989-1990			MS16215	1
Manifold Set, Intake	1989-1990			MS15976	1
Oil Pan Set	1989-1990		(Conventional Oil Pan Gasket Not Used)	Silicone JV6	1
Rear Main Seal Set	1989-1990			JV534	1
Timing Cover Set	1989-1990			JV1072	1
Timing Cover Seal	1989-1990			47730	1

MISCELLANEOUS GASKETS

Air Flow Sensor	1989-1990			G30807	1
Camshaft Seal	1989-1990			47918	2
Cam. Semi-Circular Plug	1989-1990			B45621	1
E.G.R. Gasket	1989-1990			Nitroseal G30714	1
Exhaust Pipe Gasket	1989-1990		(Flange Type), To Manifold	F7409	1
Throttle Body Gasket	1989-1990			G31040	1
Turbo Mounting Set	1989			GS33183	1
Water Outlet Gasket	1989-1990			C24082	1
Water Pump Gasket	1989-1990			K31039	1
Water Pump Mount Gasket	1990			K31039	1

8 105 CID (1.7L) SOHC Volkswagen 4 Cyl, 3.130in./79.5mm (1978-1983)**8**

<i>Part</i>	<i>Year</i>	<i>VIN</i>	<i>Model/Application</i>	<i>Part Number</i>	<i>Qty.</i>
ENGINE GASKETS					
Head Set	1978-1983		(Exhaust Pipe Gasket Not Included)	HS3609	1
Full Set	1978-1983		(Exhaust Pipe Gasket Not Included)	FS3609	1
Engine Kit Gasket Set	1978-1983			95-3076VR	1
Cylinder Head Gasket	1978-1983			VR2000 3609	1
Valve Cover Set	1978-1983			Cork Rubber VS30024	1
				Tuff-Cork VS30024TC	1
Valve Stem Seal, Exh.	1978-1983			Teflon B45423	4
				(Premium) Fluoroelastomer B45546	4
Valve Stem Seal, Int.	1978-1983			Teflon B45423	4
				(Premium) Fluoroelastomer B45546	4
Manifold Set, Int. & Exh.	1978-1983			MS15250	1
Oil Pan Set	1978-1983			Victo-Tech OS20056	1
Rear Main Seal Set	1978-1983			JV644	1
Timing Cover Set	1978-1983			JV982	1
Timing Cover Seal	1978-1983			66960	1

MISCELLANEOUS GASKETS

Air Cleaner Mount Gasket	1978-1983		2 Barrel Carburetor	G26129	1
Camshaft Seal	1978-1983			66960	1
Cam. Semi-Circular Plug	1978-1983			B45453	1
Carb. Mount Gasket	1978-1983		2 Barrel Carburetor, Carburetor To Spacer	G25769	1
			(Spacer), 2 Barrel Carburetor	G25775	1

Chrysler

8 (cont.)	105 CID (1.7L) SOHC Volkswagen 4 Cyl, 3.130in./79.5mm (1978-1983)				8 (cont.)
---------------------	--	--	--	--	---------------------

Part	Year	VIN	Model/Application	Part Number	Qty.
MISCELLANEOUS GASKETS (cont.)					
E.G.R. Gasket	1978-1983			G24079	1
Exhaust Pipe Gasket	1978-1983		(Ring Type 'F')	F7395	1
Fuel Pump Gasket	1978-1983			D24076	2
Inter Shaft Seal	1978-1983			66960	1
Intermediate Shaft Set	1978-1983			JV983	1
Water Outlet Gasket	1978-1983			C25163	1
Water Pump Hsg. O-Ring	1978-1983		<i>Victo-Tech</i>	C20119	1
Water Pump Mount Gasket	1978-1983			K26192	1

9	107 CID (1.8L) 8 Valve (4G37) Mitsubishi 4 Cyl, 3.173in./80.6mm (1989-1994)				9
Part	Year	VIN	Model/Application	Part Number	Qty.

ENGINE GASKETS					
Head Set	1989-1994		(Exhaust Pipe Gasket Not Included)	HS5812	1
Full Set	1989-1994		(Exhaust Pipe Gasket Not Included)	FS5812	1
Cylinder Head Gasket	1989-1994			5812	1
Valve Cover Set	1989-1994		<i>Victo-Tech</i>	VS39797	1
Valve Stem Seal, Exh.	1989-1994		(Original Equipment Type)	B45441	4
			(Premium)	B45806	4
Valve Stem Seal, Int.	1989-1994		(Original Equipment Type)	B45441	4
			(Premium)	B45806	4
Manifold Set, Exhaust	1989-1994			MS15980	1
Manifold Set, Intake	1989-1994		(Plenum Chamber Gasket Not Included)	MS15979	1
Plenum Chamber Gasket	1989-1992		Laser	MS14802	1
	1989-1990		Colt	MS12338	1
Oil Pan Set	1989-1994		Original Equipment Uses RTV <i>Silicone</i>	JV6	1
Rear Main Seal Set	1989-1994			JV506	1
Timing Cover Set	1989-1994		Laser	JV1038	1
	1989-1990		Colt	JV942	1
Timing Cover Gasket	1989-1992		Laser	T26808	1
	1989-1990		Colt	T26587	1
Timing Cover Seal	1989-1994			47730	1

MISCELLANEOUS GASKETS					
Air Flow Sensor	1989-1992			G30807	1
Balance Shaft Seal	1989-1992			47914	1
Camshaft Seal	1989-1992			47918	1
Cam. Semi-Circular Plug	1989-1992			B24180	1
E.G.R. Gasket	1989-1992		<i>Nitroseal</i>	G30714	1
Exhaust Pipe Gasket	1989-1994		(Flange Type)	F12336	1
	1989-1992		Laser, (Flange Type), Pipe To Converter	F7409	1
			Laser, (Flange Type), Catalytic Converter To Center Pipe	F7422	1
			Laser, (Flange Type), Center Pipe To Muffler	F7464	1
	1989-1990		Colt, (Flange Type), Pipe To Converter	F7422	1
			Colt, (Flange Type), Center Pipe To Muffler	F7423	1
Colt, (Flange Type)			F12336	1	
Fuel Pump Gasket	1989-1992			D24077	2
Injector Nozzle O-Ring	1989-1992			GS33277	1
Throttle Body Gasket	1991-1992		Laser	G31115	1
	1990		Colt	G31115	1
	1989-1990		Laser	G30808	1
	1989		Colt	G30808	1
Valve Cover Grommet	1989-1992			B45729	2
Water Outlet Gasket	1989-1992			C24082	1

9 (cont.)	107 CID (1.8L) 8 Valve (4G37) Mitsubishi 4 Cyl, 3.173in./80.6mm (1989-1994)				9 (cont.)
---------------------	--	--	--	--	---------------------

Part	Year	VIN	Model/Application	Part Number	Qty.
------	------	-----	-------------------	-------------	------

MISCELLANEOUS GASKETS (cont.)

Water Pump Mount Gasket	1989-1990			K26376	1
-------------------------	-----------	--	--	--------	---

10	112 CID (1.8L) 16 Valve (4G93) Mitsubishi 4 Cyl, 3.189in./81mm (1992-1994)				10
-----------	---	--	--	--	-----------

Part	Year	VIN	Model/Application	Part Number	Qty.
------	------	-----	-------------------	-------------	------

ENGINE GASKETS

Head Set	1993-1994			HS54172	1
Cylinder Head Gasket	1992-1994		Nitroseal	54172	1
Valve Cover Set	1992-1994			VS50274	1
Valve Stem Seal, Exh.	1992-1994			B45870	8
Valve Stem Seal, Int.	1992-1994			B45870	8
Manifold Set, Exhaust	1992-1994		Multi-Layered Steel	MS16278	1
Manifold Set, Intake	1993-1994		California	MS16506	1
Oil Pan Set	1993-1994		Cork Rubber	OS32154	1
Rear Main Seal Set	1993-1994			JV1646	1

MISCELLANEOUS GASKETS

Spark Plug Tube Seal	1992-1994			B45881	1
Throttle Body Gasket	1993-1994			G31526	1
Water Pump Mount Gasket	1993-1994			K31521	1

11	122 CID (2.0L) DOHC 4 Cyl, 3.445in./87.5mm (1995-1999)				11
-----------	---	--	--	--	-----------

Part	Year	VIN	Model/Application	Part Number	Qty.
------	------	-----	-------------------	-------------	------

ENGINE GASKETS

Head Set	1995-1999			HS54044B	1
Lower Set	1995-1999			CS54044	1
Engine Kit Gasket Set	1995-1999			95-3457VR	1
Cylinder Head Gasket	1995-1999		Multi-Layered Steel	54044A	1
Cyl. Head Bolt Set	1995-1999			GS33341	1
Valve Cover Set	1995-1999		(Contains Valve Cover Grommets, Spark Plug Tube Seals Not Included) Victo-Tech	VS50234	1
			(Contains Valve Cover Gasket Only) Victo-Tech	VS50234A	1
Valve Stem Seal, Exh.	1995-1999			B45844	8
Valve Stem Seal, Int.	1995-1999			B45844	8
Manifold Set, Exhaust	1995-1999			MS12448	1
Manifold Set, Intake	1995-1999		Neon, (Contains Plenum Chamber Gasket) Nitroseal	MS16149	1
			Neon, (Contains Plenum Chamber Gasket)	MS16149B	1
			Avenger, Sebring, (Contains Plenum Chamber Gasket)	MS16234	1
Plenum Chamber Gasket	1995-1999		Neon	MS16189	1
			Avenger, Sebring	MS16235	1
Oil Pan Set	1995-1999		Victo-Tech	OS50225	1
Rear Main Seal Set	1995-1999		(One Piece) Teflon	JV1629	1
			(One Piece) Rubber	JV1654	1
Timing Cover Set	1995-1999			JV1202	1
Timing Cover Gasket	1995-1999		Inner	T31497	1
			Outer	T31499	1

MISCELLANEOUS GASKETS

Camshaft Seal	1995-1999		Front	48392	2
Cam Sensor O-Ring	1995-1999			GS33332	1
E.G.R. Gasket	1995-1999		Valve	G31321	1
			Exhaust Gas Recirculation Tube	G31458	1
Exhaust Pipe Gasket	1995-1999		Avenger, Sebring, (Flange Type), Catalytic Converter To Center Pipe, Inlet Pipe To Catalytic Converter, Pipe To Manifold	F7409	3

Chrysler

11 (cont.)	122 CID (2.0L) DOHC 4 Cyl, 3.445in./87.5mm (1995-1999)					11 (cont.)
----------------------	---	--	--	--	--	----------------------

Part	Year	VIN	Model/Application	Part Number	Qty.
------	------	-----	-------------------	-------------	------

MISCELLANEOUS GASKETS (cont.)

Exhaust Pipe Gasket (cont.)	1995-1999		Neon, (Ring Type 'F')	F7466	1
			Avenger, Sebring, Center Pipe To Muffler	F10120	1
Spark Plug Tube Seal	1995-1999			B45843	4
Throttle Body Gasket	1995-1999		Avenger, Sebring	G31480	1
			Neon	G31500	1
Valve Cover Grommet	1995-1999			B45846	8
Water Pump Mount Gasket	1995-1999			K31501	1

12	122 CID (2.0L) SOHC 4 Cyl, 3.445in./87.5mm (1995-2003)					12
-----------	---	--	--	--	--	-----------

Part	Year	VIN	Model/Application	Part Number	Qty.
------	------	-----	-------------------	-------------	------

ENGINE GASKETS

Head Set	2001	C		HS5936D	1
	2000			HS5936D	1
	1996-1999	C		HS5936C	1
	1995	C		HS5936B	1
Lower Set	1995-2001		(Requires Head Set To Make Full Set)	CS5936	1
Engine Kit Gasket Set	1995-1999	C		95-3456VR	1
Cylinder Head Gasket	1995-2002		<i>Multi-Layered Steel</i>	5936A	1
Cyl. Head Bolt Set	1995-2003			GS33336	1
Valve Cover Set	2000		Stamped Steel Valve Cover, (Contains Spark Plug Tube Seals) <i>Victo-Tech</i>	VS50242	1
	1996-1999		(Contains Spark Plug Tube Seals) <i>Victo-Tech</i>	VS50242	1
	1995		(Contains Spark Plug Tube Seals) <i>Victo-Tech</i>	VS50223	1
Valve Stem Seal, Exh.	1995-2003			B45844	8
Valve Stem Seal, Int.	1995-2003			B45844	8
Manifold Set, Exhaust	2001-2003	C	<i>Nitroseal</i>	MS16184	1
	1995-2000		<i>Nitroseal</i>	MS16184	1
Manifold Set, Intake	2001-2003	C	Plastic Manifold, (Contains 4 Port Seals)	GS33302	1
	1995-2000		Plastic Manifold, (Contains 4 Port Seals)	GS33302	1
	1995-1996		Aluminum Manifold	MS16268	1
Oil Pan Set	1995-2003		<i>Victo-Tech</i>	OS50225	1
Rear Main Seal Set	1995-2001		(One Piece) <i>Teflon</i>	JV1629	1
			(One Piece) <i>Rubber</i>	JV1654	1
Timing Cover Set	1995-1999			JV1201	1
Timing Cover Gasket	1995-1999		Inner	T31497	1
			Outer	T31498	1

MISCELLANEOUS GASKETS

Camshaft Seal	1995-2003		Front	48392	1
Cam Sensor O-Ring	1995-2003			GS33332	1
E.G.R. Gasket	2001		Cover To Cylinder Head	G31321	1
			Neon, Cover To Cylinder Head	G31321	1
	2000		Breeze, Stratus, Valve	G31321	1
			Breeze, Stratus, Tube To Valve	G31458	1
			Breeze, Stratus, Tube To Intake Manifold	G31495	1
			Tube To Intake Manifold	G31495	1
	1995-1999		Valve	G31321	1
			Tube To Valve	G31458	1
1995-1996		Plastic Manifold, Tube To Intake Manifold	G31495	1	
Exhaust Pipe Gasket	1998-2001		(Flange Type), Pipe To Manifold	F7568	1
	1995-1997		(Ring Type 'F'), Pipe To Manifold	F7466	1
Spark Plug Tube Seal	1996-1999			B45848	4
	1995			B45847	4
Throttle Body Gasket	1995-1999		Plastic Manifold	G31496	1
	1995-1996		Aluminum Manifold	G31480	1

12 (cont.)	122 CID (2.0L) SOHC 4 Cyl, 3.445in./87.5mm (1995-2003)				12 (cont.)
----------------------	---	--	--	--	----------------------

Part	Year	VIN	Model/Application	Part Number	Qty.
------	------	-----	-------------------	-------------	------

MISCELLANEOUS GASKETS (cont.)

Water Pump Mount Gasket	1995-2003			K31501	1
-------------------------	-----------	--	--	--------	---

13	122 CID (2.0L) 4G63 DOHC Mitsubishi 4 Cyl, 3.346in./85mm (1989-1994)				13
-----------	---	--	--	--	-----------

Part	Year	VIN	Model/Application	Part Number	Qty.
------	------	-----	-------------------	-------------	------

ENGINE GASKETS

Head Set	1993-1994		(Exhaust Pipe Gasket Not Included)	HS5875A	1
	1989-1992		(Exhaust Pipe Gasket Not Included)	HS5875	1
Lower Set	1993-1994		(Requires Head Set To Make Full Set)	CS5875A	1
	1989-1992		(Requires Head Set To Make Full Set)	CS5875	1
Full Set	1989-1992		(Exhaust Pipe Gasket Not Included)	FS5875	1
Engine Kit Gasket Set	1989-1992			95-3353VR	1
Cylinder Head Gasket	1989-1994		<i>Nitroseal</i>	5875	1
Valve Cover Set	1993-1994		(Contains Spark Plug Tube Seals, Contains Camshaft Semi Circular Plug)	<i>Victo-Tech</i> VS50252	1
	1989-1992		(Contains Spark Plug Tube Seals, Contains Camshaft Semi Circular Plug)	<i>Victo-Tech</i> VS50066	1
Valve Stem Seal, Exh.	1989-1994			B45622	8
Valve Stem Seal, Int.	1989-1994			B45622	8
Manifold Set, Exhaust	1989-1994		<i>Multi-Layered Steel</i>	MS16215	1
Manifold Set, Intake	1989-1994			MS15976	1
Oil Pan Set	1993-1994		<i>Cork Rubber</i>	OS32137	1
	1989-1992		<i>Cork Rubber</i>	OS32008	1
Rear Main Seal Set	1993-1994			JV1646	1
	1989-1992			JV534	1
Timing Cover Set	1989-1992		(Requires Oil Pan Set)	JV1036	1
Timing Cover Seal	1989-1994			47730	1

MISCELLANEOUS GASKETS

Air Flow Sensor	1989-1992			G30807	1
Camshaft Seal	1989-1994			47918	2
Cam. Semi-Circular Plug	1989-1994			B45621	1
E.G.R. Gasket	1989-1994		<i>Nitroseal</i>	G30714	1
Exhaust Pipe Gasket	1989-1994		(Flange Type), Catalytic Converter To Front Exhaust Pipe	F7409	1
			(Flange Type), Catalytic Converter To Center Pipe	F7422	1
			(Flange Type), Pipe To Manifold	F12336	1
Injector Nozzle O-Ring	1989-1994			GS33277	1
Water Outlet Gasket	1989-1994			C24082	1
Water Pump Mount Gasket	1989-1994			K30615	1

14	122 CID (2.0L) 4G63T DOHC TURBO Mitsubishi 4 Cyl, 3.346in./85mm (1990-1994)				14
-----------	--	--	--	--	-----------

Part	Year	VIN	Model/Application	Part Number	Qty.
------	------	-----	-------------------	-------------	------

ENGINE GASKETS

Head Set	1993-1994		(Exhaust Pipe Gasket Not Included, Turbocharger Gasket Not Included)	HS5875A	1
	1990-1992		(Exhaust Pipe Gasket Not Included)	HS5875T	1
Lower Set	1993-1994		(Requires Head Set To Make Full Set)	CS5875A	1
	1990-1992		(Requires Head Set To Make Full Set)	CS5875	1
Full Set	1990-1992		(Exhaust Pipe Gasket Not Included)	FS5875T	1
Engine Kit Gasket Set	1990-1992			95-3353VR	1
Cylinder Head Gasket	1990-1994		<i>Nitroseal</i>	5875	1
Valve Cover Set	1993-1994		(Contains Spark Plug Tube Seals, Contains Camshaft Semi Circular Plug)	<i>Victo-Tech</i> VS50252	1
	1990-1992		(Contains Spark Plug Tube Seals, Contains Camshaft Semi Circular Plug)	<i>Victo-Tech</i> VS50066	1

Chrysler

14 (cont.)	122 CID (2.0L) 4G63T DOHC TURBO Mitsubishi 4 Cyl, 3.346in./85mm (1990-1994)				14 (cont.)
----------------------	--	--	--	--	----------------------

Part	Year	VIN	Model/Application	Part Number	Qty.
------	------	-----	-------------------	-------------	------

ENGINE GASKETS (cont.)

Valve Stem Seal, Exh.	1990-1994			B45622	8
Valve Stem Seal, Int.	1990-1994			B45622	8
Manifold Set, Exhaust	1990-1994		<i>Multi-Layered Steel</i>	MS16215	1
Manifold Set, Intake	1990-1994			MS15976	1
Oil Pan Set	1993-1994		<i>Cork Rubber</i>	OS32137	1
	1990-1992		<i>Cork Rubber</i>	OS32008	1
Rear Main Seal Set	1990-1992			JV534	1
Timing Cover Set	1993-1994		(Requires Oil Pan Set), Use With Part Number OS32137	JV5006	1
	1990-1992		(Requires Oil Pan Set), Use With Part Number OS32008	JV1036	1
Timing Cover Seal	1990-1994			47730	1

MISCELLANEOUS GASKETS

Camshaft Seal	1990-1994			47918	2
Cam. Semi-Circular Plug	1990-1994			B45621	1
E.G.R. Gasket	1990-1994		<i>Nitroseal</i>	G30714	1
Exhaust Pipe Gasket	1990-1994		(Flange Type), Catalytic Converter To Front Exhaust Pipe, Pipe To Manifold	F7409	2
			(Flange Type), Catalytic Converter To Center Pipe	F7422	1
			Exhaust Pipe To Muffler	F10120	1
Injector Nozzle O-Ring	1990-1994			GS33277	1
Throttle Body Gasket	1991-1994			G31547	1
	1990		From 5/2/90	G31547	1
Turbo Mounting Set	1990-1994			GS33311	1
Water Outlet Gasket	1990-1994			C24082	1
Water Pipe O-Ring	1990-1994			B45797	2
Water Pump Mount Gasket	1990-1994			K30615	1

15	122 CID (2.0L) SOHC "A" Mitsubishi 4 Cyl, 3.346in./85mm (1984-1991)				15
-----------	--	--	--	--	-----------

Part	Year	VIN	Model/Application	Part Number	Qty.
------	------	-----	-------------------	-------------	------

ENGINE GASKETS

Head Set	1986-1991		(Exhaust Pipe Gasket Not Included)	HS5703Y	1
	1985		Thru 9/84	HS5703X	1
			From 10/84, (Exhaust Pipe Gasket Not Included)	HS5703Y	1
	1984			HS5703X	1
Lower Set	1984-1991		(Requires Head Set To Make Full Set)	CS5875	1
Full Set	1986-1991		(Exhaust Pipe Gasket Not Included)	FS5703Y	1
	1985		Thru 9/84	FS5703X	1
			From 10/84, (Exhaust Pipe Gasket Not Included)	FS5703Y	1
	1984			FS5703X	1
Engine Kit Gasket Set	1984-1991		(Contains Seals And O-rings For Jet Valves)	95-3133VR	1
Cylinder Head Gasket	1984-1991		<i>VR2000</i>	5703	1
Cyl. Head Spacer Shim	1984-1991		Requires Sealing Compound	<i>Steel</i> 5703S	1
	1989-1990			<i>Steel</i> 5703S	1
Sealing Compound	1984-1991		(4 Ounce Brush Top Can)	JV66B	1
			(12 Ounce Spray Can)	JV66S	1
Valve Cover Set	1984-1991		(Valve Cover Grommets Not Included, Camshaft Semi Circular Plug Not Included)	<i>Victo-Tech</i> VS40003	1
			(Contains Valve Cover Grommets, Contains Camshaft Semi Circular Plug)	<i>Victo-Tech</i> VS40003CP	1
Valve Stem Seal, Exh.	1984-1991		(Original Equipment Type)	B45441	4
			(Premium)	B45806	4
Valve Stem Seal, Int.	1984-1991		(Original Equipment Type)	B45441	4
			(Premium)	B45806	4
Manifold Set, Exhaust	1986-1991			MS15389	1
	1985		From 10/84	MS15389	1

15 122 CID (2.0L) SOHC "A" Mitsubishi 4 Cyl, 3.346in./85mm (1984-1991)

(cont.)

15

(cont.)

Part	Year	VIN	Model/Application	Part Number	Qty.
ENGINE GASKETS (cont.)					
Manifold Set, Exhaust (cont.)	1985		Thru 9/84	MS15390	1
	1984			MS15390	1
Manifold Set, Intake	1989-1991		Colt Vista, (Contains Plenum Chamber Gasket)	MS15387Y	1
	1989-1990		2000 GTX, (Contains Plenum Chamber Gasket)	MS15387Z	1
	1987-1988		(Contains Plenum Chamber Gasket), Multi-Port Fuel Injection	MS15387X	1
	1984-1988		2 Barrel Carburetor	MS15387	1
Plenum Chamber Gasket	1989-1991		Colt Vista	MS14900	1
	1989-1990		2000 GTX	MS14902	1
	1987-1988			MS12339	1
Oil Pan Set	1984-1991		<i>Cork Rubber</i>	OS32008	1
Rear Main Seal Set	1984-1991			JV534	1
Timing Cover Set	1986-1991			JV1036	1
	1985		Thru 4/85	JV994	1
			From 4/85	JV1036	1
	1984			JV994	1
Timing Cover Seal	1984-1991			47730	1

MISCELLANEOUS GASKETS

Air Cleaner Mount Gasket	1984-1987		2 Barrel Carburetor	G24965	1
Air Flow Sensor	1987-1991			G30807	1
Camshaft Seal	1984-1991			47918	1
Cam. Semi-Circular Plug	1989-1991			B24180	1
Carb. Mount Gasket	1984-1987		2 Barrel Carburetor	G25771	1
E.G.R. Gasket	1988-1991		<i>Nitroseal</i>	G30714	1
	1987		Thru 10/86	G24078	1
			From 11/86	<i>Nitroseal</i>	G30714
	1984-1986			G24078	1
Exhaust Pipe Gasket	1989-1990		(Flange Type), Catalytic Converter To Front Exhaust Pipe	F7409	1
			(Flange Type), Catalytic Converter To Center Pipe	F7422	1
			(Flange Type), Center Pipe To Muffler	F7464	1
			(Flange Type), Pipe To Manifold	F12336	1
Fuel Pump Gasket	1984-1991			D24085	2
Injector Nozzle O-Ring	1987-1991			GS33277	1
Jet Valve Seal	1984-1988			B45471	4
Throttle Body Gasket	1987-1991		Colt Vista	G30808	1
	1990		2000 GTX	G31115	1
	1989		2000 GTX	G30808	1
Valve Cover Grommet	1984-1991			B45729	2
Water Outlet Gasket	1984-1991			C24082	1
Water Pump Mount Gasket	1984-1991			K30615	1

16 122 CID/1997CC (2.0L) SOHC "U" Mitsubishi 4 Cyl, 3.307in./84mm (1974-1979)**16**

Part	Year	VIN	Model/Application	Part Number	Qty.
ENGINE GASKETS					
Head Set	1978-1979			HS3672W	1
	1976-1977			HS3672	1
	1974-1975			HS3671	1
Full Set	1978-1979			FS3672W	1
	1976-1977			FS3672	1
	1974-1975			FS3671	1
Cylinder Head Gasket	1976-1979			3672	1
	1974-1975			3671	1

Chrysler

16 (cont.)	122 CID/1997CC (2.0L) SOHC "U" Mitsubishi 4 Cyl, 3.307in./84mm (1974-1979)				16 (cont.)
----------------------	---	--	--	--	----------------------

Part	Year	VIN	Model/Application	Part Number	Qty.
ENGINE GASKETS (cont.)					
Valve Cover Set	1976-1979		<i>Victo-Tech</i>	VS39860	1
	1974-1975			VS39861	1
Valve Stem Seal, Exh.	1974-1979		(Original Equipment Type)	B45441	4
			Premium	B45806	4
Valve Stem Seal, Int.	1974-1979		(Original Equipment Type)	B45441	4
			Premium	B45806	4
Manifold Set, Exhaust	1978-1979			MS15299	1
	1976-1977			MS15298	1
	1974-1975		Round Ports	MS15298	1
			Square Ports	MS15305	1
Manifold Set, Intake	1974-1979			MS15295	1
Oil Pan Set	1976-1979		<i>Cork Rubber</i>	OS20776	1
	1974-1975			OS20775	1
Rear Main Seal Set	1974-1979			JV507	1
Timing Cover Set	1976-1979			JV943	1
	1974-1975			JV945	1
Timing Cover Gasket	1976-1979			T26234	1
Timing Cover Seal	1974-1979			47735	1

MISCELLANEOUS GASKETS					
Air Cleaner Mount Gasket	1974-1979		2 Barrel Carburetor	G24090	1
Cam. Semi-Circular Plug	1974-1979			B24180	1
Carb. Mount Gasket	1978-1979		2 Barrel Carburetor	G25784	1
	1974-1977		2 Barrel Carburetor	G24966	1
E.G.R. Gasket	1976-1979			G24078	1
	1974-1975			G24092	1
Exhaust Pipe Gasket	1974		(Flange Type), Pipe To Manifold	F12287	1
Fuel Pump Gasket	1974-1979			D24076	2
Jet Valve Seal	1978-1979			B45471	4
Valve Cover Grommet	1976-1979			B45729	2
Water Outlet Gasket	1974-1979			C24082	1
Water Pump Mount Gasket	1976-1979			K26487	1

17	135 CID (2.2L) SOHC 4 Cyl, 3.445in./87.5mm (1981-1994)				17
-----------	---	--	--	--	-----------

Part	Year	VIN	Model/Application	Part Number	Qty.
ENGINE GASKETS					
Head Set	1994		(Contains Head Bolts, Exhaust Pipe Gasket Not Included)	HS5764WB2	1
			Aluminum Valve Cover, Plastic Valve Cover, (Head Bolts Not Included, Rear Camshaft Plug Not Included, Exhaust Pipe Gasket Not Included), Naturally Aspirated	HS54097-3	1
	1991-1994		Stamped Steel Valve Cover, (Head Bolts Not Included, Rear Camshaft Plug Not Included, Exhaust Pipe Gasket Not Included), Naturally Aspirated	HS54097-2	1
	1989-1993		(Contains Head Bolts, Exhaust Pipe Gasket Not Included), Naturally Aspirated	HS3688WB2	1
			Turbocharged, (Contains Head Bolts, Exhaust Pipe Gasket Not Included)	HS5764WB1	1
	1989-1990		(Head Bolts Not Included, Exhaust Pipe Gasket Not Included), Turbocharged	HS54097-1	1
			(Head Bolts Not Included, Rear Camshaft Plug Not Included, Exhaust Pipe Gasket Not Included, Camshaft Rear Seal With 2.061" Outer Diameter Not Included), Naturally Aspirated	HS54097-2	1
	1988		Requires Rear Camshaft Plug, (Head Bolts Not Included, Rear Camshaft Plug Not Included, Exhaust Pipe Gasket Not Included), Turbocharged	HS54097-1	1

17 135 CID (2.2L) SOHC 4 Cyl, 3.445in./87.5mm (1981-1994)

17
(cont.)

Part	Year	VIN	Model/Application	Part Number	Qty.
ENGINE GASKETS (cont.)					
Head Set (cont.)	1987-1988		(Contains Head Bolts, Exhaust Pipe Gasket Not Included, Camshaft Rear Seal Plug Not Included, Valve Cover Gasket For 1988 Not Included), Turbocharged/Intercooled	HS5764WB	1
	1986-1988		(Contains Head Bolts, Exhaust Pipe Gasket Not Included, Camshaft Rear Seal Plug Not Included, Camshaft Rear Seal With 2.061" Outer Diameter Not Included), Naturally Aspirated	HS3688WB1	1
			(Contains Head Bolts, Exhaust Pipe Gasket Not Included, Camshaft Rear Seal Plug Not Included, Valve Cover Gasket For 1988 Not Included), Turbocharged	HS3688WB4	1
	1984-1988		(Head Bolts Not Included, Rear Camshaft Plug Not Included, Exhaust Pipe Gasket Not Included), Turbocharged	HS54097	1
	1981-1986		(Contains Head Bolts, Exhaust Pipe Gasket Not Included, Camshaft Rear Seal Plug Not Included, Camshaft Rear Seal With 2.061" Outer Diameter Not Included), Turbocharged	HS3688WB3	1
	1981-1985		(Contains Head Bolts, Exhaust Pipe Gasket Not Included, Camshaft Rear Seal Plug Not Included, Camshaft Rear Seal With 2.061" Outer Diameter Not Included), Naturally Aspirated	HS3688WB	1
Lower Set	1994		Requires Head Set To Make Full Set	CS5764	1
	1989-1994		(Requires Head Set To Make Full Set)	CS54097-2	1
	1981-1988		(Requires Head Set To Make Full Set)	CS54097	1
Full Set	1989-1993		(Exhaust Pipe Gasket Not Included), Naturally Aspirated	FS3688Z	1
	1989-1990		(Exhaust Pipe Gasket Not Included), Turbocharged	FS5764X	1
	1988		Valve Cover Gasket Required, (Valve Cover Gasket Not Included, Exhaust Pipe Gasket Not Included, Camshaft Rear Seal Plug Not Included, Camshaft Rear Seal With 2.061" Outer Diameter Not Included), Turbocharged	FS3688T	1
	1987-1988		(Exhaust Pipe Gasket Not Included, Camshaft Rear Seal Plug Not Included, Valve Cover Gasket For 1988 Not Included), Turbocharged/Intercooled	FS5764	1
	1981-1988		(Exhaust Pipe Gasket Not Included, Camshaft Rear Seal Plug Not Included, Camshaft Rear Seal With 2.061" Outer Diameter Not Included), Naturally Aspirated	FS3688	1
	1984-1987		(Exhaust Pipe Gasket Not Included, Camshaft Rear Seal Plug Not Included, Camshaft Rear Seal With 2.061" Outer Diameter Not Included), Turbocharged	FS3688T	1
Engine Kit Gasket Set	1994		(Valve Cover Set Not Included, Aluminum Cover Gasket Not Included, Camshaft Rear Seal Plug Not Included), Use With Part Numbers VS50067, B45573	95-3350VR	1
	1989-1994		Except Turbocharged, Stamped Steel Valve Cover, (Camshaft Rear Seal Plug Not Included), Use With Part Number B45573	95-3350VR	1
	1989-1990		Intercooled Engine, Turbo II And IV	95-3351VR	1
	1988		Except Intercooled Engine, Turbo I, (Valve Cover Set Not Included, Camshaft Rear Seal Plug Not Included), Use With Part Numbers VS50067, B45573	95-3438VR	1
			Except Intercooled Engine, Turbo I, (Valve Cover Set Not Included, Camshaft Rear Seal Plug Not Included), Turbocharged, Use With Part Numbers VS50067, B45573	95-3438VR	1
			Except Intercooled Engine, Turbo I, (Valve Cover Set Not Included, Camshaft Rear Seal Plug Not Included), Turbocharged	95-3438VR	1
			Except Intercooled Engine, Turbo I, (Valve Cover Set Not Included, Camshaft Rear Seal Plug Not Included), Use With Part Numbers VS50067, B45573 (4)	95-3438VR	1
	1984-1988		Except Intercooled Engine, (Camshaft Rear Seal Plug Not Included), Turbocharged, Use With Part Number B45573	95-3348VR	1
	1983-1988		Except Turbocharged, (Camshaft Rear Seal Plug Not Included, Contains Camshaft Rear Seal With 2.112" Outside Diameter), Use With Part Numbers B45573, 47931	95-3438VR	1
1983-1984		Except Turbocharged, (Camshaft Rear Seal Plug Not Included, Contains Camshaft Rear Seal With 2.112" Outside Diameter), Use With Part Number B45573	95-3438VR	1	

Chrysler

17 135 CID (2.2L) SOHC 4 Cyl, 3.445in./87.5mm (1981-1994)

(cont.)

17

(cont.)

Part Year VIN Model/Application Part Number Qty.

ENGINE GASKETS (cont.)

Engine Kit Gasket Set (cont.)	1981-1984		Except Turbocharged, (Camshaft Rear Seal Plug Not Included, Contains Camshaft Rear Seal With 2.112" Outside Diameter), Use With Part Numbers B45573, 47931	95-3438VR	1
Cylinder Head Gasket	1981-1994		<i>Nitroseal</i>	54097	1
			(Thicker Head Gasket) <i>Nitroseal, .093" Thickness</i>	54114G	1
Cyl. Head Bolt Set	1986-1994		11mm Head Bolts	GS33184	1
	1981-1985		10mm Head Bolts	GS33250	1
Cyl. Head Washer Set	1981-1994			GS33185	1
Sealing Compound	1981-1994		(4 Ounce Brush Top Can)	JV66B	1
			(12 Ounce Spray Can)	JV66S	1
Valve Cover Set	1994		Stamped Steel Cover <i>Cork Rubber</i>	VS38039	1
			Aluminum Valve Cover <i>Victo-Tech</i>	VS50067	1
			Stamped Steel Cover <i>Victo-Foam</i>	VS50309	1
	1981-1993		Naturally Aspirated <i>Cork Rubber</i>	VS38039	1
			Naturally Aspirated <i>Victo-Foam</i>	VS50309	1
	1988-1990		Turbocharged <i>Victo-Tech</i>	VS50067	1
1981-1987		Turbocharged <i>Cork Rubber</i>	VS50007	1	
Valve Stem Seal, Exh.	1981-1994			B45449	4
Valve Stem Seal, Int.	1981-1994			B45449	4
Manifold Set, Int. & Exh.	1990-1994			MS15313	1
	1987-1994		Naturally Aspirated	MS15313	1
	1988-1992			MS15313	1
	1985-1989		Naturally Aspirated	MS15313	1
	1988			MS15313	1
	1986-1988		Naturally Aspirated	MS15313	1
			Turbocharged Except Intercooled, Turbocharged	MS15313	1
	1985-1988			MS15313	1
			Naturally Aspirated	MS15313	1
	1984-1988			MS15313	1
	1987		Turbocharged Except Intercooled	MS15313	1
			Intercooled Turbocharged Engines, Turbocharged/Intercooled	MS15313X	1
	1986-1987		Naturally Aspirated	MS15313	1
	1985-1987			MS15313	1
1983-1987		Naturally Aspirated	MS15313	1	
1981-1986			MS15313	1	
Oil Pan Set	1989-1994		<i>Victo-Tech</i>	OS32051	1
	1981-1988		<i>Cork Rubber</i>	OS38141	1
Rear Main Seal	1981-1994			47892	1
Rear Main Seal Set	1981-1994			JV524	1
			(Optional) <i>Teflon</i>	JV1637	1
Crank Repair Sleeve	1981-1994		Use With Part Number A505, Rear <i>Nickel Plated Formed Steel, .013" Thickness</i>	A342	1
Timing Cover Set	1989-1994			JV1035	1
	1981-1988			JV980	1
Timing Cover Seal	1989-1994			48061	1
	1981-1988			47929	1
Harmonic Balancer Repair Sleeve	1981-1988		Use With Part Number A508, Front <i>Nickel Plated Formed Steel, .013" Thickness</i>	A344	1

MISCELLANEOUS GASKETS

Air Cleaner Mount Gasket	1990-1994		Air Cleaner To Throttle Body	G30819	1
	1986-1994		Throttle Body Injection, Air Cleaner To Throttle Body	G30819	1
	1986-1988		Air Cleaner To Throttle Body	G30819	1
			Throttle Body Injection, Air Cleaner To Throttle Body	G30819	1
			Air Cleaner To Throttle Body	G30819	1
1986-1987		Throttle Body Injection, Air Cleaner To Throttle Body	G30819	1	

17 135 CID (2.2L) SOHC 4 Cyl, 3.445in./87.5mm (1981-1994)

(cont.)

17

(cont.)

Part	Year	VIN	Model/Application	Part Number	Qty.
MISCELLANEOUS GASKETS (cont.)					
Air Cleaner Mount Gasket (cont.)	1986-1987		Air Cleaner To Throttle Body	G30819	1
	1981-1987		2 Barrel Carburetor	G26129	1
	1986		Turbocharged, Air Cleaner To Throttle Body	G30819	1
			Throttle Body Injection, Air Cleaner To Throttle Body	G30819	1
		Air Cleaner To Throttle Body	G30819	1	
Cam. Circular Plug	1987-1994		Rear Plug	B45573	1
	1987		Rear	B45573	1
Camshaft Seal	1981-1994		Front	47929	1
	1981-1988		Rear <i>2.112" Outside Diameter</i>	47930	1
			Rear <i>2.061" Outside Diameter</i>	47931	1
Carb. Mount Gasket	1981-1987		2 Barrel Carburetor, Carburetor To Spacer	G25769	1
			2 Barrel Carburetor, Spacer To Insulator	G25775	1
E.G.R. Gasket	1988-1994			G24079	1
	1981-1987			G24091	1
Exhaust Pipe Gasket	1981-1994		(Ring Type 'F'), Naturally Aspirated, Pipe To Manifold	F7395	1
	1989-1990		Turbocharged, (Ring Type 'F')	F7466	1
	1981-1988		Turbocharged, (Ring Type 'F')	F7275	1
Fuel Pump Gasket	1981-1988			D24076	2
Intermediate Shaft Set	1981-1994			47929	1
Oil Pan Drain Plug Gst.	1981-1989			2051	1
Throttle Body Gasket	1986-1994		Except Turbocharged, To Manifold	G30716	1
	1989-1990		Intercooled Turbocharged Engines, To Manifold	G31044	1
	1987-1988		Intercooled Turbocharged Engines, To Air Cleaner Adapter	G30818	1
	1987		Except Intercooled Engine, Turbocharged, To Manifold	G30636	1
	1984-1986		Turbocharged, To Manifold	G30636	1
	1983-1985		Naturally Aspirated, To Manifold	G30637	1
Turbo Mounting Set	1986-1988		Except Intercooled Engine	GS33070	1
			Except Intercooled Engine, Turbocharged	GS33070	1
	1987		Except Intercooled Engine	GS33070	1
			Except Intercooled Engine, Turbocharged	GS33070	1
	1986-1987		Except Intercooled Engine	GS33070	1
1984-1985			GS33070	1	
Water Outlet Gasket	1981-1994			C25163	1
Water Pump Hsg. O-Ring	1981-1994			K30622	1
Water Pump Mount Gasket	1989-1994			K31045	1
	1981-1988			K30621	1

18 144 CID (2.4L) 4G64 SOHC 16 Valve Mitsubishi 4 Cyl, 3.405in./86.5mm (1993-1994)

18

Part	Year	VIN	Model/Application	Part Number	Qty.
ENGINE GASKETS					
Head Set	1993-1994		(Exhaust Pipe Gasket Not Included)	HS54119	1
Lower Set	1993-1994		(Requires Head Set To Make Full Set)	CS5875A	1
Cylinder Head Gasket	1993-1994		<i>Nitroseal</i>	54119G	1
Valve Cover Set	1993-1994		(Contains Spark Plug Tube Seals) <i>Victo-Tech</i>	VS50267	1
Valve Stem Seal, Exh.	1993-1994			B45870	4
Valve Stem Seal, Int.	1993-1994			B45870	4
Manifold Set, Exhaust	1993-1994		<i>Multi-Layered Steel</i>	MS16215	1
	1993			MS15392	1
Manifold Set, Intake	1993-1994			MS16250	1
Oil Pan Set	1993-1994		<i>Cork Rubber</i>	OS32137	1
Rear Main Seal Set	1993-1994			JV1646	1
Timing Cover Set	1993-1994		(Requires Oil Pan Set), Use With Part Number OS32137	JV5006	1

Chrysler

18 144 CID (2.4L) 4G64 SOHC 16 Valve Mitsubishi 4 Cyl, 3.405in./86.5mm (1993-1994) **18**
 (cont.) (cont.)

Part Year VIN Model/Application Part Number Qty.

MISCELLANEOUS GASKETS

Camshaft Seal	1993-1994		Front	47918	1
E.G.R. Gasket	1993-1994		<i>Nitroseal</i>	G30714	1
Exhaust Pipe Gasket	1993-1994		(Flange Type), Catalytic Converter To Center Pipe, Catalytic Converter To Front Exhaust Pipe	F7409	2
			Center Pipe To Muffler	F10120	1
			Pipe To Manifold	F12336	1
Spark Plug Tube Seal	1993-1994			B45881	1
Water Pipe O-Ring	1993-1994			B45797	2
Water Pump Gasket	1994			K31552	1
	1993			K30615	1
Water Pump Mount Gasket	1993			K30615	1

19 144 CID (2.4L) 4G64 SOHC 8 Valve Mitsubishi 4 Cyl, 3.405in./86.5mm (1992) **19**

Part Year VIN Model/Application Part Number Qty.

ENGINE GASKETS

Head Set	1992		(Exhaust Pipe Gasket Not Included)	HS5747W	1
Lower Set	1992		(Requires Head Set To Make Full Set), Use With Part Number HS5747X	CS5747W	1
Cylinder Head Gasket	1992		<i>Nitroseal</i>	5747	1
Valve Cover Set	1992		<i>Victo-Tech</i>	VS40003	1
			(Contains Valve Cover Grommets, Contains Camshaft Semi Circular Plug) <i>Victo-Tech</i>	VS40003CP	1
Valve Stem Seal, Exh.	1992		(Original Equipment Type)	B45441	4
Valve Stem Seal, Int.	1992		(Original Equipment Type)	B45441	4
Manifold Set, Exhaust	1992			MS15389	1
Manifold Set, Intake	1992		(Contains Plenum Chamber Gasket)	MS15387W	1
Plenum Chamber Gasket	1992			MS14902	1
Oil Pan Set	1992		<i>Cork Rubber</i>	OS32008	1
Rear Main Seal Set	1992			JV534	1
Timing Cover Set	1992		Use With Part Number OS32008	JV1036	1
Timing Cover Seal	1992			47730	1

MISCELLANEOUS GASKETS

Camshaft Seal	1992			47918	1
Cam. Semi-Circular Plug	1992			B24180	1
E.G.R. Gasket	1992		<i>Nitroseal</i>	G30714	1
Exhaust Pipe Gasket	1992		(Flange Type), Catalytic Converter To Center Pipe, Catalytic Converter To Front Exhaust Pipe	F7422	2
			Center Pipe To Muffler	F10120	1
			(Flange Type), Pipe To Manifold	F12336	1
Injector Nozzle O-Ring	1992			GS33277	1
Valve Cover Grommet	1992			B45729	2
Water Outlet Gasket	1992			C24082	1
Water Pipe O-Ring	1992			B45797	2
Water Pump Mount Gasket	1992			K30615	1

20 148 CID/2429CC (2.4L) DOHC 4 Cyl, 3.445in./87.5mm (1995-2003) **20**

Part Year VIN Model/Application Part Number Qty.

ENGINE GASKETS

Head Set	1995-2000			HS54044C	1
Lower Set	1995-2000			CS54044A	1
Engine Kit Gasket Set	1995-2000			95-3458VR	1
Cylinder Head Gasket	1995-2000		<i>Multi-Layered Steel</i>	54044A	1

20 (cont.)	148 CID/2429CC (2.4L) DOHC 4 Cyl, 3.445in./87.5mm (1995-2003)	20 (cont.)
----------------------	--	----------------------

Part	Year	VIN	Model/Application	Part Number	Qty.
ENGINE GASKETS (cont.)					
Cyl. Head Bolt Set	1995-2003			GS33343	1
Valve Cover Set	1995-2000		(Contains Spark Plug Tube Seals) <i>Victo-Tech</i>	VS50271	1
Valve Stem Seal, Exh.	1995-2003			B45844	8
Valve Stem Seal, Int.	1995-2003			B45844	8
Manifold Set, Exhaust	1995-2000			MS12448	1
Manifold Set, Intake	1995-2000		(Contains Plenum Chamber Gasket) <i>Nitroseal</i>	MS16149A	1
			(Contains Plenum Chamber Gasket)	MS16149C	1
Plenum Chamber Gasket	1995-1998			MS16178	1
Oil Pan Set	1995-2003		<i>Victo-Tech</i>	OS32155	1
Rear Main Seal Set	1995-2001		(One Piece) <i>Teflon</i>	JV1629	1
			(One Piece) <i>Rubber</i>	JV1654	1

MISCELLANEOUS GASKETS

Camshaft Seal	1995-2003		Front	48392	2
Cam Sensor O-Ring	1995-2003			GS33332	1
E.G.R. Gasket	1995-2002		Exhaust Gas Recirculation Tube	G31458	1
	1995-2001		Valve	G31321	1
Exhaust Pipe Gasket	1995-2003		(Flange Type), Pipe To Manifold	F7568	1
Spark Plug Tube Seal	1995-2003			B45838	4
Throttle Body Gasket	1995-2000			G30817	1
Water Pump Mount Gasket	1995-2003			K31502	1

21	153 CID (2.5L) SOHC 4 Cyl, 3.445in./87.5mm (1986-1995)	21
-----------	---	-----------

Part	Year	VIN	Model/Application	Part Number	Qty.
ENGINE GASKETS					
Head Set	1993-1995		(Contains Head Bolts, Exhaust Pipe Gasket Not Included)	HS5764WB2	1
	1991-1995		Stamped Steel Valve Cover, (Head Bolts Not Included, Rear Camshaft Plug Not Included, Exhaust Pipe Gasket Not Included), Naturally Aspirated	HS54097-2	1
			Aluminum Valve Cover, (Head Bolts Not Included, Rear Camshaft Plug Not Included, Exhaust Pipe Gasket Not Included), Naturally Aspirated	HS54097-3	1
	1989-1992		(Contains Head Bolts, Exhaust Pipe Gasket Not Included), Turbocharged	HS5764WB1	1
			(Head Bolts Not Included, Exhaust Pipe Gasket Not Included), Turbocharged	HS54097-1	1
	1988-1992		(Contains Head Bolts, Exhaust Pipe Gasket Not Included), Naturally Aspirated	HS3688WB2	1
	1986-1990		(Rear Camshaft Plug Not Included, Exhaust Pipe Gasket Not Included), Naturally Aspirated	HS54097-2	1
	1986-1988		(Contains Head Bolts, Exhaust Pipe Gasket Not Included, Camshaft Rear Seal Plug Not Included)	HS3688WB1	1
Lower Set	1993-1995		(Requires Head Set To Make Full Set)	CS5764	1
	1988-1995		(Requires Head Set To Make Full Set)	CS54097-2	1
	1986-1987		(Requires Head Set To Make Full Set)	CS54097-1	1
Full Set	1989-1992		(Exhaust Pipe Gasket Not Included), Turbocharged	FS5764X	1
	1988-1992		(Exhaust Pipe Gasket Not Included), Naturally Aspirated	FS3688Z	1
	1988		(Exhaust Pipe Gasket Not Included, Camshaft Rear Seal Plug Not Included)	FS3688Y	1
	1986-1987		(Exhaust Pipe Gasket Not Included, Camshaft Rear Seal Plug Not Included)	FS3688X	1
Engine Kit Gasket Set	1992-1995		(Aluminum Cover Gasket Not Included, Camshaft Rear Seal Plug Not Included), Use With Part Numbers VS50067, B45573	95-3350VR	1
	1988-1994		Stamped Steel Valve Cover, (Camshaft Rear Seal Plug Not Included), Naturally Aspirated, Use With Part Number B45573	95-3350VR	1

Chrysler

21 153 CID (2.5L) SOHC 4 Cyl, 3.445in./87.5mm (1986-1995)

(cont.)

21

(cont.)

Part Year VIN Model/Application Part Number Qty.

ENGINE GASKETS (cont.)

Engine Kit Gasket Set (cont.)	1993		(Valve Cover Set Not Included, Aluminum Cover Gasket Not Included, Camshaft Rear Seal Plug Not Included), Use With Part Numbers VS50067, B45573	95-3350VR	1
	1989-1992		Except Intercooled Engine, Turbocharged	95-3351VR	1
			Except Intercooled Engine, Turbocharged	95-3351VR	1
	1986-1987		(Oil Pan Gasket Not Included, Camshaft Rear Seal Plug Not Included), Naturally Aspirated, Use With Part Numbers B45573, OS32038	95-3350VR	1
Cylinder Head Gasket	1986-1995		<i>Nitroseal</i>	54097	1
			<i>Nitroseal, .093" Thickness</i>	54114G	1
Cyl. Head Bolt Set	1986-1995		<i>11mm</i>	GS33184	1
Cyl. Head Washer Set	1986-1995			GS33185	1
Sealing Compound	1986-1995		(4 Ounce Brush Top Can)	JV66B	1
			(12 Ounce Spray Can)	JV66S	1
Valve Cover Set	1993-1995		Stamped Steel Cover <i>Cork Rubber</i>	VS38039	1
			Aluminum Valve Cover <i>Victo-Tech</i>	VS50067	1
			Stamped Steel Cover <i>Victo-Foam</i>	VS50309	1
	1989-1992		Turbocharged <i>Victo-Tech</i>	VS50067	1
	1986-1992		Naturally Aspirated <i>Cork Rubber</i>	VS38039	1
			Naturally Aspirated <i>Victo-Foam</i>	VS50309	1
Valve Stem Seal, Exh.	1986-1995			B45449	4
Valve Stem Seal, Int.	1986-1995			B45449	4
Manifold Set, Int. & Exh.	1986-1995			MS15313	1
Oil Pan Set	1988-1995		<i>Victo-Tech</i>	OS32051	1
	1986-1987		<i>Cork Rubber</i>	OS32038	1
Rear Main Seal	1986-1995			47892	1
Rear Main Seal Set	1986-1995			JV524	1
			(Optional) <i>Teflon</i>	JV1637	1
Crank Repair Sleeve	1986-1995		Use With Part Number A505, Rear <i>Nickel Plated Formed Steel, .013" Thickness</i>	A342	1
Timing Cover Set	1986-1995			JV1035	1
Timing Cover Seal	1986-1995			48061	1

MISCELLANEOUS GASKETS

Air Cleaner Mount Gasket	1986-1992		Naturally Aspirated	G30819	1
	1987-1989		Throttle Body Injection, Naturally Aspirated	G30819	1
	1986-1989		Naturally Aspirated	G30819	1
	1986-1987		Throttle Body Injection	G30819	1
Cam. Circular Plug	1987-1995		Rear Plug	B45573	1
Camshaft Seal	1986-1995		Front	47929	1
			Rear <i>2.112" Outside Diameter</i>	47930	1
			Rear <i>2.061" Outside Diameter</i>	47931	1
E.G.R. Gasket	1988-1995		Valve	G24079	1
			Exhaust Gas Recirculation Tube	G26703	1
	1986-1987			G24091	1
Exhaust Pipe Gasket	1986-1993		Except Turbocharged, (Ring Type 'F'), Pipe To Manifold	F7395	1
	1989-1992		(Ring Type 'F'), Turbocharged, Pipe To Manifold	F7466	1
	1986-1988		(Ring Type 'F'), Pipe To Manifold	F7395	1
Fuel Pump Gasket	1986-1988			D24076	2
Injector Nozzle O-Ring	1989-1992			GS33276	2
Intermediate Shaft Set	1986-1995			47929	1
Oil Pan Drain Plug Gst.	1986-1990			2051	1
Throttle Body Gasket	1986-1995		Except Turbocharged, Throttle Body To Intake Manifold	G30716	1
	1989-1992		Turbocharged, Throttle Body To Intake Manifold	G31044	1
Water Outlet Gasket	1986-1995			C25163	1

21 (cont.)	153 CID (2.5L) SOHC 4 Cyl, 3.445in./87.5mm (1986-1995)					21 (cont.)
----------------------	---	--	--	--	--	----------------------

Part	Year	VIN	Model/Application	Part Number	Qty.
MISCELLANEOUS GASKETS (cont.)					
Water Pump Hsg. O-Ring	1986-1995			K30622	1
Water Pump Mount Gasket	1988-1995			K31045	1
	1986-1988			K30621	1

22	153 CID (2.5L) SOHC Flex Fuel 4 Cyl, 3.445in./87.5mm (1993-1994)					22
-----------	---	--	--	--	--	-----------

Part	Year	VIN	Model/Application	Part Number	Qty.
ENGINE GASKETS					
Head Set	1993-1994		(Contains Head Bolts, Exhaust Pipe Gasket Not Included)	HS5764WB2	1
			Stamped Steel Valve Cover, (Head Bolts Not Included, Rear Camshaft Plug Not Included, Exhaust Pipe Gasket Not Included), Naturally Aspirated	HS54097-2	1
			Aluminum Valve Cover, (Head Bolts Not Included, Rear Camshaft Plug Not Included, Exhaust Pipe Gasket Not Included), Naturally Aspirated	HS54097-3	1
Lower Set	1993-1994		(Requires Head Set To Make Full Set)	CS5764	1
			(Requires Head Set To Make Full Set)	CS54097-2	1
Cylinder Head Gasket	1993-1994		Nitroseal	54097	1
			Nitroseal, .093" Thickness	54114G	1
Cyl. Head Bolt Set	1993-1994		11mm	GS33184	1
Cyl. Head Washer Set	1993-1994			GS33185	1
Valve Cover Set	1993-1994		Stamped Steel Cover Cork Rubber	VS38039	1
			Aluminum Valve Cover Victo-Tech	VS50067	1
			Stamped Steel Cover Victo-Foam	VS50309	1
Valve Stem Seal, Exh.	1993-1994			B45449	4
Valve Stem Seal, Int.	1993-1994			B45449	4
Manifold Set, Int. & Exh.	1993-1994			MS15313	1
Oil Pan Set	1993-1994		Victo-Tech	OS32051	1
Rear Main Seal	1993-1994			47892	1
Rear Main Seal Set	1993-1994			JV524	1
			(Optional) Teflon	JV1637	1
Crank Repair Sleeve	1993-1994		Use With Part Number A505, Rear Nickel Plated Formed Steel, .013" Thickness	A342	1
Timing Cover Set	1993-1994			JV1035	1
Timing Cover Seal	1993-1994			48061	1

MISCELLANEOUS GASKETS

Cam. Circular Plug	1993-1994		Rear Plug	B45573	1
Camshaft Seal	1993-1994		Front	47929	1
E.G.R. Gasket	1993-1994		Valve	G24079	1
			Exhaust Gas Recirculation Tube	G26703	1
Intermediate Shaft Set	1993-1994			47929	1
Water Outlet Gasket	1993-1994			C25163	1
Water Pump Hsg. O-Ring	1993-1994			K30622	1
Water Pump Mount Gasket	1993-1994			K31045	1

23	2497CC (2.5L) EEB Mitsubishi V6 Cyl, 3.290in./83.5mm (1995-2000)					23
-----------	---	--	--	--	--	-----------

Part	Year	VIN	Model/Application	Part Number	Qty.
ENGINE GASKETS					
Head Set	1998-2000		(Head Bolts Not Included)	HS54248	1
	1995-1997		(Head Bolts Not Included)	HS54150	1
Lower Set	1995-2000		(Requires Head Set To Make Full Set)	CS54150	1
Cylinder Head Gasket	1998-2000		Multi-Layered Steel	54248	2
	1995-1997		Nitroseal	54150G	2

Chrysler

23 (cont.)	2497CC (2.5L) EEB Mitsubishi V6 Cyl, 3.290in./83.5mm (1995-2000)				23 (cont.)
----------------------	---	--	--	--	----------------------

Part	Year	VIN	Model/Application	Part Number	Qty.
ENGINE GASKETS (cont.)					
Valve Cover Set	1995-2000		(Contains Spark Plug Tube Seals) <i>Victo-Tech</i>	VS50270	1
Valve Stem Seal, Exh.	1995-2000			B45870A	12
Valve Stem Seal, Int.	1995-2000			B45870A	12
Manifold Set, Intake	1995-2000		(Contains Plenum Chamber Gasket)	MS16266	1
Plenum Chamber Gasket	1995-2000			MS16279	1
Oil Pan Set	1995-2000		<i>Cork Rubber</i>	OS32193	1

MISCELLANEOUS GASKETS					
Camshaft Seal	1995-2000		Front	47918	2
E.G.R. Gasket	1997-2000	N	Exhaust Gas Recirculation Tube	G31554	2
	1995-2000	N	Valve	G24079	1
		H	Valve	G31321	1
		H	Exhaust Gas Recirculation Tube	G31458	2
	1995-1996	N	Exhaust Gas Recirculation Tube	G31474	2
Exhaust Pipe Gasket	1995-2000	H	(Flange Type), Pipe To Manifold	F7568	1
	1998-1999	N	California Emission, (Flange Type), Catalytic Converter To Center Pipe, Catalytic Converter To Front Exhaust Pipe, Pre-Catalytic Converter To Exhaust Pipe	F7409	4
		N	Except California Emission, (Flange Type), Catalytic Converter To Center Pipe, Catalytic Converter To Front Exhaust Pipe, Pipe To Manifold	F7409	4
	1995-1997	N	(Flange Type), Catalytic Converter To Center Pipe, Catalytic Converter To Front Exhaust Pipe, Pipe To Manifold	F7409	4
Injector Nozzle O-Ring	1995-2000			GS33339	1
Spark Plug Tube Seal	1995-2000			B45881-A	1
Therm. Housing Gasket	1995-2000		Housing To Head	C31509	2
Throttle Body Gasket	1995-2000			G31553	1
Water Outlet Gasket	1995-2000		Water Outlet To Thermostat Case	C31507	1

24	156 CID (2.6L) SOHC "F" Mitsubishi 4 Cyl, 3.587in./91.1mm (1978-1989)				24
-----------	--	--	--	--	-----------

Part	Year	VIN	Model/Application	Part Number	Qty.
ENGINE GASKETS					
Head Set	1984-1989		(Exhaust Pipe Gasket Not Included), Turbocharged/Intercooled	HS3697T	1
	1981-1985		Front Wheel Drive, (Exhaust Pipe Gasket Not Included)	HS3697	1
	1981-1983		Rear Wheel Drive, (Exhaust Pipe Gasket Not Included, Exhaust Manifold Gasket For Canada Not Included)	HS3697W	1
	1978-1980		Rear Wheel Drive, (Exhaust Pipe Gasket Not Included)	HS3673	1
Full Set	1984-1989		(Exhaust Pipe Gasket Not Included), Turbocharged/Intercooled	FS3697T	1
	1981-1985		Front Wheel Drive, (Exhaust Pipe Gasket Not Included)	FS3697	1
	1981-1983		Rear Wheel Drive, (Exhaust Pipe Gasket Not Included, Exhaust Manifold Gasket For Canada Not Included)	FS3697W	1
	1978-1980		Rear Wheel Drive, (Exhaust Pipe Gasket Not Included)	FS3673	1
Engine Kit Gasket Set	1984-1989		Turbocharged/Intercooled	95-3190VR	1
	1981-1986		Front Wheel Drive, Naturally Aspirated	95-3103VR	1
	1980-1983		Rear Wheel Drive	95-3104VR	1
Cylinder Head Gasket	1981-1989		<i>VR2000</i>	3697	1
	1978-1980			3673	1
Cyl. Head Bolt Set	1978-1989			GS33325	1
Cyl. Head Spacer Shim	1981-1989		Requires Sealing Compound	<i>Steel</i> 3697S	1
	1978-1980		Requires Sealing Compound	<i>Steel</i> 3673S	1
Sealing Compound	1978-1989		(4 Ounce Brush Top Can)	JV66B	1
			(12 Ounce Spray Can)	JV66S	1
Valve Cover Set	1981-1989		<i>Victo-Tech</i>	VS39865	1

24 156 CID (2.6L) SOHC "F" Mitsubishi 4 Cyl, 3.587in./91.1mm (1978-1989)

24
(cont.)

Part	Year	VIN	Model/Application	Part Number	Qty.
ENGINE GASKETS (cont.)					
Valve Cover Set (cont.)	1981-1989		(Valve Cover Grommets Included, Contains Camshaft Semi Circular Plug)	<i>Victo-Tech</i> VS39865CP	1
	1978-1980			<i>Victo-Tech</i> VS39860	1
Valve Stem Seal, Exh.	1978-1989		(Original Equipment Type)	B45441	4
			(Premium)	B45806	4
Valve Stem Seal, Int.	1978-1989		(Original Equipment Type)	B45441	4
			(Premium)	B45806	4
Manifold Set, Exhaust	1986-1989		Turbocharged/Intercooled	MS15396	1
	1984-1985		Front Wheel Drive	MS15299	1
			Rear Wheel Drive, Turbocharged	MS15396	1
	1981-1985		Front Wheel Drive, To Be Replaced By MS15299	MS15526	1
	1981-1983		Canadian Models, Rear Wheel Drive	MS15298	1
				MS15299	1
Manifold Set, Intake	1981-1989		<i>Performaseal</i>	MS15320	1
	1978-1980			MS15295	1
Oil Pan Set	1978-1989		<i>Cork Rubber</i>	OS20776	1
Rear Main Seal Set	1981-1989			JV534	1
	1978-1980			JV507	1
Crank Repair Sleeve	1978-1989		Use With Part Number A512, Rear <i>Nickel Plated Formed Steel, .013" Thickness</i>	A346	1
Timing Cover Set	1978-1989			JV943	1
Timing Cover Gasket	1978-1989			T26234	1
Timing Cover Seal	1979-1989			47735	1
Harmonic Balancer Repair Sleeve	1978-1989		Use With Part Number A500, Front <i>Nickel Plated Formed Steel, .013" Thickness</i>	A238	1
MISCELLANEOUS GASKETS					
Air Cleaner Mount Gasket	1981-1985			G24090	1
			Naturally Aspirated	G24965	1
Air Flow Sensor	1989			G30807	1
Cam. Circular Plug	1981-1989			B45685	1
Camshaft Seal	1981-1985		Front Wheel Drive	47919	1
Cam. Semi-Circular Plug	1978-1989			B24180	1
Carb. Mount Gasket	1982-1985		Except Canadian Models	G25771	1
			Canadian Models	G30619	1
	1981			G25771	1
	1978-1980			G25784	1
E.G.R. Gasket	1978-1989			G24078	1
Exhaust Pipe Gasket	1987-1989		Conquest, (Ring Type 'F'), Pipe To Converter	F12368	1
	1984-1989		Conquest, (Flange Type), Turbocharged/Intercooled, Catalytic Converter To Center Pipe	F7409	1
			(Ring Type 'F'), Pipe To Manifold	F7395	1
	1981-1985		Challenger, Sapporo, Except Canadian Models, (Flange Type), Pipe To Manifold	F7409	1
			Challenger, Sapporo, Canadian Models, (Flange Type), Pipe To Manifold	F12287	1
	1980		Arrow, Colt, (Flange Type), Pipe To Manifold	F12287	1
Fuel Inj. Mixer Gasket	1984-1989		Turbocharged/Intercooled	G30639	1
Fuel Pump Gasket	1978-1989			D24076	2
Turbo Mounting Set	1984-1989			GS33077	1
Valve Cover Grommet	1978-1989			B45729	2
Water Outlet Gasket	1978-1989			C24082	1
Water Pipe O-Ring	1981-1989			B45797	1
Water Pump Mount Gasket	1984-1989		Conquest, Rear Wheel Drive, Turbocharged/Intercooled	K26487	1
	1981-1985		Front Wheel Drive	K26326	1

Chrysler

24 (cont.)	156 CID (2.6L) SOHC "F" Mitsubishi 4 Cyl, 3.587in./91.1mm (1978-1989)				24 (cont.)
----------------------	--	--	--	--	----------------------

Part	Year	VIN	Model/Application	Part Number	Qty.
------	------	-----	-------------------	-------------	------

MISCELLANEOUS GASKETS (cont.)

Water Pump Mount Gasket (cont.)	1978-1983		Rear Wheel Drive	K26487	1
---------------------------------	-----------	--	------------------	--------	---

25	167 CID/2736CC (2.7L) DOHC V6 Cyl, 3.386in./86mm (1998-2003)				25
-----------	---	--	--	--	-----------

Part	Year	VIN	Model/Application	Part Number	Qty.
------	------	-----	-------------------	-------------	------

ENGINE GASKETS

Head Set	2001-2003			HS54230	1
	1998-2000			HS54230A	1
Lower Set	1998-2001		(Requires Head Set To Make Full Set)	CS54230	1
Cylinder Head Gasket	1998-2003		Left <i>Multi-Layered Steel</i>	54230	1
			Right <i>Multi-Layered Steel</i>	54231	1
Cyl. Head Bolt Set	1998-2003			GS33366	2
Valve Cover Set	2001-2003		(Spark Plug Tube Seals Not Included) <i>Victo-Tech</i>	VS50246	1
	1998-2000		(Spark Plug Tube Seals Not Included) <i>Victo-Tech</i>	VS50319	1
Valve Stem Seal, Exh.	1998-2003			B45861	12
Valve Stem Seal, Int.	1998-2003			B45861	12
Manifold Set, Exhaust	1998-2002		<i>Steel</i>	MS16237	1
Manifold Set, Intake	1998-2003		(Plenum Chamber Gasket Not Included) <i>Victo-Tech</i>	MS16211	1
Plenum Chamber Gasket	1998-2003		<i>Victo-Tech</i>	MS16212	1
Oil Pan Set	1998-2003		(Timing Cover Gasket Not Included)	OS32156	1
Rear Main Seal Set	1998-2003			JV1643	1
Timing Cover Gasket	1998-2002			T31531	1
Timing Cover Seal	1998-2003			JV5000	1

MISCELLANEOUS GASKETS

Fuel Inj. O-Ring	1998-2003			GS33276	3
Spark Plug Tube Seal	1998-2003			B45862	6
Throttle Body Gasket	1998-2003			G31529	1
Water Pump Mount Gasket	1998-2003			K31530	1

26	167 CID/2736CC (2.7L) DOHC Flex Fuel V6 Cyl, 3.386in./86mm (2003)				26
-----------	--	--	--	--	-----------

Part	Year	VIN	Model/Application	Part Number	Qty.
------	------	-----	-------------------	-------------	------

ENGINE GASKETS

Head Set	2003			HS54230	1
Cylinder Head Gasket	2003		Left <i>Multi-Layered Steel</i>	54230	1
			Right <i>Multi-Layered Steel</i>	54231	1
Cyl. Head Bolt Set	2003			GS33366	2
Valve Cover Set	2003		(Spark Plug Tube Seals Not Included) <i>Victo-Tech</i>	VS50246	1
Valve Stem Seal, Exh.	2003			B45861	12
Valve Stem Seal, Int.	2003			B45861	12
Manifold Set, Intake	2003		(Plenum Chamber Gasket Not Included) <i>Victo-Tech</i>	MS16211	1
Plenum Chamber Gasket	2003		<i>Victo-Tech</i>	MS16212	1
Oil Pan Set	2003		(Timing Cover Gasket Not Included) <i>Victo-Tech</i>	OS32156	1
Rear Main Seal Set	2003			JV1643	1
Timing Cover Seal	2003			JV5000	1

MISCELLANEOUS GASKETS

Fuel Inj. O-Ring	2003			GS33276	3
Spark Plug Tube Seal	2003			B45862	6
Throttle Body Gasket	2003			G31529	1
Water Pump Mount Gasket	2003			K31530	1

27 170 CID (2.8L) OHV 6 Cyl, 3.400in./86.4mm (1960-1969)

27

Part	Year	VIN	Model/Application	Part Number	Qty.
ENGINE GASKETS					
Head Set	1960-1969			HS1162VE	1
Full Set	1960-1969			FS1162VE	1
Engine Kit Gasket Set	1960-1969		Except Aluminum Engine	95-3001VR	1
Cylinder Head Gasket	1960-1969		VR2000	1162VC	1
Valve Cover Set	1960-1969		Cork Rubber	VS39745	1
Valve Stem Seal, Exh.	1960-1969			B45327	6
Valve Stem Seal, Int.	1960-1969			B45298	6
Manifold Set, Int. & Exh.	1960-1969			MS16030	1
Oil Pan Set	1960-1969		Cork Rubber	OS30920X	1
Rear Main Seal Set	1960-1969		Rubber	JV607	1
Timing Cover Set	1960-1969			JV814	1
			(Contains Repair Sleeve)	JV923	1
Timing Cover Gasket	1961-1969			T28762	1
Timing Cover Seal	1960-1969			64572	1
Harmonic Balancer Repair Sleeve	1960-1969		Ground Steel, .020" Thickness	66593RS	1
			Nickel Plated Formed Steel, .013" Thickness	A223-1	1

MISCELLANEOUS GASKETS

Air Cleaner Mount Gasket	1961-1969		1 Barrel Carburetor	G25936	1
Carb. Mount Gasket	1963-1969		1 Barrel Carburetor	G7173	1
	1961-1965		1 Barrel Carburetor, Positive Vent, 1 Barrel Carburetor	G7173	1
	1962		1 Barrel Carburetor	G7173	1
Exhaust Pipe Gasket	1965-1969		(Flange Type), Pipe To Manifold	F5495C	2
	1960-1964		(Flange Type), Pipe To Manifold	F5438AK	1
Fuel Pump Gasket	1960-1969			D27094	1
Oil Filter Cover Seal	1966-1969			72239	1
Oil Pan Drain Plug Gst.	1960-1969			2051	1
Oil Pump Body Gasket	1960-1969			B26477	1
Spark Plug Tube Seal	1960-1969			B45384	6
Water Outlet Gasket	1960-1969			C24109	1
Water Pump Backing Plate	1960-1969			K27564	1
Water Pump Mount Gasket	1960-1969			K27564	1

28 181 CID (3.0L) DOHC Mitsubishi V6 Cyl, 3.587in./91.1mm (1991-1996)

28

Part	Year	VIN	Model/Application	Part Number	Qty.
ENGINE GASKETS					
Head Set	1991-1993		(Turbo Mounting Gaskets Not Included)	HS54144	1
Lower Set	1991-1992		(Requires Head Set To Make Full Set)	CS54144	1
Cylinder Head Gasket	1991-1993		Nitroseal	54144G	2
Cyl. Head Bolt Set	1991-1996			GS33327	1
Valve Cover Set	1991-1996		(Contains Spark Plug Tube Seals) Victo-Tech	VS50269	1
Valve Stem Seal, Exh.	1994-1996			B45622	12
	1991-1993			B45883	12
Valve Stem Seal, Int.	1994-1996			B45622	12
	1991-1993			B45883	12
Manifold Set, Exhaust	1991-1996			MS16265	1
Manifold Set, Intake	1991-1996		(Contains Plenum Chamber Gasket)	MS16264A	1
Plenum Chamber Gasket	1991-1996			MS16232	1
Oil Pan Set	1991-1992		Cork Rubber	OS32054	1
Rear Main Seal Set	1991-1996		Teflon	JV1062	1
				JV1637	1

Chrysler

28 181 CID (3.0L) DOHC Mitsubishi V6 Cyl, 3.587in./91.1mm (1991-1996) **28**
(cont.) (cont.)

Part	Year	VIN	Model/Application	Part Number	Qty.
MISCELLANEOUS GASKETS					
E.G.R. Gasket	1995-1996		Turbocharged, Valve <i>Nitroseal</i>	G30714	1
Exhaust Pipe Gasket	1994-1996		Front Wheel Drive, (Flange Type), Catalytic Converter To Front Exhaust Pipe, Pipe To Manifold	F7409	3
			Front Wheel Drive, (Flange Type), Right Converter Assembly	F7409	1
	1991-1996		All Wheel Drive, (Flange Type), Right Converter Assembly	F7409	1
	1991-1993		All Wheel Drive, (Flange Type), Pipe To Manifold	F7409	2
			Front Wheel Drive, (Flange Type), Catalytic Converter To Center Pipe, Pipe To Manifold	F7409	3
Spark Plug Tube Seal	1991-1993			B45884	1
Throttle Body Gasket	1991-1996			G31547	1
Water Inlet Gasket	1991-1996			C31507	1
Water Outlet Gasket	1991-1996		Cylinder Head Water Hole, Thermostat Case To Cylinder Head	C24219	3
Water Pump Mount Gasket	1991-1996			K31555	1

29 181 CID (3.0L) SOHC Mitsubishi V6 Cyl, 3.587in./91.1mm (1988-1996) **29**

Part	Year	VIN	Model/Application	Part Number	Qty.
ENGINE GASKETS					
Head Set	1991-1996		Stealth, (Exhaust Pipe Gasket Not Included)	HS5765-3	1
	1990-1995		Lebaron, Spirit, (Exhaust Pipe Gasket Not Included)	HS5765-1	1
	1989-1995		Acclaim, (Exhaust Pipe Gasket Not Included)	HS5765-1	1
	1992-1994		Shadow, Sundance, (Exhaust Pipe Gasket Not Included)	HS5765-1	1
	1990-1993		Daytona, (Exhaust Pipe Gasket Not Included)	HS5765-1	1
	1988-1993		Dynasty, (Exhaust Pipe Gasket Not Included)	HS5765-1	1
	1990-1991		TC, (Exhaust Pipe Gasket Not Included)	HS5765-1	1
	1988-1990		New Yorker, (Exhaust Pipe Gasket Not Included)	HS5765-1	1
Lower Set	1988-1996		(Requires Head Set To Make Full Set)	CS5765-1	1
Engine Kit Gasket Set	1988-1996		Multi-Port Fuel Injection	95-3192VR	1
Cylinder Head Gasket	1988-1996		<i>Nitroseal</i>	5765	2
Cyl. Head Bolt Set	1988-1996			GS33327	1
Cyl. Head Spacer Shim	1988-1996		Requires Sealing Compound <i>Steel</i>	5765S	2
Sealing Compound	1988-1996		(4 Ounce Brush Top Can)	JV66B	1
			(12 Ounce Spray Can)	JV66S	1
Valve Cover Set	1988-1996		(Contains Valve Cover Grommets) <i>Victo-Tech</i>	VS50054	1
			(Valve Cover Grommets Not Included, Camshaft Circular Plug Not Included) <i>Victo-Tech</i>	VS50256	1
			(Contains Valve Cover Grommets, Contains Camshaft Circular Plugs) <i>Victo-Tech</i>	VS50257	1
Valve Stem Seal, Exh.	1988-1996		<i>Fluoroelastomer</i>	B45790	6
Valve Stem Seal, Int.	1988-1996		<i>Fluoroelastomer</i>	B45790	6
Manifold Set, Exhaust	1988-1996			MS15543	1
Manifold Set, Intake	1991-1996		Stealth, (Contains Plenum Chamber Gasket)	MS15444Z	1
	1990-1995		Lebaron, Spirit, (Contains Plenum Chamber Gasket)	MS15444	1
	1989-1995		Acclaim, (Contains Plenum Chamber Gasket)	MS15444	1
	1992-1994		Shadow, Sundance, (Contains Plenum Chamber Gasket)	MS15444	1
	1990-1993		Daytona, (Contains Plenum Chamber Gasket)	MS15444	1
	1988-1993		Dynasty, (Contains Plenum Chamber Gasket)	MS15444	1
	1990-1991		TC, (Contains Plenum Chamber Gasket)	MS15444	1
	1988-1990		New Yorker, (Contains Plenum Chamber Gasket)	MS15444	1
Plenum Chamber Gasket	1988-1996			MS12342	1
Oil Pan Set	1988-1996		<i>Cork Rubber</i>	OS32054	1
Rear Main Seal Set	1988-1996			JV1062	1
Crank Repair Sleeve	1988-1996		Use With Part Number A505, Rear <i>Nickel Plated Formed Steel, .013" Thickness</i>	A342	1

29 (cont.)	181 CID (3.0L) SOHC Mitsubishi V6 Cyl, 3.587in./91.1mm (1988-1996)				29 (cont.)
----------------------	---	--	--	--	----------------------

Part	Year	VIN	Model/Application	Part Number	Qty.
------	------	-----	-------------------	-------------	------

ENGINE GASKETS (cont.)

Crank Repair Sleeve (cont.)	1988-1996		Front <i>Nickel Plated Formed Steel, .013" Thickness</i>	A357	1
Timing Cover Set	1988-1996			JV565	1

MISCELLANEOUS GASKETS

Cam. Circular Plug	1988-1996			B45682	2
Camshaft Seal	1988-1996			47918	2
E.G.R. Gasket	1988-1995			G30824	1
Exhaust Pipe Gasket	1989-1996		(Ring Type 'F'), Pipe To Manifold	F7466	1
	1988-1996		(Flange Type), Crossover Pipe	F7278	2
	1988		(Ring Type 'F'), Pipe To Manifold	F7275	1
Fuel Pump Gasket	1988-1996			D24076	2
Injector Nozzle O-Ring	1991-1996			GS33277	1
	1988-1995			GS33275	1
Throttle Body Gasket	1991-1996			G31558	1
	1988-1995			G31044	1
	1988			G30817	1
Valve Cover Grommet	1988-1996			B45729	4
Water Outlet Gasket	1988-1995			C24082	1
Water Pipe O-Ring	1988-1996			B45797	2
Water Pump Mount Gasket	1988-1996		Adapter To Block	K30816	1
			Pump To Adapter	K31160	1

30	181 CID/2972CC (3.0L) EF7 SOHC Mitsubishi V6 Cyl, 3.587in./91.1mm (2001-2003)				30
-----------	--	--	--	--	-----------

Part	Year	VIN	Model/Application	Part Number	Qty.
------	------	-----	-------------------	-------------	------

ENGINE GASKETS

Valve Cover Set	2001-2003		(Contains Spark Plug Tube Seals)	VS50270	1
Valve Stem Seal, Exh.	2001-2003			B45870A	12
Valve Stem Seal, Int.	2001-2003			B45870A	12
Manifold Set, Exhaust	2001-2003			MS16267	1
Manifold Set, Intake	2001-2002		(Contains Plenum Chamber Gasket)	MS16266	1
Plenum Chamber Gasket	2001-2003			MS16279	1

MISCELLANEOUS GASKETS

Camshaft Seal	2001-2003		Front	47918	2
E.G.R. Gasket	2001-2003		Valve	<i>Nitroseal</i> G30714	1
Injector Nozzle O-Ring	2001-2003			GS33339	1
Spark Plug Tube Seal	2001-2003			B45881-A	1
Therm. Housing Gasket	2001-2003		Housing To Head	C31509	2
Throttle Body Gasket	2001-2003			G31567	1
Water Outlet Gasket	2001-2002		Water Outlet To Thermostat Case	C31507	1

31	197 CID (3.2L) EGW SOHC V6 Cyl, 3.622in./92mm (1998-2001)				31
-----------	--	--	--	--	-----------

Part	Year	VIN	Model/Application	Part Number	Qty.
------	------	-----	-------------------	-------------	------

ENGINE GASKETS

Head Set	1998-2001		(Head Bolts Not Included)	HS5978A	1
Lower Set	1998-2001		(Requires Head Set To Make Full Set)	CS5978A	1
Cylinder Head Gasket	1998-2001		Right	54112	1
			Left	54113	1
Valve Cover Set	1998-2001		(Plenum Chamber Gasket Not Included)	<i>Victo-Tech</i> VS50248	1
Valve Stem Seal, Exh.	1998-2001			B45832	12
Valve Stem Seal, Int.	1998-2001			B45832	12
Manifold Set, Intake	1998-2001		(Plenum Chamber Gasket Not Included)	<i>Victo-Tech</i> MS16210	1

Chrysler

31 (cont.)	197 CID (3.2L) EGW SOHC V6 Cyl, 3.622in./92mm (1998-2001)				31 (cont.)
----------------------	--	--	--	--	----------------------

Part	Year	VIN	Model/Application	Part Number	Qty.
ENGINE GASKETS (cont.)					
Plenum Chamber Gasket	1998-2001		<i>Victo-Tech</i>	MS16508	1
Rear Main Seal Set	1998-2001			JV1642	1
Timing Cover Seal	1998-2001			48061	1

MISCELLANEOUS GASKETS					
E.G.R. Gasket	1998-2001		Valve	G31321	1
			Tube Valve End	G31458	1
Injector Nozzle O-Ring	1998-2001			GS33276	3
Spark Plug Tube Seal	1998-2001		<i>Victo-Tech</i>	B45848	6
Throttle Body Gasket	1998-2001			G31532	1

32	198 CID (3.2L) OHV 6 Cyl, 3.400in./86.4mm (1970-1974)				32
-----------	--	--	--	--	-----------

Part	Year	VIN	Model/Application	Part Number	Qty.
ENGINE GASKETS					
Head Set	1970-1974			HS1162VE	1
Full Set	1970-1974			FS1162VE	1
Engine Kit Gasket Set	1970-1974		Except Aluminum Engine	95-3001VR	1
Cylinder Head Gasket	1970-1974		<i>VR2000</i>	1162VC	1
Valve Cover Set	1970-1974		<i>Cork Rubber</i>	VS39745	1
Valve Stem Seal, Exh.	1970-1974			B45327	6
Valve Stem Seal, Int.	1970-1974			B45298	6
Manifold Set, Int. & Exh.	1970-1974			MS16030	1
Oil Pan Set	1970-1974		<i>Cork Rubber</i>	OS30920X	1
Rear Main Seal Set	1970-1974		<i>Rubber</i>	JV607	1
Timing Cover Set	1970-1974			JV814	1
			(Contains Repair Sleeve)	JV923	1
Timing Cover Gasket	1970-1974			T28762	1
Timing Cover Seal	1970-1974			64572	1
Harmonic Balancer Repair Sleeve	1970-1974		<i>Ground Steel, .020" Thickness</i>	66593RS	1
			<i>Nickel Plated Formed Steel, .013" Thickness</i>	A223-1	1

MISCELLANEOUS GASKETS					
Air Cleaner Mount Gasket	1970-1974		1 Barrel Carburetor	G26540	1
Carb. Mount Gasket	1974		1 Barrel Carburetor	G25456	1
	1973		1 Barrel Carburetor	G25457	1
	1970-1972		1 Barrel Carburetor	G24105	1
E.G.R. Gasket	1973-1974			G24079	1
Exhaust Pipe Gasket	1970-1974		(Flange Type), Pipe To Manifold	F5495C	2
Fuel Pump Gasket	1970-1974			D27094	1
				<i>Tuff-Cork</i> D27094TC	1
Oil Filter Cover Seal	1970-1974			72239	1
Oil Pan Drain Plug Gst.	1970-1974			2051	1
Oil Pump Body Gasket	1970-1974			B26477	1
Spark Plug Tube Seal	1970-1974			B45384	6
Water Outlet Gasket	1970-1974			C24109	1
Water Pump Mount Gasket	1970-1974			K27564	1

33	201 CID (3.3L) V6 Cyl, 3.661in./93mm (1990-1997)				33
-----------	---	--	--	--	-----------

Part	Year	VIN	Model/Application	Part Number	Qty.
ENGINE GASKETS					
Head Set	1990-1997		(Head Bolts Not Included, Exhaust Pipe Gasket Not Included, Intake Manifold Gasket Not Included)	HS5892	1

33 201 CID (3.3L) V6 Cyl, 3.661in./93mm (1990-1997)**33**

(cont.)

(cont.)

Part	Year	VIN	Model/Application	Part Number	Qty.
ENGINE GASKETS (cont.)					
Head Set (cont.)	1990-1997		(Contains Head Bolts, Exhaust Pipe Gasket Not Included, Intake Manifold Gasket Not Included)	HS5892WB	1
Lower Set	1990-1997		(Requires Head Set To Make Full Set)	CS5896	1
Full Set	1990-1997		(Head Bolts Not Included, Exhaust Pipe Gasket Not Included, Intake Manifold Gasket Not Included)	FS5892	1
Engine Kit Gasket Set	1990-1997		(Intake Manifold Gasket Not Included), Use With Part Number MS15984	95-3446VR	1
Cylinder Head Gasket	1990-1997	Left	Nitroseal	5985G	1
		Right	Nitroseal	5986G	1
Cyl. Head Bolt Set	1997		(Contains Washers)	GS33360	2
	1990-1996			GS33251	2
Cyl. Head Washer Set	1990-1996			GS33256	16
Cyl. Head Spacer Shim	1990-1997	Requires Sealing Compound, Left		Steel 5892S	1
		Requires Sealing Compound, Right		Steel 5893S	1
Sealing Compound	1990-1997	(4 Ounce Brush Top Can)		JV66B	1
		(12 Ounce Spray Can)		JV66S	1
Valve Cover Set	1990-1997			Victo-Tech VS50143R	1
				Tuff-Cork VS50143TC	1
Valve Stem Seal, Exh.	1990-1997			B45449	6
Valve Stem Seal, Int.	1990-1997			B45449	6
Manifold Set, Exhaust	1990-1997			MS12399	1
Manifold Set, Intake	1990-1997		(Contains Plenum Chamber Gasket)	MS15984	1
Plenum Chamber Gasket	1990-1997			MS16300	1
Oil Pan Set	1990-1997			Tuff-Cork OS32103TC	1
				Victo-Tech OS32111	1
Rear Main Seal	1990-1997			47892	1
Rear Main Seal Set	1990-1997			JV1600	1
Timing Cover Set	1990-1997		(Requires Oil Pan Set)	JV1124	1
Timing Cover Seal	1990-1997			48061	1

MISCELLANEOUS GASKETS

E.G.R. Gasket	1990-1997	Valve		G24079	1
		Exhaust Gas Recirculation Tube		G30824	1
Exhaust Pipe Gasket	1990-1993	(Ring Type 'F'), Pipe To Manifold		F7466	1
		(Flange Type), Crossover Pipe		F12380	2
Injector Nozzle O-Ring	1990-1997			GS33276	3
Throttle Body Gasket	1990-1997			G30817	1
Water Outlet Gasket	1990-1997			C25163	1
Water Pump Mount Gasket	1990-1997			K31177	1

34 201 CID (3.3L) Flex Fuel V6 Cyl, 3.661in./93mm (1994-1995)**34**

Part	Year	VIN	Model/Application	Part Number	Qty.
ENGINE GASKETS					
Head Set	1994-1995	(Head Bolts Not Included, Exhaust Pipe Gasket Not Included, Intake Manifold Gasket Not Included)		HS5892	1
		(Contains Head Bolts, Exhaust Pipe Gasket Not Included, Intake Manifold Gasket Not Included)		HS5892WB	1
Lower Set	1994-1995		(Requires Head Set To Make Full Set)	CS5896	1
Full Set	1994-1995		(Head Bolts Not Included, Exhaust Pipe Gasket Not Included, Intake Manifold Gasket Not Included)	FS5892	1
Engine Kit Gasket Set	1994-1995		(Intake Manifold Gasket Not Included), Use With Part Number MS15984	95-3446VR	1
Cylinder Head Gasket	1994-1995	Left	Nitroseal	5985G	1
		Right	Nitroseal	5986G	1
Cyl. Head Bolt Set	1994-1995			GS33251	2

Chrysler

34 (cont.)	201 CID (3.3L) Flex Fuel V6 Cyl, 3.661in./93mm (1994-1995)					34 (cont.)
----------------------	---	--	--	--	--	----------------------

<i>Part</i>	<i>Year</i>	<i>VIN</i>	<i>Model/Application</i>	<i>Part Number</i>	<i>Qty.</i>
ENGINE GASKETS (cont.)					
Cyl. Head Washer Set	1994-1995			GS33256	16
Cyl. Head Spacer Shim	1994-1995		Requires Sealing Compound, Left	<i>Steel</i> 5892S	1
			Requires Sealing Compound, Right	<i>Steel</i> 5893S	1
Sealing Compound	1994-1995		(4 Ounce Brush Top Can)	JV66B	1
			(12 Ounce Spray Can)	JV66S	1
Valve Cover Set	1994-1995			<i>Victo-Tech</i> VS50143R	1
				<i>Tuff-Cork</i> VS50143TC	1
Valve Stem Seal, Exh.	1994-1995			B45449	6
Valve Stem Seal, Int.	1994-1995			B45449	6
Manifold Set, Exhaust	1994-1995			MS12399	1
Manifold Set, Intake	1994-1995		(Contains Plenum Chamber Gasket)	MS15984	1
Plenum Chamber Gasket	1994-1995			MS16300	1
Oil Pan Set	1994-1995			<i>Tuff-Cork</i> OS32103TC	1
				<i>Victo-Tech</i> OS32111	1
Rear Main Seal	1994-1995			47892	1
Rear Main Seal Set	1994-1995			JV1600	1
Timing Cover Set	1994-1995		(Requires Oil Pan Set)	JV1124	1
Timing Cover Seal	1994-1995			48061	1

MISCELLANEOUS GASKETS					
E.G.R. Gasket	1994-1995		Valve	G24079	1
			Exhaust Gas Recirculation Tube	G30824	1
Injector Nozzle O-Ring	1994-1995			GS33276	3
Throttle Body Gasket	1994-1995			G30817	1
Water Outlet Gasket	1994-1995			C25163	1
Water Pump Mount Gasket	1994-1995			K31177	1

35	201 CID (3.3L) L-Head Dodge 6 Cyl, 3.125in./79.4mm (1935-1941)					35
-----------	---	--	--	--	--	-----------

<i>Part</i>	<i>Year</i>	<i>VIN</i>	<i>Model/Application</i>	<i>Part Number</i>	<i>Qty.</i>
ENGINE GASKETS					
Head Set	1935-1941			HS1059C	1
Full Set	1935-1941		(Main Bearing Set Not Included, Timing Cover Set Not Included)	FS1059C	1
				VR2000 1059C	1
Cylinder Head Gasket	1935-1941			MS18005	1
Manifold Set, Int. & Exh.	1935-1941			JV755	1
Timing Cover Set	1935-1941				

MISCELLANEOUS GASKETS					
Exhaust Pipe Gasket	1935-1941		(Flange Type), Pipe To Manifold	F5438AK	1
Fuel Pump Bowl Gasket	1935-1941			D34545	1
Push Rod Cover Set	1935-1941			<i>Cork Rubber</i> VS36054	1
Water Outlet Gasket	1935-1941			C25487	1
Water Pump Mount Gasket	1935-1941			K25845	1

36	215 CID (3.5L) SOHC V6 Cyl, 3.780in./96mm (1993-2003)					36
-----------	--	--	--	--	--	-----------

<i>Part</i>	<i>Year</i>	<i>VIN</i>	<i>Model/Application</i>	<i>Part Number</i>	<i>Qty.</i>
ENGINE GASKETS					
Head Set	1999-2001		(Head Bolts Not Included)	HS5978A	1
			(Head Bolts Not Included)	HS5978	1
Lower Set	1999-2001		(Requires Head Set To Make Full Set)	CS5978A	1
			(Requires Head Set To Make Full Set)	CS5978	1
Engine Kit Gasket Set	1993-1997			95-3477VR	1

36 215 CID (3.5L) SOHC V6 Cyl, 3.780in./96mm (1993-2003)**36**
(cont.)

Part	Year	VIN	Model/Application	Part Number	Qty.
ENGINE GASKETS (cont.)					
Cylinder Head Gasket	1999-2001		Right	54112	1
			Left	54113	1
	1993-1997		Right	Nitroseal 5978	1
			Left	Nitroseal 5979	1
Cyl. Head Bolt Set	1999-2003			GS33373	2
	1993-1997			GS33326	1
Valve Cover Set	1999-2003		(Spark Plug Tube Seals Not Included) Victo-Tech	VS50248	1
	1993-1997			Victo-Tech VS50231	1
Valve Stem Seal, Exh.	1999-2003			B45832	12
	1993-1997			B45832	12
Valve Stem Seal, Int.	1999-2003			B45832	12
	1993-1997			B45832	12
Manifold Set, Exhaust	1993-1997			MS16138	1
Manifold Set, Intake	1999-2003		(Plenum Chamber Gasket Not Included) Victo-Tech	MS16210	1
	1993-1997		(Contains Plenum Chamber Gasket)	MS16130	1
Plenum Chamber Gasket	1999-2003			Victo-Tech MS16508	1
	1993-1997			MS16131	2
Oil Pan Set	1999-2003			OS32240	1
	1993-1997		(Contains Windage Tray) Victo-Tech	OS32136	1
Rear Main Seal Set	1999-2001			JV1642	1
	1993-1997			JV1600	1
Timing Cover Set	1993-1997		(Requires Oil Pan Set, Dust Cover Gasket Not Included)	JV1193	1
Timing Cover Seal	1999-2003			48061	1
	1993-1997			48061	1

MISCELLANEOUS GASKETS

Auto. Idle Speed Sensor	1993-1997			G31455	1	
E.G.R. Gasket	1999-2002		Tube To Valve	G31458	1	
	1999-2001		Valve	G31321	1	
				Tube To Plenum	G31474	2
	1993-1997		Valve	G31321	1	
				Tube To Valve	G31458	1
				Tube To Plenum	G31474	2
Injector Nozzle O-Ring	1993-1997			GS33279	1	
Oil Pan Drain Plug Gst.	1993-1997			2051	1	
Spark Plug Tube Seal	1999-2003			Victo-Tech B45848	6	
Throttle Body Gasket	1999-2003			Victo-Tech G31532	1	
	1993-1997			G31456	2	
Timing Cover Dust Seal	1999-2001			GS33303	1	
	1993-1997			GS33303	1	
Water Outlet Gasket	1993-1997			C25163	1	
Water Pump Mount Gasket	1993-1997			K31457	1	

37 218 CID (3.6L) L-Head 6 Cyl, 3.250in./82.6mm (1934-1954)**37**

Part	Year	VIN	Model/Application	Part Number	Qty.
ENGINE GASKETS					
Head Set	1951-1954		Canadian Models	HS3029	1
	1946-1954		United States	HS1059C	1
	1946-1950		Canadian Models	HS4922	1
	1940-1942		Canadian Models	HS4922	1
	1934-1942		United States	HS1059C	1
	1936		Canadian Models	HS4922	1

Chrysler

37 218 CID (3.6L) L-Head 6 Cyl, 3.250in./82.6mm (1934-1954)

(cont.)

37

(cont.)

Part Year VIN Model/Application Part Number Qty.

ENGINE GASKETS (cont.)

Full Set	1951-1954		Canadian Models, (Main Bearing Set Not Included, Timing Cover Set Not Included)	FS3029X	1
	1946-1954		United States, (Main Bearing Set Not Included, Timing Cover Set Not Included)	FS1059C	1
	1946-1950		Canadian Models, (Main Bearing Set Not Included, Timing Cover Set Not Included)	FS4922	1
	1940-1942		Canadian Models, (Main Bearing Set Not Included, Timing Cover Set Not Included)	FS4922	1
	1934-1942		United States, (Main Bearing Set Not Included, Timing Cover Set Not Included)	FS1059C	1
	1936		Canadian Models, (Main Bearing Set Not Included, Timing Cover Set Not Included)	FS4922	1
Cylinder Head Gasket	1951-1954		Canadian Models	3029	1
	1946-1954		United States <i>VR2000</i>	1059C	1
	1946-1950		Canadian Models <i>VR2000</i>	4922	1
	1940-1942		Canadian Models <i>VR2000</i>	4922	1
	1934-1942		United States <i>VR2000</i>	1059C	1
	1936		Canadian Models <i>VR2000</i>	4922	1
Manifold Gasket	1946-1954		United States, Intake To Exhaust	B17186	1
	1934-1942		United States, Intake To Exhaust	B17186	1
Manifold Set, Int. & Exh.	1946-1954		Canadian Models	MS15029	1
			United States	MS18005	1
	1940-1942		Canadian Models	MS15029	1
	1934-1942		United States	MS18005	1
	1936		Canadian Models	MS15029	1
Oil Pan Set	1946-1954		United States <i>Cork Rubber</i>	OS30893	1
			Canadian Models <i>Cork Rubber</i>	OS30899	1
	1940-1942		Canadian Models <i>Cork Rubber</i>	OS30899	1
	1934-1942		United States <i>Cork Rubber</i>	OS30893	1
	1936		Canadian Models <i>Cork Rubber</i>	OS30899	1
Rear Main Seal Set	1953-1954		United States	JV134-9	1
	1951-1954		Canadian Models <i>Rubber</i>	JV134-6	1
	1949-1950		Canadian Models	JV134-9	1
	1946-1948		Canadian Models, United States <i>Rubber</i>	JV134-6	1
	1940-1942		Canadian Models, United States <i>Rubber</i>	JV134-6	1
	1936		Canadian Models, United States <i>Rubber</i>	JV134-6	1
Timing Cover Set	1953-1954		Canadian Models, Plymouth, United States	JV826	1
	1942-1952		Canadian Models, Plymouth	JV755	1
			Plymouth, United States	JV757	1
	1948		Dodge, United States	JV757	1
	1947-1948		Canadian Models, Dodge	JV755	1
		1947		Dodge, Early 1947, United States	JV755
			Dodge, Late 1947, United States	JV757	1
	1934-1946		Canadian Models, Dodge, United States	JV755	1
	1940-1942		Canadian Models, Dodge, Plymouth, United States	JV755	1
	1937		Canadian Models, Chrysler, DeSoto, Dodge, United States	JV755	1
		Chrysler, DeSoto	JV755	1	
Timing Cover Seal	1954		Dodge, Except Late 1954, Plymouth, United States	SS49521-1	1
	1947-1953		Dodge, Plymouth, United States	SS49521-1	1

MISCELLANEOUS GASKETS

Air Cleaner Mount Gasket	1946-1948			G26540	1
	1934-1942			G26540	1
Exhaust Pipe Gasket	1949-1954		Canadian Models, Plymouth, United States, (Flange Type)	F5438AK	1
	1940-1948		Canadian Models, Dodge, Plymouth, United States, (Flange Type)	F5438AK	1
		1942		Canadian Models, Plymouth, United States, (Flange Type)	F5438AK

37 218 CID (3.6L) L-Head 6 Cyl, 3.250in./82.6mm (1934-1954)

(cont.)

37

(cont.)

<i>Part</i>	<i>Year</i>	<i>VIN</i>	<i>Model/Application</i>	<i>Part Number</i>	<i>Qty.</i>
MISCELLANEOUS GASKETS (cont.)					
Exhaust Pipe Gasket (cont.)	1934-1942		Canadian Models, Dodge, United States, (Flange Type)	F5438AK	1
	1937		Canadian Models, Chrysler, DeSoto, Dodge, United States, (Flange Type)	F5438AK	1
			Chrysler, DeSoto, (Flange Type)	F5438AK	1
Fuel Pump Bowl Gasket	1946-1949			D34545	1
	1937-1942			D34545	1
Push Rod Cover Set	1949-1954		Plymouth, United States <i>Cork Rubber</i>	VS36054	1
			Canadian Models, Plymouth <i>Cork Rubber</i>	VS38219	1
	1940-1948		Canadian Models, Dodge, Plymouth <i>Cork Rubber</i>	VS38219	1
	1934-1948		Dodge, Plymouth, United States <i>Cork Rubber</i>	VS36054	1
	1942		Canadian Models, Plymouth <i>Cork Rubber</i>	VS38219	1
	1934-1942		Canadian Models, Dodge <i>Cork Rubber</i>	VS38219	1
	1934-1938		Dodge, United States <i>Cork Rubber</i>	VS36054	1
	1937		Canadian Models, Chrysler, DeSoto, Dodge <i>Cork Rubber</i>	VS38219	1
		Chrysler, DeSoto <i>Cork Rubber</i>	VS38219	1	
Timing Cover Dust Seal	1953-1954		Canadian Models, United States	42379	1
Water Outlet Gasket	1942-1954		Canadian Models, Plymouth, United States	C25487	1
	1934-1948		Canadian Models, Dodge, United States	C24109	1
	1937		Chrysler, DeSoto	C26690	1
Water Pump Mount Gasket	1949-1954		Canadian Models, Plymouth, United States	K25845	1
			Canadian Models, Dodge, Plymouth, United States	K25845	1
	1942		Canadian Models, Plymouth, United States	K25845	1
	1934-1942		Canadian Models, Dodge, United States	K25845	1
	1937		Canadian Models, Chrysler, DeSoto, Dodge, United States	K25845	1
			Chrysler, DeSoto	K25845	1

38 225 CID (3.7L) OHV 6 Cyl, 3.400in./86.4mm (1960-1983)**38**

<i>Part</i>	<i>Year</i>	<i>VIN</i>	<i>Model/Application</i>	<i>Part Number</i>	<i>Qty.</i>
ENGINE GASKETS					
Head Set	1981-1983			HS3955	1
	1960-1980		Cast Iron Engine	HS1162VE	1
Full Set	1981-1983			FS3955	1
	1960-1980		Cast Iron Engine	FS1162VE	1
Engine Kit Gasket Set	1981-1983			95-3068VR	1
	1960-1980		Except Aluminum Engine	95-3001VR	1
Cylinder Head Gasket	1960-1983		Cast Iron Engine <i>VR2000</i>	1162VC	1
Valve Cover Set	1981-1983		<i>Cork Rubber</i>	VS39720	1
	1960-1980		Cast Iron Engine <i>Cork Rubber</i>	VS39745	1
Valve Stem Seal, Exh.	1981-1983			B45327	6
	1960-1980		Except Aluminum Engine	B45327	6
Valve Stem Seal, Int.	1981-1983			B45298	6
	1960-1980		Except Aluminum Engine	B45298	6
Manifold Set, Int. & Exh.	1981-1983			MS16030	1
	1960-1980		Except Aluminum Engine	MS16030	1
Oil Pan Set	1981-1983		<i>Cork Rubber</i>	OS30920X	1
	1960-1980		Except Aluminum Engine <i>Cork Rubber</i>	OS30920X	1
Rear Main Seal Set	1981-1983		<i>Rubber</i>	JV607	1
	1960-1980		Except Aluminum Engine <i>Rubber</i>	JV607	1
Timing Cover Set	1981-1983			JV814	1
			(Contains Repair Sleeve)	JV923	1
	1960-1980		Except Aluminum Engine	JV814	1
			Except Aluminum Engine, (Contains Repair Sleeve)	JV923	1

Chrysler

38 225 CID (3.7L) OHV 6 Cyl, 3.400in./86.4mm (1960-1983)
(cont.)

38
(cont.)

Part	Year	VIN	Model/Application	Part Number	Qty.
ENGINE GASKETS (cont.)					
Timing Cover Gasket	1981-1983			T28762	1
	1960-1980		Except Aluminum Engine	T28762	1
Timing Cover Seal	1981-1983			64572	1
	1960-1980		Except Aluminum Engine	64572	1
Harmonic Balancer Repair Sleeve	1981-1983		Ground Steel, .020" Thickness	66593RS	1
			Nickel Plated Formed Steel, .013" Thickness	A223-1	1
	1960-1980		Except Aluminum Engine Ground Steel, .020" Thickness	66593RS	1
			Except Aluminum Engine Nickel Plated Formed Steel, .013" Thickness	A223-1	1
MISCELLANEOUS GASKETS					
Air Cleaner Mount Gasket	1981-1983		1 Barrel Carburetor	G26540	1
	1977-1983		Aluminum Engine, 2 Barrel Carburetor	G25936	1
	1981			G26540	1
	1961-1981		1 Barrel Carburetor	G26540	1
Air Pump Gasket	1981-1983		Air Injection Tube	B45559	1
	1975-1980		Except Aluminum Engine, Air Injection Tube	B45559	1
Carb. Mount Gasket	1981-1983		1 Barrel Carburetor	G25456	1
	1981			G25456	1
			1 Barrel Carburetor	G25456	1
	1977-1980		Except Aluminum Engine, 2 Barrel Carburetor	G14140	1
	1974-1980		Except Aluminum Engine, 1 Barrel Carburetor	G25456	1
	1973		Cast Iron Engine, 1 Barrel Carburetor	G25457	1
	1970-1972		Cast Iron Engine, 1 Barrel Carburetor	G24105	1
	1962-1969		Cast Iron Engine, 1 Barrel Carburetor	G7173	1
	1961-1965		Cast Iron Engine, Positive Vent, 1 Barrel Carburetor	G7173	1
E.G.R. Gasket	1981-1983			G24079	1
	1973-1980		Except Aluminum Engine	G24079	1
Exhaust Pipe Gasket	1981-1983		(Flange Type)	F5495C	2
	1965-1980		Except Aluminum Engine	F5495C	2
	1960-1964		Cast Iron Engine, (Flange Type)	F5438AK	1
Fuel Pump Gasket	1981-1983			D27094	1
			Tuff-Cork	D27094TC	1
	1960-1980		Except Aluminum Engine	D27094	1
			Except Aluminum Engine Tuff-Cork	D27094TC	1
Oil Filter Cover Seal	1981-1983			72239	1
	1966-1980		Except Aluminum Engine	72239	1
Oil Pan Drain Plug Gst.	1981-1983			2051	1
	1960-1980		Except Aluminum Engine	2051	1
Oil Pump Body Gasket	1981-1983			B26339	1
	1979-1980		Except Aluminum Engine	B26339	1
	1960-1978		Cast Iron Engine	B26477	1
Spark Plug Tube Seal	1960-1980		Cast Iron Engine	B45384	6
Water Outlet Gasket	1981-1983			C24109	1
	1960-1980		Except Aluminum Engine	C24109	1
Water Pump Backing Plate	1981-1983			K27564	1
	1960-1980		Except Aluminum Engine	K27564	1
Water Pump Mount Gasket	1981-1983			K27564	1
	1960-1980		Except Aluminum Engine	K27564	1

39 230 CID (3.8L) L-Head 6 Cyl, 3.250in./82.6mm (1949-1959)

39

Part	Year	VIN	Model/Application	Part Number	Qty.
ENGINE GASKETS					
Head Set	1951-1959		Canadian Models	HS3029	1
	1949-1959		United States	HS1059C	1
	1949-1950		Canadian Models	HS4922	1
Full Set	1951-1959		Canadian Models, (Main Bearing Set Not Included, Timing Cover Set Not Included)	FS3029X	1
	1949-1959		United States, (Main Bearing Set Not Included, Timing Cover Set Not Included)	FS1059C	1
	1949-1950		Canadian Models, (Main Bearing Set Not Included, Timing Cover Set Not Included)	FS4922	1
Cylinder Head Gasket	1951-1959		Canadian Models	3029	1
	1949-1959		United States <i>VR2000</i>	1059C	1
	1949-1950		Canadian Models <i>VR2000</i>	4922	1
Manifold Gasket	1949-1959		United States, Intake To Exhaust	B17186	1
Manifold Set, Int. & Exh.	1949-1959		Canadian Models	MS15029	1
			United States	MS18005	1
Oil Pan Set	1949-1959		United States <i>Cork Rubber</i>	OS30893	1
			Canadian Models <i>Cork Rubber</i>	OS30899	1
Rear Main Seal Set	1953-1959		Canadian Models <i>Rubber</i>	JV134-6	1
			United States	JV134-9	1
	1951-1954		From Engine Serial Number 272299, United States	JV134-9	1
	1949-1954		Canadian Models, Thru Engine Serial Number 272299, United States <i>Rubber</i>	JV134-6	1
	1951		Thru Engine Serial Number 272299, United States <i>Rubber</i>	JV134-6	1
Timing Cover Set	1951-1959		Canadian Models, United States	JV826	1
	1951-1952		United States	JV757	1
			Canadian Models	JV826	1
	1949-1950		Canadian Models	JV755	1
Timing Cover Seal	1949-1959		Canadian Models, United States	SS49521-1	1

MISCELLANEOUS GASKETS

Air Cleaner Mount Gasket	1949-1959		Canadian Models, United States, 2 Barrel Carburetor	G26540	1
Carb. Mount Gasket	1951-1954		Canadian Models, United States, 1 Barrel Carburetor	G5349AD	1
Exhaust Pipe Gasket	1949-1959		Canadian Models, United States, (Flange Type), Pipe To Manifold	F5438AK	1
Push Rod Cover Set	1949-1959		United States <i>Cork Rubber</i>	VS36054	1
			Canadian Models <i>Cork Rubber</i>	VS38219	1
Timing Cover Dust Seal	1949-1959		Canadian Models, United States	42379	1
Water Outlet Gasket	1949-1959		Canadian Models, United States	C24109	1
Water Pump Mount Gasket	1949-1959		Canadian Models, United States	K25845	1

40 230 CID (3.8L) V6 Cyl, 3.780in./96mm (1991-1993)

40

Part	Year	VIN	Model/Application	Part Number	Qty.
ENGINE GASKETS					
Head Set	1991-1993		(Head Bolts Not Included, Exhaust Pipe Gasket Not Included, Intake Manifold Gasket Not Included)	HS5894	1
			(Contains Head Bolts, Exhaust Pipe Gasket Not Included, Intake Manifold Gasket Not Included)	HS5894WB	1
Lower Set	1991-1993		(Requires Head Set To Make Full Set)	CS5896	1
Full Set	1991-1993		(Exhaust Pipe Gasket Not Included, Intake Manifold Gasket Not Included)	FS5894	1
Cylinder Head Gasket	1991-1993		Left <i>Nitroseal</i>	5894	1
			Right <i>Nitroseal</i>	5895	1
Cyl. Head Bolt Set	1991-1993			GS33251	2
Cyl. Head Washer Set	1991-1993			GS33256	16
Valve Cover Set	1991-1993		<i>Victo-Tech</i>	VS50143R	1
			<i>Tuff-Cork</i>	VS50143TC	1

Chrysler

40 (cont.)	230 CID (3.8L) V6 Cyl, 3.780in./96mm (1991-1993)				40 (cont.)
----------------------	---	--	--	--	----------------------

Part	Year	VIN	Model/Application	Part Number	Qty.
------	------	-----	-------------------	-------------	------

ENGINE GASKETS (cont.)

Valve Stem Seal, Exh.	1991-1993			B45449	6
Valve Stem Seal, Int.	1991-1993			B45449	6
Manifold Set, Exhaust	1991-1993			MS12399	1
Manifold Set, Intake	1991-1993		(Contains Plenum Chamber Gasket)	MS15984	1
Plenum Chamber Gasket	1991-1993			MS16300	1
Oil Pan Set	1991-1993		Tuff-Cork	OS32103TC	1
			Victo-Tech	OS32111	1
Rear Main Seal	1991-1993			47892	1
Rear Main Seal Set	1991-1993			JV1600	1
Timing Cover Set	1991-1993			JV1124	1
Timing Cover Seal	1991-1993			48061	1

MISCELLANEOUS GASKETS

E.G.R. Gasket	1991-1993		Valve	G24079	1
			Exhaust Gas Recirculation Tube	G30824	2
Exhaust Pipe Gasket	1991-1993		(Ring Type 'F'), Pipe To Manifold	F7466	1
			(Flange Type), Crossover Pipe	F12380	2
Injector Nozzle O-Ring	1991-1993			GS33276	3
Throttle Body Gasket	1991-1993			G30817	1
Water Outlet Gasket	1991-1993			C25163	1
Water Pump Mount Gasket	1991-1993		(O-Ring Type)	K31177	1

41	251 CID (4.1L) L-Head 6 Cyl, 3.438in./87.33mm (1942-1952)				41
-----------	--	--	--	--	-----------

Part	Year	VIN	Model/Application	Part Number	Qty.
------	------	-----	-------------------	-------------	------

ENGINE GASKETS

Head Set	1942-1952		Canadian Models	HS3029	1
			United States	HS4922	1
Full Set	1942-1952		Canadian Models, (Main Bearing Set Not Included, Timing Cover Set Not Included)	FS3029X	1
			United States, (Main Bearing Set Not Included, Timing Cover Set Not Included)	FS4922	1
Cylinder Head Gasket	1946-1952		Canadian Models	3029	1
			United States	VR2000 4922	1
	1942		Canadian Models	3029	1
			United States	VR2000 4922	1
Manifold Set, Int. & Exh.	1946-1952		Canadian Models, United States	MS15029	1
	1942		Canadian Models, United States	MS15029	1
Oil Pan Set	1946-1951		Canadian Models, United States	Cork Rubber OS30899	1
	1942		Canadian Models, United States	Cork Rubber OS30899	1
Rear Main Seal Set	1948-1952		Canadian Models	Rubber JV134-6	1
			United States	JV134-9	1
	1942-1947		Canadian Models, United States	Rubber JV134-6	1
Timing Cover Set	1948-1952		Canadian Models	JV755	1
			United States	JV757	1
	1942-1947		Canadian Models, United States	JV755	1
Timing Cover Seal	1948-1952		Canadian Models, United States	SS49521-1	1

MISCELLANEOUS GASKETS

Air Cleaner Mount Gasket	1946-1952		Canadian Models, United States, 1 Barrel Carburetor	G25936	1
	1942		Canadian Models, United States, 1 Barrel Carburetor	G25936	1
Carb. Mount Gasket	1946-1952		Canadian Models, United States, 1 Barrel Carburetor	G5349AD	1
	1942		Canadian Models, United States, 1 Barrel Carburetor	G5349AD	1
Exhaust Pipe Gasket	1946-1952		(Flange Type), Pipe To Manifold	F5438AK	1
	1942		(Flange Type), Pipe To Manifold	F5438AK	1

41 (cont.)	251 CID (4.1L) L-Head 6 Cyl, 3.438in./87.33mm (1942-1952)					41 (cont.)
----------------------	--	--	--	--	--	----------------------

<i>Part</i>	<i>Year</i>	<i>VIN</i>	<i>Model/Application</i>	<i>Part Number</i>	<i>Qty.</i>
MISCELLANEOUS GASKETS (cont.)					
Fuel Pump Bowl Gasket	1946-1949			D34545	1
	1942			D34545	1
Push Rod Cover Set	1946-1952		<i>Cork Rubber</i>	VS38219	1
	1942		<i>Cork Rubber</i>	VS38219	1
Water Outlet Gasket	1946-1952			C25487	1
	1942			C25487	1
Water Pump Mount Gasket	1946-1952			K25845	1
	1942			K25845	1

42	265 CID (4.3L) L-Head 6 Cyl, 3.438in./87.33mm (1953-1954)					42
-----------	--	--	--	--	--	-----------

<i>Part</i>	<i>Year</i>	<i>VIN</i>	<i>Model/Application</i>	<i>Part Number</i>	<i>Qty.</i>
ENGINE GASKETS					
Head Set	1953-1954		Canadian Models	HS3029	1
			United States	HS4922	1
Full Set	1953-1954		Canadian Models, (Main Bearing Set Not Included, Timing Cover Set Not Included)	FS3029X	1
			United States, (Main Bearing Set Not Included, Timing Cover Set Not Included)	FS4922	1
Cylinder Head Gasket	1953-1954		Canadian Models	3029	1
			United States <i>VR2000</i>	4922	1
Manifold Set, Int. & Exh.	1953-1954			MS15029	1
Oil Pan Set	1953-1954		<i>Cork Rubber</i>	OS30899	1
Rear Main Seal Set	1953-1954		Canadian Models <i>Rubber</i>	JV134-6	1
			United States	JV134-9	1
Timing Cover Set	1953-1954		Canadian Models, United States	JV826	1
Timing Cover Seal	1953-1954		Canadian Models, United States	SS49521-1	1

MISCELLANEOUS GASKETS

Air Cleaner Mount Gasket	1953-1954			G25936	1
Carb. Mount Gasket	1953-1954		1 Barrel Carburetor	G5349AD	1
Exhaust Pipe Gasket	1953-1954		(Flange Type), Pipe To Manifold	F5438AK	1
Push Rod Cover Set	1953-1954		<i>Cork Rubber</i>	VS38219	1
Timing Cover Dust Seal	1953-1954			42379	1
Water Outlet Gasket	1953-1954			C25487	1
Water Pump Mount Gasket	1953-1954			K25845	1

43	270 CID (4.4L) OHV V8 Cyl, 3.625in./92.1mm (1956)					43
-----------	--	--	--	--	--	-----------

<i>Part</i>	<i>Year</i>	<i>VIN</i>	<i>Model/Application</i>	<i>Part Number</i>	<i>Qty.</i>
ENGINE GASKETS					
Valve Cover Set	1956		<i>Cork Rubber</i>	VS38264	1
Valve Stem Seal, Int.	1956			B45298	8
Manifold Gasket, Exh.	1956		To Valve Body	F5438AK	2
Oil Pan Set	1956		<i>Cork Rubber</i>	OS30513	1
Rear Main Seal Set	1956			JV606	1
Timing Cover Seal	1956			SS49521-1	1

MISCELLANEOUS GASKETS

Air Cleaner Mount Gasket	1956			G25936	1
Dist. Mounting Gasket	1956			B17926	1
Exhaust Pipe Gasket	1956		(Flange Type), Pipe To Manifold	F5438AK	3
Fuel Pump Gasket	1956			D27094	1

Chrysler

43	270 CID (4.4L) OHV V8 Cyl, 3.625in./92.1mm (1956)	43
(cont.)		(cont.)

Part	Year	VIN	Model/Application	Part Number	Qty.
------	------	-----	-------------------	-------------	------

MISCELLANEOUS GASKETS (cont.)

Timing Cover Dust Seal	1956			42379	1
Water Outlet Gasket	1956			C25487	1

44	273 CID (4.5L) OHV V8 Cyl, 3.625in./92.1mm (1964-1969)	44
-----------	---	-----------

Part	Year	VIN	Model/Application	Part Number	Qty.
------	------	-----	-------------------	-------------	------

ENGINE GASKETS

Head Set	1966-1969			HS3536A	1
Lower Set	1966-1969		(Requires Head Set To Make Full Set)	CS3536B	1
Full Set	1968-1969			FS3536A	1
	1966			FS3536A	1
Engine Kit Gasket Set	1966-1969			95-3338VR	1
	1964-1966		(Intake Manifold Gasket Not Included), Use With Part Number MS15125	95-3338VR	1
Cylinder Head Gasket	1964-1969		Nitroseal	3536SG	2
			VR2000	3536VC	2
Valve Cover Set	1964-1969		Cork Rubber	VS39569	1
			High Temperature Cork Rubber	VS39569H	1
			Victo-Tech	VS39569R	1
Valve Stem Seal, Exh.	1964-1969			B45298	8
Valve Stem Seal, Int.	1964-1969			B45298	8
Manifold Set, Exhaust	1964-1969			MS15136	1
Manifold Set, Intake	1966-1969			MS15148	1
	1964-1965			MS15125	1
Oil Pan Set	1964-1969		Cork Rubber	OS30520X	1
Rear Main Seal Set	1964-1969			JV606	1
Timing Cover Set	1964-1969			JV806X	1
Timing Cover Gasket	1964-1969			T27787	1
Timing Cover Seal	1964-1969			64573	1
Harmonic Balancer Repair Sleeve	1964-1969		Use With Part Number A501 Nickel Plated Formed Steel, .013" Thickness	A224-1	1

MISCELLANEOUS GASKETS

Air Cleaner Mount Gasket	1964-1969		2 Barrel Carburetor	G25936	1
			4 Barrel Carburetor	G26410	1
Carb. Mount Gasket	1965-1969		2 Barrel Carburetor	G12220	1
	1967		4 Barrel Carburetor	G14590	1
	1965-1966		4 Barrel Carburetor	G27101	1
Dist. Mounting Gasket	1964-1969			B17926	1
Fuel Pump Gasket	1964-1969			D27094	1
Oil Filter Cover Seal	1965-1969			72239	1
Oil Pan Drain Plug Gst.	1964-1969			2051	1
Water Outlet Gasket	1966-1969			C25487	1
	1964-1965			C26690	1
Water Pump Mount Gasket	1964-1969			K27556	1

45	277 CID (4.5L) OHV V8 Cyl, 3.750in./95.3mm (1956-1957)	45
-----------	---	-----------

Part	Year	VIN	Model/Application	Part Number	Qty.
------	------	-----	-------------------	-------------	------

ENGINE GASKETS

Head Set	1956-1957			HS1134TC	1
Full Set	1956-1957			FS1134TC	1
Cylinder Head Gasket	1956-1957		VR2000	1134TC	2
Valve Cover Set	1956-1957		Cork Rubber	VS38282	1
Valve Stem Seal, Int.	1956-1957			B45298	8

45 (cont.)	277 CID (4.5L) OHV V8 Cyl, 3.750in./95.3mm (1956-1957)	45 (cont.)
---------------	--	---------------

Part	Year	VIN	Model/Application	Part Number	Qty.
ENGINE GASKETS (cont.)					
Manifold Set, Exhaust	1956-1957			MS15058	1
Manifold Set, Intake	1956-1957			MS15063	1
Oil Pan Set	1956-1957		<i>Cork Rubber</i>	OS30520	1
Rear Main Seal Set	1956-1957			JV606	1
Timing Cover Set	1956-1957			JV806X	1
Timing Cover Gasket	1956-1957			T27787	1
Timing Cover Seal	1956-1957			64573	1
Harmonic Balancer Repair Sleeve	1956-1957		Use With Part Number A501 <i>Nickel Plated Formed Steel, .013" Thickness</i>	A224	1

MISCELLANEOUS GASKETS

Exhaust Pipe Gasket	1956-1957		(Flange Type), Pipe To Manifold	F5438AK	1
Fuel Pump Gasket	1956-1957			D27094	1
Water Outlet Gasket	1956-1957			C25487	1
Water Pump Mount Gasket	1956-1957			K27556	1

46	301 CID (4.9L) V8 Cyl, 3.910in./99.3mm (1956-1957)	46
----	--	----

Part	Year	VIN	Model/Application	Part Number	Qty.
ENGINE GASKETS					
Head Set	1956-1957			HS1134TC	1
Full Set	1956-1957			FS1134TC	1
Cylinder Head Gasket	1956-1957		<i>VR2000</i>	1134TC	2
Valve Cover Set	1956-1957		<i>Cork Rubber</i>	VS38282	1
Valve Stem Seal, Int.	1956-1957			B45298	8
Manifold Set, Exhaust	1956-1957			MS15058	1
Manifold Set, Intake	1956-1957			MS15063	1
Oil Pan Set	1956-1957		<i>Cork Rubber</i>	OS30520	1
Rear Main Seal Set	1956-1957			JV606	1
Timing Cover Set	1956-1957			JV806X	1
Timing Cover Gasket	1956-1957			T27787	1
Timing Cover Seal	1956-1957			64573	1
Harmonic Balancer Repair Sleeve	1956-1957		Use With Part Number A501 <i>Nickel Plated Formed Steel, .013" Thickness</i>	A224	1

MISCELLANEOUS GASKETS

Exhaust Pipe Gasket	1956-1957		(Flange Type), Pipe To Manifold	F5438AK	1
Fuel Pump Gasket	1956-1957			D27094	1
Water Outlet Gasket	1956-1957			C25487	1
Water Pump Mount Gasket	1956-1957			K27556	1

47	303 CID (5.0L) OHV V8 Cyl, 3.813in./96.9mm (1956)	47
----	---	----

Part	Year	VIN	Model/Application	Part Number	Qty.
ENGINE GASKETS					
Head Set	1956			HS1134TC	1
Full Set	1956			FS1134TC	1
Cylinder Head Gasket	1956		<i>VR2000</i>	1134TC	2
Valve Cover Set	1956		<i>Cork Rubber</i>	VS38282	1
Valve Stem Seal, Int.	1956			B45298	8
Manifold Gasket, Exh.	1956		To Valve Body	F5438AK	2
Manifold Set, Exhaust	1956			MS15058	1
Manifold Set, Intake	1956			MS15063	1
Oil Pan Set	1956		United States <i>Cork Rubber</i>	OS30520	1
			Canadian Models <i>Cork Rubber</i>	OS30520X	1
Rear Main Seal Set	1956			JV606	1
Timing Cover Set	1956		United States	JV806X	1

Chrysler

47	303 CID (5.0L) OHV V8 Cyl, 3.813in./96.9mm (1956)	47
(cont.)		(cont.)

Part	Year	VIN	Model/Application	Part Number	Qty.
------	------	-----	-------------------	-------------	------

ENGINE GASKETS (cont.)

Timing Cover Seal	1956			64573	1
Harmonic Balancer Repair Sleeve	1956		United States, Use With Part Number A501 <i>Nickel Plated Formed Steel, .013" Thickness</i>	A224	1

MISCELLANEOUS GASKETS

Dist. Mounting Gasket	1956			B17926	1
Exhaust Pipe Gasket	1956		Canadian Models, United States, (Flange Type), Pipe To Manifold	F5438AK	2
Fuel Pump Gasket	1956			D27094	1
Water Outlet Gasket	1956			C25487	1

48	315 CID (5.2L) Hemispherical V8 Cyl, 3.625in./92.1mm (1956)	48
(cont.)		(cont.)

Part	Year	VIN	Model/Application	Part Number	Qty.
------	------	-----	-------------------	-------------	------

ENGINE GASKETS

Valve Cover Set	1956			<i>Cork Rubber</i> VS38264	1
Valve Stem Seal, Int.	1956			B45298	8
Oil Pan Set	1956			<i>Cork Rubber</i> OS30513	1
Rear Main Seal Set	1956			JV606	1

MISCELLANEOUS GASKETS

Air Cleaner Mount Gasket	1956			G25936	1
Dist. Mounting Gasket	1956			B17926	1
Exhaust Pipe Gasket	1956		(Flange Type), Pipe To Manifold	F5438AK	1
Fuel Pump Gasket	1956			D27094	1
Timing Cover Dust Seal	1956			42379	1
Water Outlet Gasket	1956			C25487	1

49	318 CID (5.2L) V8 Cyl, 3.910in./99.3mm (1957-1989)	49
(cont.)		(cont.)

Part	Year	VIN	Model/Application	Part Number	Qty.
------	------	-----	-------------------	-------------	------

ENGINE GASKETS

Head Set	1978-1989		4 Barrel Carburetor, Electronic Fuel Injection	HS3536B	1
	1975-1989		2 Barrel Carburetor	HS3536	1
	1967-1974		2 Barrel Carburetor	HS3536A	1
	1969-1971		4 Barrel Carburetor	HS3536C	1
	1957-1966			HS1134TC	1
Lower Set	1967-1989		(Requires Head Set To Make Full Set)	CS3536B	1
Full Set	1980-1989		4 Barrel Carburetor, Electronic Fuel Injection	FS3536B	1
	1975-1989		2 Barrel Carburetor	FS3536	1
	1980		4 Barrel Carburetor, Electronic Fuel Injection, 4 Barrel Carburetor	FS3536B	1
	1978-1980		4 Barrel Carburetor, Electronic Fuel Injection	FS3536B	1
	1967-1974		2 Barrel Carburetor	FS3536A	1
	1969-1971		4 Barrel Carburetor	FS3536C	1
	1957-1966			FS1134TC	1
	1979-1989			95-3346VR	1
Engine Kit Gasket Set	1978		4 Barrel Carburetor, (Intake Manifold Gasket Not Included), Use With Part Number MS15176W	95-3338VR	1
	1975-1978		2 Barrel Carburetor	95-3338VR	1
	1975-1976		2 Barrel Carburetor	95-3338VR	1
	1974-1975		2 Barrel Carburetor, 5 Bolt Valve Cover	95-3338VR	1
			5 Bolt Valve Cover, 2 Barrel Carburetor	95-3338VR	1
	1974		5 Bolt Valve Cover	95-3338VR	1
			5 Bolt Valve Cover, 2 Barrel Carburetor	95-3338VR	1
	1967-1974		5 Bolt Valve Cover	95-3338VR	1
1958-1967		2 Bolt Valve Cover	95-3012VR	1	

PASSENGER CAR

49 318 CID (5.2L) V8 Cyl, 3.910in./99.3mm (1957-1989)

49

(cont.)

(cont.)

Part	Year	VIN	Model/Application	Part Number	Qty.	
ENGINE GASKETS (cont.)						
Cylinder Head Gasket	1968-1989		Nitroseal	3536SG	2	
			VR2000	3536VC	2	
	1967		5 Bolt Valve Cover	Nitroseal	3536SG	2
			5 Bolt Valve Cover	VR2000	3536VC	2
	1957-1966			VR2000	1134TC	2
Cyl. Head Bolt Set	1967-1989			GS33344	2	
Valve Cover Set	1967-1989		Cork Rubber	VS39569	1	
			High Temperature Cork Rubber	VS39569H	1	
			Victo-Tech	VS39569R	1	
			Tuff-Cork	VS39569TC	1	
	1957-1966		Cork Rubber	VS38282	1	
Valve Stem Seal, Exh.	1979-1989		Fluoroelastomer	B45624	8	
	1957-1989	(Shedder Type)		B45298	8	
Valve Stem Seal, Int.	1979-1989		Fluoroelastomer	B45623	8	
	1957-1989	(Positive Type)	Nitrile	B45403	8	
	1957-1978	(Shedder Type)		B45298	8	
Manifold Gasket, Exh.	1957-1966	(Flange Type), To Valve Body		F5438AK	2	
Manifold Set, Exhaust	1975-1989			MS12268	1	
	1967-1974			MS15136	1	
	1962-1966			MS15059	1	
	1957-1961			MS15058	1	
Manifold Set, Intake	1978-1989	4 Barrel Carburetor		MS15176W	1	
	1967-1989	2 Barrel Carburetor		MS15148	1	
	1969-1971	4 Barrel Carburetor		MS15176W	1	
	1957-1966			MS15063	1	
Oil Pan Set	1970-1989		Cork Rubber	OS30520Y	1	
			Tuff-Cork	OS30520YTC	1	
	1959-1969		Cork Rubber	OS30520X	1	
	1957-1958		Cork Rubber	OS30520	1	
Rear Main Seal Set	1957-1989			JV606	1	
Timing Cover Set	1970-1989			JV806	1	
		(Contains Repair Sleeve)		JV934	1	
	1957-1969			JV806X	1	
Timing Cover Gasket	1957-1989			T27787	1	
Timing Cover Seal	1957-1989			64573	1	
Harmonic Balancer Repair Sleeve	1957-1989		Ground Steel, .020" Thickness	66592RS	1	
		Use With Part Number A501 Nickel Plated Formed Steel, .013" Thickness		A224-1	1	

MISCELLANEOUS GASKETS

Air Cleaner Mount Gasket	1989		4 Barrel Carburetor	G31043	1
	1960-1989		2 Barrel Carburetor	G25936	1
	1978-1988		4 Barrel Carburetor	G27098	1
	1969-1971		4 Barrel Carburetor	G27098	1
	1961-1962		4 Barrel Carburetor	G27098	1
Air Pump Gasket	1975-1989		Air Injection Tube	B45559	1
Carb. Mount Gasket	1985-1989		4 Barrel Carburetor	G30715	1
	1970-1989		2 Barrel Carburetor	G14140	1
	1978-1984		4 Barrel Carburetor	G14589	1
	1965-1969		2 Barrel Carburetor	G12220	1
Dist. Mounting Gasket	1957-1978			B17926	1
Distributor Seal	1966-1989	(O-Ring Type), Shaft		72133	1
E.G.R. Gasket	1973-1989			G24080	1
Exhaust Pipe Gasket	1967-1969	(Flange Type), Pipe To Manifold		F5495C	2
	1957-1966	(Flange Type), Pipe To Manifold		F5438AK	1
Fuel Pump Gasket	1988-1989			D31042	1

Chrysler

49 318 CID (5.2L) V8 Cyl, 3.910in./99.3mm (1957-1989) **49**
(cont.) (cont.)

Part	Year	VIN	Model/Application	Part Number	Qty.
MISCELLANEOUS GASKETS (cont.)					
Fuel Pump Gasket (cont.)	1957-1987			D27094	1
				Tuff-Cork	D27094TC
Oil Filler Pipe Gasket	1979-1989		Heavy Duty, High Performance Engine	B45574	1
Oil Filter Adapt Gasket	1967-1989			B31604	1
Oil Filter Cover Seal	1965-1976			72239	1
Oil Pan Drain Plug Gst.	1957-1989			2051	1
Oil Pump Cover Gasket	1963-1989			B45558	1
Water Outlet Gasket	1979-1989			C24672	1
	1975-1978			C26690	1
	1971-1974		Performaseal	C25487VC	1
	1957-1974			C25487	1
Water Pump Mount Gasket	1957-1989			K27556	1

50 325 CID (5.3L) Hemispherical V8 Cyl, 3.688in./93.7mm (1957) **50**

Part	Year	VIN	Model/Application	Part Number	Qty.
ENGINE GASKETS					
Valve Cover Set	1957			Cork Rubber VS38264	1
Valve Stem Seal, Int.	1957			B45298	8
Manifold Gasket, Exh.	1957		(Flange Type), To Valve Body	F5438AK	2
Oil Pan Set	1957			Cork Rubber OS30513	1
Rear Main Seal Set	1957			JV606	1
Timing Cover Seal	1957			64573	1

MISCELLANEOUS GASKETS					
Carb. Mount Gasket	1957		2 Barrel Carburetor	G12220	1
Dist. Mounting Gasket	1957			B17926	1
Exhaust Pipe Gasket	1957		(Flange Type), Pipe To Manifold	F5438AK	1
Fuel Pump Gasket	1957			D27094	1
Water Outlet Gasket	1957			C25487	1

51 326 CID (5.3L) OHV V8 Cyl, 3.953in./100.4mm (1959) **51**

Part	Year	VIN	Model/Application	Part Number	Qty.
ENGINE GASKETS					
Head Set	1959			HS1134TC	1
Full Set	1959			FS1134TC	1
Engine Kit Gasket Set	1959			95-3012VR	1
Cylinder Head Gasket	1959			VR2000 1134TC	2
Valve Cover Set	1959			Cork Rubber VS38282	1
Valve Stem Seal, Int.	1959			B45298	8
Manifold Set, Exhaust	1959			MS15058	1
Manifold Set, Intake	1959			MS15063	1
Oil Pan Set	1959			Cork Rubber OS30520X	1
Rear Main Seal Set	1959			JV606	1
Timing Cover Set	1959			JV806X	1
Timing Cover Gasket	1959			T27787	1
Timing Cover Seal	1959			64573	1
Harmonic Balancer Repair Sleeve	1959		Use With Part Number A501 Nickel Plated Formed Steel, .013" Thickness	A224	1

MISCELLANEOUS GASKETS					
Air Cleaner Mount Gasket	1959		2 Barrel Carburetor	G25936	1
Dist. Mounting Gasket	1959			B17926	1

51 (cont.)	326 CID (5.3L) OHV V8 Cyl, 3.953in./100.4mm (1959)	51 (cont.)
----------------------	---	----------------------

Part	Year	VIN	Model/Application	Part Number	Qty.
MISCELLANEOUS GASKETS (cont.)					
Exhaust Pipe Gasket	1959		(Flange Type), Pipe To Manifold	F5438AK	1
Fuel Pump Gasket	1959			D27094	1
Water Outlet Gasket	1959			C25487	1
Water Pump Mount Gasket	1959			K27556	1

52	340 CID (5.6L) OHV V8 Cyl, 4.040in./102.6mm (1968-1973)	52
-----------	--	-----------

Part	Year	VIN	Model/Application	Part Number	Qty.
ENGINE GASKETS					
Head Set	1968-1973		(Exhaust Pipe Gasket Not Included)	HS3536B	1
Lower Set	1970-1973		(Requires Head Set To Make Full Set)	CS3536B	1
	1968-1969		Oil Pan Gasket Required, (Requires Head Set To Make Full Set)	CS3536B	1
Full Set	1970-1973		(Exhaust Pipe Gasket Not Included)	FS3536B	1
	1968-1969		Oil Pan Gasket Required, (Oil Pan Gasket Not Included, Exhaust Pipe Gasket Not Included)	FS3536B	1
Engine Kit Gasket Set	1968-1973			95-3346VR	1
Cylinder Head Gasket	1968-1973		<i>Nitroseal</i>	3536SG	2
			<i>VR2000</i>	3536VC	2
Valve Cover Set	1968-1973		<i>Cork Rubber</i>	VS39569	1
			<i>High Temperature Cork Rubber</i>	VS39569H	1
			<i>Victo-Tech</i>	VS39569R	1
Valve Stem Seal, Exh.	1968-1973			B45298	8
Valve Stem Seal, Int.	1968-1973		(Shedder Type)	B45298	8
			(Positive Type)	<i>Nitrile</i> B45403	8
Manifold Set, Exhaust	1968-1973			MS12268	1
Manifold Set, Intake	1968-1973			MS15176W	1
Oil Pan Set	1970-1973		<i>Cork Rubber</i>	OS30520Y	1
	1968-1969		<i>Cork Rubber</i>	OS30520X	1
Rear Main Seal Set	1968-1973			JV606	1
Timing Cover Set	1970-1973			JV806	1
			(Contains Repair Sleeve)	JV934	1
	1968-1969			JV806X	1
Timing Cover Gasket	1968-1973			T27787	1
Timing Cover Seal	1968-1973			64573	1
Harmonic Balancer Repair Sleeve	1968-1973		<i>Ground Steel, .020" Thickness</i>	66592RS	1
			Use With Part Number A501 <i>Nickel Plated Formed Steel, .013" Thickness</i>	A224-1	1

MISCELLANEOUS GASKETS

Air Cleaner Mount Gasket	1968-1973		2 Barrel Carburetor	G26410	1
			4 Barrel Carburetor	G27098	1
Carb. Mount Gasket	1973		4 Barrel Carburetor	G14589	1
	1970-1972		4 Barrel Carburetor	G26662	1
	1968-1970		4 Barrel Carburetor	G14590	1
Dist. Mounting Gasket	1968-1973			B17926	1
Exhaust Pipe Gasket	1968-1973		(Flange Type), Pipe To Manifold	F5561K	1
Fuel Pump Gasket	1968-1973			D27094	1
Oil Filter Cover Seal	1968-1973			72239	1
Oil Pan Drain Plug Gst.	1968-1973			2051	1
Water Outlet Gasket	1968-1973			C25487	1
Water Pump Mount Gasket	1968-1973			K27556	1

Chrysler

53 350 CID (5.7L) OHV V8 Cyl, 4.063in./103.2mm (1958)

53

Part	Year	VIN	Model/Application	Part Number	Qty.
ENGINE GASKETS					
Engine Kit Gasket Set	1958		(Valve Cover Set Not Included, Intake Manifold Gasket Not Included), Use With Part Numbers MS15924, VS38281	95-3344VR	1
Cylinder Head Gasket	1958		VR2000	3464VC	2
Valve Cover Set	1958		Cork Rubber	VS38281	1
Valve Stem Seal, Int.	1958			B45343	8
Manifold Set, Exhaust	1958			MS15139	1
Manifold Set, Intake	1958			MS15924	1
Oil Pan Set	1958		Cork Rubber	OS31416	1
Timing Cover Set	1958			JV834	1
Timing Cover Gasket	1958			T18750	1
Harmonic Balancer Repair Sleeve	1958		Use With Part Number A501 Nickel Plated Formed Steel, .013" Thickness	A224	1

MISCELLANEOUS GASKETS

Dist. Mounting Gasket	1958			B17926	1
Exhaust Pipe Gasket	1958		(Flange Type), Pipe To Manifold	F5495C	2
Fuel Pump Gasket	1958			D27094	1
Water Outlet Gasket	1958			C25487	1
Water Pump Mount Gasket	1958		Housing To Block	K26444	2
				K27080	1

54 360 CID (5.9L) V8 Cyl, 4.000in./101.6mm (1971-1980)

54

Part	Year	VIN	Model/Application	Part Number	Qty.
ENGINE GASKETS					
Head Set	1971-1980		(Exhaust Pipe Gasket Not Included)	HS3536D	1
Full Set	1971-1980		(Exhaust Pipe Gasket Not Included)	FS3536D	1
Engine Kit Gasket Set	1979-1980			95-3345VR	1
	1974-1978			95-3343VR	1
	1971-1976			95-3343VR	1
Cylinder Head Gasket	1971-1980		Nitroseal	3536SG	2
			VR2000	3536VC	2
Cyl. Head Bolt Set	1971-1980			GS33344	2
Valve Cover Set	1971-1980		Cork Rubber	VS39569	1
			High Temperature Cork Rubber	VS39569H	1
			Victo-Tech	VS39569R	1
			Tuff-Cork	VS39569TC	1
Valve Stem Seal, Exh.	1977-1980		(Shedder Type) Fluoroelastomer	B45624	8
	1971-1980			B45298	8
Valve Stem Seal, Int.	1977-1980		Fluoroelastomer	B45623	8
	1971-1980		(Positive Type) Nitrile	B45403	8
	1971-1976		(Shedder Type)	B45298	8
Manifold Set, Exhaust	1971-1980			MS12268	1
Manifold Set, Intake	1971-1980			MS15176W	1
Oil Pan Set	1971-1980		Cork Rubber	OS30520Z	1
			Tuff-Cork	OS30520ZTC	1
Rear Main Seal Set	1971-1980			JV605	1
Timing Cover Set	1971-1980			JV806	1
			(Contains Repair Sleeve)	JV934	1
Timing Cover Gasket	1971-1980			T27787	1
Timing Cover Seal	1971-1980			64573	1
Harmonic Balancer Repair Sleeve	1971-1980		Ground Steel, .020" Thickness	66592RS	1
			Use With Part Number A501 Nickel Plated Formed Steel, .013" Thickness	A224-1	1

MISCELLANEOUS GASKETS

Air Cleaner Mount Gasket	1974-1980		4 Barrel Carburetor	G27098	1
--------------------------	-----------	--	---------------------	--------	---

54 (cont.)	360 CID (5.9L) V8 Cyl, 4.000in./101.6mm (1971-1980)	54 (cont.)
----------------------	--	----------------------

Part	Year	VIN	Model/Application	Part Number	Qty.
MISCELLANEOUS GASKETS (cont.)					
Air Cleaner Mount Gasket (cont.)	1971-1980		2 Barrel Carburetor	G26410	1
Air Pump Gasket	1975-1980			B45559	1
Carb. Mount Gasket	1974-1980		4 Barrel Carburetor	G14589	1
	1971-1980		2 Barrel Carburetor	G14141	1
Dist. Mounting Gasket	1971-1980			B17926	1
Distributor Seal	1971-1980		Shaft	72133	1
E.G.R. Gasket	1974-1980			G24080	1
Exhaust Pipe Gasket	1971-1974		(Flange Type), Pipe To Manifold	F5561K	1
Fuel Pump Gasket	1971-1980			D27094	1
				<i>Tuff-Cork</i> D27094TC	1
Oil Filler Pipe Gasket	1979-1980		Heavy Duty, High Performance Engine	B45574	1
Oil Filter Adapt Gasket	1971-1980			B31604	1
Oil Pan Drain Plug Gst.	1971-1980			2051	1
Oil Pump Cover Gasket	1971-1980			B45558	1
Water Outlet Gasket	1979-1980			C24672	1
	1975-1978			C26690	1
	1971-1974			C25487	1
Water Pump Mount Gasket	1971-1980			K27556	1

55	360 CID (5.9L) LPG V8 Cyl, 4.000in./101.6mm (1971-1980)	55
-----------	--	-----------

Part	Year	VIN	Model/Application	Part Number	Qty.
ENGINE GASKETS					
Engine Kit Gasket Set	1979-1980			95-3345VR	1
	1971-1978			95-3343VR	1
Cyl. Head Bolt Set	1971-1980			GS33344	2

MISCELLANEOUS GASKETS

Distributor Seal	1971-1980		Shaft	72133	1
Oil Filter Adapt Gasket	1971-1980			B31604	1

56	361 CID (5.9L) OHV V8 Cyl, 4.125in./104.8mm (1957-1966)	56
-----------	--	-----------

Part	Year	VIN	Model/Application	Part Number	Qty.	
ENGINE GASKETS						
Head Set	1964-1966		(Intake Manifold Gasket Not Included)	HS3464VC	1	
	1963		6 Bolt Valve Cover, (Intake Manifold Gasket Not Included)	HS3464VC	1	
Full Set	1964-1966		(Intake Manifold Gasket Not Included)	FS3464VC	1	
	1963		6 Bolt Valve Cover, (Intake Manifold Gasket Not Included)	FS3464VC	1	
Engine Kit Gasket Set	1963-1966		(Intake Manifold Gasket Not Included), Use With Part Number MS15924	95-3344VR	1	
	1958-1962		(Valve Cover Set Not Included, Intake Manifold Gasket Not Included), Use With Part Numbers MS15924, VS38281	95-3344VR	1	
Cylinder Head Gasket	1957-1966		<i>Nitroseal</i>	3464SG	2	
			<i>VR2000</i>	3464VC	2	
Valve Cover Set	1964-1966		<i>Cork Rubber</i>	VS38322	1	
			<i>High Temperature Cork Rubber</i>	VS38322H	1	
	1963		4 Bolt Valve Cover	<i>Cork Rubber</i>	VS38281	1
			6 Bolt Valve Cover	<i>Cork Rubber</i>	VS38322	1
		6 Bolt Valve Cover, (High Temperature)	<i>High Temperature Cork Rubber</i>	VS38322H	1	
1957-1962			<i>Cork Rubber</i>	VS38281	1	
Valve Stem Seal, Exh.	1959-1966			B45343	8	
Valve Stem Seal, Int.	1959-1966		(Shedder Type)	B45343	8	
			(Positive Type)	<i>Nitrile</i> B45403	8	

Chrysler

56 (cont.)	361 CID (5.9L) OHV V8 Cyl, 4.125in./104.8mm (1957-1966)				56 (cont.)
----------------------	--	--	--	--	----------------------

<i>Part</i>	<i>Year</i>	<i>VIN</i>	<i>Model/Application</i>	<i>Part Number</i>	<i>Qty.</i>
ENGINE GASKETS (cont.)					
Manifold Set, Exhaust	1957-1966			MS15139	1
Manifold Set, Intake	1957-1966			MS15924	1
Oil Pan Set	1957-1966		Cork Rubber	OS31416	1
Rear Main Seal Set	1962-1966		Rope Packing	JV551	1
			Molded Rubber	JV604	1
	1961	Except Early 1961	Rope Packing	JV551	1
		Except Early 1961	Molded Rubber	JV604	1
Timing Cover Set	1957-1966			JV834	1
		(Contains Repair Sleeve)		JV924	1
Timing Cover Gasket	1957-1966			T18750	1
Timing Cover Seal	1957-1966			64573	1
Harmonic Balancer Repair Sleeve	1957-1966		Ground Steel, .020" Thickness	66592RS	1
			Use With Part Number A501 Nickel Plated Formed Steel, .013" Thickness	A224	1

MISCELLANEOUS GASKETS					
Air Cleaner Mount Gasket	1961-1964		2 Barrel Carburetor	G26410	1
			4 Barrel Carburetor	G27098	1
Carb. Mount Gasket	1959-1966		2 Barrel Carburetor	G7328	1
	1961-1965		4 Barrel Carburetor	G27101	1
	1960		Carburetor Number 2903S, 4 Barrel Carburetor	G14569	2
		Except Carburetor Number 2903S, 4 Barrel Carburetor	G27101	1	
Dist. Mounting Gasket	1957-1966			B17926	1
Exhaust Pipe Gasket	1957-1966		(Flange Type), Pipe To Manifold	F5495C	2
Fuel Pump Gasket	1957-1966			D27094	1
Oil Pan Drain Plug Gst.	1957-1966			2051	1
Oil Pump Cover Gasket	1957-1966			B45558	1
Water Outlet Gasket	1957-1966			C25487	1
Water Pump Mount Gasket	1957-1966		Housing To Block	K26444	2
				K27080	1

57	383 CID (6.3L) LPG V8 Cyl, 4.250in./108mm (1963-1971)				57
-----------	--	--	--	--	-----------

<i>Part</i>	<i>Year</i>	<i>VIN</i>	<i>Model/Application</i>	<i>Part Number</i>	<i>Qty.</i>
ENGINE GASKETS					
Engine Kit Gasket Set	1963-1971		(Intake Manifold Gasket Not Included), Use With Part Number MS15924	95-3344VR	1

58	383 CID (6.3L) OHV V8 Cyl, 4.250in./108mm (1959-1971)				58
-----------	--	--	--	--	-----------

<i>Part</i>	<i>Year</i>	<i>VIN</i>	<i>Model/Application</i>	<i>Part Number</i>	<i>Qty.</i>
ENGINE GASKETS					
Head Set	1964-1971		(Intake Manifold Gasket Not Included)	HS3464VC	1
	1963		6 Bolt Valve Cover, (Intake Manifold Gasket Not Included)	HS3464VC	1
Full Set	1964-1971		(Intake Manifold Gasket Not Included)	FS3464VC	1
	1963		6 Bolt Valve Cover, (Intake Manifold Gasket Not Included)	FS3464VC	1
Engine Kit Gasket Set	1963-1971		(Intake Manifold Gasket Not Included), Use With Part Number MS15924	95-3344VR	1
Cylinder Head Gasket	1959-1971		Nitroseal	3464SG	2
			VR2000	3464VC	2
Valve Cover Set	1964-1971		Cork Rubber	VS38322	1
		(High Temperature)	High Temperature Cork Rubber	VS38322H	1
	1963		6 Bolt Valve Cover	Cork Rubber	VS38322

58
(cont.)

383 CID (6.3L) OHV V8 Cyl, 4.250in./108mm (1959-1971)

58
(cont.)

Part	Year	VIN	Model/Application	Part Number	Qty.
ENGINE GASKETS (cont.)					
Valve Cover Set (cont.)	1963		6 Bolt Valve Cover, (High Temperature) <i>High Temperature Cork Rubber</i>	VS38322H	1
	1962-1963		4 Bolt Valve Cover <i>Cork Rubber</i>	VS38281	1
	1959-1961		<i>Cork Rubber</i>	VS38281	1
Valve Stem Seal, Exh.	1959-1971			B45343	8
Valve Stem Seal, Int.	1959-1971		(Shedder Type)	B45343	8
			(Positive Type) <i>Nitrile</i>	B45403	8
Manifold Set, Exhaust	1959-1971			MS15139	1
Manifold Set, Intake	1959-1971			MS15924	1
Oil Pan Set	1959-1971		<i>Cork Rubber</i>	OS31416	1
Rear Main Seal Set	1962-1971		<i>Rope Packing</i>	JV551	1
				JV604	1
	1961		Except Early 1961 <i>Rope Packing</i>	JV551	1
			Except Early 1961	JV604	1
Timing Cover Set	1959-1971			JV834	1
			(Contains Repair Sleeve)	JV924	1
Timing Cover Gasket	1959-1971			T18750	1
Timing Cover Seal	1959-1971			64573	1
Harmonic Balancer Repair Sleeve	1959-1971		<i>Ground Steel, .020" Thickness</i>	66592RS	1
			Use With Part Number A501 <i>Nickel Plated Formed Steel, .013" Thickness</i>	A224	1

MISCELLANEOUS GASKETS

Air Cleaner Mount Gasket	1970-1971		4 Barrel Carburetor	G27098	1
	1959-1971		2 Barrel Carburetor	G26410	1
Carb. Mount Gasket	1971		Carburetor Number 4964S, 2 Barrel Carburetor	G7328	1
			Except Carburetor Number 4964S, 2 Barrel Carburetor	G14141	1
			Holley R4735A Carburetor, 4 Barrel Carburetor	G14590	1
			Holley R4734A Carburetor, 4 Barrel Carburetor	G14745	1
	1970-1971		Carburetor Number 4964S, Carter Carburetor Numbers 4729S, 4730S, 4895S, 2 Barrel Carburetor	G7328	1
			Except Carburetor Number 4964S, Except Carter Carburetor Numbers 4729S, 4730S, 4895S, 2 Barrel Carburetor	G14141	1
			Holley Carburetor Numbers R4736-1A, R4738-1A, R4739-1A, Holley R4735A Carburetor, 4 Barrel Carburetor	G14590	1
	1970		Carter Carburetor Numbers 4729S, 4730S, 4895S, 2 Barrel Carburetor	G7328	1
			Except Carter Carburetor Numbers 4729S, 4730S, 4895S, 2 Barrel Carburetor	G14141	1
			Holley Carburetor Numbers R4736-1A, R4738-1A, R4739-1A, 4 Barrel Carburetor	G14590	1
	1966-1969		2 Barrel Carburetor	G7328	1
			4 Barrel Carburetor	G14590	1
	1963-1966		4 Barrel Carburetor	G27101	1
	1965		Except Carburetor Number 4125S, 2 Barrel Carburetor	G7328	1
			Carburetor Number 4125S, 2 Barrel Carburetor	G12220	1
	1962-1964		2 Barrel Carburetor	G7328	1
1961		4 Barrel Carburetor	G27101	1	
1960-1961		Except Carburetor Number 2903S, 4 Barrel Carburetor	G27101	1	
1960		Carburetor Number 2903S, 4 Barrel Carburetor	G14569	2	
1959-1960		2 Barrel Carburetor	G7328	1	
Dist. Mounting Gasket	1959-1971			B17926	1
Exhaust Pipe Gasket	1963-1971		Automatic Transmission, Standard Duty Transmission, (Flange Type), Right	F5495C	2
			Standard Duty Transmission, (Flange Type), Left	F5561K	1
	1959-1971		(Flange Type), Pipe To Manifold	F5495C	2
	1966		Automatic Transmission, (Flange Type)	F5495C	2

Chrysler

58 (cont.)	383 CID (6.3L) OHV V8 Cyl, 4.250in./108mm (1959-1971)				58 (cont.)
----------------------	--	--	--	--	----------------------

Part	Year	VIN	Model/Application	Part Number	Qty.
MISCELLANEOUS GASKETS (cont.)					
Exhaust Pipe Gasket (cont.)	1966		Standard Duty Transmission, (Flange Type), Right	F5495C	2
	1963-1964		Automatic Transmission, (Flange Type)	F5495C	2
			Standard Duty Transmission, (Flange Type), Right	F5495C	2
Fuel Pump Gasket	1959-1971			D27094	1
Oil Pan Drain Plug Gst.	1959-1971			2051	1
Oil Pump Cover Gasket	1963-1971			B45558	1
Water Outlet Gasket	1959-1971			C25487	1
Water Pump Mount Gasket	1959-1971		Housing To Block	K26444	2
				K27080	1

59	400 CID (6.6L) OHV V8 Cyl, 4.342in./110.3mm (1972-1978)				59
-----------	--	--	--	--	-----------

Part	Year	VIN	Model/Application	Part Number	Qty.	
ENGINE GASKETS						
Head Set	1972-1978		(Intake Manifold Gasket Not Included)	HS3464VC	1	
Full Set	1972-1978		(Intake Manifold Gasket Not Included)	FS3464VC	1	
Engine Kit Gasket Set	1972-1978		(Intake Manifold Gasket Not Included), Use With Part Number MS15924	95-3344VR	1	
Cylinder Head Gasket	1972-1978		Nitroseal	3464SG	2	
			VR2000	3464VC	2	
Valve Cover Set	1972-1978		Cork Rubber	VS38322	1	
			High Temperature Cork Rubber	VS38322H	1	
Valve Stem Seal, Exh.	1972-1978			B45343	8	
			Fluoroelastomer	B45624	8	
Valve Stem Seal, Int.	1972-1978		(Shedder Type)	B45343	8	
			(Positive Type)	Nitrile	B45403	8
			(Positive Type)	Fluoroelastomer	B45623	8
Manifold Set, Exhaust	1972-1978			MS15139	1	
Manifold Set, Intake	1972-1978			MS15924	1	
Oil Pan Set	1972-1978		Cork Rubber	OS31416	1	
			Tuff-Cork	OS31416TC	1	
Rear Main Seal Set	1972-1978		Rope Packing	JV551	1	
				JV604	1	
Timing Cover Set	1972-1978			JV834	1	
			(Contains Repair Sleeve)	JV924	1	
Timing Cover Gasket	1972-1978			T18750	1	
Timing Cover Seal	1972-1978			64573	1	
Harmonic Balancer Repair Sleeve	1972-1978		Ground Steel, .020" Thickness	66592RS	1	
			Use With Part Number A501 Nickel Plated Formed Steel, .013" Thickness	A224	1	

MISCELLANEOUS GASKETS					
Air Cleaner Mount Gasket	1972-1978		2 Barrel Carburetor	G26410	1
			4 Barrel Carburetor	G27098	1
Carb. Mount Gasket	1973-1978		4 Barrel Carburetor	G14589	1
	1972-1976		2 Barrel Carburetor	G14141	1
	1972		4 Barrel Carburetor	G26662	1
Dist. Mounting Gasket	1972-1978			B17926	1
E.G.R. Gasket	1974-1978			G24081	1
	1974-1976			G24075	1
	1974-1975		4 Barrel Carburetor	G24081	1
				G24081	1
	1972-1975		2 Barrel Carburetor	G24075	1

59 (cont.)	400 CID (6.6L) OHV V8 Cyl, 4.342in./110.3mm (1972-1978)	59 (cont.)
----------------------	--	----------------------

Part	Year	VIN	Model/Application	Part Number	Qty.
MISCELLANEOUS GASKETS (cont.)					
E.G.R. Gasket (cont.)	1972-1974			G24075	1
Exhaust Pipe Gasket	1972-1974		(Flange Type), 4 Barrel Carburetor, Pipe To Manifold	F5495C	2
			(Flange Type), 4 Barrel Carburetor, Pipe To Manifold	F5561K	2
	1972-1973		(Flange Type), 2 Barrel Carburetor, Pipe To Manifold, Right	F5495C	2
			(Flange Type), 2 Barrel Carburetor, Left, Pipe To Manifold	F5561K	1
Fuel Pump Gasket	1972-1978			D27094	1
				<i>Tuff-Cork</i> D27094TC	1
Oil Pan Drain Plug Gst.	1972-1978			2051	1
Oil Pump Cover Gasket	1972-1978			B45558	1
Water Outlet Gasket	1975-1978			C26690	1
	1972-1974			C25487	1
Water Pump Mount Gasket	1972-1978		Housing To Block	K26444	2
				K27080	1

60	413 CID (6.8L) OHV V8 Cyl, 4.188in./106.4mm (1959-1965)	60
-----------	--	-----------

Part	Year	VIN	Model/Application	Part Number	Qty.	
ENGINE GASKETS						
Head Set	1963-1965		6 Bolt Valve Cover, (Intake Manifold Gasket Not Included)	HS3464VC	1	
Full Set	1963-1965		6 Bolt Valve Cover, (Intake Manifold Gasket Not Included)	FS3464VC	1	
Engine Kit Gasket Set	1963-1965		(Intake Manifold Gasket Not Included), Use With Part Number MS15914	95-3344VR	1	
	1959-1962		(Valve Cover Set Not Included, Intake Manifold Gasket Not Included), Use With Part Numbers MS15914, VS38281	95-3344VR	1	
Cylinder Head Gasket	1959-1965		<i>Nitroseal</i>	3464SG	2	
			<i>VR2000</i>	3464VC	2	
Valve Cover Set	1964-1965		<i>Cork Rubber</i>	VS38322	1	
			<i>High Temperature Cork Rubber</i>	VS38322H	1	
			<i>Cork Rubber</i>	VS38322	1	
	1963-1965		6 Bolt Valve Cover	<i>Cork Rubber</i>	VS38322	1
			6 Bolt Valve Cover, (High Temperature)	<i>High Temperature Cork Rubber</i>	VS38322H	1
	1964			<i>Cork Rubber</i>	VS38322	1
			<i>High Temperature Cork Rubber</i>	VS38322H	1	
	1959-1963		4 Bolt Valve Cover	<i>Cork Rubber</i>	VS38281	1
Valve Stem Seal, Exh.	1959-1965			B45343	8	
Valve Stem Seal, Int.	1959-1965			B45343	8	
Manifold Set, Exhaust	1959-1965		1-9/16" X 2-1/8" End Ports	MS10018	1	
			Except Gasket With 1-9/16" X 2-1/8" End Ports	MS15139	1	
Manifold Set, Intake	1959-1965			MS15914	1	
Oil Pan Set	1959-1965		<i>Cork Rubber</i>	OS31416	1	
Rear Main Seal Set	1959-1965		<i>Rope Packing</i>	JV551	1	
				JV604	1	
Timing Cover Set	1959-1965			JV834	1	
			(Contains Repair Sleeve)	JV924	1	
				T18750	1	
Timing Cover Seal	1959-1965			64573	1	
Harmonic Balancer Repair Sleeve	1959-1965		<i>Ground Steel, .020" Thickness</i>	66592RS	1	
			Use With Part Number A501 <i>Nickel Plated Formed Steel, .013" Thickness</i>	A224	1	

MISCELLANEOUS GASKETS

Air Cleaner Mount Gasket	1965		2 Barrel Carburetor	G26410	1
			4 Barrel Carburetor	G27098	1
Carb. Mount Gasket	1963-1965		4 Barrel Carburetor	G27101	1

Chrysler

60 (cont.)	413 CID (6.8L) OHV V8 Cyl, 4.188in./106.4mm (1959-1965)				60 (cont.)
----------------------	--	--	--	--	----------------------

Part	Year	VIN	Model/Application	Part Number	Qty.
MISCELLANEOUS GASKETS (cont.)					
Carb. Mount Gasket (cont.)	1962-1965		2 Siamese Throttle Body Bores, 4 Barrel Carburetor	G27101	1
	1963-1964		2-4 Barrel Carburetors	G27101	1
Dist. Mounting Gasket	1959-1965			B17926	1
Exhaust Pipe Gasket	1965		300L, 880, Coronet, Monaco, Polara, (Flange Type), Pipe To Manifold	F5495C	2
	1963-1965		Crown Imperial, (Flange Type), Pipe To Manifold	F5495C	2
	1962-1965		300, (Flange Type), Pipe To Manifold	F5495C	2
	1959-1965		Crown, Lebaron, New Yorker, (Flange Type), Pipe To Manifold	F5495C	2
	1964		300K, (Flange Type), Pipe To Manifold	F7153	2
	1963		300J, (Flange Type), Pipe To Manifold	F7153	2
	1959-1963		Custom, (Flange Type), Pipe To Manifold	F5495C	2
	1962		300H, Polara, (Flange Type), Pipe To Manifold	F5495C	2
	1961-1962		Dart, (Flange Type), Pipe To Manifold	F5495C	2
	1961		300G, Belvedere, Fury, Savoy, (Flange Type), Pipe To Manifold	F5495C	2
	1959-1961		Crown Imperial, (Flange Type), Pipe To Manifold	F5495C	2
	1960		300F, (Flange Type), Pipe To Manifold	F5495C	2
	1959		300E, (Flange Type), Pipe To Manifold	F5495C	2
Fuel Pump Gasket	1959-1965			D27094	1
Oil Pan Drain Plug Gst.	1959-1965			2051	1
Oil Pump Cover Gasket	1963-1965			B45558	1
Water Outlet Gasket	1959-1965			C25487	1
Water Pump Mount Gasket	1959-1965		Housing To Block	K26444	2
				K27080	1

61	426 CID (7.0L) Hemispherical V8 Cyl, 4.250in./108mm (1964-1971)				61
-----------	--	--	--	--	-----------

Part	Year	VIN	Model/Application	Part Number	Qty.
ENGINE GASKETS					
Cylinder Head Gasket	1966-1971			3447BS	2
Valve Cover Set	1966-1971		<i>Cork Rubber</i>	VS38782	1
			<i>Tuff-Cork</i>	VS38782TC	1
Manifold Set, Intake	1966-1971			MS15179	1
Oil Pan Set	1966-1971		<i>Cork Rubber</i>	OS31416	1
Rear Main Seal Set	1966-1971		<i>Rope Packing</i>	JV551	1
				JV604	1
Timing Cover Set	1966-1971			JV834	1
			(Contains Repair Sleeve)	JV924	1
Timing Cover Gasket	1966-1971			T18750	1
Timing Cover Seal	1966-1971			64573	1
Harmonic Balancer Repair Sleeve	1966-1971		<i>Ground Steel, .020" Thickness</i>	66592RS	1
			Use With Part Number A501 <i>Nickel Plated Formed Steel, .013" Thickness</i>	A224	1

Part	Year	VIN	Model/Application	Part Number	Qty.
MISCELLANEOUS GASKETS					
Air Cleaner Mount Gasket	1966-1971		4 Barrel Carburetor	G27098	1
	1964-1971		2 Barrel Carburetor	G26410	1
Dist. Mounting Gasket	1966-1971			B17926	1
Fuel Pump Gasket	1966-1971			D27094	1
Spark Plug Tube Seal	1966-1971			B45384	8
Water Outlet Gasket	1966-1971			C25487	1
Water Pump Mount Gasket	1966-1971		Housing To Block	K26444	2

PASSENGER CAR

61 (cont.)	426 CID (7.0L) Hemispherical V8 Cyl, 4.250in./108mm (1964-1971)				61 (cont.)
----------------------	--	--	--	--	----------------------

Part	Year	VIN	Model/Application	Part Number	Qty.
MISCELLANEOUS GASKETS (cont.)					
Water Pump Mount Gasket (cont.)	1966-1971			K27080	1

62	426 CID (7.0L) Wedge V8 Cyl, 4.250in./108mm (1963-1965)				62
-----------	--	--	--	--	-----------

Part	Year	VIN	Model/Application	Part Number	Qty.
ENGINE GASKETS					
Head Set	1964-1965		(Intake Manifold Gasket Not Included)	HS3464VC	1
Full Set	1964-1965		(Intake Manifold Gasket Not Included)	FS3464VC	1
Cylinder Head Gasket	1963-1965		Nitroseal	3464SG	2
			VR2000	3464VC	2
Valve Cover Set	1964-1965		Cork Rubber	VS38322	1
			High Temperature Cork Rubber	VS38322H	1
			6 Bolt Valve Cover	VS38322	1
	1963-1964		Cork Rubber	VS38322	1
	1963		4 Bolt Valve Cover	VS38281	1
Valve Stem Seal, Exh.	1963-1965			B45343	8
Valve Stem Seal, Int.	1963-1965			B45343	8
Manifold Set, Exhaust	1964-1965			MS15139	1
	1963			MS10018	1
Manifold Set, Intake	1964-1965			MS15914	1
Oil Pan Set	1963-1965		Cork Rubber	OS31416	1
Rear Main Seal Set	1963-1965		Rope Packing	JV551	1
				JV604	1
Timing Cover Set	1963-1965			JV834	1
			(Contains Repair Sleeve)	JV924	1
Timing Cover Gasket	1963-1965			T18750	1
Timing Cover Seal	1963-1965			64573	1
Harmonic Balancer Repair Sleeve	1963-1965		Ground Steel, .020" Thickness	66592RS	1
			Use With Part Number A501 Nickel Plated Formed Steel, .013" Thickness	A224	1

MISCELLANEOUS GASKETS

Air Cleaner Mount Gasket	1963-1965		2 Barrel Carburetor	G26410	1
			4 Barrel Carburetor	G27098	1
Carb. Mount Gasket	1963-1965		2-4 Barrel Carburetors	G14569	2
			4 Barrel Carburetor	G27101	1
Dist. Mounting Gasket	1963-1965			B17926	1
Exhaust Pipe Gasket	1964-1965		(Flange Type), Pipe To Manifold	F5495C	2
Fuel Pump Gasket	1963-1965			D27094	1
Oil Pan Drain Plug Gst.	1963-1965			2051	1
Water Outlet Gasket	1963-1965			C25487	1
Water Pump Mount Gasket	1963-1965		Housing To Block	K26444	2
				K27080	1

63	440 CID (7.2L) OHV V8 Cyl, 4.320in./109.7mm (1966-1978)				63
-----------	--	--	--	--	-----------

Part	Year	VIN	Model/Application	Part Number	Qty.
ENGINE GASKETS					
Head Set	1966-1978		(Intake Manifold Gasket Not Included)	HS3464VC	1
Full Set	1966-1978		(Intake Manifold Gasket Not Included)	FS3464VC	1
Engine Kit Gasket Set	1966-1978		(Intake Manifold Gasket Not Included), Use With Part Number MS15914	95-3344VR	1
Cylinder Head Gasket	1966-1978		Nitroseal	3464SG	2
			VR2000	3464VC	2
Valve Cover Set	1966-1978		Cork Rubber	VS38322	1

Chrysler

63 440 CID (7.2L) OHV V8 Cyl, 4.320in./109.7mm (1966-1978) **63**
 (cont.) (cont.)

Part	Year	VIN	Model/Application	Part Number	Qty.	
ENGINE GASKETS (cont.)						
Valve Cover Set (cont.)	1966-1978		High Temperature Cork Rubber	VS38322H	1	
Valve Stem Seal, Exh.	1966-1978			B45343	8	
			Fluoroelastomer	B45624	8	
Valve Stem Seal, Int.	1966-1978		(Shedder Type)	B45343	8	
			(Positive Type)	Nitrile	B45403	8
			(Positive Type)	Fluoroelastomer	B45623	8
Manifold Set, Exhaust	1966-1978			MS15139	1	
Manifold Set, Intake	1966-1978			MS15914	1	
Oil Pan Set	1966-1978		(Requires 2 Sets For Use With Windage Tray) Cork Rubber	OS31416	1	
			(Requires 2 Sets For Use With Windage Tray) Tuff-Cork	OS31416TC	1	
Rear Main Seal Set	1966-1978		Rope Packing	JV551	1	
				JV604	1	
Timing Cover Set	1966-1978			JV834	1	
			(Contains Repair Sleeve)	JV924	1	
Timing Cover Gasket	1966-1978			T18750	1	
Timing Cover Seal	1966-1978			64573	1	
Harmonic Balancer Repair Sleeve	1966-1978		Ground Steel, .020" Thickness	66592RS	1	
			Use With Part Number A501 Nickel Plated Formed Steel, .013" Thickness	A224	1	

MISCELLANEOUS GASKETS

Air Cleaner Mount Gasket	1966-1978		4 Barrel Carburetor	G27098	1
	1969		2 Barrel Carburetor	G26410	1
Carb. Mount Gasket	1973-1978		4 Barrel Carburetor	G14589	1
	1972		Carburetor Numbers R6255AAS And R6254AAS, 4 Barrel Carburetor	G14590	1
	1971		Carburetor Number 4968S, 4 Barrel Carburetor	G14745	1
	1967-1969		4 Barrel Carburetor	G14590	1
	1966		4 Barrel Carburetor	G27101	1
Dist. Mounting Gasket	1966-1978			B17926	1
E.G.R. Gasket	1974-1978			G24081	1
	1973			G24084	1
Exhaust Pipe Gasket	1973-1974		Except High Performance, (Flange Type), Pipe To Manifold	F5495C	2
			4 Barrel Carburetor, (Flange Type), Pipe To Manifold	F5561K	2
	1972-1974		High Performance Engine, (Flange Type), Left, Pipe To Manifold	F5495C	2
			High Performance Engine, (Flange Type), Pipe To Manifold, Right	F5561K	1
	1970-1974		4 Barrel Carburetor, (Flange Type), 4 Barrel Carburetor, Pipe To Manifold	F5561K	2
	1966-1974		4 Barrel Carburetor, (Flange Type), Pipe To Manifold	F5561K	2
	1969-1971		High Performance Engine, (Flange Type), Pipe To Manifold	F5561K	2
	1969		Except 4 Barrel Carburetor, Except High Performance, (Flange Type), Pipe To Manifold	F5495C	2
Fuel Pump Gasket	1966-1978			D27094	1
			Tuff-Cork	D27094TC	1
Oil Pan Drain Plug Gst.	1966-1978			2051	1
Oil Pump Cover Gasket	1966-1978			B45558	1
Water Outlet Gasket	1975-1978			C26690	1
	1966-1974			C25487	1
Water Pump Mount Gasket	1966-1978		Housing To Block	K26444	2
				K27080	1

Engine Index

Engine	Year	Block
993CC (1.0L) CB	1988-1992	1

Model Index

Model	Engine	Year	Block
Charade	993CC (1.0L) CB	1988-1992	1

1 993CC (1.0L) CB 3 Cyl, 2.992in./76mm (1988-1992) 1

Part	Year	VIN	Model/Application	Part Number	Qty.
------	------	-----	-------------------	-------------	------

ENGINE GASKETS

Head Set	1988-1992			HS5901	1
Full Set	1988-1992			FS5901	1
Cylinder Head Gasket	1988-1992		Nitroseal	5901	1
Valve Cover Set	1988-1992		(Contains Valve Cover Washers) Victo-Tech	VS50148	1
Valve Stem Seal, Exh.	1988-1992			B45733	3
Valve Stem Seal, Int.	1988-1992			B45733	3
Manifold Set, Exhaust	1988-1992			MS12389	1
Manifold Set, Intake	1988-1992		(Contains Plenum Chamber Gasket)	MS12390	1
Plenum Chamber Gasket	1988-1992			MS12388	1
Oil Pan Set	1988-1992		Victo-Tech	OS32105	1
Rear Main Seal Set	1988-1992			JV1602	1
Timing Cover Set	1988-1992		(Camshaft Seal Not Included)	JV1129	1

MISCELLANEOUS GASKETS

Camshaft Seal	1988-1992			67212	1
E.G.R. Gasket	1988-1992		Valve	G31194	1
			Pipe	G31195	1
Exhaust Pipe Gasket	1988-1992		(Flange Type), Catalytic Converter, Front, Manifold To Converter	F7503	1
Throttle Body Gasket	1988-1992			G31193	1
Water Outlet Gasket	1988-1992			C31191	1
Water Pump Mount Gasket	1988-1992			K31192	1

Eagle Chrysler

Engine Index

Engine	Year	Block
92 CID (1.5L) 12 Valve "Q" Mitsubishi	1991-1996	1
92 CID (1.5L) SOHC 8 Valve "Q" Fuel Injected Mitsubishi	1989-1990	2
92 CID (1.5L) SOHC Jet Valve "Q" Carbureted Mitsubishi	1989-1991	3
98 CID (1.6L) DOHC Mitsubishi	1989-1990	4
107 CID (1.8L) 8 Valve (4G37) Mitsubishi	1993-1994	5
112 CID (1.8L) 16 Valve (4G93) Mitsubishi	1992-1996	6
122 CID (2.0L) DOHC Chrysler	1995-1998	7
122 CID (2.0L) 4G63 DOHC Mitsubishi	1989-1996	8
122 CID (2.0L) 4G63 SOHC 16 Valve Mitsubishi	1993	9

Engine	Year	Block
122 CID (2.0L) 4G63T DOHC TURBO Mitsubishi	1990-1998	10
122 CID (2.0L) SOHC "A" Mitsubishi	1989-1992	11
144 CID (2.4L) 4G64 SOHC 16 Valve Mitsubishi	1993-1996	12
144 CID (2.4L) 4G64 SOHC 8 Valve Mitsubishi	1992	13
150 CID (2.5L) SOHC Renault	1988-1989	14
182 CID (3.0L) SOHC Renault	1990-1992	15
201 CID (3.3L) Chrysler	1993-1997	16
215 CID (3.5L) SOHC Chrysler	1993-1997	17

Model Index

Model	Engine	Year	Block
2000 GTX	122 CID (2.0L) 4G63 SOHC 16 Valve Mitsubishi	1993	9
2000 GTX	122 CID (2.0L) 4G63 DOHC Mitsubishi	1991-1992	8
2000 GTX	122 CID (2.0L) SOHC "A" Mitsubishi	1991-1992	11
Premier	150 CID (2.5L) SOHC Renault	1988	14
Premier	182 CID (3.0L) SOHC Renault	1989-1992	15
Summit	92 CID (1.5L) 12 Valve "Q" Mitsubishi	1991-1996	1

Model	Engine	Year	Block
Summit	92 CID (1.5L) SOHC 8 Valve "Q" Fuel Injected Mitsubishi	1989-1990	2
Summit	98 CID (1.6L) DOHC Mitsubishi	1989-1990	4
Summit	112 CID (1.8L) 16 Valve (4G93) Mitsubishi	1992-1996	6
Summit	144 CID (2.4L) 4G64 SOHC 16 Valve Mitsubishi	1993-1996	12
Summit	144 CID (2.4L) 4G64 SOHC 8 Valve Mitsubishi	1992	13

Eagle Chrysler

Model Index (cont.)

Model	Engine	Year	Block	Model	Engine	Year	Block
Talon	107 CID (1.8L) 8 Valve (4G37) Mitsubishi	1993-1994	5	Vista	92 CID (1.5L) SOHC Jet Valve "Q" Carbureted Mitsubishi	1989-1991	3
Talon	122 CID (2.0L) DOHC Chrysler	1995-1998	7	Vista	98 CID (1.6L) DOHC Mitsubishi	1989-1990	4
Talon	122 CID (2.0L) 4G63T DOHC TURBO Mitsubishi	1990-1998	10	Vista	122 CID (2.0L) 4G63 DOHC Mitsubishi	1989-1991	8
Talon	122 CID (2.0L) 4G63 DOHC Mitsubishi	1990-1994	8	Vista	122 CID (2.0L) SOHC "A" Mitsubishi	1989-1991	11
Vision	201 CID (3.3L) Chrysler	1993-1997	16				
Vision	215 CID (3.5L) SOHC Chrysler	1993-1997	17				
Vista	92 CID (1.5L) 12 Valve "Q" Mitsubishi	1992	1				

1 92 CID (1.5L) 12 Valve "Q" Mitsubishi 4 Cyl, 2.972in./75.5mm (1991-1996) 1

Part	Year	VIN	Model/Application	Part Number	Qty.
------	------	-----	-------------------	-------------	------

ENGINE GASKETS

Head Set	1991-1996		(Exhaust Pipe Gasket Not Included)	HS5907A	1
Full Set	1991-1996		(Exhaust Pipe Gasket Not Included)	FS5907	1
Engine Kit Gasket Set	1991-1994			95-3352VR	1
Cylinder Head Gasket	1991-1996		Nitroseal	5907	1
Valve Cover Set	1991-1996			VS50151	1
Valve Stem Seal, Exh.	1991-1996			B45622	4
Valve Stem Seal, Int.	1991-1996			B45622	8
Manifold Set, Exhaust	1991-1996			MS12395	1
Manifold Set, Intake	1991-1996			MS15983	1
Oil Pan Set	1991-1996		Cork Rubber	OS20674	1
Rear Main Seal Set	1991-1996			JV506	1
Timing Cover Set	1991-1996			JV944	1
Timing Cover Gasket	1991-1996			T26806	1
Timing Cover Seal	1991-1996			47738	1

MISCELLANEOUS GASKETS

Air Flow Sensor	1991-1992			G30807	1
Camshaft Seal	1991-1996			47918	1
E.G.R. Gasket	1991-1996		Nitroseal	G30714	1
Exhaust Pipe Gasket	1993-1996		(Flange Type), Catalytic Converter To Front Exhaust Pipe	F7409	1
			(Flange Type), Catalytic Converter To Center Pipe, Pipe To Manifold	F7422	2
	1991-1996		(Flange Type), Center Pipe To Muffler	F7464	1
	1991-1992		(Flange Type), Catalytic Converter To Center Pipe, Catalytic Converter To Front Exhaust Pipe	F7422	2
			(Flange Type), Pipe To Manifold	F12336	1
Fuel Pump Gasket	1991-1996		Cover To Cylinder Head	D24085	1
Injector Nozzle O-Ring	1991-1996			GS33277	1
Throttle Body Gasket	1991-1992			G31116	1
Water Outlet Gasket	1991-1996			C24082	1
Water Pipe O-Ring	1991-1996			B45797	1
Water Pump Mount Gasket	1991-1996			K26379	1

2 92 CID (1.5L) SOHC 8 Valve "Q" Fuel Injected Mitsubishi 4 Cyl, 2.972in./75.5mm (1989-1990) 2

Part	Year	VIN	Model/Application	Part Number	Qty.
------	------	-----	-------------------	-------------	------

ENGINE GASKETS

Head Set	1989-1990		(Exhaust Pipe Gasket Not Included)	HS3798X	1
Full Set	1989-1990		(Exhaust Pipe Gasket Not Included)	FS3798X	1
Engine Kit Gasket Set	1989-1990		(Intake Manifold Gasket Not Included), Use With Part Number MS15439	95-3349VR	1
Cylinder Head Gasket	1989-1990			3675	1
Valve Cover Set	1989-1990		Victo-Tech	VS38425	1
Valve Stem Seal, Exh.	1989-1990			B45622	4
Valve Stem Seal, Int.	1989-1990			B45622	4

2 (cont.)	92 CID (1.5L) SOHC 8 Valve "Q" Fuel Injected Mitsubishi 4 Cyl, 2.972in./75.5mm (1989-1990)					2 (cont.)
---------------------	---	--	--	--	--	---------------------

Part	Year	VIN	Model/Application	Part Number	Qty.
------	------	-----	-------------------	-------------	------

ENGINE GASKETS (cont.)

Manifold Set, Exhaust	1989-1990			MS12340	1
Manifold Set, Intake	1989-1990		(Contains Plenum Chamber Gasket)	MS15439	1
Plenum Chamber Gasket	1989-1990			MS12338	1
Oil Pan Set	1989-1990		Cork Rubber	OS20674	1
Rear Main Seal Set	1989-1990			JV506	1
Timing Cover Set	1989-1990			JV944	1
Timing Cover Gasket	1989-1990			T26806	1
Timing Cover Seal	1989-1990			47738	1

MISCELLANEOUS GASKETS

Air Flow Sensor	1989-1990			G30807	1
Camshaft Seal	1989-1990			47918	1
E.G.R. Gasket	1989-1990		Nitroseal	G30714	1
Exhaust Pipe Gasket	1989-1990		(Flange Type), Catalytic Converter To Center Pipe, Catalytic Converter To Front Exhaust Pipe	F7422	2
			(Flange Type), Center Pipe To Muffler	F7464	1
			(Flange Type), Pipe To Manifold	F12336	1
Fuel Pump Gasket	1989-1990		Cover To Cylinder Head	D24085	1
Injector Nozzle O-Ring	1989-1990			GS33277	1
Throttle Body Gasket	1990			G31116	1
	1989			G30808	1
Water Outlet Gasket	1989-1990			C24082	1
Water Pump Mount Gasket	1989-1990			K26379	1

3	92 CID (1.5L) SOHC Jet Valve "Q" Carbureted Mitsubishi 4 Cyl, 2.972in./75.5mm (1989-1991)					3
----------	--	--	--	--	--	----------

Part	Year	VIN	Model/Application	Part Number	Qty.
------	------	-----	-------------------	-------------	------

ENGINE GASKETS

Head Set	1989-1991		(Exhaust Pipe Gasket Not Included)	HS3798W	1
Full Set	1989-1991		(Exhaust Pipe Gasket Not Included)	FS3798W	1
Engine Kit Gasket Set	1989-1991		(Contains Seals And O-rings For Jet Valves)	95-3349VR	1
Cylinder Head Gasket	1989-1991			3675	1
Valve Cover Set	1989-1991		Victo-Tech	VS38425	1
Valve Stem Seal, Exh.	1989-1991			B45442	4
Valve Stem Seal, Int.	1989-1991			B45442	4
Manifold Set, Exhaust	1989-1991			MS12340	1
Manifold Set, Intake	1989-1991			MS7391	1
Oil Pan Set	1989-1991		Cork Rubber	OS20674	1
Rear Main Seal Set	1989-1991			JV506	1
Timing Cover Set	1989-1991			JV944	1
Timing Cover Gasket	1989-1991			T26806	1
Timing Cover Seal	1989-1991			47738	1

MISCELLANEOUS GASKETS

Air Cleaner Mount Gasket	1989-1991			G30652	1
Camshaft Seal	1989-1991			47918	1
Carb. Mount Gasket	1989-1991		(Cold Mixture Heater), Top	G30805	1
			(Cold Mixture Heater), Bottom	G30806	1
E.G.R. Gasket	1989-1991		Nitroseal	G30714	1
Exhaust Pipe Gasket	1989-1991		(Flange Type), Catalytic Converter To Front Exhaust Pipe	F7422	1
			(Flange Type), Pipe To Manifold	F12336	1
Fuel Pump Gasket	1989-1991			D24085	2
Jet Valve Seal	1989-1991			B45471	4
Water Outlet Gasket	1989-1991			C24082	1

Eagle Chrysler

3 (cont.)	92 CID (1.5L) SOHC Jet Valve "Q" Carbureted Mitsubishi 4 Cyl, 2.972in./75.5mm (1989-1991)				3 (cont.)
---------------------	--	--	--	--	---------------------

Part	Year	VIN	Model/Application	Part Number	Qty.
------	------	-----	-------------------	-------------	------

MISCELLANEOUS GASKETS (cont.)

Water Pump Mount Gasket	1989-1991			K26379	1
-------------------------	-----------	--	--	--------	---

4	98 CID (1.6L) DOHC Mitsubishi 4 Cyl, 3.240in./82.3mm (1989-1990)				4
----------	---	--	--	--	----------

Part	Year	VIN	Model/Application	Part Number	Qty.
------	------	-----	-------------------	-------------	------

ENGINE GASKETS

Head Set	1989-1990		(Exhaust Pipe Gasket Not Included)	HS5811	1
Full Set	1989-1990		(Exhaust Pipe Gasket Not Included)	FS5811	1
Cylinder Head Gasket	1989-1990		<i>Nitroseal</i>	5875	1
Valve Cover Set	1989-1990		(Contains Spark Plug Tube Seals, Contains Camshaft Semi Circular Plug) style="text-align: right;"> <i>Victo-Tech</i>	VS50066	1
Valve Stem Seal, Exh.	1989-1990			B45622	8
Valve Stem Seal, Int.	1989-1990			B45622	8
Manifold Set, Exhaust	1989-1990		<i>Multi-Layered Steel</i>	MS16215	1
Manifold Set, Intake	1989-1990			MS15976	1
Oil Pan Set	1989-1990		Original Equipment Uses RTV style="text-align: right;"> <i>Silicone</i>	JV6	1
Rear Main Seal Set	1989-1990			JV534	1
Timing Cover Set	1989-1990			JV1072	1
Timing Cover Seal	1989-1990			47730	1

MISCELLANEOUS GASKETS

Air Flow Sensor	1989-1990			G30807	1
Camshaft Seal	1989-1990			47918	2
Cam. Semi-Circular Plug	1989-1990			B45621	1
E.G.R. Gasket	1989-1990		<i>Nitroseal</i>	G30714	1
Exhaust Pipe Gasket	1989-1990		(Flange Type), Pipe To Manifold	F7409	1
			(Flange Type), Catalytic Converter To Center Pipe, Pipe To Converter	F7422	1
			Center Pipe To Muffler	F7464	1
Throttle Body Gasket	1989-1990			G31040	1
Water Outlet Gasket	1989-1990			C24082	1
Water Pump Mount Gasket	1989-1990			K31039	1

5	107 CID (1.8L) 8 Valve (4G37) Mitsubishi 4 Cyl, 3.173in./80.6mm (1993-1994)				5
----------	--	--	--	--	----------

Part	Year	VIN	Model/Application	Part Number	Qty.
------	------	-----	-------------------	-------------	------

ENGINE GASKETS

Head Set	1993-1994		(Exhaust Pipe Gasket Not Included)	HS5812	1
Full Set	1993-1994		(Exhaust Pipe Gasket Not Included)	FS5812	1
Cylinder Head Gasket	1993-1994			5812	1
Valve Cover Set	1993-1994		<i>Victo-Tech</i>	VS39797	1
Manifold Set, Exhaust	1993-1994			MS15980	1
Manifold Set, Intake	1993-1994		(Plenum Chamber Gasket Not Included)	MS15979	1
Oil Pan Set	1993-1994		Original Equipment Uses RTV style="text-align: right;"> <i>Silicone</i>	JV6	1
Rear Main Seal Set	1993-1994			JV506	1
Timing Cover Set	1993-1994			JV1038	1

MISCELLANEOUS GASKETS

Exhaust Pipe Gasket	1993-1994		(Flange Type)	F12336	1
Fuel Pump Gasket	1993-1994			D24077	2
Injector Nozzle O-Ring	1993-1994			GS33277	1
Water Outlet Gasket	1993-1994			C24082	1

6 112 CID (1.8L) 16 Valve (4G93) Mitsubishi 4 Cyl, 3.189in./81mm (1992-1996) 6

Part	Year	VIN	Model/Application	Part Number	Qty.
ENGINE GASKETS					
Head Set	1993-1996			HS54172	1
Cylinder Head Gasket	1992-1996		Nitroseal	54172	1
Valve Cover Set	1992-1995			VS50274	1
Valve Stem Seal, Exh.	1992-1994			B45870	8
Valve Stem Seal, Int.	1992-1994			B45870	8
Manifold Set, Exhaust	1992-1996		Multi-Layered Steel	MS16278	1
Manifold Set, Intake	1993-1994	California		MS16506	1
Oil Pan Set	1993-1994		Cork Rubber	OS32154	1
Rear Main Seal Set	1993-1996			JV1646	1

MISCELLANEOUS GASKETS					
Spark Plug Tube Seal	1992-1996			B45881	1
Throttle Body Gasket	1993-1994			G31526	1
Water Pump Mount Gasket	1993-1994			K31521	1

7 122 CID (2.0L) DOHC Chrysler 4 Cyl, 3.445in./87.5mm (1995-1998) 7

Part	Year	VIN	Model/Application	Part Number	Qty.
ENGINE GASKETS					
Head Set	1995-1998			HS54044B	1
Lower Set	1995-1998			CS54044	1
Engine Kit Gasket Set	1995-1998			95-3457VR	1
Cylinder Head Gasket	1995-1998		Multi-Layered Steel	54044A	1
Cyl. Head Bolt Set	1995-1998			GS33341	1
Valve Cover Set	1995-1998		(Contains Valve Cover Grommets, Spark Plug Tube Seals Not Included) <i>Victo-Tech</i>	VS50234	1
			(Contains Valve Cover Gasket Only) <i>Victo-Tech</i>	VS50234A	1
Valve Stem Seal, Exh.	1995-1998			B45844	8
Valve Stem Seal, Int.	1995-1998			B45844	8
Manifold Set, Exhaust	1995-1998			MS12448	1
Manifold Set, Intake	1995-1998		(Contains Plenum Chamber Gasket)	MS16234	1
Plenum Chamber Gasket	1995-1998			MS16235	1
Oil Pan Set	1995-1998		<i>Victo-Tech</i>	OS50225	1
Rear Main Seal Set	1995-1998		(One Piece) <i>Teflon</i>	JV1629	1
			(One Piece) <i>Rubber</i>	JV1654	1
Timing Cover Set	1995-1998			JV1202	1
Timing Cover Gasket	1995-1998		Inner	T31497	1
			Outer	T31499	1

MISCELLANEOUS GASKETS					
Camshaft Seal	1995-1998		Front	48392	2
Cam Sensor O-Ring	1995-1998			GS33332	1
E.G.R. Gasket	1995-1998		Valve	G31321	1
			Exhaust Gas Recirculation Tube	G31458	1
Exhaust Pipe Gasket	1995-1998		(Flange Type), Catalytic Converter To Center Pipe, Inlet Pipe To Catalytic Converter, Pipe To Manifold	F7409	3
			Center Pipe To Muffler	F10120	1
Spark Plug Tube Seal	1995-1998			B45843	4
Throttle Body Gasket	1995-1998			G31480	1
Valve Cover Grommet	1995-1998			B45846	8
Water Pump Mount Gasket	1995-1998			K31501	1

8 122 CID (2.0L) 4G63 DOHC Mitsubishi 4 Cyl, 3.346in./85mm (1989-1996) 8

Part	Year	VIN	Model/Application	Part Number	Qty.
ENGINE GASKETS					
Head Set	1993-1994		(Exhaust Pipe Gasket Not Included)	HS5875A	1

Eagle Chrysler

8 (cont.)	122 CID (2.0L) 4G63 DOHC Mitsubishi 4 Cyl, 3.346in./85mm (1989-1996)				8 (cont.)
---------------------	---	--	--	--	---------------------

Part	Year	VIN	Model/Application	Part Number	Qty.
ENGINE GASKETS (cont.)					
Head Set (cont.)	1989-1992		(Exhaust Pipe Gasket Not Included)	HS5875	1
Lower Set	1993-1994		(Requires Head Set To Make Full Set)	CS5875A	1
	1989-1992		(Requires Head Set To Make Full Set)	CS5875	1
Full Set	1989-1992		(Exhaust Pipe Gasket Not Included)	FS5875	1
Engine Kit Gasket Set	1989-1992			95-3353VR	1
Cylinder Head Gasket	1989-1994		<i>Nitroseal</i>	5875	1
Valve Cover Set	1993-1996		(Contains Spark Plug Tube Seals, Contains Camshaft Semi Circular Plug) <i>Victo-Tech</i>	VS50252	1
	1989-1992		(Contains Spark Plug Tube Seals, Contains Camshaft Semi Circular Plug) <i>Victo-Tech</i>	VS50066	1
Valve Stem Seal, Exh.	1989-1994			B45622	8
Valve Stem Seal, Int.	1989-1994			B45622	8
Manifold Set, Exhaust	1989-1994		<i>Multi-Layered Steel</i>	MS16215	1
Manifold Set, Intake	1989-1994			MS15976	1
Oil Pan Set	1993-1994		<i>Cork Rubber</i>	OS32137	1
	1989-1992		<i>Cork Rubber</i>	OS32008	1
Rear Main Seal Set	1993-1994			JV1646	1
	1989-1992			JV534	1
Timing Cover Set	1989-1992		(Requires Oil Pan Set)	JV1036	1
Timing Cover Seal	1989-1994			47730	1

MISCELLANEOUS GASKETS

Air Flow Sensor	1989-1992			G30807	1
Camshaft Seal	1989-1994			47918	2
Cam. Semi-Circular Plug	1989-1994			B45621	1
E.G.R. Gasket	1989-1994		<i>Nitroseal</i>	G30714	1
Exhaust Pipe Gasket	1989-1994		(Flange Type), Catalytic Converter To Front Exhaust Pipe	F7409	1
			(Flange Type), Catalytic Converter To Center Pipe	F7422	1
			(Flange Type), Pipe To Manifold	F12336	1
Injector Nozzle O-Ring	1989-1994			GS33277	1
Water Outlet Gasket	1989-1994			C24082	1
Water Pump Mount Gasket	1989-1994			K30615	1

9	122 CID (2.0L) 4G63 SOHC 16 Valve Mitsubishi 4 Cyl, 3.346in./85mm (1993)				9
----------	---	--	--	--	----------

Part	Year	VIN	Model/Application	Part Number	Qty.
ENGINE GASKETS					
Head Set	1993		(Exhaust Pipe Gasket Not Included), Use With Part Number F12336	HS54119	1
Lower Set	1993		(Requires Head Set To Make Full Set)	CS5875A	1
Cylinder Head Gasket	1993		<i>Nitroseal</i>	54119G	1
Valve Cover Set	1993		(Contains Spark Plug Tube Seals) <i>Victo-Tech</i>	VS50267	1
Valve Stem Seal, Exh.	1993			B45870	8
Valve Stem Seal, Int.	1993			B45870	8
Manifold Set, Exhaust	1993			MS16215	1
Manifold Set, Intake	1993			MS16250	1
Oil Pan Set	1993		<i>Cork Rubber</i>	OS32137	1
Rear Main Seal Set	1993			JV1646	1
MISCELLANEOUS GASKETS					
Air Flow Sensor	1993			G30807	1
Camshaft Seal	1993			47918	1
E.G.R. Gasket	1993		<i>Nitroseal</i>	G30714	1
Exhaust Pipe Gasket	1993		(Flange Type), Pipe To Manifold	F12336	1
Injector Nozzle O-Ring	1993			GS33339	1
Spark Plug Tube Seal	1993			B45881	4
Throttle Body Gasket	1993			G31115	1

9 (cont.)	122 CID (2.0L) 4G63 SOHC 16 Valve Mitsubishi 4 Cyl, 3.346in./85mm (1993)				9 (cont.)
---------------------	---	--	--	--	---------------------

Part	Year	VIN	Model/Application	Part Number	Qty.
------	------	-----	-------------------	-------------	------

MISCELLANEOUS GASKETS (cont.)

Water Pump Mount Gasket	1993			K31552	1
-------------------------	------	--	--	--------	---

10	122 CID (2.0L) 4G63T DOHC TURBO Mitsubishi 4 Cyl, 3.346in./85mm (1990-1998)				10
-----------	--	--	--	--	-----------

Part	Year	VIN	Model/Application	Part Number	Qty.
------	------	-----	-------------------	-------------	------

ENGINE GASKETS

Head Set	1993-1994		(Exhaust Pipe Gasket Not Included, Turbocharger Gasket Not Included)	HS5875A	1
	1990-1992		(Exhaust Pipe Gasket Not Included)	HS5875T	1
Lower Set	1993-1998		(Requires Head Set To Make Full Set)	CS5875A	1
	1990-1992		(Requires Head Set To Make Full Set)	CS5875	1
Full Set	1990-1992		(Exhaust Pipe Gasket Not Included)	FS5875T	1
Engine Kit Gasket Set	1990-1992			95-3353VR	1
Cylinder Head Gasket	1990-1998		Nitroseal	5875	1
Valve Cover Set	1993-1998		(Contains Spark Plug Tube Seals, Contains Camshaft Semi Circular Plug)	VS50252	1
	1990-1992		(Contains Spark Plug Tube Seals, Contains Camshaft Semi Circular Plug)	VS50066	1
Valve Stem Seal, Exh.	1990-1998			B45622	8
Valve Stem Seal, Int.	1990-1998			B45622	8
Manifold Set, Exhaust	1990-1998		Multi-Layered Steel	MS16215	1
Manifold Set, Intake	1990-1994			MS15976	1
Oil Pan Set	1993-1998		Cork Rubber	OS32137	1
	1990-1992		Cork Rubber	OS32008	1
Rear Main Seal Set	1993-1998			JV1646	1
	1990-1992			JV534	1
Timing Cover Set	1993-1998		Use With Part Number OS32137	JV5006	1
	1990-1992		(Requires Oil Pan Set), Use With Part Number OS32008	JV1036	1
Timing Cover Seal	1990-1998			47730	1

MISCELLANEOUS GASKETS

Camshaft Seal	1990-1998			47918	2
Cam. Semi-Circular Plug	1990-1998			B45621	1
E.G.R. Gasket	1990-1998		Nitroseal	G30714	1
Exhaust Pipe Gasket	1995-1998		(Flange Type), Catalytic Converter To Center Pipe, Catalytic Converter To Front Exhaust Pipe, Pipe To Manifold	F7409	3
	1990-1998		Exhaust Pipe To Muffler	F10120	1
	1990-1994		(Flange Type), Catalytic Converter To Front Exhaust Pipe, Pipe To Manifold	F7409	2
			(Flange Type), Catalytic Converter To Center Pipe	F7422	1
Injector Nozzle O-Ring	1990-1998			GS33277	1
Throttle Body Gasket	1995-1997			G31558	1
	1991-1994			G31547	1
	1990		From 5/2/90	G31547	1
Turbo Mounting Set	1990-1994			GS33311	1
Water Outlet Gasket	1990-1994			C24082	1
Water Pipe O-Ring	1990-1997			B45797	2
Water Pump Gasket	1995-1997			K31552	1
Water Pump Mount Gasket	1990-1994			K30615	1

11	122 CID (2.0L) SOHC "A" Mitsubishi 4 Cyl, 3.346in./85mm (1989-1992)				11
-----------	--	--	--	--	-----------

Part	Year	VIN	Model/Application	Part Number	Qty.
------	------	-----	-------------------	-------------	------

ENGINE GASKETS

Head Set	1989-1992		(Exhaust Pipe Gasket Not Included)	HS5703Y	1
Lower Set	1989-1992		(Requires Head Set To Make Full Set)	CS5875	1

Eagle Chrysler

11 (cont.)	122 CID (2.0L) SOHC "A" Mitsubishi 4 Cyl, 3.346in./85mm (1989-1992)				11 (cont.)
----------------------	--	--	--	--	----------------------

Part	Year	VIN	Model/Application	Part Number	Qty.
------	------	-----	-------------------	-------------	------

ENGINE GASKETS (cont.)

Full Set	1989-1992		(Exhaust Pipe Gasket Not Included)	FS5703Y	1
Engine Kit Gasket Set	1989-1992		(Contains Seals And O-rings For Jet Valves)	95-3133VR	1
Cylinder Head Gasket	1989-1992		<i>VR2000</i>	5703	1
Cyl. Head Spacer Shim	1989-1992		<i>Steel</i>	5703S	1
Sealing Compound	1989-1992		(4 Ounce Brush Top Can)	JV66B	1
			(12 Ounce Spray Can)	JV66S	1
Valve Cover Set	1989-1992		(Valve Cover Grommets Not Included, Camshaft Semi Circular Plug Not Included) <i>Victo-Tech</i>	VS40003	1
			(Contains Valve Cover Grommets, Contains Camshaft Semi Circular Plug) <i>Victo-Tech</i>	VS40003CP	1
Valve Stem Seal, Exh.	1989-1992		(Original Equipment Type)	B45441	4
			(Premium)	B45806	4
Valve Stem Seal, Int.	1989-1992		(Original Equipment Type)	B45441	4
			(Premium)	B45806	4
Manifold Set, Exhaust	1989-1992			MS15389	1
Manifold Set, Intake	1991-1992		2000 GTX, (Contains Plenum Chamber Gasket)	MS15387Z	1
	1989-1991		Vista, (Contains Plenum Chamber Gasket)	MS15387Y	1
Plenum Chamber Gasket	1991-1992		2000 GTX	MS14902	1
	1989-1991		Vista	MS14900	1
Oil Pan Set	1989-1992		<i>Cork Rubber</i>	OS32008	1
Rear Main Seal Set	1989-1992			JV534	1
Timing Cover Set	1989-1992			JV1036	1
Timing Cover Seal	1989-1992			47730	1

MISCELLANEOUS GASKETS

Air Flow Sensor	1989-1992			G30807	1
Camshaft Seal	1989-1992			47918	1
Cam. Semi-Circular Plug	1989-1992			B24180	1
E.G.R. Gasket	1989-1992		<i>Nitroseal</i>	G30714	1
Exhaust Pipe Gasket	1991-1992		2000 GTX, (Flange Type), Center Pipe To Muffler	F7464	1
			(Flange Type), Catalytic Converter To Front Exhaust Pipe	F7409	1
			(Flange Type), Catalytic Converter To Center Pipe	F7422	1
			(Flange Type), Pipe To Manifold	F12336	1
	1989-1991		Vista, (Flange Type), Center Pipe To Muffler	F7423	1
Injector Nozzle O-Ring	1989-1992			GS33277	1
Throttle Body Gasket	1991-1992		2000 GTX	G31115	1
	1989-1991		Vista	G30808	1
Valve Cover Grommet	1989-1992			B45729	2
Water Outlet Gasket	1989-1992			C24082	1
Water Pump Mount Gasket	1989-1992			K30615	1

12	144 CID (2.4L) 4G64 SOHC 16 Valve Mitsubishi 4 Cyl, 3.405in./86.5mm (1993-1996)				12
-----------	--	--	--	--	-----------

Part	Year	VIN	Model/Application	Part Number	Qty.
------	------	-----	-------------------	-------------	------

ENGINE GASKETS

Head Set	1993-1996		(Exhaust Pipe Flange Gasket Not Included)	HS54119	1
Cylinder Head Gasket	1993-1996		<i>Nitroseal</i>	54119G	1
Valve Cover Set	1993-1996		(Contains Spark Plug Tube Seals) <i>Victo-Tech</i>	VS50267	1
Valve Stem Seal, Exh.	1993-1996			B45870	8
Valve Stem Seal, Int.	1993-1996			B45870	8
Manifold Set, Exhaust	1993-1996		<i>Multi-Layered Steel</i>	MS16215	1
Manifold Set, Intake	1993-1996			MS16250	1
Rear Main Seal Set	1993-1996			JV1646	1
Timing Cover Seal	1996			47730	1

12 (cont.)	144 CID (2.4L) 4G64 SOHC 16 Valve Mitsubishi 4 Cyl, 3.405in./86.5mm (1993-1996)	12 (cont.)
----------------------	--	----------------------

Part	Year	VIN	Model/Application	Part Number	Qty.
------	------	-----	-------------------	-------------	------

MISCELLANEOUS GASKETS

Camshaft Seal	1993-1996		Front	47918	1
E.G.R. Gasket	1993-1996		Nitroseal	G30714	1
Exhaust Pipe Gasket	1993-1996		California Emission, (Flange Type), Catalytic Converter To Center Pipe, Catalytic Converter To Front Exhaust Pipe, Pre-Catalytic Converter To Exhaust Pipe	F7409	2
			Center Pipe To Muffler	F10120	1
			Federal Emission, Pipe To Manifold	F12336	1
Fuel Inj. O-Ring	1996			72011	4
Spark Plug Tube Seal	1993-1996			B45881	1
Throttle Body Gasket	1996			G31558	1
Water Pipe O-Ring	1993-1996			B45797	2
Water Pump Gasket	1994-1996			K31552	1
	1993			K30615	1

13	144 CID (2.4L) 4G64 SOHC 8 Valve Mitsubishi 4 Cyl, 3.405in./86.5mm (1992)	13
-----------	--	-----------

Part	Year	VIN	Model/Application	Part Number	Qty.
------	------	-----	-------------------	-------------	------

ENGINE GASKETS

Head Set	1992		(Exhaust Pipe Gasket Not Included)	HS5747W	1
Lower Set	1992		(Requires Head Set To Make Full Set)	CS5747W	1
Cylinder Head Gasket	1992		Nitroseal	5747	1
Valve Cover Set	1992		(Valve Cover Grommets Not Included, Camshaft Semi Circular Plug Not Included) <i>Victo-Tech</i>	VS40003	1
			(Contains Valve Cover Grommets, Contains Camshaft Semi Circular Plug) <i>Victo-Tech</i>	VS40003CP	1
Valve Stem Seal, Exh.	1992		(Original Equipment Type)	B45441	4
Valve Stem Seal, Int.	1992		(Original Equipment Type)	B45441	4
Manifold Set, Exhaust	1992			MS15389	1
Manifold Set, Intake	1992			MS15387W	1
Plenum Chamber Gasket	1992			MS14902	1
Oil Pan Set	1992		Cork Rubber	OS32008	1
Rear Main Seal Set	1992			JV534	1
Timing Cover Seal	1992			47730	1

MISCELLANEOUS GASKETS

Camshaft Seal	1992			47918	1
Cam. Semi-Circular Plug	1992			B24180	1
E.G.R. Gasket	1992		Nitroseal	G30714	1
Exhaust Pipe Gasket	1992		(Flange Type), Catalytic Converter To Center Pipe, Catalytic Converter To Front Exhaust Pipe	F7422	2
			Center Pipe To Muffler	F10120	1
			(Flange Type), Pipe To Manifold	F12336	1
Injector Nozzle O-Ring	1992			GS33277	1
Water Outlet Gasket	1992			C24082	1
Water Pipe O-Ring	1992			B45797	2
Water Pump Mount Gasket	1992			K30615	1

14	150 CID (2.5L) SOHC Renault 4 Cyl, 3.875in./98.4mm (1988-1989)	14
-----------	---	-----------

Part	Year	VIN	Model/Application	Part Number	Qty.
------	------	-----	-------------------	-------------	------

ENGINE GASKETS

Head Set	1988-1989			HS3799	1
Full Set	1988-1989			FS3799	1
Engine Kit Gasket Set	1988-1989		(Valve Stem Seals Not Included), Use With Part Numbers B45410 (4), B45411 (4)	95-3341VR	1
Cylinder Head Gasket	1988-1989			3799	1

Eagle Chrysler

14 (cont.)	150 CID (2.5L) SOHC Renault 4 Cyl, 3.875in./98.4mm (1988-1989)					14 (cont.)
----------------------	---	--	--	--	--	----------------------

Part	Year	VIN	Model/Application	Part Number	Qty.
------	------	-----	-------------------	-------------	------

ENGINE GASKETS (cont.)

Valve Cover Set	1988-1989		<i>Victo-Tech</i>	VS50001	1
Valve Stem Seal, Exh.	1988-1989			B45411	4
Valve Stem Seal, Int.	1988-1989			B45410	4
Manifold Set, Int. & Exh.	1988-1989			MS15963X	1
Oil Pan Set	1988-1989		<i>Cork Rubber</i>	OS32030	1
Rear Main Seal Set	1988-1989			JV553	1
Timing Cover Set	1988-1989			JV878	1

MISCELLANEOUS GASKETS

Exhaust Pipe Gasket	1988-1989		Catalytic Converter, Catalytic Converter To Exhaust Pipe	F10076	1
Fuel Pump Gasket	1988-1989			D27094	1
			<i>Tuff-Cork</i>	D27094TC	1
Water Outlet Gasket	1988-1989			C24003	1
Water Pump Mount Gasket	1988-1989			K27110	1

15	182 CID (3.0L) SOHC Renault V6 Cyl, 3.661in./93mm (1990-1992)					15
-----------	--	--	--	--	--	-----------

Part	Year	VIN	Model/Application	Part Number	Qty.
------	------	-----	-------------------	-------------	------

MISCELLANEOUS GASKETS

E.G.R. Gasket	1990-1992			G31536	1
Throttle Body Gasket	1990-1992			G31537	1

16	201 CID (3.3L) Chrysler V6 Cyl, 3.661in./93mm (1993-1997)					16
-----------	--	--	--	--	--	-----------

Part	Year	VIN	Model/Application	Part Number	Qty.
------	------	-----	-------------------	-------------	------

ENGINE GASKETS

Head Set	1993-1997		(Head Bolts Not Included, Exhaust Pipe Gasket Not Included, Intake Manifold Gasket Not Included)	HS5892	1
			(Contains Head Bolts, Exhaust Pipe Gasket Not Included, Intake Manifold Gasket Not Included)	HS5892WB	1
Lower Set	1993-1997		(Requires Head Set To Make Full Set)	CS5896	1
Full Set	1993-1997		(Exhaust Pipe Gasket Not Included, Intake Manifold Gasket Not Included)	FS5892	1
Engine Kit Gasket Set	1993-1997		(Intake Manifold Gasket Not Included), Use With Part Number MS15984	95-3446VR	1
Cylinder Head Gasket	1993-1997		Left	<i>Nitroseal</i> 5985G	1
			Right	<i>Nitroseal</i> 5986G	1
Cyl. Head Bolt Set	1997		(Contains Washers)	GS33360	2
	1993-1996			GS33251	2
Cyl. Head Washer Set	1993-1996			GS33256	16
Cyl. Head Spacer Shim	1993-1997		Requires Sealing Compound, Left	<i>Steel</i> 5892S	1
			Requires Sealing Compound, Right	<i>Steel</i> 5893S	1
Sealing Compound	1993-1997		(4 Ounce Brush Top Can)	JV66B	1
			(12 Ounce Spray Can)	JV66S	1
Valve Cover Set	1993-1997		<i>Victo-Tech</i>	VS50143R	1
			<i>Tuff-Cork</i>	VS50143TC	1
Valve Stem Seal, Exh.	1993-1997			B45449	6
Valve Stem Seal, Int.	1993-1997			B45449	6
Manifold Set, Exhaust	1993-1997			MS12399	1
Manifold Set, Intake	1993-1997		(Contains Plenum Chamber Gasket)	MS15984	1
Plenum Chamber Gasket	1993-1997			MS16300	1
Oil Pan Set	1993-1997		<i>Tuff-Cork</i>	OS32103TC	1
			<i>Victo-Tech</i>	OS32111	1
Rear Main Seal	1993-1997			47892	1
Rear Main Seal Set	1993-1997			JV1600	1

16 (cont.)	201 CID (3.3L) Chrysler V6 Cyl, 3.661in./93mm (1993-1997)				16 (cont.)
----------------------	--	--	--	--	----------------------

Part	Year	VIN	Model/Application	Part Number	Qty.
------	------	-----	-------------------	-------------	------

ENGINE GASKETS (cont.)

Timing Cover Set	1993-1997		(Requires Oil Pan Set)	JV1124	1
Timing Cover Seal	1993-1997			48061	1

MISCELLANEOUS GASKETS

E.G.R. Gasket	1996-1997		Exhaust Gas Recirculation Tube	G31554	1
	1993-1997		Valve	G24079	1
	1993-1995		Exhaust Gas Recirculation Tube	G30824	1
Injector Nozzle O-Ring	1993-1997			GS33276	3
Throttle Body Gasket	1993-1997			G30817	1
Water Outlet Gasket	1993-1997			C25163	1
Water Pump Mount Gasket	1993-1997			K31177	1

17	215 CID (3.5L) SOHC Chrysler V6 Cyl, 3.780in./96mm (1993-1997)				17
-----------	---	--	--	--	-----------

Part	Year	VIN	Model/Application	Part Number	Qty.
------	------	-----	-------------------	-------------	------

ENGINE GASKETS

Head Set	1993-1997		(Head Bolts Not Included)	HS5978	1
Lower Set	1993-1997		(Requires Head Set To Make Full Set)	CS5978	1
Engine Kit Gasket Set	1993-1997			95-3477VR	1
Cylinder Head Gasket	1993-1997		Right	Nitroseal 5978	1
			Left	Nitroseal 5979	1
Cyl. Head Bolt Set	1993-1997			GS33326	1
Valve Cover Set	1993-1997			Victo-Tech VS50231	1
Valve Stem Seal, Exh.	1993-1997			B45832	12
Valve Stem Seal, Int.	1993-1997			B45832	12
Manifold Set, Exhaust	1993-1997			MS16138	1
Manifold Set, Intake	1993-1997		(Contains Plenum Chamber Gasket)	MS16130	1
Plenum Chamber Gasket	1993-1997			MS16131	2
Oil Pan Set	1993-1997		(Contains Windage Tray)	Victo-Tech OS32136	1
Rear Main Seal Set	1993-1997			JV1600	1
Timing Cover Set	1993-1997		(Requires Oil Pan Set, Dust Cover Gasket Not Included)	JV1193	1
Timing Cover Seal	1993-1997			48061	1

MISCELLANEOUS GASKETS

Auto. Idle Speed Sensor	1993-1997			G31455	1
E.G.R. Gasket	1993-1997		Valve	G31321	1
			Tube To Valve	G31458	1
			Tube To Plenum	G31474	2
Injector Nozzle O-Ring	1993-1997			GS33279	1
Oil Pan Drain Plug Gst.	1993-1997			2051	1
Throttle Body Gasket	1993-1997			G31456	2
Timing Cover Dust Seal	1993-1997			GS33303	1
Water Outlet Gasket	1993-1997			C25163	1
Water Pump Mount Gasket	1993-1997			K31457	1

Fiat

Engine Index

Engine	Year	Block	Engine	Year	Block
903CC (0.9L) OHV	1971	1	1498CC (1.5L) SOHC	1979-1983	9
1116CC (1.1L) 128A OHC	1971-1973	2	1592CC (1.6L) 125B	1973-1974	10
1197CC (1.2L) 124A OHV	1966-1969	3	1592CC (1.6L) 125BC	1973-1974	11
1197CC (1.2L) 124B OHV	1966-1969	4	1608CC (1.6L) 125A DOHC	1971-1973	12
1197CC (1.2L) 124BL OHV	1966-1969	5	1608CC (1.6L) 125B DOHC	1971-1973	13
1290CC (1.3L) OHC	1972-1979	6	1756CC (1.8L) 132 AB 1 A.O.	1974-1978	14
1438CC (1.4L) 124AC DOHC	1968-1971	7	1756CC (1.8L) DOHC	1978	15
1438CC (1.4L) 124B2 OHV	1970-1973	8	1995CC (2.0L) DOHC	1979-1983	16

Model Index

Model	Engine	Year	Block	Model	Engine	Year	Block
124	1197CC (1.2L) 124A OHV	1966-1971	3	128	1116CC (1.1L) 128A OHC	1969-1973	2
124	1197CC (1.2L) 124B OHV	1966-1971	4	128	1290CC (1.3L) OHC	1972-1979	6
124	1197CC (1.2L) 124BL OHV	1966-1971	5	131	1756CC (1.8L) 132 AB 1 A.O.	1972-1977	14
124	1438CC (1.4L) 124B2 OHV	1970-1973	8	850	903CC (0.9L) OHV	1970-1971	1
124	1438CC (1.4L) 124AC DOHC	1968-1971	7	Brava	1756CC (1.8L) DOHC	1978	15
124	1592CC (1.6L) 125B	1970-1974	10	Brava	1995CC (2.0L) DOHC	1979-1983	16
124	1592CC (1.6L) 125BC	1970-1974	11	Spider 2000	1995CC (2.0L) DOHC	1979-1983	16
124	1608CC (1.6L) 125A DOHC	1971-1973	12	Strada	1498CC (1.5L) SOHC	1979-1982	9
124	1608CC (1.6L) 125B DOHC	1971-1973	13	X-1/9	1290CC (1.3L) OHC	1972-1979	6
124	1756CC (1.8L) 132 AB 1 A.O.	1974-1978	14	X-1/9	1498CC (1.5L) SOHC	1979-1983	9

1 903CC (0.9L) OHV 4 Cyl, 2.559in./65mm (1971) 1

Part	Year	VIN	Model/Application	Part Number	Qty.
------	------	-----	-------------------	-------------	------

ENGINE GASKETS

Valve Stem Seal, Exh.	1971			B45454	4
Valve Stem Seal, Int.	1971			B45454	4

2 1116CC (1.1L) 128A OHC 4 Cyl, 3.150in./80mm (1971-1973) 2

Part	Year	VIN	Model/Application	Part Number	Qty.
------	------	-----	-------------------	-------------	------

ENGINE GASKETS

Head Set	1971-1973			HS3633	1
Cylinder Head Gasket	1971-1973		VR2000	3633	1
Valve Cover Set	1971-1973			VS30038	1
Valve Stem Seal, Exh.	1971-1973			B20192	4
Valve Stem Seal, Int.	1971-1973			B20192	4
Timing Cover Set	1971-1973			JV964	1

MISCELLANEOUS GASKETS

Cam & Idler Seal	1971-1973			66632	3
E.G.R. Gasket	1971-1973			G20193	1
Therm. Housing Gasket	1971-1973			C24136	1
Water Outlet Gasket	1971-1973			C20191	1

3 1197CC (1.2L) 124A OHV 4 Cyl, 2.874in./73mm (1966-1969) 3

Part	Year	VIN	Model/Application	Part Number	Qty.
------	------	-----	-------------------	-------------	------

ENGINE GASKETS

Timing Cover Seal	1966-1969			47927	1
-------------------	-----------	--	--	-------	---

4 1197CC (1.2L) 124B OHV 4 Cyl, 2.874in./73mm (1966-1969) 4

Part	Year	VIN	Model/Application	Part Number	Qty.
------	------	-----	-------------------	-------------	------

ENGINE GASKETS

Timing Cover Seal	1966-1969			47927	1
-------------------	-----------	--	--	-------	---

5 1197CC (1.2L) 124BL OHV 4 Cyl, 2.874in./73mm (1966-1969) 5

Part	Year	VIN	Model/Application	Part Number	Qty.
------	------	-----	-------------------	-------------	------

ENGINE GASKETS

Timing Cover Seal	1966-1969			47927	1
-------------------	-----------	--	--	-------	---

6 1290CC (1.3L) OHC 4 Cyl, 3.386in./86mm (1972-1979) **6**

Part	Year	VIN	Model/Application	Part Number	Qty.
ENGINE GASKETS					
Head Set	1972-1979			HS3703	1
Full Set	1972-1979		(Rear Main Seal Not Included, Timing Cover Seal Not Included)	FS3703	1
Cylinder Head Gasket	1972-1979			3703	1
Valve Cover Set	1972-1979			VS30038	1
Valve Stem Seal, Exh.	1972-1979			B20192	4
Valve Stem Seal, Int.	1972-1979			B20192	4
Timing Cover Set	1972-1979			JV964	1

MISCELLANEOUS GASKETS					
Cam & Idler Seal	1972-1979			66632	3
E.G.R. Gasket	1972-1979			G20193	1
Therm. Housing Gasket	1972-1979			C24136	1
Water Outlet Gasket	1972-1979			C20191	1

7 1438CC (1.4L) 124AC DOHC 4 Cyl, 3.150in./80mm (1968-1971) **7**

Part	Year	VIN	Model/Application	Part Number	Qty.
ENGINE GASKETS					
Cylinder Head Gasket	1968-1971			3631	1
Valve Cover Set	1968-1971			VS30037	1
Valve Stem Seal, Exh.	1968-1971			B20192	4
Valve Stem Seal, Int.	1968-1971			B20192	4
Manifold Set, Exhaust	1968-1971			MS15238	1
Manifold Set, Intake	1968-1971			MS15244	1
Timing Cover Seal	1968-1971			47927	1

MISCELLANEOUS GASKETS					
Cam & Idler Seal	1968-1971			66632	3
E.G.R. Gasket	1968-1971			G20193	1

8 1438CC (1.4L) 124B2 OHV 4 Cyl, 3.150in./80mm (1970-1973) **8**

Part	Year	VIN	Model/Application	Part Number	Qty.
ENGINE GASKETS					
Valve Stem Seal, Exh.	1970-1971			B20192	4
Valve Stem Seal, Int.	1970-1971			B20192	4
Timing Cover Seal	1970-1971			47927	1

MISCELLANEOUS GASKETS					
Cam & Idler Seal	1970-1971			66632	3
E.G.R. Gasket	1970-1973			G20193	1

9 1498CC (1.5L) SOHC 4 Cyl, 3.402in./86.4mm (1979-1983) **9**

Part	Year	VIN	Model/Application	Part Number	Qty.
ENGINE GASKETS					
Head Set	1979-1983			HS3703	1
Full Set	1979-1983			FS3703	1
Cylinder Head Gasket	1979-1983			3703	1
Valve Cover Set	1979-1983			VS30038	1
Valve Stem Seal, Exh.	1979-1983			B20192	4
Valve Stem Seal, Int.	1979-1983			B20192	4
Timing Cover Set	1979-1983			JV964	1

MISCELLANEOUS GASKETS					
Therm. Housing Gasket	1979-1983			C24136	1
Water Outlet Gasket	1979-1983			C20191	1

Fiat

10 1592CC (1.6L) 125B 4 Cyl, 3.150in./80mm (1973-1974) 10

Part	Year	VIN	Model/Application	Part Number	Qty.
------	------	-----	-------------------	-------------	------

ENGINE GASKETS

Valve Cover Set	1973-1974			VS30037	1
Manifold Set, Exhaust	1973-1974			MS15238	1
Manifold Set, Intake	1973-1974			MS15244	1
Oil Pan Set	1973-1974			OS30072	1
Timing Cover Seal	1973-1974			47927	1

MISCELLANEOUS GASKETS

Cam & Idler Seal	1973-1974			66632	3
E.G.R. Gasket	1973-1974			G20193	1
Water Outlet Gasket	1973-1974		Victo-Tech	C45407	1

11 1592CC (1.6L) 125BC 4 Cyl, 3.150in./80mm (1973-1974) 11

Part	Year	VIN	Model/Application	Part Number	Qty.
------	------	-----	-------------------	-------------	------

ENGINE GASKETS

Valve Cover Set	1973-1974			VS30037	1
Manifold Set, Exhaust	1973-1974			MS15238	1
Manifold Set, Intake	1973-1974			MS15244	1
Oil Pan Set	1973-1974			OS30072	1
Timing Cover Seal	1973-1974			47927	1

MISCELLANEOUS GASKETS

Cam & Idler Seal	1973-1974			66632	3
E.G.R. Gasket	1973-1974			G20193	1
Water Outlet Gasket	1973-1974		Victo-Tech	C45407	1

12 1608CC (1.6L) 125A DOHC 4 Cyl, 3.150in./80mm (1971-1973) 12

Part	Year	VIN	Model/Application	Part Number	Qty.
------	------	-----	-------------------	-------------	------

ENGINE GASKETS

Cylinder Head Gasket	1971-1973			3631	1
Valve Cover Set	1971-1973			VS30037	1
Valve Stem Seal, Exh.	1971-1973			B20192	4
Valve Stem Seal, Int.	1971-1973			B20192	4
Manifold Set, Exhaust	1971-1973			MS15238	1
Manifold Set, Intake	1971-1973			MS15244	1
Rear Main Seal Set	1973			JV528	1
Timing Cover Seal	1971-1973			47927	1

MISCELLANEOUS GASKETS

Cam & Idler Seal	1971-1973			66632	3
E.G.R. Gasket	1971-1973			G20193	1

13 1608CC (1.6L) 125B DOHC 4 Cyl, 3.150in./80mm (1971-1973) 13

Part	Year	VIN	Model/Application	Part Number	Qty.
------	------	-----	-------------------	-------------	------

ENGINE GASKETS

Cylinder Head Gasket	1971-1973			3631	1
Valve Cover Set	1971-1973			VS30037	1
Valve Stem Seal, Exh.	1971-1973			B20192	4
Valve Stem Seal, Int.	1971-1973			B20192	4
Manifold Set, Exhaust	1971-1973			MS15238	1
Manifold Set, Intake	1971-1973			MS15244	1
Rear Main Seal Set	1973			JV528	1
Timing Cover Seal	1971-1973			47927	1

MISCELLANEOUS GASKETS

Cam & Idler Seal	1971-1973			66632	3
E.G.R. Gasket	1971-1973			G20193	1

14 1756CC (1.8L) 132 AB 1 A.O. 4 Cyl, 3.307in./84mm (1974-1978) 14					
<i>Part</i>	<i>Year</i>	<i>VIN</i>	<i>Model/Application</i>	<i>Part Number</i>	<i>Qty.</i>
ENGINE GASKETS					
Head Set	1974-1978		Thru Engine Serial Number 431003	HS3635	1
Full Set	1974-1978		Thru Engine Serial Number 431003	FS3635	1
Cylinder Head Gasket	1974-1978			3635	1
Valve Cover Set	1974-1978		Thru Engine Serial Number 431003	VS30037	1
Valve Stem Seal, Exh.	1974-1978			B20192	4
Valve Stem Seal, Int.	1974-1978			B20192	4
Manifold Set, Exhaust	1974-1978		Thru Engine Serial Number 431003	MS15238	1
Manifold Set, Intake	1974-1978		Thru Engine Serial Number 431003	MS15244	1
Oil Pan Set	1974-1978		Thru Engine Serial Number 431003	OS30072	1
Rear Main Seal Set	1974-1978		Thru Engine Serial Number 431003	JV528	1
MISCELLANEOUS GASKETS					
Cam & Idler Seal	1974-1978			66632	3
E.G.R. Gasket	1974-1978			G20193	1
15 1756CC (1.8L) DOHC 4 Cyl, 3.307in./84mm (1978) 15					
<i>Part</i>	<i>Year</i>	<i>VIN</i>	<i>Model/Application</i>	<i>Part Number</i>	<i>Qty.</i>
ENGINE GASKETS					
Head Set	1978			HS3635	1
Full Set	1978			FS3635	1
Cylinder Head Gasket	1978			3635	1
Valve Cover Set	1978			VS30037	1
Valve Stem Seal, Exh.	1978			B20192	4
Valve Stem Seal, Int.	1978			B20192	4
Manifold Set, Intake	1978			MS15244	1
Oil Pan Set	1978			OS30072	1
MISCELLANEOUS GASKETS					
E.G.R. Gasket	1978			G20193	1
16 1995CC (2.0L) DOHC 4 Cyl, 3.307in./84mm (1979-1983) 16					
<i>Part</i>	<i>Year</i>	<i>VIN</i>	<i>Model/Application</i>	<i>Part Number</i>	<i>Qty.</i>
ENGINE GASKETS					
Head Set	1979-1983			HS3635X	1
Full Set	1979-1983			FS3635X	1
Cylinder Head Gasket	1979-1983			3635	1
Valve Cover Set	1979-1983			VS30037	1
Valve Stem Seal, Exh.	1979-1983			B20192	4
Valve Stem Seal, Int.	1979-1983			B20192	4
Manifold Set, Exhaust	1981-1983			MS15238	1
	1979-1980			MS15395	1
Oil Pan Set	1979-1983			OS30586	1
Rear Main Seal Set	1979-1983			JV528	1
MISCELLANEOUS GASKETS					
E.G.R. Gasket	1980-1983			G26702	1
Water Outlet Gasket	1979-1983		<i>Victo-Tech</i>	C45407	1
Water Pump Mount Gasket	1979-1983			K27324	1

Ford

Engine Index

Engine	Year	Block	Engine	Year	Block
81 CID (1.3L) SOHC Mazda	1988-1997	1	241 CID/3950CC (3.9L) DOHC 32 VALVE	2000	46
98 CID (1.6L) SOHC	1981-1985	2	240 CID (4.0L) OHV	1965-1972	47
98 CID (1.6L) SOHC High Output	1982-1985	3	250 CID (4.1L)	1969-1980	48
98 CID (1.6L) OHV	1971-1973	4	255 CID (4.2L) L-Head	1949-1953	49
98 CID (1.6L) DOHC Mazda	1991-1994	5	255 CID (4.2L)	1980-1982	50
98 CID (1.6L) SOHC Mazda	1987-1989	6	256 CID (4.2L)	1954	51
1599CC (1.6L) OHV	1978-1980	7	260 CID (4.3L)	1962-1965	52
112 CID (1.8L) DOHC Mazda	1991-1996	8	272 CID (4.5L)	1955-1957	53
116 CID (1.9L) SOHC	1985-1996	9	281 CID (4.6L) SOHC	1991-2003	54
122 CID (2.0L) SOHC	1997-2003	10	281 CID (4.6L) SOHC CNG	1995-2003	55
122 CID (2.0L) SOHC	1971-1974	11	281 CID (4.6L) DOHC Ford	1993-2002	56
122 CID (2.0L) DOHC Mazda	1993-1997	12	289 CID (4.7L)	1963-1968	57
122 CID (2.0L) SOHC Mazda Diesel	1984-1987	13	292 CID (4.8L)	1955-1962	58
1989CC (2.0L) Zetec/DOHC/16 Valve	1995-2003	14	302 CID (5.0L)	1968-1991	59
1989CC (2.0L) Zetec/DOHC/16 Valve CNG	1996-2000	15	302 CID (5.0L) Boss	1969-1971	60
134 CID (2.2L) SOHC Mazda	1989-1992	16	302 CID (5.0L) High Output	1982-1995	61
140 CID (2.3L) High Swirl Combustion	1984-1994	17	312 CID (5.1L)	1956-1960	62
140 CID (2.3L) SOHC	1974-1993	18	332 CID (5.4L)	1958-1959	63
140 CID (2.3L) SOHC LPG	1984-1985	19	351 CID (5.8L) 351M	1975-1979	64
140 CID (2.3L) Special Vehicle Operation	1986	20	351 CID (5.8L) 351C Ford Cleveland	1970-1974	65
144 CID (2.4L)	1960-1964	21	351 CID (5.8L) Boss Ford Cleveland	1971	66
149 CID (2.4L) BMW Diesel	1984-1985	22	351 CID (5.8L) Cobra Jet Ford Cleveland	1973-1974	67
153 CID (2.5L) High Swirl Combustion	1986-1991	23	351 CID (5.8L) High Output Ford Cleveland	1972	68
153 CID (2.5L) DOHC Mazda	1993-1997	24	351 CID (5.8L) 351W Ford Windsor	1969-1991	69
155 CID (2.5L) Duratec/DOHC/24 Valve	1995-2002	25	352 CID (5.8L)	1958-1966	70
159 CID (2.6L)	1972-1973	26	361 CID (5.9L) Super Express	1958-1959	71
170 CID (2.8L)	1961-1972	27	368 CID (6.0L)	1956-1957	72
171 CID (2.8L) German	1974-1979	28	383 CID (6.3L)	1958-1960	73
2900CC (2.9L) Merkur	1988-1990	29	390 CID (6.4L)	1961-1971	74
181 CID/2967CC (3.0L) Duratec/DOHC/24 Valve	1996-2003	30	400 CID (6.6L) OHV	1971-1979	75
181 CID/2967CC (3.0L) DOHC 24 VALVE Lincoln	2000-2003	31	406 CID (6.7L)	1962-1963	76
183 CID (3.0L) OHV	1986-2003	32	410 CID (6.7L)	1966-1967	77
183 CID (3.0L) OHV Flex Fuel	1993-2003	33	410 CID (6.7L) OHV	1958	78
183 CID (3.0L) SHO DOHC Yamaha	1989-1995	34	427 CID (7.0L) High Performance	1963-1968	79
195 CID (3.2L) SHO DOHC Yamaha	1993-1995	35	427 CID (7.0L) Super High Output	1963-1967	80
200 CID (3.3L) L-Head	1933-1934	36	428 CID (7.0L) Cobra Jet	1966-1970	81
200 CID (3.3L) OHV	1963-1983	37	428 CID (7.0L) Super Cobra Jet	1969-1970	82
212 CID (3.5L) L-Head	1928-1932	38	428 CID (7.0L) Thunderbird	1966-1968	83
215 CID (3.5L)	1952-1953	39	429 CID (7.0L) Boss	1970	84
221 CID (3.6L)	1932-1942	40	429 CID (7.0L) Cobra Jet	1970-1971	85
221 CID (3.6L)	1962-1963	41	429 CID (7.0L) Special	1969-1970	86
223 CID (3.7L)	1954-1964	42	429 CID (7.0L) Super Cobra Jet	1971	87
232 CID (3.8L)	1982-2003	43	429 CID (7.0L) Thunder Jet	1968-1973	88
239 CID (3.9L) L-Head	1939-1953	44	430 CID (7.0L)	1958-1965	89
239 CID (3.9L) OHV	1954	45	460 CID (7.5L)	1968-1978	90
			462 CID (7.6L)	1966-1968	91

Model Index

Model	Engine	Year	Block	Model	Engine	Year	Block
Aspire	81 CID (1.3L) SOHC Mazda	1994-1997	1	Capri	302 CID (5.0L) High Output	1982-1986	61
Bermuda	361 CID (5.9L) Super Express	1958	71	Capri	302 CID (5.0L)	1979-1983	59
Bobcat	140 CID (2.3L) SOHC	1975-1979	18	Capri	368 CID (6.0L)	1956-1957	72
Bobcat	171 CID (2.8L) German	1975-1979	28	Capri	390 CID (6.4L)	1966-1967	74
CORSAIR	332 CID (5.4L)	1959	63	Capri	430 CID (7.0L)	1958-1959	89
CORSAIR	410 CID (6.7L) OHV	1958	78	Citation	410 CID (6.7L) OHV	1958	78
Calienta	170 CID (2.8L)	1964	27	Colony Park	292 CID (4.8L)	1961-1962	58
Calienta	200 CID (3.3L) OHV	1964-1967	37	Colony Park	352 CID (5.8L)	1961-1962	70
Calienta	260 CID (4.3L)	1964	52	Colony Park	368 CID (6.0L)	1957	72
Calienta	289 CID (4.7L)	1964-1966	57	Colony Park	383 CID (6.3L)	1958-1959	73
Calienta	390 CID (6.4L)	1966-1967	74	Colony Park	390 CID (6.4L)	1961-1968	74
Capri	98 CID (1.6L) DOHC Mazda	1991-1994	5	Colony Park	410 CID (6.7L)	1966-1967	77
Capri	98 CID (1.6L) OHV	1971-1973	4	Colony Park	427 CID (7.0L) High Performance	1967	79
Capri	122 CID (2.0L) SOHC	1971-1974	11	Colony Park	428 CID (7.0L) Thunderbird	1966-1968	83
Capri	140 CID (2.3L) SOHC	1976-1986	18	Colony Park	430 CID (7.0L)	1958-1960	89
Capri	159 CID (2.6L)	1972	26	Comet	144 CID (2.4L)	1960-1963	21
Capri	171 CID (2.8L) German	1974-1978	28	Comet	170 CID (2.8L)	1961-1967	27
Capri	200 CID (3.3L) OHV	1966-1982	37	Comet	200 CID (3.3L) OHV	1964-1977	37
Capri	232 CID (3.8L)	1983-1986	43	Comet	250 CID (4.1L)	1969-1977	48
Capri	255 CID (4.2L)	1980-1982	50	Comet	260 CID (4.3L)	1963	52
Capri	289 CID (4.7L)	1966-1967	57				

Model Index (cont.)

Model	Engine	Year	Block	Model	Engine	Year	Block
Comet	289 CID (4.7L)	1964-1967	57	Country Sedan	428 CID (7.0L) Thunderbird	1966-1968	83
Comet	302 CID (5.0L)	1968-1977	59	Country Squire	223 CID (3.7L)	1955-1964	42
Comet	390 CID (6.4L)	1966-1967	74	Country Squire	240 CID (4.0L) OHV	1965-1968	47
Commuter	390 CID (6.4L)	1964-1968	74	Country Squire	272 CID (4.5L)	1955-1957	53
Commuter	410 CID (6.7L)	1966-1967	77	Country Squire	289 CID (4.7L)	1963-1968	57
Commuter	428 CID (7.0L) Cobra Jet	1966-1968	81	Country Squire	292 CID (4.8L)	1955-1962	58
Continental	149 CID (2.4L) BMW Diesel	1984-1985	22	Country Squire	312 CID (5.1L)	1956	62
Continental	232 CID (3.8L)	1982-1994	43	Country Squire	332 CID (5.4L)	1958-1959	63
Continental	281 CID (4.6L) DOHC Ford	1995-2002	56	Country Squire	352 CID (5.8L)	1958-1959	70
Continental	302 CID (5.0L)	1980-1987	59	Crestline	215 CID (3.5L)	1952-1953	39
Continental	351 CID (5.8L) 351W Ford Windsor	1980	69	Crestline	223 CID (3.7L)	1954	42
Continental	400 CID (6.6L) OHV	1977-1979	75	Crestline	239 CID (3.9L) OHV	1954	45
Continental	430 CID (7.0L)	1961-1965	89	Crestline	239 CID (3.9L) L-Head	1950-1954	44
Continental	460 CID (7.5L)	1968-1978	90	Crestline	256 CID (4.2L)	1954	51
Continental	462 CID (7.6L)	1966-1968	91	Crown Victoria	281 CID (4.6L) SOHC	1995-2004	55
Contour	155 CID (2.5L) Duratec/DOHC/24 Valve	1995-2000	25	Crown Victoria	281 CID (4.6L) SOHC	1992-2004	54
Contour	1989CC (2.0L) Zetec/DOHC/16 Valve	1996-2000	15	Crown Victoria	302 CID (5.0L)	1983-1991	59
Contour	1989CC (2.0L) Zetec/DOHC/16 Valve	1995-2000	14	Crown Victoria	351 CID (5.8L) 351W Ford Windsor	1983-1991	69
Cougar	140 CID (2.3L) SOHC	1981-1986	18	Custom	223 CID (3.7L)	1957	42
Cougar	155 CID (2.5L) Duratec/DOHC/24 Valve	1999-2002	25	Custom	239 CID (3.9L) L-Head	1949-1951	44
Cougar	200 CID (3.3L) OHV	1981-1982	37	Custom	240 CID (4.0L) OHV	1965-1972	47
Cougar	232 CID (3.8L)	1982-1997	43	Custom	255 CID (4.2L) L-Head	1952-1953	49
Cougar	255 CID (4.2L)	1980-1982	50	Custom	256 CID (4.2L)	1954	51
Cougar	281 CID (4.6L) SOHC	1994-1997	54	Custom	272 CID (4.5L)	1957	53
Cougar	289 CID (4.7L)	1967	57	Custom	289 CID (4.7L)	1964-1967	57
Cougar	302 CID (5.0L) High Output	1991-1992	61	Custom	292 CID (4.8L)	1955	58
Cougar	302 CID (5.0L) Boss	1969-1971	60	Custom	302 CID (5.0L)	1969-1971	59
Cougar	302 CID (5.0L)	1968-1988	59	Custom	312 CID (5.1L)	1956	62
Cougar	351 CID (5.8L) 351M	1975-1979	64	Custom	351 CID (5.8L) 351C Ford Cleveland	1970-1972	65
Cougar	351 CID (5.8L) 351C Ford Cleveland	1970-1974	65	Custom	351 CID (5.8L) 351W Ford Windsor	1969-1971	69
Cougar	351 CID (5.8L) 351W Ford Windsor	1969-1979	69	Custom	390 CID (6.4L)	1967-1970	74
Cougar	390 CID (6.4L)	1967-1969	74	Custom	400 CID (6.6L) OHV	1971-1972	75
Cougar	400 CID (6.6L) OHV	1974-1978	75	Custom	429 CID (7.0L) Thunder Jet	1969-1971	88
Cougar	427 CID (7.0L) High Performance	1968	79	Custom 300	223 CID (3.7L)	1957-1959	42
Cougar	428 CID (7.0L) Cobra Jet	1968-1969	81	Custom 300	272 CID (4.5L)	1957	53
Cougar	429 CID (7.0L) Super Cobra Jet	1971	87	Custom 300	292 CID (4.8L)	1957-1959	58
Cougar	429 CID (7.0L) Cobra Jet	1970-1971	85	Custom 300	312 CID (5.1L)	1957	62
Cougar	429 CID (7.0L) Thunder Jet	1969	88	Custom 300	332 CID (5.4L)	1958	63
Cougar	460 CID (7.5L)	1974-1976	90	Custom 300	352 CID (5.8L)	1958-1959	70
Cougar	1989CC (2.0L) Zetec/DOHC/16 Valve	1999-2002	14	Custom 500	240 CID (4.0L) OHV	1965-1972	47
Country Sedan	170 CID (2.8L)	1961-1962	27	Custom 500	289 CID (4.7L)	1964-1967	57
Country Sedan	223 CID (3.7L)	1955-1964	42	Custom 500	302 CID (5.0L)	1969-1971	59
Country Sedan	240 CID (4.0L) OHV	1965-1968	47	Custom 500	351 CID (5.8L) 351M	1975-1977	64
Country Sedan	272 CID (4.5L)	1955-1957	53	Custom 500	351 CID (5.8L) Cobra Jet Ford Cleveland	1973-1974	67
Country Sedan	289 CID (4.7L)	1963-1968	57	Custom 500	351 CID (5.8L) High Output Ford Cleveland	1972	68
Country Sedan	292 CID (4.8L)	1957-1962	58	Custom 500	351 CID (5.8L) 351C Ford Cleveland	1971-1974	65
Country Sedan	312 CID (5.1L)	1957	62	Custom 500	351 CID (5.8L) 351W Ford Windsor	1969-1977	69
Country Sedan	332 CID (5.4L)	1958-1959	63	Custom 500	390 CID (6.4L)	1964-1970	74
Country Sedan	352 CID (5.8L)	1958-1963	70	Custom 500	400 CID (6.6L) OHV	1971-1977	75
Country Sedan	390 CID (6.4L)	1961-1968	74	Custom 500	427 CID (7.0L) High Performance	1964-1968	79

Ford

Model Index (cont.)

Model	Engine	Year	Block	Model	Engine	Year	Block
Custom 500	427 CID (7.0L) Super High Output	1964-1967	80	Fairlane 500	351 CID (5.8L) 351W Ford Windsor	1969-1970	69
Custom 500	429 CID (7.0L) Thunder Jet	1969-1971	88	Fairlane 500	352 CID (5.8L)	1958-1967	70
Custom 500	460 CID (7.5L)	1973-1977	90	Fairlane 500	390 CID (6.4L)	1961-1969	74
Customline	215 CID (3.5L)	1952-1953	39	Fairmont	140 CID (2.3L) SOHC	1978-1982	18
Customline	223 CID (3.7L)	1954-1956	42	Fairmont	200 CID (3.3L) OHV	1978-1982	37
Customline	239 CID (3.9L) OHV	1954	45	Fairmont	255 CID (4.2L)	1980-1982	50
Customline	239 CID (3.9L) L-Head	1952-1953	44	Fairmont	302 CID (5.0L)	1978-1979	59
Customline	256 CID (4.2L)	1954	51	Falcon	144 CID (2.4L)	1960-1964	21
Customline	272 CID (4.5L)	1955-1956	53	Falcon	170 CID (2.8L)	1961-1970	27
Cyclone	289 CID (4.7L)	1964-1967	57	Falcon	200 CID (3.3L) OHV	1965-1970	37
Cyclone	302 CID (5.0L)	1968-1969	59	Falcon	250 CID (4.1L)	1970	48
Cyclone	351 CID (5.8L) 351C Ford Cleveland	1970-1971	65	Falcon	260 CID (4.3L)	1964-1965	52
Cyclone	351 CID (5.8L) 351W Ford Windsor	1969-1971	69	Falcon	289 CID (4.7L)	1965-1968	57
Cyclone	390 CID (6.4L)	1966-1969	74	Falcon	302 CID (5.0L)	1969-1970	59
Cyclone	427 CID (7.0L) High Performance	1968	79	Falcon	351 CID (5.8L) 351C Ford Cleveland	1970	65
Cyclone	428 CID (7.0L) Cobra Jet	1968-1969	81	Falcon	351 CID (5.8L) 351W Ford Windsor	1970	69
Cyclone	429 CID (7.0L) Super Cobra Jet	1971	87	Festiva	81 CID (1.3L) SOHC Mazda	1988-1993	1
Cyclone	429 CID (7.0L) Cobra Jet	1970-1971	85	Fiesta	1599CC (1.6L) OHV	1978-1980	7
Cyclone	429 CID (7.0L) Special	1969-1970	86	Focus	122 CID (2.0L) SOHC	2000-2004	10
Cyclone	429 CID (7.0L) Thunder Jet	1969-1971	88	Focus	1989CC (2.0L) Zetec/DOHC/16 Valve	2000-2004	14
Deluxe	221 CID (3.6L)	1938-1942	40	Galaxie	289 CID (4.7L)	1963	57
Deluxe	239 CID (3.9L) L-Head	1946-1951	44	Galaxie	427 CID (7.0L) High Performance	1963	79
EXP	98 CID (1.6L) SOHC High Output	1983-1985	3	Galaxie	427 CID (7.0L) Super High Output	1963	80
EXP	98 CID (1.6L) SOHC	1983-1985	2	Galaxie 500	223 CID (3.7L)	1962-1964	42
EXP	116 CID (1.9L) SOHC	1986-1988	9	Galaxie 500	240 CID (4.0L) OHV	1965-1972	47
Escort	98 CID (1.6L) SOHC High Output	1982-1985	3	Galaxie 500	289 CID (4.7L)	1963-1966	57
Escort	98 CID (1.6L) SOHC	1981-1985	2	Galaxie 500	292 CID (4.8L)	1962	58
Escort	112 CID (1.8L) DOHC Mazda	1991-1996	8	Galaxie 500	302 CID (5.0L)	1968-1972	59
Escort	116 CID (1.9L) SOHC	1985-1996	9	Galaxie 500	351 CID (5.8L) 351C Ford Cleveland	1971-1974	65
Escort	122 CID (2.0L) SOHC	1997-2002	10	Galaxie 500	351 CID (5.8L) 351W Ford Windsor	1971-1974	69
Escort	122 CID (2.0L) SOHC Mazda Diesel	1984-1987	13	Galaxie 500	390 CID (6.4L)	1963-1970	74
Escort	1989CC (2.0L) Zetec/DOHC/16 Valve	1998-2003	14	Galaxie 500	400 CID (6.6L) OHV	1971-1974	75
Fairlane	170 CID (2.8L)	1963-1969	27	Galaxie 500	427 CID (7.0L) High Performance	1963-1968	79
Fairlane	200 CID (3.3L) OHV	1963-1969	37	Galaxie 500	427 CID (7.0L) Super High Output	1963-1967	80
Fairlane	221 CID (3.6L)	1962-1963	41	Galaxie 500	428 CID (7.0L) Thunderbird	1966-1968	83
Fairlane	223 CID (3.7L)	1955-1964	42	Galaxie 500	429 CID (7.0L) Thunder Jet	1969-1971	88
Fairlane	260 CID (4.3L)	1963-1964	52	Gran Torino	250 CID (4.1L)	1972-1973	48
Fairlane	272 CID (4.5L)	1955-1956	53	Gran Torino	302 CID (5.0L)	1972-1976	59
Fairlane	289 CID (4.7L)	1964-1968	57	Gran Torino	351 CID (5.8L) 351M	1975-1976	64
Fairlane	292 CID (4.8L)	1955-1962	58	Gran Torino	351 CID (5.8L) Cobra Jet Ford Cleveland	1973-1974	67
Fairlane	302 CID (5.0L)	1968-1969	59	Gran Torino	351 CID (5.8L) High Output Ford Cleveland	1972	68
Fairlane	312 CID (5.1L)	1956	62	Gran Torino	351 CID (5.8L) 351C Ford Cleveland	1972-1974	65
Fairlane	332 CID (5.4L)	1958-1959	63	Gran Torino	351 CID (5.8L) 351W Ford Windsor	1972-1976	69
Fairlane	351 CID (5.8L) 351W Ford Windsor	1969	69	Gran Torino	400 CID (6.6L) OHV	1972-1976	75
Fairlane	352 CID (5.8L)	1958-1967	70	Gran Torino	460 CID (7.5L)	1973-1976	90
Fairlane	390 CID (6.4L)	1961-1969	74	Granada	140 CID (2.3L) SOHC	1981-1982	18
Fairlane	428 CID (7.0L) Cobra Jet	1969	81	Granada	200 CID (3.3L) OHV	1975-1982	37
Fairlane 500	170 CID (2.8L)	1961-1970	27	Granada	232 CID (3.8L)	1982	43
Fairlane 500	200 CID (3.3L) OHV	1963-1970	37	Granada	250 CID (4.1L)	1975-1979	48
Fairlane 500	221 CID (3.6L)	1962-1963	41	Granada	255 CID (4.2L)	1980	50
Fairlane 500	223 CID (3.7L)	1957-1964	42	Granada	302 CID (5.0L)	1975-1980	59
Fairlane 500	250 CID (4.1L)	1969-1970	48	Granada	351 CID (5.8L) 351M	1975-1977	64
Fairlane 500	260 CID (4.3L)	1963-1964	52	Granada	351 CID (5.8L) 351W Ford Windsor	1975-1977	69
Fairlane 500	272 CID (4.5L)	1957	53	Grand Marquis	281 CID (4.6L) SOHC	1992-2004	54
Fairlane 500	289 CID (4.7L)	1963-1968	57				
Fairlane 500	292 CID (4.8L)	1957-1961	58				
Fairlane 500	302 CID (5.0L)	1969-1970	59				
Fairlane 500	312 CID (5.1L)	1957	62				
Fairlane 500	332 CID (5.4L)	1958-1959	63				
Fairlane 500	351 CID (5.8L) 351C Ford Cleveland	1970	65				

Model Index (cont.)

Model	Engine	Year	Block	Model	Engine	Year	Block
Grand Marquis	302 CID (5.0L)	1980-1991	59	Mark VI	302 CID (5.0L)	1980-1982	59
Grand Marquis	351 CID (5.8L) 351W Ford Windsor	1979-1986	69	Mark VI	351 CID (5.8L) 351W Ford Windsor	1980-1983	69
Grand Marquis	400 CID (6.6L) OHV	1975-1978	75	Mark VII	149 CID (2.4L) BMW Diesel	1984-1985	22
Grand Marquis	460 CID (7.5L)	1975-1978	90	Mark VII	302 CID (5.0L) High Output	1985-1992	61
Grand Marquis	302 CID (5.0L)	1983-1991	59	Mark VII	302 CID (5.0L)	1984-1986	59
Colony Park LN-7	98 CID (1.6L) SOHC High Output	1983	3	Mark VIII	281 CID (4.6L) DOHC Ford	1993-1998	56
LN-7	98 CID (1.6L) SOHC	1982-1983	2	Marquis	140 CID (2.3L) SOHC	1984-1985	19
LS	181 CID/2967CC (3.0L) DOHC 24 VALVE Lincoln	2000-2004	31	Marquis	140 CID (2.3L) SOHC	1983-1986	18
LS	241 CID/3950CC (3.9L) DOHC 32 VALVE	2000-2004	46	Marquis	200 CID (3.3L) OHV	1983	37
LTD	140 CID (2.3L) SOHC	1984-1985	19	Marquis	232 CID (3.8L)	1983-1986	43
LTD	140 CID (2.3L) SOHC	1983-1986	18	Marquis	255 CID (4.2L)	1981-1982	50
LTD	200 CID (3.3L) OHV	1983	37	Marquis	302 CID (5.0L)	1979-1982	59
LTD	232 CID (3.8L)	1983-1986	43	Marquis	351 CID (5.8L) 351M	1975-1978	64
LTD	255 CID (4.2L)	1981-1982	50	Marquis	351 CID (5.8L) 351W Ford Windsor	1978-1982	69
LTD	289 CID (4.7L)	1967	57	Marquis	390 CID (6.4L)	1968-1969	74
LTD	302 CID (5.0L) High Output	1984-1985	61	Marquis	400 CID (6.6L) OHV	1971-1978	75
LTD	302 CID (5.0L)	1968-1982	59	Marquis	410 CID (6.7L)	1967	77
LTD	351 CID (5.8L) 351M	1975-1979	64	Marquis	427 CID (7.0L) High Performance	1967	79
LTD	351 CID (5.8L) 351C Ford Cleveland	1971-1974	65	Marquis	428 CID (7.0L) Cobra Jet	1967-1969	81
LTD	351 CID (5.8L) 351W Ford Windsor	1970-1983	69	Marquis	429 CID (7.0L) Super Cobra Jet	1971	87
LTD	390 CID (6.4L)	1967-1970	74	Marquis	429 CID (7.0L) Thunder Jet	1969-1973	88
LTD	400 CID (6.6L) OHV	1971-1978	75	Marquis	460 CID (7.5L)	1972-1978	90
LTD	429 CID (7.0L) Thunder Jet	1968-1973	88	Maverick	170 CID (2.8L)	1969-1973	27
LTD	460 CID (7.5L)	1973-1978	90	Maverick	200 CID (3.3L) OHV	1969-1977	37
LTD Country Squire	302 CID (5.0L)	1977-1979	59	Maverick	250 CID (4.1L)	1969-1977	48
LTD II	351 CID (5.8L) 351M	1977-1979	64	Maverick	302 CID (5.0L)	1969-1977	59
LTD II	351 CID (5.8L) 351W Ford Windsor	1977-1979	69	Maverick	312 CID (5.1L)	1956	62
LTD II	400 CID (6.6L) OHV	1977-1978	75	Mercury	239 CID (3.9L) L-Head	1939-1948	44
Lynx	98 CID (1.6L) SOHC High Output	1983-1985	3	Mercury	255 CID (4.2L) L-Head	1949-1951	49
Lynx	98 CID (1.6L) SOHC	1981-1985	2	Meteor	170 CID (2.8L)	1962-1963	27
Lynx	116 CID (1.9L) SOHC	1985-1987	9	Meteor	200 CID (3.3L) OHV	1963	37
Lynx	122 CID (2.0L) SOHC Mazda Diesel	1984-1987	13	Meteor	221 CID (3.6L)	1962-1963	41
Mainline	215 CID (3.5L)	1952-1953	39	Meteor	223 CID (3.7L)	1961	42
Mainline	223 CID (3.7L)	1954-1956	42	Meteor	260 CID (4.3L)	1962-1963	52
Mainline	239 CID (3.9L) OHV	1954	45	Meteor	292 CID (4.8L)	1961	58
Mainline	239 CID (3.9L) L-Head	1952-1953	44	Model 01A	221 CID (3.6L)	1940	40
Mainline	256 CID (4.2L)	1954	51	Model 11A	221 CID (3.6L)	1941	40
Mainline	272 CID (4.5L)	1955-1956	53	Model 18	221 CID (3.6L)	1932	40
Mainline	292 CID (4.8L)	1955	58	Model 022A	221 CID (3.6L)	1940	40
Mainline	312 CID (5.1L)	1956	62	Model 40	221 CID (3.6L)	1933	40
Marauder	390 CID (6.4L)	1963-1965	74	Model 48	221 CID (3.6L)	1935	40
Marauder	406 CID (6.7L)	1963	76	Model 68	221 CID (3.6L)	1936	40
Marauder	427 CID (7.0L) High Performance	1964	79	Model 78	221 CID (3.6L)	1937	40
Marauder	427 CID (7.0L) Super High Output	1964-1965	80	Model 81A	221 CID (3.6L)	1938	40
Marauder	429 CID (7.0L) Thunder Jet	1969-1970	88	Model 82A	221 CID (3.6L)	1938	40
Marauder X-100	429 CID (7.0L) Thunder Jet	1969-1970	88	Model 91A	221 CID (3.6L)	1939	40
Mark II	368 CID (6.0L)	1956-1957	72	Model 922A	221 CID (3.6L)	1939	40
Mark IV	430 CID (7.0L)	1959	89	Model A	212 CID (3.5L) L-Head	1928-1931	38
Mark IV	460 CID (7.5L)	1972-1976	90	Model B	200 CID (3.3L) L-Head	1932-1934	36
Mark V	400 CID (6.6L) OHV	1977-1979	75	Model B	212 CID (3.5L) L-Head	1932-1934	38
Mark V	430 CID (7.0L)	1960	89	Monarch	200 CID (3.3L) OHV	1975-1977	37
Mark V	460 CID (7.5L)	1977-1978	90	Monarch	250 CID (4.1L)	1975-1979	48
				Monarch	255 CID (4.2L)	1980	50
				Monarch	302 CID (5.0L)	1975-1980	59
				Monarch	351 CID (5.8L) 351M	1975-1977	64
				Monarch	351 CID (5.8L) 351W Ford Windsor	1975-1977	69
				Montclair	292 CID (4.8L)	1955	58
				Montclair	312 CID (5.1L)	1956-1957	62
				Montclair	368 CID (6.0L)	1957	72
				Montclair	383 CID (6.3L)	1958	73
				Montclair	430 CID (7.0L)	1958-1960	89
				Montego	200 CID (3.3L) OHV	1968	37
				Montego	250 CID (4.1L)	1969-1973	48
				Montego	302 CID (5.0L)	1968-1973	59
				Montego	351 CID (5.8L) 351M	1975-1976	64

Ford

Model Index (cont.)

Model	Engine	Year	Block	Model	Engine	Year	Block
Montego	351 CID (5.8L) Cobra Jet Ford Cleveland	1973-1974	67	Monterey	400 CID (6.6L) OHV	1971-1974	75
Montego	351 CID (5.8L) 351C Ford Cleveland	1970-1974	65	Monterey	406 CID (6.7L)	1962-1963	76
Montego	351 CID (5.8L) 351W Ford Windsor	1969-1976	69	Monterey	410 CID (6.7L)	1966-1967	77
Montego	390 CID (6.4L)	1968-1969	74	Monterey	427 CID (7.0L) High Performance	1964	79
Montego	400 CID (6.6L) OHV	1972-1976	75	Monterey	427 CID (7.0L) Super High Output	1964-1967	80
Montego	427 CID (7.0L) High Performance	1968	79	Monterey	428 CID (7.0L) Cobra Jet	1968-1969	81
Montego	428 CID (7.0L) Cobra Jet	1968-1969	81	Monterey	428 CID (7.0L) Thunderbird	1966-1968	83
Montego	429 CID (7.0L) Super Cobra Jet	1971	87	Monterey	429 CID (7.0L) Cobra Jet	1971	85
Montego	429 CID (7.0L) Cobra Jet	1970-1971	85	Monterey	429 CID (7.0L) Thunder Jet	1969-1973	88
Montego	429 CID (7.0L) Thunder Jet	1969-1973	88	Monterey	430 CID (7.0L)	1958-1960	89
Montego	460 CID (7.5L)	1974-1976	90	Monterey	460 CID (7.5L)	1972-1974	90
Montego MX	200 CID (3.3L) OHV	1968	37	Mustang	140 CID (2.3L) Special Vehicle Operation	1984-1986	20
Montego MX	250 CID (4.1L)	1969-1973	48	Mustang	140 CID (2.3L) SOHC	1974-1992	18
Montego MX	302 CID (5.0L)	1968-1969	59	Mustang	170 CID (2.8L)	1965	27
Montego MX	351 CID (5.8L) 351M	1975-1976	64	Mustang	171 CID (2.8L) German	1974-1979	28
Montego MX	351 CID (5.8L) Cobra Jet Ford Cleveland	1973-1974	67	Mustang	200 CID (3.3L) OHV	1965-1981	37
Montego MX	351 CID (5.8L) 351C Ford Cleveland	1970-1974	65	Mustang	232 CID (3.8L)	1983-2004	43
Montego MX	351 CID (5.8L) 351W Ford Windsor	1969-1976	69	Mustang	250 CID (4.1L)	1969-1973	48
Montego MX	390 CID (6.4L)	1968-1969	74	Mustang	255 CID (4.2L)	1980-1981	50
Montego MX	400 CID (6.6L) OHV	1972-1976	75	Mustang	260 CID (4.3L)	1965	52
Montego MX	427 CID (7.0L) High Performance	1968	79	Mustang	281 CID (4.6L) DOHC Ford	1996-2001	56
Montego MX	428 CID (7.0L) Cobra Jet	1968-1969	81	Mustang	281 CID (4.6L) SOHC	1996-2004	54
Montego MX	429 CID (7.0L) Super Cobra Jet	1971	87	Mustang	289 CID (4.7L)	1965-1968	57
Montego MX	429 CID (7.0L) Cobra Jet	1970-1971	85	Mustang	302 CID (5.0L) High Output	1982-1995	61
Montego MX	429 CID (7.0L) Thunder Jet	1969-1973	88	Mustang	302 CID (5.0L) Boss	1969-1971	60
Montego MX	460 CID (7.5L)	1974-1976	90	Mustang	302 CID (5.0L)	1968-1979	59
Montego MX	250 CID (4.1L)	1970-1973	48	Mustang	351 CID (5.8L) High Output Ford Cleveland	1972	68
Montego MX Brougham	302 CID (5.0L)	1971-1974	59	Mustang	351 CID (5.8L) Boss Ford Cleveland	1971	66
Montego MX Brougham	351 CID (5.8L) 351M	1975-1976	64	Mustang	351 CID (5.8L) 351C Ford Cleveland	1970-1973	65
Montego MX Brougham	351 CID (5.8L) Cobra Jet Ford Cleveland	1973	67	Mustang	351 CID (5.8L) 351W Ford Windsor	1969-1973	69
Montego MX Brougham	351 CID (5.8L) 351C Ford Cleveland	1970-1974	65	Mustang	390 CID (6.4L)	1967	74
Montego MX Brougham	351 CID (5.8L) 351W Ford Windsor	1970-1976	69	Mustang	427 CID (7.0L) High Performance	1968	79
Montego MX Brougham	400 CID (6.6L) OHV	1972-1976	75	Mustang	428 CID (7.0L) Super Cobra Jet	1969-1970	82
Montego MX Brougham	429 CID (7.0L) Super Cobra Jet	1971	87	Mustang	428 CID (7.0L) Cobra Jet	1968-1970	81
Montego MX Brougham	429 CID (7.0L) Cobra Jet	1970-1971	85	Mustang	429 CID (7.0L) Super Cobra Jet	1971	87
Montego MX Brougham	429 CID (7.0L) Thunder Jet	1970-1973	88	Mustang	429 CID (7.0L) Boss	1970	84
Montego MX Brougham	460 CID (7.5L)	1975-1976	90	Mustang	429 CID (7.0L) Cobra Jet	1971	85
Monterey	223 CID (3.7L)	1962	42	Mystique	155 CID (2.5L) Duratec/DOHC/24 Valve	1995-2000	25
Monterey	255 CID (4.2L) L-Head	1950-1953	49	Mystique	1989CC (2.0L) Zetec/DOHC/16 Valve	1995-2000	14
Monterey	256 CID (4.2L)	1954	51	Pacer	361 CID (5.9L) Super Express	1958	71
Monterey	292 CID (4.8L)	1955-1962	58	Parklane	390 CID (6.4L)	1968	74
Monterey	312 CID (5.1L)	1956-1960	62	Parklane	410 CID (6.7L)	1966-1967	77
Monterey	351 CID (5.8L) 351C Ford Cleveland	1971-1973	65	Parklane	427 CID (7.0L) High Performance	1967	79
Monterey	351 CID (5.8L) 351W Ford Windsor	1972-1973	69	Parklane	428 CID (7.0L) Thunderbird	1966-1968	83
Monterey	352 CID (5.8L)	1961-1962	70	Parklane	430 CID (7.0L)	1958-1960	89
Monterey	368 CID (6.0L)	1957	72	Pinto	98 CID (1.6L) OHV	1971-1972	4
Monterey	383 CID (6.3L)	1958-1960	73	Pinto	122 CID (2.0L) SOHC	1971-1974	11
Monterey	390 CID (6.4L)	1961-1970	74	Pinto	140 CID (2.3L) SOHC	1974-1979	18
				Pinto	171 CID (2.8L) German	1975-1979	28
				Premier	368 CID (6.0L)	1956-1957	72
				Premier	430 CID (7.0L)	1958-1960	89
				Probe	122 CID (2.0L) DOHC Mazda	1993-1997	12
				Probe	134 CID (2.2L) SOHC Mazda	1989-1992	16
				Probe	153 CID (2.5L) DOHC Mazda	1993-1997	24
				Probe	183 CID (3.0L) OHV	1990-1992	32
				Ranch Wagon	223 CID (3.7L)	1955-1959	42

Model Index (cont.)

Model	Engine	Year	Block	Model	Engine	Year	Block
Ranch Wagon	240 CID (4.0L) OHV	1965-1968	47	Thunderbird	390 CID (6.4L)	1961-1969	74
Ranch Wagon	272 CID (4.5L)	1955-1957	53	Thunderbird	400 CID (6.6L) OHV	1977-1978	75
Ranch Wagon	289 CID (4.7L)	1965-1968	57	Thunderbird	428 CID (7.0L) Cobra Jet	1968	81
Ranch Wagon	292 CID (4.8L)	1955-1959	58	Thunderbird	428 CID (7.0L) Thunderbird	1966-1968	83
Ranch Wagon	312 CID (5.1L)	1956	62	Thunderbird	429 CID (7.0L) Thunder Jet	1969-1973	88
Ranch Wagon	332 CID (5.4L)	1958-1959	63	Thunderbird	460 CID (7.5L)	1972-1976	90
Ranch Wagon	352 CID (5.8L)	1958-1959	70	Topaz	122 CID (2.0L) SOHC Mazda Diesel	1984-1986	13
Ranger	223 CID (3.7L)	1959	42	Topaz	140 CID (2.3L) High Swirl Combustion	1984-1994	17
Ranger	292 CID (4.8L)	1959	58	Topaz	183 CID (3.0L) OHV	1992-1994	32
Ranger	332 CID (5.4L)	1959	63	Torino	200 CID (3.3L) OHV	1968-1969	37
Ranger	352 CID (5.8L)	1960	70	Torino	250 CID (4.1L)	1969-1973	48
Ranger	361 CID (5.9L) Super Express	1958-1959	71	Torino	289 CID (4.7L)	1968	57
Roundup	361 CID (5.9L) Super Express	1958	71	Torino	302 CID (5.0L)	1969-1975	59
S-55	428 CID (7.0L) Thunderbird	1966	83	Torino	351 CID (5.8L) 351M	1975-1976	64
Sable	153 CID (2.5L) High Swirl	1986	23	Torino	351 CID (5.8L) Cobra Jet Ford Cleveland	1973-1974	67
Sable	181 CID/2967CC (3.0L) Duratec/DOHC/24 Valve	1996-2003	30	Torino	351 CID (5.8L) 351C Ford Cleveland	1970-1974	65
Sable	183 CID (3.0L) OHV	1986-2003	32	Torino	351 CID (5.8L) 351W Ford Windsor	1969-1976	69
Sable	232 CID (3.8L)	1988-1995	43	Torino	390 CID (6.4L)	1969	74
Scorpio	2900CC (2.9L) Merkur	1988-1990	29	Torino	400 CID (6.6L) OHV	1971-1976	75
Super Deluxe	221 CID (3.6L)	1941-1942	40	Torino	428 CID (7.0L) Cobra Jet	1969	81
Super Deluxe	239 CID (3.9L) L-Head	1946-1948	44	Torino	429 CID (7.0L) Cobra Jet	1971	85
Taurus	153 CID (2.5L) High Swirl	1986-1991	23	Torino	460 CID (7.5L)	1973-1976	90
Taurus	181 CID/2967CC (3.0L) Duratec/DOHC/24 Valve	1996-2004	30	Town Car	281 CID (4.6L) SOHC	1991-2004	54
Taurus	183 CID (3.0L) OHV	1993-2004	33	Town Car	302 CID (5.0L) High Output	1984-1985	61
Taurus	183 CID (3.0L) SHO DOHC	1989-1995	34	Town Car	302 CID (5.0L)	1981-1990	59
Taurus	183 CID (3.0L) OHV	1986-2004	32	Tracer	98 CID (1.6L) SOHC Mazda	1987-1989	6
Taurus	195 CID (3.2L) SHO DOHC	1993-1995	35	Tracer	112 CID (1.8L) DOHC Mazda	1991-1996	8
Taurus	232 CID (3.8L)	1988-1995	43	Tracer	116 CID (1.9L) SOHC	1991-1996	9
Tempo	122 CID (2.0L) SOHC Mazda Diesel	1984-1986	13	Tracer	122 CID (2.0L) SOHC	1997-1999	10
Tempo	140 CID (2.3L) High Swirl	1984-1994	17	Turnpike	368 CID (6.0L)	1957	72
Tempo	183 CID (3.0L) OHV	1992-1994	32	Cruiser			
Thunderbird	140 CID (2.3L) SOHC	1983-1988	18	Turnpike	430 CID (7.0L)	1958	89
Thunderbird	200 CID (3.3L) OHV	1980-1982	37	Cruiser			
Thunderbird	232 CID (3.8L)	1982-1997	43	Versailles	302 CID (5.0L)	1977-1980	59
Thunderbird	255 CID (4.2L)	1980-1982	50	Versailles	351 CID (5.8L) 351W Ford	1977	69
Thunderbird	281 CID (4.6L) SOHC	1994-1997	54	Villager	200 CID (3.3L) OHV	1966-1967	37
Thunderbird	302 CID (5.0L) High Output	1991-1992	61	Villager	223 CID (3.7L)	1959	42
Thunderbird	302 CID (5.0L)	1977-1988	59	Villager	289 CID (4.7L)	1966-1967	57
Thunderbird	332 CID (5.4L)	1959	63	Villager	292 CID (4.8L)	1960	58
Thunderbird	351 CID (5.8L) 351M	1977-1979	64	Villager	332 CID (5.4L)	1959	63
Thunderbird	351 CID (5.8L) 351W Ford	1977-1979	69	Villager	352 CID (5.8L)	1960	70
Thunderbird	Windsor			Villager	361 CID (5.9L) Super Express	1958-1959	71
Thunderbird	352 CID (5.8L)	1958-1959	70	Villager	390 CID (6.4L)	1966-1967	74
				Voyager	200 CID (3.3L) OHV	1966-1967	37
				Voyager	289 CID (4.7L)	1966-1967	57
				Voyager	390 CID (6.4L)	1966-1967	74
				XR4Ti	140 CID (2.3L) SOHC	1985-1989	18
				Zephyr	140 CID (2.3L) SOHC	1978-1982	18
				Zephyr	200 CID (3.3L) OHV	1978-1982	37
				Zephyr	255 CID (4.2L)	1980-1982	50
				Zephyr	302 CID (5.0L)	1978-1979	59

1 81 CID (1.3L) SOHC Mazda 4 Cyl, 2.795in./71mm (1988-1997) 1

Part	Year	VIN	Model/Application	Part Number	Qty.
------	------	-----	-------------------	-------------	------

ENGINE GASKETS

Head Set	1988-1992			HS5880	1
Full Set	1988-1992			FS5880	1
Engine Kit Gasket Set	1988-1993			95-3380VR	1
Cylinder Head Gasket	1988-1997			5880	1
Valve Cover Set	1988-1993		Victo-Tech	VS50037	1
Valve Stem Seal, Exh.	1988-1997			B45588	4
Valve Stem Seal, Int.	1988-1997			B45588	4

Ford

1 (cont.)	81 CID (1.3L) SOHC Mazda 4 Cyl, 2.795in./71mm (1988-1997)					1 (cont.)
--------------	---	--	--	--	--	--------------

Part	Year	VIN	Model/Application	Part Number	Qty.
------	------	-----	-------------------	-------------	------

ENGINE GASKETS (cont.)

Manifold Set, Exhaust	1988-1993			MS12378	1
Manifold Set, Intake	1988-1993		(Contains Plenum Chamber Gasket)	MS15664	1
Plenum Chamber Gasket	1988-1993			MS12379	1
Oil Pan Set	1988-1993		<i>Victo-Tech</i>	OS32475	1
Rear Main Seal Set	1988-1997			JV559	1
Timing Cover Set	1993-1997			JV1206	1
	1992		Thru 1/13/92	JV1044	1
			From 1/13/92	JV1206	1
	1988-1991			JV1044	1
Timing Cover Seal	1993-1997			67602	1
	1992		From 1/13/92	67602	1

MISCELLANEOUS GASKETS

Camshaft Seal	1988-1997			47699	1
Carb. Mount Gasket	1988-1989		2 Barrel Carburetor, Spacer To Manifold	G31136	1
			2 Barrel Carburetor, Carburetor To Spacer	G31137	1
Dist. Mounting Gasket	1988-1997			72222	1
E.G.R. Gasket	1988-1993			G30702	1
Exhaust Pipe Gasket	1988-1997		(Flange Type), Pipe To Manifold	F7393	1
Fuel Pump Gasket	1988-1992			D20208	2
Injector Nozzle O-Ring	1989-1997			GS33277	1
Throttle Body Gasket	1994-1997			G31433	1
	1990-1993			G30952	1
Valve Cover Grommet	1988-1996			B45795	6
Water Outlet Gasket	1988-1997		(2 Holes) <i>Victopac</i>	C20115	1
Water Pump Gasket	1988-1997		Inlet	K30740	1
Water Pump Mount Gasket	1988-1997			K30739	1

2	98 CID (1.6L) SOHC 4 Cyl, 3.147in./79.94mm (1981-1985)					2
---	--	--	--	--	--	---

Part	Year	VIN	Model/Application	Part Number	Qty.
------	------	-----	-------------------	-------------	------

ENGINE GASKETS

Head Set	1981-1985		(Head Bolts Not Included, Exhaust Pipe Gasket Not Included)	HS3646	1
			(Contains Head Bolts, Exhaust Pipe Gasket Not Included)	HS3646WB	1
Full Set	1981-1985		(Head Bolts Not Included, Exhaust Pipe Gasket Not Included)	FS3646	1
			(Contains Head Bolts, Exhaust Pipe Gasket Not Included)	FS3646WB	1
Engine Kit Gasket Set	1981-1985		(Head Bolts Not Included), Use With Part Number GS33163	95-3362VR	1
			(Contains Head Bolts)	95-3368VR	1
Cylinder Head Gasket	1981-1985		<i>Nitroseal</i>	5739	1
Cyl. Head Bolt Set	1981-1985			GS33163	1
Cyl. Head Spacer Shim	1981-1985		Requires Sealing Compound <i>Steel</i>	5739S	1
Sealing Compound	1981-1985		(4 Ounce Brush Top Can)	JV66B	1
			(12 Ounce Spray Can)	JV66S	1
Valve Cover Set	1981-1985		<i>Cork Rubber</i>	VS39793	1
			<i>High Temperature Tuff-Cork</i>	VS50026HTC	1
			<i>Victo-Tech</i>	VS50200	1
Valve Stem Seal, Exh.	1981-1985			B45613	4
Valve Stem Seal, Int.	1981-1985			B45613	4
Manifold Set, Exhaust	1981-1985			MS15249	1
Manifold Set, Intake	1981-1985		(Contains Plenum Chamber Gasket)	MS15314W	1
Plenum Chamber Gasket	1983-1985			MS14154	1
Oil Pan Set	1981-1985		<i>Cork Rubber</i>	OS30573	1
Rear Main Seal	1981-1985			47753	1

2 98 CID (1.6L) SOHC 4 Cyl, 3.147in./79.94mm (1981-1985) **2**
(cont.) (cont.)

Part	Year	VIN	Model/Application	Part Number	Qty.
ENGINE GASKETS (cont.)					
Rear Main Seal Set	1981-1985			JV555	1
			(Optional) <i>Teflon</i>	JV1638	1
Crank Repair Sleeve	1981-1985		Use With Part Number A507, Rear <i>Nickel Plated Formed Steel, .013" Thickness</i>	A333	1
			(Oil Pump Housing Machining Required, Remove 0.006" to 0.013" From Each Of The Three Locating Fingers In The Aluminum Pump Housing To Maintain Adequate Clearance Between The Crankshaft And The Oil Pump Housing After Installation Of The Sleeve.), Use With Part Number A508, Front <i>Nickel Plated Formed Steel, .013" Thickness</i>	A334	1
			(Crankshaft Machining Required, Remove 0.026" From The Crankshaft Seal Surface Before Using Sleeve.), Use With Part Number A508, Front <i>Nickel Plated Formed Steel, .013" Thickness</i>	A334G	1
Timing Cover Set	1981-1985		(Camshaft Seal Not Included)	JV954	1
Timing Cover Seal	1981-1985			47752	1

MISCELLANEOUS GASKETS

Camshaft Seal	1981-1985			47751	1
Carb. Mount Gasket	1981-1982		2 Barrel Carburetor	G26862	1
Dist. Mounting Gasket	1981-1985			B45835	1
E.G.R. Gasket	1981-1985			G26702	1
Exhaust Pipe Gasket	1983-1985		EXP, (Ring Type 'F'), Pipe To Converter	F7211	1
			EXP, (Flange Type), Pipe To Manifold	F14750	1
	1982-1985		Escort, Lynx, (Ring Type 'F'), Pipe To Converter	F12298	1
	1981-1985		Escort, Lynx, (Flange Type), Pipe To Manifold	F14750	1
	1983		LN-7, Canadian, (Ring Type 'F'), Pipe To Converter	F7211	1
			LN-7, Except Canadian Models, (Ring Type 'F'), Pipe To Converter	F12298	1
	1982-1983		LN-7, (Flange Type), Pipe To Manifold	F14750	1
1981		Escort, Lynx, (Ring Type 'F'), Pipe To Converter	F7211	1	
Fuel Pump Gasket	1981-1985			D27201	1
Injector Nozzle O-Ring	1983-1985			GS33276	2
Therm. Housing Gasket	1981-1985		<i>Victo-Tech</i>	C31284	1
Throttle Body Gasket	1983-1985			G30940	1
Water Inlet Gasket	1981-1985			C26870	1
Water Outlet Gasket	1981-1985			C26302	1
Water Pump Mount Gasket	1981-1985		Inlet	C26870	1
				K27192	1

3 98 CID (1.6L) SOHC High Output 4 Cyl, 3.147in./79.94mm (1982-1985) **3**

Part	Year	VIN	Model/Application	Part Number	Qty.
ENGINE GASKETS					
Head Set	1982-1985		(Head Bolts Not Included, Exhaust Pipe Gasket Not Included)	HS3646	1
			(Contains Head Bolts, Exhaust Pipe Gasket Not Included)	HS3646WB	1
Full Set	1982-1985		(Head Bolts Not Included, Exhaust Pipe Gasket Not Included)	FS3646	1
			(Contains Head Bolts, Exhaust Pipe Gasket Not Included)	FS3646WB	1
Cylinder Head Gasket	1982-1985		<i>Nitroseal</i>	5739	1
Cyl. Head Bolt Set	1982-1985			GS33163	1
Cyl. Head Spacer Shim	1982-1985		Requires Sealing Compound	<i>Steel</i> 5739S	1
				JV66B	1
Sealing Compound	1982-1985		(4 Ounce Brush Top Can)	JV66B	1
			(12 Ounce Spray Can)	JV66S	1
Valve Cover Set	1982-1985		<i>Cork Rubber</i>	VS39793	1
			<i>High Temperature Tuff-Cork</i>	VS50026HTC	1

Ford

3 (cont.)	98 CID (1.6L) SOHC High Output 4 Cyl, 3.147in./79.94mm (1982-1985)				3 (cont.)
---------------------	---	--	--	--	---------------------

Part	Year	VIN	Model/Application	Part Number	Qty.
------	------	-----	-------------------	-------------	------

ENGINE GASKETS (cont.)

Valve Cover Set (cont.)	1982-1985		<i>Victo-Tech</i>	VS50200	1
Valve Stem Seal, Exh.	1982-1985			B45613	4
Valve Stem Seal, Int.	1982-1985			B45613	4
Manifold Set, Exhaust	1982-1985			MS15249	1
Manifold Set, Intake	1982-1985		(Contains Plenum Chamber Gasket)	MS15314W	1
Oil Pan Set	1982-1985		<i>Cork Rubber</i>	OS30573	1
Rear Main Seal	1982-1985			47753	1
Rear Main Seal Set	1982-1985			JV555	1
			(Optional) <i>Teflon</i>	JV1638	1
Crank Repair Sleeve	1982-1985		(Oil Pump Housing Machining Required, Remove 0.006" to 0.013" From Each Of The Three Locating Fingers In The Aluminum Pump Housing To Maintain Adequate Clearance Between The Crankshaft And The Oil Pump Housing After Installation Of The Sleeve.), Use With Part Number A508 <i>Nickel Plated Formed Steel, .013" Thickness</i>	A334	1
			(Crankshaft Machining Required, Remove 0.026" From The Crankshaft Seal Surface Before Using Sleeve.), Use With Part Number A508 <i>Nickel Plated Formed Steel, .013" Thickness</i>	A334G	1
Timing Cover Set	1982-1985		(Camshaft Seal Not Included)	JV954	1
Timing Cover Seal	1982-1985			47752	1

MISCELLANEOUS GASKETS

Camshaft Seal	1982-1985			47751	1
Carb. Mount Gasket	1982		2 Barrel Carburetor	G26862	1
Dist. Mounting Gasket	1982-1985			B45835	1
E.G.R. Gasket	1982-1985			G26702	1
Exhaust Pipe Gasket	1983-1985		EXP, (Ring Type 'F'), Pipe To Converter	F7211	1
			Lynx, (Ring Type 'F'), Pipe To Converter	F12298	1
			EXP, Lynx, (Flange Type), Pipe To Manifold	F14750	1
	1982-1985		Escort, (Ring Type 'F'), Pipe To Converter	F12298	1
			Escort, (Flange Type), Pipe To Manifold	F14750	1
	1983		LN-7, Canadian, (Ring Type 'F'), Pipe To Converter	F7211	1
			LN-7, Except Canadian Models, (Ring Type 'F'), Pipe To Converter	F12298	1
			LN-7, (Flange Type), Pipe To Manifold	F14750	1
Fuel Pump Gasket	1982-1985		D27201	1	
Therm. Housing Gasket	1982-1985		<i>Victo-Tech</i>	C31284	1
Water Inlet Gasket	1982-1985			C26870	1
Water Outlet Gasket	1982-1985			C26302	1
Water Pump Mount Gasket	1982-1985		Inlet	C26870	1
				K27192	1

4	98 CID (1.6L) OHV 4 Cyl, 3.188in./80.98mm (1971-1973)				4
----------	--	--	--	--	----------

Part	Year	VIN	Model/Application	Part Number	Qty.
------	------	-----	-------------------	-------------	------

ENGINE GASKETS

Head Set	1971-1973		(Exhaust Pipe Gasket Not Included)	HS3468	1
Full Set	1971-1973		(Exhaust Pipe Gasket Not Included)	FS3468	1
Cylinder Head Gasket	1971-1973			3468	1
Valve Cover Set	1971-1973		<i>Cork Rubber</i>	VS39749	1
Valve Stem Seal, Exh.	1971-1973			B45613	4
Valve Stem Seal, Int.	1971-1973			B45613	4
Manifold Set, Exhaust	1971-1973			MS12266	1
Manifold Set, Intake	1971-1973			MS15184	1
Oil Pan Set	1971-1973		<i>Cork Rubber</i>	OS30545	1
Rear Main Seal	1971-1973			47487	1
Rear Main Seal Set	1971-1973			JV615	1

4 98 CID (1.6L) OHV 4 Cyl, 3.188in./80.98mm (1971-1973) **4**
(cont.) (cont.)

Part Year VIN Model/Application Part Number Qty.

ENGINE GASKETS (cont.)

Timing Cover Set	1971-1973			JV875	1
Timing Cover Seal	1971-1973			47486	1

MISCELLANEOUS GASKETS

Carb. Mount Gasket	1971-1973		1 Barrel Carburetor	G24101	1
Exhaust Pipe Gasket	1973		Capri, (Ring Type 'B'), Pipe To Manifold	F7212	1
	1971-1972		Capri, Pinto, (Ring Type 'C'), Pipe To Manifold	F7355	1
	1971		Capri, (Ring Type 'B'), Pipe To Manifold	F7212	1
Fuel Pump Gasket	1971-1973			D27171	1
Water Outlet Gasket	1971-1973			C26651	1
Water Pump Mount Gasket	1971-1973			K27981	1

5 98 CID (1.6L) DOHC Mazda 4 Cyl, 3.071in./78mm (1991-1994) **5**

Part Year VIN Model/Application Part Number Qty.

ENGINE GASKETS

Cylinder Head Gasket	1991-1994			<i>Nitroseal</i> 5868	1
Cyl. Head Spacer Shim	1991-1994		Requires Sealing Compound	<i>Steel</i> 5868S	1
Sealing Compound	1991-1994		(4 Ounce Brush Top Can)	JV66B	1
			(12 Ounce Spray Can)	JV66S	1
Valve Cover Set	1991-1994			<i>Victo-Tech</i> VS50219	1
Valve Stem Seal, Exh.	1991-1994			B45549	8
Valve Stem Seal, Int.	1991-1994			B45549	8
Manifold Set, Exhaust	1991-1994			<i>Multi-Layered Steel</i> MS15633	1
Manifold Set, Intake	1991-1994			MS15631	1
Oil Pan Set	1991-1994		(Requires RTV), Turbocharged	<i>Victo-Tech</i> OS32085	1
			Naturally Aspirated	<i>Victo-Tech</i> OS32475	1
Rear Main Seal Set	1991-1994			JV559	1

MISCELLANEOUS GASKETS

Camshaft Seal	1991-1994			66864	2
Exhaust Pipe Gasket	1991-1994		(Flange Type), Naturally Aspirated, Pipe To Manifold	F7393	1
			(Ring Type 'F'), Front, Pipe To Converter	F10148	1
			(Flange Type), Turbocharged, Pipe To Manifold	F10149	1
Injector Nozzle O-Ring	1991-1994			GS33277	1
Oil Pump Inlet Tube	1991-1994			B45718	1
Oil Pump Mounting Gasket	1991-1994			L45680	1
Water Outlet Gasket	1991-1994		(2 Holes)	<i>Victopac</i> C20115	1
Water Pump By-Pass Seal	1991-1994		(O-Ring Type)	B45807	1
Water Pump Mount Gasket	1991-1994			K30739	1

6 98 CID (1.6L) SOHC Mazda 4 Cyl, 3.071in./78mm (1987-1989) **6**

Part Year VIN Model/Application Part Number Qty.

ENGINE GASKETS

Head Set	1987-1989			HS5736	1
Full Set	1987-1989			FS5736	1
Engine Kit Gasket Set	1987-1989			95-3197VR	1
Cylinder Head Gasket	1987-1989			<i>Nitroseal</i> 5736	1
Valve Cover Set	1987-1989			<i>Victo-Tech</i> VS50037	1
Valve Stem Seal, Exh.	1987-1989			B45588	4
Valve Stem Seal, Int.	1987-1989			B45588	4
Manifold Set, Exhaust	1987-1989			MS12322	1
Manifold Set, Intake	1987-1989		(Contains Plenum Chamber Gasket)	MS12321	1

Ford

6 (cont.)	98 CID (1.6L) SOHC Mazda 4 Cyl, 3.071in./78mm (1987-1989)				6 (cont.)
---------------------	--	--	--	--	---------------------

Part	Year	VIN	Model/Application	Part Number	Qty.
------	------	-----	-------------------	-------------	------

ENGINE GASKETS (cont.)

Plenum Chamber Gasket	1987-1989			MS12347	1
Oil Pan Set	1987-1989		Victo-Tech	OS32475	1
Rear Main Seal	1987-1989			66977	1
Rear Main Seal Set	1987-1989			JV559	1
Timing Cover Set	1987-1989			JV1044	1
Timing Cover Seal	1987-1989			47699	1

MISCELLANEOUS GASKETS

Camshaft Seal	1987-1989			47699	1
Dist. Mounting Gasket	1987-1989			72222	1
E.G.R. Gasket	1987-1989			G30741	1
Exhaust Pipe Gasket	1987-1989		(Flange Type), Pipe To Manifold	F7393	1
Fuel Pump Gasket	1987-1989			D20208	2
Throttle Body Gasket	1987-1989			G30952	2
Valve Cover Grommet	1987-1989			B45795	6
Water Outlet Gasket	1987-1989		(2 Holes) Victopac	C20115	1
Water Pump Mount Gasket	1987-1989			K30739	1

7	1599CC (1.6L) OHV 4 Cyl, 3.188in./80.98mm (1978-1980)				7
----------	--	--	--	--	----------

Part	Year	VIN	Model/Application	Part Number	Qty.
------	------	-----	-------------------	-------------	------

ENGINE GASKETS

Head Set	1978-1980			HS3468W	1
Full Set	1978-1980			FS3468W	1
Cylinder Head Gasket	1978-1980			3468	1
Valve Cover Set	1978-1980		Cork Rubber	VS39792	1
Valve Stem Seal, Exh.	1978-1980			B45613	4
Valve Stem Seal, Int.	1978-1980			B45613	4
Manifold Set, Exhaust	1978-1980			MS12266	1
Manifold Set, Intake	1978-1980			MS15184	1
Oil Pan Set	1978-1980		Cork Rubber	OS30559	1
Rear Main Seal Set	1978-1980			JV615	1
Timing Cover Set	1978-1980			JV946	1

MISCELLANEOUS GASKETS

Carb. Mount Gasket	1978-1980		2 Barrel Carburetor	G27310	1
E.G.R. Gasket	1978-1980			G26700	1
Exhaust Pipe Gasket	1978-1980		(Ring Type 'B'), Pipe To Manifold	F7390	1
Fuel Pump Gasket	1978-1980			D27171	1
Water Outlet Gasket	1978-1980			C26651	1
Water Pump Mount Gasket	1978-1980			K24086	1

8	112 CID (1.8L) DOHC Mazda 4 Cyl, 3.268in./83mm (1991-1996)				8
----------	---	--	--	--	----------

Part	Year	VIN	Model/Application	Part Number	Qty.
------	------	-----	-------------------	-------------	------

ENGINE GASKETS

Head Set	1991-1996			HS5878	1
Lower Set	1991-1996		(Requires Head Set To Make Full Set)	CS5878	1
Full Set	1991		Thru 2/1/91, (Requires RTV)	FS5878	1
Cylinder Head Gasket	1991-1996		Multi-Layered Steel	5878	1
Valve Cover Set	1991-1996		Victo-Tech	VS50135	1
Valve Stem Seal, Exh.	1991-1996			B45549	8
Valve Stem Seal, Int.	1991-1996			B45549	8
Manifold Set, Exhaust	1991-1996		Multi-Layered Steel	MS15646	1
Manifold Set, Intake	1991-1996		(Contains Plenum Chamber Gasket)	MS15647	1

8 112 CID (1.8L) DOHC Mazda 4 Cyl, 3.268in./83mm (1991-1996) **8**
(cont.) (cont.)

Part Year VIN Model/Application Part Number Qty.

ENGINE GASKETS (cont.)

Plenum Chamber Gasket	1991-1996			MS14755	1
Oil Pan Set	1991-1996		(Requires RTV) <i>Victo-Tech</i>	OS32096	1
Rear Main Seal	1991-1996			66977	1
Rear Main Seal Set	1991-1996			JV559	1
Timing Cover Set	1991		Thru 2/1/91, (Camshaft Seals Not Included)	JV1119	1
Timing Cover Seal	1991		Thru 2/1/91	47699	1

MISCELLANEOUS GASKETS

Camshaft Seal	1991-1996			66864	1
Dist. Mounting Gasket	1991-1996			72222	1
Exhaust Pipe Gasket	1991-1995		(Flange Type), Pipe To Converter	F7422	1
			(Flange Type), Pipe To Manifold	F7473	1
Injector Nozzle O-Ring	1991-1996			GS33277	1
Oil Pump Inlet Tube	1991-1996			B45718	1
Oil Pump Mounting Gasket	1991-1996			L45680	1
Throttle Body Gasket	1991-1996			G31190	1
Water Outlet Gasket	1991-1996		(2 Holes) <i>Victopac</i>	C20115	1
Water Pump Gasket	1992		Inlet	K30740	1
	1991		Thru 10/91, Inlet	K30740	1
Water Pump Mount Gasket	1991			K30739	1

9 116 CID (1.9L) SOHC 4 Cyl, 3.226in./81.94mm (1985-1996) **9**

Part Year VIN Model/Application Part Number Qty.

ENGINE GASKETS

Head Set	1992-1996		(Contains Head Bolts)	HS5884	1
	1991		Thru 5/2/91, (Contains Head Bolts, Valve Stem Seals Not Included)	HS5884	1
	1985-1990		(Contains Head Bolts, Exhaust Pipe Gasket Not Included)	HS5739	1
Lower Set	1994-1996		(Requires Head Set To Make Full Set)	CS5884	1
	1993		From 2/10/93, (Requires Head Set To Make Full Set)	CS5884	1
Full Set	1993		Thru 2/10/93, (Contains Head Bolts)	FS5884	1
	1992		(Contains Head Bolts)	FS5884	1
	1991		Thru 5/2/91, (Contains Head Bolts, Valve Stem Seals Not Included)	FS5884	1
	1985-1990		(Contains Head Bolts, Exhaust Pipe Gasket Not Included)	FS5739	1
Engine Kit Gasket Set	1994-1995		(Contains Head Bolts)	95-3382VR	1
	1993		Thru 1/14/93, (Contains Head Bolts)	95-3381VR	1
			From 1/15/93, (Contains Head Bolts)	95-3382VR	1
	1991-1992		(Contains Head Bolts)	95-3381VR	1
	1986-1990		(Contains Head Bolts)	95-3372VR	1
	1985		Cast Valve Cover, (Contains Head Bolts)	95-3372VR	1
Cylinder Head Gasket	1991-1996		<i>Nitroseal</i>	5884	1
	1985-1990		<i>Nitroseal</i>	5739	1
Cyl. Head Bolt Set	1985-1996			GS33163	1
Cyl. Head Spacer Shim	1991-1996		Requires Sealing Compound <i>Steel</i>	5884S	1
	1985-1990		Requires Sealing Compound <i>Steel</i>	5739S	1
Sealing Compound	1985-1996		(4 Ounce Brush Top Can)	JV66B	1
			(12 Ounce Spray Can)	JV66S	1
Valve Cover Set	1991-1996		<i>High Temperature Tuff-Cork</i>	VS39374HTC	1
	1985-1990		Cast Cover <i>High Temperature Tuff-Cork</i>	VS50026HTC	1
			Cast Cover <i>Victo-Tech</i>	VS50200	1
	1985		Stamped Cover <i>Cork Rubber</i>	VS39793	1

Ford

9 (cont.)	116 CID (1.9L) SOHC 4 Cyl, 3.226in./81.94mm (1985-1996)	9 (cont.)
--------------	---	--------------

Part	Year	VIN	Model/Application	Part Number	Qty.
------	------	-----	-------------------	-------------	------

ENGINE GASKETS (cont.)

Valve Stem Seal, Exh.	1992-1996			B45745	4	
	1991		Thru 5/2/91	B45613	4	
			From 5/2/91		B45745	4
	1985-1990			B45613	4	
Valve Stem Seal, Int.	1992-1996			B45745	4	
	1991		Thru 5/2/91	B45613	4	
			From 5/2/91		B45745	4
1985-1990			B45613	4		
Manifold Set, Exhaust	1985-1996			MS15249	1	
Manifold Set, Intake	1991-1996			MS15415	1	
	1987-1990		Central Fuel Injection	MS15415	1	
	1985-1990		(Contains Plenum Chamber Gasket), Multi-Port Fuel Injection	MS15414	1	
Plenum Chamber Gasket	1985-1990			MS15454	1	
Oil Pan Set	1994-1996		<i>Victo-Tech</i>	OS32519	1	
	1993		Thru 2/10/93	<i>Victo-Tech</i>	OS32462	1
			From 2/10/93	<i>Victo-Tech</i>	OS32519	1
	1985-1992		<i>Victo-Tech</i>	OS32462	1	
Rear Main Seal	1985-1996			47753	1	
Rear Main Seal Set	1985-1996			JV555	1	
		(Optional)	<i>Teflon</i>	JV1638	1	
Crank Repair Sleeve	1985-1996		Use With Part Number A507, Rear <i>Nickel Plated Formed Steel, .013" Thickness</i>	A333	1	
			(Oil Pump Housing Machining Required, Remove 0.006" to 0.013" From Each Of The Three Locating Fingers In The Aluminum Pump Housing To Maintain Adequate Clearance Between The Crankshaft And The Oil Pump Housing After Installation Of The Sleeve.), Use With Part Number A508, Front <i>Nickel Plated Formed Steel, .013" Thickness</i>	A334	1	
			(Crankshaft Machining Required, Remove 0.026" From The Crankshaft Seal Surface Before Using Sleeve.), Use With Part Number A508, Front <i>Nickel Plated Formed Steel, .013" Thickness</i>	A334G	1	
Timing Cover Set	1985-1996		(Camshaft Seal Not Included)	JV954	1	
Timing Cover Seal	1985-1996			47752	1	

MISCELLANEOUS GASKETS

Air Cleaner Mount Gasket	1987-1990		Central Fuel Injection	G31429	1
	1987-1988			G31429	1
			Central Fuel Injection	G31429	1
	1987			G31429	1
		Multi-Port Fuel Injection	G31429	1	
Camshaft Seal	1985-1996			47751	1
Dist. Mounting Gasket	1985-1990			B45835	1
E.G.R. Gasket	1991-1996			G30625	1
	1987-1990		Multi-Port Fuel Injection	G26702	1
			Central Fuel Injection	G30625	1
	1987-1988			G30625	1
			Central Fuel Injection	G30625	1
	1985-1987			G26702	1
Exhaust Pipe Gasket	1991-1995		Escort, (Flange Type), Pipe To Converter	F7486	1
	1986-1990		Escort, (Ring Type 'F'), Pipe To Converter	F12298	1
			Escort, (Flange Type), Pipe To Manifold	F14750	1
			(Ring Type 'F'), Pipe To Converter	F12298	1
	1986-1988		(Flange Type), Pipe To Manifold	F14750	1
			Lynx, (Ring Type 'F'), Pipe To Converter	F12298	1
1985-1987		Lynx, (Flange Type), Pipe To Manifold	F14750	1	
Fuel Pump Gasket	1985-1986			D27201	1

9 116 CID (1.9L) SOHC 4 Cyl, 3.226in./81.94mm (1985-1996) **9**
(cont.) (cont.)

Part	Year	VIN	Model/Application	Part Number	Qty.
MISCELLANEOUS GASKETS (cont.)					
Injector Nozzle O-Ring	1985-1996			GS33276	2
Thermostat Seal	1990		Victo-Tech	C31284	1
Throttle Body Gasket	1994-1996			G31435	1
	1991-1993			G31434	1
	1985-1990			G30940	1
Water Outlet Gasket	1991-1996			C26235	1
	1985-1990			C26302	1
Water Pump Mount Gasket	1991-1996			K27987	1
		1985-1990	Inlet	C26870	1
				K30626	1

10 122 CID (2.0L) SOHC 4 Cyl, 3.339in./84.8mm (1997-2003) **10**

Part	Year	VIN	Model/Application	Part Number	Qty.
ENGINE GASKETS					
Head Set	2000-2003		Focus, (Head Bolts Not Included)	HS54350A	1
	2000-2002		Escort, (Head Bolts Not Included)	HS54350	1
	1997-1999		(Head Bolts Not Included)	HS54227	1
Lower Set	1997-2003		(Requires Head Set To Make Full Set)	CS5884	1
Cylinder Head Gasket	2000-2003		Multi-Layered Steel	54350	1
	1997-1999		Nitroseal	54227	1
Cyl. Head Bolt Set	1997-2003			GS33163	1
Valve Cover Set	1998-2003		(Contains Valve Cover Grommets) Victo-Foam	VS50277A	1
	1997		(Contains Valve Cover Grommets) Victo-Foam	VS50277	1
Valve Stem Seal, Exh.	1997-2003			B45745	4
Valve Stem Seal, Int.	1997-2003			B45745	4
Manifold Set, Exhaust	1997-2003			MS15249	1
Manifold Set, Intake	2000-2003		Focus, (Contains Plenum) Victo-Tech	MS16347	1
	2000-2002		Escort, (Contains Plenum Chamber Gasket) Victo-Tech	MS16298	1
	1997-1999		(Contains Plenum Chamber Gasket) Victo-Tech	MS16298	1
Oil Pan Set	1997-2003			OS32519	1
Rear Main Seal	1997-2003			47753	1
Rear Main Seal Set	1997-2003			JV555	1
Timing Cover Seal	1997-2001			47918	1

MISCELLANEOUS GASKETS					
Camshaft Seal	1997-2003			47751	1
E.G.R. Gasket	1997-2003		Valve	G30625	1
	1997-2001		Exhaust Manifold To EGR Inlet Pipe	G31415	1
Therm. Housing Set	2000-2003		Focus Victo-Tech	GS33382	1
Throttle Body Gasket	2000-2003		Focus	G31623	1
	2000-2001		Escort	G31576	1
	1997-1999			G31576	1
Water Outlet Gasket	1997-1999			C26235	1
Water Pump Gasket	2000-2003		Focus	K31622	1
	2000-2002		Escort	K27987	1
	1997-1999			K27987	1

11 122 CID (2.0L) SOHC 4 Cyl, 3.578in./90.8mm (1971-1974) **11**

Part	Year	VIN	Model/Application	Part Number	Qty.
ENGINE GASKETS					
Head Set	1971-1974		(Exhaust Pipe Gasket Not Included)	HS3469VC	1
Full Set	1971-1974		(Exhaust Pipe Gasket Not Included)	FS3469VC	1
Engine Kit Gasket Set	1971-1974			95-3028VR	1
Cylinder Head Gasket	1971-1974		VR2000	3469VC	1
Valve Cover Set	1971-1974		Cork Rubber	VS39748	1

PASSENGER CAR

Ford

11 (cont.)	122 CID (2.0L) SOHC 4 Cyl, 3.578in./90.8mm (1971-1974)				11 (cont.)
----------------------	---	--	--	--	----------------------

<i>Part</i>	<i>Year</i>	<i>VIN</i>	<i>Model/Application</i>	<i>Part Number</i>	<i>Qty.</i>
-------------	-------------	------------	--------------------------	--------------------	-------------

ENGINE GASKETS (cont.)

Valve Stem Seal, Exh.	1971-1974			B45613	4
Valve Stem Seal, Int.	1971-1974			B45613	4
Manifold Set, Exhaust	1971-1974			MS7196	1
Manifold Set, Intake	1971-1974			MS15185	1
Oil Pan Set	1971-1974		<i>Cork Rubber</i>	OS30544	1
Rear Main Seal	1971-1974			47487	1
Rear Main Seal Set	1971-1974			JV615	1
Timing Cover Set	1971-1974		(Camshaft Seal Not Included)	JV874	1
Timing Cover Seal	1971-1974		Lower, Upper	47518	1

MISCELLANEOUS GASKETS

Air Cleaner Mount Gasket	1971-1974		2 Barrel Carburetor	G27296	1
Camshaft Seal	1971-1974			47518	1
Carb. Mount Gasket	1971-1974		2 Barrel Carburetor	G26726	1
Exhaust Pipe Gasket	1971-1974		(Ring Type 'C'), Pipe To Manifold	F7355	1
	1971		(Ring Type 'B'), Pipe To Manifold	F7212	1
Fuel Pump Gasket	1971-1974			D27160	1
Water Outlet Gasket	1971-1974			C26651	1
Water Pump Mount Gasket	1971-1974			K27157	1

12	122 CID (2.0L) DOHC Mazda 4 Cyl, 3.268in./83mm (1993-1997)				12
-----------	---	--	--	--	-----------

<i>Part</i>	<i>Year</i>	<i>VIN</i>	<i>Model/Application</i>	<i>Part Number</i>	<i>Qty.</i>
-------------	-------------	------------	--------------------------	--------------------	-------------

ENGINE GASKETS

Head Set	1993-1997		(Head Bolts Not Included)	HS5942	1
Lower Set	1993-1997		(Requires Head Set To Make Full Set)	CS5942	1
Engine Kit Gasket Set	1993-1997			95-3472VR	1
Cylinder Head Gasket	1993-1997		<i>Multi-Layered Steel</i>	5942	1
Cyl. Head Bolt Set	1993-1997			GS33270	1
Cyl. Head Spacer Shim	1993-1997		Requires Sealing Compound	<i>Steel</i> 5942S	1
Sealing Compound	1993-1997		(4 Ounce Brush Top Can)	JV66B	1
			(12 Ounce Spray Can)	JV66S	1
Valve Cover Set	1993-1997		<i>Victo-Tech</i>	VS50186	1
Valve Stem Seal, Exh.	1993-1997			B45549	4
Valve Stem Seal, Int.	1993-1997			B45549	4
Manifold Set, Exhaust	1993-1997		<i>Multi-Layered Steel</i>	MS16122	1
Manifold Set, Intake	1993-1997			MS16121	1
Oil Pan Set	1993-1997		<i>Cork Rubber</i>	OS32515	1
Rear Main Seal Set	1993-1997			JV1615	1

MISCELLANEOUS GASKETS

Camshaft Seal	1993-1997			66864	2
Dist. Mounting Gasket	1993-1995			72213	1
Exhaust Pipe Gasket	1993-1997		(Flange Type), Pipe To Manifold	F7547	1
	1993-1995		(Flange Type), Front, Pipe To Converter	F7486	1
Therm. Housing Gasket	1993-1997		Housing To Block	C31306	1
Throttle Body Gasket	1993-1997			G31436	1
Water Outlet Gasket	1993-1997		Housing To Head	C31307	1
Water Pump Mount Gasket	1993-1997			K31308	1

13 122 CID (2.0L) SOHC Mazda Diesel 4 Cyl, 3.386in./86mm (1984-1987) 13

Part	Year	VIN	Model/Application	Part Number	Qty.
ENGINE GASKETS					
Head Set	1984-1987			HS3787	1
Full Set	1984-1987			FS3787	1
Cylinder Head Gasket	1984-1987		VR2000	3787	1
Valve Cover Set	1984-1987		Victo-Tech	VS39470	1
Valve Stem Seal, Exh.	1984-1987			B45548	4
Valve Stem Seal, Int.	1984-1987			B45548	4
Manifold Set, Exhaust	1984-1987			MS15366	1
Manifold Set, Intake	1984-1987			MS15379	1
Oil Pan Set	1984-1987		Cork Rubber	OS30993	1
Rear Main Seal Set	1984-1987			JV535	1
Timing Cover Set	1984-1987			JV996	1
Timing Cover Seal	1984-1987			47993	1

MISCELLANEOUS GASKETS					
Camshaft Seal	1984-1987		Front	47699	1
			Rear	47743	1
E.G.R. Gasket	1987		(1 Hole)	G31027	1
			(2 Holes)	G31028	1
	1984-1986			G26702	1
Exhaust Pipe Gasket	1984-1987		(Ring Type 'F'), Pipe To Converter	F12298	1
Water Outlet Gasket	1984-1987			C24553	1
Water Pump Backing Plate	1984-1987			K27136	1
Water Pump Mount Gasket	1984-1987			K27984	1

14 1989CC (2.0L) Zetec/DOHC/16 Valve 4 Cyl, 3.339in./84.8mm (1995-2003) 14

Part	Year	VIN	Model/Application	Part Number	Qty.
ENGINE GASKETS					
Head Set	2001-2003		Focus, (Head Bolts Not Included)	HS54197C	1
	1998-2003		Escort, (Head Bolts Not Included)	HS54197A	
	1999-2002		Cougar, (Head Bolts Not Included)	HS54197A	
	2000		Focus, Thru 12/19/99, (Head Bolts Not Included)	HS54197B	1
			Focus, From 12/20/99, (Head Bolts Not Included)	HS54197C	1
	1998-2000		Contour, Mystique, (Head Bolts Not Included)	HS54197A	
	1995-1997		(Head Bolts Not Included)	HS54197	1
Lower Set	2000-2003		Escort, (Requires Head Set To Make Full Set)	CS54197	1
	2000-2002		Cougar, (Requires Head Set To Make Full Set)	CS54197	1
			Focus, (Requires Head Set To Make Full Set)	CS54197A	1
	2000		Contour, Mystique, (Requires Head Set To Make Full Set)	CS54197	1
	1995-1999		(Requires Head Set To Make Full Set)	CS54197	1
Engine Kit Gasket Set	1995-1997			95-3464VR	1
Cylinder Head Gasket	1995-2003		Multi-Layered Steel	54197	1
Cyl. Head Bolt Set	1995-2003			GS33376	1
Valve Cover Set	2001-2003		Focus, (Contains Valve Cover Grommets) Victo-Tech	VS50314	1
	2000-2003		Escort, (Contains Valve Cover Grommets) Victo-Tech	VS50312	1
	2000-2002		Cougar, (Contains Valve Cover Grommets) Victo-Tech	VS50312	1
	2000		Contour, Mystique, (Contains Valve Cover Grommets) Victo-Tech	VS50312	1
			Focus, Thru 12/19/99, (Contains Valve Cover Grommets) Victo-Tech	VS50313	1
			Focus, From 12/20/99, (Contains Valve Cover Grommets) Victo-Tech	VS50314	1
	1998-1999		(Contains Valve Cover Grommets) Victo-Tech	VS50312	1
	1995-1997		(Contains Valve Cover Grommets) Victo-Tech	VS50311	1
Valve Stem Seal, Exh.	1995-2003			B45915	8
Valve Stem Seal, Int.	1995-2003			B45915	8
Manifold Set, Exhaust	1995-2003			MS16177	1

Ford

14 (cont.)	1989CC (2.0L) Zetec/DOHC/16 Valve 4 Cyl, 3.339in./84.8mm (1995-2003)				14 (cont.)
----------------------	---	--	--	--	----------------------

Part	Year	VIN	Model/Application	Part Number	Qty.
------	------	-----	-------------------	-------------	------

ENGINE GASKETS (cont.)

Manifold Set, Intake	2000-2003		Escort	<i>Victo-Tech</i> MS16333	1
	2000		Contour, Mystique	<i>Victo-Tech</i> MS16333	1
	1998-1999			<i>Victo-Tech</i> MS16333	1
	1995-1997			<i>Victo-Tech</i> MS16334	1
Oil Pan Set	2000-2003		Escort	<i>Victo-Tech</i> OS32227	1
	2000-2002		Cougar	<i>Victo-Tech</i> OS32227	1
			Focus	<i>Victo-Tech</i> OS32228	1
	2000		Contour, Mystique	<i>Victo-Tech</i> OS32227	1
	1995-1999			<i>Victo-Tech</i> OS32227	1
Rear Main Seal Set	1995-2003			JV1648	1

MISCELLANEOUS GASKETS

Camshaft Seal Set	1998-2003		Requires Oil Pan Set	GS33385	1
	1995-1997		Requires Oil Pan Set	GS33384	1
E.G.R. Gasket	1995-2000		Contour, Mystique	G30625	1
Injector Nozzle O-Ring	1995-2003			GS33276	2
Therm. Housing Gasket	1995-2003		Housing To Head	C31611	1
Thermostat Seal	1995-2003			C31612	1
Throttle Body Gasket	2000-2003		Escort	<i>Victo-Tech</i> G31608	1
			Focus	<i>Victo-Tech</i> G31609	1
	2000-2002		Cougar	<i>Victo-Tech</i> G31608	1
	2000		Contour, Mystique	<i>Victo-Tech</i> G31608	1
	1996-1999			<i>Victo-Tech</i> G31608	1
	1995			G31607	1
Water Pump Mount Gasket	1995-1997			K31443	1

15	1989CC (2.0L) Zetec/DOHC/16 Valve CNG 4 Cyl, 3.339in./84.8mm (1996-2000)				15
-----------	---	--	--	--	-----------

Part	Year	VIN	Model/Application	Part Number	Qty.
------	------	-----	-------------------	-------------	------

ENGINE GASKETS

Head Set	1998-2000		(Head Bolts Not Included)	HS54197A	
	1996-1997		(Head Bolts Not Included)	HS54197	1
Lower Set	1996-2000		(Requires Head Set To Make Full Set)	CS54197	1
Engine Kit Gasket Set	1996-1997			95-3464VR	1
Cylinder Head Gasket	1996-2000		<i>Multi-Layered Steel</i>	54197	1
Cyl. Head Bolt Set	1996-2000			GS33376	1
Valve Cover Set	1998-2000		(Contains Valve Cover Grommets)	<i>Victo-Tech</i> VS50312	1
	1996-1997		(Contains Valve Cover Grommets)	<i>Victo-Tech</i> VS50311	1
Valve Stem Seal, Exh.	1996-2000			B45915	8
Valve Stem Seal, Int.	1996-2000			B45915	8
Manifold Set, Exhaust	1996-2000			MS16177	1
Manifold Set, Intake	1998-2000			<i>Victo-Tech</i> MS16333	1
	1996-1997			<i>Victo-Tech</i> MS16334	1
Oil Pan Set	1996-2000			<i>Victo-Tech</i> OS32227	1
Rear Main Seal Set	1996-2000			JV1648	1

MISCELLANEOUS GASKETS

E.G.R. Gasket	1996-2000			G30625	1
Injector Nozzle O-Ring	1996-2000			GS33276	2
Therm. Housing Gasket	1996-2000		Housing To Head	C31611	1
Thermostat Seal	1996-2000			C31612	1
Throttle Body Gasket	1996-2000			<i>Victo-Tech</i> G31608	1
Water Pump Mount Gasket	1996-1997			K31443	1

16 134 CID (2.2L) SOHC Mazda 4 Cyl, 3.386in./86mm (1989-1992) 16

Part	Year	VIN	Model/Application	Part Number	Qty.
ENGINE GASKETS					
Head Set	1989-1992		(Contains Exhaust Manifold Gasket, Exhaust Manifold Heat Shield Gasket Not Included)	HS5851	1
Engine Kit Gasket Set	1989-1992		(Exhaust Manifold Heat Shield Gasket Not Included), Naturally Aspirated, Use With Part Number MS15621	95-3201VR	1
			Turbocharged, (Exhaust Manifold Heat Shield Gasket Not Included), Use With Part Number MS15593	95-3201VR	1
Cylinder Head Gasket	1989-1992		<i>Nitroseal</i>	5851	1
Valve Cover Set	1989-1992		<i>Victo-Tech</i>	VS50096	1
Valve Stem Seal, Exh.	1989-1992			B45588	6
Valve Stem Seal, Int.	1989-1992			B45588	6
Manifold Set, Exhaust	1989-1992		(Contains Exhaust Manifold Heat Shield And Gasket), Turbocharged	MS15593	1
			(Contains Exhaust Manifold Heat Shield And Gasket), Naturally Aspirated	MS15621	1
Manifold Set, Intake	1989-1992			MS15619	1
Oil Pan Set	1989-1992		<i>Cork Rubber</i>	OS30598	1
Rear Main Seal Set	1989-1992			JV535	1
Crank Repair Sleeve	1989-1992	Rear	<i>Nickel Plated Formed Steel, .013" Thickness</i>	A347	1
Timing Cover Set	1989-1992		(Camshaft Seal Not Included)	JV1105	1
Timing Cover Seal	1989-1992			66864	1

MISCELLANEOUS GASKETS

Camshaft Seal	1989-1991			66864	1
E.G.R. Gasket	1989-1992		Automatic Transmission, Naturally Aspirated	G30702	1
			Turbocharged	G30748	1
Exhaust Pipe Gasket	1989-1992		Except Turbocharged, (Flange Type), Pipe To Manifold	F7472	1
			(Flange Type), Turbocharged, Pipe To Manifold	F7473	1
			(Ring Type 'F'), Turbocharged, Front	F10148	1
			Except Turbocharged, Manual Transmission, (Ring Type 'F'), Front, Pipe To Converter	F10148	1
Fuel Pump Gasket	1989-1992			D24099	2
Injector Nozzle O-Ring	1989-1992			GS33277	1
Throttle Body Gasket	1989-1992			G31070	1
Water Outlet Gasket	1989-1992		<i>Victopac</i>	C20115	1
Water Pump Mount Gasket	1990-1992			K31069	1
	1989		From 8/88	K31069	1
			Thru 8/88, (O-Ring Type)	K31111	1

17 140 CID (2.3L) High Swirl Combustion 4 Cyl, 3.680in./93.5mm (1984-1994) 17

Part	Year	VIN	Model/Application	Part Number	Qty.
ENGINE GASKETS					
Head Set	1991-1994		(Head Bolts Not Included, Exhaust Pipe Gasket Not Included)	HS5882	1
	1989-1990		(Head Bolts Not Included, Exhaust Pipe Gasket Not Included)	HS5737A	1
	1988		(Head Bolts Not Included, Exhaust Pipe Gasket Not Included)	HS5737X	1
	1985-1987		Aluminum Valve Cover, (Head Bolts Not Included, Exhaust Pipe Gasket Not Included, Intake Manifold Gasket For High Output Engine Not Included, Intake Manifold Gasket For Central Fuel Injection Not Included)	HS5737	1
	1985		Steel Valve Covers, (Head Bolts Not Included, Exhaust Pipe Gasket Not Included, Intake Manifold Gasket For High Output Engine Not Included, Intake Manifold Gasket For Central Fuel Injection Not Included)	HS3775	1
	1984		(Head Bolts Not Included, Exhaust Pipe Gasket Not Included, Intake Manifold Gasket For High Output Engine Not Included, Intake Manifold Gasket For Central Fuel Injection Not Included)	HS3775	1

Ford

17 140 CID (2.3L) High Swirl Combustion 4 Cyl, 3.680in./93.5mm (1984-1994) **17**
 (cont.) (cont.)

Part Year VIN Model/Application Part Number Qty.

ENGINE GASKETS (cont.)

Lower Set	1989-1990		(Oil Pan Gasket Not Included, Requires Head Set To Make Full Set)	CS5737	1
Full Set	1991-1994		(Oil Pan Gasket Not Included, Exhaust Pipe Gasket Not Included)	FS5882	1
	1988		(Exhaust Pipe Gasket Not Included, Intake Manifold Gasket For High Output Engine Not Included, Intake Manifold Gasket For Central Fuel Injection Not Included)	FS5737X	1
	1985-1987		Aluminum Valve Cover, (Exhaust Pipe Gasket Not Included, Intake Manifold Gasket For High Output Engine Not Included, Intake Manifold Gasket For Central Fuel Injection Not Included)	FS5737	1
	1984-1985		Steel Valve Covers, (Exhaust Pipe Gasket Not Included, Intake Manifold Gasket For High Output Engine Not Included, Intake Manifold Gasket For Central Fuel Injection Not Included)	FS3775	1
Engine Kit Gasket Set	1989-1994		Plastic Valve Cover	95-3378VR	1
	1988-1989		Aluminum Valve Cover	95-3377VR	1
	1985-1987		Aluminum Valve Cover, Electronic Fuel Injection, Use With Part Number MS15535	95-3385VR	1
	1985		Central Fuel Injection, Steel Valve Covers	95-3371VR	1
	1984-1985		Except Central Fuel Injection, Steel Valve Covers, (Intake Manifold Gasket Not Included), Use With Part Number MS15535	95-3371VR	1
Cylinder Head Gasket	1991-1994		<i>Nitroseal</i>	5882	1
	1984-1990		<i>Nitroseal</i>	5737	1
Cyl. Head Bolt Set	1984-1989			GS33292	1
Valve Cover Set	1989-1994		<i>High Temperature Tuff-Cork</i>	VS50152HTC	1
	1985-1988		Aluminum Valve Cover <i>Tuff-Cork</i>	VS50027TC	1
			Aluminum Valve Cover <i>Victo-Tech</i>	VS50199	1
	1984-1985		Steel Valve Covers <i>Cork Rubber</i>	VS38951	1
Valve Stem Seal, Exh.	1984-1994			B45404	4
Valve Stem Seal, Int.	1984-1994		<i>Fluoroelastomer</i>	B45418	4
Manifold Set, Exhaust	1984-1994			MS12307	1
Manifold Set, Intake	1988-1994		(Contains Plenum Chamber Gasket)	MS15447	1
	1985-1987		High Output Engine	MS15536	1
	1984-1987		Except High Output Engine	MS15535	1
Plenum Chamber Gasket	1988-1994			MS15448	1
Oil Pan Set	1989-1994		(Conventional Oil Pan Gasket Not Used) <i>Silicone</i>	JV6	1
	1988		<i>Victo-Tech</i>	OS32467	1
	1984-1987		<i>Cork Rubber</i>	OS30609	1
Rear Main Seal	1984-1994			47753	1
Rear Main Seal Set	1984-1994			JV555	1
		(Optional) <i>Teflon</i>	JV1638	1	
Crank Repair Sleeve	1984-1994		Use With Part Number A507, Rear <i>Nickel Plated Formed Steel, .013" Thickness</i>	A333	1
Timing Cover Set	1984-1994			JV997	1
Timing Cover Seal	1984-1994			47744	1
Harmonic Balancer Repair Sleeve	1984-1994		Use With Part Number A504 <i>Nickel Plated Formed Steel, .013" Thickness</i>	A233	1
MISCELLANEOUS GASKETS					
Air Cleaner Mount Gasket	1984-1987			G26540	1
Carb. Mount Gasket	1985-1987		1 Barrel Carburetor, Carburetor To Spacer	G26163	1
	1984		Except Heated Spacer, 1 Barrel Carburetor, Carburetor To Manifold	G26163	1
E.G.R. Gasket	1988-1994			G30625	1
	1984-1987			G26701	1
Exhaust Pipe Gasket	1985-1994		(Ring Type 'A'), Pipe To Manifold	F7419	1
	1984-1994		(Ring Type 'F'), Pipe To Converter	F12298	1

17 140 CID (2.3L) High Swirl Combustion 4 Cyl, 3.680in./93.5mm (1984-1994) **17**
 (cont.) (cont.)

Part	Year	VIN	Model/Application	Part Number	Qty.
MISCELLANEOUS GASKETS (cont.)					
Exhaust Pipe Gasket (cont.)	1984		(Ring Type 'A'), Pipe To Manifold	F7417	1
Fuel Pump Gasket	1984-1988			D27094	1
				Tuff-Cork D27094TC	1
Injector Nozzle O-Ring	1984-1994			GS33276	2
Throttle Body Gasket	1988-1994			G30943	1
Water Outlet Gasket	1984-1994			C26194	1
Water Pump Backing Plate	1984-1989			K26064	1
Water Pump Mount Gasket	1984-1994			K27330	1

18 140 CID (2.3L) SOHC 4 Cyl, 3.780in./96mm (1974-1993) **18**

Part	Year	VIN	Model/Application	Part Number	Qty.
ENGINE GASKETS					
Head Set	1991-1993			HS5938	1
	1989-1990			HS3519E	1
	1985-1988		(Turbocharger Gasket Not Included)	HS3519Y	1
	1974-1984		(Exhaust Pipe Gasket Not Included, Turbocharger Gasket Not Included, Intake Manifold Gasket For Liquid Propane Gas Not Included)	HS3519	1
			(Exhaust Pipe Gasket Not Included, Turbocharger Gasket Not Included, Intake Manifold Gasket For Liquid Propane Gas Not Included, Contains Head Gasket With Stainless Steel Combustion Chamber Flanges)	HS3519T	1
Lower Set	1993		(Requires Head Set To Make Full Set)	CS5938A	1
	1991-1992		(Requires Head Set To Make Full Set)	CS5938	1
Full Set	1989-1990			FS3519E	1
	1987-1988		(Turbocharger Gasket Not Included)	FS3519Y	1
	1986		Thru 2/19/86, (Turbocharger Gasket Not Included, Intake Manifold Gasket For Liquid Propane Gas Not Included)	FS3519W	1
			From 2/19/86, (Turbocharger Gasket Not Included)	FS3519Y	1
	1983-1985		(Turbocharger Gasket Not Included, Intake Manifold Gasket For Liquid Propane Gas Not Included)	FS3519W	1
	1982		Thru 9/28/81, (Exhaust Pipe Gasket Not Included, Intake Manifold Gasket For Liquid Propane Gas Not Included)	FS3519	1
			From 9/28/81, (Exhaust Pipe Gasket Not Included, Intake Manifold Gasket For Liquid Propane Gas Not Included)	FS3519W	1
	1974-1981		(Exhaust Pipe Gasket Not Included, Intake Manifold Gasket For Liquid Propane Gas Not Included)	FS3519	1
	Engine Kit Gasket Set	1993		(Oil Pan Gasket Not Included), Use With Part Number OS32481	95-3384VR
1991-1992				95-3384VR	1
1989-1990				95-3383VR	1
1987-1988				95-3376VR	1
1986			Thru 2/19/86	95-3370VR	1
			From 2/19/86	95-3376VR	1
1985				95-3370VR	1
1983-1984			Turbocharged	95-3370VR	1
1982-1984			(Rear Main Seal Not Included), Naturally Aspirated, Use With Part Number JV523	95-3360VR	1
1981			From 9/28/81, (Rear Main Seal Not Included), Naturally Aspirated, Use With Part Number JV523	95-3360VR	1
			Thru 9/28/81, Naturally Aspirated	95-3360VR	1
1979-1981			Turbocharged	95-3370VR	1
1974-1980			Naturally Aspirated	95-3360VR	1
Cylinder Head Gasket	1974-1993		VR2000	4029	1
			Nitroseal	4029SG	1
Cyl. Head Bolt Set	1985-1993			GS33328	1

Ford

18 (cont.)	140 CID (2.3L) SOHC 4 Cyl, 3.780in./96mm (1974-1993)	18 (cont.)
----------------------	---	----------------------

Part	Year	VIN	Model/Application	Part Number	Qty.
------	------	-----	-------------------	-------------	------

ENGINE GASKETS (cont.)

Cyl. Head Spacer Shim	1974-1993		Requires Sealing Compound	<i>Steel</i> 4029S	1	
Sealing Compound	1974-1993		(4 Ounce Brush Top Can)	JV66B	1	
			(12 Ounce Spray Can)	JV66S	1	
Valve Cover Set	1989-1993			<i>Cork Rubber</i> VS39878	1	
	1974-1993			<i>Victo-Tech</i> VS50208	1	
	1974-1988			<i>Cork Rubber</i> VS39751	1	
				<i>High Temperature Cork Rubber</i> VS39751H	1	
Valve Stem Seal, Exh.	1974-1993			B45404	4	
Valve Stem Seal, Int.	1985-1993			<i>Fluoroelastomer</i> B45418	4	
	1974-1984			B45404	4	
Manifold Set, Exhaust	1974-1993			MS16048	1	
Manifold Set, Intake	1991-1993		(Contains Plenum Chamber Gasket)	MS15480	1	
	1985-1990		(Contains Plenum Chamber Gasket)	MS15582W	1	
	1974-1984		Except Liquid Propane Gas, (Contains Plenum Chamber Gasket)	MS15207X	1	
Plenum Chamber Gasket	1991-1993			MS15547	1	
	1985-1990			MS14631	1	
	1983-1984			MS12346	1	
Oil Pan Set	1993			<i>Victo-Tech</i> OS32481	1	
	1991-1992			<i>Victo-Tech</i> OS32463	1	
	1987-1990			<i>Victo-Tech</i> OS32464	1	
	1986		Thru 2/19/86	<i>Cork Rubber</i>	OS30546	1
			Thru 2/19/86	<i>Tuff-Cork</i>	OS30546TC	1
			From 2/19/86	<i>Victo-Tech</i>	OS32464	1
	1974-1985			<i>Cork Rubber</i>	OS30546	1
				<i>Tuff-Cork</i>	OS30546TC	1
Rear Main Seal Set	1983-1993			JV523	1	
				<i>Teflon</i> JV1635	1	
	1982		From 9/28/81		JV523	1
			Thru 9/28/81	<i>Molded Rubber</i>	JV730R	1
			From 9/28/81	<i>Teflon</i>	JV1635	1
	1974-1981			<i>Molded Rubber</i> JV730R	1	
Crank Repair Sleeve	1982-1993		<i>Nickel Plated Formed Steel, .013" Thickness</i>	A349	1	
	1983-1990		Use With Part Number A509, Rear <i>Nickel Plated Formed Steel, .013" Thickness</i>	A335	1	
Timing Cover Set	1993		(Auxiliary Shaft Seal Not Included)	JV1175	1	
	1990-1992		(Auxiliary Shaft Seal Not Included)	JV1116	1	
	1987-1989		(Auxiliary Shaft Seal Not Included)	JV1033	1	
	1986		Thru 2/86, (Auxiliary Shaft Seal Not Included)	JV879	1	
			From 2/86, (Auxiliary Shaft Seal Not Included)	JV1033	1	
1974-1985		(Auxiliary Shaft Seal Not Included)	JV879	1		
Timing Cover Seal	1974-1993			47524	1	

MISCELLANEOUS GASKETS

Air Cleaner Mount Gasket	1983-1986		1 Barrel Carburetor	G25936	1
	1983		Naturally Aspirated	G25936	1
			1 Barrel Carburetor	G25936	1
	1974-1982		2 Barrel Carburetor	G31431	1
Aux. Shaft Seal	1974-1993			47524	1
Camshaft Seal	1974-1993			47524	1
Carb. Mount Gasket	1984-1986		Naturally Aspirated, Spacer To Manifold	G25177	1
			1 Barrel Carburetor, Spacer To Manifold	G25177	1
	1983-1986		1 Barrel Carburetor, Carburetor To Spacer	G26163	1
	1983		Naturally Aspirated, Carburetor To Spacer	G26163	1
			1 Barrel Carburetor, Carburetor To Spacer	G26163	1

18 140 CID (2.3L) SOHC 4 Cyl, 3.780in./96mm (1974-1993) **18**
(cont.) (cont.)

Part	Year	VIN	Model/Application	Part Number	Qty.
MISCELLANEOUS GASKETS (cont.)					
Carb. Mount Gasket (cont.)	1974-1982		2 Barrel Carburetor, Spacer To Manifold	G26062	1
			2 Barrel Carburetor, Carburetor To Spacer	G27336	1
E.G.R. Gasket	1977-1993			G26703	1
	1974-1976			G26700	1
Exhaust Pipe Gasket	1985-1988		XR4Ti, (Flange Type), Turbocharger To Exhaust Manifold	F7414	1
	1983-1988		Thunderbird, (Flange Type), Turbocharger To Exhaust Manifold	F7414	1
	1984-1986		Cougar, (Flange Type), Turbocharger To Exhaust Manifold	F7414	1
	1983-1985		Capri, Mustang, (Flange Type), Turbocharger To Exhaust Manifold	F7414	1
	1977-1983		(Flange Type), Pipe To Converter 2-1/2" Inside Diameter	F14145	1
	1975-1983		(Flange Type), Pipe To Converter 2-5/16" Inside Diameter	F14144	1
	1976-1978		Capri, Mustang, California, (Ring Type 'B'), Pipe To Manifold	F7390	1
Injector Nozzle O-Ring	1983-1993			GS33276	2
Thermostat Seal	1979-1985		Victo-Tech	C31284	1
Throttle Body Gasket	1983-1990			G30942	1
Turbo O-ring Set	1979-1982			GS27702	1
Water Outlet Gasket	1974-1993			C26681	1
Water Pump Mount Gasket	1974-1993			K27612	1

19 140 CID (2.3L) SOHC LPG 4 Cyl, 3.780in./96mm (1984-1985) **19**

Part	Year	VIN	Model/Application	Part Number	Qty.
ENGINE GASKETS					
Head Set	1985			HS3519Y	1
	1984		(Exhaust Pipe Gasket Not Included, Intake Manifold Gasket For Liquid Propane Gas Not Included)	HS3519	1
Full Set	1984-1985		(Intake Manifold Gasket For Liquid Propane Gas Not Included)	FS3519W	1
Engine Kit Gasket Set	1985			95-3370VR	1
	1984		(Rear Main Seal Not Included), Use With Part Number JV523	95-3360VR	1
Cylinder Head Gasket	1984-1985		VR2000	4029	1
			Nitroseal	4029SG	1
Cyl. Head Bolt Set	1985			GS33328	1
Cyl. Head Spacer Shim	1984-1985		Requires Sealing Compound	Steel 4029S	1
Sealing Compound	1984-1985		(4 Ounce Brush Top Can)	JV66B	1
			(12 Ounce Spray Can)	JV66S	1
Valve Cover Set	1984-1985		Cork Rubber	VS39751	1
			High Temperature Cork Rubber	VS39751H	1
			Victo-Tech	VS50208	1
Valve Stem Seal, Exh.	1984-1985			B45404	4
Valve Stem Seal, Int.	1985		Fluoroelastomer	B45418	4
	1984			B45404	4
Manifold Set, Exhaust	1984-1985			MS16048	1
Manifold Set, Intake	1985		(Contains Plenum Chamber Gasket)	MS15582W	1
	1984			MS15207W	1
Plenum Chamber Gasket	1985			MS14631	1
	1984			MS12346	1
Oil Pan Set	1984-1985		Cork Rubber	OS30546	1
			Tuff-Cork	OS30546TC	1
Rear Main Seal Set	1984-1985			JV523	1
			Teflon	JV1635	1
Crank Repair Sleeve	1984-1985		Use With Part Number A509, Rear Nickel Plated Formed Steel, .013" Thickness	A335	1

Ford

19	140 CID (2.3L) SOHC LPG 4 Cyl, 3.780in./96mm (1984-1985)	19
(cont.)		(cont.)

Part	Year	VIN	Model/Application	Part Number	Qty.
------	------	-----	-------------------	-------------	------

ENGINE GASKETS (cont.)

Crank Repair Sleeve (cont.)	1984-1985		<i>Nickel Plated Formed Steel, .013" Thickness</i>	A349	1
Timing Cover Set	1984-1985		(Auxiliary Shaft Seal Not Included)	JV879	1
Timing Cover Seal	1984-1985			47524	1

MISCELLANEOUS GASKETS

Air Cleaner Mount Gasket	1985		1 Barrel Carburetor	G25936	1
	1984		1 Barrel Carburetor	G27098	1
Aux. Shaft Seal	1984-1985			47524	1
Camshaft Seal	1984-1985			47524	1
Carb. Mount Gasket	1984-1985		1 Barrel Carburetor, Spacer To Manifold	G25177	1
			1 Barrel Carburetor, Carburetor To Spacer	G26163	1
E.G.R. Gasket	1984-1985			G26703	1
Injector Nozzle O-Ring	1984-1985			GS33276	2
Thermostat Seal	1984-1985		<i>Victo-Tech</i>	C31284	1
Throttle Body Gasket	1984-1985			G30942	1
Water Outlet Gasket	1984-1985			C26681	1
Water Pump Mount Gasket	1984-1985			K27612	1

20	140 CID (2.3L) Special Vehicle Operation 4 Cyl, 3.780in./96mm (1986)	20
-----------	---	-----------

Part	Year	VIN	Model/Application	Part Number	Qty.
------	------	-----	-------------------	-------------	------

ENGINE GASKETS

Oil Pan Set	1986		From 2/19/86	<i>Victo-Tech</i>	OS32464	1
-------------	------	--	--------------	-------------------	---------	---

21	144 CID (2.4L) 6 Cyl, 3.500in./88.9mm (1960-1964)	21
-----------	--	-----------

Part	Year	VIN	Model/Application	Part Number	Qty.
------	------	-----	-------------------	-------------	------

ENGINE GASKETS

Head Set	1960-1964		(Exhaust Pipe Gasket Not Included)	HS3910VJ	1
Full Set	1960-1964		(Exhaust Pipe Gasket Not Included)	FS3910VJ	1
Engine Kit Gasket Set	1960-1964			95-3005VR	1
Cylinder Head Gasket	1960-1964		<i>VR2000</i>	3910VC	1
Valve Cover Set	1960-1964		<i>Cork Rubber</i>	VS39564	1
Valve Stem Seal, Exh.	1960-1964			B45320	6
Valve Stem Seal, Int.	1960-1964			B45320	6
Manifold Set, Exhaust	1960-1964			MS16035W	1
Oil Pan Set	1960-1964		<i>Cork Rubber</i>	OS30921	1
Rear Main Seal Set	1960-1964		<i>Rope Packing</i>	JV730	1
			<i>Molded Rubber</i>	JV730P	1
				JV820	1
Timing Cover Set	1960-1964		(Contains Repair Sleeve)	JV930	1
Timing Cover Seal	1960-1964			46244	1
Harmonic Balancer Repair Sleeve	1960-1964		<i>Ground Steel, .020" Thickness</i>	66594RS	1

MISCELLANEOUS GASKETS

Air Cleaner Mount Gasket	1960-1961		1 Barrel Carburetor	G26540	1
Carb. Mount Gasket	1963-1964		1 Barrel Carburetor	G26581	2
	1962-1963		1 Barrel Carburetor, Carburetor To Spacer	G26581	2
	1962		1 Barrel Carburetor, Spacer To Manifold	G5260EK	1
	1960-1961		1 Barrel Carburetor	G5260EK	2
Exhaust Pipe Gasket	1963-1964		(Ring Type 'C'), Pipe To Manifold	F7355	1
	1960-1962		(Flange Type), Pipe To Manifold	F5360C	1
Fuel Pump Gasket	1960-1964			D27094	1
Water Outlet Gasket	1960-1964			C24005	1

21 144 CID (2.4L) 6 Cyl, 3.500in./88.9mm (1960-1964) **21**
(cont.) (cont.)

Part Year VIN Model/Application Part Number Qty.

MISCELLANEOUS GASKETS (cont.)

Water Pump Mount Gasket	1960-1964			K14119	1
-------------------------	-----------	--	--	--------	---

22 149 CID (2.4L) BMW Diesel 6 Cyl, 3.150in./80mm (1984-1985) **22**

Part Year VIN Model/Application Part Number Qty.

ENGINE GASKETS

Head Set	1984-1985		(Head Gasket Not Included, Replacement Gasket Must Be Of Same Thickness As One Removed)	HS4828LH	1
Lower Set	1984-1985		(Requires Head Set And Cylinder Head Gasket To Make Full Set)	CS4828	1
Cylinder Head Gasket	1984-1985		(1 Hole) <i>1.43mm Thickness</i>	4828	1
			(2 Holes) <i>1.54mm Thickness</i>	4829	1
			(3 Holes, Replacement Gasket Must Be Of Same Thickness As One Removed) <i>1.70mm Thickness</i>	4830	1
Valve Cover Set	1984-1985		<i>Victo-Tech</i>	VS38431	1
Valve Stem Seal, Exh.	1984-1985			B45498	6
Valve Stem Seal, Int.	1984-1985			B45498	6
Manifold Set, Exhaust	1984-1985			MS10052	1
Manifold Set, Intake	1984-1985			MS10058	1
Oil Pan Set	1984-1985		<i>Cork Rubber</i>	OS30992	1

MISCELLANEOUS GASKETS

E.G.R. Gasket	1984-1985			G26197	1
Thermostat Seal	1984-1985		<i>Victo-Tech</i>	C45551	1
Water Outlet Gasket	1984-1985		Side	C26943	1
			Front	C26944	1
			Rear	C26945	1
Water Pump Mount Gasket	1984-1985			K27876	1

23 153 CID (2.5L) High Swirl Combustion 4 Cyl, 3.680in./93.5mm (1986-1991) **23**

Part Year VIN Model/Application Part Number Qty.

ENGINE GASKETS

Head Set	1986-1991			HS5737W	1
Full Set	1989-1991		(Oil Pan Gasket Not Included)	FS5737W	1
	1988		From 4/88, (Oil Pan Gasket Not Included)	FS5737W	1
			Thru 4/88	FS5737W	1
	1986-1987			FS5737W	1
Engine Kit Gasket Set	1991		Plastic Valve Cover, (Intake Manifold Gasket Not Included), Use With Part Number MS15536	95-3378VR	1
	1986-1990		Aluminum Valve Cover, (Oil Pan Gasket Not Included), Use With Part Number OS32467	95-3385VR	1
Cylinder Head Gasket	1986-1991		<i>Nitroseal</i>	5737	1
Valve Cover Set	1986-1991		<i>Tuff-Cork</i>	VS50027TC	1
			<i>Victo-Tech</i>	VS50199	1
				B45404	4
Valve Stem Seal, Exh.	1986-1991		<i>Fluoroelastomer</i>	B45418	4
Valve Stem Seal, Int.	1986-1991			B45418	4
Manifold Set, Exhaust	1986-1991			MS12307	1
Manifold Set, Intake	1986-1991			MS15536	1
Oil Pan Set	1989-1991		Original Equipment Uses RTV, (Conventional Oil Pan Gasket Not Used) <i>Silicone</i>	JV6	1
	1988		From 4/88, Original Equipment Uses RTV, (Conventional Oil Pan Gasket Not Used) <i>Silicone</i>	JV6	1
			Thru 4/88 <i>Victo-Tech</i>	OS32467	1
	1986-1987		<i>Victo-Tech</i>	OS32467	1
Rear Main Seal	1986-1991			47753	1
Rear Main Seal Set	1986-1991			JV555	1

Ford

23 (cont.)	153 CID (2.5L) High Swirl Combustion 4 Cyl, 3.680in./93.5mm (1986-1991)					23 (cont.)
----------------------	--	--	--	--	--	----------------------

Part	Year	VIN	Model/Application	Part Number	Qty.
------	------	-----	-------------------	-------------	------

ENGINE GASKETS (cont.)

Rear Main Seal Set (cont.)	1986-1991		(Optional) <i>Teflon</i>	JV1638	1
Crank Repair Sleeve	1986-1991		Use With Part Number A507, Rear <i>Nickel Plated Formed Steel, .013" Thickness</i>	A333	1
Timing Cover Set	1986-1991			JV997	1
Timing Cover Seal	1986-1991			47744	1

MISCELLANEOUS GASKETS

E.G.R. Gasket	1991			G30625	1
	1990			G26702	1
	1986-1987			G26701	1
Exhaust Pipe Gasket	1986-1991		(Ring Type 'F'), Pipe To Converter	F12298	1
Injector Nozzle O-Ring	1986-1991			GS33276	2
Water Outlet Gasket	1986-1991			C26681	1
Water Pump Mount Gasket	1986-1991			K27330	1

24	153 CID (2.5L) DOHC Mazda V6 Cyl, 3.327in./84.5mm (1993-1997)					24
-----------	--	--	--	--	--	-----------

Part	Year	VIN	Model/Application	Part Number	Qty.
------	------	-----	-------------------	-------------	------

ENGINE GASKETS

Head Set	1993-1997			HS54060	1
Lower Set	1993-1997		(Requires Head Set To Make Full Set)	CS54060	1
Cylinder Head Gasket	1993-1997		Right Head <i>Multi-Layered Steel</i>	54060	1
			Left Head <i>Multi-Layered Steel</i>	54061	1
Valve Cover Set	1993-1997		(Contains Isolators, Contains Valve Cover Grommets, Requires Intake Manifold Gasket) <i>Victo-Tech</i>	VS50253	1
Valve Stem Seal, Exh.	1993-1997			B45866	12
Valve Stem Seal, Int.	1993-1997			B45866	12
Manifold Set, Exhaust	1993-1997		<i>Multi-Layered Steel</i>	MS12456	1
Manifold Set, Intake	1993-1997		<i>Beaded Steel</i>	MS12458	1
Oil Pan Set	1993-1997		<i>Cork Rubber</i>	OS32213	1
Rear Main Seal	1993-1997		<i>Rubber</i>	66853	1
Timing Cover Set	1993-1997			JV1209	1
Timing Cover Seal	1993-1997			JV5002	1

MISCELLANEOUS GASKETS

Cam. Circular Plug	1993-1997			B45867	2
Camshaft Seal	1993-1997			47699	2
Exhaust Pipe Gasket	1993-1997		(Flange Type), Pipe To Manifold	F7547	1
Injector Nozzle O-Ring	1993-1997			GS33278	1
Throttle Body Gasket	1993-1997			G31438	1
Water Crossover Mount Set	1993-1997			GS33312	1
Water Outlet Gasket	1993-1997		<i>Victopac</i>	C20115	1
Water Pump Mount Gasket	1993-1997		<i>Victo-Tech</i>	K31543	1

25	155 CID (2.5L) Duratec/DOHC/24 Valve V6 Cyl, 3.240in./82.3mm (1995-2002)					25
-----------	---	--	--	--	--	-----------

Part	Year	VIN	Model/Application	Part Number	Qty.
------	------	-----	-------------------	-------------	------

ENGINE GASKETS

Head Set	2001-2002		(Head Bolts Not Included)	HS54360	1
	2000		(Head Bolts Not Included)	HS54365	1
	1999		Thru 6/14/99, (Head Bolts Not Included)	HS5990	1
			From 6/15/99, (Head Bolts Not Included)	HS54365	1
	1995-1998		(Head Bolts Not Included)	HS5990	1
Lower Set	2001-2002		(Requires Head Set To Make Full Set)	CS5990A	1
	1995-2000		(Requires Head Set To Make Full Set)	CS5990	1

25 155 CID (2.5L) Duratec/DOHC/24 Valve V6 Cyl, 3.240in./82.3mm (1995-2002) **25**
(cont.) (cont.)

Part	Year	VIN	Model/Application	Part Number	Qty.
ENGINE GASKETS (cont.)					
Cylinder Head Gasket	2001-2002		Right <i>Multi-Layered Steel</i>	54360	1
			Left <i>Multi-Layered Steel</i>	54361	1
	2000		Right <i>Nitroseal</i>	54365	1
	1995-2000		Left <i>Nitroseal</i>	5991	1
	1999		Thru 6/14/99, Right <i>Nitroseal</i>	5990	1
			From 6/15/99, Right <i>Nitroseal</i>	54365	1
	1995-1998		Right <i>Nitroseal</i>	5990	1
Cyl. Head Bolt Set	1995-2002			GS33388	2
Valve Cover Set	1995-2002		(Contains Valve Cover Grommets, Contains Spark Plug Tube Seals) <i>Victo-Tech</i>	VS50237	1
Valve Stem Seal, Exh.	1995-2002			B45837	12
Valve Stem Seal, Int.	1995-2002			B45837	12
Manifold Set, Exhaust	1995-2002			MS12415	1
Manifold Set, Intake	1995-2002		(Contains Plenum Chamber Gasket) <i>Victo-Tech</i>	MS16356	1
Plenum Chamber Gasket	1995-2002		<i>Victo-Tech</i>	MS16357	1
Oil Pan Set	2001-2002		Lower <i>Victo-Tech</i>	OS32244	1
	1995-2000		<i>Victo-Tech</i>	OS32145	1
Rear Main Seal Set	1995-2002			JV1612	1
Timing Cover Set	1995-2002		<i>Victo-Tech</i>	JV5026	1
Timing Cover Seal	1995-2002			48322	1

MISCELLANEOUS GASKETS

E.G.R. Gasket	1995-2002			G30625	1
Exhaust Pipe Gasket	1995-2002		Pipe To Manifold	F17991	1
Throttle Body Gasket	1995-2002			G31338	1
Water Outlet Gasket	1995-2002			C31302	1
Water Pump Mount Gasket	1997		Thru 10/97	K31339	1
	1995-1996			K31339	1

26 159 CID (2.6L) V6 Cyl, 3.543in./90mm (1972-1973) **26**

Part	Year	VIN	Model/Application	Part Number	Qty.
ENGINE GASKETS					
Valve Cover Set	1972-1973		<i>Cork Rubber</i>	VS39761	1
Oil Pan Set	1972-1973		<i>Cork Rubber</i>	OS30555	1
Rear Main Seal Set	1972-1973			JV617	1

MISCELLANEOUS GASKETS

Air Cleaner Mount Gasket	1972-1973		2 Barrel Carburetor	G27296	1
Exhaust Pipe Gasket	1972-1973		(Ring Type 'B'), Pipe To Manifold	F7212	1
Thermostat Seal	1972-1973		<i>Victo-Tech</i>	C45407	1
Water Outlet Gasket	1972-1973		Upper	C26671	1
			Lower Front	C26675	1
			Lower Rear	C26686	1

27 170 CID (2.8L) 6 Cyl, 3.500in./88.9mm (1961-1972) **27**

Part	Year	VIN	Model/Application	Part Number	Qty.
ENGINE GASKETS					
Head Set	1961-1972		(Exhaust Pipe Gasket Not Included)	HS3910VJ	1
Full Set	1961-1972		(Exhaust Pipe Gasket Not Included)	FS3910VJ	1
Engine Kit Gasket Set	1961-1972			95-3005VR	1
Cylinder Head Gasket	1961-1972		<i>VR2000</i>	3910VC	1
Valve Cover Set	1961-1972		<i>Cork Rubber</i>	VS39564	1
Valve Stem Seal, Exh.	1961-1972			B45320	6
Valve Stem Seal, Int.	1961-1972			B45320	6

Ford

27 170 CID (2.8L) 6 Cyl, 3.500in./88.9mm (1961-1972) **27**
 (cont.) (cont.)

Part Year VIN Model/Application Part Number Qty.

ENGINE GASKETS (cont.)

Manifold Set, Exhaust	1961-1972			MS16035W	1
Oil Pan Set	1961-1972		Cork Rubber	OS30921	1
Rear Main Seal Set	1961-1972		Rope Packing	JV730	1
			Molded Rubber	JV730P	1
Timing Cover Set	1961-1972			JV820	1
			(Contains Repair Sleeve)	JV930	1
Timing Cover Seal	1961-1972			46244	1
Harmonic Balancer Repair Sleeve	1961-1972		Ground Steel, .020" Thickness	66594RS	1
			Use With Part Number A504 Nickel Plated Formed Steel, .013" Thickness	A225	1

MISCELLANEOUS GASKETS

Air Cleaner Mount Gasket	1968-1972		1 Barrel Carburetor	G25936	1
	1961		1 Barrel Carburetor	G26540	1
Carb. Mount Gasket	1970-1972		1 Barrel Carburetor, Spacer To Manifold	G25498	1
			1 Barrel Carburetor, Carburetor To Manifold, Carburetor To Spacer	G26223	1
	1965-1969		Improved Combustion Emission Control System Or Carter Carburetor, 1 Barrel Carburetor	G26186	1
	1962-1969		Except Improved Combustion Emission Control Or Carter Carburetor, 1 Barrel Carburetor, Carburetor To Spacer	G26581	1
	1961-1969		Except Improved Combustion Emission Control Or Carter Carburetor, 1 Barrel Carburetor, Spacer To Manifold	G5260EK	1
Exhaust Pipe Gasket	1963-1972		(Ring Type 'C'), Pipe To Manifold 1.75" Pipe	F7355	1
			1.80" Pipe, (Ring Type 'B'), Pipe To Manifold	F7387	1
			2" Pipe, (Ring Type 'C'), Pipe To Manifold	F17250	1
			2" Pipe, (Ring Type 'B'), Pipe To Manifold Sintered Metal	F17250S	1
	1961-1962		(Flange Type), Pipe To Manifold	F5360C	1
Fuel Pump Bowl Gasket	1961-1962			D35288	1
Fuel Pump Gasket	1961-1972			D27094	1
			Tuff-Cork	D27094TC	1
Water Outlet Gasket	1961-1972			C24005	1
Water Pump Mount Gasket	1961-1972			K14119	1

28 171 CID (2.8L) German V6 Cyl, 3.661in./93mm (1974-1979) **28**

Part Year VIN Model/Application Part Number Qty.

ENGINE GASKETS

Head Set	1976-1979		Capri	HS3515W	1
	1975-1979		Bobcat, Mustang, Pinto	HS3515W	1
	1974-1975		Capri	HS3515	1
	1974		Mustang	HS3515	1
Full Set	1976-1979		Capri	FS3515W	1
	1975-1979		Bobcat, Mustang, Pinto	FS3515W	1
	1974-1975		Capri	FS3515	1
	1974		Mustang	FS3515	1
Engine Kit Gasket Set	1975-1979			95-3361VR	1
	1974		(Intake Manifold Gasket Not Included), Use With Part Number MS15751	95-3361VR	1
Cylinder Head Gasket	1974-1979		Left Head VR2000	3778	1
			Right Head VR2000	3779	1
Valve Cover Set	1974-1979		Cork Rubber	VS39761	1
Valve Stem Seal, Exh.	1974-1979			B45900	6
Valve Stem Seal, Int.	1974-1979			B45900	6
Manifold Set, Exhaust	1974-1979			MS18851	1

28 171 CID (2.8L) German V6 Cyl, 3.661in./93mm (1974-1979) **28**
(cont.) (cont.)

Part	Year	VIN	Model/Application	Part Number	Qty.
ENGINE GASKETS (cont.)					
Manifold Set, Intake	1976-1979		Bobcat, Capri, Mustang, Pinto	MS15752	1
	1975		Bobcat, Pinto	MS15751	1
	1974-1975		Capri, Mustang	MS15751	1
Oil Pan Set	1974-1979		Cork Rubber	OS30555	1
Rear Main Seal Set	1974-1979			JV617	1
Timing Cover Set	1974-1979			JV880	1
Timing Cover Seal	1974-1979			47518	1

MISCELLANEOUS GASKETS

Air Cleaner Mount Gasket	1977-1979		Except California, 2 Barrel Carburetor	G27098	1
			California, 2 Barrel Carburetor	G31432	1
	1975-1976		2 Barrel Carburetor	G27098	1
	1974		2 Barrel Carburetor	G27296	1
Carb. Mount Gasket	1977-1979		2 Barrel Carburetor, Spacer To Manifold	G27288	1
	1975-1979		2 Barrel Carburetor, Carburetor To Spacer	G26048	1
	1976		Thru 8/76, 2 Barrel Carburetor, Spacer To Manifold	G26736	1
			From 8/76, 2 Barrel Carburetor, Spacer To Manifold	G27288	1
	1975		2 Barrel Carburetor, Spacer To Manifold	G26736	1
	1974		2 Barrel Carburetor, Spacer To Manifold	G26733	1
			2 Barrel Carburetor, Carburetor To Spacer	G26734	1
E.G.R. Gasket	1977-1979		Bobcat, Capri, Mustang, Pinto	G26702	1
	1976		Bobcat, Capri, Mustang, Pinto, Thru 8/76	G26701	1
			Bobcat, Capri, Mustang, Pinto, From 8/76	G26702	1
	1975		Bobcat, Capri, Mustang, Pinto	G26701	1
	1974			G26700	1
Exhaust Pipe Gasket	1975-1979		(Flange Type), Pipe To Converter 2-5/16" Inside Diameter	F14144	1
			(Flange Type), Pipe To Converter 2-1/2" Inside Diameter	F14145	1
	1976-1978		Bobcat, Capri, (Ring Type 'B'), Pipe To Manifold	F7390	1
	1975		Bobcat, (Ring Type 'B'), Pipe To Manifold	F7212	1
	1974-1975		Capri, (Ring Type 'B'), Pipe To Manifold	F7212	1
Fuel Pump Gasket	1974-1979			D27160	1
Thermostat Seal	1974-1979		Victo-Tech	C45407	1
Water Outlet Gasket	1975-1979		Upper	C26677	1
	1974-1979		Lower Front	C26675	1
			Lower Rear	C26686	1
	1974		Thru 6/74, Upper	C26671	1
		From 7/74, Upper	C26677	1	
Water Pump Mount Gasket	1974-1979			K30821	1

29 2900CC (2.9L) Merkur V6 Cyl, 3.661in./93mm (1988-1990) **29**

Part	Year	VIN	Model/Application	Part Number	Qty.
ENGINE GASKETS					
Head Set	1988-1989		(Head Bolts Not Included, Intake Manifold Gasket Not Included)	HS5721	1
			(Contains Head Bolts, Intake Manifold Gasket Not Included)	HS5721WB	1
Full Set	1988-1989		(Intake Manifold Gasket Not Included)	FS5721	1
Engine Kit Gasket Set	1988-1989			95-3294VR	1
Cylinder Head Gasket	1988-1989		Left Head VR2000	5721	1
			Right Head VR2000	5722	1
Cyl. Head Bolt Set	1988-1990			GS33221	2
Valve Cover Set	1988-1989		Cork Rubber	VS50014	1
			Victo-Tech	VS50014R	1
Valve Stem Seal, Exh.	1988-1990			B45900	6
Valve Stem Seal, Int.	1988-1990			B45900	6
Manifold Set, Exhaust	1988-1989			MS15429	1

Ford

29 (cont.)	2900CC (2.9L) Merkur V6 Cyl, 3.661in./93mm (1988-1990)				29 (cont.)
----------------------	---	--	--	--	----------------------

Part	Year	VIN	Model/Application	Part Number	Qty.
------	------	-----	-------------------	-------------	------

ENGINE GASKETS (cont.)

Manifold Set, Intake	1988-1989		(Contains Plenum Chamber Gasket)	MS15702W	1
Plenum Chamber Gasket	1988-1989			MS14753	1
Oil Pan Set	1988-1989		<i>Victo-Tech</i>	OS32466	1
Rear Main Seal Set	1988-1989			JV617	1
Crank Repair Sleeve	1988-1989		Use With Part Number A511, Rear <i>Nickel Plated Formed Steel, .013" Thickness</i>	A341	1
Timing Cover Set	1988-1989			JV1037	1
Timing Cover Seal	1988-1989			47518	1

MISCELLANEOUS GASKETS

E.G.R. Gasket	1988-1989			G26703	1
Injector Nozzle O-Ring	1988-1989			GS33276	3
Throttle Body Gasket	1988-1989			G30945	1
Water Pump Mount Gasket	1988-1989			K30678	1

30	181 CID/2967CC (3.0L) Duratec/DOHC/24 Valve V6 Cyl, 3.504in./89mm (1996-2003)				30
-----------	--	--	--	--	-----------

Part	Year	VIN	Model/Application	Part Number	Qty.
------	------	-----	-------------------	-------------	------

ENGINE GASKETS

Head Set	2000-2002		(Head Bolts Not Included)	HS54363A	1
	1996-1999		(Head Bolts Not Included)	HS54363	1
Lower Set	1997-2003		(Requires Head Set To Make Full Set)	CS5990A	1
	1996		(Requires Head Set To Make Full Set)	CS5990	1
Cylinder Head Gasket	1996-2002		Right <i>Multi-Layered Steel</i>	54363	1
			Left <i>Multi-Layered Steel</i>	54364	1
Cyl. Head Bolt Set	1996-2003			GS33388	2
Valve Cover Set	2001-2003		(Contains Valve Cover Grommets, Contains Spark Plug Tube Seals) <i>Victo-Tech</i>	VS50336	1
	2000		(Contains Valve Cover Grommets, Contains Spark Plug Tube Seals) <i>Victo-Tech</i>	VS50335	1
	1996-1999		(Contains Valve Cover Grommets, Contains Spark Plug Tube Seals) <i>Victo-Tech</i>	VS50334	1
Valve Stem Seal, Exh.	1996-2003			B45837	12
Valve Stem Seal, Int.	1996-2003			B45837	12
Manifold Set, Exhaust	1996-2003			MS12415	2
Manifold Set, Intake	2003		(Contains Plenum Chamber Gasket) <i>Victo-Tech</i>	MS16362	1
	2000-2002		(Contains Plenum Chamber Gasket) <i>Victo-Tech</i>	MS16358	1
	1996-1999		(Contains Plenum Chamber Gasket) <i>Victo-Tech</i>	MS16356	1
Plenum Chamber Gasket	2000-2003		<i>Victo-Tech</i>	MS16361	1
	1996-1999		<i>Victo-Tech</i>	MS16357	1
Oil Pan Set	1997-2003		Lower <i>Victo-Tech</i>	OS32244	1
	1996		<i>Victo-Tech</i>	OS32145	1
Rear Main Seal Set	1996-2003			JV1612	1
Timing Cover Set	1996-2003		<i>Victo-Tech</i>	JV5026	1

MISCELLANEOUS GASKETS

E.G.R. Gasket	1996-2003			G30625	1
Water Outlet Gasket	1996-2003			C31302	1

31	181 CID/2967CC (3.0L) DOHC 24 VALVE Lincoln V6 Cyl, 3.504in./89mm (2000-2003)				31
-----------	--	--	--	--	-----------

Part	Year	VIN	Model/Application	Part Number	Qty.
------	------	-----	-------------------	-------------	------

ENGINE GASKETS

Valve Stem Seal, Exh.	2000-2003			B45837	12
Valve Stem Seal, Int.	2000-2003			B45837	12
Manifold Set, Exhaust	2000-2003			MS12415	2
Rear Main Seal Set	2000-2003			JV1612	1

31 181 CID/2967CC (3.0L) DOHC 24 VALVE Lincoln V6 Cyl, 3.504in./89mm (2000-2003) **31**
(cont.) (cont.)

Part Year VIN Model/Application Part Number Qty.

MISCELLANEOUS GASKETS

E.G.R. Gasket	2000-2002			G30625	1
Water Outlet Gasket	2000-2003			C31302	1

32 183 CID (3.0L) OHV V6 Cyl, 3.504in./89mm (1986-2003) **32**

Part Year VIN Model/Application Part Number Qty.

ENGINE GASKETS

Head Set	1999		Thru 7/27/99, (Head Bolts Not Included)	HS5891	1
	1998		Thru 7/13/98, (Contains Head Bolts)	HS5891WB	1
	1991-1998		(Head Bolts Not Included)	HS5891	1
	1991-1997		(Contains Head Bolts)	HS5891WB	1
	1986-1990		(Head Bolts Not Included)	HS5717	1
			(Contains Head Bolts)	HS5717WB	1
Lower Set	1991-2001		(Requires Head Set To Make Full Set)	CS5891	1
Full Set	1991		Probe, Sable, Taurus	FS5717W	1
	1990		Sable, Taurus, Thru 3/27/90	FS5717	1
			Probe, Sable, Taurus, From 3/27/90	FS5717A	1
	1986-1989		Sable, Taurus	FS5717	1
Engine Kit Gasket Set	1999		Thru 7/27/99	95-3473VR	1
	1991-1998			95-3473VR	1
	1990		Thru 3/27/90	95-3373VR	1
	1986-1989			95-3373VR	1
Cylinder Head Gasket	1986-2001		Nitroseal	5891	2
Cyl. Head Bolt Set	1999-2003			GS33359	2
	1998		Thru 7/13/98	GS33220	2
			From 7/13/98	GS33359	2
	1986-1997			GS33220	2
Cyl. Head Spacer Shim	1986-2001		Requires Sealing Compound	Steel 5891S	2
Sealing Compound	1986-2001		(4 Ounce Brush Top Can)	JV66B	1
			(12 Ounce Spray Can)	JV66S	1
Valve Cover Set	1991-2003			Victo-Tech VS50145	1
	1986-1990			Tuff-Cork VS50028TC	1
			(Single Valve Cover)	Tuff-Cork VS50130TC	2
				Victo-Tech VS50197	1
			(Single Valve Cover)	Victo-Tech VS50197S	2
Valve Stem Seal, Exh.	2000-2003		7mm Valve Stem Diameter	B45908	6
	1999		Thru 7/27/99	B45576	6
			7mm Valve Stem Diameter, From 7/27/99	B45908	6
	1986-1998			B45576	6
Valve Stem Seal, Int.	2000-2003		7mm Valve Stem Diameter	B45907	6
	1999		Thru 7/27/99	B45575	6
			7mm Valve Stem Diameter, From 7/27/99	B45907	6
	1986-1998			B45575	6
Manifold Set, Exhaust	1986-2003			MS15426	1
Manifold Set, Intake	1986-2003		(Contains Plenum Chamber Gasket)	MS16068	1
Plenum Chamber Gasket	1986-2001			MS15404	1
Oil Pan Set	1993-2001			Victo-Tech OS32486	1
	1992		Tempo, Topaz	Victo-Tech OS32486	1
	1990-1992		Probe, Sable, Taurus	Victo-Tech OS32486	1
	1990		Sable, Taurus, Thru 3/27/90	Victo-Tech OS32465	1
			Sable, Taurus, From 3/27/90	Victo-Tech OS32486	1
	1986-1989			Victo-Tech OS32465	1
Rear Main Seal	1986-2003			47753	1
Rear Main Seal Set	1986-1999			JV555	1
			(Optional)	Teflon JV1638	1

PASSENGER CAR

Ford

32 183 CID (3.0L) OHV V6 Cyl, 3.504in./89mm (1986-2003) **32**
(cont.) (cont.)

Part Year VIN Model/Application Part Number Qty.

ENGINE GASKETS (cont.)

Crank Repair Sleeve	1986-1996		Use With Part Number A507, Rear <i>Nickel Plated Formed Steel, .013" Thickness</i>	A340	1
Timing Cover Set	1995-2003			JV1179	1
	1986-1994			JV1032	1
Timing Cover Seal	1986-2003			46293	1
Harmonic Balancer Repair Sleeve	1986-1995		Use With Part Number A502 <i>Nickel Plated Formed Steel, .013" Thickness</i>	A235	1

MISCELLANEOUS GASKETS

Dist. Mounting Gasket	1996-2001		(O-Ring Type)	72122	1
E.G.R. Gasket	1986-2003			G30625	1
Exhaust Pipe Gasket	1986-1995		Sable, Taurus, (Ring Type 'F'), Pipe To Converter	F10085	1
	1992-1994		Tempo, Topaz, (Ring Type 'F')	F12298	1
	1990-1992		Probe, (Flange Type), Rear	F7486	1
			Probe, (Ring Type 'F'), Front	F12298	1
Injector Nozzle O-Ring	1986-1999			GS33276	3
Water Outlet Gasket	1986-2001			C30649	1
Water Pump Backing Plate	1991-1992		Probe	K27986	1
Water Pump Mount Gasket	1995-2001			K39114	1
	1986-1994			K30629	1

33 183 CID (3.0L) OHV Flex Fuel V6 Cyl, 3.504in./89mm (1993-2003) **33**

Part Year VIN Model/Application Part Number Qty.

ENGINE GASKETS

Head Set	1999		Thru 7/27/99, (Head Bolts Not Included)	HS5891	1
	1998		Thru 7/13/98, (Contains Head Bolts)	HS5891WB	1
	1993-1998		(Head Bolts Not Included)	HS5891	1
	1993-1997		(Contains Head Bolts)	HS5891WB	1
Lower Set	1993-2001		(Requires Head Set To Make Full Set)	CS5891	1
Engine Kit Gasket Set	1999		Thru 7/27/99	95-3473VR	1
	1993-1998			95-3473VR	1
Cylinder Head Gasket	1993-2001		<i>Nitroseal</i>	5891	2
Cyl. Head Bolt Set	1999-2003			GS33359	2
	1998		Thru 7/13/98	GS33220	2
			From 7/13/98	GS33359	2
	1993-1997			GS33220	2
Cyl. Head Spacer Shim	1993-2001		Requires Sealing Compound <i>Steel</i>	5891S	2
Sealing Compound	1993-2001		(4 Ounce Brush Top Can)	JV66B	1
			(12 Ounce Spray Can)	JV66S	1
Valve Cover Set	1993-2003		<i>Victo-Tech</i>	VS50145	1
Valve Stem Seal, Exh.	2000-2003		7mm Valve Stem Diameter	B45908	6
	1999		Thru 7/27/99	B45576	6
			7mm Valve Stem Diameter, From 7/27/99	B45908	6
	1993-1998			B45576	6
Valve Stem Seal, Int.	2000-2003		7mm Valve Stem Diameter	B45907	6
	1999		Thru 7/27/99	B45575	6
			7mm Valve Stem Diameter, From 7/27/99	B45907	6
	1993-1998			B45575	6
Manifold Set, Exhaust	1993-2003			MS15426	1
Manifold Set, Intake	1993-2003		(Contains Plenum Chamber Gasket)	MS16068	1
Plenum Chamber Gasket	1993-2001			MS15404	1
Oil Pan Set	1993-2001		<i>Victo-Tech</i>	OS32486	1
Rear Main Seal	1993-2003			47753	1
Rear Main Seal Set	1993-1999			JV555	1

33 183 CID (3.0L) OHV Flex Fuel V6 Cyl, 3.504in./89mm (1993-2003) **33**
(cont.) (cont.)

Part Year VIN Model/Application Part Number Qty.

ENGINE GASKETS (cont.)

Rear Main Seal Set (cont.)	1993-1999		(Optional) <i>Teflon</i>	JV1638	1
Crank Repair Sleeve	1993-1996		Use With Part Number A507, Rear <i>Nickel Plated Formed Steel, .013" Thickness</i>	A340	1
Timing Cover Set	1995-2001			JV1179	1
	1993-1994			JV1032	1
Timing Cover Seal	1993-2001			46293	1
Harmonic Balancer Repair Sleeve	1993-1995		Use With Part Number A502 <i>Nickel Plated Formed Steel, .013" Thickness</i>	A235	1

MISCELLANEOUS GASKETS

Dist. Mounting Gasket	1996-2001		(O-Ring Type)	72122	1
E.G.R. Gasket	1993-2003			G30625	1
Exhaust Pipe Gasket	1993-1995		(Ring Type 'F'), Pipe To Converter	F10085	1
Injector Nozzle O-Ring	1993-1999			GS33276	3
Water Outlet Gasket	1993-1999			C30649	1
Water Pump Mount Gasket	1995-2003			K39114	1
	1993-1994			K30629	1

34 183 CID (3.0L) SHO DOHC Yamaha V6 Cyl, 3.504in./89mm (1989-1995) **34**

Part Year VIN Model/Application Part Number Qty.

ENGINE GASKETS

Head Set	1989-1995			HS54033	1
Cylinder Head Gasket	1989-1995		<i>Nitroseal</i>	54033	2
Cyl. Head Bolt Set	1989-1995			GS33318	1
Valve Cover Set	1989-1995			VS50220	1
Valve Stem Seal, Exh.	1989-1995			B45831	12
Valve Stem Seal, Int.	1989-1995			B45830	12
Manifold Set, Exhaust	1989-1995			MS16180	1
Manifold Set, Intake	1989-1995			MS16179	1

MISCELLANEOUS GASKETS

Injector Nozzle O-Ring	1989-1994			GS33277	2
Therm. Housing Gasket	1989-1995			C31446	1
Throttle Body Gasket	1989-1995			G31439	1
Water Outlet Gasket	1989-1995			C31460	2

35 195 CID (3.2L) SHO DOHC Yamaha V6 Cyl, 3.600in./91.4mm (1993-1995) **35**

Part Year VIN Model/Application Part Number Qty.

ENGINE GASKETS

Cyl. Head Bolt Set	1993-1995			GS33318	1
Valve Cover Set	1993-1995			VS50220	1
Valve Stem Seal, Exh.	1993-1995			B45831	12
Valve Stem Seal, Int.	1993-1995			B45830	12
Manifold Set, Exhaust	1993-1995			MS16180	1
Manifold Set, Intake	1993-1995			MS16179	1

MISCELLANEOUS GASKETS

Therm. Housing Gasket	1993-1995			C31446	1
Throttle Body Gasket	1993-1995			G31439	1
Water Outlet Gasket	1993-1995			C31460	2

Ford

36 200 CID (3.3L) L-Head 4 Cyl, 3.875in./98.4mm (1933-1934) 36

Part	Year	VIN	Model/Application	Part Number	Qty.
ENGINE GASKETS					
Manifold Set, Int. & Exh.	1933-1934			MS9800	1

37 200 CID (3.3L) OHV 6 Cyl, 3.680in./93.5mm (1963-1983) 37

Part	Year	VIN	Model/Application	Part Number	Qty.
ENGINE GASKETS					
Head Set	1963-1983		(Exhaust Pipe Gasket Not Included)	HS3910VJ	1
Full Set	1963-1983		(Exhaust Pipe Gasket Not Included)	FS3910VJ	1
Engine Kit Gasket Set	1963-1983			95-3005VR	1
Cylinder Head Gasket	1963-1983		VR2000	3910VC	1
Valve Cover Set	1963-1983		Cork Rubber	VS39564	1
Valve Stem Seal, Exh.	1963-1983			B45320	6
Valve Stem Seal, Int.	1963-1983			B45320	6
Manifold Set, Exhaust	1963-1983			MS16035W	1
Oil Pan Set	1963-1983		Cork Rubber	OS30921	1
Rear Main Seal Set	1963-1983		Rope Packing	JV730	1
			Molded Rubber	JV730P	1
Timing Cover Set	1963-1983			JV820	1
			(Contains Repair Sleeve)	JV930	1
Timing Cover Seal	1963-1983			46244	1
Harmonic Balancer Repair Sleeve	1963-1983		Ground Steel	66594RS	1
			Use With Part Number A504 Nickel Plated Formed Steel, .013" Thickness	A225	1

MISCELLANEOUS GASKETS

Air Cleaner Mount Gasket	1983		LTD, Marquis, 1 Barrel Carburetor	G26540	1
	1980-1983		Fairmont, Zephyr, 1 Barrel Carburetor	G26540	1
	1981-1982		Cougar, Granada, 1 Barrel Carburetor	G26540	1
	1980-1982		Capri, Mustang, Thunderbird, 1 Barrel Carburetor	G26540	1
	1979		Capri, Manual Transmission, 1 Barrel Carburetor	G25936	1
			Capri, Except Manual Transmission, 1 Barrel Carburetor	G26540	1
	1978-1979		Fairmont, Zephyr, Manual Transmission, 1 Barrel Carburetor	G25936	1
			Fairmont, Mustang, Zephyr, Except Manual Transmission, 1 Barrel Carburetor	G26540	1
	1968-1979		Mustang, Manual Transmission, 1 Barrel Carburetor	G25936	1
	1975-1977		Granada, Monarch, 1 Barrel Carburetor	G25936	1
	1971-1977		Comet, 1 Barrel Carburetor	G25936	1
	1969-1977		Maverick, 1 Barrel Carburetor	G25936	1
	1969-1973		Mustang, 1 Barrel Carburetor	G25936	1
	1968-1970		Fairlane 500, Falcon, 1 Barrel Carburetor	G25936	1
	1968-1969		Fairlane, Torino, 1 Barrel Carburetor	G25936	1
	1968		Comet, Montego, Montego MX, 1 Barrel Carburetor	G25936	1
	Carb. Mount Gasket	1983		LTD, Marquis, 1 Barrel Carburetor, Spacer To Manifold	G27364
1980-1983			1 Barrel Carburetor, Carburetor To Spacer	G26190	1
			Fairmont, Zephyr, 1 Barrel Carburetor, Spacer To Manifold	G26732	1
1981-1982			Cougar, Granada, 1 Barrel Carburetor, Spacer To Manifold	G27364	1
1980-1982			Capri, Mustang, Thunderbird, 1 Barrel Carburetor, Spacer To Manifold	G27364	1
1977-1979			1 Barrel Carburetor, Spacer To Manifold	G26732	1
1975-1979			1 Barrel Carburetor, Carburetor To Spacer	G26163	1
1970-1976			1 Barrel Carburetor, Spacer To Manifold	G25498	1
1974			Except Thermactor Emission, 1 Barrel Carburetor, Carburetor To Spacer	G26177	1
			Thermactor Emission, 1 Barrel Carburetor, Carburetor To Spacer	G26639	1
1973-1974		1 Barrel Carburetor, Carburetor To Heat Shield	G26163	1	
1973		1 Barrel Carburetor, Carburetor To Spacer	G26639	1	

37 200 CID (3.3L) OHV 6 Cyl, 3.680in./93.5mm (1963-1983) **37**
(cont.) (cont.)

Part	Year	VIN	Model/Application	Part Number	Qty.
MISCELLANEOUS GASKETS (cont.)					
Carb. Mount Gasket (cont.)	1970-1972		1 Barrel Carburetor, Carburetor To Manifold, Carburetor To Spacer	G26223	1
	1968-1969		1 Barrel Carburetor, Carburetor To Spacer	G26581	1
	1963-1969		1 Barrel Carburetor, Spacer To Manifold	G5260EK	1
	1967		C4 Automatic Transmission, Improved Combustion Emission Control System, 1 Barrel Carburetor, Carburetor To Spacer	G26186	1
			Except C4 Transmission, Except Improved Combustion Emission Control System, 1 Barrel Carburetor, Carburetor To Spacer	G26581	1
1963-1966		1 Barrel Carburetor, Carburetor To Spacer	G26581	2	
E.G.R. Gasket	1977-1983			G26702	1
	1973-1976			G26701	1
Exhaust Pipe Gasket	1978-1983		(Flange Type), Pipe To Converter	F14144	1
	1963-1983		(Ring Type 'C'), Pipe To Manifold <i>1.75" Pipe</i>	F7355	1
			1.80" Pipe, (Ring Type 'B'), Pipe To Manifold	F7387	1
			2" Pipe, (Ring Type 'C'), Pipe To Manifold	F17250	1
			2" Pipe, (Ring Type 'B'), Pipe To Manifold <i>Sintered Metal</i>	F17250S	1
	1977		Comet, Maverick, Mustang, (Flange Type), Pipe To Converter	F14145	1
1975-1977		Granada, Monarch, (Flange Type), Pipe To Converter	F14145	1	
Fuel Pump Gasket	1963-1983			D27094	1
			<i>Tuff-Cork</i>	D27094TC	1
Oil Pan Drain Plug Gst.	1978-1979			2051	1
Water Outlet Gasket	1963-1983			C24005	1
Water Pump Mount Gasket	1963-1983			K14119	1

38 212 CID (3.5L) L-Head 4 Cyl, 3.875in./98.4mm (1928-1932) **38**

Part	Year	VIN	Model/Application	Part Number	Qty.
ENGINE GASKETS					
Head Set	1928-1931			HS800C	1
Full Set	1928-1931			FS800C	1
Cylinder Head Gasket	1928-1931			800C	1
Manifold Set, Int. & Exh.	1928-1932			MS9800	1
Oil Pan Set	1928-1931		<i>Cork Rubber</i>	OS30300	1

39 215 CID (3.5L) 6 Cyl, 3.563in./90.5mm (1952-1953) **39**

Part	Year	VIN	Model/Application	Part Number	Qty.
ENGINE GASKETS					
Head Set	1952-1953		(Intake Manifold Gasket Not Included, Exhaust Manifold Gasket Not Included, O-Ring Type Valve Seals Not Included)	HS3264VW	1
Full Set	1952-1953		(Intake Manifold Gasket Not Included, Exhaust Manifold Gasket Not Included, O-Ring Type Valve Seals Not Included)	FS3264VW	1
Cylinder Head Gasket	1952-1953		<i>VR2000</i>	3264VC	1
Valve Cover Set	1952-1953		<i>Cork Rubber</i>	VS39683	1
Valve Stem Seal, Exh.	1952-1953		(O-Ring Type)	B45229	6
			(Umbrella Type)	B45283	6
Valve Stem Seal, Int.	1952-1953		(O-Ring Type)	B45229	6
			(Umbrella Type)	B45283	6
Manifold Set, Int. & Exh.	1952-1953			MS16037X	1
Oil Pan Set	1952-1953		<i>Cork Rubber</i>	OS31570	1
Rear Main Seal Set	1952-1953		<i>Rope Packing</i>	JV683	1
			<i>Molded Rubber</i>	JV683P	1

Ford

39 (cont.)	215 CID (3.5L) 6 Cyl, 3.563in./90.5mm (1952-1953)				39 (cont.)
----------------------	--	--	--	--	----------------------

<i>Part</i>	<i>Year</i>	<i>VIN</i>	<i>Model/Application</i>	<i>Part Number</i>	<i>Qty.</i>
-------------	-------------	------------	--------------------------	--------------------	-------------

ENGINE GASKETS (cont.)

Timing Cover Set	1952-1953			JV818	1
Timing Cover Seal	1952-1953			46293	1

MISCELLANEOUS GASKETS

Carb. Mount Gasket	1952-1953		1 Barrel Carburetor, Spacer To Manifold	G5260EK	1
Exhaust Pipe Gasket	1952-1953		(Flange Type), Pipe To Manifold	F5451K	1
Fuel Pump Bowl Gasket	1952-1953			D35288	1
Fuel Pump Gasket	1952-1953			D27094	1
Push Rod Cover Grommet	1952-1953			B45317	2
Push Rod Cover Set	1952-1953			PS39563	1
Valve Cover Grommet	1952-1953			B45317	2
Water Outlet Gasket	1952-1953			C25435	1
Water Pump Mount Gasket	1952-1953			K25856	1

40	221 CID (3.6L) V8 Cyl, 3.063in./77.8mm (1932-1942)				40
-----------	---	--	--	--	-----------

<i>Part</i>	<i>Year</i>	<i>VIN</i>	<i>Model/Application</i>	<i>Part Number</i>	<i>Qty.</i>
-------------	-------------	------------	--------------------------	--------------------	-------------

ENGINE GASKETS

Full Set	1938-1942		100 Horsepower	FS1026K	1
Cylinder Head Gasket	1938-1942		100 Horsepower <i>VR2000</i>	1026K	2
	1932-1942		Rebored To 3.438" Maximum <i>Copper</i>	3036	2
	1932-1938		85-90 Horsepower <i>VR2000</i>	1002K	2
Valve Cover Set	1932-1942		(Contains Intake Manifold Gaskets) <i>Cork Rubber</i>	VS18765	1
Manifold Set, Exhaust	1932-1942			MS5278AK	1
Oil Pan Set	1932-1942		<i>Cork Rubber</i>	OS31242	1
Rear Main Seal Set	1932-1942			JV674	1
Timing Cover Set	1932-1942			JV762	1

MISCELLANEOUS GASKETS

Exhaust Pipe Gasket	1932-1942			F17802	2
Fuel Pump Cover Gasket	1936-1942			D34545	1

41	221 CID (3.6L) V8 Cyl, 3.500in./88.9mm (1962-1963)				41
-----------	---	--	--	--	-----------

<i>Part</i>	<i>Year</i>	<i>VIN</i>	<i>Model/Application</i>	<i>Part Number</i>	<i>Qty.</i>
-------------	-------------	------------	--------------------------	--------------------	-------------

ENGINE GASKETS

Full Set	1962-1963		(Exhaust Manifold Gasket Not Included, Ring Type 'C' Exhaust Pipe Gasket Not Included)	FS1186	1
Valve Cover Set	1962-1963		<i>Cork Rubber</i>	VS38300	1
			<i>High Temperature Cork Rubber</i>	VS38300H	1
			<i>High Temperature Tuff-Cork</i>	VS38300HTC	1
			<i>Victo-Tech</i>	VS38300R	1
Valve Stem Seal, Exh.	1962-1963			B45399	8
Valve Stem Seal, Int.	1962-1963			B45399	8
Manifold Set, Exhaust	1962-1963			MS15129X	1
Manifold Set, Intake	1962-1963			MS15172	1
Oil Pan Set	1962-1963		<i>Cork Rubber</i>	OS30531	1
Rear Main Seal Set	1962-1963		<i>Rope Packing</i>	JV730	1
			<i>Molded Rubber</i>	JV730R	1
Timing Cover Set	1962-1963			JV856	1
			(Contains Repair Sleeve)	JV922	1
Timing Cover Gasket	1962-1963			T27802	1
Timing Cover Seal	1962-1963			46293	1
Harmonic Balancer Repair Sleeve	1962-1963		<i>Ground Steel, .020" Thickness</i>	66595RS	1

41 221 CID (3.6L) V8 Cyl, 3.500in./88.9mm (1962-1963) **41**
(cont.) (cont.)

Part Year VIN Model/Application Part Number Qty.

ENGINE GASKETS (cont.)

Harmonic Balancer Repair Sleeve (cont.)	1962-1963		Use With Part Number A502 <i>Nickel Plated Formed Steel, .013" Thickness</i>	A226-2	1
---	-----------	--	---	--------	---

MISCELLANEOUS GASKETS

Carb. Mount Gasket	1962-1963		2 Barrel Carburetor	G26052	2
Dist. Mounting Gasket	1962-1963			72125	1
Exhaust Pipe Gasket	1962-1963		(Flange Type), Pipe To Manifold	F5451K	1
			(Ring Type 'C'), Pipe To Manifold	F17250	1
			(Ring Type 'B'), Pipe To Manifold <i>Sintered Metal</i>	F17250S	1
Fuel Pump Bowl Gasket	1962-1963			D35288	1
Fuel Pump Gasket	1962-1963			D27094	1
Oil Pan Drain Plug Gst.	1962-1963			2066A	1
Oil Pump Inlet Tube	1962-1963			B26151	1
Oil Pump Mounting Gasket	1962-1963			B26553	1
Water Outlet Gasket	1962-1963			C24005	1
Water Pump Mount Gasket	1962-1963			K27579	1

42 223 CID (3.7L) 6 Cyl, 3.625in./92.1mm (1954-1964) **42**

Part Year VIN Model/Application Part Number Qty.

ENGINE GASKETS

Head Set	1954-1964		(Contains Intake Manifold Gaskets, Ring Type 'C' Exhaust Pipe Gasket Not Included)	HS3264VW	1
Full Set	1954-1964		(Contains Intake Manifold Gaskets, Ring Type 'C' Exhaust Pipe Gasket Not Included)	FS3264VW	1
Cylinder Head Gasket	1954-1964		<i>VR2000</i>	3264VC	1
Valve Cover Set	1960-1964		<i>Cork Rubber</i>	VS39565	1
	1954-1959		<i>Cork Rubber</i>	VS39683	1
Valve Stem Seal, Exh.	1961-1964		Except Zero Lash Valves	B45283	6
			Zero Lash Valves	B45373	6
	1954-1960			B45283	6
Valve Stem Seal, Int.	1961-1964		Except Zero Lash Valves	B45283	6
			Zero Lash Valves	B45373	6
	1954-1960			B45283	6
Manifold Set, Intake	1954-1964		(Multi Piece)	MS9997	1
Manifold Set, Int. & Exh.	1954-1964		(One Piece)	MS16037X	1
Oil Pan Set	1954-1964		<i>Cork Rubber</i>	OS31570	1
Rear Main Seal Set	1954-1964		<i>Rope Packing</i>	JV683	1
			<i>Molded Rubber</i>	JV683P	1
Timing Cover Set	1954-1964		Zero Lash Valves	JV818	1
			Except Zero Lash Valves	JV827	1
Timing Cover Seal	1954-1964			46293	1

MISCELLANEOUS GASKETS

Air Cleaner Mount Gasket	1954-1960		1 Barrel Carburetor	G25936	1
Carb. Mount Gasket	1954-1964		1 Barrel Carburetor, Spacer To Manifold	G5260EK	1
Exhaust Pipe Gasket	1963-1964		(Ring Type 'C'), Pipe To Manifold	F17250	1
			(Ring Type 'B'), Pipe To Manifold <i>Sintered Metal</i>	F17250S	1
	1954-1962		(Flange Type), Pipe To Manifold	F5451K	1
Fuel Pump Bowl Gasket	1954-1964			D35288	1
Fuel Pump Gasket	1954-1964			D27094	1
Oil Pan Drain Plug Gst.	1957-1964			2066A	1

Ford

42 (cont.)	223 CID (3.7L) 6 Cyl, 3.625in./92.1mm (1954-1964)				42 (cont.)
----------------------	--	--	--	--	----------------------

<i>Part</i>	<i>Year</i>	<i>VIN</i>	<i>Model/Application</i>	<i>Part Number</i>	<i>Qty.</i>
MISCELLANEOUS GASKETS (cont.)					
Push Rod Cover Grommet	1954-1964			B45317	2
Push Rod Cover Set	1954-1964			PS39563	1
Valve Cover Grommet	1954-1962			B45317	2
Water Outlet Gasket	1954-1964			C25435	1
Water Pump Mount Gasket	1954-1956			K25856	1

43	232 CID (3.8L) V6 Cyl, 3.811in./96.8mm (1982-2003)				43
-----------	---	--	--	--	-----------

<i>Part</i>	<i>Year</i>	<i>VIN</i>	<i>Model/Application</i>	<i>Part Number</i>	<i>Qty.</i>
-------------	-------------	------------	--------------------------	--------------------	-------------

ENGINE GASKETS						
Head Set	1999		(Head Bolts Not Included, Contains 4mm Thick Intake Manifold Gasket)	HS54175E	1	
	1997-1998		(Head Bolts Not Included)	HS54177	1	
	1996		Cougar, Mustang, Thunderbird, (Head Bolts Not Included)	HS54191	1	
	1994-1995			Sable, Taurus, (Head Bolts Not Included)	HS5786A	1
				Thunderbird, (Head Bolts Not Included), Supercharged	HS5815A	1
				Cougar, (Head Bolts Not Included)	HS5816A	1
				Thunderbird, (Head Bolts Not Included), Naturally Aspirated	HS5816A	1
				Mustang, Exhaust Manifold Gasket Not Included, Use With Part Number MS16277	HS5816A	1
	1994		Continental, (Head Bolts Not Included)	HS5786A	1	
	1989-1993			Continental, Sable, Taurus, (Contains Head Bolts)	HS5786WB	1
				Thunderbird, (Head Bolts Not Included), Supercharged	HS5815	1
				Thunderbird, (Contains Head Bolts), Supercharged	HS5815WB	1
				Cougar, Thunderbird, (Contains Head Bolts), Naturally Aspirated	HS5816WB	1
	1988-1993			Continental, Sable, Taurus, (Head Bolts Not Included)	HS5786	1
				Cougar, Thunderbird, (Head Bolts Not Included), Naturally Aspirated	HS5816	1
	1989-1990			Cougar, (Head Bolts Not Included), Supercharged	HS5815	1
				Cougar, (Contains Head Bolts), Supercharged	HS5815WB	1
	1988			Continental, Sable, Taurus, (Contains Head Bolts)	HS5786WB1	1
				Cougar, Thunderbird, (Contains Head Bolts)	HS5816WB1	1
	1987			(Contains Head Bolts)	HS3677WB2	1
				(Head Bolts Not Included)	HS3677Y	1
	1986			Thru 1/15/86, (Contains Head Bolts)	HS3677WB1	1
				From 1/15/86, (Contains Head Bolts)	HS3677WB2	1
				Thru 1/15/86, (Head Bolts Not Included)	HS3677X	1
				From 1/15/86, (Head Bolts Not Included)	HS3677Y	1
	1984-1985			(Contains Head Bolts)	HS3677WB1	1
				(Head Bolts Not Included)	HS3677X	1
	1982-1983			(Head Bolts Not Included)	HS3677	1
				(Contains Head Bolts)	HS3677WB	1
	Lower Set	1994-1999		(Requires Head Set To Make Full Set)	CS5815	1
	Full Set	1989-1993		Thunderbird, Supercharged	FS5815	1
		1988-1993		Continental, Sable, Taurus, Front Wheel Drive	FS5786	1
			Cougar, Thunderbird, Rear Wheel Drive, Naturally Aspirated	FS5816	1	
1989-1990			Cougar, Supercharged	FS5815	1	
1987				FS3677Y	1	
1986				Thru 1/15/86	FS3677X	1
				From 1/15/86	FS3677Y	1
1984-1985				FS3677X	1	
1982-1983				FS3677W	1	
Engine Kit Gasket Set	1994-1995		Thunderbird	95-3474VR	1	
			Mustang, (Exhaust Manifold Gasket Not Included), Use With Part Number MS16277	95-3474VR	1	

Part	Year	VIN	Model/Application	Part Number	Qty.
ENGINE GASKETS (cont.)					
Engine Kit Gasket Set (cont.)	1994-1995		Cougar	95-3474VR	1
			Sable, Taurus	95-3476VR	1
	1994		Continental	95-3476VR	1
	1989-1993		Rear Wheel Drive	95-3387VR	1
			Front Wheel Drive	95-3389VR	1
	1988		Rear Wheel Drive	95-3386VR	1
			Front Wheel Drive	95-3388VR	1
	1987			95-3209VR	1
	1986		From 1/16/86	95-3209VR	1
			Thru 1/15/86, (Intake Manifold Gasket Not Included), Use With Part Number MS15296W	95-3363VR	1
1984-1985		(Intake Manifold Gasket Not Included), Use With Part Number MS15296W	95-3363VR	1	
1982-1983		(Intake Manifold Gasket Not Included), Use With Part Number MS15296	95-3363VR	1	
Cylinder Head Gasket	1999-2003		Right <i>Multi-Layered Steel</i>	54175	1
			Left <i>Multi-Layered Steel</i>	54176	1
	1997-1998		Right <i>Multi-Layered Steel</i>	54177	1
			Left <i>Multi-Layered Steel</i>	54178	1
	1996		Cougar, Mustang, Thunderbird <i>Nitroseal</i>	54191	2
	1994-1995		Mustang, Rear Wheel Drive <i>Nitroseal</i>	5816	2
	1989-1995		Thunderbird, Supercharged <i>Nitroseal</i>	5815	2
	1988-1995		Sable, Taurus, Front Wheel Drive <i>Nitroseal</i>	5786	2
			Cougar, Thunderbird, Rear Wheel Drive, Naturally Aspirated <i>Nitroseal</i>	5816	2
	1988-1994		Continental, Front Wheel Drive <i>Nitroseal</i>	5786	2
	1989-1990		Cougar, Supercharged <i>Nitroseal</i>	5815	2
	1982-1987		<i>Nitroseal</i>	5816	2
	Cyl. Head Bolt Set	1996-2003			GS33317
1989-1995				GS33219	2
1982-1988				GS33194	2
Cyl. Head Spacer Shim	1989-1995		Thunderbird, Requires Sealing Compound, Supercharged <i>Steel</i>	5815S	2
	1988-1995		Sable, Taurus, Front Wheel Drive, Requires Sealing Compound <i>Steel</i>	5786S	2
	1988-1994		Continental, Front Wheel Drive, Requires Sealing Compound <i>Steel</i>	5786S	2
	1989-1990		Cougar, Requires Sealing Compound, Supercharged <i>Steel</i>	5815S	2
Sealing Compound	1982-1997		(4 Ounce Brush Top Can)	JV66B	1
			(12 Ounce Spray Can)	JV66S	1
Valve Cover Set	1994-2003		(Valve Cover Grommets Not Included) <i>Victo-Tech</i>	VS50202	1
			(Contains Valve Cover Grommets) <i>Victo-Tech</i>	VS50202A	1
			(Single Valve Cover) <i>Victo-Tech</i>	VS50202S	2
	1988-1993		<i>Tuff-Cork</i>	VS50057TC	1
			(Single Valve Cover) <i>Tuff-Cork</i>	VS50131TC	2
			<i>Victo-Tech</i>	VS50201	1
			(Single Valve Cover) <i>Victo-Tech</i>	VS50201S	2
	1987		<i>Tuff-Cork</i>	VS50029TC	1
			(Single Valve Cover) <i>Tuff-Cork</i>	VS50132TC	2
			<i>Victo-Tech</i>	VS50198	1
			(Single Valve Cover) <i>Victo-Tech</i>	VS50198S	2
	1986		Thru 1/15/86 <i>Cork Rubber</i>	VS39254	1
			From 1/15/86 <i>Tuff-Cork</i>	VS50029TC	1
			From 1/15/86, (Single Valve Cover) <i>Tuff-Cork</i>	VS50132TC	2
			From 1/15/86 <i>Victo-Tech</i>	VS50198	1
		From 1/15/86, (Single Valve Cover) <i>Victo-Tech</i>	VS50198S	2	
1982-1985		<i>Cork Rubber</i>	VS39254	1	

Ford

43 232 CID (3.8L) V6 Cyl, 3.811in./96.8mm (1982-2003)

(cont.)

43

(cont.)

Part Year VIN Model/Application Part Number Qty.

ENGINE GASKETS (cont.)

Valve Stem Seal, Exh.	1999-2003			B45906	6	
	1996-1998			B45823	6	
	1989-1995			B45547	6	
	1982-1988			B45399	6	
Valve Stem Seal, Int.	1999-2003			B45906	6	
	1996-1998			B45823	6	
	1987-1995			B45547	6	
	1982-1986			B45399	6	
Manifold Set, Exhaust	1999-2003		Nitroseal	MS16318	1	
	1996-1998			MS16277	1	
	1994-1995		Cougar, Sable, Taurus, Thunderbird	MS12296	1	
			Mustang	MS16277	1	
	1982-1993			MS12296	1	
Manifold Set, Intake	2000-2002	(Plenum Chamber Gasket Not Included)	Victo-Tech	MS16230	1	
	1999	(Plenum Chamber Gasket Not Included)	Victo-Tech	MS16233-1	1	
	1996-1998	Mustang, (Contains Plenum Chamber Gasket)		MS16282	1	
	1996-1997	Cougar, Thunderbird, (Contains Plenum Chamber Gasket)		MS16282	1	
	1988-1995	(Contains Plenum Chamber Gasket)		MS15451	1	
	1984-1987			MS15296W	1	
	1982-1983			MS15296	1	
Plenum Chamber Gasket	1999-2001		Performaseal	MS16284	1	
	1988-1998			MS15975	1	
Oil Pan Set	2000	Except Engine Tags AK-530/531-BA, SK-530/531-BA		OS32524	1	
	1989-1999			OS32524	1	
	1988		Cork Rubber	OS32483	1	
	1982-1987		Cork Rubber	OS30592	1	
Rear Main Seal Set	1984-2003			JV523	1	
	1984-2001		Teflon	JV1635	1	
	1983		From 1/1/83		JV523	1
			Thru 1/83	Rope Packing	JV730	1
			Thru 1/83	Molded Rubber	JV730R	1
			From 1/1/83	Teflon	JV1635	1
	1982			Rope Packing	JV730	1
			Molded Rubber	JV730R	1	
Crank Repair Sleeve	1982-1997	Use With Part Number A505, Rear Nickel Plated Formed Steel, .013" Thickness	A331	1		
Timing Cover Set	2000-2001		Performaseal	JV5012	1	
	1988-1999			JV1073	1	
	1982-1987			JV979	1	
			(Contains Repair Sleeve)		JV1132	1
Timing Cover Gasket	1990-2001		Performaseal	T31565	1	
Timing Cover Seal	1982-2001			46293	1	
Harmonic Balancer Repair Sleeve	1982-1987	Use With Part Number A502 Nickel Plated Formed Steel, .013" Thickness		A226-2	1	

MISCELLANEOUS GASKETS

Air Cleaner Mount Gasket	1984-1987		Canadian, 2 Barrel Carburetor	G27098	1
			Except Canadian Models, 2 Barrel Carburetor	G31432	1
	1983		2 Barrel Carburetor	G27098	1
	1982-1983		Canadian, Except California, 2 Barrel Carburetor	G27098	1
	1982		Except California, 2 Barrel Carburetor	G27098	1
Carb. Mount Gasket	1984-1987		2 Barrel Carburetor, Spacer To Manifold	G26896	1
	1982-1987		2 Barrel Carburetor, Carburetor To Spacer	G26864	1
	1982-1983		2 Barrel Carburetor	G26865	1
Dist. Mounting Gasket	1996-2001		(O-Ring Type)	72122	1
	1990-1995		(O-Ring Type)	72025	1

43 232 CID (3.8L) V6 Cyl, 3.811in./96.8mm (1982-2003) **43**
(cont.) (cont.)

Part	Year	VIN	Model/Application	Part Number	Qty.
MISCELLANEOUS GASKETS (cont.)					
E.G.R. Gasket	1988-2001			G30625	1
	1982-1989		Valve To Adapter	G26702	1
	1982-1987		Between Adapter And Spacer	G24669	1
Exhaust Pipe Gasket	1991-1996		Single Exhaust, (Flange Type)	F12438	1
	1989-1995		Dual Exhaust, Pipe To Converter	F10085	1
	1990-1994		(Flange Type), Pipe To Converter	F12438	1
	1989-1990		Thru 12/89, (Ring Type 'F')	F10085	1
	1988-1990		Dual Exhaust, Except Dual Exhaust, (Ring Type 'F'), Pipe To Converter	F10085	1
	1988		(Ring Type 'F')	F10085	1
	1982-1988		(Flange Type), Pipe To Converter	F14144	1
Fuel Pump Gasket	1982-1987			D27094	1
			<i>Tuff-Cork</i>	D27094TC	1
Injector Nozzle O-Ring	1987-1996			GS33276	3
Oil Filter Gasket	1982-1986		Adapter To Pump	B45826	1
Throttle Body Gasket	1994-1998	4		G31437	1
	1989-1995	R		G31109	1
	1988-1993	4		G30940	1
Water Outlet Gasket	1996-2001			C26961	1
	1989-1995	R	Supercharged	C26888	1
			Naturally Aspirated	C26961	1
	1982-1988			C26961	1
Water Pump Gasket	1996-2001			K31566	1
Water Pump Mount Gasket	1988-1995			K31010	1
	1982-1987			K27665	1

44 239 CID (3.9L) L-Head V8 Cyl, 3.188in./80.98mm (1939-1953) **44**

Part	Year	VIN	Model/Application	Part Number	Qty.
ENGINE GASKETS					
Head Set	1949-1953			HS1084K	1
Full Set	1949-1953			FS1084K	1
	1946-1948			FS1026K	1
	1939-1942			FS1026K	1
Cylinder Head Gasket	1949-1953		Right	VR2000 1084K	1
			Left	VR2000 1085K	1
	1939-1948		Standard Bore	VR2000 1026K	2
			Rebored To 3.438" Maximum	Copper 3036	2
Valve Cover Set	1949-1953			Cork Rubber VS18755	1
	1939-1948			Cork Rubber VS18765	1
Manifold Set, Exhaust	1939-1953			MS5278AK	1
Oil Pan Set	1949-1953			Cork Rubber OS21111	1
	1939-1948			Cork Rubber OS31242	1
Rear Main Seal Set	1939-1953			JV674	1
Timing Cover Set	1939-1953			JV762	1
Timing Cover Seal	1952-1953			46293	1

MISCELLANEOUS GASKETS					
Carb. Mount Gasket	1939-1953		2 Barrel Carburetor	G7128	1
Exhaust Pipe Gasket	1949-1953		(Flange Type), Pipe To Manifold	F5451K	1
	1939-1948		(Flange Type), Pipe To Manifold	F17802	2
Fuel Pump Bowl Gasket	1939-1948			D35288	1
Fuel Pump Gasket	1949-1953			D27094	1
Water Outlet Gasket	1949-1953			C24109	1
Water Pump Mount Gasket	1949-1953			K26373	1

Ford

45 239 CID (3.9L) OHV V8 Cyl, 3.500in./88.9mm (1954) 45

Part	Year	VIN	Model/Application	Part Number	Qty.
ENGINE GASKETS					
Valve Cover Set	1954		Cork Rubber	VS38261	1
Manifold Set, Exhaust	1954			MS15083Y	1
Oil Pan Set	1954		Cork Rubber	OS31414	1
Rear Main Seal Set	1954		Rope Packing	JV707	1
			Molded Rubber	JV748	1
Timing Cover Set	1954			JV799	1
Timing Cover Seal	1954			46293	1

MISCELLANEOUS GASKETS					
Carb. Mount Gasket	1954		2 Barrel Carburetor	G7128	1
Exhaust Pipe Gasket	1954		(Flange Type), Pipe To Manifold	F5451K	1
Fuel Pump Gasket	1954			D27094	1
Oil Pump Mounting Gasket	1954			B25973	1
Push Rod Cover Grommet	1954			B45317	2
Push Rod Cover Set	1954			PS38524	1
Valve Cover Grommet	1954			B45317	4
Water Outlet Gasket	1954			C25907	1

46 241 CID/3950CC (3.9L) DOHC 32 VALVE V8 Cyl, 3.386in./86mm (2000) 46

Part	Year	VIN	Model/Application	Part Number	Qty.
MISCELLANEOUS GASKETS					
Throttle Body Gasket	2000		Throttle Body To Adapter	G31569	1

47 240 CID (4.0L) OHV 6 Cyl, 4.000in./101.6mm (1965-1972) 47

Part	Year	VIN	Model/Application	Part Number	Qty.
ENGINE GASKETS					
Head Set	1968-1972		(Exhaust Pipe Gasket Not Included)	HS3824E	1
	1965-1967		(Valve Cover Gasket Not Included, Exhaust Pipe Gasket Not Included), Use With Part Number VS38035	HS3824E	1
Lower Set	1965-1972		(Requires Head Set To Make Full Set)	CS3824A	1
Full Set	1968-1972		(Exhaust Pipe Gasket Not Included)	FS3824E	1
	1965-1967		(Valve Cover Gasket Not Included, Exhaust Pipe Gasket Not Included), Use With Part Number VS38035	FS3824E	1
Engine Kit Gasket Set	1968-1972			95-3013VR	1
	1965-1967		(Valve Cover Gasket Not Included), Use With Part Number VS38035	95-3013VR	1
Cylinder Head Gasket	1965-1972		VR2000	3824	1
			Nitroseal	5821SG	1
Valve Cover Set	1968-1972		Cork Rubber	VS39747	1
	1965-1967		Cork Rubber	VS38035	1
Valve Stem Seal, Exh.	1965-1972		Except Police Car, Except Taxi	B45373	6
	1965-1970		Police Car, Taxi	B45229	6
Valve Stem Seal, Int.	1965-1972			B45373	6
Manifold Set, Int. & Exh.	1965-1972			MS16040X	1
Oil Pan Set	1965-1972		Cork Rubber	OS30930	1
Rear Main Seal Set	1965-1972			JV611	1
			Teflon	JV1636	1
Crank Repair Sleeve	1965-1972		Use With Part Number A506, Rear Nickel Plated Formed Steel, .013" Thickness	A332	1
Timing Cover Set	1965-1972			JV867	1
			(Contains Repair Sleeve)	JV931	1
Timing Cover Gasket	1965-1972			T27118	1
Timing Cover Seal	1965-1972			46293	1
Harmonic Balancer Repair Sleeve	1965-1972		Ground Steel, .020" Thickness	66595RS	1

47 240 CID (4.0L) OHV 6 Cyl, 4.000in./101.6mm (1965-1972) **47**
 (cont.) (cont.)

Part Year VIN Model/Application Part Number Qty.

ENGINE GASKETS (cont.)

Harmonic Balancer Repair Sleeve (cont.)	1965-1972		Use With Part Number A502, Front <i>Nickel Plated Formed Steel, .013" Thickness</i>	A226-1	1
---	-----------	--	--	--------	---

MISCELLANEOUS GASKETS

Air Cleaner Mount Gasket	1968-1972		1 Barrel Carburetor	G25936	1
Carb. Mount Gasket	1968-1972		Manual Transmission, 1 Barrel Carburetor	G26223	1
	1968-1969		Automatic Transmission, 1 Barrel Carburetor	G26639	1
	1965-1968		1 Barrel Carburetor	G26639	1
Exhaust Pipe Gasket	1965-1972		(Ring Type 'C'), Pipe To Manifold	F17250	1
			(Ring Type 'B'), Pipe To Manifold <i>Sintered Metal</i>	F17250S	1
Fuel Pump Gasket	1965-1972			D27094	1
				<i>Tuff-Cork</i> D27094TC	1
Push Rod Cover Grommet	1965-1972			B45317	2
Push Rod Cover Set	1965-1972			PS39570	1
Water Outlet Gasket	1965-1972			C24005	1
Water Pump Mount Gasket	1965-1972			K27113	1

48 250 CID (4.1L) 6 Cyl, 3.680in./93.5mm (1969-1980) **48**

Part Year VIN Model/Application Part Number Qty.

ENGINE GASKETS

Head Set	1969-1980		(Exhaust Pipe Gasket Not Included)	HS3910VJ	1
Full Set	1969-1980		(Exhaust Pipe Gasket Not Included)	FS3870E	1
Engine Kit Gasket Set	1969-1980			95-3023VR	1
Cylinder Head Gasket	1969-1980		<i>VR2000</i>	3910VC	1
Valve Cover Set	1969-1980		<i>Cork Rubber</i>	VS39564	1
Valve Stem Seal, Exh.	1969-1980			B45320	6
Valve Stem Seal, Int.	1969-1980			B45320	6
Manifold Set, Exhaust	1969-1980			MS16035W	1
Oil Pan Set	1969-1980		<i>Cork Rubber</i>	OS30991	1
Rear Main Seal Set	1969-1980		<i>Rope Packing</i>	JV730	1
			<i>Molded Rubber</i>	JV730R	1
Timing Cover Set	1969-1980			JV868	1
Timing Cover Seal	1969-1980			46293	1
Harmonic Balancer Repair Sleeve	1969-1980		Use With Part Number A502 <i>Nickel Plated Formed Steel, .013" Thickness</i>	A226-1	1

MISCELLANEOUS GASKETS

Air Cleaner Mount Gasket	1970-1980		1 Barrel Carburetor	G26540	1
Carb. Mount Gasket	1980		1 Barrel Carburetor, Carburetor To Spacer	G26190	1
			1 Barrel Carburetor, Spacer To Manifold	G27364	1
	1977-1979		1 Barrel Carburetor, Spacer To Manifold	G26732	1
	1975-1979		1 Barrel Carburetor, Carburetor To Spacer	G26163	1
	1969-1976		1 Barrel Carburetor, Spacer To Manifold	G25498	1
	1973-1974		1 Barrel Carburetor, Carburetor To Heat Shield	G24114	1
	1970-1974		Except Automatic Transmission, Except Thermactor Emission, 1 Barrel Carburetor, Carburetor To Spacer	G26177	1
	1969		Except Holley Carburetor, Improved Combustion Emission Control System, 1 Barrel Carburetor, Carburetor To Spacer	G26223	1
		Holley Carburetor, 1 Barrel Carburetor, Carburetor To Spacer	G26639	1	
E.G.R. Gasket	1977-1980			G26702	1
	1973-1976			G26701	1
Exhaust Pipe Gasket	1975-1980		Granada, Monarch, (Flange Type), Pipe To Converter	F14145	1
			Granada, Monarch, (Ring Type 'C'), Pipe To Manifold	F17250	1

PASSENGER CAR

Ford

48 (cont.)	250 CID (4.1L) 6 Cyl, 3.680in./93.5mm (1969-1980)				48 (cont.)
----------------------	--	--	--	--	----------------------

Part	Year	VIN	Model/Application	Part Number	Qty.
------	------	-----	-------------------	-------------	------

MISCELLANEOUS GASKETS (cont.)

Exhaust Pipe Gasket (cont.)	1975-1980		Granada, Monarch, (Ring Type 'B'), Pipe To Manifold <i>Sintered Metal</i>	F17250S	1
	1977		Maverick, (Flange Type), Pipe To Converter	F14145	1
	1975-1977		Comet, (Flange Type), Pipe To Converter	F14145	1
	1971-1977		Maverick, (Ring Type 'B'), Pipe To Manifold	F7387	1
			Comet, (Ring Type 'C'), Pipe To Manifold	F17250	1
			Comet, (Ring Type 'B'), Pipe To Manifold <i>Sintered Metal</i>	F17250S	1
	1972-1973		Gran Torino, (Ring Type 'C'), Pipe To Manifold	F17250	1
			Gran Torino, (Ring Type 'B'), Pipe To Manifold <i>Sintered Metal</i>	F17250S	1
	1970-1973		Montego MX Brougham, (Ring Type 'C'), Pipe To Manifold	F17250	1
			Montego MX Brougham, (Ring Type 'B'), Pipe To Manifold <i>Sintered Metal</i>	F17250S	1
	1969-1973		Montego, Montego MX, Mustang, Torino, (Ring Type 'C'), Pipe To Manifold	F17250	1
			Montego, Montego MX, Mustang, Torino, (Ring Type 'B'), Pipe To Manifold <i>Sintered Metal</i>	F17250S	1
	1970		Falcon, (Ring Type 'C'), Pipe To Manifold	F17250	1
			Falcon, (Ring Type 'B'), Pipe To Manifold <i>Sintered Metal</i>	F17250S	1
	1969-1970		Fairlane 500, (Ring Type 'C'), Pipe To Manifold	F17250	1
			Fairlane 500, (Ring Type 'B'), Pipe To Manifold <i>Sintered Metal</i>	F17250S	1
1969		Comet, (Ring Type 'C'), Pipe To Manifold	F17250	1	
		Comet, (Ring Type 'B'), Pipe To Manifold <i>Sintered Metal</i>	F17250S	1	
Fuel Pump Gasket	1969-1980			D27094	1
			<i>Tuff-Cork</i>	D27094TC	1
Water Outlet Gasket	1969-1980			C24005	1
Water Pump Mount Gasket	1969-1980			K27121	1

49	255 CID (4.2L) L-Head V8 Cyl, 3.188in./80.98mm (1949-1953)				49
-----------	---	--	--	--	-----------

Part	Year	VIN	Model/Application	Part Number	Qty.
------	------	-----	-------------------	-------------	------

ENGINE GASKETS

Valve Cover Set	1949-1953		(Contains Intake Manifold Gaskets) <i>Cork Rubber</i>	VS18755	1
Oil Pan Set	1949-1953		<i>Cork Rubber</i>	OS21111	1
Rear Main Seal Set	1949-1953			JV674	1
Timing Cover Set	1949-1953			JV762	1

MISCELLANEOUS GASKETS

Exhaust Pipe Gasket	1949-1953			F5451K	1
Fuel Pump Bowl Gasket	1949-1953			D35288	1
Fuel Pump Gasket	1949-1953			D27094	1
Water Outlet Gasket	1949-1953			C24109	1
Water Pump Mount Gasket	1949-1953			K26373	2

50	255 CID (4.2L) V8 Cyl, 3.680in./93.5mm (1980-1982)				50
-----------	---	--	--	--	-----------

Part	Year	VIN	Model/Application	Part Number	Qty.
------	------	-----	-------------------	-------------	------

ENGINE GASKETS

Head Set	1980-1982		(Exhaust Pipe Gasket Not Included, Intake Manifold Gasket Not Included)	HS3562	1
Lower Set	1980-1982		(Requires Head Set To Make Full Set)	CS3530B	1
Full Set	1980-1982		(Exhaust Pipe Gasket Not Included, Intake Manifold Gasket Not Included)	FS3562	1
Engine Kit Gasket Set	1982			95-3057VR	1
	1981		From 4/14/81	95-3057VR	1

50 (cont.)	255 CID (4.2L) V8 Cyl, 3.680in./93.5mm (1980-1982)	50 (cont.)
----------------------	---	----------------------

Part	Year	VIN	Model/Application	Part Number	Qty.
------	------	-----	-------------------	-------------	------

ENGINE GASKETS (cont.)

Engine Kit Gasket Set (cont.)	1981		Thru 4/14/81, (Intake Manifold Gasket Not Included), Use With Part Number MS15959	95-3057VR	1
	1980		(Intake Manifold Gasket Not Included), Use With Part Number MS15959	95-3057VR	1
Cylinder Head Gasket	1980-1982		<i>VR2000</i>	3562	2
Valve Cover Set	1980-1982		<i>Cork Rubber</i>	VS38300	1
			<i>High Temperature Cork Rubber</i>	VS38300H	1
			<i>High Temperature Tuff-Cork</i>	VS38300HTC	1
			<i>Victo-Tech</i>	VS38300R	1
			<i>(Steel Reinforced) Victo-Tech</i>	VS50203	1
			<i>(Steel Reinforced, Single Valve Cover) Victo-Tech</i>	VS50203S	2
Valve Stem Seal, Exh.	1980-1982			B45399	8
Valve Stem Seal, Int.	1980-1982			B45399	8
Manifold Set, Exhaust	1980-1982			MS15129X	1
Manifold Set, Intake	1982			MS15333	1
	1981		From 4/14/81	MS15333	1
			Thru 4/14/81	MS15959	1
	1980			MS15959	1
Oil Pan Set	1980-1982		<i>Cork Rubber</i>	OS30531	1
			<i>Tuff-Cork</i>	OS30531TC	1
Rear Main Seal Set	1980-1982		<i>Rope Packing</i>	JV730	1
			<i>Molded Rubber</i>	JV730R	1
Timing Cover Set	1980-1982			JV856	1
			<i>(Contains Repair Sleeve)</i>	JV922	1
Timing Cover Gasket	1980-1982			T27802	1
Timing Cover Seal	1980-1982			46293	1
Harmonic Balancer Repair Sleeve	1980-1982		<i>Ground Steel, .020" Thickness</i>	66595RS	1
			<i>Use With Part Number A502 Nickel Plated Formed Steel, .013" Thickness</i>	A226-2	1

MISCELLANEOUS GASKETS

Air Cleaner Mount Gasket	1981-1982		5-3/4" Outside Diameter, 5-3/8" Inside Diameter, 2 Barrel Carburetor	G31432	1
	1980-1982		5-1/2" Outside Diameter, 5-1/32" Inside Diameter, 2 Barrel Carburetor	G27098	1
Carb. Mount Gasket	1980-1982		(Spacer), 2 Barrel Carburetor	G30651	1
Dist. Mounting Gasket	1980-1982			72125	1
E.G.R. Gasket	1980-1982			G26702	1
Exhaust Pipe Gasket	1981-1982		LTD, Marquis, (Flange Type), Pipe To Converter	F14144	1
	1980-1982		Capri, Cougar, Fairmont, Mustang, Thunderbird, Zephyr, (Flange Type), Pipe To Converter	F14144	1
	1981		Granada, (Flange Type), Pipe To Converter	F14144	1
	1980		Granada, Monarch, (Flange Type), Pipe To Converter	F14145	1
			(Ring Type 'C'), Pipe To Manifold	F17250	1
			(Ring Type 'B'), Pipe To Manifold <i>Sintered Metal</i>	F17250S	1
Fuel Pump Gasket	1980-1982			D27094	1
			<i>Tuff-Cork</i>	D27094TC	1
Oil Pump Inlet Tube	1980-1982			B26151	1
Water Outlet Gasket	1980-1982			C24005	1
Water Pump Backing Plate	1981-1982		Cougar	K27151	1
			LTD, Marquis, Police, Taxi Or Trailer Towing Package	K27328	1
			LTD, Marquis, Except Police, Taxi And Trailer Towing Package	K27989	1
	1980-1982		Fairmont, Zephyr	K27151	1
			Capri, Cougar, Mustang, Thunderbird	K27989	1
	1980-1981		Granada	K27151	1
	1980		Monarch	K27151	1

Ford

50 (cont.)	255 CID (4.2L) V8 Cyl, 3.680in./93.5mm (1980-1982)					50 (cont.)
----------------------	---	--	--	--	--	----------------------

Part	Year	VIN	Model/Application	Part Number	Qty.
------	------	-----	-------------------	-------------	------

MISCELLANEOUS GASKETS (cont.)

Water Pump Mount Gasket	1980-1982			K27955	1
-------------------------	-----------	--	--	--------	---

51	256 CID (4.2L) V8 Cyl, 3.625in./92.1mm (1954)					51
-----------	--	--	--	--	--	-----------

Part	Year	VIN	Model/Application	Part Number	Qty.
------	------	-----	-------------------	-------------	------

ENGINE GASKETS

Cylinder Head Gasket	1954		VR2000	1176TC	2
Valve Cover Set	1954		Cork Rubber	VS38261	1
Manifold Set, Exhaust	1954			MS15083Y	1
Oil Pan Set	1954		Cork Rubber	OS31414	1
Rear Main Seal Set	1954		Rope Packing	JV707	1
			Molded Rubber	JV748	1
Timing Cover Set	1954			JV799	1
Timing Cover Seal	1954			46293	1

MISCELLANEOUS GASKETS

Exhaust Pipe Gasket	1954		(Flange Type), Pipe To Manifold	F5451K	1
Fuel Pump Gasket	1954			D27094	1
Oil Pump Mounting Gasket	1954			B25973	1
Push Rod Cover Grommet	1954			B45317	2
Push Rod Cover Set	1954			PS38524	1
Valve Cover Grommet	1954			B45317	4
Water Outlet Gasket	1954			C25907	1

52	260 CID (4.3L) V8 Cyl, 3.800in./96.5mm (1962-1965)					52
-----------	---	--	--	--	--	-----------

Part	Year	VIN	Model/Application	Part Number	Qty.
------	------	-----	-------------------	-------------	------

ENGINE GASKETS

Head Set	1962-1965		(Exhaust Pipe Gasket Not Included)	HS3530VJ	1	
Lower Set	1962-1965		(Requires Head Set To Make Full Set)	CS3530B	1	
Full Set	1962-1965		(Exhaust Pipe Gasket Not Included)	FS3530VJ	1	
Engine Kit Gasket Set	1962-1965			95-3367VR	1	
Cylinder Head Gasket	1962-1965		VR2000	3428	2	
			Nitroseal	3428SG	2	
Valve Cover Set	1962-1965		Cork Rubber	VS38300	1	
			High Temperature Cork Rubber	VS38300H	1	
			High Temperature Tuff-Cork	VS38300HTC	1	
			Victo-Tech	VS38300R	1	
			(Steel Reinforced)	Victo-Tech	VS50203	1
			(Steel Reinforced, Single Valve Cover)	Victo-Tech	VS50203S	2
Valve Stem Seal, Exh.	1962-1965			B45399	8	
Valve Stem Seal, Int.	1962-1965			B45399	8	
Manifold Set, Exhaust	1962-1965			MS15129X	1	
Manifold Set, Intake	1962-1965			MS15172	1	
Oil Pan Set	1962-1965		Cork Rubber	OS30531	1	
Rear Main Seal Set	1962-1965		Rope Packing	JV730	1	
			Molded Rubber	JV730R	1	
Timing Cover Set	1962-1965			JV856	1	
			(Contains Repair Sleeve)	JV922	1	
Timing Cover Gasket	1962-1965			T27802	1	
Timing Cover Seal	1962-1965			46293	1	
Harmonic Balancer Repair Sleeve	1962-1965		Ground Steel, .020" Thickness	66595RS	1	
			Use With Part Number A502 Nickel Plated Formed Steel, .013" Thickness	A226-2	1	

52 260 CID (4.3L) V8 Cyl, 3.800in./96.5mm (1962-1965) **52**
(cont.) (cont.)

Part Year VIN Model/Application Part Number Qty.

MISCELLANEOUS GASKETS

Air Cleaner Mount Gasket	1962-1965		2 Barrel Carburetor	G27098	1
Carb. Mount Gasket	1962-1965		2 Barrel Carburetor	G26052	2
Exhaust Pipe Gasket	1963-1965		(Ring Type 'C'), Pipe To Manifold	F17250	2
			(Ring Type 'B'), Pipe To Manifold <i>Sintered Metal</i>	F17250S	2
	1962		Meteor, (Flange Type), Pipe To Manifold	F5451K	2
Fuel Pump Bowl Gasket	1962-1963			D35288	1
Fuel Pump Gasket	1962-1965			D27094	1
Oil Pan Drain Plug Gst.	1962-1965			2066A	1
Oil Pump Inlet Tube	1962-1965			B26151	1
Oil Pump Mounting Gasket	1962-1965			B26553	1
Water Outlet Gasket	1962-1965			C24005	1
Water Pump Mount Gasket	1962-1965			K27579	1

53 272 CID (4.5L) V8 Cyl, 3.625in./92.1mm (1955-1957) **53**

Part Year VIN Model/Application Part Number Qty.

ENGINE GASKETS

Head Set	1955-1957		(Exhaust Manifold Gasket Not Included)	HS1176VJ	1
Full Set	1955-1957		(Exhaust Manifold Gasket Not Included)	FS1176VJ	1
Engine Kit Gasket Set	1955-1957			95-3319VR	1
Cylinder Head Gasket	1955-1957		<i>VR2000</i>	1176TC	2
Valve Cover Set	1955-1957		<i>Cork Rubber</i>	VS38261	1
Valve Stem Seal, Exh.	1955-1957			B45283	8
Valve Stem Seal, Int.	1955-1957			B45283	8
Manifold Set, Exhaust	1955-1957			MS15083Y	1
Manifold Set, Intake	1955-1957			MS18690	1
Oil Pan Set	1955-1957		<i>Cork Rubber</i>	OS31414	1
Rear Main Seal Set	1955-1957		<i>Rope Packing</i>	JV707	1
			<i>Molded Rubber</i>	JV748	1
				JV799	1
Timing Cover Set	1955-1957			46293	1

MISCELLANEOUS GASKETS

Carb. Mount Gasket	1957		2 Barrel Carburetor	G7332	1
			4 Barrel Carburetor	G27104	1
	1955-1956		2 Barrel Carburetor	G7128	1
Exhaust Pipe Gasket	1955-1957		(Flange Type), Pipe To Manifold	F5451K	1
Fuel Pump Gasket	1955-1957			D27094	1
Oil Pump Mounting Gasket	1955-1957			B25973	1
Push Rod Cover Grommet	1955-1957			B45317	2
Push Rod Cover Set	1955-1957			PS38524	1
Valve Cover Grommet	1955-1957			B45317	4
Water Outlet Gasket	1955-1957			C25907	1
Water Pump Mount Gasket	1955-1957			K27542	2

54 281 CID (4.6L) SOHC V8 Cyl, 3.551in./90.2mm (1991-2003) **54**

Part Year VIN Model/Application Part Number Qty.

ENGINE GASKETS

Head Set	1997-1998		(Head Bolts Not Included, Throttle Body Gasket Not Included)	HS5931A	1
----------	-----------	--	--	---------	---

Ford

54 281 CID (4.6L) SOHC V8 Cyl, 3.551in./90.2mm (1991-2003)

54
(cont.)

Part	Year	VIN	Model/Application	Part Number	Qty.
ENGINE GASKETS (cont.)					
Head Set (cont.)	1996	W, X	(Head Bolts Not Included, Throttle Body Gasket Not Included)	HS5931A	1
	1995		Cougar, Thunderbird, (Head Bolts Not Included, Valve Stem Seals Not Included)	HS5931	1
			Crown Victoria, Grand Marquis, Town Car, (Head Bolts Not Included)	HS5931A	1
	1991-1994		(Head Bolts Not Included)	HS5931	1
Lower Set	1991-1999		(Requires Head Set To Make Full Set)	CS5931	1
Engine Kit Gasket Set	1997-1998		(Throttle Body Gasket Not Included)	95-3471VR	1
	1996	W, X	(Throttle Body Gasket Not Included)	95-3471VR	1
	1995		Cougar, Thunderbird, (Valve Stem Seals Not Included), Use With Part Number B45892 (12)	95-3470VR	1
			Crown Victoria, Grand Marquis, Town Car, (Throttle Body Gasket Not Included)	95-3471VR	1
	1991-1994			95-3470VR	1
Cylinder Head Gasket	2002-2003	W	Left	Nitroseal 5931	1
		W	Right	Nitroseal 5932	1
	1991-2001		Left	Nitroseal 5931	1
			Right	Nitroseal 5932	1
Cyl. Head Bolt Set	1991-2003			GS33269	2
Valve Cover Set	2002	W	(Contains Valve Cover Grommets)	Victo-Tech VS50177	1
		W	(Single Valve Cover, Contains Valve Cover Grommets), Left	Victo-Tech VS50177L	1
		W	(Single Valve Cover, Contains Valve Cover Grommets), Right	Victo-Tech VS50177R	1
			(Contains Valve Cover Grommets)	Victo-Tech VS50177	1
	2001		(Single Valve Cover, Contains Valve Cover Grommets), Left	Victo-Tech VS50177L	1
			(Single Valve Cover, Contains Valve Cover Grommets), Right	Victo-Tech VS50177R	1
			(Single Valve Cover, Contains Valve Cover Grommets), Right	Victo-Tech VS50177R	1
	1999-2000	W	(Contains Valve Cover Grommets)	Victo-Tech VS50177	1
		W	(Single Valve Cover, Contains Valve Cover Grommets), Left	Victo-Tech VS50177L	1
		W	(Single Valve Cover, Contains Valve Cover Grommets), Right	Victo-Tech VS50177R	1
		X		Victo-Tech VS50275	1
	1997-1998		(Contains Valve Cover Grommets)	Victo-Tech VS50177	1
			(Single Valve Cover, Contains Valve Cover Grommets), Left	Victo-Tech VS50177L	1
			(Single Valve Cover, Contains Valve Cover Grommets), Right	Victo-Tech VS50177R	1
	1996	W, X	(Contains Valve Cover Grommets)	Victo-Tech VS50177	1
		W, X	(Single Valve Cover, Contains Valve Cover Grommets), Left	Victo-Tech VS50177L	1
		W, X	(Single Valve Cover, Contains Valve Cover Grommets), Right	Victo-Tech VS50177R	1
		6		Victo-Tech VS50275	1
			(Contains Valve Cover Grommets)	Victo-Tech VS50177	1
	1991-1995		(Single Valve Cover, Contains Valve Cover Grommets), Left	Victo-Tech VS50177L	1
		(Single Valve Cover, Contains Valve Cover Grommets), Right	Victo-Tech VS50177R	1	
		(Single Valve Cover, Contains Valve Cover Grommets), Right	Victo-Tech VS50177R	1	
Valve Stem Seal, Exh.	1995-2003			B45892	8
	1995-1998		To Be Replaced By B45892	B45824	8
	1991-1994			B45802	8
Valve Stem Seal, Int.	1995-2003			B45892	8
	1995-1998		To Be Replaced By B45892	B45824	8
	1991-1994			B45802	8
Manifold Set, Exhaust	1991-2003			MS16112	1
Manifold Set, Intake	2002-2003	W		Victo-Tech MS16296	1

54 281 CID (4.6L) SOHC V8 Cyl, 3.551in./90.2mm (1991-2003) **54**
(cont.) (cont.)

Part	Year	VIN	Model/Application	Part Number	Qty.
ENGINE GASKETS (cont.)					
Manifold Set, Intake (cont.)	2001			<i>Victo-Tech</i> MS16296	1
	1999-2000	W	(Contains Plenum Chamber Gasket)	<i>Victo-Tech</i> MS16260	1
		X		<i>Victo-Tech</i> MS16296	1
	1996-1998		(Contains Plenum Chamber Gasket)	<i>Victo-Tech</i> MS16260	1
	1995		Cougar, Thunderbird, (Contains Plenum Chamber Gasket)	<i>Victo-Tech</i> MS16102	1
			Crown Victoria, Grand Marquis, Town Car, (Contains Plenum Chamber Gasket)	<i>Victo-Tech</i> MS16260	1
1991-1994		(Contains Plenum Chamber Gasket)	<i>Victo-Tech</i> MS16102	1	
Plenum Chamber Gasket	1991-1999			<i>Nitroseal</i> MS14158	1
Oil Pan Set	1991-2003			<i>Victo-Tech</i> OS32517	1
Rear Main Seal Set	1991-2003			JV1612	1
Timing Cover Set	2001-2003			JV1159	1
	1999-2000	W		JV1159	1
	1991-1998			JV1159	1
Timing Cover Seal	2001-2003			48322	1
	1999-2000	W		48322	1
		X		67616	1
1991-1998			48322	1	
Harmonic Balancer Repair Sleeve	1991-1999		Use With Part Number A502 <i>Nickel Plated Formed Steel, .013" Thickness</i>	A226-1	1

MISCELLANEOUS GASKETS

E.G.R. Gasket	1991-2002			G30625	1
Exhaust Pipe Gasket	1991-1997		(Flange Type), Pipe To Converter	F12439	1
Injector Nozzle O-Ring	1991-1997			GS33276	4
Oil Filter Adapt Gasket	1998-2003		Oil Cooler	<i>Victo-Tech</i> B31584	1
Therm. Housing Gasket	1991-2003		(O-Ring Type)	C31302	1
Throttle Body Gasket	2001-2003	W	Throttle Body To Adapter	G31569	1
			Adapter To Intake Manifold	<i>Victo-Tech</i> G31603	1
	1999-2000	W	Adapter To Intake Manifold	<i>Victo-Tech</i> G31602	1
		X	Adapter To Intake Manifold	<i>Victo-Tech</i> G31603	1
	1996-2000		Throttle Body To Adapter	G31569	1
	1996-1998		Adapter To Intake Manifold	<i>Victo-Tech</i> G31602	1
1991-1995			G31163	1	
Water Pump Mount Gasket	1991-2003			K31309	1

55 281 CID (4.6L) SOHC CNG V8 Cyl, 3.551in./90.2mm (1995-2003) **55**

Part	Year	VIN	Model/Application	Part Number	Qty.
ENGINE GASKETS					
Engine Kit Gasket Set	1995		(Throttle Body Gasket Not Included)	95-3471VR	1
Cylinder Head Gasket	1995-2003		Left	<i>Nitroseal</i> 5931	1
			Right	<i>Nitroseal</i> 5932	1
Cyl. Head Bolt Set	1995-2003			GS33269	2
Valve Cover Set	1995-2001			<i>Victo-Tech</i> VS50177	1
Valve Stem Seal, Exh.	1995-2003			B45892	8
	1995-1998		To Be Replaced By B45892	B45824	8
Valve Stem Seal, Int.	1995-2003			B45892	8
	1995-1998		To Be Replaced By B45892	B45824	8
Manifold Set, Exhaust	1995-2003			MS16112	1
Manifold Set, Intake	2001-2003			<i>Victo-Tech</i> MS16296	1
	1999-2000		Crown Victoria, (Contains Plenum Chamber Gasket)	<i>Victo-Tech</i> MS16260	1
				<i>Victo-Tech</i> MS16260	1
1995-2000			MS16260	1	

Ford

55 (cont.)	281 CID (4.6L) SOHC CNG V8 Cyl, 3.551in./90.2mm (1995-2003)				55 (cont.)
----------------------	--	--	--	--	----------------------

Part	Year	VIN	Model/Application	Part Number	Qty.
------	------	-----	-------------------	-------------	------

ENGINE GASKETS (cont.)

Manifold Set, Intake (cont.)	1995		Crown Victoria, (Contains Plenum Chamber Gasket) <i>Victo-Tech</i>	MS16260	1
Plenum Chamber Gasket	1995		<i>Nitroseal</i>	MS14158	1
Oil Pan Set	1995-2003		<i>Victo-Tech</i>	OS32517	1
Rear Main Seal Set	1995-2003			JV1612	1
Timing Cover Set	1995-1999			JV1159	1
Timing Cover Seal	1995-2003			48322	1

MISCELLANEOUS GASKETS

E.G.R. Gasket	2002			G30625	1
Oil Filter Adapt Gasket	1998-2003		Oil Cooler <i>Victo-Tech</i>	B31584	1
Therm. Housing Gasket	2002-2003		(O-Ring Type)	C31302	1
Throttle Body Gasket	2002-2003		Adapter To Intake Manifold <i>Victo-Tech</i>	G31603	1
Water Pump Mount Gasket	2002-2003			K31309	1

56	281 CID (4.6L) DOHC Ford V8 Cyl, 3.551in./90.2mm (1993-2002)				56
-----------	---	--	--	--	-----------

Part	Year	VIN	Model/Application	Part Number	Qty.
------	------	-----	-------------------	-------------	------

ENGINE GASKETS

Head Set	1993-1999		(Head Bolts Not Included, Valve Cover Gasket Not Included, Plenum Chamber Gasket Not Included, Intake Manifold Gasket Not Included)	HS5931B	1
Lower Set	1993-1999		(Requires Head Set To Make Full Set)	CS5931	1
Cylinder Head Gasket	1993-1999		Left <i>Nitroseal</i>	5931	1
			Right <i>Nitroseal</i>	5932	1
Cyl. Head Bolt Set	1993-1999			GS33269	2
Valve Cover Set	1999-2002		(Contains Valve Cover Grommets, Contains Spark Plug Tube Seals) <i>Victo-Tech</i>	VS50273	1
	1998		Continental, (Contains Valve Cover Grommets, Contains Spark Plug Tube Seals) <i>Victo-Tech</i>	VS50273	1
	1997-1998		Mustang, (Single Valve Cover, Contains Valve Cover Grommets), Right <i>Victo-Tech</i>	VS50184R	1
			Mark VIII, (Contains Valve Cover Grommets, Contains Spark Plug Tube Seals) <i>Victo-Tech</i>	VS50273	1
	1996-1998		Mustang, (Contains Valve Cover Grommets) <i>Victo-Tech</i>	VS50184	1
			Mustang, (Single Valve Cover, Contains Valve Cover Grommets), Left <i>Victo-Tech</i>	VS50184L	1
	1993-1998		(Single Valve Cover, Contains Valve Cover Grommets), Right <i>Victo-Tech</i>	VS50184R	1
	1995-1997		Continental, (Contains Valve Cover Grommets) <i>Victo-Tech</i>	VS50184	1
			Continental, (Single Valve Cover, Contains Valve Cover Grommets), Left <i>Victo-Tech</i>	VS50184L	1
			Continental, (Single Valve Cover, Contains Valve Cover Grommets), Right <i>Victo-Tech</i>	VS50184R	1
1993-1996		(Contains Valve Cover Grommets) <i>Victo-Tech</i>	VS50184	1	
		(Single Valve Cover, Contains Valve Cover Grommets), Left <i>Victo-Tech</i>	VS50184L	1	
Valve Stem Seal, Exh.	1993-2001			B45887	16
Valve Stem Seal, Int.	1993-2001			B45887	16
Manifold Set, Exhaust	1993-2001		<i>Nitroseal</i>	MS16286	1
Manifold Gasket, Int.	1996-1998		Mustang, Cover <i>Victo-Tech</i>	MS16289	1
Manifold Set, Intake	1998-2001		Mustang, (Plenum Chamber Gasket Not Included) <i>Victo-Tech</i>	MS16287	1
	1998		Continental, (Plenum Chamber Gasket Not Included) <i>Victo-Tech</i>	MS16281	1
	1997-1998		Mark VIII, (Plenum Chamber Gasket Not Included) <i>Victo-Tech</i>	MS16287	1

56 281 CID (4.6L) DOHC Ford V8 Cyl, 3.551in./90.2mm (1993-2002) **56**
(cont.) (cont.)

Part	Year	VIN	Model/Application	Part Number	Qty.
ENGINE GASKETS (cont.)					
Manifold Set, Intake (cont.)	1996-1997		Mustang, (Plenum Chamber Gasket Not Included) <i>Victo-Tech</i>	MS16272	1
	1995-1997		Continental, (Plenum Chamber Gasket Not Included)	MS16276	1
	1993-1996		Mark VIII, (Plenum Chamber Gasket Not Included)	MS16276	1
Plenum Chamber Gasket	1998-2001		Continental, Upper	MS16274	1
	1996-2001		Mustang, (Intake Manifold Cover Gasket Not Included) <i>Victo-Tech</i>	MS16273	1
	1996-1998		Mark VIII, (Intake Manifold Cover Gasket Not Included) <i>Victo-Tech</i>	MS16273	1
	1995-1997		Continental	MS16275	1
	1993-1995		Mark VIII	MS16275	1
	Oil Pan Set	1993-2001			OS32517
Rear Main Seal Set	1993-1999			JV1612	1
Timing Cover Set	1993-1999			JV1164	1
Timing Cover Seal	1999	V		48322	1
	1996-1998			48322	1
Harmonic Balancer Repair Sleeve	1993-1999		Use With Part Number A502 <i>Nickel Plated Formed Steel, .013" Thickness</i>	A226-1	1

MISCELLANEOUS GASKETS

E.G.R. Gasket	1993-1999			G30625	1
Injector Nozzle O-Ring	1993-1997			GS33276	4
Spark Plug Tube Seal	1993-2001		<i>Victo-Tech</i>	B45889	1
Therm. Housing Gasket	1993-2001		(O-Ring Type)	C31302	1
Throttle Body Gasket	1993-2002			G31303	1
	1996-2001		Mustang	G31575	1
	1997-1998		Mark VIII	G31575	1
	1996		Mark VIII	G31303	1
Water Pump Mount Gasket	1993-1999			K31309	1

57 289 CID (4.7L) V8 Cyl, 4.000in./101.6mm (1963-1968) **57**

Part	Year	VIN	Model/Application	Part Number	Qty.
ENGINE GASKETS					
Head Set	1963-1968		(Exhaust Pipe Gasket Not Included)	HS3530VJ	1
Full Set	1963-1968		(Exhaust Pipe Gasket Not Included)	FS3530VJ	1
Engine Kit Gasket Set	1964-1968		Except K Engine	95-3367VR	1
		C	Except K Engine	95-3367VR	1
	1964-1967	A	Except K Engine	95-3367VR	1
Cylinder Head Gasket	1963-1968		<i>VR2000</i>	3428	2
			<i>Nitroseal</i>	3428SG	2
Valve Cover Set	1963-1968		<i>Cork Rubber</i>	VS38300	1
			<i>High Temperature Cork Rubber</i>	VS38300H	1
			<i>High Temperature Tuff-Cork</i>	VS38300HTC	1
			<i>Victo-Tech</i>	VS38300R	1
			(Steel Reinforced) <i>Victo-Tech</i>	VS50203	1
			(Steel Reinforced, Single Valve Cover) <i>Victo-Tech</i>	VS50203S	2
Valve Stem Seal, Exh.	1963-1968			B45399	8
Valve Stem Seal, Int.	1963-1968			B45399	8
Manifold Set, Exhaust	1963-1968			MS15129X	1
Manifold Set, Intake	1963-1968			MS15172	1
Oil Pan Set	1963-1968		<i>Cork Rubber</i>	OS30531	1
Rear Main Seal Set	1963-1968		<i>Rope Packing</i>	JV730	1
			<i>Molded Rubber</i>	JV730R	1
Timing Cover Set	1963-1968			JV856	1
			(Contains Repair Sleeve)	JV922	1

Ford

57 (cont.)	289 CID (4.7L) V8 Cyl, 4.000in./101.6mm (1963-1968)				57 (cont.)
----------------------	--	--	--	--	----------------------

Part	Year	VIN	Model/Application	Part Number	Qty.
------	------	-----	-------------------	-------------	------

ENGINE GASKETS (cont.)

Timing Cover Gasket	1963-1968			T27802	1
Timing Cover Seal	1963-1968			46293	1
Harmonic Balancer Repair Sleeve	1963-1968		<i>Ground Steel, .020" Thickness</i>	66595RS	1
			Use With Part Number A502 <i>Nickel Plated Formed Steel, .013" Thickness</i>	A226-2	1

MISCELLANEOUS GASKETS

Air Cleaner Mount Gasket	1963-1968		2 Barrel Carburetor	G27098	1
Carb. Mount Gasket	1964-1968		2 Barrel Carburetor	G26052	2
	1965-1967		4 Barrel Carburetor	G27190	2
	1963-1965		4 Barrel Carburetor	G27104	1
Dist. Mounting Gasket	1963-1968		(O-Ring Type)	72125	1
			(Tapered Washer)	B25212	1
Exhaust Pipe Gasket	1963-1968		(Ring Type 'C'), Pipe To Manifold	F17250	2
			(Ring Type 'B'), Pipe To Manifold	<i>Sintered Metal</i> F17250S	2
			Mustang, (Flange Type), Inlet, Resonator	F5421K	4
Fuel Pump Bowl Gasket	1963-1968			D35288	1
Fuel Pump Gasket	1963-1968			D27094	1
Heat Riser Gasket	1967		(Flange Type)	F5451K	1
Oil Pan Drain Plug Gst.	1963-1968			2066A	1
Oil Pump Inlet Tube	1963-1968			B26151	1
Oil Pump Mounting Gasket	1963-1968			B26553	1
Water Outlet Gasket	1963-1968			C24005	1
Water Pump Backing Plate	1963-1968			K27142	1
Water Pump Mount Gasket	1963-1968		Aluminum Pump	K27579	1
			Cast Iron Pump	K27955	1

58	292 CID (4.8L) V8 Cyl, 3.750in./95.3mm (1955-1962)				58
-----------	---	--	--	--	-----------

Part	Year	VIN	Model/Application	Part Number	Qty.
------	------	-----	-------------------	-------------	------

ENGINE GASKETS

Head Set	1955-1962		(Exhaust Manifold Gasket Not Included, Ring Type Exhaust Pipe Gasket Not Included)	HS1176VJ	1
Full Set	1955-1962		(Exhaust Manifold Gasket Not Included, Ring Type Exhaust Pipe Gasket Not Included)	FS1176VJ	1
Engine Kit Gasket Set	1955-1962			95-3319VR	1
Cylinder Head Gasket	1955-1962		<i>VR2000</i>	1176TC	2
Valve Cover Set	1960-1962		<i>Cork Rubber</i>	VS38307	1
	1955-1959		<i>Cork Rubber</i>	VS38261	1
Valve Stem Seal, Exh.	1955-1962			B45283	8
Valve Stem Seal, Int.	1955-1962			B45283	8
Manifold Set, Exhaust	1955-1962			MS15083Y	1
Manifold Set, Intake	1955-1962			MS18690	1
Oil Pan Set	1955-1962		<i>Cork Rubber</i>	OS31414	1
Rear Main Seal Set	1955-1962		<i>Rope Packing</i>	JV707	1
			<i>Molded Rubber</i>	JV748	1
				JV799	1
Timing Cover Seal	1955-1962			46293	1
Harmonic Balancer Repair Sleeve	1955-1962		Use With Part Number A502		
			<i>Nickel Plated Formed Steel, .013" Thickness</i>	A229-1	1

MISCELLANEOUS GASKETS

Carb. Mount Gasket	1957-1962		2 Barrel Carburetor	G7332	1
--------------------	-----------	--	---------------------	-------	---

58 292 CID (4.8L) V8 Cyl, 3.750in./95.3mm (1955-1962) **58**
(cont.) (cont.)

Part	Year	VIN	Model/Application	Part Number	Qty.
MISCELLANEOUS GASKETS (cont.)					
Carb. Mount Gasket (cont.)	1957-1959		4 Barrel Carburetor	G27104	1
Dist. Mounting Gasket	1955-1962			B25212	1
Exhaust Pipe Gasket	1962		Galaxie 500, (Ring Type 'C'), Pipe To Manifold	F17250	2
			Galaxie 500, (Ring Type 'B'), Pipe To Manifold <i>Sintered Metal</i>	F17250S	2
	1961-1962		Country Sedan, Fairlane, Fairlane 500, (Ring Type 'C'), Pipe To Manifold	F17250	2
			Country Sedan, Fairlane, Fairlane 500, (Ring Type 'B'), Pipe To Manifold <i>Sintered Metal</i>	F17250S	2
	1955-1962		(Flange Type), Pipe To Manifold	F5451K	3
Fuel Pump Bowl Gasket	1955-1962			D35288	1
Fuel Pump Gasket	1955-1962			D27094	1
Oil Pump Mounting Gasket	1955-1962			B25973	1
Push Rod Cover Grommet	1955-1962			B45317	2
Push Rod Cover Set	1955-1962			PS38524	1
Valve Cover Grommet	1955-1962			B45317	4
Water Outlet Gasket	1955-1962			C25907	1
Water Pump Mount Gasket	1955-1962			K27542	2

59 302 CID (5.0L) V8 Cyl, 4.000in./101.6mm (1968-1991) **59**

Part	Year	VIN	Model/Application	Part Number	Qty.
ENGINE GASKETS					
Head Set	1991			HS3530VY	1
	1986-1990			HS3530VR	1
	1977-1985		(Exhaust Pipe Gasket Not Included)	HS3530VK	1
	1968-1976		(Exhaust Pipe Gasket Not Included)	HS3530VJ	1
Lower Set	1988-1991		(Requires Head Set To Make Full Set, Contains 1 Piece Steel Backbone Molded Rubber Oil Pan Gasket)	CS3530	1
	1983-1987		(Requires Head Set To Make Full Set)	CS3530A	1
	1982		From 12/1/82, (Requires Head Set To Make Full Set)	CS3530A	1
			Thru 12/1/82, (Requires Head Set To Make Full Set)	CS3530B	1
1968-1981		(Requires Head Set To Make Full Set)	CS3530B	1	
Full Set	1991			FS3530VY	1
	1988-1990			FS3530VA	1
	1986-1987			FS3530VR	1
	1983-1985			FS3530VP	1
	1982		Thru 12/1/82	FS3530VK	1
			From 12/1/82	FS3530VP	1
	1977-1981			FS3530VK	1
	1968-1976		(Exhaust Pipe Gasket Not Included)	FS3530VJ	1
Engine Kit Gasket Set	1991			95-3447VR	1
	1986-1990			95-3374VR	1
	1983-1985			95-3365VR	1
	1982		From 12/1/82	95-3365VR	1
			Thru 12/1/82	95-3367VR	1
	1968-1981			95-3367VR	1
Cylinder Head Gasket	1968-1991		<i>VR2000</i>	3428	2
			<i>Nitroseal</i>	3428SG	2
Cyl. Head Bolt Set	1968-1991			GS33316	2
Valve Cover Set	1968-1991		<i>Cork Rubber</i>	VS38300	1
			<i>High Temperature Cork Rubber</i>	VS38300H	1
			<i>High Temperature Tuff-Cork</i>	VS38300HTC	1
			<i>Victo-Tech</i>	VS38300R	1

Ford

59 302 CID (5.0L) V8 Cyl, 4.000in./101.6mm (1968-1991) **59**
 (cont.) (cont.)

Part Year VIN Model/Application Part Number Qty.

ENGINE GASKETS (cont.)

Valve Cover Set (cont.)	1968-1991		(Steel Reinforced)	<i>Victo-Tech</i>	VS50203	1	
			(Steel Reinforced, Single Valve Cover)	<i>Victo-Tech</i>	VS50203S	2	
Valve Stem Seal, Exh.	1991				B45904	8	
	1968-1990				B45399	8	
Valve Stem Seal, Int.	1991				B45904	8	
	1985-1990			<i>Fluoroelastomer</i>	B45418	8	
	1968-1984				B45399	8	
Manifold Set, Exhaust	1981-1991				MS15129Y	1	
	1968-1980				MS15129X	1	
Manifold Set, Intake	1986-1991	F	(Contains Plenum Chamber Gasket)		MS15202Y	1	
	1977-1985				MS15202X	1	
	1968-1976				MS15172	1	
Plenum Chamber Gasket	1986-1991	F			MS15449	1	
Oil Pan Set	1986-1991		(Steel Reinforced, Original Equipment Type)	<i>Victo-Tech</i>	OS32491B	1	
	1968-1991		(Multi Piece)	<i>Cork Rubber</i>	OS30531	1	
			(Multi Piece)	<i>Tuff-Cork</i>	OS30531TC	1	
	1988-1990		(One Piece, 1 Piece Design)	<i>Victo-Tech</i>	OS32491	1	
Rear Main Seal Set	1983-1991				JV523	1	
				<i>Teflon</i>	JV1635	1	
	1982		From 12/1/82			JV523	1
			Thru 12/1/82	<i>Rope Packing</i>	JV730	1	
			Thru 12/1/82	<i>Molded Rubber</i>	JV730R	1	
			From 12/1/82	<i>Teflon</i>	JV1635	1	
	1968-1981			<i>Rope Packing</i>	JV730	1	
				<i>Molded Rubber</i>	JV730R	1	
Crank Repair Sleeve	1983-1991		Use With Part Number A505, Rear <i>Nickel Plated Formed Steel, .013" Thickness</i>	A331	1		
Timing Cover Set	1986-1991				JV1034	1	
	1968-1985				JV856	1	
			(Contains Repair Sleeve)		JV922	1	
Timing Cover Gasket	1986-1991				T27802	1	
Timing Cover Seal	1968-1991				46293	1	
Harmonic Balancer Repair Sleeve	1968-1985			<i>Ground Steel, .020" Thickness</i>	66595RS	1	
			Use With Part Number A502 <i>Nickel Plated Formed Steel, .013" Thickness</i>	A226-2	1		

MISCELLANEOUS GASKETS

Air Cleaner Mount Gasket	1977-1985		5-3/4" Outside Diameter, 5-3/8" Inside Diameter, 2 Barrel Carburetor		G31432	1
	1968-1985		5-1/2" Outside Diameter, 5-1/32" Inside Diameter, 2 Barrel Carburetor		G27098	1
Carb. Mount Gasket	1981-1985		Cougar, Aluminum Intake Manifold Spacer, Automatic Overdrive Transmission, California, 2 Barrel Carburetor		G30651	1
			Cougar, Aluminum Intake Manifold Spacer, California, 2 Barrel Carburetor		G30651	1
	1980-1985		Grand Marquis, Cast Iron Manifold, Except Canadian Models, 2 Barrel Carburetor, Spacer To Manifold		G26740	1
			Grand Marquis, Cast Iron Manifold, 2 Barrel Carburetor, Carburetor To Spacer		G26741	1
			Grand Marquis, Aluminum Intake Manifold Spacer, Automatic Overdrive Transmission, California, 2 Barrel Carburetor		G30651	1
	1979-1985		Cougar, Aluminum Intake Manifold Spacer, Automatic Overdrive Transmission, California, 2 Barrel Carburetor		G30651	1
	1977-1985		Cougar, Cast Iron Manifold, 2 Barrel Carburetor, Carburetor To Spacer		G26741	1
	1975-1985		Cougar, Cast Iron Manifold, Except Canadian Models, (2 Holes), 2 Barrel Carburetor, Spacer To Manifold		G26740	1

Part Year VIN Model/Application Part Number Qty.

MISCELLANEOUS GASKETS (cont.)

Carb. Mount Gasket (cont.)	1982		Capri, Continental, Cast Iron Manifold, 2 Barrel Carburetor, Carburetor To Spacer	G26048	1
			Capri, Continental, Cast Iron Manifold, Except Canadian Models, 2 Barrel Carburetor, Spacer To Manifold	G26740	1
			Capri, Continental, Town Car, Cast Iron Manifold, 2 Barrel Carburetor, Carburetor To Spacer	G26741	1
			Capri, Continental, Canadian, 2 Barrel Carburetor, Spacer To Manifold	G27312	1
			Capri, Aluminum Intake Manifold Spacer, Automatic Overdrive Transmission, California, 2 Barrel Carburetor	G30651	1
	1981-1982		Grand Marquis, Mark VI, Marquis, Town Car, Cast Iron Manifold, 2 Barrel Carburetor, Carburetor To Spacer	G26048	1
			Town Car, Cast Iron Manifold, Except Canadian Models, 2 Barrel Carburetor, Spacer To Manifold	G26740	1
			Cougar, Grand Marquis, LTD, Mark VI, Marquis, Town Car, Canadian, 2 Barrel Carburetor, Spacer To Manifold	G27312	1
			Town Car, Aluminum Intake Manifold Spacer, Automatic Overdrive Transmission, California, 2 Barrel Carburetor	G30651	1
	1980-1982		Mark VI, Cast Iron Manifold, Except Canadian Models, 2 Barrel Carburetor, Spacer To Manifold	G26740	1
			Mark VI, Aluminum Intake Manifold Spacer, Automatic Overdrive Transmission, California, 2 Barrel Carburetor	G30651	1
	1979-1982		Marquis, Cast Iron Manifold, Except Canadian Models, (2 Holes), 2 Barrel Carburetor, Spacer To Manifold	G26740	1
			LTD, Marquis, Aluminum Intake Manifold Spacer, Automatic Overdrive Transmission, California, 2 Barrel Carburetor	G30651	1
	1975-1982		LTD, Cast Iron Manifold, Except Canadian Models, (2 Holes), 2 Barrel Carburetor, Spacer To Manifold	G26740	1
	1973-1982		Cougar, LTD, Cast Iron Manifold, 2 Barrel Carburetor, Carburetor To Spacer	G26048	1
	1981		Thunderbird, Cast Iron Manifold, 2 Barrel Carburetor, Carburetor To Spacer	G26048	1
			Mustang, Thunderbird, Canadian, 2 Barrel Carburetor, Spacer To Manifold	G27312	1
	1979-1981		Mustang, Thunderbird, Aluminum Intake Manifold Spacer, Automatic Overdrive Transmission, California, 2 Barrel Carburetor	G30651	1
	1977-1981		Thunderbird, Cast Iron Manifold, Except Canadian Models, (2 Holes), 2 Barrel Carburetor, Spacer To Manifold	G26740	1
	1975-1981		Mustang, Cast Iron Manifold, Except Canadian Models, (2 Holes), 2 Barrel Carburetor, Spacer To Manifold	G26740	1
1973-1981		Mustang, Cast Iron Manifold, 2 Barrel Carburetor, Carburetor To Spacer	G26048	1	
1980		Mark VI, Cast Iron Manifold, 2 Barrel Carburetor, Spacer To Manifold	G24089	1	
		Continental, Versailles, Cast Iron Manifold, Except Canadian Models, 2 Barrel Carburetor, Spacer To Manifold	G26740	1	
		Mark VI, Mustang, Cast Iron Manifold, 2 Barrel Carburetor, Carburetor To Spacer	G26741	1	
1979-1980		Continental, Versailles, Cast Iron Manifold, (Open Center), 2 Barrel Carburetor, Spacer To Manifold	G24089	1	
		Marquis, Cast Iron Manifold, 2 Barrel Carburetor, Carburetor To Spacer	G26741	1	
		Continental, Granada, Monarch, Aluminum Intake Manifold Spacer, Automatic Overdrive Transmission, California, 2 Barrel Carburetor	G30651	1	
1977-1980		Continental, Granada, LTD, Monarch, Thunderbird, Versailles, Cast Iron Manifold, 2 Barrel Carburetor, Carburetor To Spacer	G26741	1	
1975-1980		Granada, Monarch, Cast Iron Manifold, Except Canadian Models, (2 Holes), 2 Barrel Carburetor, Spacer To Manifold	G26740	1	
1979		Capri, Cast Iron Manifold, Except Canadian Models, (2 Holes), 2 Barrel Carburetor, Spacer To Manifold	G26740	1	

Ford

59 302 CID (5.0L) V8 Cyl, 4.000in./101.6mm (1968-1991) **59**
 (cont.) (cont.)

Part	Year	VIN	Model/Application	Part Number	Qty.
MISCELLANEOUS GASKETS (cont.)					
Carb. Mount Gasket (cont.)	1979		Capri, Cast Iron Manifold, 2 Barrel Carburetor, Carburetor To Spacer	G26741	1
			Versailles, Aluminum Intake Manifold Spacer, 2 Barrel Carburetor	G30651	1
			Capri, Fairmont, LTD II, Zephyr, Aluminum Intake Manifold Spacer, Automatic Overdrive Transmission, California, 2 Barrel Carburetor	G30651	1
	1978-1979		Fairmont, Zephyr, Cast Iron Manifold, Except Canadian Models, (2 Holes), 2 Barrel Carburetor, Spacer To Manifold	G26740	1
			Fairmont, Zephyr, Cast Iron Manifold, 2 Barrel Carburetor, Carburetor To Spacer	G26741	1
	1977-1979		LTD II, Cast Iron Manifold, Except Canadian Models, (2 Holes), 2 Barrel Carburetor, Spacer To Manifold	G26740	1
			LTD II, Cast Iron Manifold, 2 Barrel Carburetor, Carburetor To Spacer	G26741	1
	1977-1978		Versailles, Cast Iron Manifold, Except Canadian Models, 2 Barrel Carburetor, Spacer To Manifold	G26740	1
			Mustang, Cast Iron Manifold, 2 Barrel Carburetor, Carburetor To Spacer	G26741	1
	1975-1978		Continental, Cast Iron Manifold, Except Canadian Models, 2 Barrel Carburetor, Spacer To Manifold	G26740	1
	1977		Comet, Maverick, Cast Iron Manifold, 2 Barrel Carburetor, Carburetor To Spacer	G26741	1
	1975-1977		Comet, Maverick, Cast Iron Manifold, Except Canadian Models, 2 Barrel Carburetor, Spacer To Manifold	G26740	1
	1975-1976		Granada, Monarch, Cast Iron Manifold, 2 Barrel Carburetor, Carburetor To Spacer	G26048	1
			Gran Torino, Cast Iron Manifold, Except Canadian Models, 2 Barrel Carburetor, Spacer To Manifold	G26740	1
	1973-1976		Comet, Continental, Gran Torino, Maverick, Cast Iron Manifold, 2 Barrel Carburetor, Carburetor To Spacer	G26048	1
	1975		Torino, Cast Iron Manifold, Except Canadian Models, 2 Barrel Carburetor, Spacer To Manifold	G26740	1
	1973-1975		Torino, Cast Iron Manifold, 2 Barrel Carburetor, Carburetor To Spacer	G26048	1
	1973-1974		Montego, Montego MX, Montego MX Brougham, Cast Iron Manifold, 2 Barrel Carburetor, Carburetor To Spacer	G26048	1
			2 Barrel Carburetor, Spacer To Manifold	G26742	1
	1968-1972		2 Barrel Carburetor	G26052	2
1968		4 Barrel Carburetor	G27190	2	
Dist. Mounting Gasket	1968-1985		(O-Ring Type)	72125	1
	1968-1972		(Tapered Washer)	B25212	1
E.G.R. Gasket	1977-1991			G26702	1
	1973-1976			G26701	1
Exhaust Pipe Gasket	1991		(Flange Type), Pipe To Converter	F12439	1
	1975-1990		2-5/16" Inside Diameter, (Flange Type), Pipe To Converter	F14144	1
			2-5/16" Inside Diameter		
	1983-1985		2" Pipe, (Ring Type 'F'), Pipe To Converter	F12298	1
	1975-1982		2-1/2" Inside Diameter, (Flange Type), Pipe To Converter	F14145	1
			2-1/2" Inside Diameter		
1968-1980		1.80" Pipe, (Ring Type 'B'), Pipe To Manifold	F7387	2	
		2" Pipe, (Ring Type 'C'), Pipe To Manifold	F17250	2	
		2" Pipe, (Ring Type 'B'), Pipe To Manifold <i>Sintered Metal</i>	F17250S	2	
Fuel Pump Gasket	1968-1985			D27094	1
			<i>Tuff-Cork</i>	D27094TC	1
Injector Nozzle O-Ring	1985-1991			GS33276	4
Oil Pan Drain Plug Gst.	1968-1991			2066A	1
Oil Pump Inlet Tube	1968-1991			B26151	1
Oil Pump Mounting Gasket	1968-1985			B26553	1

PASSENGER CAR

<i>Part</i>	<i>Year</i>	<i>VIN</i>	<i>Model/Application</i>	<i>Part Number</i>	<i>Qty.</i>
MISCELLANEOUS GASKETS (cont.)					
Throttle Body Gasket	1989-1991		Continental, 2.195" Throttle Body Bore, EGR Valve Spacer To Plenum	G31119	1
			Continental, 1.988" Throttle Body Bore	G31120	1
	1987-1991		Crown Victoria, Grand Marquis, LTD Country Squire, 1.988" Throttle Body Bore	G31120	1
	1986-1991		Crown Victoria, Grand Marquis, LTD Country Squire, 2.195" Throttle Body Bore, EGR Valve Spacer To Plenum	G31119	1
	1987-1990		Town Car, 1.988" Throttle Body Bore	G31120	1
	1986-1990		Town Car, 2.195" Throttle Body Bore, EGR Valve Spacer To Plenum	G31119	1
	1987-1988		Cougar, Thunderbird, 1.988" Throttle Body Bore	G31120	1
	1986-1988		Cougar, Thunderbird, 2.195" Throttle Body Bore, EGR Valve Spacer To Plenum	G31119	1
	1987		Continental, 1.988" Throttle Body Bore	G31120	1
	1986-1987		Continental, 2.195" Throttle Body Bore, EGR Valve Spacer To Plenum	G31119	1
	1986		Continental, Cougar, Crown Victoria, Grand Marquis, LTD Country Squire, Mark VII, Thunderbird, Town Car, 1.978" Throttle Body Bore, Throttle Body To Exhaust Gas Recirculator Valve Spacer	G31122	1
Water Outlet Gasket	1968-1991			C24005	1
Water Pump Backing Plate	1990-1991			K28004	1
	1986-1989			K30707	1
	1984-1985		Mark VII, Cast Iron Pump	K27151	1
	1983-1985		Thunderbird, Cast Iron Pump	K27151	1
			Crown Victoria, Police, Taxi Or Trailer Towing Package	K27328	1
			Crown Victoria, LTD Country Squire, Aluminum Pump	K27989	1
	1982-1985		Continental, Cast Iron Pump	K27151	1
	1981-1985		Cougar, Town Car, Cast Iron Pump	K27151	1
	1980-1985		Grand Marquis, Aluminum Pump	K27989	1
	1979-1985		Cougar, Aluminum Pump	K27989	1
	1980-1983		Mark VI, Cast Iron Pump	K27151	1
	1982		Capri, Aluminum Pump	K27989	1
	1979-1982		Marquis, Cast Iron Pump	K27151	1
			LTD, Aluminum Pump	K27989	1
	1979-1981		Mustang, Aluminum Pump	K27989	1
	1977-1981		Thunderbird, Cast Iron Pump	K27151	1
	1977-1980		Versailles, Cast Iron Pump	K27151	1
	1975-1980		Granada, Monarch, Cast Iron Pump	K27151	1
	1972-1980		Continental, Cast Iron Pump	K27151	1
	1979		Fairmont, Zephyr, Police, Taxi Or Trailer Towing Package	K27328	1
			Capri, LTD II, Aluminum Pump	K27989	1
	1978-1979		Fairmont, Zephyr, Cast Iron Pump	K27151	1
	1977-1979		Cougar, Cast Iron Pump	K27151	1
	1978		Thunderbird	K27151	1
	1977		Granada	K27151	1
	1975-1977		Monarch	K27151	1
	1971-1977		Comet	K27151	1
	1970-1977		Maverick	K27151	1
	1972-1976		Gran Torino	K27151	1
	1970-1975		Torino	K27151	1
	1971-1974		Montego, Montego MX, Montego MX Brougham	K27151	1
	1970-1973		Cougar	K27151	1
	1970-1972		Galaxie 500	K27151	1
1970-1971		Custom, Custom 500	K27151	1	
1970		Fairlane 500, Falcon	K27151	1	
1968-1969			K27142	1	

Ford

59 302 CID (5.0L) V8 Cyl, 4.000in./101.6mm (1968-1991) **59**
 (cont.) (cont.)

Part Year VIN Model/Application Part Number Qty.

MISCELLANEOUS GASKETS (cont.)

Water Pump Mount Gasket	1991		Continental, Crown Victoria, Grand Marquis, LTD Country Squire, Serpentine Belt	K27988	1
	1989-1991		Continental, Except Serpentine Belt	K27955	1
	1987-1991		LTD Country Squire, Except Serpentine Belt	K27955	1
	1983-1991		Crown Victoria, Grand Marquis, Except Serpentine Belt	K27955	1
	1983-1990		Town Car, Except Serpentine Belt	K27955	1
	1989		Town Car	K27955	1
	1983-1988		Thunderbird	K27955	1
	1968-1988		Cougar	K27955	1
	1983-1987		Continental, Except Serpentine Belt	K27955	1
	1982-1987		Continental	K27955	1
	1984-1986		Mark VII	K27955	1
	1983-1986		Crown Victoria, LTD Country Squire	K27955	1
	1980-1986		Grand Marquis	K27955	1
	1980-1983		Mark VI	K27955	1
	1982		Capri	K27955	1
	1981-1982		Town Car	K27955	1
	1979-1982		Marquis	K27955	1
	1969-1982		LTD	K27955	1
	1977-1981		Thunderbird	K27955	1
	1968-1981		Mustang	K27955	1
	1977-1980		Versailles	K27955	1
	1975-1980		Granada, Monarch	K27955	1
	1972-1980		Continental	K27955	1
	1979		Capri	K27955	1
	1978-1979		Fairmont, Zephyr	K27955	1
	1977-1979		LTD II	K27955	1
	1971-1977		Comet	K27955	1
	1969-1977		Maverick	K27955	1
	1972-1976		Gran Torino	K27955	1
	1969-1975		Torino	K27955	1
	1971-1974		Montego MX, Montego MX Brougham	K27955	1
	1968-1974		Montego	K27955	1
	1969-1972		Galaxie 500	K27955	1
1969-1971		Custom, Custom 500	K27955	1	
1969-1970		Fairlane 500, Falcon	K27955	1	
1968-1969		Comet, Cyclone, Fairlane, Montego MX	K27955	1	

60 302 CID (5.0L) Boss V8 Cyl, 4.000in./101.6mm (1969-1971) **60**

Part Year VIN Model/Application Part Number Qty.

ENGINE GASKETS

Head Set	1969-1971			HS3446	1
Full Set	1969-1971			FS3446	1
Cylinder Head Gasket	1969-1971		VR2000	3446	2
Cyl. Head Bolt Set	1969-1971			GS33316	2
Valve Cover Set	1969-1971		Cork Rubber	VS38422	1
			(Contains Gasket With Pre-inserted Grommets)	VS38422GR	1
			High Temperature Cork Rubber	VS38422H	1
			Victo-Tech	VS38422R	1
Manifold Set, Intake	1969-1971			MS15181	1
Oil Pan Set	1969-1971		Cork Rubber	OS30531	1
Rear Main Seal Set	1969-1971		Molded Rubber	JV730R	1
Timing Cover Set	1969-1971			JV856	1
			(Contains Repair Sleeve)	JV922	1
Timing Cover Seal	1969-1971			46293	1

60 302 CID (5.0L) Boss V8 Cyl, 4.000in./101.6mm (1969-1971) **60**
(cont.) (cont.)

Part Year VIN Model/Application Part Number Qty.

ENGINE GASKETS (cont.)

Harmonic Balancer Repair Sleeve	1969-1971		Ground Steel, .020" Thickness	66595RS	1
			Use With Part Number A502 Nickel Plated Formed Steel, .013" Thickness	A226-2	1

MISCELLANEOUS GASKETS

Carb. Mount Gasket	1969-1971		4 Barrel Carburetor	G14733	1
Fuel Pump Gasket	1969-1971			D27094	1
				Tuff-Cork D27094TC	1
Water Outlet Gasket	1969-1971			C24005	1
Water Pump Backing Plate	1969-1971		Cougar, Mustang	K27151	1
Water Pump Mount Gasket	1969-1971		Cougar, Mustang	K27955	1

61 302 CID (5.0L) High Output V8 Cyl, 4.000in./101.6mm (1982-1995) **61**

Part Year VIN Model/Application Part Number Qty.

ENGINE GASKETS

Head Set	1993-1995	T	Except Cobra	HS3530A	1
		D	Cobra Only	HS3530B	1
	1991-1992			HS3530VY	1
	1990			HS3530VR	1
	1983-1989			HS5740	1
	1982			HS3530VK	1
Lower Set	1988-1995		(Requires Head Set To Make Full Set, Contains 1 Piece Steel Backbone Molded Rubber Oil Pan Gasket)	CS3530	1
	1984-1987		(Requires Head Set To Make Full Set)	CS3530A	1
Full Set	1991-1992			FS3530VY	1
	1990			FS3530VA	1
	1983-1989			FS5740	1
	1982		Thru 12/1/82	FS3530VK	1
			From 12/1/82	FS5740	1
Engine Kit Gasket Set	1991-1995			95-3447VR	1
	1986-1990			95-3374VR	1
	1983-1985			95-3365VR	1
	1982		From 12/1/82	95-3365VR	1
			Thru 12/1/82	95-3367VR	1
Cylinder Head Gasket	1990-1995		VR2000	3428	2
	1982-1995		Nitroseal	3428SG	2
	1983-1989		VR2000	5740	2
	1982		VR2000	3428	2
Cyl. Head Bolt Set	1982-1992			GS33316	2
Valve Cover Set	1982-1995		Cork Rubber	VS38300	1
			High Temperature Cork Rubber	VS38300H	1
			High Temperature Tuff-Cork	VS38300HTC	1
			Victo-Tech	VS38300R	1
			Aluminum Cover, (Steel Reinforced, Original Equipment Type) Victo-Tech	VS50203	1
			Aluminum Cover, (Steel Reinforced, Single Valve Cover, Original Equipment Type) Victo-Tech	VS50203S	2
Valve Stem Seal, Exh.	1991-1995		(Original Equipment Type)	B45904	8
	1982-1990			B45399	8
Valve Stem Seal, Int.	1991-1995		(Original Equipment Type)	B45904	8
	1985-1990		Fluoroelastomer	B45418	8
	1982-1984			B45399	8
Manifold Set, Exhaust	1982-1995			MS15129Y	1
Manifold Set, Intake	1993-1995	T	Except Cobra, (Contains Plenum Chamber Gasket)	MS15202Y	1
		D	Cobra Only, (Contains Plenum Chamber Gasket)	MS16127	1

Ford

61 302 CID (5.0L) High Output V8 Cyl, 4.000in./101.6mm (1982-1995) **61**
 (cont.) (cont.)

Part Year VIN Model/Application Part Number Qty.

ENGINE GASKETS (cont.)

Manifold Set, Intake (cont.)	1986-1992		(Contains Plenum Chamber Gasket)	MS15202Y	1
	1982-1985			MS15202X	1
Plenum Chamber Gasket	1993-1995	T	Except Cobra	MS15449	1
		D	Cobra Only	MS16100	1
	1991-1992	T		MS15449	1
	1986-1992			MS15449	1
Oil Pan Set	1990-1995		(1 Piece Design) <i>Victo-Tech</i>	OS32491	1
	1986-1995		(Steel Reinforced, Original Equipment Type) <i>Victo-Tech</i>	OS32491B	1
	1982-1995		(Multi Piece) <i>Cork Rubber</i>	OS30531	1
			(Multi Piece) <i>Tuff-Cork</i>	OS30531TC	1
Rear Main Seal Set	1983-1995			JV523	1
				<i>Teflon</i> JV1635	1
	1982		From 12/1/82	JV523	1
			Thru 12/1/82	<i>Rope Packing</i> JV730	1
			Thru 12/1/82	<i>Molded Rubber</i> JV730R	1
Crank Repair Sleeve	1983-1995		Use With Part Number A505, Rear <i>Nickel Plated Formed Steel, .013" Thickness</i>	A331	1
Timing Cover Set	1993-1995			JV1177	1
	1986-1992			JV1034	1
	1982-1985			JV856	1
			(Contains Repair Sleeve)	JV922	1
Timing Cover Gasket	1982-1994			T27802	1
Timing Cover Seal	1982-1995			46293	1
Harmonic Balancer Repair Sleeve	1982-1985		<i>Ground Steel, .020" Thickness</i>	66595RS	1
			Use With Part Number A502 <i>Nickel Plated Formed Steel, .013" Thickness</i>	A226-2	1

MISCELLANEOUS GASKETS

Air Cleaner Mount Gasket	1983-1985		5-1/2" Outside Diameter, 5-1/32" Inside Diameter	G27098	1
			5-3/4" Outside Diameter, 5-3/8" Inside Diameter	G31432	1
	1983		5-1/2" Outside Diameter, 5-1/32" Inside Diameter, 4 Barrel Carburetor	G27098	1
			5-3/4" Outside Diameter, 5-3/8" Inside Diameter, 4 Barrel Carburetor	G31432	1
	1982		5-1/2" Outside Diameter, 5-1/32" Inside Diameter	G27098	1
			5-1/2" Outside Diameter, 5-1/32" Inside Diameter, 2 Barrel Carburetor	G27098	1
			5-3/4" Outside Diameter, 5-3/8" Inside Diameter	G31432	1
			5-3/4" Outside Diameter, 5-3/8" Inside Diameter, 2 Barrel Carburetor	G31432	1
			G31432	1	
Carb. Mount Gasket	1985		Carburetor To Heat Shield	G27186	1
			4 Barrel Carburetor, Carburetor To Manifold	G30618	1
	1984-1985		Electronic Fuel Injection, Carburetor To Heat Shield	G27186	1
			Electronic Fuel Injection, Carburetor To Manifold	G30618	1
	1982-1985		Capri, Aluminum Intake Manifold Spacer, Automatic Overdrive Transmission, California, Electronic Fuel Injection	G30651	1
	1983		4 Barrel Carburetor, Spacer To Manifold	G25175	1
	1982-1983		Capri, Cast Iron Manifold, 4 Barrel Carburetor, Carburetor To Spacer	G26741	1
	1982		Capri, Mustang, Cast Iron Manifold, 2 Barrel Carburetor, Carburetor To Spacer	G26048	1
		Capri, Mustang, Cast Iron Manifold, Except Canadian Models, 2 Barrel Carburetor, Spacer To Manifold	G26740	1	
		Mustang, Cast Iron Manifold, Except Canadian Models, Except Manual Transmission, 2 Barrel Carburetor, Spacer To Manifold	G26740	1	

Part	Year	VIN	Model/Application	Part Number	Qty.
MISCELLANEOUS GASKETS (cont.)					
Carb. Mount Gasket (cont.)	1982		Cast Iron Manifold, Carburetor To Spacer	G26741	1
			Mustang, Cast Iron Manifold, 2 Barrel Carburetor, Carburetor To Spacer	G26741	1
			Canadian, Spacer To Manifold	G27312	1
			Capri, Mustang, Canadian, 2 Barrel Carburetor, Spacer To Manifold	G27312	1
			Mustang, Aluminum Intake Manifold Spacer, Automatic Overdrive Transmission, California, 2 Barrel Carburetor	G30651	1
			Aluminum Intake Manifold Spacer, California	G30651	1
Dist. Mounting Gasket	1982-1985		(O-Ring Type)	72125	1
E.G.R. Gasket	1982-1995			G26702	1
Exhaust Pipe Gasket	1991-1994		(Flange Type), Pipe To Converter	F12439	1
	1982-1990		2-5/16" Inside Diameter, (Flange Type), Pipe To Converter <i>2-5/16" Inside Diameter</i>	F14144	1
	1985		2" Pipe, (Ring Type 'F'), Pipe To Converter	F12298	1
	1982-1983		2-1/2" Inside Diameter, (Flange Type), Pipe To Converter <i>2-1/2" Inside Diameter</i>	F14145	1
Fuel Pump Gasket	1982-1985			D27094	1
			<i>Tuff-Cork</i>	D27094TC	1
Injector Nozzle O-Ring	1985-1995			GS33276	4
Oil Pan Drain Plug Gst.	1982-1995			2066A	1
Oil Pump Inlet Tube	1982-1995			B26151	1
Oil Pump Mounting Gasket	1982-1985			B26553	1
Throttle Body Gasket	1993-1995		Mustang, 2.438" Throttle Body Bore, Except Cobra	G31121	1
			Mustang, Cobra Only	G31323	1
	1990-1992		Mark VII, 2.520" Throttle Body Bore, EGR Valve Spacer To Plenum	G31118	1
	1987-1992		Mustang, 2.520" Throttle Body Bore, EGR Valve Spacer To Plenum	G31118	1
			Mark VII, 1.988" Throttle Body Bore	G31120	1
			Mark VII, Mustang, 2.438" Throttle Body Bore	G31121	1
	1986		Capri, 2.195" Throttle Body Bore, EGR Valve Spacer To Plenum	G31119	1
		2.437" Throttle Body Bore, Throttle Body To Exhaust Gas Recirculator Valve Spacer	G31124	1	
Water Outlet Gasket	1982-1995			C24005	1
Water Pump Backing Plate	1992-1995			K30707	1
	1990-1991			K28004	1
	1986-1989			K30707	1
	1985		Mark VII, Cast Iron Pump	K27151	1
			Aluminum Pump	K27989	1
			Mustang, Aluminum Pump	K27989	1
	1984-1985		Town Car, Cast Iron Pump	K27151	1
			LTD, Police, Taxi Or Trailer Towing Package	K27328	1
	1982-1985		Capri, Aluminum Pump	K27989	1
	1982-1983		Mustang, Aluminum Pump	K27989	1
Water Pump Mount Gasket	1994-1995		Mustang	K27988	1
	1993		Cougar, Thunderbird	K27988	1
	1991-1992		Cougar, Thunderbird, Except Serpentine Belt	K27955	1
			Cougar, Mark VII, Mustang, Thunderbird, Serpentine Belt	K27988	1
	1987-1992		Mark VII, Mustang, Except Serpentine Belt	K27955	1
	1985-1986		Mark VII	K27955	1
	1984-1986		LTD, Mustang	K27955	1
	1982-1986		Capri	K27955	1
	1984-1985		Town Car	K27955	1

Ford

61 (cont.)	302 CID (5.0L) High Output V8 Cyl, 4.000in./101.6mm (1982-1995)	61 (cont.)
----------------------	--	----------------------

Part	Year	VIN	Model/Application	Part Number	Qty.
------	------	-----	-------------------	-------------	------

MISCELLANEOUS GASKETS (cont.)

Water Pump Mount Gasket (cont.)	1983		Mustang, Except Serpentine Belt	K27955	1
	1982		Mustang	K27955	1

62	312 CID (5.1L) V8 Cyl, 3.800in./96.5mm (1956-1960)	62
-----------	---	-----------

Part	Year	VIN	Model/Application	Part Number	Qty.
------	------	-----	-------------------	-------------	------

ENGINE GASKETS

Head Set	1956-1960		(Exhaust Manifold Gasket Not Included)	HS1176VJ	1
Full Set	1956-1960		(Exhaust Manifold Gasket Not Included)	FS1176VJ	1
Engine Kit Gasket Set	1956-1960			95-3319VR	1
Cylinder Head Gasket	1956-1960		VR2000	1176TC	2
Valve Cover Set	1960		Cork Rubber	VS38307	1
	1956-1959		Cork Rubber	VS38261	1
Valve Stem Seal, Exh.	1956-1960			B45283	8
Valve Stem Seal, Int.	1956-1960			B45283	8
Manifold Set, Exhaust	1956-1960			MS15083Y	1
Manifold Set, Intake	1956-1960			MS18690	1
Oil Pan Set	1956-1960		Cork Rubber	OS31414	1
Rear Main Seal Set	1956-1960			JV707	1
Timing Cover Set	1956-1960			JV799	1
Timing Cover Seal	1956-1960			46293	1
Harmonic Balancer Repair Sleeve	1956-1960		Use With Part Number A502 Nickel Plated Formed Steel, .013" Thickness	A229-1	1

MISCELLANEOUS GASKETS

Carb. Mount Gasket	1957-1958		4 Barrel Carburetor	G27104	2
Exhaust Pipe Gasket	1956-1960		(Flange Type), Pipe To Manifold	F5451K	1
Fuel Pump Bowl Gasket	1956-1960			D35288	1
Fuel Pump Gasket	1956-1960			D27094	1
Oil Pump Mounting Gasket	1956-1960			B25973	1
Push Rod Cover Grommet	1956-1960			B45317	2
Push Rod Cover Set	1956-1960			PS38524	1
Valve Cover Grommet	1956-1960			B45317	4
Water Outlet Gasket	1956-1960			C25907	1
Water Pump Mount Gasket	1956-1960			K27542	2

63	332 CID (5.4L) V8 Cyl, 4.000in./101.6mm (1958-1959)	63
-----------	--	-----------

Part	Year	VIN	Model/Application	Part Number	Qty.
------	------	-----	-------------------	-------------	------

ENGINE GASKETS

Head Set	1958-1959			HS3389VJ	1
Full Set	1958-1959			FS3389VJ	1
Engine Kit Gasket Set	1958-1959		(Exhaust Manifold Heat Shield Gasket Not Included), Use With Part Number MS15521X	95-3359VR	1
Cylinder Head Gasket	1958-1959		VR2000	3389	2
Valve Cover Set	1958-1959		Cork Rubber	VS38308	1
			Victo-Tech	VS38308R	1
Valve Stem Seal, Exh.	1958-1959			B45390	8
Valve Stem Seal, Int.	1958-1959			B45390	8
Manifold Set, Exhaust	1958-1959			MS15509	1
Manifold Set, Intake	1958-1959			MS15166X	1
Oil Pan Set	1958-1959		Cork Rubber	OS30764	1
Rear Main Seal Set	1958-1959		Rope Packing	JV707	1
			Molded Rubber	JV707P	1

63 332 CID (5.4L) V8 Cyl, 4.000in./101.6mm (1958-1959) **63**
(cont.) (cont.)

Part Year VIN Model/Application Part Number Qty.

ENGINE GASKETS (cont.)

Timing Cover Set	1958-1959			JV819	1
			(Contains Repair Sleeve)	JV921	1
Timing Cover Gasket	1958-1959			T27798	1
Timing Cover Seal	1958-1959			46293	1
Harmonic Balancer Repair Sleeve	1958-1959		<i>Ground Steel, .020" Thickness</i>	66595RS	1
			Use With Part Number A502 <i>Nickel Plated Formed Steel, .013" Thickness</i>	A226-2	1

MISCELLANEOUS GASKETS

Carb. Mount Gasket	1958-1959		2 Barrel Carburetor, Carburetor To Spacer	G7332	1
	1958		4 Barrel Carburetor	G27104	2
Dist. Mounting Gasket	1958-1959			B25212	1
Exhaust Pipe Gasket	1958-1959		(Flange Type), Pipe To Manifold	F5451K	3
Fuel Pump Gasket	1958-1959			D27094	1
Oil Pump Mounting Gasket	1958-1959			B25412	1
Water Outlet Gasket	1958-1959			C25487	1
Water Pump Backing Plate	1958-1959			K27079	1
Water Pump Mount Gasket	1958-1959			K26442	2

64 351 CID (5.8L) 351M V8 Cyl, 4.000in./101.6mm (1975-1979) **64**

Part Year VIN Model/Application Part Number Qty.

ENGINE GASKETS

Head Set	1975-1979		(Intake Manifold Gasket Not Included, Exhaust Manifold Gasket For 4 Barrel Carburetor Not Included)	HS3502	1
Full Set	1975-1979		(Intake Manifold Gasket Not Included, Exhaust Manifold Gasket For 4 Barrel Carburetor Not Included)	FS3502	1
Engine Kit Gasket Set	1975-1979		(Intake Manifold Gasket Not Included), Use With Part Number MS15938	95-3030VR	1
Cylinder Head Gasket	1975-1979		<i>VR2000</i>	3502	2
			<i>Nitroseal</i>	3502SG	2
Cyl. Head Bolt Set	1975-1979			GS33346	2
Valve Cover Set	1975-1979		<i>Cork Rubber</i>	VS38422	1
			(Contains Gasket With Pre-inserted Grommets) <i>Grommated Cork-Rubber</i>	VS38422GR	1
			<i>High Temperature Cork Rubber</i>	VS38422H	1
			<i>Victo-Tech</i>	VS38422R	1
			<i>Tuff-Cork</i>	VS38422TC	1
Valve Stem Seal, Exh.	1975-1979			B45399	8
Valve Stem Seal, Int.	1975-1979			B45399	8
Manifold Set, Exhaust	1975-1979			MS15197	1
Manifold Set, Intake	1975-1979			MS15938	1
Oil Pan Set	1975-1979		<i>Cork Rubber</i>	OS30543	1
			<i>Tuff-Cork</i>	OS30543TC	1
Rear Main Seal Set	1975-1979		<i>Molded Rubber</i>	JV614	1
			<i>Rope Packing</i>	JV730	1
Timing Cover Set	1975-1979			JV869	1
			(Contains Repair Sleeve)	JV933	1
Timing Cover Gasket	1975-1979			T27150	1
Timing Cover Seal	1975-1979			46293	1
Harmonic Balancer Repair Sleeve	1975-1979		<i>Ground Steel, .020" Thickness</i>	66595RS	1
			Use With Part Number A502 <i>Nickel Plated Formed Steel, .013" Thickness</i>	A226-2	1

Ford

64 (cont.)	351 CID (5.8L) 351M V8 Cyl, 4.000in./101.6mm (1975-1979)				64 (cont.)
----------------------	---	--	--	--	----------------------

Part	Year	VIN	Model/Application	Part Number	Qty.
------	------	-----	-------------------	-------------	------

MISCELLANEOUS GASKETS

Air Cleaner Mount Gasket	1975-1979		2 Barrel Carburetor	G27098	1
Carb. Mount Gasket	1977-1979		Canadian, 2 Barrel Carburetor, Spacer To Manifold	G26074	1
			2 Barrel Carburetor, Spacer To Manifold	G26746	1
	1975-1979		2 Barrel Carburetor, Carburetor To Spacer	G26741	1
	1975-1976		2 Barrel Carburetor, Spacer To Manifold	G26074	1
Choke Tube Gasket	1975-1979			B45788	1
Dist. Mounting Gasket	1975-1979			72125	1
E.G.R. Gasket	1977-1979			G26702	1
	1975-1976			G26701	1
Exhaust Pipe Gasket	1975-1978		2-5/16" Inside Diameter, (Flange Type), Pipe To Converter	F14144	1
			2-1/2" Inside Diameter, (Flange Type), Pipe To Converter	F14145	1
Fuel Pump Gasket	1975-1979			D24006	1
Oil Pan Drain Plug Gst.	1975-1979			2066A	1
Water Outlet Gasket	1975-1979			C26650	1
Water Pump Backing Plate	1975-1979			K27151	1
Water Pump Mount Gasket	1975-1979			K27158	1

65	351 CID (5.8L) 351C Ford Cleveland V8 Cyl, 4.000in./101.6mm (1970-1974)				65
-----------	--	--	--	--	-----------

Part	Year	VIN	Model/Application	Part Number	Qty.
------	------	-----	-------------------	-------------	------

ENGINE GASKETS

Head Set	1970-1974		(Intake Manifold Gasket Not Included, Exhaust Manifold Gasket For 4 Barrel Carburetor Not Included)	HS3502	1
Full Set	1970-1974		(Intake Manifold Gasket Not Included, Exhaust Manifold Gasket For 4 Barrel Carburetor Not Included)	FS3502	1
Engine Kit Gasket Set	1971-1974		2 Barrel Carburetor, (Intake Manifold Gasket Not Included), Use With Part Number MS15815	95-3030VR	1
	1970-1972		4 Barrel Carburetor, (Intake Manifold Gasket Not Included, Exhaust Manifold Gasket Not Included), Use With Part Numbers MS15816, MS15182	95-3030VR	1
Cylinder Head Gasket	1970-1974		<i>VR2000</i>	3502	2
			<i>Nitroseal</i>	3502SG	2
Cyl. Head Bolt Set	1970-1974			GS33346	2
Valve Cover Set	1970-1974		<i>Cork Rubber</i>	VS38422	1
			(Contains Gasket With Pre-inserted Grommets)	VS38422GR	1
			<i>High Temperature Cork Rubber</i>	VS38422H	1
			<i>Victo-Tech</i>	VS38422R	1
			<i>Tuff-Cork</i>	VS38422TC	1
Valve Stem Seal, Exh.	1970-1974			B45399	8
Valve Stem Seal, Int.	1970-1974			B45399	8
Manifold Set, Exhaust	1970-1974			MS15197	1
Manifold Set, Intake	1970-1974			MS15815	1
Oil Pan Set	1970-1974		<i>Cork Rubber</i>	OS30543	1
			<i>Tuff-Cork</i>	OS30543TC	1
Rear Main Seal Set	1970-1974		<i>Molded Rubber</i>	JV614	1
			<i>Rope Packing</i>	JV730	1
Timing Cover Set	1970-1974			JV869	1
			(Contains Repair Sleeve)	JV933	1
Timing Cover Gasket	1970-1974			T27150	1
Timing Cover Seal	1970-1974			46293	1
Harmonic Balancer Repair Sleeve	1970-1974		<i>Ground Steel, .020" Thickness</i>	66595RS	1
			Use With Part Number A502 <i>Nickel Plated Formed Steel, .013" Thickness</i>	A226-2	1

65 351 CID (5.8L) 351C Ford Cleveland V8 Cyl, 4.000in./101.6mm (1970-1974) **65**
(cont.) (cont.)

Part	Year	VIN	Model/Application	Part Number	Qty.
MISCELLANEOUS GASKETS					
Air Cleaner Mount Gasket	1970-1974		2 Barrel Carburetor	G27098	1
Carb. Mount Gasket	1973-1974		2 Barrel Carburetor, Carburetor To Spacer	G26048	1
			2 Barrel Carburetor, Spacer To Manifold	G26050	1
Dist. Mounting Gasket	1970-1974		2 Barrel Carburetor	G26744	1
			(O-Ring Type)	72125	1
E.G.R. Gasket	1970-1974		(Tapered Washer)	B25212	1
			Valve	G26701	1
Fuel Pump Gasket	1973-1974		To Valve Body	G24662	1
		1973		D24006	1
Oil Pan Drain Plug Gst.	1970-1974			2066A	1
Oil Pump Mounting Gasket	1970-1974			B25211	1
Water Outlet Gasket	1970-1974			C26650	1
Water Pump Mount Gasket	1970-1974			K27151	1

66 351 CID (5.8L) Boss Ford Cleveland V8 Cyl, 4.000in./101.6mm (1971) **66**

Part	Year	VIN	Model/Application	Part Number	Qty.
ENGINE GASKETS					
Head Set	1971		(Intake Manifold Gasket Not Included, Exhaust Manifold Gasket For 4 Barrel Carburetor Not Included)	HS3502	1
Full Set	1971		(Intake Manifold Gasket Not Included, Exhaust Manifold Gasket For 4 Barrel Carburetor Not Included)	FS3502	1
Cylinder Head Gasket	1971		VR2000	3502	2
			Nitroseal	3502SG	2
Cyl. Head Bolt Set	1971			GS33346	2
Valve Cover Set	1971		Cork Rubber	VS38422	1
			(Contains Gasket With Pre-inserted Grommets)	VS38422GR	1
			High Temperature Cork Rubber	VS38422H	1
			Victo-Tech	VS38422R	1
			Tuff-Cork	VS38422TC	1
Valve Stem Seal, Exh.	1971			B45399	8
Valve Stem Seal, Int.	1971			B45399	8
Manifold Set, Exhaust	1971			MS15182	1
Manifold Set, Intake	1971			MS15816	1
Oil Pan Set	1971		Cork Rubber	OS30543	1
			Tuff-Cork	OS30543TC	1
Rear Main Seal Set	1971		Molded Rubber	JV614	1
			Rope Packing	JV730	1
Timing Cover Set	1971			JV869	1
			(Contains Repair Sleeve)	JV933	1
Timing Cover Gasket	1971			T27150	1
Timing Cover Seal	1971			46293	1
Harmonic Balancer Repair Sleeve	1971		Ground Steel, .020" Thickness	66595RS	1

MISCELLANEOUS GASKETS					
Air Cleaner Mount Gasket	1971		4 Barrel Carburetor	G27098	1
Dist. Mounting Gasket	1971		(O-Ring Type)	72125	1
			(Tapered Washer)	B25212	1
Fuel Pump Gasket	1971			D24006	1
Oil Pan Drain Plug Gst.	1971			2066A	1
Oil Pump Mounting Gasket	1971			B25211	1

Ford

66 (cont.)	351 CID (5.8L) Boss Ford Cleveland V8 Cyl, 4.000in./101.6mm (1971)				66 (cont.)
----------------------	---	--	--	--	----------------------

Part	Year	VIN	Model/Application	Part Number	Qty.
------	------	-----	-------------------	-------------	------

MISCELLANEOUS GASKETS (cont.)

Water Outlet Gasket	1971			C26650	1
Water Pump Mount Gasket	1971			K27151	1

67	351 CID (5.8L) Cobra Jet Ford Cleveland V8 Cyl, 4.000in./101.6mm (1973-1974)				67
-----------	---	--	--	--	-----------

Part	Year	VIN	Model/Application	Part Number	Qty.
------	------	-----	-------------------	-------------	------

ENGINE GASKETS

Head Set	1973-1974		(Intake Manifold Gasket Not Included, Exhaust Manifold Gasket For 4 Barrel Carburetor Not Included)	HS3502	1
Full Set	1973-1974		(Intake Manifold Gasket Not Included, Exhaust Manifold Gasket For 4 Barrel Carburetor Not Included)	FS3502	1
Cylinder Head Gasket	1973-1974		<i>VR2000</i>	3502	2
			<i>Nitroseal</i>	3502SG	2
Cyl. Head Bolt Set	1973-1974			GS33346	2
Valve Cover Set	1973-1974		<i>Cork Rubber</i>	VS38422	1
			(Contains Gasket With Pre-inserted Grommets)	VS38422GR	1
			<i>High Temperature Cork Rubber</i>	VS38422H	1
			<i>Victo-Tech</i>	VS38422R	1
			<i>Tuff-Cork</i>	VS38422TC	1
Valve Stem Seal, Exh.	1973-1974			B45399	8
Valve Stem Seal, Int.	1973-1974			B45399	8
Manifold Set, Exhaust	1973-1974			MS15182	1
Manifold Set, Intake	1973-1974			MS15816	1
Oil Pan Set	1973-1974		<i>Cork Rubber</i>	OS30543	1
			<i>Tuff-Cork</i>	OS30543TC	1
Rear Main Seal Set	1973-1974		<i>Molded Rubber</i>	JV614	1
			<i>Rope Packing</i>	JV730	1
Timing Cover Set	1973-1974			JV869	1
			(Contains Repair Sleeve)	JV933	1
Timing Cover Gasket	1973-1974			T27150	1
Timing Cover Seal	1973-1974			46293	1
Harmonic Balancer Repair Sleeve	1973-1974		<i>Ground Steel, .020" Thickness</i>	66595RS	1
			Use With Part Number A502 <i>Nickel Plated Formed Steel, .013" Thickness</i>	A226-2	1

MISCELLANEOUS GASKETS

Air Cleaner Mount Gasket	1973-1974			G27098	1
			4 Barrel Carburetor	G27098	1
Carb. Mount Gasket	1973-1974			G26916	1
			4 Barrel Carburetor	G26916	1
			Carburetor To Spacer	G27131	1
			4 Barrel Carburetor, Carburetor To Spacer	G27131	1
			Spacer To Manifold	G27178	1
			4 Barrel Carburetor, Spacer To Manifold	G27178	1
Dist. Mounting Gasket	1973-1974		(O-Ring Type)	72125	1
			(Tapered Washer)	B25212	1
E.G.R. Gasket	1973-1974		Valve	G26701	1
	1973		To Valve Body	G24662	1
Fuel Pump Gasket	1973-1974			D24006	1
Oil Pan Drain Plug Gst.	1973-1974			2066A	1
Oil Pump Mounting Gasket	1973-1974			B25211	1
Water Outlet Gasket	1973-1974			C26650	1
Water Pump Mount Gasket	1973-1974			K27151	1

68 351 CID (5.8L) High Output Ford Cleveland V8 Cyl, 4.000in./101.6mm (1972) 68

Part	Year	VIN	Model/Application	Part Number	Qty.
ENGINE GASKETS					
Head Set	1972		(Intake Manifold Gasket Not Included, Exhaust Manifold Gasket For 4 Barrel Carburetor Not Included)	HS3502	1
Full Set	1972		(Intake Manifold Gasket Not Included, Exhaust Manifold Gasket For 4 Barrel Carburetor Not Included)	FS3502	1
Cylinder Head Gasket	1972		VR2000	3502	2
			Nitroseal	3502SG	2
Cyl. Head Bolt Set	1972			GS33346	2
Valve Cover Set	1972		Cork Rubber	VS38422	1
			(Contains Gasket With Pre-inserted Grommets)	VS38422GR	1
			High Temperature Cork Rubber	VS38422H	1
			Victo-Tech	VS38422R	1
			Tuff-Cork	VS38422TC	1
Valve Stem Seal, Exh.	1972			B45399	8
Valve Stem Seal, Int.	1972			B45399	8
Manifold Set, Exhaust	1972			MS15182	1
Manifold Set, Intake	1972			MS15816	1
Oil Pan Set	1972		Cork Rubber	OS30543	1
			Tuff-Cork	OS30543TC	1
Rear Main Seal Set	1972		Molded Rubber	JV614	1
			Rope Packing	JV730	1
Timing Cover Set	1972			JV869	1
			(Contains Repair Sleeve)	JV933	1
Timing Cover Gasket	1972			T27150	1
Timing Cover Seal	1972			46293	1
Harmonic Balancer Repair Sleeve	1972		Ground Steel, .020" Thickness	66595RS	1

MISCELLANEOUS GASKETS

Air Cleaner Mount Gasket	1972		4 Barrel Carburetor	G27098	1
Dist. Mounting Gasket	1972		(O-Ring Type)	72125	1
			(Tapered Washer)	B25212	1
Fuel Pump Gasket	1972			D24006	1
Oil Pan Drain Plug Gst.	1972			2066A	1
Oil Pump Mounting Gasket	1972			B25211	1
Water Outlet Gasket	1972			C26650	1
Water Pump Mount Gasket	1972			K27151	1

69 351 CID (5.8L) 351W Ford Windsor V8 Cyl, 4.000in./101.6mm (1969-1991) 69

Part	Year	VIN	Model/Application	Part Number	Qty.
ENGINE GASKETS					
Head Set	1987-1991			HS3428R	1
	1986		From 7/1/86	HS3428R	1
			Thru 7/1/86	HS3428Y	1
	1975-1985			HS3428Y	1
	1969-1974		(Exhaust Pipe Gasket Not Included)	HS3428E	1
Full Set	1988-1991			FS3428A	1
	1987		From 6/30/87	FS3428A	1
			Thru 6/30/87	FS3428R	1
	1986		Thru 7/1/86	FS3428P	1
			From 7/1/86	FS3428R	1
	1984-1985			FS3428P	1
	1983		From 7/11/83	FS3428P	1
			Thru 7/11/83	FS3428Y	1
	1975-1982			FS3428Y	1
1969-1974		(Exhaust Pipe Gasket Not Included)	FS3428E	1	

Ford

69 351 CID (5.8L) 351W Ford Windsor V8 Cyl, 4.000in./101.6mm (1969-1991) **69**
 (cont.) (cont.)

Part Year VIN Model/Application Part Number Qty.

ENGINE GASKETS (cont.)

Engine Kit Gasket Set	1988-1991		2 Barrel Carburetor	95-3379VR	1
	1987		Thru 5/31/87, (Valve Stem Seals Not Included), 2 Barrel Carburetor, Use With Part Numbers B45404 (8), B45418 (8)	95-3364VR	1
			From 6/1/87, 2 Barrel Carburetor	95-3379VR	1
	1986		From 7/21/86, (Valve Stem Seals Not Included), 2 Barrel Carburetor, Use With Part Numbers B45404 (8), B45418 (8)	95-3364VR	1
			Thru 7/21/86	95-3364VR	1
	1984-1985			95-3364VR	1
	1983		Thru 7/11/83	95-3036VR	1
			From 7/11/83	95-3364VR	1
	1975-1982			95-3036VR	1
1969-1974			95-3029VR	1	
Cylinder Head Gasket	1969-1991		<i>VR2000</i>	3428	2
			<i>Nitroseal</i>	3428SG	2
Cyl. Head Bolt Set	1973-1991			GS33345	2
Valve Cover Set	1969-1991		<i>Cork Rubber</i>	VS38300	1
			<i>High Temperature Cork Rubber</i>	VS38300H	1
			<i>High Temperature Tuff-Cork</i>	VS38300HTC	1
			<i>Victo-Tech</i>	VS38300R	1
Valve Stem Seal, Exh.	1987-1991			B45404	8
	1986		Thru 6/86	B45399	8
			From 7/1/86	B45404	8
	1969-1985			B45399	8
Valve Stem Seal, Int.	1987-1991		<i>Fluoroelastomer</i>	B45418	8
	1986		Thru 6/86	B45399	8
			From 7/1/86	<i>Fluoroelastomer</i>	B45418
	1969-1985			B45399	8
Manifold Set, Exhaust	1969-1991			MS15129Y	1
Manifold Set, Intake	1975-1991			MS15202	1
	1969-1974			MS15173W	1
Oil Pan Set	1988-1991		(One Piece) <i>Victo-Tech</i>	OS32492	1
	1987		Thru 6/30/87, (Multi Piece) <i>Cork Rubber</i>	OS30541	1
			Thru 6/30/87, (Multi Piece) <i>Tuff-Cork</i>	OS30541TC	1
			Thru 6/30/87, (Multi Piece, Contains Gasket With Pre-inserted Grommets)	OS32173GR	1
			From 6/30/87, (One Piece) <i>Victo-Tech</i>	OS32492	1
	1969-1986		(Multi Piece) <i>Cork Rubber</i>	OS30541	1
			(Multi Piece) <i>Tuff-Cork</i>	OS30541TC	1
			(Multi Piece, Contains Gasket With Pre-inserted Grommets)	OS32173GR	1
		(Optional, One Piece) <i>Victo-Tech</i>	OS32492	1	
Rear Main Seal Set	1984-1991			JV611	1
			<i>Teflon</i>	JV1636	1
	1983		From 7/83	JV611	1
			Thru 7/83 <i>Molded Rubber</i>	JV614	1
			Thru 7/83 <i>Rope Packing</i>	JV730	1
	1969-1982		<i>Molded Rubber</i>	JV614	1
			<i>Rope Packing</i>	JV730	1
Crank Repair Sleeve	1983-1991		Use With Part Number A506, Rear <i>Nickel Plated Formed Steel, .013" Thickness</i>	A332	1
Timing Cover Set	1986-1991			JV1034	1
	1969-1985			JV856	1
			(Contains Repair Sleeve)	JV922	1
Timing Cover Gasket	1969-1991			T27802	1
Timing Cover Seal	1969-1991			46293	1
Harmonic Balancer Repair Sleeve	1969-1985		<i>Ground Steel, .020" Thickness</i>	66595RS	1
			Use With Part Number A502 <i>Nickel Plated Formed Steel, .013" Thickness</i>	A226-2	1

69
(cont.)

351 CID (5.8L) 351W Ford Windsor V8 Cyl, 4.000in./101.6mm (1969-1991)

69
(cont.)

Part	Year	VIN	Model/Application	Part Number	Qty.	
MISCELLANEOUS GASKETS						
Air Cleaner Mount Gasket	1982-1991		2 Barrel Carburetor	G31432	1	
	1980		Canadian, 2 Barrel Carburetor	G27098	1	
			Except Canadian Models, 2 Barrel Carburetor	G31432	1	
	1979		Except California, 2 Barrel Carburetor	G27098	1	
	1969-1978		2 Barrel Carburetor	G27098	1	
Carb. Mount Gasket	1980-1988		Aluminum Intake Manifold Spacer, 2 Barrel Carburetor	G30651	1	
	1985		Cast Iron Manifold, 2 Barrel Carburetor, Spacer To Manifold	G26740	1	
			Cast Iron Manifold, 2 Barrel Carburetor, Carburetor To Spacer	G26741	1	
	1980		Cast Iron Manifold, 2 Barrel Carburetor, Spacer To Manifold	G26740	1	
			Cast Iron Manifold, 2 Barrel Carburetor, Carburetor To Spacer	G26741	1	
	1977-1979		2 Barrel Carburetor, Carburetor To Spacer	G26741	1	
	1975-1979		2 Barrel Carburetor, Spacer To Manifold	G26740	1	
	1973-1976		2 Barrel Carburetor, Carburetor To Spacer	G26048	1	
	1969-1972		2 Barrel Carburetor	G26052	2	
	1969		4 Barrel Carburetor	G27190	1	
Dist. Mounting Gasket	1969-1985		(O-Ring Type)	72125	1	
	1969-1972		(Tapered Washer)	B25212	1	
Exhaust Air Supply Tube	1980-1989			B45834	1	
E.G.R. Gasket	1980-1991			G26702	1	
	1979		California, Valve	G24088	1	
			Except California, Valve, Valve Adapter	G26702	1	
			(Cooler Tube Inlet), Cooler Tube, Inlet	G30689	1	
			(Cooler Tube Outlet), Cooler Tube	G30690	1	
	1977-1978			G26702	1	
	1973-1976		Valve	G26701	1	
	1975		To Valve Body	G24662	1	
	Exhaust Pipe Gasket	1991		(Flange Type), Pipe To Converter	F12439	1
		1976-1990		2-5/16" Inside Diameter, (Flange Type), Pipe To Converter 2-5/16" Inside Diameter	F14144	1
			2-1/2" Inside Diameter, (Flange Type), Pipe To Converter 2-1/2" Inside Diameter	F14145	1	
1975-1978			(Ring Type 'C'), Pipe To Manifold	F17250	1	
			(Ring Type 'B'), Pipe To Manifold <i>Sintered Metal</i>	F17250S	1	
1972-1974			Gran Torino, (Ring Type 'B'), Pipe To Manifold	F17945	2	
1971-1974			Cougar, Galaxie 500, Montego, Montego MX, Montego MX Brougham, (Ring Type 'B'), Pipe To Manifold	F17945	2	
1970-1974			LTD, (Ring Type 'B'), Pipe To Manifold	F17945	2	
1969-1974			Custom 500, Torino, (Ring Type 'B'), Pipe To Manifold	F17945	2	
1972-1973			Monterey, (Ring Type 'B'), Pipe To Manifold	F17945	2	
1969-1973			Mustang, (Ring Type 'C'), Pipe To Manifold	F7197	2	
1971			Cyclone, (Ring Type 'B'), Pipe To Manifold	F17945	2	
1969-1971			Custom, (Ring Type 'B'), Pipe To Manifold	F17945	2	
1970			Montego MX Brougham, (Ring Type 'C'), Pipe To Manifold	F7197	2	
1969-1970			Cougar, Cyclone, Montego MX, (Ring Type 'C'), Pipe To Manifold	F7197	2	
			Fairlane 500, (Ring Type 'B'), Pipe To Manifold	F17945	2	
1969			Montego, (Ring Type 'C'), Pipe To Manifold	F7197	2	
			Fairlane, (Ring Type 'B'), Pipe To Manifold	F17945	2	
Fuel Pump Gasket		1969-1986			D27094	1
				<i>Tuff-Cork</i>	D27094TC	1
Injector Nozzle O-Ring	1985-1991			GS33276	4	
Oil Pan Drain Plug Gst.	1969-1991			2066A	1	
Oil Pump Inlet Tube	1969-1988			B26151	1	

Ford

69 351 CID (5.8L) 351W Ford Windsor V8 Cyl, 4.000in./101.6mm (1969-1991) **69**
 (cont.) (cont.)

Part Year VIN Model/Application Part Number Qty.

MISCELLANEOUS GASKETS (cont.)

Oil Pump Mounting Gasket	1969-1972			B25210	1
Water Outlet Gasket	1969-1991			C24005	1
Water Pump Backing Plate	1986-1989			K30707	1
	1983-1985		Crown Victoria, Police, Taxi Or Trailer Towing Package	K27328	1
	1980-1985		Continental, Cast Iron Pump	K27151	1
	1980-1983		Mark VI, Cast Iron Pump	K27151	1
			LTD, Aluminum Pump, Except Police, Taxi And Trailer Towing Package	K27989	1
	1980-1982		Marquis, Aluminum Pump, Except Police, Taxi And Trailer Towing Package	K27989	1
	1979		Grand Marquis	K27989	1
	1978		Thunderbird	K27151	1
	1977-1978		Cougar	K27151	1
	1977		Versailles	K27151	1
	1975-1977		Granada, Monarch	K27151	1
	1969-1977		Custom 500	K27151	1
	1972-1976		Gran Torino	K27151	1
	1970-1976		LTD, Montego, Montego MX Brougham, Torino	K27151	1
	1971-1974		Galaxie 500	K27151	1
	1972-1973		Monterey	K27151	1
	1970-1973		Cougar, Mustang	K27151	1
			Cougar <i>Performaseal</i>	K27151VC	1
	1970-1971		Cyclone	K27151	1
	1970		Falcon	K27151	1
1969			K27142	1	
Water Pump Mount Gasket	1969-1991			K27955	1

70 352 CID (5.8L) V8 Cyl, 4.000in./101.6mm (1958-1966) **70**

Part Year VIN Model/Application Part Number Qty.

ENGINE GASKETS

Head Set	1958-1964			HS3389VJ	1
Full Set	1958-1966			FS3389VJ	1
Engine Kit Gasket Set	1958-1966		(Exhaust Manifold Heat Shield Gasket Not Included), Use With Part Number MS15521X	95-3359VR	1
Cylinder Head Gasket	1958-1966		<i>VR2000</i>	3389	2
Valve Cover Set	1958-1966		<i>Cork Rubber</i>	VS38308	1
			<i>Victo-Tech</i>	VS38308R	1
Valve Stem Seal, Exh.	1958-1966			B45390	8
Valve Stem Seal, Int.	1958-1966			B45390	8
Manifold Set, Exhaust	1958-1966			MS15509	1
			(Heat Shield)	MS15521X	1
Manifold Set, Intake	1958-1966			MS15166X	1
Oil Pan Set	1958-1966		<i>Cork Rubber</i>	OS30764	1
Rear Main Seal Set	1958-1966		<i>Rope Packing</i>	JV707	1
			<i>Molded Rubber</i>	JV707P	1
Timing Cover Set	1958-1966			JV819	1
			(Contains Repair Sleeve)	JV921	1
Timing Cover Gasket	1958-1966			T27798	1
Timing Cover Seal	1958-1966			46293	1
Harmonic Balancer Repair Sleeve	1958-1966		<i>Ground Steel, .020" Thickness</i>	66595RS	1
			Use With Part Number A502 <i>Nickel Plated Formed Steel, .013" Thickness</i>	A226-2	1

70 352 CID (5.8L) V8 Cyl, 4.000in./101.6mm (1958-1966) **70**
 (cont.) (cont.)

Part	Year	VIN	Model/Application	Part Number	Qty.
MISCELLANEOUS GASKETS					
Air Cleaner Mount Gasket	1963-1966		4 Barrel Carburetor	G27098	1
Carb. Mount Gasket	1964-1966		4 Barrel Carburetor, Spacer To Manifold	G27190	1
	1960-1963		2 Barrel Carburetor, Carburetor To Spacer	G7332	1
	1959-1960		4 Barrel Carburetor	G27104	1
Dist. Mounting Gasket	1958-1966			B25212	1
Exhaust Pipe Gasket	1964-1966		(Ring Type 'C'), Pipe To Manifold	F17250	2
			(Ring Type 'B'), Pipe To Manifold <i>Sintered Metal</i>	F17250S	2
	1961-1963		Fairlane, Fairlane 500, (Flange Type), Pipe To Manifold	F5576D	3
	1961-1962		Colony Park, Monterey, (Flange Type), Pipe To Manifold	F5451K	3
	1961		Country Sedan, (Flange Type), Pipe To Manifold	F5576D	3
	1960		Ranger, Thunderbird, Villager, (Flange Type), Pipe To Manifold	F5451K	3
	1959-1960		Country Sedan, (Flange Type), Pipe To Manifold	F5451K	3
	1958-1960		Fairlane, Fairlane 500, (Flange Type), Pipe To Manifold	F5451K	3
	1958-1959		Custom 300, Ranch Wagon, Thunderbird, (Flange Type), Pipe To Manifold	F5451K	3
	1958		Country Squire, (Flange Type), Pipe To Manifold	F5451K	3
Fuel Pump Bowl Gasket	1958-1966			D35288	1
Fuel Pump Gasket	1958-1966			D27094	1
Oil Filter Gasket	1958-1966		Adapter To Block	B25451	1
Oil Pump Inlet Tube	1958-1966			B26151	1
Oil Pump Mounting Gasket	1958-1966			B25412	1
Water Outlet Gasket	1958-1966			C25487	1
Water Pump Backing Plate	1958-1966			K27079	1
Water Pump Mount Gasket	1958-1966			K26442	2

71 361 CID (5.9L) Super Express V8 Cyl, 4.050in./102.9mm (1958-1959) **71**

Part	Year	VIN	Model/Application	Part Number	Qty.
ENGINE GASKETS					
Head Set	1958-1959			HS3389VJ	1
Full Set	1958-1959			FS3389VJ	1
Engine Kit Gasket Set	1958-1959		(Exhaust Manifold Heat Shield Gasket Not Included), Use With Part Number MS15521X	95-3359VR	1
Cylinder Head Gasket	1958-1959		<i>VR2000</i>	3389	2
Valve Cover Set	1958-1959		<i>Cork Rubber</i>	VS38308	1
			<i>Victo-Tech</i>	VS38308R	1
Valve Stem Seal, Exh.	1958-1959			B45390	8
Valve Stem Seal, Int.	1958-1959			B45390	8
Manifold Set, Exhaust	1958-1959			MS15509	1
Manifold Set, Intake	1958-1959			MS15166X	1
Oil Pan Set	1958-1959		<i>Cork Rubber</i>	OS30764	1
Rear Main Seal Set	1958-1959		<i>Rope Packing</i>	JV707	1
			<i>Molded Rubber</i>	JV707P	1
				JV819	1
Timing Cover Set	1958-1959			JV921	1
			(Contains Repair Sleeve)	T27798	1
Timing Cover Gasket	1958-1959			46293	1
Timing Cover Seal	1958-1959				1
Harmonic Balancer Repair Sleeve	1958-1959		<i>Ground Steel, .020" Thickness</i>	66595RS	1
			Use With Part Number A502 <i>Nickel Plated Formed Steel, .013" Thickness</i>	A226-2	1

PASSENGER CAR

Ford

71 (cont.)	361 CID (5.9L) Super Express V8 Cyl, 4.050in./102.9mm (1958-1959)	71 (cont.)
----------------------	--	----------------------

Part	Year	VIN	Model/Application	Part Number	Qty.
------	------	-----	-------------------	-------------	------

MISCELLANEOUS GASKETS

Carb. Mount Gasket	1958-1959		4 Barrel Carburetor	G27104	2
Exhaust Pipe Gasket	1958-1959		(Flange Type), Pipe To Manifold	F5451K	3
Fuel Pump Gasket	1958-1959			D27094	1
Water Outlet Gasket	1958-1959			C25487	1
Water Pump Backing Plate	1958-1959			K27079	2
Water Pump Mount Gasket	1958-1959			K26442	2

72	368 CID (6.0L) V8 Cyl, 4.000in./101.6mm (1956-1957)	72
-----------	--	-----------

Part	Year	VIN	Model/Application	Part Number	Qty.
------	------	-----	-------------------	-------------	------

ENGINE GASKETS

Valve Cover Set	1956-1957			<i>Cork Rubber</i> VS38288	1
Valve Stem Seal, Exh.	1956-1957			B45298	8
Valve Stem Seal, Int.	1956-1957			B45298	8
Oil Pan Set	1956-1957			<i>Cork Rubber</i> OS30759	1
Rear Main Seal Set	1956-1957			JV701	1
Timing Cover Seal	1956-1957			46293	1

MISCELLANEOUS GASKETS

Air Cleaner Mount Gasket	1956-1957		4 Barrel Carburetor	G26410	1
Exhaust Pipe Gasket	1957		Colony Park, Montclair, Monterey, Turnpike Cruiser, (Flange Type), Pipe To Manifold	F5451K	3
	1956-1957		Capri, Mark II, Premier, (Flange Type), Pipe To Manifold	F5436AK	3
Fuel Pump Gasket	1956-1957			D27094	1
Heat Riser Gasket	1956-1957		Capri, Mark II, Premier, (Flange Type)	F5436AK	3
Push Rod Cover Grommet	1956-1957			B45317	2

73	383 CID (6.3L) V8 Cyl, 4.300in./109.2mm (1958-1960)	73
-----------	--	-----------

Part	Year	VIN	Model/Application	Part Number	Qty.
------	------	-----	-------------------	-------------	------

ENGINE GASKETS

Cylinder Head Gasket	1958-1960			<i>VR2000</i> 3821VC	2
Valve Cover Set	1958-1960			<i>Cork Rubber</i> VS38280	1
Manifold Set, Exhaust	1958-1960			MS15571	1
Manifold Set, Intake	1958-1960			MS15079	1
Oil Pan Set	1958-1960			<i>Cork Rubber</i> OS31572	1
Rear Main Seal Set	1958-1960			JV701	1
Timing Cover Set	1958-1960		Crank Driven Power Steering	JV824	1
Timing Cover Seal	1958-1960		Except Crank Driven Power Steering	46293	1

MISCELLANEOUS GASKETS

Carb. Mount Gasket	1958-1959		4 Barrel Carburetor	G27104	2
Exhaust Pipe Gasket	1958-1960		(Flange Type), Pipe To Manifold	F5561K	1
Fuel Pump Gasket	1958-1960			D27094	1
Push Rod Cover Grommet	1958-1960			B45317	2
Push Rod Cover Set	1958-1960			PS38993	1
Water Outlet Gasket	1958-1960			C25487	1
Water Pump Mount Gasket	1958-1960			K26007	2

74	390 CID (6.4L) V8 Cyl, 4.050in./102.9mm (1961-1971)	74
-----------	--	-----------

Part	Year	VIN	Model/Application	Part Number	Qty.
------	------	-----	-------------------	-------------	------

ENGINE GASKETS

Head Set	1961-1971		(Exhaust Pipe Gasket Not Included)	HS3389VJ	1
----------	-----------	--	------------------------------------	----------	---

74 390 CID (6.4L) V8 Cyl, 4.050in./102.9mm (1961-1971)
(cont.)74
(cont.)

Part	Year	VIN	Model/Application	Part Number	Qty.
ENGINE GASKETS (cont.)					
Full Set	1961-1971		(Exhaust Pipe Gasket Not Included)	FS3389VJ	1
Engine Kit Gasket Set	1961-1971		(Exhaust Manifold Heat Shield Gasket Not Included), Use With Part Number MS15521X	95-3359VR	1
Cylinder Head Gasket	1961-1971		VR2000	3389	2
Valve Cover Set	1961-1971		Cork Rubber	VS38308	1
			Victo-Tech	VS38308R	1
Valve Stem Seal, Exh.	1961-1971			B45390	8
Valve Stem Seal, Int.	1961-1971			B45390	8
Manifold Set, Exhaust	1967-1971		Custom, LTD, 1-7/16" X 2-7/16" Ports	MS15509	1
			Custom, LTD, (Heat Shield)	MS15521X	1
	1964-1971		Custom 500, 1-7/16" X 2-7/16" Ports	MS15509	1
			Custom 500, (Heat Shield)	MS15521X	1
	1963-1971		Galaxie 500, 1-7/16" X 2-7/16" Ports	MS15509	1
			Galaxie 500, (Heat Shield)	MS15521X	1
	1961-1970		Monterey, 1-7/16" X 2-7/16" Ports	MS15509	1
			Fairlane 500, 1-7/16" X 2-1/8" Ports	MS15520	1
			Monterey, (Heat Shield)	MS15521X	1
	1969		Marauder, 1-7/16" X 2-7/16" Ports	MS15509	1
			Torino, 1-7/16" X 2-1/8" Ports	MS15520	1
			Marauder, (Heat Shield)	MS15521X	1
	1968-1969		Marquis, 1-7/16" X 2-7/16" Ports	MS15509	1
			Montego, Montego MX, 1-7/16" X 2-1/8" Ports	MS15520	1
			Marquis, (Heat Shield)	MS15521X	1
	1967-1969		Cougar, Mustang, 1-7/16" X 2-1/8" Ports	MS15520	1
	1966-1969		Cyclone, 1-7/16" X 2-7/16" Ports	MS15509	1
			Cyclone, (Heat Shield)	MS15521X	1
	1961-1969		Thunderbird, 1-7/16" X 2-7/16" Ports	MS15509	1
			Fairlane, 1-7/16" X 2-1/8" Ports	MS15520	1
			Thunderbird, (Heat Shield)	MS15521X	1
	1968		Parklane, 1-7/16" X 2-7/16" Ports	MS15509	1
			Parklane, (Heat Shield)	MS15521X	1
	1966-1968		Country Sedan, 1-7/16" X 2-7/16" Ports	MS15509	1
			Country Sedan, (Heat Shield)	MS15521X	1
	1964-1968		Commuter, 1-7/16" X 2-7/16" Ports	MS15509	1
			Commuter, (Heat Shield)	MS15521X	1
1961-1968		Colony Park, 1-7/16" X 2-7/16" Ports	MS15509	1	
		Colony Park, (Heat Shield)	MS15521X	1	
1966-1967		Calienta, Capri, Villager, Voyager, 1-7/16" X 2-7/16" Ports	MS15509	1	
		Comet, 1-7/16" X 2-1/8" Ports	MS15520	1	
		Calienta, Capri, Villager, Voyager, (Heat Shield)	MS15521X	1	
1963-1965		Marauder, 1-7/16" X 2-7/16" Ports	MS15509	1	
		Marauder, (Heat Shield)	MS15521X	1	
1961		Country Sedan, 1-7/16" X 2-1/8" Ports	MS15520	1	
Manifold Set, Intake	1961-1971			MS15166X	1
Oil Pan Set	1961-1971		Cork Rubber	OS30764	1
Rear Main Seal Set	1961-1971		Rope Packing	JV707	1
			Molded Rubber	JV707P	1
				JV819	1
Timing Cover Set	1961-1971		(Contains Repair Sleeve)	JV921	1
				T27798	1
Timing Cover Seal	1961-1971			46293	1
Harmonic Balancer Repair Sleeve	1961-1971		Ground Steel, .020" Thickness	66595RS	1
			Use With Part Number A502 Nickel Plated Formed Steel, .013" Thickness	A226-2	1

Ford

74 (cont.)	390 CID (6.4L) V8 Cyl, 4.050in./102.9mm (1961-1971)	74 (cont.)
---------------	---	---------------

Part	Year	VIN	Model/Application	Part Number	Qty.
------	------	-----	-------------------	-------------	------

MISCELLANEOUS GASKETS

Air Cleaner Mount Gasket	1961-1971		2 Barrel Carburetor	G27098	1
Carb. Mount Gasket	1961-1971		2 Barrel Carburetor, Carburetor To Spacer	G26073	2
	1965-1969		4 Barrel Carburetor, Carburetor To Spacer, Spacer To Manifold	G27190	1
	1963-1968		Thermactor Emission, 4 Barrel Carburetor, Carburetor To Spacer	G27186	1
	1966-1967		2 Barrel Carburetor, Carburetor To Spacer, Spacer To Manifold	G26052	2
	1961-1965		2 Barrel Carburetor, Spacer To Manifold	G26052	2
Dist. Mounting Gasket	1961-1971			B25212	1
Exhaust Pipe Gasket	1967-1971		Custom, LTD, (Ring Type 'C'), Pipe To Manifold	F7197	2
	1964-1971		Custom 500, (Ring Type 'C'), Pipe To Manifold	F7197	2
	1963-1971		Galaxie 500, (Ring Type 'C'), Pipe To Manifold	F7197	2
	1961-1970		Monterey, (Ring Type 'C'), Pipe To Manifold	F7197	2
			Fairlane 500, (Ring Type 'C'), Pipe To Manifold	F17250	2
			Fairlane 500, (Ring Type 'B'), Pipe To Manifold <i>Sintered Metal</i>	F17250S	2
	1969		Marauder, (Ring Type 'C'), Pipe To Manifold	F7197	2
			Torino, (Ring Type 'C'), Pipe To Manifold	F17250	2
	1968-1969		Marquis, (Ring Type 'C'), Pipe To Manifold	F7197	2
			Montego, Montego MX, (Ring Type 'C'), Pipe To Manifold	F17250	2
			Montego, Montego MX, (Ring Type 'B'), Pipe To Manifold <i>Sintered Metal</i>	F17250S	2
	1967-1969		Cougar, Mustang, (Ring Type 'C'), Pipe To Manifold	F17250	2
			Cougar, Mustang, (Ring Type 'B'), Pipe To Manifold <i>Sintered Metal</i>	F17250S	2
	1966-1969		Cyclone, (Ring Type 'C'), Pipe To Manifold	F7197	2
	1961-1969		Thunderbird, (Ring Type 'C'), Pipe To Manifold	F7197	2
			Fairlane, (Ring Type 'C'), Pipe To Manifold	F17250	2
			Fairlane, (Ring Type 'B'), Pipe To Manifold <i>Sintered Metal</i>	F17250S	2
	1968		Parklane, (Ring Type 'C'), Pipe To Manifold	F7197	2
	1966-1968		Country Sedan, (Ring Type 'C'), Pipe To Manifold	F7197	2
	1964-1968		Commuter, (Ring Type 'C'), Pipe To Manifold	F7197	2
	1961-1968		Colony Park, (Ring Type 'C'), Pipe To Manifold	F7197	2
	1966-1967		Calienta, Capri, Villager, Voyager, (Ring Type 'C'), Pipe To Manifold	F7197	2
			Comet, (Ring Type 'C'), Pipe To Manifold	F17250	2
			Comet, (Ring Type 'B'), Pipe To Manifold <i>Sintered Metal</i>	F17250S	2
	1963-1965		Marauder, (Ring Type 'C'), Pipe To Manifold	F7197	2
	1961		Country Sedan, (Ring Type 'C'), Pipe To Manifold	F17250	2
			Country Sedan, (Ring Type 'B'), Pipe To Manifold <i>Sintered Metal</i>	F17250S	2
Fuel Pump Bowl Gasket	1961-1970			D35288	1
Fuel Pump Gasket	1961-1971			D27094	1
Heat Riser Gasket	1963-1968		Country Sedan, (Flange Type)	F5451K	1
	1967		Calienta, Capri, Colony Park, Comet, Commuter, Cougar, Custom, Custom 500, Cyclone, Fairlane, Fairlane 500, Galaxie 500, LTD, Monterey, Mustang, Thunderbird, Villager, Voyager, (Flange Type)	F5451K	1
Oil Filter Gasket	1961-1971		Adapter To Block	B25451	1
Oil Pump Inlet Tube	1961-1971			B26151	1
Oil Pump Mounting Gasket	1961-1971			B25412	1
Water Outlet Gasket	1961-1971			C26154	1
Water Pump Backing Plate	1961-1971			K27079	1
Water Pump Mount Gasket	1961-1971			K26442	2

75 400 CID (6.6L) OHV V8 Cyl, 4.000in./101.6mm (1971-1979) 75

Part	Year	VIN	Model/Application	Part Number	Qty.
ENGINE GASKETS					
Head Set	1971-1979		(Intake Manifold Gasket Not Included)	HS3502	1
Full Set	1971-1979		(Intake Manifold Gasket Not Included)	FS3502	1
Engine Kit Gasket Set	1975-1979		(Intake Manifold Gasket Not Included), Use With Part Number MS15938	95-3030VR	1
	1971-1974		(Intake Manifold Gasket Not Included), Use With Part Number MS15929	95-3030VR	1
Cylinder Head Gasket	1971-1979		VR2000	3502	2
			Nitroseal	3502SG	2
Valve Cover Set	1971-1979		Cork Rubber	VS38422	1
			(Contains Gasket With Pre-inserted Grommets) Grommated Cork-Rubber	VS38422GR	1
			High Temperature Cork Rubber	VS38422H	1
			Victo-Tech	VS38422R	1
			Tuff-Cork	VS38422TC	1
Valve Stem Seal, Exh.	1971-1979			B45399	8
Valve Stem Seal, Int.	1971-1979			B45399	8
Manifold Set, Exhaust	1971-1979			MS15197	1
Manifold Set, Intake	1975-1979			MS15938	1
	1971-1974		Thermactor Emission	MS15941	1
Oil Pan Set	1971-1979		Cork Rubber	OS30543	1
			Tuff-Cork	OS30543TC	1
Rear Main Seal Set	1971-1979		Molded Rubber	JV614	1
			Rope Packing	JV730	1
Timing Cover Set	1971-1979			JV869	1
			(Contains Repair Sleeve)	JV933	1
Timing Cover Gasket	1971-1979			T27150	1
Timing Cover Seal	1971-1979			46293	1
Harmonic Balancer Repair Sleeve	1971-1979		Ground Steel, .020" Thickness	66595RS	1
			Use With Part Number A502 Nickel Plated Formed Steel, .013" Thickness	A226-2	1
MISCELLANEOUS GASKETS					
Air Cleaner Mount Gasket	1971-1979		2 Barrel Carburetor	G27098	1
Carb. Mount Gasket	1977-1979		Canadian, 2 Barrel Carburetor, Spacer To Manifold	G26074	1
			Except Canadian Models, 2 Barrel Carburetor, Spacer To Manifold	G26746	1
	1975-1979		2 Barrel Carburetor, Carburetor To Spacer	G26741	1
	1975-1976		2 Barrel Carburetor, Spacer To Manifold	G26074	1
	1973-1974		2 Barrel Carburetor, Carburetor To Spacer	G26048	1
			Except Thermactor Emission, 2 Barrel Carburetor, Spacer To Manifold	G26050	1
Choke Tube Gasket	1971-1979			B45788	1
Dist. Mounting Gasket	1971-1979		(O-Ring Type)	72125	1
	1971-1972		(Tapered Washer)	B25212	1
E.G.R. Gasket	1977-1979			G26702	1
	1973-1976			G26701	1
	1973		To Valve Body	G24662	1
Exhaust Pipe Gasket	1975-1979		2-5/16" Inside Diameter, (Flange Type), Pipe To Converter 2-5/16" Inside Diameter	F14144	1
			2-1/2" Inside Diameter, (Flange Type), Pipe To Converter 2-1/2" Inside Diameter	F14145	1
Fuel Pump Gasket	1971-1979			D24006	1
Oil Pan Drain Plug Gst.	1971-1979			2066A	1
Oil Pump Mounting Gasket	1971-1979			B25211	1
Water Outlet Gasket	1971-1979			C26650	1
Water Pump Backing Plate	1971-1979			K27151	1

Ford

75 (cont.)	400 CID (6.6L) OHV V8 Cyl, 4.000in./101.6mm (1971-1979)	75 (cont.)
----------------------	--	----------------------

Part	Year	VIN	Model/Application	Part Number	Qty.
------	------	-----	-------------------	-------------	------

MISCELLANEOUS GASKETS (cont.)

Water Pump Mount Gasket	1971-1979			K27158	1
-------------------------	-----------	--	--	--------	---

76	406 CID (6.7L) V8 Cyl, 4.130in./104.9mm (1962-1963)	76
-----------	--	-----------

Part	Year	VIN	Model/Application	Part Number	Qty.
------	------	-----	-------------------	-------------	------

ENGINE GASKETS

Head Set	1962-1963		(Exhaust Pipe Gasket Not Included)	HS3389VJ	1
Full Set	1962-1963		(Exhaust Pipe Gasket Not Included)	FS3389VJ	1
Engine Kit Gasket Set	1962-1963		(Exhaust Manifold Heat Shield Gasket Not Included), Use With Part Number MS15521X	95-3359VR	1
Cylinder Head Gasket	1962-1963		VR2000	3389	2
Valve Cover Set	1962-1963		Cork Rubber	VS38308	1
			Victo-Tech	VS38308R	1
Valve Stem Seal, Exh.	1962-1963			B45390	8
Valve Stem Seal, Int.	1962-1963			B45390	8
Manifold Set, Exhaust	1962-1963			MS15509	1
Manifold Set, Intake	1962-1963			MS15166X	1
Oil Pan Set	1962-1963		Cork Rubber	OS30764	1
Rear Main Seal Set	1962-1963		Rope Packing	JV707	1
			Molded Rubber	JV707P	1
Timing Cover Set	1962-1963			JV819	1
			(Contains Repair Sleeve)	JV921	1
Timing Cover Gasket	1962-1963			T27798	1
Timing Cover Seal	1962-1963			46293	1
Harmonic Balancer Repair Sleeve	1962-1963		Ground Steel, .020" Thickness	66595RS	1
			Use With Part Number A502 Nickel Plated Formed Steel, .013" Thickness	A226-2	1

MISCELLANEOUS GASKETS

Air Cleaner Mount Gasket	1963		4 Barrel Carburetor	G27098	1
Carb. Mount Gasket	1962-1963		3-2 Barrel Carburetors	G26052	2
			4 Barrel Carburetor	G27104	1
Dist. Mounting Gasket	1962-1963			B25212	1
Exhaust Pipe Gasket	1962-1963		(Flange Type), Pipe To Manifold	F5576D	3
Fuel Pump Gasket	1962-1963			D27094	1
Oil Pump Mounting Gasket	1962-1963			B25412	1
Water Outlet Gasket	1962-1963			C25487	1
Water Pump Backing Plate	1962-1963			K27079	1
Water Pump Mount Gasket	1962-1963			K26442	2

77	410 CID (6.7L) V8 Cyl, 4.050in./102.9mm (1966-1967)	77
-----------	--	-----------

Part	Year	VIN	Model/Application	Part Number	Qty.
------	------	-----	-------------------	-------------	------

ENGINE GASKETS

Head Set	1966-1967		(Exhaust Pipe Gasket Not Included)	HS3389VJ	1
Full Set	1966-1967		(Exhaust Pipe Gasket Not Included)	FS3389VJ	1
Engine Kit Gasket Set	1966-1967		(Exhaust Manifold Heat Shield Gasket Not Included), Use With Part Number MS15521X	95-3359VR	1
Cylinder Head Gasket	1966-1967		VR2000	3389	2
Valve Cover Set	1966-1967		Cork Rubber	VS38308	1
			Victo-Tech	VS38308R	1
Valve Stem Seal, Exh.	1966-1967			B45390	8
Valve Stem Seal, Int.	1966-1967			B45390	8

77 410 CID (6.7L) V8 Cyl, 4.050in./102.9mm (1966-1967) **77**
 (cont.) (cont.)

Part Year VIN Model/Application Part Number Qty.

ENGINE GASKETS (cont.)

Manifold Set, Exhaust	1966-1967			MS15509	1
			(Heat Shield)	MS15521X	1
Manifold Set, Intake	1966-1967			MS15166X	1
Oil Pan Set	1966-1967			<i>Cork Rubber</i> OS30764	1
Rear Main Seal Set	1966-1967			<i>Rope Packing</i> JV707	1
				<i>Molded Rubber</i> JV707P	1
Timing Cover Set	1966-1967			JV819	1
			(Contains Repair Sleeve)	JV921	1
Timing Cover Gasket	1966-1967			T27798	1
Timing Cover Seal	1966-1967			46293	1
Harmonic Balancer Repair Sleeve	1966-1967			<i>Ground Steel, .020" Thickness</i> 66595RS	1
			Use With Part Number A502 <i>Nickel Plated Formed Steel, .013" Thickness</i>	A226-2	1

MISCELLANEOUS GASKETS

Air Cleaner Mount Gasket	1966-1967		4 Barrel Carburetor	G27098	1
Dist. Mounting Gasket	1966-1967			B25212	1
Exhaust Pipe Gasket	1966-1967		(Ring Type 'C'), Pipe To Manifold	F17250	1
			(Ring Type 'B'), Pipe To Manifold	<i>Sintered Metal</i> F17250S	1
Fuel Pump Gasket	1966-1967			D27094	1
Oil Pump Mounting Gasket	1966-1967			B25412	1
Water Outlet Gasket	1966-1967			C25487	1
Water Pump Backing Plate	1966-1967			K27079	2
Water Pump Mount Gasket	1966-1967			K26442	2

78 410 CID (6.7L) OHV V8 Cyl, 4.203in./106.8mm (1958) **78**

Part Year VIN Model/Application Part Number Qty.

ENGINE GASKETS

Cylinder Head Gasket	1958			<i>VR2000</i> 3821VC	2
Valve Cover Set	1958			<i>Cork Rubber</i> VS38280	1
Manifold Set, Exhaust	1958			MS15571	1
Manifold Set, Intake	1958			MS15079	1
Oil Pan Set	1958			<i>Cork Rubber</i> OS31572	1
Rear Main Seal Set	1958			JV701	1
Timing Cover Set	1958		(Contains Repair Sleeve)	JV921	1
Timing Cover Seal	1958			46293	1
Harmonic Balancer Repair Sleeve	1958			<i>Ground Steel, .020" Thickness</i> 66595RS	1
			Use With Part Number A502 <i>Nickel Plated Formed Steel, .013" Thickness</i>	A226-2	1

MISCELLANEOUS GASKETS

Carb. Mount Gasket	1958		4 Barrel Carburetor	G27104	2
Exhaust Pipe Gasket	1958		(Flange Type)	F5561K	2
Fuel Pump Gasket	1958			D27094	1
Push Rod Cover Set	1958			PS38993	1
Water Outlet Gasket	1958			C25487	1
Water Pump Backing Plate	1958			K27079	2
Water Pump Mount Gasket	1958			K26007	2

PASSENGER CAR

Ford

79 427 CID (7.0L) High Performance V8 Cyl, 4.233in./107.5mm (1963-1968)

79

Part	Year	VIN	Model/Application	Part Number	Qty.
ENGINE GASKETS					
Head Set	1963-1968		(Exhaust Pipe Gasket Not Included)	HS3389VJ	1
Full Set	1963-1968		(Exhaust Pipe Gasket Not Included)	FS3389VJ	1
Cylinder Head Gasket	1963-1968		VR2000	3389	2
Valve Cover Set	1963-1968		Cork Rubber	VS38308	1
			Victo-Tech	VS38308R	1
Valve Stem Seal, Exh.	1963-1968			B45390	8
Valve Stem Seal, Int.	1963-1968			B45390	8
Manifold Set, Exhaust	1968		Custom 500, Cyclone, Galaxie 500, Montego, Montego MX, Mustang, Exhaust Manifold Studs Above And Below Exhaust Ports	MS15509	1
			Cougar	MS15520	1
	1963-1967			MS15509	1
Manifold Set, Intake	1963-1968			MS15166X	1
Oil Pan Set	1963-1968		Cork Rubber	OS30764	1
Rear Main Seal Set	1963-1968		Rope Packing	JV707	1
			Molded Rubber	JV707P	1
Timing Cover Set	1963-1968			JV819	1
			(Contains Repair Sleeve)	JV921	1
Timing Cover Gasket	1963-1968			T27798	1
Timing Cover Seal	1963-1968			46293	1
Harmonic Balancer Repair Sleeve	1963-1968		Ground Steel, .020" Thickness	66595RS	1
			Use With Part Number A502 Nickel Plated Formed Steel, .013" Thickness	A226-2	1
MISCELLANEOUS GASKETS					
Air Cleaner Mount Gasket	1963-1968		4 Barrel Carburetor	G27098	1
Carb. Mount Gasket	1968		(Open Center), 4 Barrel Carburetor, Carburetor To Spacer	G27104	1
			Custom 500, Cyclone, Galaxie 500, Montego, Montego MX, Mustang, (Open Center), 4 Barrel Carburetor, Carburetor To Spacer	G27104	1
			Cyclone, Montego, Montego MX, 4 Barrel Carburetor, Spacer To Manifold	G27186	1
			Cougar, 4 Barrel Carburetor, Spacer To Manifold	G27186	1
			Cougar, (4 Bolt Holes), 4 Barrel Carburetor	G27190	1
		Custom 500, Cyclone, Galaxie 500, Montego, Montego MX, Mustang, (4 Bolt Holes), 4 Barrel Carburetor	G27190	1	
Dist. Mounting Gasket	1963-1968		4 Barrel Carburetor	G14733	1
			(O-Ring Type)	72125	1
Exhaust Pipe Gasket	1963-1968		(Tapered Washer)	B25212	1
		1968		Cyclone, Montego, Montego MX, Mustang, (Flange Type), Pipe To Manifold	F5576D
Exhaust Pipe Gasket	1968		Cougar, Custom 500, Cyclone, Galaxie 500, Montego, Montego MX, Mustang, (Ring Type 'C'), Pipe To Manifold	F17250	1
			Cougar, Custom 500, Cyclone, Galaxie 500, Montego, Montego MX, Mustang, (Ring Type 'B'), Pipe To Manifold	F17250S	1
			Sintered Metal	F17250S	1
	1964-1968		Custom 500, (Flange Type), Pipe To Manifold	F5576D	3
	1963-1968		Galaxie 500, (Flange Type), Pipe To Manifold	F5576D	3
	1967		Colony Park, Marquis, Monterey, Parklane, (Flange Type), Pipe To Manifold	F5576D	3
	1964		Marauder, Monterey, (Flange Type), Pipe To Manifold	F5576D	3
	1963		Galaxie, (Flange Type), Pipe To Manifold	F5576D	3
Fuel Pump Gasket	1963-1968			D27094	1
Oil Filter Gasket	1963-1968		Adapter To Block	B25451	1
Oil Pump Inlet Tube	1963-1968			B26151	1
Oil Pump Mounting Gasket	1963-1968			B25412	1
Water Outlet Gasket	1963-1968			C25487	1

79 427 CID (7.0L) High Performance V8 Cyl, 4.233in./107.5mm (1963-1968) **79**
 (cont.) (cont.)

Part	Year	VIN	Model/Application	Part Number	Qty.
MISCELLANEOUS GASKETS (cont.)					
Water Pump Backing Plate	1963-1968			K27079	2
Water Pump Mount Gasket	1963-1968			K26442	2

80 427 CID (7.0L) Super High Output V8 Cyl, 4.233in./107.5mm (1963-1967) **80**

Part	Year	VIN	Model/Application	Part Number	Qty.
------	------	-----	-------------------	-------------	------

ENGINE GASKETS					
Head Set	1963-1967		(Exhaust Pipe Gasket Not Included)	HS3389VJ	1
Full Set	1963-1967		(Exhaust Pipe Gasket Not Included)	FS3389VJ	1
Engine Kit Gasket Set	1963-1967		Except High Performance	95-3359VR	1
Cylinder Head Gasket	1963-1967		VR2000	3389	2
Valve Cover Set	1963-1967		Cork Rubber	VS38308	1
			Victo-Tech	VS38308R	1
Valve Stem Seal, Exh.	1963-1967			B45390	8
Valve Stem Seal, Int.	1963-1967			B45390	8
Manifold Set, Exhaust	1963-1967			MS15509	1
Manifold Set, Intake	1963-1967			MS15166X	1
Oil Pan Set	1963-1967		Cork Rubber	OS30764	1
Rear Main Seal Set	1963-1967		Rope Packing	JV707	1
			Molded Rubber	JV707P	1
				JV819	1
Timing Cover Set	1963-1967		(Contains Repair Sleeve)	JV921	1
				T27798	1
Timing Cover Gasket	1963-1967			46293	1
Timing Cover Seal	1963-1967				1
Harmonic Balancer Repair Sleeve	1963-1967		Ground Steel, .020" Thickness	66595RS	1
			Use With Part Number A502 Nickel Plated Formed Steel, .013" Thickness	A226-2	1

MISCELLANEOUS GASKETS					
Air Cleaner Mount Gasket	1963-1967		2-4 Barrel Carburetors	G27098	1
Carb. Mount Gasket	1966-1967		2-4 Barrel Carburetors	G14733	1
	1964-1965		Custom 500, Marauder, Monterey, 2-4 Barrel Carburetors	G27104	1
	1963-1965		Galaxie 500, 2-4 Barrel Carburetors	G27104	1
	1963		Galaxie, 2-4 Barrel Carburetors	G27104	1
Dist. Mounting Gasket	1963-1967		(O-Ring Type)	72125	1
			(Tapered Washer)	B25212	1
Exhaust Pipe Gasket	1964-1967		Custom 500, Monterey, (Flange Type), Pipe To Manifold	F5576D	3
	1963-1967		Galaxie 500, (Flange Type), Pipe To Manifold	F5576D	3
	1964-1965		Marauder, (Flange Type), Pipe To Manifold	F5576D	3
	1963		Galaxie, (Flange Type), Pipe To Manifold	F5576D	3
Fuel Pump Gasket	1963-1967			D27094	1
Oil Filter Gasket	1963-1967		Adapter To Block	B25451	1
Oil Pump Inlet Tube	1963-1967			B26151	1
Oil Pump Mounting Gasket	1963-1967			B25412	1
Water Outlet Gasket	1963-1967			C25487	1
Water Pump Backing Plate	1963-1967			K27079	2
Water Pump Mount Gasket	1963-1967			K26442	2

Ford

81 428 CID (7.0L) Cobra Jet V8 Cyl, 4.130in./104.9mm (1966-1970)

81

Part	Year	VIN	Model/Application	Part Number	Qty.
ENGINE GASKETS					
Head Set	1966-1969		(Exhaust Pipe Gasket Not Included)	HS3389VJ	1
Full Set	1966-1969		(Exhaust Pipe Gasket Not Included)	FS3389VJ	1
Cylinder Head Gasket	1966-1970		VR2000	3389	2
Valve Cover Set	1966-1970		Cork Rubber	VS38308	1
			Victo-Tech	VS38308R	1
Valve Stem Seal, Exh.	1966-1970			B45390	8
Valve Stem Seal, Int.	1966-1970			B45390	8
Manifold Set, Exhaust	1968-1970		Cougar, Mustang, Exhaust Manifold Studs Beside Exhaust Ports	MS15520	1
	1969		Fairlane, Torino, Exhaust Manifold Studs Beside Exhaust Ports	MS15520	1
	1968-1969		Cyclone, Monterey, Exhaust Manifold Studs Above And Below Exhaust Ports	MS15509	1
			Montego, Montego MX, Exhaust Manifold Studs Beside Exhaust Ports	MS15520	1
			Cyclone, Monterey, Exhaust Manifold Studs Above And Below Exhaust Ports, (Heat Shield)	MS15521X	1
	1967-1969		Marquis, Exhaust Manifold Studs Above And Below Exhaust Ports	MS15509	1
			Marquis, Exhaust Manifold Studs Above And Below Exhaust Ports, (Heat Shield)	MS15521X	1
	1968		Thunderbird, Exhaust Manifold Studs Above And Below Exhaust Ports	MS15509	1
			Thunderbird, Exhaust Manifold Studs Above And Below Exhaust Ports, (Heat Shield)	MS15521X	1
	1966-1968		Commuter, Exhaust Manifold Studs Above And Below Exhaust Ports	MS15509	1
		Commuter, Exhaust Manifold Studs Above And Below Exhaust Ports, (Heat Shield)	MS15521X	1	
Manifold Set, Intake	1966-1970			MS15166X	1
Oil Pan Set	1966-1970		Cork Rubber	OS30764	1
Rear Main Seal Set	1966-1970		Rope Packing	JV707	1
			Molded Rubber	JV707P	1
				JV819	1
Timing Cover Set	1966-1970			JV921	1
			(Contains Repair Sleeve)	T27798	1
Timing Cover Gasket	1966-1970			46293	1
Timing Cover Seal	1966-1970				
Harmonic Balancer Repair Sleeve	1966-1970		Ground Steel, .020" Thickness	66595RS	1
			Use With Part Number A502 Nickel Plated Formed Steel, .013" Thickness	A226-2	1
MISCELLANEOUS GASKETS					
Air Cleaner Mount Gasket	1966-1970		4 Barrel Carburetor	G27098	1
Carb. Mount Gasket	1968-1970		4 Barrel Carburetor	G14733	1
	1966-1967		4 Barrel Carburetor	G27190	2
Dist. Mounting Gasket	1966-1970		(O-Ring Type)	72125	1
			(Tapered Washer)	B25212	1
Exhaust Pipe Gasket	1968-1970		Cougar, (Ring Type 'C'), Pipe To Manifold	F7197	2
			Mustang, (Ring Type 'B'), Pipe To Manifold	F17946	1
	1969		Fairlane, Torino, (Ring Type 'B'), Pipe To Manifold	F17946	1
	1968-1969		Montego, Montego MX, (Ring Type 'C'), Pipe To Manifold	F7197	2
			Cyclone, Marquis, Monterey, (Ring Type 'B'), Pipe To Manifold	F17946	1
	1968		Thunderbird, (Ring Type 'C'), Pipe To Manifold	F7197	2
			Commuter, (Ring Type 'B'), Pipe To Manifold	F17946	1
1966-1967		(Ring Type 'C'), Pipe To Manifold	F17250	1	
		(Ring Type 'B'), Pipe To Manifold	Sintered Metal F17250S	1	
Fuel Pump Gasket	1966-1970			D27094	1
Heat Riser Gasket	1967		Commuter, Marquis, (Flange Type)	F5451K	1

81 428 CID (7.0L) Cobra Jet V8 Cyl, 4.130in./104.9mm (1966-1970) **81**
(cont.) (cont.)

Part	Year	VIN	Model/Application	Part Number	Qty.
MISCELLANEOUS GASKETS (cont.)					
Oil Filter Gasket	1966-1970		Adapter To Block	B25451	1
Oil Pump Inlet Tube	1966-1970			B26151	1
Oil Pump Mounting Gasket	1966-1970			B25412	1
Water Outlet Gasket	1966-1970			C25487	1
Water Pump Backing Plate	1966-1970			K27079	1
Water Pump Mount Gasket	1966-1970			K26442	2

82 428 CID (7.0L) Super Cobra Jet V8 Cyl, 4.130in./104.9mm (1969-1970) **82**

Part	Year	VIN	Model/Application	Part Number	Qty.
ENGINE GASKETS					
Head Set	1969-1970		(Exhaust Pipe Gasket Not Included, Exhaust Manifold Gasket Not Included)	HS3389VJ	1
Full Set	1969-1970		(Exhaust Pipe Gasket Not Included, Exhaust Manifold Gasket Not Included)	FS3389VJ	1
Cylinder Head Gasket	1969-1970		VR2000	3389	2
Valve Cover Set	1969-1970		Cork Rubber	VS38308	1
			Victo-Tech	VS38308R	1
Valve Stem Seal, Exh.	1969-1970			B45390	8
Valve Stem Seal, Int.	1969-1970			B45390	8
Manifold Set, Exhaust	1969-1970		Mustang, 1-7/16" X 2-1/8" Ports	MS15520	1
Manifold Set, Intake	1969-1970			MS15166X	1
Oil Pan Set	1969-1970		Cork Rubber	OS30764	1
Rear Main Seal Set	1969-1970		Rope Packing	JV707	1
			Molded Rubber	JV707P	1
				JV819	1
Timing Cover Set	1969-1970		(Contains Repair Sleeve)	JV921	1
Timing Cover Gasket	1969-1970			T27798	1
Timing Cover Seal	1969-1970			46293	1
Harmonic Balancer Repair Sleeve	1969-1970		Ground Steel, .020" Thickness	66595RS	1
			Use With Part Number A502 Nickel Plated Formed Steel, .013" Thickness	A226-2	1

MISCELLANEOUS GASKETS

Air Cleaner Mount Gasket	1969-1970		4 Barrel Carburetor	G27098	1
Carb. Mount Gasket	1969-1970		4 Barrel Carburetor	G14733	1
Dist. Mounting Gasket	1969-1970		(O-Ring Type)	72125	1
			(Tapered Washer)	B25212	1
Exhaust Pipe Gasket	1969-1970		Mustang, (Ring Type 'B'), Pipe To Manifold	F17946	1
Fuel Pump Gasket	1969-1970			D27094	1
Oil Filter Gasket	1969-1970		Adapter To Block	B25451	1
Oil Pump Inlet Tube	1969-1970			B26151	1
Oil Pump Mounting Gasket	1969-1970			B25412	1
Water Outlet Gasket	1969-1970			C25487	1
Water Pump Backing Plate	1969-1970			K27079	1
Water Pump Mount Gasket	1969-1970			K26442	2

83 428 CID (7.0L) Thunderbird V8 Cyl, 4.130in./104.9mm (1966-1968) **83**

Part	Year	VIN	Model/Application	Part Number	Qty.
ENGINE GASKETS					
Head Set	1966-1968		(Exhaust Pipe Gasket Not Included)	HS3389VJ	1

Ford

83 (cont.)	428 CID (7.0L) Thunderbird V8 Cyl, 4.130in./104.9mm (1966-1968)				83 (cont.)
----------------------	--	--	--	--	----------------------

Part	Year	VIN	Model/Application	Part Number	Qty.
------	------	-----	-------------------	-------------	------

ENGINE GASKETS (cont.)

Full Set	1966-1968		(Exhaust Pipe Gasket Not Included)	FS3389VJ	1
Engine Kit Gasket Set	1966-1968		(Exhaust Manifold Heat Shield Gasket Not Included), Use With Part Number MS15521X	95-3359VR	1
Cylinder Head Gasket	1966-1968		<i>VR2000</i>	3389	2
Valve Cover Set	1966-1968		<i>Cork Rubber</i>	VS38308	1
			<i>Victo-Tech</i>	VS38308R	1
Valve Stem Seal, Exh.	1966-1968			B45390	8
Valve Stem Seal, Int.	1966-1968			B45390	8
Manifold Set, Exhaust	1966-1968		Colony Park, Country Sedan, Galaxie 500, Monterey, Parklane, Thunderbird, 1-7/16" X 2-7/16" Ports	MS15509	1
			Colony Park, Country Sedan, Galaxie 500, Monterey, Parklane, Thunderbird, (Heat Shield)	MS15521X	1
	1966		S-55, 1-7/16" X 2-7/16" Ports	MS15509	1
			S-55, (Heat Shield)	MS15521X	1
Manifold Set, Intake	1966-1968			MS15166X	1
Oil Pan Set	1966-1968		<i>Cork Rubber</i>	OS30764	1
Rear Main Seal Set	1966-1968		<i>Rope Packing</i>	JV707	1
			<i>Molded Rubber</i>	JV707P	1
				JV819	1
Timing Cover Set	1966-1968			JV921	1
			(Contains Repair Sleeve)	T27798	1
Timing Cover Gasket	1966-1968			46293	1
Timing Cover Seal	1966-1968				1
Harmonic Balancer Repair Sleeve	1966-1968		<i>Ground Steel, .020" Thickness</i>	66595RS	1
			Use With Part Number A502 <i>Nickel Plated Formed Steel, .013" Thickness</i>	A226-2	1

MISCELLANEOUS GASKETS

Air Cleaner Mount Gasket	1966-1968		4 Barrel Carburetor	G27098	1
Carb. Mount Gasket	1968		4 Barrel Carburetor	G27104	1
	1966-1967		4 Barrel Carburetor	G27190	1
Dist. Mounting Gasket	1966-1968		(O-Ring Type)	72125	1
			(Tapered Washer)	B25212	1
Exhaust Pipe Gasket	1968		Country Sedan, Galaxie 500, Thunderbird, (Ring Type 'C'), Pipe To Manifold	F7197	2
			Colony Park, Monterey, Parklane, (Ring Type 'B'), Pipe To Manifold	F17946	1
	1966-1967		(Ring Type 'C'), Pipe To Manifold	F17250	1
			(Ring Type 'B'), Pipe To Manifold <i>Sintered Metal</i>	F17250S	1
Fuel Pump Gasket	1966-1968			D27094	1
Heat Riser Gasket	1967		Colony Park, Country Sedan, Galaxie 500, Monterey, Parklane, Thunderbird, (Flange Type)	F5451K	1
Oil Filter Gasket	1966-1968		Adapter To Block	B25451	1
Oil Pump Inlet Tube	1966-1968			B26151	1
Oil Pump Mounting Gasket	1966-1968			B25412	1
Water Outlet Gasket	1966-1968			C25487	1
Water Pump Backing Plate	1966-1968			K27079	1
Water Pump Mount Gasket	1966-1968			K26442	2

84	429 CID (7.0L) Boss V8 Cyl, 4.360in./110.7mm (1970)				84
-----------	--	--	--	--	-----------

Part	Year	VIN	Model/Application	Part Number	Qty.
------	------	-----	-------------------	-------------	------

ENGINE GASKETS

Rear Main Seal Set	1970		<i>Molded Rubber</i>	JV618	1
Timing Cover Gasket	1970			T27842	1
Timing Cover Seal	1970			46293	1

84 429 CID (7.0L) Boss V8 Cyl, 4.360in./110.7mm (1970) **84**
(cont.) (cont.)

Part Year VIN Model/Application Part Number Qty.

ENGINE GASKETS (cont.)

Harmonic Balancer Repair Sleeve	1970		Ground Steel, .020" Thickness	66595RS	1
			Use With Part Number A502 Nickel Plated Formed Steel, .013" Thickness	A226-2	1

MISCELLANEOUS GASKETS

Fuel Pump Gasket	1970			D27094	1
				Tuff-Cork D27094TC	1
Oil Pan Drain Plug Gst.	1970			2066A	1
Oil Pump Inlet Tube	1970			B26151	1
Water Outlet Gasket	1970			C26650	1
Water Pump Backing Plate	1970			K27148	1

85 429 CID (7.0L) Cobra Jet V8 Cyl, 4.360in./110.7mm (1970-1971) **85**

Part Year VIN Model/Application Part Number Qty.

ENGINE GASKETS

Cylinder Head Gasket	1970-1971		Nitroseal	3978SG	2
Valve Cover Set	1970-1971		Cork Rubber	VS38421	1
			(High Temperature) High Temperature Cork Rubber	VS38421H	1
			Victo-Tech	VS38421R	1
			Tuff-Cork	VS38421TC	1
Valve Stem Seal, Exh.	1970-1971			B45399	8
Valve Stem Seal, Int.	1970-1971			B45399	8
Oil Pan Set	1970-1971		Cork Rubber	OS30540	1
			Tuff-Cork	OS30540TC	1
Timing Cover Set	1970-1971			JV865	1
Timing Cover Gasket	1970-1971			T27842	1
Timing Cover Seal	1970-1971			46293	1

MISCELLANEOUS GASKETS

Carb. Mount Gasket	1970		4 Barrel Carburetor, Carburetor To Spacer, Spacer To Manifold	G27190	1
Dist. Mounting Gasket	1970-1971		(O-Ring Type)	72125	1
			(Tapered Washer)	B25212	1
Fuel Pump Gasket	1970-1971			D27094	1
				Tuff-Cork D27094TC	1
Oil Pump Inlet Tube	1970-1971			B26151	1
Water Outlet Gasket	1970-1971			C26650	1
Water Pump Backing Plate	1970-1971			K27148	1
Water Pump Mount Gasket	1970-1971			K27147	1

86 429 CID (7.0L) Special V8 Cyl, 4.360in./110.7mm (1969-1970) **86**

Part Year VIN Model/Application Part Number Qty.

ENGINE GASKETS

Engine Kit Gasket Set	1969-1970		(Exhaust Manifold Heat Shield Gasket Not Included), Use With Part Number MS15205	95-3432VR	1
-----------------------	-----------	--	--	-----------	---

87 429 CID (7.0L) Super Cobra Jet V8 Cyl, 4.360in./110.7mm (1971) **87**

Part Year VIN Model/Application Part Number Qty.

ENGINE GASKETS

Cylinder Head Gasket	1971		Nitroseal	3978SG	2
Valve Cover Set	1971		Cork Rubber	VS38421	1
			(High Temperature) High Temperature Cork Rubber	VS38421H	1

Ford

87 429 CID (7.0L) Super Cobra Jet V8 Cyl, 4.360in./110.7mm (1971) **87**
 (cont.) (cont.)

Part	Year	VIN	Model/Application	Part Number	Qty.
ENGINE GASKETS (cont.)					
Valve Cover Set (cont.)	1971		<i>Victo-Tech</i>	VS38421R	1
			<i>Tuff-Cork</i>	VS38421TC	1
Valve Stem Seal, Exh.	1971			B45399	8
Valve Stem Seal, Int.	1971			B45399	8
Oil Pan Set	1971		<i>Cork Rubber</i>	OS30540	1
			<i>Tuff-Cork</i>	OS30540TC	1
Timing Cover Set	1971			JV865	1
Timing Cover Gasket	1971			T27842	1
Timing Cover Seal	1971			46293	1

MISCELLANEOUS GASKETS					
Carb. Mount Gasket	1971		4 Barrel Carburetor	G14733	2
Dist. Mounting Gasket	1971		(O-Ring Type)	72125	1
			(Tapered Washer)	B25212	1
Fuel Pump Gasket	1971			D27094	1
			<i>Tuff-Cork</i>	D27094TC	1
Oil Pump Inlet Tube	1971			B26151	1
Water Outlet Gasket	1971			C26650	1
Water Pump Backing Plate	1971			K27148	1
Water Pump Mount Gasket	1971			K27147	1

88 429 CID (7.0L) Thunder Jet V8 Cyl, 4.360in./110.7mm (1968-1973) **88**

Part	Year	VIN	Model/Application	Part Number	Qty.
ENGINE GASKETS					
Head Set	1968-1973		(Exhaust Pipe Gasket Not Included)	HS3851	1
Lower Set	1968-1973		(Requires Head Set To Make Full Set)	CS3978	1
Full Set	1968-1973		(Exhaust Pipe Gasket Not Included)	FS3851E	1
Engine Kit Gasket Set	1968-1973		(Exhaust Manifold Heat Shield Gasket Not Included), Use With Part Number MS15205	95-3432VR	1
Cylinder Head Gasket	1968-1973		<i>VR2000</i>	3909	2
			<i>Nitroseal</i>	3978SG	2
Valve Cover Set	1968-1973		<i>Cork Rubber</i>	VS38421	1
			<i>High Temperature Cork Rubber</i>	VS38421H	1
			<i>Victo-Tech</i>	VS38421R	1
			<i>Tuff-Cork</i>	VS38421TC	1
Valve Stem Seal, Exh.	1968-1973			B45399	8
Valve Stem Seal, Int.	1968-1973			B45399	8
Manifold Set, Exhaust	1968-1973			MS15175	1
Manifold Set, Intake	1968-1973			MS15171	1
Oil Pan Set	1968-1973		<i>Cork Rubber</i>	OS30540	1
			<i>Tuff-Cork</i>	OS30540TC	1
Rear Main Seal Set	1968-1973		<i>Molded Rubber</i>	JV618	1
			<i>Rope Packing</i>	JV730	1
Timing Cover Set	1968-1973			JV865	1
			(Contains Repair Sleeve)	JV932	1
Timing Cover Gasket	1968-1973			T27842	1
Timing Cover Seal	1968-1973			46293	1
Harmonic Balancer Repair Sleeve	1968-1973		<i>Ground Steel, .020" Thickness</i>	66595RS	1
			Use With Part Number A502 <i>Nickel Plated Formed Steel, .013" Thickness</i>	A226-2	1

MISCELLANEOUS GASKETS					
Air Cleaner Mount Gasket	1968-1973		4 Barrel Carburetor	G27098	1
Carb. Mount Gasket	1968-1973		4 Barrel Carburetor, Carburetor To Spacer	G27186	1

PASSENGER CAR

88 429 CID (7.0L) Thunder Jet V8 Cyl, 4.360in./110.7mm (1968-1973) **88**
 (cont.) (cont.)

Part	Year	VIN	Model/Application	Part Number	Qty.
MISCELLANEOUS GASKETS (cont.)					
Carb. Mount Gasket (cont.)	1968-1973		4 Barrel Carburetor, Spacer To Manifold	G27190	1
	1969-1971		2 Barrel Carburetor, Carburetor To Spacer	G26073	2
Choke Tube Gasket	1968-1973			B45789	1
Dist. Mounting Gasket	1968-1973		(Tapered Washer)	B25212	1
E.G.R. Gasket	1973		Between Valve And Adapter	G24663	1
			Valve	G26701	1
Exhaust Pipe Gasket	1970-1973		Marquis, Montego, Montego MX, Montego MX Brougham, Monterey, Thunderbird, (Ring Type 'B'), Pipe To Manifold	F17946	1
			LTD, (Ring Type 'B'), Pipe To Manifold	F17947	1
	1972		Galaxie 500, (Ring Type 'B'), Pipe To Manifold	F17947	1
	1970-1972		Custom, (Ring Type 'B'), Pipe To Manifold	F17947	1
	1970-1971		Cyclone, (Ring Type 'B'), Pipe To Manifold	F17946	1
			Custom 500, (Ring Type 'B'), Pipe To Manifold	F17947	1
	1970		Marauder, Marauder X-100, (Ring Type 'B'), Pipe To Manifold	F17946	1
			Galaxie 500, (Ring Type 'B'), Pipe To Manifold	F17947	1
	1969		Cougar, Cyclone, Marauder, Marauder X-100, Marquis, Montego, Montego MX, Monterey, (Ring Type 'B'), Pipe To Manifold	F17947	1
Fuel Pump Gasket	1968-1973			D27094	1
			Tuff-Cork	D27094TC	1
Oil Pan Drain Plug Gst.	1968-1973			2066A	1
Oil Pump Inlet Tube	1968-1973			B26151	1
Water Outlet Gasket	1968-1973			C26650	1
Water Pump Backing Plate	1968-1973			K27148	1
Water Pump Mount Gasket	1968-1973			K27147	1

89 430 CID (7.0L) V8 Cyl, 4.300in./109.2mm (1958-1965) **89**

Part	Year	VIN	Model/Application	Part Number	Qty.
ENGINE GASKETS					
Head Set	1961-1965			HS3821VE	1
Full Set	1961-1965			FS3821VE	1
Cylinder Head Gasket	1958-1965		VR2000	3821VC	2
Valve Cover Set	1958-1965		Cork Rubber	VS38280	1
Manifold Set, Exhaust	1958-1965			MS15571	1
Manifold Set, Intake	1958-1965			MS15079	1
Oil Pan Set	1958-1965		Cork Rubber	OS31572	1
Rear Main Seal Set	1958-1960			JV701	1
Timing Cover Set	1958-1960		Colony Park, Montclair, Monterey, Parklane, Crank Driven Power Steering	JV824	1
	1958		Turnpike Cruiser, Crank Driven Power Steering	JV824	1
Timing Cover Seal	1958-1960		Except Crank Driven Power Steering	46293	1

MISCELLANEOUS GASKETS					
Carb. Mount Gasket	1963-1965		4 Barrel Carburetor	G31444	1
	1960		Mark V, 2 Barrel Carburetor	G7332	1
	1958		Capri, Colony Park, Montclair, Parklane, Premier, Turnpike Cruiser, 4 Barrel Carburetor	G27104	1
Crankcase Vent Cover Gasket	1958-1965			C24109	1
Dist. Mounting Gasket	1958-1960			B25212	1
Exhaust Pipe Gasket	1963-1965		(Flange Type), Pipe To Converter	F5421K	4
	1958-1960		(Flange Type), Pipe To Manifold	F5561K	2
Fuel Pump Gasket	1958-1965			D27094	1

Ford

89 (cont.)	430 CID (7.0L) V8 Cyl, 4.300in./109.2mm (1958-1965)				89 (cont.)
----------------------	--	--	--	--	----------------------

Part	Year	VIN	Model/Application	Part Number	Qty.
MISCELLANEOUS GASKETS (cont.)					
Oil Pump Mounting Gasket	1958-1965			B25412	1
Push Rod Cover Set	1958-1965			PS38993	1
Water Outlet Gasket	1958-1965			C25487	1
Water Pump Mount Gasket	1958-1965			K26007	2

90	460 CID (7.5L) V8 Cyl, 4.360in./110.7mm (1968-1978)				90
-----------	--	--	--	--	-----------

Part	Year	VIN	Model/Application	Part Number	Qty.
------	------	-----	-------------------	-------------	------

ENGINE GASKETS					
Head Set	1968-1978		Except High Output Engine, (Exhaust Pipe Gasket Not Included, Intake Manifold Gasket Not Included)	HS3851	1
			High Output Engine, (Exhaust Pipe Gasket Not Included, Intake Manifold Gasket Not Included)	HS3978P	1
Lower Set	1968-1978		(Requires Head Set To Make Full Set)	CS3978	1
Full Set	1968-1978		Except High Output Engine, (Exhaust Pipe Gasket Not Included, Intake Manifold Gasket Not Included)	FS3851E	1
			High Output Engine, (Exhaust Pipe Gasket Not Included, Intake Manifold Gasket Not Included)	FS3978P	1
Engine Kit Gasket Set	1975-1978		(Intake Manifold Gasket Not Included, Exhaust Manifold Heat Shield Gasket Not Included), Use With Part Numbers MS15937, MS15205	95-3432VR	1
	1968-1974		(Exhaust Manifold Heat Shield Gasket Not Included), Use With Part Number MS15205	95-3432VR	1
Cylinder Head Gasket	1968-1978		Except High Output Engine <i>VR2000</i>	3909	2
			High Output Engine <i>Nitroseal</i>	3978	2
Valve Cover Set	1968-1978		<i>Cork Rubber</i>	VS38421	1
			<i>High Temperature Cork Rubber</i>	VS38421H	1
			<i>Victo-Tech</i>	VS38421R	1
			<i>Tuff-Cork</i>	VS38421TC	1
Valve Stem Seal, Exh.	1968-1978			B45399	8
Valve Stem Seal, Int.	1968-1978			B45399	8
Manifold Set, Exhaust	1968-1978			MS15175	1
			(Heat Shield)	MS15205	1
Manifold Set, Intake	1975-1978			MS15937	1
	1968-1974			MS15171	1
				MS15171	1
Oil Pan Set	1968-1978		<i>Cork Rubber</i>	OS30540	1
			<i>Tuff-Cork</i>	OS30540TC	1
Rear Main Seal Set	1968-1978		<i>Molded Rubber</i>	JV618	1
			<i>Rope Packing</i>	JV730	1
Timing Cover Set	1970-1978			JV865	1
			(Contains Repair Sleeve)	JV932	1
	1968-1969			JV864	1
Timing Cover Gasket	1968-1978			T27842	1
Timing Cover Seal	1970-1978			46293	1
Harmonic Balancer Repair Sleeve	1970-1978		<i>Ground Steel, .020" Thickness</i>	66595RS	1
			Use With Part Number A502 <i>Nickel Plated Formed Steel, .013" Thickness</i>	A226-2	1

MISCELLANEOUS GASKETS					
Air Cleaner Mount Gasket	1975-1978		4 Barrel Carburetor	G27098	1
	1972-1976		Except Thermactor Emission, 4 Barrel Carburetor	G27098	1
	1975		4 Barrel Carburetor	G27098	1
	1968-1970		4 Barrel Carburetor	G27098	1
Carb. Mount Gasket	1976-1978		4 Barrel Carburetor, Spacer To Manifold	G26755	1
	1975-1978		4 Barrel Carburetor, Carburetor To Spacer	G26750	1
	1975		4 Barrel Carburetor, Spacer To Manifold	G26763	1

90 (cont.)	460 CID (7.5L) V8 Cyl, 4.360in./110.7mm (1968-1978)				90 (cont.)
---------------	---	--	--	--	---------------

Part	Year	VIN	Model/Application	Part Number	Qty.
------	------	-----	-------------------	-------------	------

MISCELLANEOUS GASKETS (cont.)

Carb. Mount Gasket (cont.)	1972-1974		Except Thermactor Emission, 4 Barrel Carburetor, Carburetor To Spacer	G27186	1
	1968-1972		4 Barrel Carburetor, Carburetor To Spacer	G27186	1
			4 Barrel Carburetor, Spacer To Manifold	G27190	1
Choke Tube Gasket	1974		Except Thermactor Emission	B45789	1
	1968-1973		Thermactor Emission	B45789	1
Dist. Mounting Gasket	1968-1978			72125	1
E.G.R. Gasket	1977-1978			G26702	1
	1976		Both Sides Of Back Pressure Valve	G24666	2
	1973-1976		Between Valve And Valve Adapter, Valve Adapter	G24663	1
			Valve	G26701	1
	1975		To Valve Body	G24662	1
Exhaust Pipe Gasket	1977-1978		Mark V, (Ring Type 'C'), Pipe To Manifold	F17250	1
			Mark V, (Ring Type 'B'), Pipe To Manifold <i>Sintered Metal</i>	F17250S	1
	1975-1978		2-5/16" Inside Diameter, (Flange Type), Pipe To Converter <i>2-5/16" Inside Diameter</i>	F14144	1
			2-1/2" Inside Diameter, (Flange Type), Pipe To Converter <i>2-1/2" Inside Diameter</i>	F14145	1
			Grand Marquis, (Ring Type 'B'), Pipe To Manifold	F17947	1
	1973-1978		(Flange Type)	F5576D	2
			LTD, (Ring Type 'B'), Pipe To Manifold	F17947	1
	1972-1978		Marquis, (Ring Type 'B'), Pipe To Manifold	F17947	1
	1968-1978		Continental, (Ring Type 'C'), Pipe To Manifold	F17250	1
			Continental, (Ring Type 'B'), Pipe To Manifold <i>Sintered Metal</i>	F17250S	1
	1973-1977		Custom 500, (Ring Type 'B'), Pipe To Manifold	F17947	1
	1975-1976		Montego MX Brougham, (Ring Type 'B'), Pipe To Manifold	F17946	1
	1974-1976		Cougar, Montego, Montego MX, (Ring Type 'B'), Pipe To Manifold	F17946	1
	1973-1976		Gran Torino, Torino, (Ring Type 'B'), Pipe To Manifold	F17947	1
	1972-1976		Mark IV, Thunderbird, (Ring Type 'C'), Pipe To Manifold	F17250	1
			Mark IV, Thunderbird, (Ring Type 'B'), Pipe To Manifold <i>Sintered Metal</i>	F17250S	1
			Mark IV, (Ring Type 'B'), Pipe To Manifold	F17946	1
	1972-1974		Monterey, (Ring Type 'B'), Pipe To Manifold	F17947	1
	1968-1969		Continental, (Flange Type), Pipe To Converter	F5421K	4
				D27094	1
Fuel Pump Gasket	1968-1978		<i>Tuff-Cork</i>	D27094TC	1
Oil Filter Gasket	1973-1978		(O-Ring Type), Adapter To Block	B45825	1
Oil Pump Inlet Tube	1968-1978			B26151	1
Water Outlet Gasket	1968-1978			C26650	1
Water Pump Backing Plate	1968-1978			K27148	1
Water Pump Mount Gasket	1968-1978			K27147	1

91	462 CID (7.6L) V8 Cyl, 4.380in./111.3mm (1966-1968)				91
----	---	--	--	--	----

Part	Year	VIN	Model/Application	Part Number	Qty.
------	------	-----	-------------------	-------------	------

ENGINE GASKETS

Head Set	1966-1968			HS3821VE	1
Full Set	1966-1968			FS3821VE	1
Cylinder Head Gasket	1966-1968		<i>VR2000</i>	3821VC	2
Valve Cover Set	1966-1968		<i>Cork Rubber</i>	VS38280	1
Manifold Set, Exhaust	1966-1968			MS15571	1
Manifold Set, Intake	1966-1968			MS15155	1
Oil Pan Set	1966-1968		<i>Cork Rubber</i>	OS31572	1
Rear Main Seal Set	1966-1968			JV701	1

Ford

91 (cont.)	462 CID (7.6L) V8 Cyl, 4.380in./111.3mm (1966-1968)	91 (cont.)
----------------------	--	----------------------

Part	Year	VIN	Model/Application	Part Number	Qty.
------	------	-----	-------------------	-------------	------

ENGINE GASKETS (cont.)

Timing Cover Set	1966-1968			JV824	1
------------------	-----------	--	--	-------	---

MISCELLANEOUS GASKETS

Carb. Mount Gasket	1966-1968		4 Barrel Carburetor	G31444	1
Dist. Mounting Gasket	1966-1968			B25212	1
Exhaust Pipe Gasket	1966-1968		(Flange Type), Pipe To Converter	F5421K	4
Fuel Pump Gasket	1966-1968			D27094	1
Oil Pump Inlet Tube	1966-1968			B26151	1
Oil Pump Mounting Gasket	1966-1968			B25412	1
Push Rod Cover Set	1966-1968			PS38993	1
Water Outlet Gasket	1966-1968			C25487	1
Water Pump Mount Gasket	1966-1968			K26007	2

General Motors Corp.

Engine Index

Engine	Year	Block	Engine	Year	Block
61 CID (1.0L) LP2 Suzuki	1989-2000	1	207 CID (3.4L) L32 Chevrolet	1993-1995	47
61 CID (1.0L) LS3 Turbo Suzuki	1987-1991	2	207 CID (3.4L) LA1 Chevrolet	1999-2003	48
61 CID (1.0L) LY9 Suzuki	1985-1988	3	207 CID (3.4L) LQ1 DOHC Chevrolet	1991-1997	49
79 CID (1.3L) L72 SOHC Suzuki	1992-1997	4	212 CID (3.5L) LX5 Oldsmobile	1999-2002	50
79 CID (1.3L) LY8 Suzuki	1998-2001	5	215 CID (3.5L) Pontiac	1964-1965	51
85 CID (1.4L) LX3 Chevrolet	1976-1977	6	215 CID (3.5L) Aluminum Block & Heads Buick	1961-1963	52
92 CID (1.5L) LC5 Isuzu	1985-1989	7	216 CID (3.5L) Chevrolet	1937-1952	53
98 CID (1.6L) Chevrolet	1976-1987	8	225 CID (3.7L) Buick	1964-1967	54
98 CID (1.6L) L73 Daewoo	1988-1993	9	229 CID (3.8L) LC3 Chevrolet	1980-1984	55
98 CID (1.6L) LO1 SOHC Isuzu	1990-1993	10	230 CID (3.8L) Chevrolet	1964-1970	56
98 CID (1.6L) LW0 DOHC Isuzu	1990-1991	11	230 CID (3.8L) OHC Pontiac	1966-1967	57
98 CID (1.6L) LC9 SOHC Toyota	1985-1988	12	231 CID (3.8L) Carbureted Buick	1975-1987	58
98 CID (1.6L) LO1 DOHC Toyota	1989-1997	13	231 CID (3.8L) Fuel Injected Buick	1984-2003	59
98 CID (1.6L) LW0 DOHC Toyota	1988-1992	14	231 CID (3.8L) Supercharged Buick	1991-2003	60
108 CID (1.8L) LV6 DOHC Toyota	1993-1997	15	231 CID (3.8L) Turbo Buick	1978-1989	61
110 CID (1.8L) LV6 DOHC Isuzu	1992-1993	16	235 CID (3.9L) Chevrolet	1950-1962	62
110 CID (1.8L) LA5 OHC Turbo Pontiac	1984-1986	17	235 CID (3.9L) Corvette Chevrolet	1953-1955	63
110 CID (1.8L) LH8 OHC Pontiac	1982-1986	18	244 CID (4.0L) L47 Oldsmobile	1995-2003	64
111 CID (1.8L) LJ5 SOHC Isuzu Diesel	1981-1986	19	250 CID (4.1L) Chevrolet	1966-1979	65
112 CID (1.8L) L46 Chevrolet	1982	20	250 CID (4.1L) OHC Pontiac	1968-1969	66
121 CID (2.0L) LL8 Chevrolet	1987-1989	21	252 CID (4.1L) LC4 Buick	1980-1984	67
121 CID (2.0L) LQ5 Chevrolet	1983-1986	22	252 CID (4.1L) Cadillac	1982-1988	68
121 CID (2.0L) LR9 Chevrolet	1983-1984	23	260 CID (4.3L) Oldsmobile Diesel	1982-1985	69
122 CID (2.0L) OHC Pontiac	1987-1994	24	260 CID (4.3L) LF7 Oldsmobile Diesel	1979	70
122 CID (2.0L) OHC Turbo Pontiac	1987-1990	25	260 CID (4.3L) LV8 Oldsmobile	1975-1982	71
134 CID (2.2L) LM3 Chevrolet	1990-1991	26	262 CID (4.3L) Chevrolet	1985-1993	72
134 CID (2.2L) LN2/KL6 Chevrolet Bi-Fuel Gasoline/Compressed Natural Gas	2000-2002	27	262 CID (4.3L) Chevrolet	1975-1976	73
134 CID (2.2L) OHV Chevrolet	1992-2002	28	265 CID (4.3L) Chevrolet	1955-1957	74
138 CID (2.3L) DOHC Oldsmobile	1987-1995	29	265 CID (4.3L) L99 Chevrolet	1994-1996	75
138 CID (2.3L) L40 SOHC Oldsmobile	1992-1994	30	265 CID (4.3L) LS5 Pontiac	1980-1981	76
140 CID (2.3L) Chevrolet	1971-1977	31	267 CID (4.4L) L39 Chevrolet	1979-1982	77
140 CID (2.3L) Chevrolet Corvair	1960-1961	32	273 CID (4.5L) Cadillac	1988-1992	78
145 CID (2.4L) Chevrolet Corvair	1961-1963	33	281 CID (4.6L) L37 Cadillac	1993-2003	79
146 CID (2.4L) LD9 DOHC Oldsmobile	1996-2002	34	281 CID (4.6L) LD8 Cadillac	1993-2003	80
151 CID (2.5L) Carbureted Pontiac	1977-1983	35	283 CID (4.6L) Chevrolet	1957-1967	81
151 CID (2.5L) Fuel Injected Pontiac	1982-1992	36	300 CID (4.9L) Buick	1964-1967	82
153 CID (2.5L) Chevrolet	1962-1970	37	300 CID (4.9L) L26 Cadillac	1991-1995	83
164 CID (2.7L) Chevrolet Corvair	1965-1969	38	301 CID (4.9L) Pontiac	1977-1981	84
173 CID (2.8L) Chevrolet	1980-1989	39	302 CID (5.0L) Chevrolet	1967-1969	85
181 CID (3.0L) Buick	1982-1988	40	305 CID (5.0L) Chevrolet	1976-1993	86
189 CID (3.1L) Chevrolet	1988-2003	41	307 CID (5.0L) Chevrolet	1968-1973	87
194 CID (3.2L) Chevrolet	1962-1966	42	307 CID (5.0L) Oldsmobile	1980-1990	88
195 CID (3.2L) Pontiac	1961-1963	43	322 CID (5.3L) Buick	1953-1956	89
196 CID (3.2L) LC9 Buick	1978-1979	44	326 CID (5.3L) Pontiac	1963-1967	90
200 CID (3.3L) L26 Chevrolet	1978-1979	45	327 CID (5.4L) Chevrolet	1962-1969	91
204 CID (3.3L) LG7 Buick	1989-1993	46	330 CID (5.4L) OHV Oldsmobile	1964-1967	92

Engine Index (cont.)

Engine	Year	Block
331 CID (5.4L) OHV Cadillac	1949-1955	93
340 CID (5.6L) Buick	1966-1967	94
346 CID (5.7L) LS1 Chevrolet	1997-2003	95
346 CID (5.7L) LS6 Chevrolet	2001-2003	96
348 CID (5.7L) Chevrolet	1958-1961	97
350 CID (5.7L) Buick	1968-1981	98
350 CID (5.7L) Carbureted Chevrolet	1967-1987	99
350 CID (5.7L) Fuel Injected Chevrolet	1982-1997	100
350 CID (5.7L) LT5 DOHC Chevrolet	1993	101
350 CID (5.7L) Oldsmobile	1968-1980	102
350 CID (5.7L) Oldsmobile Diesel	1978-1985	103
350 CID (5.7L) Pontiac	1968-1977	104
364 CID (6.0L) Buick	1957-1961	105
365 CID (6.0L) Cadillac	1957-1958	106
368 CID (6.0L) Cadillac	1980-1985	107
370 CID (6.1L) Pontiac	1958	108
389 CID (6.4L) Pontiac	1961-1966	109
390 CID (6.4L) Cadillac	1959-1963	110
396 CID (6.6L) Chevrolet	1965-1970	111
400 CID (6.6L) Buick	1967-1969	112
400 CID (6.6L) Chevrolet	1970-1976	113

Engine	Year	Block
400 CID (6.6L) Oldsmobile	1968-1969	114
400 CID (6.6L) Oldsmobile	1965-1967	115
400 CID (6.6L) Pontiac	1967-1979	116
401 CID (6.6L) Buick	1959-1966	117
402 CID (6.6L) Chevrolet	1970-1972	118
403 CID (6.6L) L80 Oldsmobile	1977-1979	119
409 CID (6.7L) Chevrolet	1961-1965	120
421 CID (6.9L) Pontiac	1963-1966	121
425 CID (7.0L) Buick	1963-1966	122
425 CID (7.0L) Cadillac	1977-1979	123
425 CID (7.0L) Oldsmobile	1965-1967	124
427 CID (7.0L) Chevrolet	1966-1969	125
428 CID (7.0L) Pontiac	1967-1969	126
429 CID (7.0L) Cadillac	1964-1967	127
430 CID (7.0L) Buick	1967-1969	128
454 CID (7.4L) Chevrolet	1970-1976	129
455 CID (7.5L) Buick	1970-1976	130
455 CID (7.5L) Oldsmobile	1968-1976	131
455 CID (7.5L) Pontiac	1970-1976	132
472 CID (7.7L) Cadillac	1968-1974	133
500 CID (8.2L) Cadillac	1970-1976	134

Model Index

Model	Engine	Year	Block
88 Royale	231 CID (3.8L) Supercharged Buick	1995	60
88 Royale	231 CID (3.8L) Fuel Injected Buick	1989-1999	59
442	400 CID (6.6L) Oldsmobile	1968-1969	114
442	455 CID (7.5L) Oldsmobile	1968-1971	131
2000 Sunbird	110 CID (1.8L) LA5 OHC Turbo Pontiac	1984-1985	17
2000 Sunbird	110 CID (1.8L) LH8 OHC Pontiac	1984-1985	18
2000 Sunbird	121 CID (2.0L) LQ5 Chevrolet	1984-1985	22
6000	151 CID (2.5L) Fuel Injected Pontiac	1982-1991	36
6000	173 CID (2.8L) Chevrolet	1982-1989	39
6000	189 CID (3.1L) Chevrolet	1988-1991	41
6000	260 CID (4.3L) Oldsmobile Diesel	1982-1985	69
Achieva	138 CID (2.3L) L40 SOHC Oldsmobile	1992-1994	30
Achieva	138 CID (2.3L) DOHC Oldsmobile	1992-1995	29
Achieva	146 CID (2.4L) LD9 DOHC Oldsmobile	1996-1998	34
Achieva	189 CID (3.1L) Chevrolet	1994-1998	41
Achieva	204 CID (3.3L) LG7 Buick	1992-1993	46
Alero	146 CID (2.4L) LD9 DOHC Oldsmobile	1999-2001	34
Alero	207 CID (3.4L) LA1 Chevrolet	1999-2004	48
Allante	252 CID (4.1L) Cadillac	1987-1988	68
Allante	273 CID (4.5L) Cadillac	1989-1992	78
Allante	281 CID (4.6L) L37 Cadillac	1993	79
Apollo	231 CID (3.8L) Carbureted Buick	1975	58
Apollo	250 CID (4.1L) Chevrolet	1973-1975	65
Apollo	260 CID (4.3L) LV8 Oldsmobile	1975	71
Apollo	350 CID (5.7L) Buick	1975	98
Astre	140 CID (2.3L) Chevrolet	1975-1976	31
Astre	151 CID (2.5L) Carbureted Pontiac	1977	35
Aurora	212 CID (3.5L) LX5 Oldsmobile	2001-2002	50
Aurora	244 CID (4.0L) L47 Oldsmobile	1995-2003	64
Beauville	235 CID (3.9L) Chevrolet	1955-1957	62
Beauville	265 CID (4.3L) Chevrolet	1955-1957	74
Beauville	283 CID (4.6L) Chevrolet	1957	81
Bel Air	230 CID (3.8L) Chevrolet	1964-1965	56
Bel Air	235 CID (3.9L) Chevrolet	1953-1960	62

Model	Engine	Year	Block
Bel Air	250 CID (4.1L) Chevrolet	1965-1975	65
Bel Air	265 CID (4.3L) Chevrolet	1955-1957	74
Bel Air	283 CID (4.6L) Chevrolet	1957-1967	81
Bel Air	307 CID (5.0L) Chevrolet	1968	87
Bel Air	327 CID (5.4L) Chevrolet	1962-1968	91
Bel Air	348 CID (5.7L) Chevrolet	1958-1961	97
Bel Air	350 CID (5.7L) Carbureted Chevrolet	1969-1975	99
Bel Air	396 CID (6.6L) Chevrolet	1965-1968	111
Bel Air	400 CID (6.6L) Chevrolet	1971-1975	113
Bel Air	402 CID (6.6L) Chevrolet	1971-1972	118
Bel Air	409 CID (6.7L) Chevrolet	1961-1965	120
Bel Air	427 CID (7.0L) Chevrolet	1966-1969	125
Bel Air	454 CID (7.4L) Chevrolet	1971-1975	129
Beretta	121 CID (2.0L) LL8 Chevrolet	1987-1989	21
Beretta	134 CID (2.2L) OHV Chevrolet	1992-1996	28
Beretta	134 CID (2.2L) LM3 Chevrolet	1990-1991	26
Beretta	138 CID (2.3L) DOHC Oldsmobile	1989-1993	29
Beretta	173 CID (2.8L) Chevrolet	1987-1989	39
Beretta	189 CID (3.1L) Chevrolet	1990-1996	41
Biscayne	230 CID (3.8L) Chevrolet	1964-1965	56
Biscayne	235 CID (3.9L) Chevrolet	1958-1963	62
Biscayne	250 CID (4.1L) Chevrolet	1965-1972	65
Biscayne	283 CID (4.6L) Chevrolet	1958-1967	81
Biscayne	307 CID (5.0L) Chevrolet	1968	87
Biscayne	327 CID (5.4L) Chevrolet	1962-1968	91
Biscayne	348 CID (5.7L) Chevrolet	1958-1961	97
Biscayne	350 CID (5.7L) Carbureted Chevrolet	1969-1972	99
Biscayne	396 CID (6.6L) Chevrolet	1965-1968	111
Biscayne	400 CID (6.6L) Chevrolet	1970-1972	113
Biscayne	402 CID (6.6L) Chevrolet	1970-1972	118
Biscayne	409 CID (6.7L) Chevrolet	1961-1965	120
Biscayne	427 CID (7.0L) Chevrolet	1966-1969	125
Biscayne	454 CID (7.4L) Chevrolet	1970-1972	129
Bonneville	231 CID (3.8L) Supercharged Buick	1992-2003	60
Bonneville	231 CID (3.8L) Fuel Injected Buick	1986-2004	59
Bonneville	231 CID (3.8L) Carbureted Buick	1980-1986	58
Bonneville	252 CID (4.1L) LC4 Buick	1982	67
Bonneville	260 CID (4.3L) Oldsmobile Diesel	1982	69
Bonneville	262 CID (4.3L) Chevrolet	1986	72
Bonneville	265 CID (4.3L) LS5 Pontiac	1980-1981	76

General Motors Corp.

Model Index (cont.)

Model	Engine	Year	Block	Model	Engine	Year	Block
Bonneville	301 CID (4.9L) Pontiac	1977-1981	84	Caprice	283 CID (4.6L) Chevrolet	1966-1967	81
Bonneville	305 CID (5.0L) Chevrolet	1983-1986	86	Caprice	305 CID (5.0L) Chevrolet	1977-1993	86
Bonneville	307 CID (5.0L) Oldsmobile	1981	88	Caprice	307 CID (5.0L) Oldsmobile	1980-1990	88
Bonneville	350 CID (5.7L) Oldsmobile	1980-1984	103	Caprice	307 CID (5.0L) Chevrolet	1968-1973	87
	Diesel			Caprice	327 CID (5.4L) Chevrolet	1966-1969	91
Bonneville	350 CID (5.7L) Carbureted Chevrolet	1974-1982	99	Caprice	350 CID (5.7L) Fuel Injected Chevrolet	1990-1996	100
Bonneville	350 CID (5.7L) Buick	1978-1980	98	Caprice	350 CID (5.7L) Oldsmobile Diesel	1978-1985	103
Bonneville	350 CID (5.7L) Pontiac	1976-1977	104	Caprice	350 CID (5.7L) Carbureted Chevrolet	1967-1987	99
Bonneville	350 CID (5.7L) Oldsmobile	1976-1980	102	Caprice	396 CID (6.6L) Chevrolet	1966-1968	111
Bonneville	389 CID (6.4L) Pontiac	1960-1966	109	Caprice	400 CID (6.6L) Chevrolet	1970-1976	113
Bonneville	400 CID (6.6L) Chevrolet	1971-1976	113	Caprice	402 CID (6.6L) Chevrolet	1970-1972	118
Bonneville	400 CID (6.6L) Pontiac	1967-1978	116	Caprice	427 CID (7.0L) Chevrolet	1966-1969	125
Bonneville	403 CID (6.6L) L80 Oldsmobile	1977-1979	119	Caprice	454 CID (7.4L) Chevrolet	1970-1975	129
Bonneville	421 CID (6.9L) Pontiac	1963-1966	121	Catalina	231 CID (3.8L) Carbureted Buick	1976-1981	58
Bonneville	428 CID (7.0L) Pontiac	1967-1969	126	Catalina	265 CID (4.3L) LS5 Pontiac	1980-1981	76
Bonneville	455 CID (7.5L) Pontiac	1970-1975	132	Catalina	301 CID (4.9L) Pontiac	1977-1981	84
Bonneville	389 CID (6.4L) Pontiac	1960-1962	109	Catalina	305 CID (5.0L) Chevrolet	1977	86
Custom				Catalina	307 CID (5.0L) Oldsmobile	1980-1981	88
Brookwood	235 CID (3.9L) Chevrolet	1958-1960	62	Catalina	350 CID (5.7L) Oldsmobile Diesel	1978-1981	103
Brookwood	283 CID (4.6L) Chevrolet	1958-1961	81	Catalina	350 CID (5.7L) Carbureted Chevrolet	1974-1981	99
Brookwood	348 CID (5.7L) Chevrolet	1958-1961	97	Catalina	350 CID (5.7L) Buick	1978-1980	98
Brookwood	409 CID (6.7L) Chevrolet	1961	120	Catalina	350 CID (5.7L) Pontiac	1971-1977	104
Brougham	305 CID (5.0L) Chevrolet	1991-1992	86	Catalina	350 CID (5.7L) Oldsmobile	1972-1980	102
Brougham	350 CID (5.7L) Fuel Injected Chevrolet	1990-1996	100	Catalina	389 CID (6.4L) Pontiac	1959-1965	109
Calais	138 CID (2.3L) DOHC Oldsmobile	1987-1991	29	Catalina	400 CID (6.6L) Pontiac	1967-1978	116
Calais	151 CID (2.5L) Fuel Injected Pontiac	1985-1991	36	Catalina	403 CID (6.6L) L80 Oldsmobile	1977-1979	119
Calais	181 CID (3.0L) Buick	1985-1988	40	Catalina	421 CID (6.9L) Pontiac	1963-1966	121
Calais	204 CID (3.3L) LG7 Buick	1989-1991	46	Catalina	428 CID (7.0L) Pontiac	1967-1969	126
Calais	350 CID (5.7L) Oldsmobile	1976	102	Catalina	455 CID (7.5L) Pontiac	1970-1975	132
Calais	429 CID (7.0L) Cadillac	1965-1967	127	Cavalier	112 CID (1.8L) L46 Chevrolet	1982	20
Calais	472 CID (7.7L) Cadillac	1968-1974	133	Cavalier	121 CID (2.0L) LL8 Chevrolet	1987-1989	21
Calais	500 CID (8.2L) Cadillac	1975-1976	134	Cavalier	121 CID (2.0L) LQ5 Chevrolet	1983-1986	22
Camaro	151 CID (2.5L) Fuel Injected Pontiac	1982-1986	36	Cavalier	121 CID (2.0L) LR9 Chevrolet	1983-1984	23
Camaro	151 CID (2.5L) Carbureted Pontiac	1982-1983	35	Cavalier	134 CID (2.2L) LN2/KL6 Chevrolet	2000-2002	27
Camaro	173 CID (2.8L) Chevrolet	1982-1989	39	Cavalier	134 CID (2.2L) OHV Chevrolet	1992-2002	28
Camaro	189 CID (3.1L) Chevrolet	1990-1992	41	Cavalier	134 CID (2.2L) LM3 Chevrolet	1990-1991	26
Camaro	207 CID (3.4L) L32 Chevrolet	1993-1995	47	Cavalier	138 CID (2.3L) DOHC Oldsmobile	1995	29
Camaro	229 CID (3.8L) LC3 Chevrolet	1980-1984	55	Cavalier	146 CID (2.4L) LD9 DOHC Oldsmobile	1996-2002	34
Camaro	230 CID (3.8L) Chevrolet	1967-1970	56	Cavalier	173 CID (2.8L) Chevrolet	1985-1989	39
Camaro	231 CID (3.8L) Fuel Injected Buick	1995-2002	59	Cavalier	189 CID (3.1L) Chevrolet	1990-1994	41
Camaro	231 CID (3.8L) Carbureted Buick	1978-1987	58	Celebrity	151 CID (2.5L) Fuel Injected Pontiac	1982-1990	36
Camaro	250 CID (4.1L) Chevrolet	1967-1979	65	Celebrity	151 CID (2.5L) Carbureted Pontiac	1982-1983	35
Camaro	267 CID (4.4L) L39 Chevrolet	1979-1982	77	Celebrity	173 CID (2.8L) Chevrolet	1982-1989	39
Camaro	283 CID (4.6L) Chevrolet	1967	81	Celebrity	189 CID (3.1L) Chevrolet	1990	41
Camaro	302 CID (5.0L) Chevrolet	1967-1969	85	Celebrity	260 CID (4.3L) Oldsmobile Diesel	1982-1985	69
Camaro	305 CID (5.0L) Chevrolet	1976-1993	86	Centurion	350 CID (5.7L) Buick	1971	98
Camaro	307 CID (5.0L) Chevrolet	1968-1973	87	Centurion	455 CID (7.5L) Buick	1971-1973	130
Camaro	327 CID (5.4L) Chevrolet	1967-1969	91	Century	134 CID (2.2L) OHV Chevrolet	1993-1996	28
Camaro	346 CID (5.7L) LS1 Chevrolet	1998-2002	95	Century	151 CID (2.5L) Fuel Injected Pontiac	1982-1992	36
Camaro	350 CID (5.7L) Fuel Injected Chevrolet	1987-1997	100	Century	151 CID (2.5L) Carbureted Pontiac	1982-1983	35
Camaro	350 CID (5.7L) Carbureted Chevrolet	1967-1981	99	Century	173 CID (2.8L) Chevrolet	1982-1989	39
Camaro	396 CID (6.6L) Chevrolet	1967-1970	111	Century	181 CID (3.0L) Buick	1982-1985	40
Camaro	402 CID (6.6L) Chevrolet	1970-1972	118	Century	189 CID (3.1L) Chevrolet	1994-2004	41
Camaro	427 CID (7.0L) Chevrolet	1967-1969	125	Century	196 CID (3.2L) LC9 Buick	1978-1979	44
Caprice	229 CID (3.8L) LC3 Chevrolet	1980-1984	55	Century	204 CID (3.3L) LG7 Buick	1989-1993	46
Caprice	231 CID (3.8L) Carbureted Buick	1980-1981	58	Century	231 CID (3.8L) Fuel Injected Buick	1984-1988	59
Caprice	250 CID (4.1L) Chevrolet	1976-1979	65				
Caprice	262 CID (4.3L) Chevrolet	1985-1993	72				
Caprice	265 CID (4.3L) L99 Chevrolet	1994-1996	75				
Caprice	267 CID (4.4L) L39 Chevrolet	1980-1982	77				

Model Index (cont.)

Model	Engine	Year	Block	Model	Engine	Year	Block
Century	231 CID (3.8L) Turbo Buick	1978-1981	61	Commercial Chassis	500 CID (8.2L) Cadillac	1976	134
Century	231 CID (3.8L) Carbureted Buick	1975-1981	58	Corsica	121 CID (2.0L) LL8 Chevrolet	1987-1988	21
Century	252 CID (4.1L) LC4 Buick	1984	67	Corsica	134 CID (2.2L) OHV Chevrolet	1992-1996	28
Century	260 CID (4.3L) Oldsmobile Diesel	1982-1985	69	Corsica	134 CID (2.2L) LM3 Chevrolet	1990	26
Century	265 CID (4.3L) LS5 Pontiac	1980-1981	76	Corsica	138 CID (2.3L) DOHC Oldsmobile	1989-1993	29
Century	267 CID (4.4L) L39 Chevrolet	1981	77	Corsica	173 CID (2.8L) Chevrolet	1987-1988	39
Century	301 CID (4.9L) Pontiac	1978-1981	84	Corsica	189 CID (3.1L) Chevrolet	1990-1996	41
Century	305 CID (5.0L) Chevrolet	1977-1981	86	Corvair	140 CID (2.3L) Chevrolet	1960-1961	32
Century	322 CID (5.3L) Buick	1954-1956	89	Corvair	145 CID (2.4L) Chevrolet	1961-1963	33
Century	350 CID (5.7L) Oldsmobile Diesel	1981	103	Corvair	164 CID (2.7L) Chevrolet	1963-1969	38
Century	350 CID (5.7L) Carbureted Chevrolet	1977-1979	99	Corvette	235 CID (3.9L) Corvette Chevrolet	1953-1955	63
Century	350 CID (5.7L) Buick	1973-1977	98	Corvette	265 CID (4.3L) Chevrolet	1955-1956	74
Century	350 CID (5.7L) Oldsmobile	1977-1979	102	Corvette	283 CID (4.6L) Chevrolet	1957-1961	81
Century	364 CID (6.0L) Buick	1957-1958	105	Corvette	305 CID (5.0L) Chevrolet	1979-1981	86
Century	403 CID (6.6L) L80 Oldsmobile	1977-1979	119	Corvette	327 CID (5.4L) Chevrolet	1962-1968	91
Century	455 CID (7.5L) Buick	1973-1974	130	Corvette	346 CID (5.7L) LS6 Chevrolet	2001-2004	96
Chevelle	194 CID (3.2L) Chevrolet	1964-1966	42	Corvette	346 CID (5.7L) LS1 Chevrolet	1997-2004	95
Chevelle	230 CID (3.8L) Chevrolet	1964-1969	56	Corvette	350 CID (5.7L) LT5 DOHC Chevrolet	1990-1995	101
Chevelle	250 CID (4.1L) Chevrolet	1967-1977	65	Corvette	350 CID (5.7L) Fuel Injected Chevrolet	1982-1996	100
Chevelle	283 CID (4.6L) Chevrolet	1964-1967	81	Corvette	350 CID (5.7L) Carbureted Chevrolet	1969-1980	99
Chevelle	305 CID (5.0L) Chevrolet	1976	86	Corvette	396 CID (6.6L) Chevrolet	1965	111
Chevelle	307 CID (5.0L) Chevrolet	1968-1973	87	Corvette	427 CID (7.0L) Chevrolet	1966-1969	125
Chevelle	327 CID (5.4L) Chevrolet	1964-1968	91	Corvette	454 CID (7.4L) Chevrolet	1970-1975	129
Chevelle	350 CID (5.7L) Carbureted Chevrolet	1969-1977	99	Coupe DeVille	350 CID (5.7L) Oldsmobile Diesel	1978-1979	103
Chevelle	396 CID (6.6L) Chevrolet	1965-1971	111	Coupe DeVille	425 CID (7.0L) Cadillac	1978-1979	123
Chevelle	400 CID (6.6L) Chevrolet	1971-1976	113	Custom Cruiser	305 CID (5.0L) Chevrolet	1991-1992	86
Chevelle	402 CID (6.6L) Chevrolet	1970-1972	118	Custom Cruiser	307 CID (5.0L) Oldsmobile	1980-1990	88
Chevelle	454 CID (7.4L) Chevrolet	1970-1975	129	Custom Cruiser	350 CID (5.7L) Fuel Injected Chevrolet	1992	100
Chevette	85 CID (1.4L) LX3 Chevrolet	1976-1977	6	Custom Cruiser Diesel	350 CID (5.7L) Oldsmobile	1978-1985	103
Chevette	98 CID (1.6L) Chevrolet	1976-1987	8	Custom Cruiser	350 CID (5.7L) Oldsmobile	1977-1980	102
Chevette	111 CID (1.8L) LJ5 SOHC Isuzu Diesel	1981-1986	19	Custom Cruiser	403 CID (6.6L) L80 Oldsmobile	1977-1979	119
Chevy II	153 CID (2.5L) Chevrolet	1962-1968	37	Custom Cruiser	455 CID (7.5L) Oldsmobile	1971-1976	131
Chevy II	194 CID (3.2L) Chevrolet	1962-1966	42	Cutlass	134 CID (2.2L) OHV Chevrolet	1993	28
Chevy II	230 CID (3.8L) Chevrolet	1964-1968	56	Cutlass	151 CID (2.5L) Fuel Injected Pontiac	1987-1992	36
Chevy II	250 CID (4.1L) Chevrolet	1967-1968	65	Cutlass	173 CID (2.8L) Chevrolet	1987-1989	39
Chevy II	283 CID (4.6L) Chevrolet	1962-1966	81	Cutlass	189 CID (3.1L) Chevrolet	1994-1999	41
Chevy II	307 CID (5.0L) Chevrolet	1968	87	Cutlass	204 CID (3.3L) LG7 Buick	1989-1993	46
Chevy II	327 CID (5.4L) Chevrolet	1962-1968	91	Cutlass	231 CID (3.8L) Fuel Injected Buick	1987-1988	59
Chieftain	370 CID (6.1L) Pontiac	1958	108	Cutlass	231 CID (3.8L) Carbureted Buick	1977-1984	58
Cimarron	112 CID (1.8L) L46 Chevrolet	1982	20	Cutlass	250 CID (4.1L) Chevrolet	1967-1976	65
Cimarron	121 CID (2.0L) LQ5 Chevrolet	1983-1986	22	Cutlass	260 CID (4.3L) Oldsmobile Diesel	1982-1984	69
Cimarron	121 CID (2.0L) LR9 Chevrolet	1983-1984	23	Cutlass	260 CID (4.3L) LF7 Oldsmobile Diesel	1979	70
Cimarron	173 CID (2.8L) Chevrolet	1985-1988	39	Cutlass	260 CID (4.3L) LV8 Oldsmobile	1975-1980	71
Citation	151 CID (2.5L) Fuel Injected Pontiac	1982	36	Cutlass	267 CID (4.4L) L39 Chevrolet	1979-1981	77
Citation	151 CID (2.5L) Carbureted Pontiac	1980-1982	35	Cutlass	305 CID (5.0L) Chevrolet	1978-1981	86
Citation	173 CID (2.8L) Chevrolet	1980-1983	39	Cutlass	307 CID (5.0L) Oldsmobile	1980-1984	88
Citation 2	151 CID (2.5L) Fuel Injected Pontiac	1984-1985	36				
Citation 2	173 CID (2.8L) Chevrolet	1984-1985	39				
Commercial Chassis	252 CID (4.1L) Cadillac	1985-1987	68				
Commercial Chassis	252 CID (4.1L) LC4 Buick	1981	67				
Commercial Chassis	273 CID (4.5L) Cadillac	1988-1989	78				
Commercial Chassis	300 CID (4.9L) L26 Cadillac	1991-1993	83				
Commercial Chassis	350 CID (5.7L) Oldsmobile	1976	102				
Commercial Chassis	368 CID (6.0L) Cadillac	1980-1984	107				
Commercial Chassis	425 CID (7.0L) Cadillac	1977-1979	123				

General Motors Corp.

Model Index (cont.)

Model	Engine	Year	Block	Model	Engine	Year	Block	
Cutlass	330 CID (5.4L) OHV Oldsmobile	1967	92	Cutlass Supreme	403 CID (6.6L) L80 Oldsmobile	1977	119	
Cutlass	350 CID (5.7L) Oldsmobile Diesel	1978-1984	103	Cutlass Supreme	455 CID (7.5L) Oldsmobile	1970-1976	131	
Cutlass	350 CID (5.7L) Carbureted Chevrolet	1978-1979	99	DeVille	252 CID (4.1L) Cadillac	1982-1987	68	
Cutlass	350 CID (5.7L) Oldsmobile	1968-1980	102	DeVille	252 CID (4.1L) LC4 Buick	1980-1983	67	
Cutlass	403 CID (6.6L) L80 Oldsmobile	1977	119	DeVille	260 CID (4.3L) Oldsmobile Diesel	1985	69	
Cutlass	455 CID (7.5L) Oldsmobile	1970-1976	131	DeVille	273 CID (4.5L) Cadillac	1988-1989	78	
Cutlass 'S'	231 CID (3.8L) Carbureted Buick	1977	58	DeVille	281 CID (4.6L) L37 Cadillac	1993-2004	79	
Cutlass 'S'	250 CID (4.1L) Chevrolet	1968-1976	65	DeVille	281 CID (4.6L) LD8 Cadillac	1993-2004	80	
Cutlass 'S'	260 CID (4.3L) LV8 Oldsmobile	1975-1977	71	DeVille	300 CID (4.9L) L26 Cadillac	1991-1995	83	
Cutlass 'S'	350 CID (5.7L) Oldsmobile	1968-1977	102	DeVille	350 CID (5.7L) Oldsmobile Diesel	1980-1985	103	
Cutlass 'S'	403 CID (6.6L) L80 Oldsmobile	1977	119	DeVille	350 CID (5.7L) Oldsmobile	1976-1977	102	
Cutlass 'S'	455 CID (7.5L) Oldsmobile	1972-1976	131	DeVille	368 CID (6.0L) Cadillac	1980-1981	107	
Cutlass Ciera	134 CID (2.2L) OHV Chevrolet	1993-1996	28	DeVille	425 CID (7.0L) Cadillac	1977	123	
Cutlass Ciera	151 CID (2.5L) Fuel Injected Pontiac	1982-1992	36	DeVille	500 CID (8.2L) Cadillac	1976	134	
Cutlass Ciera	173 CID (2.8L) Chevrolet	1986-1989	39	Del Ray	235 CID (3.9L) Chevrolet	1958	62	
Cutlass Ciera	181 CID (3.0L) Buick	1982-1985	40	Del Ray	283 CID (4.6L) Chevrolet	1958	81	
Cutlass Ciera	189 CID (3.1L) Chevrolet	1994-1996	41	Del Ray	348 CID (5.7L) Chevrolet	1958	97	
Cutlass Ciera	204 CID (3.3L) LG7 Buick	1989-1993	46	Delmont	350 CID (5.7L) Oldsmobile	1968	102	
Cutlass Ciera	231 CID (3.8L) Fuel Injected Buick	1984-1988	59	Eighty-Eight Delmont	455 CID (7.5L) Oldsmobile	1968	131	
Cutlass Ciera	260 CID (4.3L) Oldsmobile Diesel	1982-1985	69	Eighty-Eight Delmont	330 CID (5.4L) OHV Oldsmobile	1967	92	
Cutlass Salon	231 CID (3.8L) Carbureted Buick	1978-1980	58	Eighty-Eight '330' Delmont	425 CID (7.0L) Oldsmobile	1967	124	
Cutlass Salon	260 CID (4.3L) LF7 Oldsmobile Diesel	1979	70	Eighth-Eight '425' Delta 88	231 CID (3.8L) Carbureted Buick	1977-1983	58	
Cutlass Salon	260 CID (4.3L) LV8 Oldsmobile	1975-1980	71	Delta 88	260 CID (4.3L) LV8 Oldsmobile	1977-1979	71	
Cutlass Salon	305 CID (5.0L) Chevrolet	1978-1980	86	Delta 88	265 CID (4.3L) LS5 Pontiac	1980	76	
Cutlass Salon	350 CID (5.7L) Oldsmobile Diesel	1980	103	Delta 88	301 CID (4.9L) Pontiac	1979	84	
Cutlass Salon	350 CID (5.7L) Oldsmobile	1975-1977	102	Delta 88	307 CID (5.0L) Oldsmobile	1980-1983	88	
Cutlass Salon	403 CID (6.6L) L80 Oldsmobile	1977	119	Delta 88	350 CID (5.7L) Oldsmobile Diesel	1978-1983	103	
Cutlass Salon	455 CID (7.5L) Oldsmobile	1975	131	Delta 88	350 CID (5.7L) Oldsmobile	1969-1979	102	
Cutlass Supreme	138 CID (2.3L) DOHC Oldsmobile	1990-1991	29	Delta 88	403 CID (6.6L) L80 Oldsmobile	1977-1978	119	
Cutlass Supreme	173 CID (2.8L) Chevrolet	1988-1989	39	Delta 88	425 CID (7.0L) Oldsmobile	1965-1967	124	
Cutlass Supreme	189 CID (3.1L) Chevrolet	1989-1997	41	Delta 88	455 CID (7.5L) Oldsmobile	1968-1976	131	
Cutlass Supreme	207 CID (3.4L) LQ1 DOHC Chevrolet	1991-1995	49	Delta 88	181 CID (3.0L) Buick	1985-1988	40	
Cutlass Supreme	231 CID (3.8L) Carbureted Buick	1977-1987	58	Royale	Delta 88	231 CID (3.8L) Fuel Injected Buick	1986-1988	59
Cutlass Supreme	250 CID (4.1L) Chevrolet	1975	65	Royale	Delta 88	231 CID (3.8L) Carbureted Buick	1977-1987	58
Cutlass Supreme	260 CID (4.3L) Oldsmobile Diesel	1982-1984	69	Royale	Delta 88	260 CID (4.3L) LV8 Oldsmobile	1977-1979	71
Cutlass Supreme	260 CID (4.3L) LF7 Oldsmobile Diesel	1979	70	Royale	Delta 88	265 CID (4.3L) LS5 Pontiac	1980	76
Cutlass Supreme	260 CID (4.3L) LV8 Oldsmobile	1976-1981	71	Royale	Delta 88	301 CID (4.9L) Pontiac	1979	84
Cutlass Supreme	305 CID (5.0L) Chevrolet	1978-1980	86	Royale	Delta 88	307 CID (5.0L) Oldsmobile	1980-1988	88
Cutlass Supreme	307 CID (5.0L) Oldsmobile	1982-1988	88	Royale	Delta 88	350 CID (5.7L) Oldsmobile Diesel	1978-1985	103
Cutlass Supreme	330 CID (5.4L) OHV Oldsmobile	1964-1967	92	Royale	Delta 88	350 CID (5.7L) Oldsmobile	1970-1980	102
Cutlass Supreme	350 CID (5.7L) Oldsmobile Diesel	1980-1985	103	Royale	Delta 88	403 CID (6.6L) L80 Oldsmobile	1977-1978	119
Cutlass Supreme	350 CID (5.7L) Oldsmobile	1968-1977	102	Royale	Delta 88	455 CID (7.5L) Oldsmobile	1969-1976	131
Cutlass Supreme	400 CID (6.6L) Oldsmobile	1968	114	Deluxe	216 CID (3.5L) Chevrolet	1949-1952	53	
Cutlass Supreme	400 CID (6.6L) Oldsmobile	1967	115	Deluxe	235 CID (3.9L) Chevrolet	1950-1952	62	
				Deluxe 210	235 CID (3.9L) Chevrolet	1953-1957	62	
				Deluxe 210	265 CID (4.3L) Chevrolet	1955-1957	74	
				Deluxe 210	283 CID (4.6L) Chevrolet	1957	81	

General Motors Corp.

Model Index (cont.)

Model	Engine	Year	Block	Model	Engine	Year	Block
Dynamic 88	425 CID (7.0L) Oldsmobile	1965-1966	124	F-85	330 CID (5.4L) OHV Oldsmobile	1964-1967	92
Eldorado	252 CID (4.1L) Cadillac	1982-1987	68	F-85	350 CID (5.7L) Oldsmobile	1968-1972	102
Eldorado	252 CID (4.1L) LC4 Buick	1981-1983	67	F-85	400 CID (6.6L) Oldsmobile	1965-1966	115
Eldorado	273 CID (4.5L) Cadillac	1988-1989	78	Fiero	151 CID (2.5L) Fuel Injected	1984-1988	36
Eldorado	281 CID (4.6L) L37 Cadillac	1993-2002	79	Pontiac			
Eldorado	281 CID (4.6L) LD8 Cadillac	1993-2002	80	Fiero	173 CID (2.8L) Chevrolet	1985-1988	39
Eldorado	300 CID (4.9L) L26 Cadillac	1991-1993	83	Firebird	151 CID (2.5L) Fuel Injected	1982-1986	36
Eldorado	305 CID (5.0L) Chevrolet	1984	86	Pontiac			
Eldorado	350 CID (5.7L) Oldsmobile	1979-1985	103	Firebird	151 CID (2.5L) Carbureted	1982-1983	35
	Diesel			Pontiac			
Eldorado	350 CID (5.7L) Oldsmobile	1976-1977	102	Firebird	173 CID (2.8L) Chevrolet	1982-1989	39
Eldorado	368 CID (6.0L) Cadillac	1980-1981	107	Firebird	189 CID (3.1L) Chevrolet	1990-1992	41
Eldorado	425 CID (7.0L) Cadillac	1977-1979	123	Firebird	207 CID (3.4L) L32 Chevrolet	1993-1995	47
Eldorado	429 CID (7.0L) Cadillac	1967	127	Firebird	230 CID (3.8L) OHC Pontiac	1967	57
Eldorado	472 CID (7.7L) Cadillac	1968-1969	133	Firebird	231 CID (3.8L) Fuel Injected	1995-2002	59
Eldorado	500 CID (8.2L) Cadillac	1970-1976	134	Pontiac			
Eldorado	331 CID (5.4L) OHV Cadillac	1953-1954	93	Firebird	231 CID (3.8L) Turbo Buick	1988-1989	61
Special				Firebird	231 CID (3.8L) Carbureted	1977-1981	58
Eldorado	365 CID (6.0L) Cadillac	1956-1957	106	Pontiac			
Special				Firebird	250 CID (4.1L) OHC Pontiac	1968-1969	66
Eldorado	390 CID (6.4L) Cadillac	1959-1963	110	Firebird	250 CID (4.1L) Chevrolet	1971-1976	65
Special				Firebird	265 CID (4.3L) LS5 Pontiac	1980-1981	76
Eldorado	429 CID (7.0L) Cadillac	1964	127	Firebird	301 CID (4.9L) Pontiac	1977-1981	84
Special				Firebird	305 CID (5.0L) Chevrolet	1977-1992	86
Electra	181 CID (3.0L) Buick	1982-1985	40	Firebird	326 CID (5.3L) Pontiac	1967	90
Electra	231 CID (3.8L) Fuel Injected	1985-1990	59	Firebird	346 CID (5.7L) LS1 Chevrolet	1998-2002	95
	Buick			Firebird	350 CID (5.7L) Fuel Injected	1987-1997	100
Electra	231 CID (3.8L) Carbureted	1979	58	Firebird	Chevrolet		
	Buick			Firebird	350 CID (5.7L) Carbureted	1978-1979	99
Electra	252 CID (4.1L) LC4 Buick	1980-1984	67	Firebird	Chevrolet		
Electra	260 CID (4.3L) Oldsmobile	1985	69	Firebird	350 CID (5.7L) Pontiac	1968-1977	104
	Diesel			Firebird	350 CID (5.7L) Oldsmobile	1977	102
Electra	307 CID (5.0L) Oldsmobile	1980-1984	88	Firebird	400 CID (6.6L) Pontiac	1967-1979	116
Electra	350 CID (5.7L) Oldsmobile	1980-1984	103	Firebird	403 CID (6.6L) L80 Oldsmobile	1977-1979	119
	Diesel			Firebird	455 CID (7.5L) Pontiac	1971-1975	132
Electra	350 CID (5.7L) Buick	1976-1980	98	Firefly	61 CID (1.0L) LP2 Suzuki	1989-1991	1
Electra	350 CID (5.7L) Oldsmobile	1977-1980	102	Firefly	61 CID (1.0L) LY9 Suzuki	1985-1988	3
Electra	400 CID (6.6L) Pontiac	1978	116	Firefly	79 CID (1.3L) LY8 Suzuki	1998-2000	5
Electra	403 CID (6.6L) L80 Oldsmobile	1977-1979	119	Firefly	79 CID (1.3L) L72 SOHC	1995-1997	4
Electra 225	401 CID (6.6L) Buick	1959-1964	117				
Electra 225	425 CID (7.0L) Buick	1965	122	Firenza	110 CID (1.8L) LH8 OHC	1982-1986	18
Electra 225	430 CID (7.0L) Buick	1967-1969	128				
Electra 225	455 CID (7.5L) Buick	1970-1976	130	Firenza	112 CID (1.8L) L46 Chevrolet	1982	20
Electra	301 CID (4.9L) Pontiac	1980	84	Firenza	121 CID (2.0L) LL8 Chevrolet	1987-1988	21
Estate				Firenza	121 CID (2.0L) LQ5 Chevrolet	1983-1986	22
Wagon				Firenza	121 CID (2.0L) LR9 Chevrolet	1983-1984	23
Electra	307 CID (5.0L) Oldsmobile	1981-1989	88	Firenza	122 CID (2.0L) OHC Pontiac	1987-1988	24
Estate				Firenza	173 CID (2.8L) Chevrolet	1985-1987	39
Wagon				Fleetline	216 CID (3.5L) Chevrolet	1941	53
Electra	350 CID (5.7L) Oldsmobile	1980-1985	103	Fleetmaster	216 CID (3.5L) Chevrolet	1942	53
Estate	Diesel			Fleetwood	252 CID (4.1L) Cadillac	1982-1987	68
Wagon				Fleetwood	252 CID (4.1L) LC4 Buick	1980-1983	67
Electra	350 CID (5.7L) Buick	1980	98	Fleetwood	260 CID (4.3L) Oldsmobile	1985	69
Estate					Diesel		
Wagon				Fleetwood	273 CID (4.5L) Cadillac	1988-1989	78
Electra	350 CID (5.7L) Oldsmobile	1980	102	Fleetwood	300 CID (4.9L) L26 Cadillac	1991-1993	83
Estate				Fleetwood	305 CID (5.0L) Chevrolet	1991-1992	86
Wagon				Fleetwood	307 CID (5.0L) Oldsmobile	1986-1990	88
Estate	350 CID (5.7L) Buick	1977-1979	98	Fleetwood	350 CID (5.7L) Fuel Injected	1990-1996	100
Wagon					Chevrolet		
Estate	350 CID (5.7L) Oldsmobile	1977-1979	102	Fleetwood	350 CID (5.7L) Oldsmobile	1979-1985	103
Wagon					Diesel		
Estate	403 CID (6.6L) L80 Oldsmobile	1977-1979	119	Fleetwood	350 CID (5.7L) Oldsmobile	1976-1977	102
Wagon				Fleetwood	368 CID (6.0L) Cadillac	1980-1985	107
Estate	455 CID (7.5L) Buick	1970-1976	130	Fleetwood	425 CID (7.0L) Cadillac	1977-1979	123
Wagon				Fleetwood	429 CID (7.0L) Cadillac	1965-1966	127
Executive	350 CID (5.7L) Pontiac	1970	104	Fleetwood	500 CID (8.2L) Cadillac	1976	134
Executive	400 CID (6.6L) Pontiac	1967-1970	116	Fleetwood 75	331 CID (5.4L) OHV Cadillac	1949-1955	93
Executive	428 CID (7.0L) Pontiac	1967-1969	126	Fleetwood 75	350 CID (5.7L) Oldsmobile	1976-1977	102
Executive	455 CID (7.5L) Pontiac	1970	132	Fleetwood 75	365 CID (6.0L) Cadillac	1956-1958	106
F-85	225 CID (3.7L) Buick	1964-1965	54				
F-85	250 CID (4.1L) Chevrolet	1966-1970	65				

General Motors Corp.

Model Index (cont.)

Model	Engine	Year	Block	Model	Engine	Year	Block
Fleetwood 75	368 CID (6.0L) Cadillac	1980-1983	107	Grandville	400 CID (6.6L) Pontiac	1975	116
Fleetwood 75	390 CID (6.4L) Cadillac	1959-1963	110	Grandville	455 CID (7.5L) Pontiac	1971-1974	132
Fleetwood 75	425 CID (7.0L) Cadillac	1977-1979	123	Impala	207 CID (3.4L) LA1 Chevrolet	2000-2004	48
Fleetwood 75	429 CID (7.0L) Cadillac	1964-1967	127	Impala	229 CID (3.8L) LC3 Chevrolet	1980-1984	55
Fleetwood 75	472 CID (7.7L) Cadillac	1968-1974	133	Impala	230 CID (3.8L) Chevrolet	1964-1965	56
Fleetwood 75	500 CID (8.2L) Cadillac	1975	134	Impala	231 CID (3.8L) Fuel Injected	2000-2004	59
Fleetwood Special	331 CID (5.4L) OHV Cadillac	1949-1955	93	Impala	Buick		
Fleetwood Special	365 CID (6.0L) Cadillac	1956-1958	106	Impala	231 CID (3.8L) Carbureted	1978-1985	58
Fleetwood Special	390 CID (6.4L) Cadillac	1959-1963	110	Impala	Buick		
Fleetwood Special	429 CID (7.0L) Cadillac	1964-1967	127	Impala	235 CID (3.9L) Chevrolet	1958-1963	62
Fleetwood Special	472 CID (7.7L) Cadillac	1968-1974	133	Impala	250 CID (4.1L) Chevrolet	1965-1979	65
Fleetwood Special	500 CID (8.2L) Cadillac	1975	134	Impala	262 CID (4.3L) Chevrolet	1985	72
GTO	400 CID (6.6L) Pontiac	1967-1970	116	Impala	267 CID (4.4L) L39 Chevrolet	1979-1982	77
GTO	455 CID (7.5L) Pontiac	1970	132	Impala	283 CID (4.6L) Chevrolet	1958-1967	81
Gran Sport	350 CID (5.7L) Buick	1970-1971	98	Impala	305 CID (5.0L) Chevrolet	1977-1985	86
Gran Sport 455	455 CID (7.5L) Buick	1970-1972	130	Impala	307 CID (5.0L) Chevrolet	1968	87
Grand Am	122 CID (2.0L) OHC Turbo Pontiac	1987-1989	25	Impala	327 CID (5.4L) Chevrolet	1962-1968	91
Grand Am	138 CID (2.3L) L40 SOHC Oldsmobile	1992-1994	30	Impala	348 CID (5.7L) Chevrolet	1958-1961	97
Grand Am	138 CID (2.3L) DOHC Oldsmobile	1988-1995	29	Impala	350 CID (5.7L) Fuel Injected Chevrolet	1994-1996	100
Grand Am	146 CID (2.4L) LD9 DOHC Oldsmobile	1996-2001	34	Impala	350 CID (5.7L) Oldsmobile Diesel	1978-1985	103
Grand Am	151 CID (2.5L) Fuel Injected Pontiac	1985-1991	36	Impala	350 CID (5.7L) Carbureted Chevrolet	1969-1985	99
Grand Am	181 CID (3.0L) Buick	1985-1987	40	Impala	396 CID (6.6L) Chevrolet	1965-1968	111
Grand Am	189 CID (3.1L) Chevrolet	1994-1998	41	Impala	400 CID (6.6L) Chevrolet	1970-1976	113
Grand Am	204 CID (3.3L) LG7 Buick	1992-1993	46	Impala	402 CID (6.6L) Chevrolet	1970-1972	118
Grand Am	207 CID (3.4L) LA1 Chevrolet	1999-2004	48	Impala	409 CID (6.7L) Chevrolet	1961-1965	120
Grand Am	231 CID (3.8L) Carbureted Buick	1979	58	Impala	427 CID (7.0L) Chevrolet	1966-1969	125
Grand Am	301 CID (4.9L) Pontiac	1978-1980	84	Impala	454 CID (7.4L) Chevrolet	1970-1975	129
Grand Am	305 CID (5.0L) Chevrolet	1978-1980	86	Intrigue	212 CID (3.5L) LX5 Oldsmobile	1999-2002	50
Grand Am	400 CID (6.6L) Pontiac	1973	116	Intrigue	231 CID (3.8L) Fuel Injected Buick	1998-1999	59
Grand Am	455 CID (7.5L) Pontiac	1973-1974	132	Invicta	401 CID (6.6L) Buick	1959-1963	117
Grand Prix	138 CID (2.3L) DOHC Oldsmobile	1990-1991	29	J2000	110 CID (1.8L) LH8 OHC Pontiac	1982-1983	18
Grand Prix	173 CID (2.8L) Chevrolet	1988-1989	39	J2000	112 CID (1.8L) L46 Chevrolet	1982	20
Grand Prix	189 CID (3.1L) Chevrolet	1989-2003	41	J2000	121 CID (2.0L) LQ5 Chevrolet	1983	22
Grand Prix	207 CID (3.4L) LQ1 DOHC Chevrolet	1991-1996	49	Jetstar 1	425 CID (7.0L) Oldsmobile	1965-1966	124
Grand Prix	231 CID (3.8L) Supercharged Buick	1997-2003	60	Jetstar 88	330 CID (5.4L) OHV Oldsmobile	1964-1966	92
Grand Prix	231 CID (3.8L) Fuel Injected Buick	1997-2003	59	LSS	231 CID (3.8L) Supercharged Buick	1996-1999	60
Grand Prix	231 CID (3.8L) Carbureted Buick	1978-1987	58	LSS	231 CID (3.8L) Fuel Injected Buick	1996-1999	59
Grand Prix	252 CID (4.1L) LC4 Buick	1982	67	Laurentian	229 CID (3.8L) LC3 Chevrolet	1980	55
Grand Prix	262 CID (4.3L) Chevrolet	1986-1987	72	Laurentian	231 CID (3.8L) Carbureted Buick	1981	58
Grand Prix	265 CID (4.3L) LS5 Pontiac	1980-1981	76	Laurentian	250 CID (4.1L) Chevrolet	1971-1979	65
Grand Prix	301 CID (4.9L) Pontiac	1977-1980	84	Laurentian	265 CID (4.3L) LS5 Pontiac	1981	76
Grand Prix	305 CID (5.0L) Chevrolet	1978-1987	86	Laurentian	267 CID (4.4L) L39 Chevrolet	1980-1981	77
Grand Prix	350 CID (5.7L) Oldsmobile Diesel	1981-1984	103	Laurentian	305 CID (5.0L) Chevrolet	1977-1981	86
Grand Prix	350 CID (5.7L) Pontiac	1976-1977	104	Laurentian	307 CID (5.0L) Oldsmobile	1981	88
Grand Prix	350 CID (5.7L) Oldsmobile	1977	102	Laurentian	350 CID (5.7L) Oldsmobile Diesel	1980-1981	103
Grand Prix	389 CID (6.4L) Pontiac	1982-1966	109	Laurentian	350 CID (5.7L) Carbureted Chevrolet	1976	99
Grand Prix	400 CID (6.6L) Chevrolet	1976	113	Le Sabre	181 CID (3.0L) Buick	1986	40
Grand Prix	400 CID (6.6L) Pontiac	1967-1976	116	Le Sabre	231 CID (3.8L) Fuel Injected Buick	1986-2004	59
Grand Prix	403 CID (6.6L) L80 Oldsmobile	1977	119	Le Sabre	231 CID (3.8L) Turbo Buick	1978-1981	61
Grand Prix	421 CID (6.9L) Pontiac	1963-1965	121	Le Sabre	231 CID (3.8L) Carbureted Buick	1976-1985	58
Grand Prix	428 CID (7.0L) Pontiac	1967-1969	126	Le Sabre	252 CID (4.1L) LC4 Buick	1980-1984	67
Grand Prix	455 CID (7.5L) Pontiac	1970-1975	132	Le Sabre	267 CID (4.4L) L39 Chevrolet	1981-1982	77
				Le Sabre	300 CID (4.9L) Buick	1964-1965	82

General Motors Corp.

Model Index (cont.)

Model	Engine	Year	Block	Model	Engine	Year	Block
Le Sabre	301 CID (4.9L) Pontiac	1977-1981	84	Monte Carlo	207 CID (3.4L) LA1 Chevrolet	2000-2004	48
Le Sabre	305 CID (5.0L) Chevrolet	1977-1978	86	Monte Carlo	207 CID (3.4L) LQ1 DOHC Chevrolet	1995-1997	49
Le Sabre	307 CID (5.0L) Oldsmobile	1981-1990	88	Monte Carlo	229 CID (3.8L) LC3 Chevrolet	1980-1984	55
Le Sabre	340 CID (5.6L) Buick	1966-1967	94	Monte Carlo	231 CID (3.8L) Fuel Injected Buick	1998-2004	59
Le Sabre	350 CID (5.7L) Oldsmobile Diesel	1980-1985	103	Monte Carlo	231 CID (3.8L) Turbo Buick	1978-1982	61
Le Sabre	350 CID (5.7L) Carbureted Chevrolet	1978	99	Monte Carlo	231 CID (3.8L) Carbureted Buick	1978-1981	58
Le Sabre	350 CID (5.7L) Buick	1968-1980	98	Monte Carlo	260 CID (4.3L) Oldsmobile Diesel	1982-1985	69
Le Sabre	350 CID (5.7L) Oldsmobile	1977-1980	102	Monte Carlo	262 CID (4.3L) Chevrolet	1985-1988	72
Le Sabre	364 CID (6.0L) Buick	1959-1961	105	Monte Carlo	267 CID (4.4L) L39 Chevrolet	1979-1982	77
Le Sabre	400 CID (6.6L) Pontiac	1978	116	Monte Carlo	305 CID (5.0L) Chevrolet	1976-1988	86
Le Sabre	401 CID (6.6L) Buick	1962-1964	117	Monte Carlo	307 CID (5.0L) Oldsmobile	1980-1986	88
Le Sabre	403 CID (6.6L) L80 Oldsmobile	1977-1979	119	Monte Carlo	350 CID (5.7L) Oldsmobile Diesel	1978-1985	103
Le Sabre	425 CID (7.0L) Buick	1964	122	Monte Carlo	350 CID (5.7L) Carbureted Chevrolet	1970-1977	99
Le Sabre	455 CID (7.5L) Buick	1970-1976	130	Monte Carlo	400 CID (6.6L) Chevrolet	1970-1976	113
LeMans	98 CID (1.6L) L73 Daewoo	1988-1993	9	Monte Carlo	402 CID (6.6L) Chevrolet	1970-1971	118
LeMans	122 CID (2.0L) OHC Pontiac	1989-1990	24	Monte Carlo	454 CID (7.4L) Chevrolet	1970-1975	129
LeMans	229 CID (3.8L) LC3 Chevrolet	1980	55	Monza	140 CID (2.3L) Chevrolet	1975-1977	31
LeMans	231 CID (3.8L) Carbureted Buick	1977-1981	58	Monza	151 CID (2.5L) Carbureted Pontiac	1978-1980	35
LeMans	250 CID (4.1L) Chevrolet	1970-1976	65	Monza	196 CID (3.2L) LC9 Buick	1978-1979	44
LeMans	260 CID (4.3L) LV8 Oldsmobile	1976	71	Monza	231 CID (3.8L) Carbureted Buick	1978-1980	58
LeMans	265 CID (4.3L) LS5 Pontiac	1980-1981	76	Monza	262 CID (4.3L) Chevrolet	1975-1976	73
LeMans	301 CID (4.9L) Pontiac	1977-1981	84	Monza	305 CID (5.0L) Chevrolet	1976-1978	86
LeMans	305 CID (5.0L) Chevrolet	1978-1981	86	Monza	350 CID (5.7L) Carbureted Chevrolet	1975-1980	99
LeMans	350 CID (5.7L) Carbureted Chevrolet	1978-1979	99	Ninety Eight	181 CID (3.0L) Buick	1985	40
LeMans	350 CID (5.7L) Buick	1974-1975	98	Ninety Eight	231 CID (3.8L) Supercharged Buick	1991-1995	60
LeMans	350 CID (5.7L) Pontiac	1970-1977	104	Ninety Eight	231 CID (3.8L) Fuel Injected Buick	1985-1996	59
LeMans	350 CID (5.7L) Oldsmobile	1977-1979	102	Ninety Eight	252 CID (4.1L) LC4 Buick	1981-1983	67
LeMans	400 CID (6.6L) Pontiac	1971-1976	116	Ninety Eight	260 CID (4.3L) Oldsmobile Diesel	1985	69
LeMans	403 CID (6.6L) L80 Oldsmobile	1977	119	Ninety Eight	307 CID (5.0L) Oldsmobile	1980-1990	88
LeMans	455 CID (7.5L) Pontiac	1971-1975	132	Ninety Eight	350 CID (5.7L) Oldsmobile Diesel	1978-1985	103
Limited	364 CID (6.0L) Buick	1958-1960	105	Ninety Eight	350 CID (5.7L) Oldsmobile	1976-1980	102
Lumina	134 CID (2.2L) OHV Chevrolet	1993	28	Ninety Eight	403 CID (6.6L) L80 Oldsmobile	1977-1979	119
Lumina	151 CID (2.5L) Fuel Injected Pontiac	1990-1992	36	Ninety Eight	425 CID (7.0L) Oldsmobile	1965-1967	124
Lumina	189 CID (3.1L) Chevrolet	1990-2001	41	Ninety Eight	455 CID (7.5L) Oldsmobile	1968-1975	131
Lumina	207 CID (3.4L) LQ1 DOHC Chevrolet	1991-1997	49	Nomad	235 CID (3.9L) Chevrolet	1955-1960	62
Lumina	231 CID (3.8L) Fuel Injected Buick	1995-1999	59	Nomad	265 CID (4.3L) Chevrolet	1955-1957	74
Malibu	146 CID (2.4L) LD9 DOHC Oldsmobile	1997-1999	34	Nomad	283 CID (4.6L) Chevrolet	1957-1961	81
Malibu	189 CID (3.1L) Chevrolet	1997-2003	41	Nomad	348 CID (5.7L) Chevrolet	1958-1961	97
Malibu	200 CID (3.3L) L26 Chevrolet	1978-1979	45	Nova	98 CID (1.6L) LW0 DOHC Toyota	1988	14
Malibu	229 CID (3.8L) LC3 Chevrolet	1980-1983	55	Nova	98 CID (1.6L) LC9 SOHC Toyota	1985-1988	12
Malibu	231 CID (3.8L) Carbureted Buick	1978-1981	58	Nova	153 CID (2.5L) Chevrolet	1969-1970	37
Malibu	260 CID (4.3L) Oldsmobile Diesel	1982-1983	69	Nova	230 CID (3.8L) Chevrolet	1969	56
Malibu	267 CID (4.4L) L39 Chevrolet	1979-1982	77	Nova	231 CID (3.8L) Carbureted Buick	1978-1979	58
Malibu	305 CID (5.0L) Chevrolet	1978-1983	86	Nova	250 CID (4.1L) Chevrolet	1969-1979	65
Malibu	350 CID (5.7L) Oldsmobile Diesel	1978-1983	103	Nova	262 CID (4.3L) Chevrolet	1975-1976	73
Malibu	350 CID (5.7L) Carbureted Chevrolet	1978-1979	99	Nova	305 CID (5.0L) Chevrolet	1976-1978	86
Master	216 CID (3.5L) Chevrolet	1937	53	Nova	307 CID (5.0L) Chevrolet	1969-1973	87
Master 85	216 CID (3.5L) Chevrolet	1939	53	Nova	350 CID (5.7L) Carbureted Chevrolet	1969-1977	99
Master Deluxe	216 CID (3.5L) Chevrolet	1937	53	Nova	396 CID (6.6L) Chevrolet	1969-1970	111
Metro	61 CID (1.0L) LP2 Suzuki	1989-2001	1	Omega	151 CID (2.5L) Fuel Injected Pontiac	1982-1984	36
Metro	61 CID (1.0L) LS3 Turbo Suzuki	1989-1991	2	Omega	151 CID (2.5L) Carbureted Pontiac	1980-1983	35
Metro	79 CID (1.3L) LY8 Suzuki	1998-2001	5	Omega	173 CID (2.8L) Chevrolet	1980-1984	39
Metro	79 CID (1.3L) L72 SOHC Suzuki	1992-1997	4				
Monte Carlo	189 CID (3.1L) Chevrolet	1995-1999	41				
Monte Carlo	200 CID (3.3L) L26 Chevrolet	1978-1979	45				

General Motors Corp.

Model Index (cont.)

Model	Engine	Year	Block	Model	Engine	Year	Block
Omega	231 CID (3.8L) Carbureted Buick	1977	58	Riviera	231 CID (3.8L) Fuel Injected Buick	1986-1997	59
Omega	250 CID (4.1L) Chevrolet	1973-1976	65	Riviera	231 CID (3.8L) Turbo Buick	1978-1985	61
Omega	260 CID (4.3L) LV8 Oldsmobile	1975-1977	71	Riviera	231 CID (3.8L) Carbureted Buick	1976-1986	58
Omega	305 CID (5.0L) Chevrolet	1977-1978	86	Riviera	252 CID (4.1L) LC4 Buick	1980-1983	67
Omega	350 CID (5.7L) Carbureted Chevrolet	1977-1979	99	Riviera	300 CID (4.9L) Buick	1965	82
Omega	350 CID (5.7L) Buick	1975-1977	98	Riviera	301 CID (4.9L) Pontiac	1977-1979	84
Parisienne	231 CID (3.8L) Carbureted Buick	1983-1984	58	Riviera	305 CID (5.0L) Chevrolet	1977-1978	86
Parisienne	262 CID (4.3L) Chevrolet	1985-1986	72	Riviera	307 CID (5.0L) Oldsmobile	1980-1985	88
Parisienne	305 CID (5.0L) Chevrolet	1983-1986	86	Riviera	350 CID (5.7L) Oldsmobile Diesel	1980-1985	103
Parisienne	307 CID (5.0L) Oldsmobile	1986	88	Riviera	350 CID (5.7L) Carbureted Chevrolet	1977-1979	99
Parisienne	350 CID (5.7L) Oldsmobile Diesel	1983-1985	103	Riviera	350 CID (5.7L) Buick	1976-1980	98
Park Avenue	231 CID (3.8L) Supercharged Buick	1991-2004	60	Riviera	350 CID (5.7L) Oldsmobile	1977-1980	102
Park Avenue	231 CID (3.8L) Fuel Injected Buick	1991-2004	59	Riviera	400 CID (6.6L) Pontiac	1978	116
Phoenix	151 CID (2.5L) Fuel Injected Pontiac	1982-1984	36	Riviera	401 CID (6.6L) Buick	1963	117
Phoenix	151 CID (2.5L) Carbureted Pontiac	1977-1983	35	Riviera	403 CID (6.6L) L80 Oldsmobile	1977-1979	119
Phoenix	173 CID (2.8L) Chevrolet	1980-1984	39	Riviera	425 CID (7.0L) Buick	1963-1966	122
Phoenix	231 CID (3.8L) Carbureted Buick	1977-1979	58	Riviera	430 CID (7.0L) Buick	1967-1969	128
Phoenix	305 CID (5.0L) Chevrolet	1977-1979	86	Riviera	455 CID (7.5L) Buick	1970-1976	130
Phoenix	350 CID (5.7L) Carbureted Chevrolet	1977-1979	99	Roadmaster	305 CID (5.0L) Chevrolet	1991-1993	86
Prizm	98 CID (1.6L) LO1 DOHC Toyota	1989-1997	13	Roadmaster	322 CID (5.3L) Buick	1953-1956	89
Prizm	98 CID (1.6L) LW0 DOHC Toyota	1990-1992	14	Roadmaster	350 CID (5.7L) Fuel Injected Chevrolet	1992-1996	100
Prizm	108 CID (1.8L) LV6 DOHC Toyota	1993-1999	15	Roadmaster	364 CID (6.0L) Buick	1957-1958	105
Reatta	231 CID (3.8L) Fuel Injected Buick	1988-1993	59	Safari	307 CID (5.0L) Oldsmobile	1987-1989	88
Regal	173 CID (2.8L) Chevrolet	1988-1989	39	Sedan	350 CID (5.7L) Oldsmobile Diesel	1978-1979	103
Regal	189 CID (3.1L) Chevrolet	1989-1998	41	Sedan	425 CID (7.0L) Cadillac DeVille	1978-1979	123
Regal	196 CID (3.2L) LC9 Buick	1978-1979	44	Series 61	331 CID (5.4L) OHV Cadillac	1949-1951	93
Regal	231 CID (3.8L) Supercharged Buick	1997-2004	60	Series 62	331 CID (5.4L) OHV Cadillac	1949-1955	93
Regal	231 CID (3.8L) Fuel Injected Buick	1990-2004	59	Series 62	365 CID (6.0L) Cadillac	1956-1958	106
Regal	231 CID (3.8L) Turbo Buick	1978-1987	61	Series 6200	331 CID (5.4L) OHV Cadillac	1951-1955	93
Regal	231 CID (3.8L) Carbureted Buick	1976-1987	58	Series 6200	365 CID (6.0L) Cadillac	1956-1958	106
Regal	252 CID (4.1L) LC4 Buick	1980-1984	67	Series 6200	390 CID (6.4L) Cadillac	1959-1963	110
Regal	260 CID (4.3L) Oldsmobile Diesel	1982-1985	69	Series 6200	429 CID (7.0L) Cadillac	1964-1967	127
Regal	262 CID (4.3L) Chevrolet	1985	72	Series 6200	472 CID (7.7L) Cadillac	1968-1974	133
Regal	265 CID (4.3L) LS5 Pontiac	1980-1981	76	Series 6200	500 CID (8.2L) Cadillac	1975	134
Regal	267 CID (4.4L) L39 Chevrolet	1981-1982	77	Seville	252 CID (4.1L) Cadillac	1982-1987	68
Regal	301 CID (4.9L) Pontiac	1979-1981	84	Seville	252 CID (4.1L) LC4 Buick	1981-1983	67
Regal	305 CID (5.0L) Chevrolet	1977-1987	86	Seville	273 CID (4.5L) Cadillac	1988-1989	78
Regal	307 CID (5.0L) Oldsmobile	1984-1987	88	Seville	281 CID (4.6L) L37 Cadillac	1993-2003	79
Regal	350 CID (5.7L) Oldsmobile Diesel	1981-1985	103	Seville	281 CID (4.6L) LD8 Cadillac	1993-2004	80
Regal	350 CID (5.7L) Carbureted Chevrolet	1977	99	Seville	300 CID (4.9L) L26 Cadillac	1991-1993	83
Regal	350 CID (5.7L) Buick	1976-1977	98	Seville	350 CID (5.7L) Oldsmobile Diesel	1978-1985	103
Regal	350 CID (5.7L) Oldsmobile	1977	102	Seville	350 CID (5.7L) Oldsmobile	1975-1979	102
Regal	403 CID (6.6L) L80 Oldsmobile	1977	119	Seville	368 CID (6.0L) Cadillac	1980-1981	107
Regency	231 CID (3.8L) Fuel Injected Buick	1997-1998	59	Seville	425 CID (7.0L) Cadillac	1977	123
Regency	307 CID (5.0L) Oldsmobile Diesel	1984	88	Seville	500 CID (8.2L) Cadillac	1976	134
Regency	350 CID (5.7L) Oldsmobile Diesel	1984	103	Skyhawk	110 CID (1.8L) LA5 OHC Turbo Pontiac	1984-1986	17
Riviera	173 CID (2.8L) Chevrolet	1984	39	Skyhawk	110 CID (1.8L) LH8 OHC Pontiac	1982-1986	18
Riviera	231 CID (3.8L) Supercharged Buick	1995-1999	60	Skyhawk	112 CID (1.8L) L46 Chevrolet	1982	20
				Skyhawk	121 CID (2.0L) LL8 Chevrolet	1987-1989	21
				Skyhawk	121 CID (2.0L) LQ5 Chevrolet	1983-1986	22
				Skyhawk	121 CID (2.0L) LR9 Chevrolet	1983-1984	23
				Skyhawk	122 CID (2.0L) OHC Turbo Pontiac	1987	25
				Skyhawk	122 CID (2.0L) OHC Pontiac	1987-1988	24
				Skyhawk	231 CID (3.8L) Carbureted Buick	1975-1980	58
				Skyhawk	138 CID (2.3L) L40 SOHC Oldsmobile	1992-1994	30
				Skyhawk	138 CID (2.3L) DOHC Oldsmobile	1988-1991	29

General Motors Corp.

Model Index (cont.)

Model	Engine	Year	Block	Model	Engine	Year	Block
Skylark	146 CID (2.4L) LD9 DOHC Oldsmobile	1996-1998	34	Storm	98 CID (1.6L) LO1 SOHC Isuzu	1990-1993	10
Skylark	151 CID (2.5L) Fuel Injected Pontiac	1982-1991	36	Storm	98 CID (1.6L) LW0 DOHC Isuzu	1990-1991	11
Skylark	151 CID (2.5L) Carbureted Pontiac	1980-1983	35	Storm	110 CID (1.8L) LV6 DOHC Isuzu	1992-1993	16
Skylark	173 CID (2.8L) Chevrolet	1980-1985	39	Stylemaster	216 CID (3.5L) Chevrolet	1946	53
Skylark	181 CID (3.0L) Buick	1985-1988	40	Sunbird	110 CID (1.8L) LA5 OHC	1986	17
Skylark	189 CID (3.1L) Chevrolet	1994-1998	41		Turbo Pontiac		
Skylark	204 CID (3.3L) LG7 Buick	1989-1993	46	Sunbird	110 CID (1.8L) LH8 OHC	1986	18
Skylark	215 CID (3.5L) Aluminum Block & Heads Buick	1961-1963	52	Sunbird	122 CID (2.0L) OHC Turbo Pontiac	1987-1990	25
Skylark	225 CID (3.7L) Buick	1964-1967	54	Sunbird	122 CID (2.0L) OHC Pontiac	1987-1994	24
Skylark	231 CID (3.8L) Carbureted Buick	1975-1987	58	Sunbird	140 CID (2.3L) Chevrolet	1976-1977	31
Skylark	250 CID (4.1L) Chevrolet	1968-1971	65	Sunbird	151 CID (2.5L) Carbureted Pontiac	1977-1980	35
Skylark	260 CID (4.3L) LV8 Oldsmobile	1975-1976	71	Sunbird	189 CID (3.1L) Chevrolet	1991-1994	41
Skylark	300 CID (4.9L) Buick	1964-1967	82	Sunbird	231 CID (3.8L) Carbureted Buick	1976-1980	58
Skylark	301 CID (4.9L) Pontiac	1977-1979	84				
Skylark	305 CID (5.0L) Chevrolet	1977-1978	86	Sunbird	305 CID (5.0L) Chevrolet	1978-1979	86
Skylark	322 CID (5.3L) Buick	1954	89	Sunburst	92 CID (1.5L) LC5 Isuzu	1985-1988	7
Skylark	340 CID (5.6L) Buick	1966-1967	94	Sunfire	134 CID (2.2L) OHV Chevrolet	1995-2002	28
Skylark	350 CID (5.7L) Carbureted Chevrolet	1977-1979	99	Sunfire	138 CID (2.3L) DOHC Oldsmobile	1995	29
Skylark	350 CID (5.7L) Buick	1968-1976	98	Sunfire	146 CID (2.4L) LD9 DOHC Oldsmobile	1996-2002	34
Skylark	350 CID (5.7L) Oldsmobile	1977-1980	102				
Skylark	400 CID (6.6L) Buick	1967-1969	112	Super	322 CID (5.3L) Buick	1953-1956	89
Skylark	401 CID (6.6L) Buick	1965-1966	117	Super	364 CID (6.0L) Buick	1957-1958	105
Skylark	455 CID (7.5L) Buick	1971	130	Super Chief	370 CID (6.1L) Pontiac	1958	108
Somerset	138 CID (2.3L) L40 SOHC Oldsmobile	1993-1994	30	T1000	98 CID (1.6L) Chevrolet	1981-1987	8
Somerset	138 CID (2.3L) DOHC Oldsmobile	1988-1989	29	Tempest	121 CID (2.0L) LL8 Chevrolet	1987-1989	21
Somerset	151 CID (2.5L) Fuel Injected Pontiac	1985-1989	36	Tempest	134 CID (2.2L) LM3 Chevrolet	1990-1991	26
Somerset	181 CID (3.0L) Buick	1985-1988	40	Tempest	173 CID (2.8L) Chevrolet	1987-1989	39
Somerset	189 CID (3.1L) Chevrolet	1994-1995	41	Tempest	189 CID (3.1L) Chevrolet	1990-1991	41
Somerset	204 CID (3.3L) LG7 Buick	1989	46	Tempest	195 CID (3.2L) Pontiac	1961-1963	43
Special	215 CID (3.5L) Aluminum Block & Heads Buick	1961-1963	52	Tempest	215 CID (3.5L) Pontiac	1964-1965	51
Special	216 CID (3.5L) Chevrolet	1949-1952	53	Tempest	215 CID (3.5L) Aluminum Block & Heads Buick	1961-1963	52
Special	225 CID (3.7L) Buick	1964-1967	54	Tempest	230 CID (3.8L) OHC Pontiac	1966-1967	57
Special	250 CID (4.1L) Chevrolet	1968-1969	65	Tempest	250 CID (4.1L) OHC Pontiac	1968-1969	66
Special	300 CID (4.9L) Buick	1964-1967	82	Tempest	326 CID (5.3L) Pontiac	1963-1967	90
Special	322 CID (5.3L) Buick	1956	89	Tempest	350 CID (5.7L) Pontiac	1969-1970	104
Special	340 CID (5.6L) Buick	1966-1967	94	Tempest	421 CID (6.9L) Pontiac	1963	121
Special	350 CID (5.7L) Buick	1968-1969	98	Tempest	389 CID (6.4L) Pontiac	1964-1966	109
Special	364 CID (6.0L) Buick	1957-1958	105	LeMans			
Special 150	235 CID (3.9L) Chevrolet	1953-1957	62	Toronado	231 CID (3.8L) Fuel Injected Buick	1986-1992	59
Special 150	265 CID (4.3L) Chevrolet	1955-1957	74	Toronado	252 CID (4.1L) LC4 Buick	1981-1984	67
Special 150	283 CID (4.6L) Chevrolet	1957	81	Toronado	307 CID (5.0L) Oldsmobile	1980-1985	88
Special Deluxe	216 CID (3.5L) Chevrolet	1940	53	Toronado	350 CID (5.7L) Oldsmobile Diesel	1979-1985	103
Spectrum	92 CID (1.5L) LC5 Isuzu	1985-1989	7	Toronado	350 CID (5.7L) Oldsmobile	1977-1980	102
Sprint	61 CID (1.0L) LP2 Suzuki	1989-1991	1	Toronado	403 CID (6.6L) L80 Oldsmobile	1977-1978	119
Sprint	61 CID (1.0L) LS3 Turbo Suzuki	1987-1991	2	Toronado	425 CID (7.0L) Oldsmobile	1966-1967	124
Sprint	61 CID (1.0L) LY9 Suzuki	1985-1988	3	Toronado	455 CID (7.5L) Oldsmobile	1968-1975	131
Star Chief	370 CID (6.1L) Pontiac	1958	108	Townsmen	235 CID (3.9L) Chevrolet	1954-1957	62
Star Chief	389 CID (6.4L) Pontiac	1960-1965	109	Townsmen	265 CID (4.3L) Chevrolet	1955-1957	74
Star Chief	421 CID (6.9L) Pontiac	1963-1965	121	Townsmen	283 CID (4.6L) Chevrolet	1957	81
Star Chief Executive	389 CID (6.4L) Pontiac	1966	109	Vega	140 CID (2.3L) Chevrolet	1971-1977	31
Starfire	140 CID (2.3L) Chevrolet	1976-1977	31	Ventura	151 CID (2.5L) Carbureted Pontiac	1977	35
Starfire	151 CID (2.5L) Carbureted Pontiac	1978-1980	35	Ventura	231 CID (3.8L) Carbureted Buick	1977	58
Starfire	231 CID (3.8L) Carbureted Buick	1975-1980	58	Ventura	250 CID (4.1L) Chevrolet	1973-1976	65
Starfire	305 CID (5.0L) Chevrolet	1977-1978	86	Ventura	260 CID (4.3L) LV8 Oldsmobile	1975-1976	71
Starfire	425 CID (7.0L) Oldsmobile	1965-1966	124	Ventura	301 CID (4.9L) Pontiac	1977	84
				Ventura	305 CID (5.0L) Chevrolet	1977	86
				Ventura	350 CID (5.7L) Carbureted Chevrolet	1977	99

General Motors Corp.

Model Index (cont.)

Model	Engine	Year	Block	Model	Engine	Year	Block
Ventura	350 CID (5.7L) Buick	1974-1976	98	Vista Cruiser	350 CID (5.7L) Oldsmobile	1968-1975	102
Ventura	350 CID (5.7L) Pontiac	1973-1974	104	Vista Cruiser	455 CID (7.5L) Oldsmobile	1971-1975	131
Ventura	350 CID (5.7L) Oldsmobile	1977	102	Wild Cat	401 CID (6.6L) Buick	1964-1966	117
Ventura	389 CID (6.4L) Pontiac	1960-1961	109	Wild Cat	425 CID (7.0L) Buick	1964-1966	122
Ventura II	250 CID (4.1L) Chevrolet	1971	65	Wild Cat	430 CID (7.0L) Buick	1967-1969	128
Ventura II	307 CID (5.0L) Chevrolet	1971	87	Wild Cat	455 CID (7.5L) Buick	1970	130
Ventura II	350 CID (5.7L) Pontiac	1972	104	Yeoman	235 CID (3.9L) Chevrolet	1958	62
Vista Cruiser	330 CID (5.4L) OHV Oldsmobile	1964-1967	92	Yeoman	283 CID (4.6L) Chevrolet	1958	81
				Yeoman	348 CID (5.7L) Chevrolet	1958	97

1 61 CID (1.0L) LP2 Suzuki 3 Cyl, 2.913in./74mm (1989-2000) 1

Part	Year	VIN	Model/Application	Part Number	Qty.
------	------	-----	-------------------	-------------	------

ENGINE GASKETS

Head Set	1989-2000		(Head Bolts Not Included)	HS5874A	1
Lower Set	1989-2000			CS5874A	1
Full Set	1989-1997		(Head Bolts Not Included)	FS5874	1
Engine Kit Gasket Set	1989-1994			95-3426VR	1
Cylinder Head Gasket	1989-2000		Nitroseal	5874	1
Cyl. Head Bolt Set	1989-2000		(Contains Washers)	GS33242	1
Valve Cover Set	1989-2000		(Contains Valve Cover Grommets)	Victo-Tech VS50115A	1
Valve Stem Seal, Exh.	1989-2000			B45674	3
Valve Stem Seal, Int.	1989-2000			B45674	3
Manifold Set, Exhaust	1989-2000			MS14157	1
Manifold Set, Intake	1989-2000			MS14156	1
Oil Pan Set	1989-2000		Cork Rubber	OS32023	1
Rear Main Seal Set	1989-2000			JV549	1
Timing Cover Set	1989-2000			JV5009	1
	1989-1997		To Be Replaced By 66981	JV1024	1

MISCELLANEOUS GASKETS

E.G.R. Gasket	1989-2000			G30785	1
Exhaust Pipe Gasket	1989-2000		(Ring Type 'F'), Pipe To Manifold	F7211	1
Therm. Housing Gasket	1989-2000			C31394	1
Throttle Body Gasket	1995-2000			G31404	1
	1993-1994		2nd Design	G31405	1
	1989-1993		1st Design	G31368	1
Water Outlet Gasket	1989-2000			C30826	1
Water Pump Mount Gasket	1989-2000			K30640	1

2 61 CID (1.0L) LS3 Turbo Suzuki 3 Cyl, 2.913in./74mm (1987-1991) 2

Part	Year	VIN	Model/Application	Part Number	Qty.
------	------	-----	-------------------	-------------	------

ENGINE GASKETS

Head Set	1989-1991		(Requires Turbocharger Mounting Set)	HS5874A	1
Lower Set	1989-1991		Metro, Requires Head Set To Make Full Set	CS5874A	1
Cylinder Head Gasket	1989-1991		Nitroseal	5874	1
Cyl. Head Bolt Set	1987-1991		(Contains Washers)	GS33242	1
Valve Cover Set	1989-1991		(Contains Grommets)	Victo-Tech VS50115A	1
Valve Stem Seal, Exh.	1989-1991			B45674	3
Valve Stem Seal, Int.	1989-1991			B45674	3
Manifold Set, Exhaust	1989-1991			MS14157	1
Manifold Set, Intake	1989-1991			MS14156	1
Oil Pan Set	1989-1991		Cork Rubber	OS32023	1
Rear Main Seal Set	1989-1991			JV549	1
Timing Cover Set	1989-1991			JV5009	1

MISCELLANEOUS GASKETS

Exhaust Pipe Gasket	1989-1991		(Ring Type 'F'), Pipe To Manifold	F7211	1
Therm. Housing Gasket	1989-1991			C31394	1

2 61 CID (1.0L) LS3 Turbo Suzuki 3 Cyl, 2.913in./74mm (1987-1991) **2**
(cont.) (cont.)

Part Year VIN Model/Application Part Number Qty.

MISCELLANEOUS GASKETS (cont.)

Throttle Body Gasket	1989-1991			G31403	1
Turbo Mounting Set	1989-1991			GS33358	1
Water Outlet Gasket	1989-1991			C30826	1
Water Pump Mount Gasket	1989-1991			K30640	1

3 61 CID (1.0L) LY9 Suzuki 3 Cyl, 2.913in./74mm (1985-1988) **3**

Part Year VIN Model/Application Part Number Qty.

ENGINE GASKETS

Head Set	1985-1988		(Head Bolts Not Included)	HS5704	1
			(Contains Head Bolts)	HS5704WB	1
Full Set	1985-1988		(Head Bolts Not Included)	FS5704	1
Engine Kit Gasket Set	1985-1988			95-3172VR	1
Cylinder Head Gasket	1985-1988			<i>Nitroseal</i> 5704	1
Cyl. Head Bolt Set	1985-1988		(Contains Washers)	GS33242	1
Valve Cover Set	1985-1988			<i>Cork Rubber</i> VS50002	1
Valve Stem Seal, Exh.	1985-1988			B45590	3
Valve Stem Seal, Int.	1985-1988			B45590	3
Manifold Set, Exhaust	1985-1988			MS12318	1
Manifold Set, Intake	1985-1988			MS12317	1
Oil Pan Set	1985-1988			<i>Cork Rubber</i> OS32023	1
Rear Main Seal Set	1985-1988			JV549	1
Timing Cover Set	1985-1988		To Be Replaced By 66981	JV1024	1
				JV5009	1

MISCELLANEOUS GASKETS

Exhaust Pipe Gasket	1985-1988		(Ring Type 'F'), Pipe To Manifold	F7211	1
Fuel Pump Gasket	1985-1988			D30641	1
Water Outlet Gasket	1985-1988			C30826	1
Water Pump Mount Gasket	1985-1988			K30640	1

4 79 CID (1.3L) L72 SOHC Suzuki 4 Cyl, 2.913in./74mm (1992-1997) **4**

Part Year VIN Model/Application Part Number Qty.

ENGINE GASKETS

Cylinder Head Gasket	1992-1997			<i>Nitroseal</i> 5759	1
Valve Cover Set	1995-1997			VS50310	1
	1992-1994			<i>Cork Rubber</i> VS50042	1
Oil Pan Set	1996-1997			<i>Cork Rubber</i> OS32141	1
	1992-1995			<i>Cork Rubber</i> OS32089	1
Rear Main Seal Set	1992-1997			JV549	1
Timing Cover Set	1992-1997		To Be Replaced By 66981	JV1024	1
				JV5009	1

MISCELLANEOUS GASKETS

Therm. Housing Gasket	1992-1997			C31394	1
Throttle Body Gasket	1992-1994			G31405	1
Water Outlet Gasket	1992-1997			C30645	1
Water Pump Mount Gasket	1992-1997			K30640	1

5 79 CID (1.3L) LY8 Suzuki 4 Cyl, 2.913in./74mm (1998-2001) **5**

Part Year VIN Model/Application Part Number Qty.

ENGINE GASKETS

Cylinder Head Gasket	1998-1999			<i>Nitroseal</i> 5759	1
----------------------	-----------	--	--	-----------------------	---

General Motors Corp.

5	79 CID (1.3L) LY8 Suzuki 4 Cyl, 2.913in./74mm (1998-2001)	5
(cont.)		(cont.)

Part	Year	VIN	Model/Application	Part Number	Qty.
------	------	-----	-------------------	-------------	------

ENGINE GASKETS (cont.)

Oil Pan Set	1998-1999		<i>Cork Rubber</i>	OS32141	1
-------------	-----------	--	--------------------	---------	---

MISCELLANEOUS GASKETS

Therm. Housing Gasket	1998-1999			C31394	1
Water Outlet Gasket	1998-1999			C30645	1
Water Pump Mount Gasket	1998-2001			K30640	1

6	85 CID (1.4L) LX3 Chevrolet 4 Cyl, 3.228in./82mm (1976-1977)	6
(cont.)		(cont.)

Part	Year	VIN	Model/Application	Part Number	Qty.
------	------	-----	-------------------	-------------	------

ENGINE GASKETS

Head Set	1976-1977			HS3520	1
Full Set	1976-1977			FS3520	1
Engine Kit Gasket Set	1976-1977			95-3043VR	1
Cylinder Head Gasket	1976-1977		<i>VR2000</i>	3520	1
Valve Cover Set	1976-1977		<i>Cork Rubber</i>	VS39762	1
Valve Stem Seal, Exh.	1976-1977			B45411	4
Valve Stem Seal, Int.	1976-1977			B45410	4
Manifold Set, Exhaust	1976-1977			MS15312	1
Manifold Set, Intake	1976-1977			MS15209	1
Oil Pan Set	1976-1977		<i>Cork Rubber</i>	OS30556	1
Rear Main Seal Set	1976-1977			JV619	1
Timing Cover Set	1976-1977		<i>Tuff-Cork</i>	JV882TC	1
Timing Cover Gasket	1976-1977		<i>Tuff-Cork</i>	T27633TC	1
Timing Cover Seal	1976-1977		<i>3/8" Wide</i>	49328	1

MISCELLANEOUS GASKETS

Camshaft Seal	1976-1977			48277SF	1
Carb. Mount Gasket	1976-1977		1 Barrel Carburetor	G26718	1
Dist. Mounting Gasket	1976-1977			B45821	1
E.G.R. Gasket	1976-1977			G26315	1
Fuel Pump Gasket	1976-1977			D27207	1
Water Outlet Gasket	1976-1977			C26653	1
Water Pump Mount Gasket	1976-1977			K26063	1

7	92 CID (1.5L) LC5 Isuzu 4 Cyl, 3.031in./77mm (1985-1989)	7
(cont.)		(cont.)

Part	Year	VIN	Model/Application	Part Number	Qty.
------	------	-----	-------------------	-------------	------

ENGINE GASKETS

Head Set	1986-1989	7		HS5705	1
	1985			HS5705	1
Full Set	1986-1989	7		FS5705	1
	1985			FS5705	1
Engine Kit Gasket Set	1986-1989	7		95-3173VR	1
	1985			95-3173VR	1
Cylinder Head Gasket	1986-1989	7		5705	1
	1985			5705	1
Valve Cover Set	1986-1989	7	<i>Victo-Tech</i>	VS50003	1
	1985		<i>Victo-Tech</i>	VS50003	1
Valve Stem Seal, Exh.	1986-1989	7		B45571	4
	1985			B45571	4
Valve Stem Seal, Int.	1986-1989	7		B45571	4
	1985			B45571	4
Manifold Set, Exhaust	1986-1989	7		MS12319	1
	1985			MS12319	1
Manifold Set, Intake	1986-1989	7		MS15399	1

7 92 CID (1.5L) LC5 Isuzu 4 Cyl, 3.031in./77mm (1985-1989) **7**
 (cont.) (cont.)

Part Year VIN Model/Application Part Number Qty.

ENGINE GASKETS (cont.)

Manifold Set, Intake (cont.)	1985			MS15399	1
Oil Pan Set	1986-1989	7	Cork Rubber	OS32024	1
	1985		Cork Rubber	OS32024	1
Rear Main Seal Set	1986-1989	7		JV550	1
	1985			JV550	1
Timing Cover Set	1986-1989	7		JV1025	1
	1985			JV1025	1

MISCELLANEOUS GASKETS

Camshaft Seal	1986-1989	7		67111	1
	1985			67111	1
Carb. Mount Gasket	1985-1989		2 Barrel Carburetor	G31418	2
E.G.R. Gasket	1986-1989	7		G31300	1
	1985			G31300	1
Exhaust Pipe Gasket	1986-1989	7	(Flange Type), Pipe To Manifold	F7277	2
	1986-1988	7	(Flange Type), Catalytic Converter	F10086	2
	1985		(Flange Type), Pipe To Manifold	F7277	2
			(Flange Type), Catalytic Converter	F10086	2
Fuel Pump Gasket	1986-1989	7		D30644	1
	1985			D30644	1
Thermostat Seal	1986-1989	7		Victopac C20115	1
		7	(2 Holes), To Be Replaced By C20115	Victo-Tech C30660	1
	1985			Victopac C20115	1
			(2 Holes), To Be Replaced By C20115	Victo-Tech C30660	1
Water Outlet Gasket	1986-1989	7		C30643	1
	1985			C30643	1
Water Pump Mount Gasket	1986-1989	7		K30642	1
	1985			K30642	1

8 98 CID (1.6L) Chevrolet 4 Cyl, 3.228in./82mm (1976-1987) **8**

Part Year VIN Model/Application Part Number Qty.

ENGINE GASKETS

Head Set	1979-1987			HS3520W	1
	1976-1978			HS3520	1
Full Set	1979-1987			FS3520W	1
	1976-1978			FS3520	1
Engine Kit Gasket Set	1976-1987			95-3043VR	1
Cylinder Head Gasket	1976-1987		VR2000	3520	1
Valve Cover Set	1976-1987		Cork Rubber	VS39762	1
Valve Stem Seal, Exh.	1976-1987			B45411	4
Valve Stem Seal, Int.	1976-1987			B45410	4
Manifold Set, Exhaust	1976-1987			MS15312	1
Manifold Set, Intake	1979-1987			MS15223	1
	1976-1978			MS15209	1
Oil Pan Set	1976-1987		Cork Rubber	OS30556	1
Rear Main Seal Set	1976-1987			JV619	1
Timing Cover Set	1976-1987		Tuff-Cork	JV882TC	1
Timing Cover Gasket	1976-1987		Tuff-Cork	T27633TC	1
Timing Cover Seal	1976-1987		3/8" Wide	49328	1

MISCELLANEOUS GASKETS

Camshaft Seal	1976-1987			48277SF	1
Carb. Mount Gasket	1979-1982		2 Barrel Carburetor	G25462	1
	1976-1978		1 Barrel Carburetor	G26718	1
Dist. Mounting Gasket	1976-1987			B45821	1

General Motors Corp.

8 (cont.)	98 CID (1.6L) Chevrolet 4 Cyl, 3.228in./82mm (1976-1987)				8 (cont.)
---------------------	---	--	--	--	---------------------

Part	Year	VIN	Model/Application	Part Number	Qty.
------	------	-----	-------------------	-------------	------

MISCELLANEOUS GASKETS (cont.)

E.G.R. Gasket	1976-1987			G26315	1
Fuel Pump Gasket	1976-1987			D27207	1
Water Outlet Gasket	1976-1987			C26653	1
Water Pump Mount Gasket	1976-1987			K26063	1

9	98 CID (1.6L) L73 Daewoo 4 Cyl, 3.110in./79mm (1988-1993)				9
----------	--	--	--	--	----------

Part	Year	VIN	Model/Application	Part Number	Qty.
------	------	-----	-------------------	-------------	------

ENGINE GASKETS

Head Set	1988-1993			HS5867	1
Lower Set	1988-1993		(Requires Head Set To Make Full Set)	CS5867	1
Engine Kit Gasket Set	1988-1993			95-3248VR	1
Cylinder Head Gasket	1988-1993			5867	1
Valve Cover Set	1988-1993		Cork Rubber	VS50108	1
Valve Stem Seal, Exh.	1988-1993			B45625	4
Valve Stem Seal, Int.	1988-1993			B45625	4
Manifold Set, Exhaust	1988-1993			MS12373	1
Manifold Set, Intake	1988-1993			MS15632	1
Oil Pan Set	1988-1993		Tuff-Cork	OS32083TC	1
Rear Main Seal Set	1988-1993			JV595	1
Timing Cover Set	1988-1993			JV1111	1

MISCELLANEOUS GASKETS

Camshaft Seal	1988-1993			47950	1
E.G.R. Gasket	1988-1993			G31125	1
Exhaust Pipe Gasket	1988-1993		(Ring Type 'F'), Pipe To Manifold	F7209	1
Throttle Body Gasket	1988-1993			G31134	1
Water Outlet Gasket	1988-1993			C31379	1

10	98 CID (1.6L) LO1 SOHC Isuzu 4 Cyl, 3.150in./80mm (1990-1993)				10
-----------	--	--	--	--	-----------

Part	Year	VIN	Model/Application	Part Number	Qty.
------	------	-----	-------------------	-------------	------

ENGINE GASKETS

Head Set	1990-1993			HS5910	1
Full Set	1990-1993			FS5910	1
Cylinder Head Gasket	1990-1993		Nitroseal	5910	1
Valve Cover Set	1990-1993		Victo-Tech	VS50155	1
Valve Stem Seal, Exh.	1990-1993			B45571	4
Valve Stem Seal, Int.	1990-1993			B45571	8
Manifold Set, Exhaust	1990-1993			MS12397	1
Manifold Set, Intake	1990-1993		(Contains Plenum Chamber Gasket)	MS16061	1
Plenum Chamber Gasket	1990-1993			MS16062	1
Oil Pan Set	1990-1993		Cork Rubber	OS32024	1
Rear Main Seal Set	1990-1993			JV1604	1
Timing Cover Set	1990-1993		(Requires RTV)	JV1025	1

MISCELLANEOUS GASKETS

Camshaft Seal	1990-1993			67111	1
E.G.R. Gasket	1990-1993			G31211	1
Exhaust Pipe Gasket	1990-1993		(Ring Type 'A'), Pipe To Manifold	F7493	1
			Except California, (Flange Type), Catalytic Converter	F10086	2
Therm. Housing Gasket	1990-1993		Housing To Head	Victo-Tech C31206	1
Throttle Body Gasket	1990-1993			G31205	1
Water Inlet Gasket	1990-1993			C31213	1
Water Outlet Gasket	1990-1993		Victo-Tech	C20115	1

10 98 CID (1.6L) LO1 SOHC Isuzu 4 Cyl, 3.150in./80mm (1990-1993) **10**
(cont.) (cont.)

Part Year VIN Model/Application Part Number Qty.

MISCELLANEOUS GASKETS (cont.)

Water Pump Mount Gasket	1990-1993			K31201	1
-------------------------	-----------	--	--	--------	---

11 98 CID (1.6L) LW0 DOHC Isuzu 4 Cyl, 3.150in./80mm (1990-1991) **11**

Part Year VIN Model/Application Part Number Qty.

ENGINE GASKETS

Head Set	1990-1991			HS5911	1
Full Set	1990-1991			FS5911	1
Cylinder Head Gasket	1990-1991		<i>Nitroseal</i>	5911	1
Valve Cover Set	1990-1991		<i>Victo-Tech</i>	VS50154	1
Valve Stem Seal, Exh.	1990-1991			B45571	8
Valve Stem Seal, Int.	1990-1991			B45571	8
Manifold Set, Exhaust	1990-1991			MS16065	1
Manifold Set, Intake	1990-1991		(Contains Plenum Chamber Gasket)	MS16063	1
Plenum Chamber Gasket	1990-1991			MS16064	1
Oil Pan Set	1990-1991		<i>Cork Rubber</i>	OS32024	1
Rear Main Seal Set	1990-1991			JV1604	1
Timing Cover Set	1990-1991		(Requires RTV)	JV1025	1

MISCELLANEOUS GASKETS

Camshaft Seal	1990-1991			66780	2
E.G.R. Gasket	1990-1991			G31211	1
Exhaust Pipe Gasket	1990-1991		(Flange Type), Catalytic Converter	F10086	2
			(Flange Type), Pipe To Manifold	F12398	1
Thermostat Seal	1990-1991		<i>Victo-Tech</i>	C31203	1
Throttle Body Gasket	1990-1991			G31205	1
Water Outlet Gasket	1990-1991		(2 Holes) <i>Victopac</i>	C20115	1
Water Pump Mount Gasket	1990-1991			K31201	1

12 98 CID (1.6L) LC9 SOHC Toyota 4 Cyl, 3.189in./81mm (1985-1988) **12**

Part Year VIN Model/Application Part Number Qty.

ENGINE GASKETS

Head Set	1986-1988			HS3756Y	1
	1985			HS3756	1
Lower Set	1985-1988			CS3756	1
Engine Kit Gasket Set	1986-1988		2 Barrel Carburetor, (Valve Cover Set Not Included), Use With Part Number VS50047	95-3409VR	1
	1985		2 Barrel Carburetor, (Valve Cover Set Not Included), Use With Part Number VS20348	95-3409VR	1
Cylinder Head Gasket	1985-1988		<i>Nitroseal</i>	3756	1
Valve Cover Set	1986-1988		(Contains Valve Cover Washers, Contains Valve Cover End Plug) <i>Victo-Tech</i>	VS50047	1
	1985		(Contains Valve Cover Washers, Contains Valve Cover End Plug) <i>Victo-Tech</i>	VS20348	1
Valve Stem Seal, Exh.	1985-1988			B45476	4
Valve Stem Seal, Int.	1985-1988			B45476	4
Manifold Set, Int. & Exh.	1985-1988			MS15318	1
Oil Pan Set	1985-1988		<i>Cork Rubber</i>	OS30349	1
Rear Main Seal Set	1985-1988			JV532	1
Timing Cover Set	1986-1988		(Camshaft Seal Not Included)	JV1009	1
	1985			JV992	1

MISCELLANEOUS GASKETS

Camshaft Seal	1985-1988			66807	1
E.G.R. Gasket	1985-1988			G26262	1

General Motors Corp.

12 <small>(cont.)</small>	98 CID (1.6L) LC9 SOHC Toyota 4 Cyl, 3.189in./81mm (1985-1988)	12 <small>(cont.)</small>
-------------------------------------	---	-------------------------------------

Part	Year	VIN	Model/Application	Part Number	Qty.
MISCELLANEOUS GASKETS (cont.)					
Exhaust Pipe Gasket	1985-1988		(Ring Type 'A'), Pipe To Manifold	F14592	1
			(Ring Type 'A'), Catalytic Converter	F20252	2
Water Outlet Gasket	1985-1988		<i>Victo-Tech</i>	C24184	1
			Water Outlet To Block	C24213	1
Water Pump Mount Gasket	1985-1988		(O-Ring Type)	B45550	2
				K27440	1

13	98 CID (1.6L) LO1 DOHC Toyota 4 Cyl, 3.189in./81mm (1989-1997)	13
-----------	---	-----------

Part	Year	VIN	Model/Application	Part Number	Qty.	
ENGINE GASKETS						
Head Set	1989-1992		(Head Bolts Not Included)	HS4899W	1	
			(Contains Head Bolts)	HS4899WB	1	
Full Set	1989-1992		(Head Bolts Not Included)	FS4899W	1	
Engine Kit Gasket Set	1989-1992			95-3271VR	1	
Cylinder Head Gasket	1989-1992		<i>Nitroseal</i>	4899	1	
Cyl. Head Bolt Set	1989-1992			GS33240	1	
Valve Cover Set	1993-1997		(Contains Spark Plug Tube Seals And Washers)	<i>Victo-Tech</i>	VS50228	1
			(Contains Valve Cover Grommets, Contains Spark Plug Tube Seals)	<i>Victo-Tech</i>	VS50098	1
Valve Stem Seal, Exh.	1989-1992			B45549	8	
Valve Stem Seal, Int.	1989-1992			B45549	8	
Manifold Set, Exhaust	1989-1997			MS15560	1	
Manifold Set, Intake	1989-1992		California	MS15559	1	
			Except California	MS15561	1	
Oil Pan Set	1993-1997			OS32088	1	
	1989-1992		<i>Silicone</i>	JV6	1	
Rear Main Seal Set	1989-1997			JV532	1	
Timing Cover Set	1993-1997		(Camshaft Seals Not Included)	JV1009	1	
	1989-1992			JV992	1	

MISCELLANEOUS GASKETS

Camshaft Seal	1989-1997			66807	1
E.G.R. Gasket	1989-1992		California	G31083	1
			Except California	G31384	1
Exhaust Pipe Gasket	1989-1997		(Ring Type 'A'), Pipe To Manifold	F20252	1
	1990-1992		Except California, (Flange Type), Catalytic Converter	F14594	2
Injector Nozzle O-Ring	1989-1997			GS33277	1
Therm. Housing Gasket	1989-1992		<i>Victo-Tech</i>	C24220	1
Thermostat Seal	1989-1993			C31379	1
Throttle Body Gasket	1993-1997			G31382	1
	1996			G31400	1
	1989-1992			G31089	1
Valve Cover Grommet	1989-1992			GS33282	1
Water Inlet Gasket	1993-1997			C31401	1
Water Outlet Gasket	1989-1997		(O-Ring Type) <i>Victo-Tech</i>	C24184	1
Water Pump Mount Gasket	1989-1997		(O-Ring Type)	B45550	2
				K27440	1

14	98 CID (1.6L) LW0 DOHC Toyota 4 Cyl, 3.189in./81mm (1988-1992)	14
-----------	---	-----------

Part	Year	VIN	Model/Application	Part Number	Qty.
ENGINE GASKETS					
Head Set	1990-1992		(Head Bolts Not Included)	HS5797W	1
			(Contains Head Bolts)	HS5797WB1	1

14 98 CID (1.6L) LW0 DOHC Toyota 4 Cyl, 3.189in./81mm (1988-1992) **14**
(cont.) (cont.)

Part	Year	VIN	Model/Application	Part Number	Qty.
ENGINE GASKETS (cont.)					
Head Set (cont.)	1988		(Head Bolts Not Included)	HS5797	1
			(Contains Head Bolts)	HS5797WB	1
Full Set	1990-1992		(Head Bolts Not Included)	FS5797W	1
	1988		(Head Bolts Not Included, Oil Pan Gasket Not Included)	FS5797	1
Cylinder Head Gasket	1990-1992		Nitroseal	5797	1
	1988		Nitroseal	5797	1
Cyl. Head Bolt Set	1990-1992			GS33240	1
	1988			GS33240	1
Valve Cover Set	1990-1992		(Contains Valve Cover Grommets) Victo-Tech	VS50117	1
	1988		(Contains Valve Cover Washers, Spark Plug Tube Seals Not Included) Victo-Tech	VS38395	1
Valve Stem Seal, Exh.	1990-1992			B45556	8
	1988			B45476	8
Valve Stem Seal, Int.	1990-1992			B45677	8
	1988			B45476	8
Manifold Set, Exhaust	1990-1992			MS15382	1
	1988			MS15382	1
Manifold Set, Intake	1990-1992			MS15643	1
	1988			MS15566	1
Oil Pan Set	1990-1992		Original Equipment Uses RTV Silicone	JV6	1
	1988		Original Equipment Uses RTV Silicone	JV6	1
Rear Main Seal Set	1990-1992			JV532	1
	1988			JV532	1
Timing Cover Set	1990-1992			JV1012	1
	1988			JV1012	1

MISCELLANEOUS GASKETS

E.G.R. Gasket	1990-1992			G31083	1
	1988			G26262	1
Exhaust Pipe Gasket	1990-1992		(Ring Type 'A'), Pipe To Manifold	F14592	1
			Except California, (Flange Type), Catalytic Converter	F14594	2
	1988		(Ring Type 'A'), Pipe To Manifold	F14592	1
			(Ring Type 'A'), Catalytic Converter	F20252	2
Therm. Housing Gasket	1990-1992		Victo-Tech	C24220	1
Throttle Body Gasket	1990-1992			G31089	1
Valve Cover Grommet	1990-1992			GS33282	1
Water Outlet Gasket	1990-1992		(O-Ring Type) Victo-Tech	C24184	1
	1988		Victo-Tech	C24184	1
			Water Outlet To Block	C24213	1
Water Pump Mount Gasket	1990-1992		(O-Ring Type)	B45550	2
				K27440	1
				B45550	2
	1988		(O-Ring Type)	B45550	2
				K27440	1

15 108 CID (1.8L) LV6 DOHC Toyota 4 Cyl, 3.189in./81mm (1993-1997) **15**

Part	Year	VIN	Model/Application	Part Number	Qty.
ENGINE GASKETS					
Valve Cover Set	1993-1997		(Contains Spark Plug Tube Seals And Washers) Victo-Tech	VS50228	1
Manifold Set, Exhaust	1993-1997			MS15560	1
Oil Pan Set	1993-1997			OS32138	1
Rear Main Seal Set	1993-1997			JV532	1
MISCELLANEOUS GASKETS					
E.G.R. Gasket	1996-1997			G31083	1
	1995		Except California	G31083	1

General Motors Corp.

15 108 CID (1.8L) LV6 DOHC Toyota 4 Cyl, 3.189in./81mm (1993-1997) **15**
(cont.) (cont.)

Part	Year	VIN	Model/Application	Part Number	Qty.
MISCELLANEOUS GASKETS (cont.)					
E.G.R. Gasket (cont.)	1993-1995		California	G26262	1
Exhaust Pipe Gasket	1993-1996		California, (Ring Type 'A'), Catalytic Converter, Pipe To Manifold, Rear	F20252	1
	1993-1995		California, (Ring Type 'A'), Catalytic Converter, Front	F14594	1
Throttle Body Gasket	1993-1996			G31382	1
Water Inlet Gasket	1993-1997			C31401	1
Water Outlet Gasket	1993-1997		Victo-Tech	C24184	1
Water Pump Mount Gasket	1993-1997			K27440	1

16 110 CID (1.8L) LV6 DOHC Isuzu 4 Cyl, 3.150in./80mm (1992-1993) **16**

Part	Year	VIN	Model/Application	Part Number	Qty.
ENGINE GASKETS					
Head Set	1992-1993			HS5917	1
Full Set	1992-1993			FS5917	1
Cylinder Head Gasket	1992-1993		Nitroseal	5917	1
Valve Cover Set	1992-1993		Victo-Tech	VS50154	1
Valve Stem Seal, Exh.	1992-1993			B45571	8
Valve Stem Seal, Int.	1992-1993			B45571	8
Manifold Set, Exhaust	1992-1993			MS16065	1
Manifold Set, Intake	1992-1993		(Contains Plenum Chamber Gasket)	MS16066	1
Plenum Chamber Gasket	1992-1993			MS16051	1
Oil Pan Set	1992-1993			OS32140	1
Rear Main Seal Set	1992-1993			JV1604	1
Timing Cover Set	1992-1993		(Camshaft Seals Not Included)	JV1025	1

MISCELLANEOUS GASKETS					
Camshaft Seal	1992-1993			66780	2
E.G.R. Gasket	1992-1993		Valve	G31211	1
			Pipe	G31415	1
Exhaust Pipe Gasket	1992-1993		(Flange Type), Exhaust Pipe To Converter	F10086	2
			(Flange Type), Pipe To Manifold	F12398	1
Therm. Housing Gasket	1992-1993			C31214	1
Water Inlet Gasket	1992-1993			C31213	1
Water Outlet Gasket	1992-1993			C31215	1
Water Pump Mount Gasket	1992-1993			K31201	1

17 110 CID (1.8L) LA5 OHC Turbo Pontiac 4 Cyl, 3.339in./84.8mm (1984-1986) **17**

Part	Year	VIN	Model/Application	Part Number	Qty.
ENGINE GASKETS					
Head Set	1984-1986		(Head Bolts Not Included, Exhaust Pipe Gasket Not Included)	HS3721A	1
Lower Set	1984-1986		(Requires Head Set To Make Full Set)	CS3721	1
Engine Kit Gasket Set	1984-1986		(Exhaust Manifold Gasket Not Included), Use With Part Number MS15590	95-3405VR	1
Cylinder Head Gasket	1984-1986		Nitroseal	3721	1
Cyl. Head Bolt Set	1984-1986			GS33222	1
Cyl. Head Spacer Shim	1984-1986		Requires Sealing Compound	Steel 3721S	1
Sealing Compound	1984-1986		(4 Ounce Brush Top Can)	JV66B	1
			(12 Ounce Spray Can)	JV66S	1
Valve Cover Set	1984-1986		Tuff-Cork	VS38326TC	1
Valve Stem Seal, Exh.	1984-1986			B45613	4
Valve Stem Seal, Int.	1984-1986			B45613	4

17 110 CID (1.8L) LA5 OHC Turbo Pontiac 4 Cyl, 3.339in./84.8mm (1984-1986) **17**
(cont.) (cont.)

Part	Year	VIN	Model/Application	Part Number	Qty.
ENGINE GASKETS (cont.)					
Manifold Set, Exhaust	1984-1986			MS15590	1
Manifold Set, Intake	1984-1986			MS12289	1
Oil Pan Set	1984-1986		<i>Cork Rubber</i>	OS30587	1
Rear Main Seal Set	1984-1986			JV519	1
Crank Repair Sleeve	1984-1986		Use With Part Number A507, Rear <i>Nickel Plated Formed Steel, .013" Thickness</i>	A343	1
Timing Cover Set	1984-1986		(Contains Oil Pump Seal, Contains Oil Pump Gasket And Water Pump Seal)	JV985	1
Timing Cover Seal	1984-1986			47952	1
Harmonic Balancer Repair Sleeve	1984-1986		Use With Part Number A508 <i>Nickel Plated Formed Steel, .013" Thickness</i>	A345	1

MISCELLANEOUS GASKETS

Air Cleaner Mount Gasket	1984-1986		Throttle Body Injection	G26803	1
Camshaft Seal	1984-1986			47950	1
E.G.R. Gasket	1984-1986			G26985	1
Exhaust Pipe Gasket	1984-1986		(Ring Type 'E'), Pipe To Manifold	F7267	1
Fuel Pump Gasket	1984-1986			D27207	1
Thermostat Seal	1984-1986			C31325	1
Throttle Body Gasket	1985-1986		Throttle Body To Adapter	G31375	1
			Adapter To Manifold	G31376	1
	1984		Bottom, Inner, Throttle Body Injection To Manifold	G26828	1
			Bottom, Outer, Throttle Body Injection To Manifold	G26829	1
			Throttle Body Injection To Manifold, Top	G26830	1
Turbo Mounting Set	1984-1986		GS33273	1	
Water Outlet Gasket	1984-1986			C24120	1
			(O-Ring Type)	C31398	1
Water Pump Mount Gasket	1984-1986			K31188	1

18 110 CID (1.8L) LH8 OHC Pontiac 4 Cyl, 3.339in./84.8mm (1982-1986) **18**

Part	Year	VIN	Model/Application	Part Number	Qty.
ENGINE GASKETS					
Head Set	1982-1986		(Head Bolts Not Included, Exhaust Pipe Gasket Not Included)	HS3721	1
			(Contains Head Bolts, Exhaust Pipe Gasket Not Included)	HS3721WB	1
Full Set	1982-1986		(Head Bolts Not Included, Exhaust Pipe Gasket Not Included)	FS3721	1
Engine Kit Gasket Set	1982-1986			95-3405VR	1
Cylinder Head Gasket	1982-1986		<i>Nitroseal</i>	3721	1
Cyl. Head Bolt Set	1982-1986			GS33222	1
Cyl. Head Spacer Shim	1982-1986		Requires Sealing Compound <i>Steel</i>	3721S	1
Sealing Compound	1982-1986		(4 Ounce Brush Top Can)	JV66B	1
			(12 Ounce Spray Can)	JV66S	1
Valve Cover Set	1982-1986		<i>Cork Rubber</i>	VS38326	1
Valve Stem Seal, Exh.	1982-1986			B45613	4
Valve Stem Seal, Int.	1982-1986			B45613	4
Manifold Set, Exhaust	1982-1986			MS12288	1
Manifold Set, Intake	1982-1986			MS12289	1
Oil Pan Set	1982-1986		<i>Cork Rubber</i>	OS30587	1
Rear Main Seal Set	1982-1986			JV519	1
Crank Repair Sleeve	1982-1986		Use With Part Number A507, Rear <i>Nickel Plated Formed Steel, .013" Thickness</i>	A343	1
			Front <i>Nickel Plated Formed Steel, .013" Thickness</i>	A345	1
Timing Cover Set	1982-1986		(Contains Oil Pump Seal, Contains Oil Pump Gasket And Water Pump Seal)	JV985	1

General Motors Corp.

18 110 CID (1.8L) LH8 OHC Pontiac 4 Cyl, 3.339in./84.8mm (1982-1986) **18**
 (cont.) (cont.)

Part Year VIN Model/Application Part Number Qty.

ENGINE GASKETS (cont.)

Timing Cover Seal	1982-1986			47952	1
Harmonic Balancer Repair Sleeve	1982-1986		Use With Part Number A508, Front <i>Nickel Plated Formed Steel, .013" Thickness</i>	A345	1

MISCELLANEOUS GASKETS

Harmonic Balancer Repair Sleeve	1982-1986		Use With Part Number A508, Front <i>Nickel Plated Formed Steel, .013" Thickness</i>	A345	1
Air Cleaner Mount Gasket	1982-1986		Throttle Body Injection	G26803	1
	1982-1985		Throttle Body Injection	G26803	1
Camshaft Seal	1982-1986			47950	1
E.G.R. Gasket	1982-1986			G26985	1
Exhaust Pipe Gasket	1984-1986		(Ring Type 'E'), Pipe To Manifold	F7267	1
	1983		(Ring Type 'F'), Pipe To Manifold	F7209	1
	1982		(Ring Type 'E'), Pipe To Manifold	F7267	1
Fuel Pump Gasket	1982-1986			D27262	1
Therm. Housing Gasket	1982-1986			C31325	1
Thermostat Seal	1982-1986		(O-Ring Type)	C31556	1
Throttle Body Gasket	1985-1986		Throttle Body To Adapter	G31375	1
			Adapter To Manifold	G31376	1
	1984		Bottom, Inner, Throttle Body Injection To Manifold	G26829	1
	1982-1984		Bottom, Inner, Throttle Body Injection To Manifold	G26828	1
			Bottom, Outer, Throttle Body Injection To Manifold	G26829	1
			Throttle Body Injection To Manifold, Top	G26830	1
Water Outlet Gasket	1982-1986			C24120	1
			(O-Ring Type)	C31398	1
Water Pump Mount Gasket	1982-1986			K31188	1

19 111 CID (1.8L) LJ5 SOHC Isuzu Diesel 4 Cyl, 3.307in./84mm (1981-1986) **19**

Part Year VIN Model/Application Part Number Qty.

ENGINE GASKETS

Head Set	1981-1986		(Exhaust Pipe Gasket Not Included)	HS3706	1
Full Set	1981-1986		(Exhaust Pipe Gasket Not Included)	FS3706	1
Cylinder Head Gasket	1981-1986			3706	1
Valve Cover Set	1981-1986		<i>Victo-Tech</i>	VS39364	1
Valve Stem Seal, Exh.	1981-1986			B20183	4
Valve Stem Seal, Int.	1981-1986			B20183	4
Manifold Set, Exhaust	1981-1986			MS15325	1
Manifold Set, Intake	1981-1986			MS15324	1
Oil Pan Set	1981-1986		<i>Victo-Tech</i>	OS30574	1
Rear Main Seal Set	1981-1986			JV525	1
Timing Cover Set	1981-1986			JV986	1
Timing Cover Seal	1981-1986			47927	1

MISCELLANEOUS GASKETS

Air Cleaner Mount Gasket	1981-1986		Indirect Injection	G27098	1
Camshaft Seal	1981-1986			47953	1
Cylinder Head End Plug	1981-1986			B24165	1
Exhaust Pipe Gasket	1981-1986			F7210	1
Water Outlet Gasket	1981-1986			C26651	1
Water Pump Mount Gasket	1981-1986		Cover To Block	K27378	1
			Pump To Cover	K27399	1

PASSENGER CAR

20 112 CID (1.8L) L46 Chevrolet 4 Cyl, 3.504in./89mm (1982) **20**

Part	Year	VIN	Model/Application	Part Number	Qty.
ENGINE GASKETS					
Head Set	1982		(Head Bolts Not Included, Exhaust Pipe Gasket Not Included)	HS3660	1
Full Set	1982		(Head Bolts Not Included, 11mm Wide Rear Seal Not Included, Exhaust Pipe Gasket Not Included)	FS3660	1
Engine Kit Gasket Set	1982		(Optional 1 Piece Rear Main Seal Not Included), Use With Part Number JV531	95-3401VR	1
Cylinder Head Gasket	1982		<i>Solicor</i>	3660	1
Cyl. Head Bolt Set	1982			GS33284	1
Valve Cover Set	1982		<i>Cork Rubber</i>	VS39362	1
Valve Stem Seal, Exh.	1982			B45411	4
Valve Stem Seal, Int.	1982			B45410	4
Manifold Set, Exhaust	1982			MS15331	1
Manifold Set, Intake	1982			MS15330	1
Oil Pan Set	1982		<i>Cork Rubber</i>	OS30939	1
Rear Main Seal Set	1982		(2 Piece, Not Contained In Full Set)	JV526	1
			(Contained In Full Set) <i>5mm Wide</i>	JV531	1
			(Not Contained In Full Set) <i>11mm Wide</i>	JV544	1
			<i>Teflon, 11mm Wide</i>	JV1633	1
Timing Cover Set	1982		(Repair Sleeve Not Included)	JV969	1
			(Contains Repair Sleeve)	JV1133	1
Timing Cover Gasket	1982			T27647	1
Timing Cover Seal	1982			48277SF	1
Harmonic Balancer Repair Sleeve	1982		Use With Part Number A504 <i>Nickel Plated Formed Steel, .013" Thickness</i>	A228	1

MISCELLANEOUS GASKETS

Air Cleaner Mount Gasket	1982		2 Barrel Carburetor	G26672	1
Dist. Mounting Gasket	1982			B25934	1
E.G.R. Gasket	1982			G26748	1
Exhaust Pipe Gasket	1982		(Ring Type 'E')	F7267	1
Fuel Pump Gasket	1982			D27094	1
			<i>Tuff-Cork</i>	D27094TC	1
Water Outlet Gasket	1982			C24118	1
			Water Outlet Adapter	C24120	1
Water Pump Mount Gasket	1982			K27392	1

21 121 CID (2.0L) LL8 Chevrolet 4 Cyl, 3.504in./89mm (1987-1989) **21**

Part	Year	VIN	Model/Application	Part Number	Qty.
ENGINE GASKETS					
Head Set	1987-1989		1st Design Intake Manifold With Casting Number 10103651, (Head Bolts Not Included, Exhaust Pipe Gasket Not Included)	HS5871	1
			2nd Design Intake Manifold With Casting Number 10198899, (Head Bolts Not Included, Exhaust Pipe Gasket Not Included)	HS5871A	1
Lower Set	1987-1989		(Requires Head Set To Make Full Set)	CS5871	1
Full Set	1987-1989		1st Design Intake Manifold With Casting Number 10103651, (Head Bolts Not Included, Exhaust Pipe Gasket Not Included)	FS5871	1
			2nd Design Intake Manifold With Casting Number 10198899, (Head Bolts Not Included, Exhaust Pipe Gasket Not Included)	FS5871A	1
Engine Kit Gasket Set	1987-1989			95-3445VR	1
Cylinder Head Gasket	1987-1989		<i>Nitroseal</i>	5871G	1
Cyl. Head Spacer Shim	1987-1989		Requires Sealing Compound <i>Steel</i>	5871S	1
Sealing Compound	1987-1989		(4 Ounce Brush Top Can)	JV66B	1
			(12 Ounce Spray Can)	JV66S	1

General Motors Corp.

21 (cont.)	121 CID (2.0L) LL8 Chevrolet 4 Cyl, 3.504in./89mm (1987-1989)				21 (cont.)
----------------------	--	--	--	--	----------------------

<i>Part</i>	<i>Year</i>	<i>VIN</i>	<i>Model/Application</i>	<i>Part Number</i>	<i>Qty.</i>
ENGINE GASKETS (cont.)					
Valve Cover Set	1987-1989		<i>Victo-Tech</i>	VS50051	1
Valve Stem Seal, Exh.	1987-1989			B45411	4
Valve Stem Seal, Int.	1987-1989			B45410	4
Manifold Set, Exhaust	1987-1989			MS15440	1
Manifold Set, Intake	1987-1989		1st Design Intake Manifold With Casting Number 10103651	MS15589	1
			2nd Design Intake Manifold With Casting Number 10198899, (Contains Plenum Chamber Gasket)	MS15687	1
Plenum Chamber Gasket	1987-1989			MS15687A	1
Oil Pan Set	1987-1989		<i>Cork Rubber</i>	OS32120	1
Rear Main Seal Set	1987-1989		<i>11mm Wide</i>	JV544	1
			<i>Teflon, 11mm Wide</i>	JV1633	1
Crank Repair Sleeve	1987-1989		Use With Part Number A510		
			<i>Nickel Plated Formed Steel, .013" Thickness</i>	A337	1
Timing Cover Set	1987-1989			JV1061	1
Timing Cover Gasket	1987-1989			T31351	1
Timing Cover Seal	1987-1989			48277SF	1
Harmonic Balancer Repair Sleeve	1987-1989		<i>Ground Steel, .020" Thickness</i>	66597RS	1
			Use With Part Number A504		
			<i>Nickel Plated Formed Steel, .013" Thickness</i>	A228	1

MISCELLANEOUS GASKETS					
Air Cleaner Mount Gasket	1987-1989		Throttle Body Injection	G31374	1
Dist. Mounting Gasket	1987			72214	1
E.G.R. Gasket	1987-1989			G17797	1
Exhaust Pipe Gasket	1987-1989		(Ring Type 'F'), Pipe To Manifold	F7448	1
Thermostat O-Ring	1987-1989		<i>Victo-Tech</i>	C31156	1
Throttle Body Gasket	1987-1989			G30965	1
Water Outlet Gasket	1987-1989		Water Outlet Adapter	C24152	1
Water Pump Mount Gasket	1987-1989			K30814	1

22	121 CID (2.0L) LQ5 Chevrolet 4 Cyl, 3.504in./89mm (1983-1986)				22
-----------	--	--	--	--	-----------

<i>Part</i>	<i>Year</i>	<i>VIN</i>	<i>Model/Application</i>	<i>Part Number</i>	<i>Qty.</i>
ENGINE GASKETS					
Head Set	1985-1986		(Head Bolts Not Included, Exhaust Pipe Gasket Not Included)	HS3751	1
	1983-1984		(Head Bolts Not Included, Exhaust Pipe Gasket Not Included)	HS3660	1
Full Set	1985-1986		(Head Bolts Not Included, Exhaust Pipe Gasket Not Included)	FS3751	1
	1983-1984		(Head Bolts Not Included, 11mm Wide Rear Seal Not Included, Contains 5.5 Wide Rear Main Seal, Exhaust Pipe Gasket Not Included)	FS3660	1
Engine Kit Gasket Set	1985-1986			95-3419VR	1
	1984		1st Design, 5.5mm Wide Rear Main Seal, (Optional 1 Piece Rear Main Seal Not Included), Use With Part Number JV531	95-3401VR	1
			11mm Wide Rear Main Seal, 2nd Design	95-3419VR	1
	1983		(Optional 1 Piece Rear Main Seal Not Included), Use With Part Number JV531	95-3401VR	1
Cylinder Head Gasket	1985-1986		<i>Solicor</i>	3751	1
	1983-1984		<i>Solicor</i>	3660	1
Cyl. Head Bolt Set	1983-1986			GS33284	1
Valve Cover Set	1983-1986		<i>Cork Rubber</i>	VS39362	1
Valve Stem Seal, Exh.	1983-1986			B45411	4
Valve Stem Seal, Int.	1983-1986			B45410	4

22 121 CID (2.0L) LQ5 Chevrolet 4 Cyl, 3.504in./89mm (1983-1986) **22**
(cont.) (cont.)

Part	Year	VIN	Model/Application	Part Number	Qty.
ENGINE GASKETS (cont.)					
Manifold Set, Exhaust	1983-1986			MS15331	1
Manifold Set, Intake	1983-1986			MS15330	1
Oil Pan Set	1983-1986		Cork Rubber	OS30939	1
Rear Main Seal Set	1983-1986		11mm Wide	JV544	1
			Teflon, 11mm Wide	JV1633	1
	1983-1984	(2 Piece)		JV526	1
			5mm Wide	JV531	1
Crank Repair Sleeve	1983-1986		Use With Part Number A510 Nickel Plated Formed Steel, .013" Thickness	A337	1
Timing Cover Set	1983-1986		(Repair Sleeve Not Included)	JV969	1
			(Contains Repair Sleeve)	JV1133	1
Timing Cover Gasket	1983-1986			T27647	1
Timing Cover Seal	1983-1986			48277SF	1
Harmonic Balancer Repair Sleeve	1983-1986		Ground Steel, .020" Thickness	66597RS	1
			Use With Part Number A504 Nickel Plated Formed Steel, .013" Thickness	A228	1

MISCELLANEOUS GASKETS

Air Cleaner Mount Gasket	1983-1986		Throttle Body Injection	G26672	1
Dist. Mounting Gasket	1983-1986			72214	1
E.G.R. Gasket	1983-1986			G26748	1
Exhaust Pipe Gasket	1985-1986		(Ring Type 'F'), Pipe To Manifold	F7209	1
	1983-1984		(Ring Type 'E'), Pipe To Manifold	F7267	1
Throttle Body Gasket	1983-1986			G31363	1
Water Outlet Gasket	1983-1986			C24118	1
			Water Outlet Adapter	C24152	1
Water Pump Mount Gasket	1983-1986			K27392	1

23 121 CID (2.0L) LR9 Chevrolet 4 Cyl, 3.504in./89mm (1983-1984) **23**

Part	Year	VIN	Model/Application	Part Number	Qty.
ENGINE GASKETS					
Head Set	1983-1984		(Head Bolts Not Included, Exhaust Pipe Gasket Not Included)	HS3660	1
Full Set	1983-1984		(Head Bolts Not Included, 11mm Wide Rear Seal Not Included, Contains 5.5 Wide Rear Main Seal, Exhaust Pipe Gasket Not Included)	FS3660	1
Engine Kit Gasket Set	1984		1st Design, 5.5mm Wide Rear Main Seal, (Optional 1 Piece Rear Main Seal Not Included), Use With Part Number JV531	95-3401VR	1
			11mm Wide Rear Main Seal, 2nd Design	95-3419VR	1
	1983		(Optional 1 Piece Rear Main Seal Not Included), Use With Part Number JV531	95-3401VR	1
Cylinder Head Gasket	1983-1984		Solicor	3660	1
Cyl. Head Bolt Set	1983-1984			GS33284	1
Valve Cover Set	1983-1984		Cork Rubber	VS39362	1
Valve Stem Seal, Exh.	1983-1984			B45411	4
Valve Stem Seal, Int.	1983-1984			B45410	4
Manifold Set, Exhaust	1983-1984			MS15331	1
Manifold Set, Intake	1983-1984			MS15330	1
Oil Pan Set	1983-1984		Cork Rubber	OS30939	1
Rear Main Seal Set	1983-1984	(2 Piece)		JV526	1
			5mm Wide	JV531	1
			11mm Wide	JV544	1
			Teflon, 11mm Wide	JV1633	1
Crank Repair Sleeve	1983-1984		Use With Part Number A510 Nickel Plated Formed Steel, .013" Thickness	A337	1

General Motors Corp.

23 (cont.)	121 CID (2.0L) LR9 Chevrolet 4 Cyl, 3.504in./89mm (1983-1984)				23 (cont.)
----------------------	--	--	--	--	----------------------

Part	Year	VIN	Model/Application	Part Number	Qty.
------	------	-----	-------------------	-------------	------

ENGINE GASKETS (cont.)

Timing Cover Set	1983-1984		(Repair Sleeve Not Included)	JV969	1
			(Contains Repair Sleeve)	JV1133	1
Timing Cover Gasket	1983-1984			T27647	1
Timing Cover Seal	1983-1984			48277SF	1
Harmonic Balancer Repair Sleeve	1983-1984		<i>Ground Steel, .020" Thickness</i>	66597RS	1
			Use With Part Number A504 <i>Nickel Plated Formed Steel, .013" Thickness</i>	A228	1

MISCELLANEOUS GASKETS

Air Cleaner Mount Gasket	1983-1984		2 Barrel Carburetor	G26672	1
Dist. Mounting Gasket	1983-1984			72214	1
E.G.R. Gasket	1983-1984			G26748	1
Exhaust Pipe Gasket	1983-1984		(Ring Type 'E'), Pipe To Manifold	F7267	1
Throttle Body Gasket	1983-1984			G31363	1
Water Outlet Gasket	1983-1984			C24118	1
			Water Outlet Adapter	C24152	1
Water Pump Mount Gasket	1983-1984			K27392	1

24	122 CID (2.0L) OHC Pontiac 4 Cyl, 3.386in./86mm (1987-1994)				24
-----------	--	--	--	--	-----------

Part	Year	VIN	Model/Application	Part Number	Qty.
------	------	-----	-------------------	-------------	------

ENGINE GASKETS

Head Set	1987-1994		(Head Bolts Not Included, Exhaust Pipe Gasket Not Included)	HS5778	1
			(Contains Head Bolts, Exhaust Pipe Gasket Not Included)	HS5778WB	1
Full Set	1987-1994		(Head Bolts Not Included, Exhaust Pipe Gasket Not Included)	FS5778	1
Engine Kit Gasket Set	1987-1994			95-3251VR	1
Cylinder Head Gasket	1987-1994		<i>Nitroseal</i>	5779	1
Cyl. Head Bolt Set	1987-1994			GS33189	1
Cyl. Head Spacer Shim	1987-1994		Requires Sealing Compound <i>Steel</i>	5779S	1
Sealing Compound	1987-1994		(4 Ounce Brush Top Can)	JV66B	1
			(12 Ounce Spray Can)	JV66S	1
Valve Cover Set	1987-1994		<i>Cork Rubber</i>	VS38326	1
			<i>Tuff-Cork</i>	VS38326TC	1
Valve Stem Seal, Exh.	1987-1994			B45625	4
Valve Stem Seal, Int.	1987-1994			B45625	4
Manifold Set, Exhaust	1987-1994			MS12288	1
Manifold Set, Intake	1987-1994			MS15538	1
Oil Pan Set	1987-1994		<i>Tuff-Cork</i>	OS32480	1
Rear Main Seal Set	1987-1994			JV571	1
Crank Repair Sleeve	1987-1994		Except Crankshaft Number 902280399, Use With Part Number A507, Rear <i>Nickel Plated Formed Steel, .013" Thickness</i>	A343	1
			Crankshaft Number 902280399 <i>Nickel Plated Formed Steel, .013" Thickness</i>	A347	1
Timing Cover Set	1987-1994			JV985	1
Timing Cover Seal	1987-1994			47952	1
Harmonic Balancer Repair Sleeve	1987-1994		Use With Part Number A508 <i>Nickel Plated Formed Steel, .013" Thickness</i>	A345	1

MISCELLANEOUS GASKETS

Camshaft Seal	1987-1994			47950	1
E.G.R. Gasket	1987-1994			G17797	1
Exhaust Pipe Gasket	1991-1994		Catalytic Converter <i>51mm Inside Diameter</i>	F10131	2
	1987-1994		(Ring Type 'E'), Pipe To Manifold	F7267	1

24 122 CID (2.0L) OHC Pontiac 4 Cyl, 3.386in./86mm (1987-1994) **24**
(cont.) (cont.)

Part	Year	VIN	Model/Application	Part Number	Qty.
MISCELLANEOUS GASKETS (cont.)					
Exhaust Pipe Gasket (cont.)	1990		Catalytic Converter, Rear <i>51mm Inside Diameter</i>	F10131	1
			Catalytic Converter, Front	F10132	1
Throttle Body Gasket	1992-1994			G31410	1
	1989-1991			G31135	1
Water Outlet Gasket	1987-1994		<i>Tuff-Cork</i>	C31187TC	1
Water Pump Mount Gasket	1987-1994			K31188	1

25 122 CID (2.0L) OHC Turbo Pontiac 4 Cyl, 3.386in./86mm (1987-1990) **25**

Part	Year	VIN	Model/Application	Part Number	Qty.
ENGINE GASKETS					
Head Set	1987-1990		(Head Bolts Not Included, Exhaust Pipe Gasket Not Included, Exhaust Manifold Gasket Not Included)	HS5778	1
			(Contains Head Bolts, Exhaust Pipe Gasket Not Included, Exhaust Manifold Gasket Not Included)	HS5778WB	1
Full Set	1987-1990		(Head Bolts Not Included, Exhaust Pipe Gasket Not Included, Exhaust Manifold Gasket Not Included)	FS5778	1
Engine Kit Gasket Set	1987-1990		(Exhaust Manifold Gasket Not Included), Use With Part Number MS15590	95-3251VR	1
Cylinder Head Gasket	1987-1990		<i>Nitroseal</i>	5779	1
Cyl. Head Bolt Set	1987-1990			GS33189	1
Cyl. Head Spacer Shim	1987-1990		Requires Sealing Compound <i>Steel</i>	5779S	1
Sealing Compound	1987-1990		(4 Ounce Brush Top Can)	JV66B	1
			(12 Ounce Spray Can)	JV66S	1
Valve Cover Set	1987-1990		<i>Cork Rubber</i>	VS38326	1
			<i>Tuff-Cork</i>	VS38326TC	1
Valve Stem Seal, Exh.	1987-1990			B45625	4
Valve Stem Seal, Int.	1987-1990			B45625	4
Manifold Set, Exhaust	1987-1990			MS15590	1
Manifold Set, Intake	1987-1990			MS15538	1
Oil Pan Set	1987-1990		<i>Tuff-Cork</i>	OS32480	1
Rear Main Seal Set	1987-1990			JV571	1
Crank Repair Sleeve	1987-1990		Except Crankshaft Number 902280399, Use With Part Number A507, Rear <i>Nickel Plated Formed Steel, .013" Thickness</i>	A343	1
			Crankshaft Number 902280399, Rear <i>Nickel Plated Formed Steel, .013" Thickness</i>	A347	1
Timing Cover Set	1987-1990			JV985	1
Timing Cover Seal	1987-1990			47952	1
Harmonic Balancer Repair Sleeve	1987-1990		Use With Part Number A508 <i>Nickel Plated Formed Steel, .013" Thickness</i>	A345	1

MISCELLANEOUS GASKETS

Camshaft Seal	1987-1990	M		47950	1
E.G.R. Gasket	1987-1990	M		G17797	1
Exhaust Pipe Gasket	1990	M	Catalytic Converter, Rear <i>51mm Inside Diameter</i>	F10131	1
		M	Catalytic Converter, Front	F10132	1
	1987-1990	M	(Ring Type 'E'), Pipe To Manifold	F7267	1
Throttle Body Gasket	1989-1990	M		G31135	1
	1987-1988	M		G30968	1
Turbo Mounting Set	1987-1990	M		GS33273	1
Water Outlet Gasket	1987-1990	M	<i>Tuff-Cork</i>	C31187TC	1
Water Pump Mount Gasket	1987-1990	M		K31188	1

General Motors Corp.

26 134 CID (2.2L) LM3 Chevrolet 4 Cyl, 3.504in./89mm (1990-1991)

26

Part	Year	VIN	Model/Application	Part Number	Qty.
ENGINE GASKETS					
Head Set	1990-1991		1st Design Intake Manifold With Casting Number 10103651, (Head Bolts Not Included, Exhaust Pipe Gasket Not Included)	HS5871	1
			2nd Design Intake Manifold With Casting Number 10198899, (Head Bolts Not Included, Exhaust Pipe Gasket Not Included)	HS5871A	1
			1st Design Intake Manifold With Casting Number 10103651, (Contains Head Bolts, Exhaust Pipe Gasket Not Included)	HS5871WB	1
Lower Set	1990-1991		(Requires Head Set To Make Full Set)	CS5871	1
Full Set	1990-1991		1st Design Intake Manifold With Casting Number 10103651, (Head Bolts Not Included, Exhaust Pipe Gasket Not Included)	FS5871	1
			2nd Design Intake Manifold With Casting Number 10198899, (Head Bolts Not Included, Exhaust Pipe Gasket Not Included)	FS5871A	1
Engine Kit Gasket Set	1990-1991		1st Design Intake Manifold With Casting Number 10103651	95-3445VR	1
Cylinder Head Gasket	1990-1991		<i>Nitroseal</i>	5871G	1
Cyl. Head Bolt Set	1990-1991			GS33267	1
Cyl. Head Spacer Shim	1990-1991		Requires Sealing Compound	<i>Steel</i> 5871S	1
Sealing Compound	1990-1991		(4 Ounce Brush Top Can)	JV66B	1
			(12 Ounce Spray Can)	JV66S	1
Valve Cover Set	1990-1991		<i>Victo-Tech</i>	VS50051	1
Valve Stem Seal, Exh.	1990-1991			B45411	4
Valve Stem Seal, Int.	1990-1991			B45410	4
Manifold Set, Exhaust	1990-1991			MS15440	1
Manifold Set, Intake	1990-1991		1st Design Intake Manifold With Casting Number 10103651	MS15589	1
			2nd Design Intake Manifold With Casting Number 10198899, (Contains Plenum Chamber Gasket)	MS15687	1
Oil Pan Set	1990-1991		<i>Cork Rubber</i>	OS32120	1
Rear Main Seal Set	1990-1991			JV544	1
				<i>Teflon</i> JV1633	1
Timing Cover Set	1990-1991			JV1061	1
Timing Cover Seal	1990-1991			48277SF	1

MISCELLANEOUS GASKETS

Air Cleaner Mount Gasket	1990-1991			G31374	1
E.G.R. Gasket	1990-1991			G17797	1
Exhaust Pipe Gasket	1990-1991		(Ring Type 'F'), Pipe To Manifold	F7448	1
			Catalytic Converter	<i>51mm Inside Diameter</i> F10131	1
Oil Pan Drain Plug Gst.	1990-1991			2051	1
Thermostat O-Ring	1990-1991		<i>Victo-Tech</i>	C31156	1
Water Outlet Gasket	1990-1991			C31408	1
Water Pump Mount Gasket	1990-1991			K30814	1

27 134 CID (2.2L) LN2/KL6 Chevrolet Bi-Fuel Gasoline/Compressed Natural Gas 4 Cyl, 3.504in./89mm (2000-2002)

27

Part	Year	VIN	Model/Application	Part Number	Qty.
ENGINE GASKETS					
Head Set	2000-2002		(Head Bolts Not Included, Exhaust Pipe Gasket Not Included)	HS54051	1
Cylinder Head Gasket	2000-2002		<i>Nitroseal</i>	54051	1
Cyl. Head Bolt Set	2000-2002			GS33294	1
Valve Cover Set	2000-2002		<i>Victo-Tech</i>	VS50249	1
Valve Stem Seal, Exh.	2000-2002			B45864	4
Valve Stem Seal, Int.	2000-2002			B45864	4
Manifold Set, Exhaust	2000-2002			MS16311	1

27 134 CID (2.2L) LN2/KL6 Chevrolet Bi-Fuel Gasoline/Compressed Natural Gas 4 Cyl, 3.504in./89mm (2000-2002) **27**
(cont.) (cont.)

Part	Year	VIN	Model/Application	Part Number	Qty.
ENGINE GASKETS (cont.)					
Manifold Set, Intake	2001-2002		To Be Replaced By MS16507	MS16313	1
	2000-2002			MS16507	1
Oil Pan Set	2000-2002			Cork Rubber OS32120	1
Rear Main Seal Set	2000-2002			JV544	1
				Teflon JV1633	1

28 134 CID (2.2L) OHV Chevrolet 4 Cyl, 3.504in./89mm (1992-2002) **28**

Part	Year	VIN	Model/Application	Part Number	Qty.
ENGINE GASKETS					
Head Set	1998-2002		(Head Bolts Not Included, Exhaust Pipe Gasket Not Included)	HS54051	1
	1993-1997		(Head Bolts Not Included, Contains 7mm Valve Stem Seal, Exhaust Pipe Gasket Not Included)	HS5871B	1
	1992-1993		(Head Bolts Not Included, Contains 8mm Valve Stem Seals, Exhaust Pipe Gasket Not Included)	HS5871A	1
Lower Set	1992-2002		(Requires Head Set To Make Full Set)	CS5871	1
Full Set	1992-1993		(Head Bolts Not Included, Contains 8mm Valve Stem Seals, Exhaust Pipe Gasket Not Included)	FS5871A	1
Engine Kit Gasket Set	1993-1997		(Contains 7mm Valve Stem Seal)	95-3494VR	1
	1992-1993		(Contains 8mm Valve Stem Seals, Intake Manifold Gasket Not Included), Use With Part Number MS15687	95-3445VR	1
Cylinder Head Gasket	1998-2002			Nitroseal 54051	1
	1992-1997			Nitroseal 5871G	1
Cyl. Head Bolt Set	1998-2002			GS33362	1
	1995-1997			GS33295	1
	1993-1997			GS33294	1
	1992			GS33267	1
Cyl. Head Spacer Shim	1992-1997		Requires Sealing Compound	Steel 5871S	1
Sealing Compound	1992-1997		(4 Ounce Brush Top Can) (12 Ounce Spray Can)	JV66B	1
				JV66S	1
Valve Cover Set	1998-2002			Victo-Tech VS50249	1
	1992-1997			Victo-Tech VS50051	1
Valve Stem Seal, Exh.	1998-2002			B45864	4
	1993-1997		7mm Valve Stem Diameter	B45814	4
	1992-1993		8mm Valve Stem Diameter	B45411	4
Valve Stem Seal, Int.	1998-2002			B45864	4
	1993-1997		7mm Valve Stem Diameter	B45814	4
	1992-1993		8mm Valve Stem Diameter	B45410	4
Manifold Set, Exhaust	1998-2002			MS16311	1
	1992-1997			MS15440	1
Manifold Set, Intake	2001-2002		To Be Replaced By MS16507	MS16313	1
	1998-2002			MS16507	1
	1992-1997		(Contains Plenum Chamber Gasket)	MS15687	1
Plenum Chamber Gasket	1992-1997			MS15687A	1
Oil Pan Set	1992-2002			Cork Rubber OS32120	1
Rear Main Seal Set	1992-2002			JV544	1
				Teflon JV1633	1
Timing Cover Set	1992-2001			JV1061	1
Timing Cover Gasket	1992-2002			T31351	1
Timing Cover Seal	1992-2002			48277SF	1

MISCELLANEOUS GASKETS

E.G.R. Gasket	1999-2000		(Adapter), Cover To Cylinder Head, Intake Side	G31525	1
	1996-1998		Valve To Adapter	G31356	1
	1992-1995			G17797	1
Exhaust Pipe Gasket	1992-2002		Catalytic Converter	51mm Inside Diameter F10131	2

General Motors Corp.

28 134 CID (2.2L) OHV Chevrolet 4 Cyl, 3.504in./89mm (1992-2002) **28**
(cont.) (cont.)

Part	Year	VIN	Model/Application	Part Number	Qty.
MISCELLANEOUS GASKETS (cont.)					
Exhaust Pipe Gasket (cont.)	1995-1996		Sunfire, (Ring Type 'E'), Pipe To Manifold	F7267	1
	1994-1996		Beretta, Cavalier, Corsica, (Ring Type 'E'), Pipe To Manifold	F7267	1
	1993		Century, Cutlass Ciera, (Flange Type), Pipe To Manifold	F7280	1
			Beretta, Corsica, (Ring Type 'F'), Pipe To Manifold	F7517	1
	1992-1993		Cavalier, (Ring Type 'F'), Pipe To Manifold	F7210	1
	1992		Beretta, Corsica, With Adapter, (Ring Type 'E'), Pipe To Manifold	F7271	1
		Beretta, Corsica, Except With Adapter, (Ring Type 'F'), Pipe To Manifold	F7516	1	
Oil Pan Drain Plug Gst.	1998-2002			B45828	1
	1992-1997			2051	1
Oil Pan Seal	1992-2002		Rear	B45598	1
Therm. Housing Gasket	1995-1997		Adapter To Cylinder Head	C31414	1
Thermostat O-Ring	1992-2002		<i>Victo-Tech</i>	C31156	1
Throttle Body Gasket	1998-2002			G31524	1
Water Inlet Gasket	1992-2002		Inlet To Cylinder Block	C31275	1
Water Outlet Gasket	1992-1997			C31408	1
Water Pump Mount Gasket	1995-2002			K31274	1
	1992-1994			K30814	1

29 138 CID (2.3L) DOHC Oldsmobile 4 Cyl, 3.622in./92mm (1987-1995) **29**

Part	Year	VIN	Model/Application	Part Number	Qty.
ENGINE GASKETS					
Head Set	1995		2nd Design: Seals Fit Into Grooves In Camshaft Housing Cover, 2nd Design: With 21 Hole Timing Cover Gasket 3.40mm Thick, (Head Bolts Not Included)	HS5870C	1
	1992-1994		2nd Design: Seals Fit Into Grooves In Camshaft Housing Cover, 2nd Design: With 21 Hole Timing Cover Gasket 3.40mm Thick, (Head Bolts Not Included, Exhaust Pipe Gasket Not Included)	HS5870A	1
			1st Design: Seals Fit Into Grooves In Camshaft Housing, 1st Design: With 20 Hole Timing Cover Gasket 0.70mm Thick, (Head Bolts Not Included, Exhaust Pipe Gasket Not Included)	HS5870	1
			1st Design: Seals Fit Into Grooves In Camshaft Housing, 1st Design: With 20 Hole Timing Cover Gasket 0.70mm Thick, (Contains Head Bolts, Exhaust Pipe Gasket Not Included)	HS5870WB	1
Lower Set	1995		(Requires Head Set To Make Full Set)	CS5870A	1
	1987-1994		(Requires Head Set To Make Full Set)	CS5870	1
Full Set	1987-1991		1st Design: Seals Fit Into Grooves In Camshaft Housing, 1st Design: With 20 Hole Timing Cover Gasket 0.70mm Thick, (Head Bolts Not Included, Exhaust Pipe Gasket Not Included)	FS5870	1
Engine Kit Gasket Set	1992-1993		2nd Design: With 21 Hole Timing Cover Gasket 3.40mm Thick, (Timing Cover Set Not Included), Use With Part Number JV1167	95-3448VR	1
	1987-1991		1st Design: With 20 Hole Timing Cover Gasket 0.70mm Thick	95-3448VR	1
Cylinder Head Gasket	1987-1995		<i>Nitroseal</i>	5870	1
Cyl. Head Bolt Set	1987-1995			GS33239	1
Valve Cover Set	1995	D	Intake Camshaft Carrier	VS50245	1
	1992-1995		2nd Design: Seals Fit Into Grooves In Camshaft Housing Cover, Exhaust Camshaft Carrier	VS50204	1
	1992-1994		2nd Design: Seals Fit Into Grooves In Camshaft Housing Cover, (Contains Camshaft Seal), Intake Camshaft Carrier	VS50205	1
	1987-1993		1st Design: Seals Fit Into Grooves In Camshaft Housing, Exhaust Camshaft Carrier	VS50113	1

PASSENGER CAR

29 138 CID (2.3L) DOHC Oldsmobile 4 Cyl, 3.622in./92mm (1987-1995) **29**
(cont.) (cont.)

Part Year VIN Model/Application Part Number Qty.

ENGINE GASKETS (cont.)

Valve Cover Set (cont.)	1987-1993		1st Design: Seals Fit Into Grooves In Camshaft Housing, (Contains Camshaft Seal), Intake Camshaft Carrier	VS50114	1
Valve Stem Seal, Exh.	1987-1995			B45672	8
Valve Stem Seal, Int.	1987-1995			B45672	8
Manifold Set, Exhaust	1995			MS16142	1
	1993-1994			MS16135	1
	1987-1992			MS12374	1
Manifold Set, Intake	1987-1995			MS15636	1
Oil Pan Set	1995			OS32150	1
	1987-1994		Tuff-Cork	OS32094	1
Rear Main Seal Set	1987-1995			JV596	1
Crank Repair Sleeve	1987-1995		Nickel Plated Formed Steel, .013" Thickness	A353	1
Timing Cover Set	1992-1995		2nd Design: With 21 Hole Timing Cover Gasket 3.40mm Thick	JV1167	1
	1987-1991		1st Design: With 20 Hole Timing Cover Gasket 0.70mm Thick, (Contains Timing Cover Seal And Front Cover Gasket Only)	JV1115	1
				1st Design: With 20 Hole Timing Cover Gasket 0.70mm Thick	JV1169
Timing Cover Seal	1987-1995			48176	1

MISCELLANEOUS GASKETS

Camshaft Seal	1987-1995			48174	1
Exhaust Pipe Gasket	1990-1995		Catalytic Converter 51mm Inside Diameter	F10131	1
	1987-1995	D	(Ring Type 'E'), Pipe To Manifold	F7267	1
	1989-1994	A	(Ring Type 'F'), Pipe To Manifold	F10139	1
Injector Nozzle O-Ring	1987-1995			GS33276	2
Thermostat O-Ring	1995			C31156	1
Throttle Body Gasket	1987-1995			G31113	1
Water Outlet Gasket	1987-1995			C31114	1
Water Pump Mount Set	1987-1995		(Requires Exhaust Manifold Gasket)	GS33188	1

30 138 CID (2.3L) L40 SOHC Oldsmobile 4 Cyl, 3.622in./92mm (1992-1994) **30**

Part Year VIN Model/Application Part Number Qty.

ENGINE GASKETS

Head Set	1992-1994		(Head Bolts Not Included, Exhaust Pipe Gasket Not Included)	HS5870B	1
Lower Set	1992-1994		(Requires Head Set To Make Full Set)	CS5870	1
Engine Kit Gasket Set	1992-1994			95-3468VR	1
Cylinder Head Gasket	1992-1994		Nitroseal	5870	1
Cyl. Head Bolt Set	1992-1994			GS33239	1
Valve Cover Set	1992-1994		2nd Design: Seals Fit Into Grooves In Camshaft Housing Cover, (Contains Camshaft Seal), Intake Camshaft Carrier	VS50205	1
	1992-1993		1st Design: Seals Fit Into Grooves In Camshaft Housing, (Contains Camshaft Seal), Intake Camshaft Carrier	VS50114	1
Valve Stem Seal, Exh.	1992-1994			B45672	4
Valve Stem Seal, Int.	1992-1994			B45672	4
Manifold Set, Exhaust	1992			MS12374	1
Manifold Set, Intake	1992-1994			MS15636	1
Oil Pan Set	1992-1994		Tuff-Cork	OS32094	1
Rear Main Seal Set	1992-1994			JV596	1
Crank Repair Sleeve	1992-1994		Nickel Plated Formed Steel, .013" Thickness	A353	1
Timing Cover Set	1992-1994			JV1168	1
Timing Cover Seal	1992-1994			48176	1

MISCELLANEOUS GASKETS

Camshaft Seal	1992-1994			48174	1
Exhaust Pipe Gasket	1992-1994		(Ring Type 'E'), Pipe To Manifold	F7267	1

General Motors Corp.

30 (cont.)	138 CID (2.3L) L40 SOHC Oldsmobile 4 Cyl, 3.622in./92mm (1992-1994)					30 (cont.)
----------------------	--	--	--	--	--	----------------------

Part	Year	VIN	Model/Application	Part Number	Qty.
MISCELLANEOUS GASKETS (cont.)					
Exhaust Pipe Gasket (cont.)	1992-1994		Catalytic Converter <i>51mm Inside Diameter</i>	F10131	1
Injector Nozzle O-Ring	1992-1994			GS33276	2
Throttle Body Gasket	1992-1994			G31113	1
Water Outlet Gasket	1992-1994			C31114	1
Water Pump Mount Set	1992-1994		(Requires Exhaust Manifold Gasket)	GS33188	1

31	140 CID (2.3L) Chevrolet 4 Cyl, 3.500in./88.9mm (1971-1977)					31
-----------	--	--	--	--	--	-----------

Part	Year	VIN	Model/Application	Part Number	Qty.
ENGINE GASKETS					
Head Set	1971-1977			HS3445VC	1
Full Set	1971-1977			FS3445VC	1
Engine Kit Gasket Set	1971-1977			95-3027VR	1
Cylinder Head Gasket	1971-1977		<i>VR2000</i>	3445VC	1
Valve Cover Set	1971-1977		<i>Cork Rubber</i>	VS38424	1
Valve Stem Seal, Exh.	1971-1977			B45404	4
Valve Stem Seal, Int.	1971-1977		<i>Fluoroelastomer</i>	B45418	4
Manifold Set, Exhaust	1971-1977			MS15210	1
Manifold Set, Intake	1971-1977			MS15178	1
Oil Pan Set	1971-1977		<i>Cork Rubber</i>	OS20770	1
Rear Main Seal Set	1971-1977			JV610	1
Timing Cover Set	1971-1977			JV873	1
Timing Cover Gasket	1971-1977		(Oil Pump Cover)	T27613	1
Timing Cover Seal	1971-1977			47483	1

MISCELLANEOUS GASKETS					
Air Cleaner Mount Gasket	1973-1977		2 Barrel Carburetor	G26813	1
	1971-1977		1 Barrel Carburetor	G25936	1
	1971-1972		2 Barrel Carburetor	G26617	1
Camshaft Seal	1971-1977		<i>3/8" Wide</i>	49328	1
Carb. Mount Gasket	1973-1977		(Insulator), 2 Barrel Carburetor	G25462	1
			2 Barrel Carburetor	G25469	1
	1971-1977		(Insulator), 1 Barrel Carburetor	G26718	1
			1 Barrel Carburetor	G26841	1
Dist. Mounting Gasket	1971-1977			B26466	1
E.G.R. Gasket	1971-1977			G26315	1
Water Outlet Gasket	1971-1977			C24004	1
Water Pump Mount Gasket	1971-1977			K26041	1

32	140 CID (2.3L) Chevrolet Corvair 6 Cyl, 3.375in./85.7mm (1960-1961)					32
-----------	--	--	--	--	--	-----------

Part	Year	VIN	Model/Application	Part Number	Qty.
ENGINE GASKETS					
Head Set	1960-1961			HS1170X	2
Full Set	1960-1961			FS1170X	1
Cylinder Head Gasket	1960-1961			1170	6
Valve Cover Set	1960-1961		<i>Victo-Tech</i>	VS28294	1
Manifold Set, Exhaust	1960-1961			MS7158	1
Oil Pan Set	1960-1961		<i>Cork Rubber</i>	OS30664	1
Rear Main Seal Set	1960-1961			JV646	1
Timing Cover Set	1960-1961			JV858	1
Timing Cover Seal	1960-1961			46248	1

32 140 CID (2.3L) Chevrolet Corvair 6 Cyl, 3.375in./85.7mm (1960-1961) **32**
(cont.) (cont.)

Part	Year	VIN	Model/Application	Part Number	Qty.
MISCELLANEOUS GASKETS					
Air Cleaner Mount Gasket	1960-1961		2-1 Barrel Carburetors	G25936	2
Clutch Throwout Brg. Seal	1960-1961		Inner	47447	1
Crankcase Cover Gasket	1960-1961		Top Cover	OS20604	1
Cylinder Sleeve Gasket	1960-1961		To Block	19312	6
Dist. Mounting Gasket	1960-1961			B26466	1
Exhaust Pipe Gasket	1960-1961		(Ring Type 'C'), Pipe To Manifold	F7140	2
Flywheel Housing Gasket	1960-1961			T27792	1
Flywheel Housing Oil Seal	1960-1961			46227	1
Fuel Pump Gasket	1960-1961			72210	1
Push Rod Seal	1960-1961		Push Rod To Crankcase Tube	B45314	24

33 145 CID (2.4L) Chevrolet Corvair 6 Cyl, 3.438in./87.33mm (1961-1963) **33**

Part	Year	VIN	Model/Application	Part Number	Qty.
ENGINE GASKETS					
Head Set	1961-1963			HS1170X	2
Full Set	1961-1963			FS1170X	1
Cylinder Head Gasket	1961-1963			1170	6
Valve Cover Set	1961-1963		<i>Victo-Tech</i>	VS28294	1
Manifold Set, Exhaust	1961-1963			MS7158	1
Oil Pan Set	1961-1963		<i>Cork Rubber</i>	OS30664	1
Rear Main Seal Set	1961-1963			JV646	1
Timing Cover Set	1961-1963			JV858	1
Timing Cover Seal	1961-1963			46248	1

MISCELLANEOUS GASKETS					
Air Cleaner Mount Gasket	1961-1963		2-1 Barrel Carburetors	G25936	2
Carb. Mount Gasket	1963		1 Side Draft Carburetor, Turbocharged	G7177	1
Clutch Throwout Brg. Seal	1961-1963		Inner	47447	1
Crankcase Cover Gasket	1961-1963		Top Cover	OS20604	1
Cylinder Sleeve Gasket	1961-1963		To Block	19312	6
Dist. Mounting Gasket	1961-1963			B26466	1
Engine Rear Hsg. Seal	1961-1963			46248	1
Exhaust Pipe Gasket	1961-1963		(Ring Type 'C'), Pipe To Manifold	F7140	2
Flywheel Housing Gasket	1961-1963			T27792	1
Flywheel Housing Oil Seal	1961-1963			46227	1
Fuel Pump Gasket	1961-1963			72210	1
Push Rod Seal	1961-1963		Push Rod To Crankcase Tube	B45314	24
Rocker Arm Stud Seal	1961-1963			B45315	12
Turbo Gasket	1962-1963		(Flange Type), Outlet Pipe	F7192	1
			Induction Pipe To Head	G5349AD	2

34 146 CID (2.4L) LD9 DOHC Oldsmobile 4 Cyl, 3.543in./90mm (1996-2002) **34**

Part	Year	VIN	Model/Application	Part Number	Qty.
ENGINE GASKETS					
Head Set	2000-2002		(Head Bolts Not Included)	HS54236	1
	1999		Engines With E.G.R. Valve, (Head Bolts Not Included)	HS5929	1

General Motors Corp.

34 146 CID (2.4L) LD9 DOHC Oldsmobile 4 Cyl, 3.543in./90mm (1996-2002) **34**
(cont.) (cont.)

Part	Year	VIN	Model/Application	Part Number	Qty.
ENGINE GASKETS (cont.)					
Head Set (cont.)	1999		Except Engines With E.G.R. Valve, (Head Bolts Not Included)	HS54236	1
	1996-1998		(Head Bolts Not Included)	HS5929	1
Lower Set	1996-2002		(Requires Head Set To Make Full Set)	CS5929	1
Cylinder Head Gasket	2000-2002		<i>Nitroseal</i>	54236	1
	1999		Engines With E.G.R. Valve	<i>Nitroseal</i> 5929	1
			Except Engines With E.G.R. Valve	<i>Nitroseal</i> 54236	1
1996-1998			<i>Nitroseal</i> 5929	1	
Cyl. Head Bolt Set	1996-2002			GS33365	1
Valve Cover Set	1996-2002		Exhaust Camshaft Carrier	VS50204	1
			Intake Camshaft Carrier	VS50245	1
Valve Stem Seal, Exh.	1996-2002			B45845	8
Valve Stem Seal, Int.	1996-2002			B45845	8
Manifold Set, Exhaust	2000-2002		<i>Multi-Layered Steel</i>	MS16321	1
	1999		Engines With E.G.R. Valve	<i>Multi-Layered Steel</i> MS16199	1
			Except Engines With E.G.R. Valve	<i>Multi-Layered Steel</i> MS16321	1
1996-1998			<i>Multi-Layered Steel</i> MS16199	1	
Manifold Set, Intake	1996-2002			MS16200	1
Oil Pan Set	1996-2002			OS32150	1
Rear Main Seal Set	1996-2002			JV596	1
Timing Cover Set	1996-2002			JV1205	1
Timing Cover Seal	1996-2002			48176	1

MISCELLANEOUS GASKETS

E.G.R. Gasket	1996-1999		Tube To Intake Manifold	72116	1
			Valve To Adapter	G31356	1
			Adapter To Cylinder Head	G31590	1
Exhaust Pipe Gasket	1999-2002		Pipe To Manifold	F31591	1
	1996-2002		Exhaust Pipe To Converter	F10131	1
	1996-1998		Pipe To Manifold	F7574	1
Oil Pan Drain Plug Gskt.	1996-2002			B45828	1
Thermostat O-Ring	1996-2002		<i>Victo-Tech</i>	C31156	1
Throttle Body Gasket	1996-2002			G31524	1
Water Outlet Gasket	1996-2002		<i>Victo-Tech</i>	C31522	1
Water Pump Mount Gasket	1996-2002		(Requires Exhaust Pipe Gasket, Requires Exhaust Manifold Gasket)	GS33364	1

35 151 CID (2.5L) Carbureted Pontiac 4 Cyl, 4.000in./101.6mm (1977-1983) **35**

Part	Year	VIN	Model/Application	Part Number	Qty.
ENGINE GASKETS					
Head Set	1980-1983		(Head Bolts Not Included, Exhaust Pipe Gasket Not Included)	HS3684	1
	1979	1	Except Cross Flow Cylinder Heads, Intake And Exhaust On Same Side Of Engine, (Head Bolts Not Included)	HS3538	1
		9, V		Cross Flow Cylinder Heads, Intake And Exhaust On Opposite Sides Of Engine, (Head Bolts Not Included, Exhaust Pipe Gasket Not Included)	HS3684
	1977-1978		(Head Bolts Not Included)	HS3538	1
Full Set	1980-1983		(Exhaust Pipe Gasket Not Included)	FS3684	1
	1979	1	Except Cross Flow Cylinder Heads, Intake And Exhaust On Same Side Of Engine, (Exhaust Pipe Gasket Not Included)	FS3538	1
		9, V		Cross Flow Cylinder Heads, Intake And Exhaust On Opposite Sides Of Engine, (Exhaust Pipe Gasket Not Included)	FS3684
1977-1978		(Exhaust Pipe Gasket Not Included)	FS3538	1	
Engine Kit Gasket Set	1980-1983			95-3399VR	1
	1979		Except Cross Flow Cylinder Heads, Intake And Exhaust On Same Side Of Engine	95-3060VR	1

Part	Year	VIN	Model/Application	Part Number	Qty.	
ENGINE GASKETS (cont.)						
Engine Kit Gasket Set (cont.)	1979		Cross Flow Cylinder Heads, Intake And Exhaust On Opposite Sides Of Engine	95-3399VR	1	
	1977-1978			95-3060VR	1	
Cylinder Head Gasket	1980-1983		VR2000	3684	1	
	1980-1981		(Thicker Head Gasket) VR2000	CH3548T	1	
	1979	1	Except Cross Flow Cylinder Heads, Intake And Exhaust On Same Side Of Engine	VR2000	3538	1
		9, V	Cross Flow Cylinder Heads, Intake And Exhaust On Opposite Sides Of Engine	VR2000	3684	1
		9, V	Cross Flow Cylinder Heads, Intake And Exhaust On Opposite Sides Of Engine, (Thicker Head Gasket)	VR2000	CH3548T	1
1977-1978		VR2000	3538	1		
Valve Cover Set	1980-1983		Cork Rubber	VS39354	1	
			High Temperature Tuff-Cork	VS39354HTC	1	
			Victo-Tech	VS39354R	1	
	1979	9, V	Cross Flow Cylinder Heads, Intake And Exhaust On Opposite Sides Of Engine	Cork Rubber	VS39354	1
		9, V	Cross Flow Cylinder Heads, Intake And Exhaust On Opposite Sides Of Engine	High Temperature Tuff-Cork	VS39354HTC	1
		9, V	Cross Flow Cylinder Heads, Intake And Exhaust On Opposite Sides Of Engine	Victo-Tech	VS39354R	1
		1	Except Cross Flow Cylinder Heads, Intake And Exhaust On Same Side Of Engine	Cork Rubber	VS39764	1
	1977-1978		Cork Rubber	VS39764	1	
Valve Stem Seal, Exh.	1977-1983		(O-Ring Type)	B45229	4	
Valve Stem Seal, Int.	1980-1983		Fluoroelastomer	B45418	4	
	1977-1983		(O-Ring Type)	B45229	4	
Manifold Set, Exhaust	1980-1983			MS15303	1	
	1979		Cross Flow Cylinder Heads, Intake And Exhaust On Opposite Sides Of Engine	MS15303	1	
Manifold Set, Intake	1980-1983			MS15304	1	
	1979		Cross Flow Cylinder Heads, Intake And Exhaust On Opposite Sides Of Engine	MS15304	1	
Manifold Set, Int. & Exh.	1979	1	Except Cross Flow Cylinder Heads, Intake And Exhaust On Same Side Of Engine	MS15215	1	
	1977-1978			MS15215	1	
Oil Pan Set	1980-1983		Cork Rubber	OS30539X	1	
			Tuff-Cork	OS30539XTC	1	
	1979	1	Except Cross Flow Cylinder Heads, Intake And Exhaust On Same Side Of Engine	Cork Rubber	OS30539	1
		9, V	Cross Flow Cylinder Heads, Intake And Exhaust On Opposite Sides Of Engine	Cork Rubber	OS30539X	1
		9, V	Cross Flow Cylinder Heads, Intake And Exhaust On Opposite Sides Of Engine	Tuff-Cork	OS30539XTC	1
	1977-1978		Cork Rubber	OS30539	1	
Rear Main Seal Set	1980-1983		(1 Piece)	JV553	1	
	1979	9, V	Cross Flow Cylinder Heads, Intake And Exhaust On Opposite Sides Of Engine, (1 Piece)	JV553	1	
		1	Except Cross Flow Cylinder Heads, Intake And Exhaust On Same Side Of Engine, (2 Piece, Lip Relocator Type)	JV1627	1	
	1977-1978		(2 Piece, Lip Relocator Type)	JV1627	1	
Crank Repair Sleeve	1977-1983		Use With Part Number A510 Nickel Plated Formed Steel, .013" Thickness	A339	1	
Timing Cover Set	1977-1983		(Repair Sleeve Not Included)	JV883	1	
			(Contains Repair Sleeve)	JV1136	1	
Timing Cover Gasket	1977-1983			T27634	1	
Timing Cover Seal	1977-1983			48277SF	1	
Harmonic Balancer Repair Sleeve	1977-1983		Use With Part Number A504 Nickel Plated Formed Steel, .013" Thickness	A228	1	

General Motors Corp.

35 151 CID (2.5L) Carbureted Pontiac 4 Cyl, 4.000in./101.6mm (1977-1983) **35**
 (cont.) (cont.)

Part Year VIN Model/Application Part Number Qty.

MISCELLANEOUS GASKETS

Air Cleaner Mount Gasket	1980-1983		2 Barrel Carburetor	G26672	1
	1979		Cross Flow Cylinder Heads, Intake And Exhaust On Opposite Sides Of Engine, 2 Barrel Carburetor, Silencer To Carburetor	G26672	1
			Except Cross Flow Cylinder Heads, Intake And Exhaust On Same Side Of Engine, 2 Barrel Carburetor, Silencer To Carburetor	G26822	1
	1977-1978		Except California, 2 Barrel Carburetor, Silencer To Carburetor	G26813	1
			California, 2 Barrel Carburetor, Silencer To Carburetor	G26822	1
Carb. Mount Gasket	1980-1983		2 Barrel Carburetor, Adapter To Manifold	G14147	1
			2 Barrel Carburetor, Carburetor To Adapter	G26773	1
	1979		Cross Flow Cylinder Heads, Intake And Exhaust On Opposite Sides Of Engine, 2 Barrel Carburetor, Adapter To Manifold	G14147	1
			Except Cross Flow Cylinder Heads, Intake And Exhaust On Same Side Of Engine, 2 Barrel Carburetor	G25469	1
			Cross Flow Cylinder Heads, Intake And Exhaust On Opposite Sides Of Engine, 2 Barrel Carburetor, Carburetor To Adapter	G26773	1
			Except Cross Flow Cylinder Heads, Intake And Exhaust On Same Side Of Engine, (Insulator), 2 Barrel Carburetor	G26817	1
	1978		(Insulator), 2 Barrel Carburetor	G26817	1
	1977-1978		2 Barrel Carburetor	G25469	1
	1977		(Insulator), 2 Barrel Carburetor	G25462	1
Dist. Mounting Gasket	1982-1983			72216	1
	1980-1981			B25941	1
	1979		Cross Flow Cylinder Heads, Intake And Exhaust On Opposite Sides Of Engine	B25941	1
			Except Cross Flow Cylinder Heads, Intake And Exhaust On Same Side Of Engine	B26466	1
	1977-1978			B26466	1
E.G.R. Gasket	1977-1983			G17797	1
Exhaust Pipe Gasket	1983		(Ring Type 'F'), Pipe To Manifold	F7398	1
	1979-1982		(Ring Type 'F'), Front Pipe To Intermediate Pipe	F7209	1
			(Ring Type 'E'), Pipe To Manifold	F7270	1
	1980-1981		(Flange Type), Pipe To Manifold	F20401	1
Fuel Pump Gasket	1977-1983			D27094	1
			<i>Tuff-Cork</i>	D27094TC	1
Push Rod Cover Set	1977-1983		<i>Cork Rubber</i>	PS38792	1
Therm. Housing Gasket	1979		Except Cross Flow Cylinder Heads, Intake And Exhaust On Same Side Of Engine	C26544	1
	1977-1978			C26544	1
Water Outlet Gasket	1977-1983			C24109	1
Water Pump Mount Gasket	1980-1983		Adapter To Block	K26284	1
				K26545	1
	1979		Cross Flow Cylinder Heads, Intake And Exhaust On Opposite Sides Of Engine, Adapter To Block	K26284	1
			Except Cross Flow Cylinder Heads, Intake And Exhaust On Same Side Of Engine	K26545	1
	1977-1978			K26545	1

36 151 CID (2.5L) Fuel Injected Pontiac 4 Cyl, 4.000in./101.6mm (1982-1992) **36**

Part Year VIN Model/Application Part Number Qty.

ENGINE GASKETS

Head Set	1990-1992	R	(Contains Head Bolts, Exhaust Pipe Gasket Not Included)	HS5701WB3	1
		R	(Head Bolts Not Included, Exhaust Pipe Gasket Not Included)	HS5701Y	1

Part	Year	VIN	Model/Application	Part Number	Qty.
ENGINE GASKETS (cont.)					
Head Set (cont.)	1989-1991	U	(Contains Head Bolts, Exhaust Pipe Gasket Not Included)	HS5720WB3	1
		U	(Head Bolts Not Included, Exhaust Pipe Gasket Not Included)	HS5720Y	1
	1988-1989	R	(Contains Head Bolts, Exhaust Pipe Gasket Not Included)	HS5701WB2	1
		R	(Head Bolts Not Included, Exhaust Pipe Gasket Not Included)	HS5701X	1
	1988	U	(Contains Head Bolts, Exhaust Pipe Gasket Not Included)	HS5720WB2	1
		U	(Head Bolts Not Included, Exhaust Pipe Gasket Not Included)	HS5720X	1
	1987	R	(Head Bolts Not Included, Exhaust Pipe Gasket Not Included)	HS5701W	1
		R	(Contains Head Bolts, Exhaust Pipe Gasket Not Included)	HS5701WB1	1
		U	(Head Bolts Not Included, Exhaust Pipe Gasket Not Included)	HS5720W	1
		U	(Contains Head Bolts, Exhaust Pipe Gasket Not Included)	HS5720WB1	1
	1985-1986	2, R	(Contains Head Bolts, Exhaust Pipe Gasket Not Included)	HS5701WB	1
		U	(Head Bolts Not Included, Exhaust Pipe Gasket Not Included)	HS5720	1
		U	(Contains Head Bolts, Exhaust Pipe Gasket Not Included)	HS5720WB	1
	1984-1986	2, R	(Head Bolts Not Included, Exhaust Pipe Gasket Not Included)	HS5701	1
	1982-1983	2, R	(Head Bolts Not Included, Exhaust Pipe Gasket Not Included)	HS3684	1
	Full Set	1990-1992	R	(Head Bolts Not Included, Exhaust Pipe Gasket Not Included)	FS5701Y
1989-1991		U	(Head Bolts Not Included, Exhaust Pipe Gasket Not Included)	FS5720Y	1
1988-1989		R	(Head Bolts Not Included, Exhaust Pipe Gasket Not Included)	FS5701X	1
1988		U	(Head Bolts Not Included, Exhaust Pipe Gasket Not Included)	FS5720X	1
1987		R	(Head Bolts Not Included, Exhaust Pipe Gasket Not Included)	FS5701W	1
		U	(Head Bolts Not Included, Exhaust Pipe Gasket Not Included)	FS5720W	1
1985-1986		U	(Head Bolts Not Included, Exhaust Pipe Gasket Not Included)	FS5720	1
1984-1986		2, R	(Head Bolts Not Included, Exhaust Pipe Gasket Not Included)	FS5701	1
1982-1983		2, R	(Head Bolts Not Included, Exhaust Pipe Gasket Not Included)	FS3684	1
Engine Kit Gasket Set	1990-1992	R		95-3253VR	1
	1989-1991	U	Tech IV	95-3255VR	1
	1988-1989	R		95-3414VR	1
	1988	U	Tech IV	95-3256VR	1
	1987	U	Automatic Transmission, Tech IV	95-3257VR	1
		U	Manual Transmission, Tech IV, (Oil Pan Gasket Not Included), Use With Part Number OS32474	95-3257VR	1
		R		95-3413VR	1
	1985-1986	U	Tech IV	95-3258VR	1
		2, R	(Push Rod Cover Set Not Included), Use With Part Number PS39841	95-3399VR	1
	1982-1984			95-3399VR	1
Cylinder Head Gasket	1984-1992	R	VR2000	5701	1
	1985-1991	U	VR2000	5720	1
	1984-1986	2	VR2000	5701	1
	1982-1983	2, R	VR2000	3684	1
Cyl. Head Bolt Set	1985-1992	R		GS33190	1
	1985-1991	U		GS33266	1
Cyl. Head Spacer Shim	1984-1992	R	Requires Sealing Compound Steel	5701S	1

General Motors Corp.

36 151 CID (2.5L) Fuel Injected Pontiac 4 Cyl, 4.000in./101.6mm (1982-1992) **36**
 (cont.) (cont.)

Part Year VIN Model/Application Part Number Qty.

ENGINE GASKETS (cont.)

Cyl. Head Spacer Shim (cont.)	1985-1991	U	Requires Sealing Compound	<i>Steel</i>	5720S	1	
	1984-1986	2	Requires Sealing Compound	<i>Steel</i>	5701S	1	
Sealing Compound	1982-1992		(4 Ounce Brush Top Can)		JV66B	1	
			(12 Ounce Spray Can)		JV66S	1	
Valve Cover Set	1984-1992			<i>High Temperature Tuff-Cork</i>	VS39354HTC	1	
				<i>Victo-Tech</i>	VS39354R	1	
	1982-1992			<i>Cork Rubber</i>	VS39354	1	
	1982-1990			<i>Victo-Tech</i>	VS39354R	1	
	1982-1986			<i>High Temperature Tuff-Cork</i>	VS39354HTC	1	
Valve Stem Seal, Exh.	1987-1992				B45613	4	
	1982-1986		(O-Ring Type)		B45229	4	
Valve Stem Seal, Int.	1987-1992				B45613	4	
	1982-1986		(O-Ring Type)		B45229	4	
					<i>Fluoroelastomer</i>	B45418	4
Manifold Set, Exhaust	1987-1992				MS15433	1	
	1982-1986				MS15303	1	
Manifold Set, Intake	1990-1992	R			MS15668	1	
	1989-1991	U			MS15668	1	
	1987-1989	R			MS15438	1	
	1987-1988	U			MS15438	1	
	1982-1986				MS15304	1	
Oil Pan Set	1988-1992		Original Equipment Uses RTV	<i>Silicone</i>	JV6	1	
	1987	U	Automatic Transmission	<i>Cork Rubber</i>	OS32474	1	
	1982-1987	R			<i>Cork Rubber</i>	OS30539X	1
		R			<i>Tuff-Cork</i>	OS30539XTC	1
	1985-1986	U		<i>Cork Rubber</i>	OS32474	1	
	1982-1986	2			<i>Cork Rubber</i>	OS30539X	1
		2			<i>Tuff-Cork</i>	OS30539XTC	1
Rear Main Seal Set	1982-1992	R	(1 Piece)		JV553	1	
	1987-1991	U	(1 Piece)		JV553	1	
	1985-1986	U			JV552	1	
	1982-1986	2	(1 Piece)		JV553	1	
Crank Repair Sleeve	1982-1992		Use With Part Number A510, Rear <i>Nickel Plated Formed Steel, .013" Thickness</i>		A339	1	
Timing Cover Set	1990-1992		(Repair Sleeve Not Included)		JV1125	1	
	1985-1989	U	(Repair Sleeve Not Included)		JV1040	1	
		U	(Contains Repair Sleeve)		JV1135	1	
	1982-1989	R	(Repair Sleeve Not Included)		JV883	1	
		R	(Contains Repair Sleeve)		JV1136	1	
	1982-1986	2	(Repair Sleeve Not Included)		JV883	1	
		2	(Contains Repair Sleeve)		JV1136	1	
	Timing Cover Gasket	1982-1992				T27634	1
Timing Cover Seal	1982-1992				48277SF	1	
Harmonic Balancer Repair Sleeve	1982-1992		Use With Part Number A504 <i>Nickel Plated Formed Steel, .013" Thickness</i>		A228	1	

MISCELLANEOUS GASKETS

Air Cleaner Mount Gasket	1982-1992		Throttle Body Injection		G26803	1
Dist. Mounting Gasket	1987-1992				72213	1
	1982-1986				72216	1
E.G.R. Gasket	1982-1992		Throttle Body Injection		G26985	1
Exhaust Pipe Gasket	1983-1992		(Ring Type 'F'), Pipe To Manifold		F7398	1
	1990-1991		Catalytic Converter	<i>51mm Inside Diameter</i>	F10131	1
	1982		(Ring Type 'F'), Front Pipe To Intermediate Pipe		F7209	1
			(Ring Type 'E'), Pipe To Manifold		F7270	1
Fuel Pump Gasket	1982-1986				D27094	1

36 151 CID (2.5L) Fuel Injected Pontiac 4 Cyl, 4.000in./101.6mm (1982-1992) **36**
(cont.) (cont.)

Part	Year	VIN	Model/Application	Part Number	Qty.
MISCELLANEOUS GASKETS (cont.)					
Fuel Pump Gasket (cont.)	1982-1986		Tuff-Cork	D27094TC	1
Oil Pan Drain & Filter Seal	1987-1992			B45673	1
Push Rod Cover Set	1985-1992		Cork Rubber	PS39841	1
	1982-1984		Cork Rubber	PS38792	1
Therm. Housing Gasket	1988-1992	R		C31377	1
	1988-1991	U		C31377	1
Throttle Body Gasket	1987-1991			G30969	1
	1982-1986			G26794	1
Water Outlet Gasket	1982-1992	R		C24109	1
	1985-1986	U	Original Equipment Uses RTV Silicone	JV6	1
	1982-1986	2		C24109	1
Water Outlet Seal	1990-1992	R		Victo-Tech C31380	1
	1987-1991	U		Victo-Tech C31380	1
Water Pump Mount Gasket	1990-1992	R	Adapter To Block	K31179	1
	1987-1992		Original Equipment Uses RTV, To Adapter Silicone	JV6	1
	1990-1991	U	Adapter To Block	K31179	1
	1985-1989	U	Adapter To Block	K26284	1
		U		K27454	1
	1982-1989	R	Adapter To Block	K26284	1
	1984-1986	R	Transverse Engine	K27454	1
	1982-1986	2	Adapter To Block	K26284	1
1982-1984	2, R	Except Transverse Engine	K26545	1	

37 153 CID (2.5L) Chevrolet 4 Cyl, 3.875in./98.4mm (1962-1970) **37**

Part	Year	VIN	Model/Application	Part Number	Qty.
ENGINE GASKETS					
Head Set	1962-1970			HS1179VC	1
Full Set	1969-1970			FS1179VX	1
	1962-1967			FS1179VC	1
Cylinder Head Gasket	1962-1970		VR2000	1179VC	1
Valve Cover Set	1962-1970		Cork Rubber	VS38114	1
Valve Stem Seal, Exh.	1962-1970		(O-Ring Type)	B45229	4
Valve Stem Seal, Int.	1962-1970		(O-Ring Type)	B45229	4
Manifold Set, Int. & Exh.	1962-1970			MS15104	1
Oil Pan Set	1962-1970		Cork Rubber	OS30539	1
Rear Main Seal Set	1969-1970		(Lip Relocator Type)	JV1627	1
	1962-1967			JV728	1
Timing Cover Set	1969-1970		(Repair Sleeve Not Included)	JV862	1
	1962-1970		(Contains Repair Sleeve)	JV925	1
	1962-1963		(Repair Sleeve Not Included)	JV862	1
Timing Cover Gasket	1962-1970			T14744	1
Timing Cover Seal	1969-1970		(Lip Relocator Type) 1/2" Wide	65022	1
	1962-1970		3/8" Wide	49328	1
	1962-1963		(Lip Relocator Type) 1/2" Wide	65022	1
Harmonic Balancer Repair Sleeve	1969-1970		Ground Steel, .020" Thickness	66597RS	1
	1962-1970		Use With Part Number A504 Nickel Plated Formed Steel, .013" Thickness	A228	1
	1962-1963		Ground Steel, .020" Thickness	66597RS	1

MISCELLANEOUS GASKETS

Air Cleaner Mount Gasket	1962-1970		1 Barrel Carburetor	G25936	1
--------------------------	-----------	--	---------------------	--------	---

General Motors Corp.

37 153 CID (2.5L) Chevrolet 4 Cyl, 3.875in./98.4mm (1962-1970) **37**
 (cont.) (cont.)

Part	Year	VIN	Model/Application	Part Number	Qty.
MISCELLANEOUS GASKETS (cont.)					
Carb. Mount Gasket	1962-1970		1 Barrel Carburetor	G5349AD	1
Dist. Mounting Gasket	1962-1970			B26466	1
Exhaust Pipe Gasket	1969-1970		(Ring Type 'C'), Pipe To Manifold	F17250	1
	1962-1970		(Ring Type 'B'), Pipe To Manifold <i>Sintered Metal</i>	F17250S	1
	1962-1963		(Ring Type 'C'), Pipe To Manifold	F17250	1
Fuel Pump Gasket	1969-1970		Plate To Block	D25932	1
			Pump To Plate	D27094	1
			Pump To Plate <i>Tuff-Cork</i>	D27094TC	1
	1962-1970		Plate To Block <i>Tuff-Cork</i>	D25932TC	1
	1962-1963		Plate To Block	D25932	1
			Pump To Plate	D27094	1
			Pump To Plate <i>Tuff-Cork</i>	D27094TC	1
Oil Pan Drain Plug Gskt.	1962-1970		2051	1	
Push Rod Cover Set	1962-1970		PS38112	1	
Therm. Housing Gasket	1962-1970		C26544	1	
Water Outlet Gasket	1969-1970		(Universal Type)	C24109	1
				C25930	1
	1962-1963		(Universal Type)	C24109	1
				C25930	1
Water Pump Mount Gasket	1962-1970		K26545	1	

38 164 CID (2.7L) Chevrolet Corvair 6 Cyl, 3.438in./87.3mm (1965-1969) **38**

Part	Year	VIN	Model/Application	Part Number	Qty.
ENGINE GASKETS					
Head Set	1965-1969		(Manifold Gaskets For 4-1 Barrel Carburetors Not Included)	HS3367X	2
Full Set	1965-1969		(Manifold Gaskets For 4-1 Barrel Carburetors Not Included)	FS3367X	1
Cylinder Head Gasket	1965-1969			CH3367	2
Valve Cover Set	1965-1969		<i>Victo-Tech</i>	VS28294	1
Manifold Set, Exhaust	1965-1969		Except 4-1 Barrel Carburetors	MS7158	1
	1965-1966		4-1 Barrel Carburetors	MS7188	1
Oil Pan Set	1965-1969		<i>Cork Rubber</i>	OS30664	1
Rear Main Seal Set	1965-1969			JV646	1
Timing Cover Set	1965-1969			JV858	1
Timing Cover Seal	1965-1969			46248	1

MISCELLANEOUS GASKETS					
Air Cleaner Mount Gasket	1965-1969		2-1 Barrel Carburetors	G25936	2
Carb. Mount Gasket	1965-1969		2-1 Barrel Carburetors	G7177	2
Clutch Throwout Brg. Seal	1965-1967		Inner	47448	1
Crankcase Cover Gasket	1965-1967		Top Cover	OS20604	1
Cylinder Sleeve Gasket	1965-1967		To Block	19312	6
Dist. Mounting Gasket	1965-1969			B26466	1
Engine Rear Hsg. Seal	1965-1969		Damper End	46248	1
Exhaust Pipe Gasket	1965-1969		(Ring Type 'C'), Pipe To Manifold	F7140	2
			Except 4-1 Barrel Carburetors, (Ring Type 'C'), Pipe To Manifold	F7140	2
	1965-1966		(Ring Type 'C'), Pipe To Manifold	F17251	1
Flywheel Housing Gasket	1965-1969			T27792	1
Flywheel Housing Oil Seal	1965-1969			46227	1

PASSENGER CAR

38 164 CID (2.7L) Chevrolet Corvair 6 Cyl, 3.438in./87.3mm (1965-1969) **38**
(cont.) (cont.)

Part	Year	VIN	Model/Application	Part Number	Qty.
MISCELLANEOUS GASKETS (cont.)					
Fuel Pump Gasket	1965-1969			72210	1
Push Rod Seal	1965-1969		Push Rod To Crankcase Tube	B45314	24
Rocker Arm Stud Seal	1965-1969			B45315	12
Turbo Gasket	1965-1966		Outlet Pipe	F7139	2
			Inlet To Exhaust Pipe	F17355	1
			Induction Pipe To Head	G5349AD	2

39 173 CID (2.8L) Chevrolet V6 Cyl, 3.504in./89mm (1980-1989) **39**

Part	Year	VIN	Model/Application	Part Number	Qty.	
ENGINE GASKETS						
Head Set	1987-1989	S	Camaro, Firebird, (Contains Head Bolts, Exhaust Pipe Gasket Not Included)	HS3549WB1	1	
		W	(Contains Head Bolts, Exhaust Pipe Gasket Not Included, Intake Manifold Gasket Not Included)	HS3793WB	1	
		W	(Head Bolts Not Included, Exhaust Pipe Gasket Not Included, Intake Manifold Gasket Not Included)	HS3793X	1	
	1985-1989	S	Camaro, Firebird, (Head Bolts Not Included, Exhaust Pipe Gasket Not Included)	HS3549X	1	
	1985-1988	9		Fiero, (Contains Head Bolts, Exhaust Pipe Gasket Not Included)	HS3549WB3	1
				Fiero, (Head Bolts Not Included, Exhaust Pipe Gasket Not Included)	HS3549Y	1
	1986	W	Cutlass Ciera, (Head Bolts Not Included, Exhaust Pipe Gasket Not Included)	HS3549X	1	
	1985-1986	W		(Contains Head Bolts, Exhaust Pipe Gasket Not Included)	HS3549WB2	1
				6000, Cavalier, Celebrity, Cimarron, Firenza, (Head Bolts Not Included, Exhaust Pipe Gasket Not Included)	HS3549X	1
	1981-1986	X		(Head Bolts Not Included, Exhaust Pipe Gasket Not Included)	HS3549	1
				(Contains Head Bolts, Exhaust Pipe Gasket Not Included)	HS3549WB	1
	1985	W	Citation 2, Skylark, (Head Bolts Not Included, Exhaust Pipe Gasket Not Included)	HS3549X	1	
	1982-1984	1, Z		(Head Bolts Not Included, Exhaust Pipe Gasket Not Included)	HS3549	1
				(Contains Head Bolts, Exhaust Pipe Gasket Not Included)	HS3549WB	1
	1980	7		(Head Bolts Not Included, Exhaust Pipe Gasket Not Included)	HS3549	1
			(Contains Head Bolts, Exhaust Pipe Gasket Not Included)	HS3549WB	1	
Lower Set	1980-1984		(Requires Head Set To Make Full Set)	CS3549B	1	
Full Set	1987-1989	S	Camaro, Firebird, (Head Bolts Not Included, Exhaust Pipe Gasket Not Included)	FS3549Z	1	
		W	(Head Bolts Not Included, Exhaust Pipe Gasket Not Included, Intake Manifold Gasket Not Included)	FS3793X	1	
	1987-1988	9	Fiero, (Head Bolts Not Included, Exhaust Pipe Gasket Not Included)	FS3549R	1	
	1985-1986	X		(Head Bolts Not Included, Exhaust Pipe Gasket Not Included)	FS3549W	1
			S, W	(Head Bolts Not Included, 5mm Rear Main Seal Not Included, Exhaust Pipe Gasket Not Included)	FS3549X	1
		9	Fiero, (Head Bolts Not Included, Exhaust Pipe Gasket Not Included)	FS3549Y	1	
	1982-1984	1, Z	(Head Bolts Not Included, Exhaust Pipe Gasket Not Included)	FS3549	1	
	1981-1984	X	(Head Bolts Not Included, Exhaust Pipe Gasket Not Included)	FS3549	1	
	1982-1983	Z	(Head Bolts Not Included, Exhaust Pipe Gasket Not Included)	FS3549	1	
	1980	7	(Head Bolts Not Included, Exhaust Pipe Gasket Not Included)	FS3549	1	

General Motors Corp.

39 173 CID (2.8L) Chevrolet V6 Cyl, 3.504in./89mm (1980-1989)

(cont.)

39

(cont.)

Part	Year	VIN	Model/Application	Part Number	Qty.
ENGINE GASKETS (cont.)					
Engine Kit Gasket Set	1988-1989	W	Cutlass Supreme, Grand Prix, Regal, Aluminum Cylinder Heads, (Intake Manifold Gasket Not Included, Exhaust Manifold Gasket Not Included), Use With Part Numbers MS15704, MS15442	95-3410VR	1
	1987-1989	W	Beretta, Cavalier, Celebrity, Corsica, Tempest, Aluminum Cylinder Heads, (Intake Manifold Gasket Not Included, Exhaust Manifold Gasket Not Included), Use With Part Numbers MS15704, MS15443	95-3410VR	1
		W	6000, Century, Cutlass, Cutlass Ciera, Aluminum Cylinder Heads, (Intake Manifold Gasket Not Included, Exhaust Manifold Gasket Not Included), Use With Part Numbers MS15704, MS15442	95-3410VR	1
		S	Camaro, Firebird, Cast Iron Cylinder Heads	95-3416VR	1
	1987-1988	W	Cimarron, Aluminum Cylinder Heads, (Intake Manifold Gasket Not Included, Exhaust Manifold Gasket Not Included), Use With Part Numbers MS15704, MS15443	95-3410VR	1
		9	Fiero, (Valve Cover Set Not Included, Exhaust Manifold Gasket Not Included), Use With Part Numbers MS15441, VS50016	95-3416VR	1
	1987	W	Firenza, Aluminum Cylinder Heads, (Intake Manifold Gasket Not Included, Exhaust Manifold Gasket Not Included), Use With Part Numbers MS15704, MS15442	95-3410VR	1
	1986	X	(Optional Oil Pan Set For Goodwrench Replacement Engine Not Included), Use With Part Number OS32495	95-3406VR	1
	1985-1986	S, W	(Optional Oil Pan Set For Goodwrench Replacement Engine Not Included), Use With Part Number OS32495	95-3406VR	1
		9	Fiero, (Valve Cover Set Not Included, Exhaust Manifold Gasket Not Included), Use With Part Numbers MS15441, VS50016	95-3406VR	1
	1985	X	11mm Wide Rear Main Seal, 2nd Design, (Valve Cover Set Not Included, Optional Oil Pan Set For Goodwrench Replacement Engine Not Included), Use With Part Numbers VS39772, OS32495	95-3406VR	1
		X	1st Design, 5.5mm Wide Rear Main Seal, (Valve Cover Set Not Included, 5.5mm Rear Main Seal Not Included, Optional Oil Pan Set For Goodwrench Replacement Engine Not Included), Use With Part Numbers JV531, VS39772, OS32495	95-3406VR	1
	1980-1984		(Optional 1 Piece Rear Main Seal Not Included, Optional Oil Pan Set For Goodwrench Replacement Engine Not Included), Use With Part Numbers JV531, OS32495	95-3435VR	1
	Cylinder Head Gasket	1987-1989	W	Aluminum Cylinder Heads	<i>Nitroseal</i> 3793
1985-1989		S	Camaro, Firebird, Cast Iron Cylinder Heads	<i>VR2000</i> 3549	2
1985-1988		9	Fiero	<i>VR2000</i> 3549	2
1986		W, X	Cutlass Ciera	<i>VR2000</i> 3549	2
1985-1986		W	6000, Cavalier, Celebrity, Cimarron, Firenza	<i>VR2000</i> 3549	2
1982-1986		X	6000, Celebrity, Century	<i>VR2000</i> 3549	2
1981-1986		X	Skylark	<i>VR2000</i> 3549	2
1985		W	Citation 2, Skylark	<i>VR2000</i> 3549	2
1984-1985		X	Citation 2	<i>VR2000</i> 3549	2
1984		Z	Citation 2	<i>VR2000</i> 3549	2
1983-1984		Z	6000	<i>VR2000</i> 3549	2
1982-1984		Z	Celebrity, Omega, Phoenix, Skylark	<i>VR2000</i> 3549	2
		1	Camaro, Firebird, Cast Iron Cylinder Heads	<i>VR2000</i> 3549	2
1981-1984		X	Omega, Phoenix	<i>VR2000</i> 3549	2
1982-1983		Z	Citation, Skylark	<i>VR2000</i> 3549	2
1981-1983		X	Citation, Skylark	<i>VR2000</i> 3549	2
1982		Z	Citation	<i>VR2000</i> 3549	2
1981-1982		X	Citation	<i>VR2000</i> 3549	2
1980		7	Citation, Omega, Phoenix, Skylark	<i>VR2000</i> 3549	2
Cyl. Head Bolt Set	1985-1989	S	Camaro, Firebird	GS33223	2
		W	Rear Head	GS33224	1

PASSENGER CAR

Part	Year	VIN	Model/Application	Part Number	Qty.
ENGINE GASKETS (cont.)					
Cyl. Head Bolt Set (cont.)	1985-1989	W	Front Head	GS33225	1
	1985-1988	9	Fiero, Rear Head	GS33223	2
		9	Fiero, Front Head	GS33229	1
	1986	X	Cutlass Ciera	GS33223	2
	1982-1986	X	6000, Celebrity, Century	GS33223	2
	1981-1986	X	Skylark	GS33223	2
	1984-1985	X	Citation 2	GS33223	2
	1984	Z	Citation 2	GS33223	2
	1983-1984	Z	6000	GS33223	2
	1982-1984	Z	Celebrity, Omega, Phoenix, Skylark	GS33223	2
		1	Camaro, Firebird	GS33223	2
	1981-1984	X	Omega, Phoenix	GS33223	2
	1982-1983	Z	Citation, Skylark	GS33223	2
	1981-1983	X	Citation, Phoenix, Skylark	GS33223	2
	1982	Z	Citation	GS33223	2
	1981-1982	X	Citation	GS33223	2
1980	7	Citation, Omega, Phoenix, Skylark	GS33223	2	
Cyl. Head Spacer Shim	1987-1989	W	Aluminum Cylinder Heads, Requires Sealing Compound <i>Steel</i>	3793S	2
Sealing Compound	1987-1989		(4 Ounce Brush Top Can)	JV66B	1
			(12 Ounce Spray Can)	JV66S	1
Valve Cover Set	1987-1989	W	(Valve Cover Grommets Not Included) <i>Victo-Tech</i>	VS50053	1
		W	(Single Valve Cover, Valve Cover Grommets Not Included) <i>Victo-Tech</i>	VS50120	2
	1985-1989	S	Camaro, Firebird <i>Cork Rubber</i>	VS50019	1
	1985-1988	9	Fiero <i>Victo-Tech</i>	VS50016	1
		9	Fiero, (Single Valve Cover) <i>Victo-Tech</i>	VS50121	2
	1986	W	Cutlass Ciera <i>Cork Rubber</i>	VS50019	1
	1985-1986	W	6000, Cavalier, Celebrity, Cimarron, Firenza <i>Cork Rubber</i>	VS50019	1
	1981-1986	X	<i>Cork Rubber</i>	VS39772	1
		X	<i>Victo-Tech</i>	VS39772R	1
	1985	W	Citation 2, Skylark <i>Cork Rubber</i>	VS50019	1
	1982-1984	1, Z	<i>Cork Rubber</i>	VS39772	1
		1, Z	<i>Victo-Tech</i>	VS39772R	1
	1980	7	<i>Cork Rubber</i>	VS39772	1
		7	<i>Victo-Tech</i>	VS39772R	1
Valve Stem Seal, Exh.	1987-1989	S	(O-Ring Type)	B45229	6
		W		B45612	6
	1987-1988	9	(O-Ring Type)	B45229	6
	1980-1986		(O-Ring Type)	B45229	6
Valve Stem Seal, Int.	1987-1989	S	(O-Ring Type)	B45229	6
		S	<i>Fluoroelastomer</i>	B45418	6
		W		B45611	6
	1987-1988	9	(O-Ring Type)	B45229	6
		9	<i>Fluoroelastomer</i>	B45418	6
	1981-1986		<i>Fluoroelastomer</i>	B45418	6
	1980-1986		(O-Ring Type)	B45229	6
	Manifold Set, Exhaust	1988-1989	W	Cutlass Supreme, Grand Prix, Regal	MS15442
1987-1989		W	6000, Century, Cutlass, Cutlass Ciera	MS15442	1
		W	Beretta, Cavalier, Celebrity, Corsica, Tempest	MS15443	1
1985-1989		S	Camaro, Firebird	MS15310	1
1985-1988		9	Fiero	MS15441	1
1987		W	Firenza	MS15442	1
		W	Cimarron	MS15443	1
1986		W, X	Cutlass Ciera	MS15310	1
1985-1986		W	6000, Cavalier, Celebrity, Cimarron, Firenza	MS15310	1

General Motors Corp.

39 173 CID (2.8L) Chevrolet V6 Cyl, 3.504in./89mm (1980-1989)

(cont.)

39

(cont.)

Part	Year	VIN	Model/Application	Part Number	Qty.
ENGINE GASKETS (cont.)					
Manifold Set, Exhaust (cont.)	1982-1986	X	6000, Celebrity, Century	MS15310	1
	1981-1986	X	Skylark	MS15310	1
	1985	W	Citation 2, Skylark	MS15310	1
	1984-1985	X	Citation 2	MS15310	1
	1984	L	Riviera	MS15310	1
		Z	Citation 2	MS15310	1
	1983-1984	L	Firebird	MS15310	1
		Z	6000	MS15310	1
	1982-1984	Z	Celebrity, Omega, Phoenix, Skylark	MS15310	1
		1	Camaro, Firebird	MS15310	1
	1981-1984	X	Omega, Phoenix	MS15310	1
	1983	L	Camaro	MS15310	1
	1982-1983	Z	Citation, Skylark	MS15310	1
	1981-1983	X	Citation, Skylark	MS15310	1
	1982	Z	Citation	MS15310	1
	1981-1982	X	Citation	MS15310	1
1980	7	Citation, Omega, Phoenix, Skylark	MS15310	1	
Manifold Set, Intake	1988-1989	W	Cutlass Supreme, Grand Prix, Regal, (Requires Valve Cover Set, Contains Plenum Chamber Gasket)	MS15704	1
	1987-1989	W	6000, Beretta, Cavalier, Celebrity, Century, Corsica, Cutlass, Cutlass Ciera, Tempest, (Requires Valve Cover Set, Contains Plenum Chamber Gasket)	MS15704	1
	1985-1989	S	Camaro, Firebird, (Requires Valve Cover Set, Contains Plenum Chamber Gasket)	MS15222	1
	1985-1988	9	Fiero, (Requires Valve Cover Set, Contains Plenum Chamber Gasket)	MS15222	1
	1987	W	Cimarron, Firenza, (Requires Valve Cover Set, Contains Plenum Chamber Gasket)	MS15704	1
	1986	W	Cutlass Ciera, (Requires Valve Cover Set, Contains Plenum Chamber Gasket)	MS15222	1
	1985-1986	W	6000, Cavalier, Celebrity, Cimarron, Firenza, (Requires Valve Cover Set, Contains Plenum Chamber Gasket)	MS15222	1
	1981-1986	X	(Requires Valve Cover Set)	MS15307	1
	1985	W	Citation 2, Skylark, (Requires Valve Cover Set, Contains Plenum Chamber Gasket)	MS15222	1
	1983-1984	L		MS15307	1
	1982-1984	1, Z		MS15307	1
	1980	7		MS15221	1
	Plenum Chamber Gasket	1988-1989	W	Cutlass Supreme, Grand Prix, Regal	MS14752A
1987-1989		W	6000, Beretta, Cavalier, Celebrity, Century, Corsica, Cutlass, Cutlass Ciera, Tempest	MS14752A	1
1985-1989		S	Camaro, Firebird	MS14752	1
1985-1988		9	Fiero	MS14752	1
1987		W	Cimarron, Firenza	MS14752A	1
1986		W	Cutlass Ciera, Throttle Body Faces Rear Of Engine	MS14752	1
1985-1986		W	6000, Cavalier, Celebrity, Firenza, Throttle Body Faces Rear Of Engine	MS14752	1
		W	Cimarron, Throttle Body Faces Front Of Engine	MS14752B	1
1985		W	Citation 2, Skylark, Throttle Body Faces Rear Of Engine	MS14752	1
Oil Pan Set	1987-1989		<i>Tuff-Cork</i>	OS32476TC	1
			<i>Victo-Tech</i>	OS32495	1
	1985-1986		<i>Cork Rubber</i>	OS32025	1
	1980-1984		<i>Cork Rubber</i>	OS32104	1
Rear Main Seal Set	1987-1989		<i>11mm Wide</i>	JV554	1
	1985-1989		<i>11mm Wide</i>	JV544	1
			<i>Teflon, 11mm Wide</i>	JV1633	1
	1985-1988		<i>11mm Wide Rear Main Seal</i>	JV544	1

PASSENGER CAR

Part Year VIN Model/Application Part Number Qty.

ENGINE GASKETS (cont.)

Rear Main Seal Set (cont.)	1986			<i>5.5mm Wide</i>	JV531	1
	1985-1986		5.5mm Wide Rear Main Seal	<i>5.5mm Wide</i>	JV531	1
	1980-1986			<i>5.5mm Wide</i>	JV531	1
	1980-1984		(2 Piece)		JV526	1
Crank Repair Sleeve	1985-1989		Use With Part Number A510 <i>Nickel Plated Formed Steel, .013" Thickness</i>		A337	1
Timing Cover Set	1987-1989	W			JV1065	1
		S	(Repair Sleeve Not Included)		JV1066	1
		S	(Contains Repair Sleeve)		JV1131	1
	1985-1988	9	Fiero		JV948	1
	1986	W, X	Cutlass Ciera		JV948	1
	1985-1986	W	Firenza		JV948	1
		S	Camaro, Firebird		JV948	1
		W	6000, Cavalier, Celebrity, Cimarron		JV948	1
	1982-1986	X	6000, Celebrity, Century		JV948	1
	1981-1986	X	Skylark		JV948	1
	1985	W	Citation 2, Skylark		JV948	1
	1984-1985	X	Citation 2		JV948	1
	1984	L	Riviera		JV948	1
		Z	Citation 2		JV948	1
	1983-1984	L	Firebird		JV948	1
		Z	6000		JV948	1
	1982-1984	Z	Celebrity, Omega, Phoenix, Skylark		JV948	1
		1	Camaro, Firebird		JV948	1
	1981-1984	X	Omega, Phoenix		JV948	1
	1983	L	Camaro		JV948	1
	1982-1983	Z	Citation, Skylark		JV948	1
	1981-1983	X	Citation, Skylark		JV948	1
	1982	Z	Citation		JV948	1
1981-1982	X	Citation		JV948	1	
1980	7	Citation, Omega, Phoenix, Skylark		JV948	1	
Timing Cover Gasket	1980-1989				T27635	1
Timing Cover Seal	1980-1989			<i>3/8" Wide</i>	49328	1
			(Lip Relocator Type)	<i>1/2" Wide</i>	65022	1
Harmonic Balancer Repair Sleeve	1987-1989		Front Wheel Drive, Use With Part Number A504 <i>Nickel Plated Formed Steel, .013" Thickness</i>		A228-2	1
	1982-1989		Rear Wheel Drive, Use With Part Number A504 <i>Nickel Plated Formed Steel, .013" Thickness</i>		A228-1	1

MISCELLANEOUS GASKETS

Air Cleaner Mount Gasket	1980-1986		2 Barrel Carburetor		G26672	1
Cam. Cover Gasket	1980-1989				H36978	1
Carb. Mount Gasket	1980-1986		Except Heater Type, 2 Barrel Carburetor		G26773	1
Dist. Mounting Gasket	1982-1989				72214	1
	1980-1981				B25934	1
E.G.R. Gasket	1988-1989	W	Cutlass Supreme, Grand Prix, Regal		G31541	1
	1987-1989	W	6000, Beretta, Cavalier, Celebrity, Century, Corsica, Cutlass, Cutlass Ciera, Tempest		G31541	1
		S	Camaro, Firebird		G17797	1
	1987-1988	9	Fiero		G31541	1
	1987	W	Cimarron, Firenza		G31541	1
	1986	W, X	Cutlass Ciera		G17797	1
	1985-1986	W	6000, Cavalier, Celebrity, Cimarron, Firenza		G17797	1
		9	Fiero		G17797	1
	1982-1986	X	6000, Celebrity, Century		G17797	1
1981-1986	X	Skylark		G17797	1	

General Motors Corp.

39 173 CID (2.8L) Chevrolet V6 Cyl, 3.504in./89mm (1980-1989) **39**
 (cont.) (cont.)

Part	Year	VIN	Model/Application	Part Number	Qty.
MISCELLANEOUS GASKETS (cont.)					
E.G.R. Gasket (cont.)	1985	W	Citation 2, Skylark	G17797	1
	1984-1985	X	Citation 2	G17797	1
	1984	L	Riviera	G17797	1
		Z	Citation 2	G17797	1
	1983-1984	Z	6000	G17797	1
		L	Firebird	G17797	1
	1982-1984	Z	Celebrity, Omega, Phoenix, Skylark	G17797	1
		1	Camaro, Firebird	G17797	1
	1981-1984	X	Omega, Phoenix	G17797	1
	1983	L	Camaro	G17797	1
	1982-1983	Z	Citation, Skylark	G17797	1
	1981-1983	X	Citation, Skylark	G17797	1
	1982	Z	Citation	G17797	1
	1981-1982	X	Citation	G17797	1
1980	7	Citation, Omega, Phoenix, Skylark	G17797	1	
Exhaust Manifold Extension Gasket	1987-1989	W	Cavalier	F7563	1
Exhaust Pipe Gasket	1987-1989	W	(Ring Type 'F'), Pipe To Manifold	F7448	1
	1985-1989	S	(Ring Type 'F'), Pipe To Manifold	F7210	1
	1985-1988	9	(Ring Type 'F'), Pipe To Manifold	F7210	1
	1985-1986	W	(Ring Type 'F'), Pipe To Manifold	F7210	1
	1981-1986	X	(Ring Type 'F'), Pipe To Manifold	F7210	1
	1983-1984	L	(Ring Type 'F'), Pipe To Manifold	F7210	1
	1982-1984	1, Z	(Ring Type 'F'), Pipe To Manifold	F7210	1
	1980	7	(Ring Type 'F'), Pipe To Manifold	F7210	1
Fuel Pump Gasket	1980-1986		2 Barrel Carburetor	D27228	1
Injector Nozzle O-Ring	1985-1989			GS33276	3
Oil Filter Adapt Gasket	1985-1989	W		B31606	1
	1985-1986	X		B31606	1
	1980-1984			B31606	1
Throttle Body Gasket	1987-1989	W		G31281	1
	1985-1989	S		G30949	1
	1985-1988	9		G30949	1
	1985-1986	W		G31399	1
Valve Cover Grommet	1987-1989	W		GS33305	1
Water By-Pass Gasket	1985-1989			C31326	1
Water Outlet Gasket	1988-1989	W	Cutlass Supreme, Grand Prix, Regal	C24118	1
	1987-1989	W	Beretta, Century, Corsica, Cutlass, Tempest	C24118	1
		S	Camaro, Firebird	C30820	1
	1986-1989	W	Cutlass Ciera	C24118	1
	1985-1989	W	6000, Cavalier, Celebrity	C24118	1
	1985-1988	9	Fiero	C30820	1
	1985-1987	W	Cimarron, Firenze	C24118	1
	1986	X	Cutlass Ciera	3.310" Bolt Center To Bolt Center C25930	1
	1985-1986	S	Camaro, Firebird	2.830" Bolt Center To Bolt Center C24118	1
	1982-1986	X	6000, Celebrity, Century	3.310" Bolt Center To Bolt Center C25930	1
	1981-1986	X	Skylark	3.310" Bolt Center To Bolt Center C25930	1
	1985	W	Citation 2, Skylark	C24118	1
	1984-1985	X	Citation 2	3.310" Bolt Center To Bolt Center C25930	1
	1984	L	Riviera	3.310" Bolt Center To Bolt Center C25930	1
		Z	Citation 2	3.310" Bolt Center To Bolt Center C25930	1
	1983-1984	L	Firebird	2.830" Bolt Center To Bolt Center C24118	1
		Z	6000	3.310" Bolt Center To Bolt Center C25930	1
	1982-1984	1	Camaro, Firebird	2.830" Bolt Center To Bolt Center C24118	1
		Z	Celebrity, Omega, Phoenix, Skylark	3.310" Bolt Center To Bolt Center C25930	1
	1981-1984	X	Omega, Phoenix	3.310" Bolt Center To Bolt Center C25930	1

PASSENGER CAR

39 173 CID (2.8L) Chevrolet V6 Cyl, 3.504in./89mm (1980-1989) **39**
 (cont.) (cont.)

Part	Year	VIN	Model/Application	Part Number	Qty.
MISCELLANEOUS GASKETS (cont.)					
Water Outlet Gasket (cont.)	1983	L	Camaro <i>2.830" Bolt Center To Bolt Center</i>	C24118	1
	1982-1983	Z	Citation, Phoenix, Skylark <i>3.310" Bolt Center To Bolt Center</i>	C25930	1
	1981-1983	X	Citation, Phoenix, Skylark <i>3.310" Bolt Center To Bolt Center</i>	C25930	1
	1982	Z	Citation <i>3.310" Bolt Center To Bolt Center</i>	C25930	1
	1981-1982	X	Citation <i>3.310" Bolt Center To Bolt Center</i>	C25930	1
	1980	7	Citation, Omega, Phoenix, Skylark <i>3.310" Bolt Center To Bolt Center</i>	C25930	1
Water Pump Mount Gasket	1987-1989	W		K30946	1
		S		K30947	1
	1986	W	Cutlass Ciera	K24689	1
	1985-1986	W	Firenza	K24689	1
		S	Camaro, Firebird	K24689	1
		W	6000, Celebrity, Cimarron	K24689	1
		9	Fiero	K24689	1
		W	Cavalier	K31540	1
	1981-1986	X		K24689	1
	1985	W	Citation 2, Skylark	K24689	1
	1983-1984	L		K24689	1
	1982-1984	1, Z		K24689	1
	1980	7		K24689	1

40 181 CID (3.0L) Buick V6 Cyl, 3.800in./96.5mm (1982-1988) **40**

Part	Year	VIN	Model/Application	Part Number	Qty.
ENGINE GASKETS					
Head Set	1986-1988	L	(Contains Head Bolts, Exhaust Pipe Gasket Not Included, Intake Manifold Gasket Not Included)	HS3777WB1	1
	1985-1988	L	(Head Bolts Not Included, Exhaust Pipe Gasket Not Included, Intake Manifold Gasket Not Included)	HS3777W	1
	1985	L	(Contains Head Bolts, Exhaust Pipe Gasket Not Included, Intake Manifold Gasket Not Included)	HS3777WB3	1
	1982-1985	E	(Exhaust Pipe Gasket Not Included, Intake Manifold Gasket Not Included, Intake Valve Stem Seals Used With .552" Valve Guides Not Included)	HS3741	1
Full Set	1985-1988	L	(Head Bolts Not Included, Exhaust Pipe Gasket Not Included, Intake Manifold Gasket Not Included)	FS3777W	1
	1985	E	(Exhaust Pipe Gasket Not Included, Intake Manifold Gasket Not Included)	FS3741B	1
	1982-1984	E	(Exhaust Pipe Gasket Not Included, Intake Manifold Gasket Not Included, Intake Valve Stem Seals Used With .552" Valve Guides Not Included)	FS3741	1
Engine Kit Gasket Set	1985-1988	L	(Intake Manifold Gasket Not Included, Optional 2 Piece Rubber Rear Main Seal Not Included), Use With Part Numbers MS15971, JV742R	95-3411VR	1
	1985	E	14 Bolt Oil Pan, (Intake Manifold Gasket Not Included, Optional 2 Piece Rubber Rear Main Seal Not Included), Use With Part Numbers MS15960, JV742R	95-3420VR	1
		E	20 Bolt Oil Pan, (Oil Pan Gasket Not Included, Intake Manifold Gasket Not Included, Optional 2 Piece Rubber Rear Main Seal Not Included), Use With Part Numbers MS15960, JV742R, OS32022	95-3420VR	1
	1983-1984	E	(Intake Manifold Gasket Not Included, Optional 2 Piece Rubber Rear Main Seal Not Included), Use With Part Numbers MS15960, JV742R	95-3420VR	1
	1982-1983	E	Thru 11/30/82, (Intake Manifold Gasket Not Included, Optional 2 Piece Rubber Rear Main Seal Not Included), Use With Part Numbers MS15960, JV742R	95-3402VR	1

General Motors Corp.

40 181 CID (3.0L) Buick V6 Cyl, 3.800in./96.5mm (1982-1988) **40**
 (cont.) (cont.)

Part Year VIN Model/Application Part Number Qty.

ENGINE GASKETS (cont.)

Engine Kit Gasket Set (cont.)	1982	E	(Intake Manifold Gasket Not Included, Optional 2 Piece Rubber Rear Main Seal Not Included), Use With Part Numbers MS15960, JV742R	95-3402VR	1
Cylinder Head Gasket	1985-1988	L	<i>Nitroseal</i>	3777	2
	1982-1985	E	<i>VR2000</i>	5820	2
Cyl. Head Bolt Set	1985-1988	L		GS33255	2
Valve Cover Set	1985-1988	L	<i>Victo-Tech</i>	VS50017	1
		L	(Single Valve Cover) <i>Victo-Tech</i>	VS50122	2
	1982-1985	E	<i>Cork Rubber</i>	VS39763	1
		E	<i>Victo-Tech</i>	VS39763R	1
Valve Stem Seal, Exh.	1985-1988	L		B45591	6
Valve Stem Seal, Int.	1984-1988			B45484	6
	1983		.552" Guide Outside Diameter	B45484	6
			.605" Guide Outside Diameter	B45497	6
	1982			B45497	6
Manifold Set, Exhaust	1985-1988	L		MS15519	1
	1982-1985	E		MS15327	1
Manifold Set, Intake	1985-1988	L		MS15971	1
	1982-1985	E		MS15960	1
Oil Pan Set	1985-1988	L	<i>Victo-Tech</i>	OS32022	1
	1985	E	20 Bolt Pan <i>Victo-Tech</i>	OS32022	1
	1982-1985	E	14 Bolt Pan <i>Cork Rubber</i>	OS30589	1
Rear Main Seal Set	1982-1988		<i>Rope Packing</i>	JV742	1
			<i>Molded Rubber</i>	JV742R	1
Timing Cover Set	1985-1988	L		JV1046	1
	1982-1985	E	<i>Rope Packing</i>	JV988	1
		E	(Contains Superflex Seal)		JV1050SF
Timing Cover Gasket	1982-1988			T27960	1
Timing Cover Seal	1985-1988	L		48069	1
	1982-1985	E	(Superflex)	65025SF	1

MISCELLANEOUS GASKETS

Air Cleaner Mount Gasket	1982-1985	E	2 Barrel Carburetor	G26906	1
Carb. Mount Gasket	1982-1983	E	Except Carburetor Heater, 2 Barrel Carburetor	G26696	1
Dist. Mounting Gasket	1982-1985	E		72215	1
E.G.R. Gasket	1985-1988	L		G26315	1
	1982-1985	E		G17797	1
Exhaust Pipe Gasket	1985-1988	L	(Ring Type 'F'), Pipe To Manifold	F7209	1
	1985	E	(Ring Type 'E'), Pipe To Manifold	F7207	1
	1982-1985	E	(Ring Type 'F'), Crossover Pipe	F7209	1
	1984	E	(Ring Type 'E'), Pipe To Manifold	F7271	1
	1982-1983	E	(Ring Type 'E'), Pipe To Manifold	F7207	1
Injector Nozzle O-Ring	1985-1988	L		GS33276	3
Oil Pump Cover Gasket	1982-1985	E		B45577	1
Throttle Body Gasket	1985-1988	L		G30995	1
Valve Cover Grommet	1985-1988			GS33334	1
Water Outlet Gasket	1985-1988	L		C31155	1
	1982-1985	E		C26515	1
Water Pump Mount Gasket	1985-1988	L		K30793	1
	1982-1985	E		K27444	1

Part	Year	VIN	Model/Application	Part Number	Qty.	
ENGINE GASKETS						
Head Set	1999-2002	J	(Head Bolts Not Included, Exhaust Pipe Gasket Not Included)	HS54059A	1	
	1997-1999	M	(Head Bolts Not Included, Exhaust Pipe Gasket Not Included)	HS54059B	1	
	1995-1996	M	1st Design Without Push Rod Guides On Intake Gasket, (Head Bolts Not Included, Exhaust Pipe Gasket Not Included)	HS54059	1	
		M	2nd Design With Push Rod Guides On Intake Gasket, (Head Bolts Not Included, Exhaust Pipe Gasket Not Included)	HS54059B	1	
	1993-1994	M	(Head Bolts Not Included, Exhaust Pipe Gasket Not Included)	HS54059	1	
	1991-1994	T	Cavalier, Lumina, Sunbird, (Head Bolts Not Included, Exhaust Pipe Gasket Not Included)	HS3793B	1	
	1993	W	Lumina, (Head Bolts Not Included, Exhaust Pipe Gasket Not Included)	HS3793B	1	
	1991-1993	T	Beretta, Corsica, Cutlass Supreme, Grand Prix, Regal, (Head Bolts Not Included, Exhaust Pipe Gasket Not Included)	HS3793B	1	
	1990-1992	T	Camaro, Firebird, (Contains Head Bolts, Exhaust Pipe Gasket Not Included)	HS3549WB1	1	
		T	Camaro, Firebird, (Head Bolts Not Included, Exhaust Pipe Gasket Not Included)	HS3549X	1	
	1991	T	6000, Tempest, (Head Bolts Not Included, Exhaust Pipe Gasket Not Included)	HS3793B	1	
	1990	T	Cavalier, Lumina, Tempest, (Contains Head Bolts, Exhaust Pipe Gasket Not Included)	HS3793WB	1	
		T	Cavalier, Lumina, Tempest, (Head Bolts Not Included, Exhaust Pipe Gasket Not Included)	HS3793X	1	
	1989-1990	T	Beretta, Celebrity, Corsica, Cutlass Supreme, Grand Prix, Regal, (Contains Head Bolts, Exhaust Pipe Gasket Not Included)	HS3793WB	1	
		T	Beretta, Celebrity, Corsica, Cutlass Supreme, Grand Prix, Regal, (Head Bolts Not Included, Exhaust Pipe Gasket Not Included)	HS3793X	1	
	1988-1990	T	6000, (Contains Head Bolts, Exhaust Pipe Gasket Not Included)	HS3793WB	1	
		T	6000, (Head Bolts Not Included, Exhaust Pipe Gasket Not Included)	HS3793X	1	
	Lower Set	1999-2002	J	(Requires Head Set To Make Full Set)	CS3793A	1
		1993-1999	M	(Requires Head Set To Make Full Set)	CS3793A	1
		1990-1994	T	Transverse Engine, (Requires Head Set To Make Full Set)	CS3793	1
1993		W	Transverse Engine, (Requires Head Set To Make Full Set)	CS3793	1	
1990-1993		T	(Requires Head Set To Make Full Set)	CS3793	1	
1988-1993		T	Transverse Engine, (Requires Head Set To Make Full Set)	CS3793	1	
1989-1990		V	Transverse Engine, (Requires Head Set To Make Full Set)	CS3793	1	
Full Set	1990-1992	T	Except Transverse Engine, (Head Bolts Not Included, Exhaust Pipe Gasket Not Included)	FS3549Z	1	
	1988-1990	T	Transverse Engine, (Head Bolts Not Included, Exhaust Pipe Gasket Not Included)	FS3793X	1	
Engine Kit Gasket Set	1993-1996	M	1st Design Without Push Rod Guides On Intake Gasket	95-3492VR	1	
	1993-1994	W	Aluminum Cylinder Heads, Flex Fuel Engine, (Intake Manifold Gasket Not Included, Exhaust Manifold Gasket Not Included), Use With Part Numbers MS15704A, MS15442	95-3410VR	1	
		T	Aluminum Cylinder Heads, Except Camaro, Firebird, (Intake Manifold Gasket Not Included, Exhaust Manifold Gasket Not Included), Use With Part Numbers MS15704A, MS15442	95-3410VR	1	
	1990-1992	T	Camaro, Firebird, Cast Iron Cylinder Heads	95-3416VR	1	
	1989-1990	V	Aluminum Cylinder Heads, Turbocharged, (Intake Manifold Gasket Not Included, Exhaust Manifold Gasket Not Included), Use With Part Numbers MS15704, MS15442	95-3410VR	1	
	1988-1990	T	Aluminum Cylinder Heads, Except Camaro, Firebird, (Intake Manifold Gasket Not Included, Exhaust Manifold Gasket Not Included), Use With Part Numbers MS15704, MS15442	95-3410VR	1	

General Motors Corp.

41 189 CID (3.1L) Chevrolet V6 Cyl, 3.504in./89mm (1988-2003) **41**
 (cont.) (cont.)

Part	Year	VIN	Model/Application	Part Number	Qty.
ENGINE GASKETS (cont.)					
Cylinder Head Gasket	1999-2003	J		<i>Nitroseal</i> 54059	2
	1993-1999	M		<i>Nitroseal</i> 54059	2
	1988-1994	T	Aluminum Cylinder Heads, Transverse Engine	<i>Nitroseal</i> 3793	2
	1993	W	Aluminum Cylinder Heads, Transverse Engine	<i>Nitroseal</i> 3793	2
	1990-1992	T	Cast Iron Cylinder Heads, Except Transverse Engine		
				<i>VR2000</i> 3549	2
Cyl. Head Bolt Set	1999-2003	J	(1 Set Per Engine)	GS33377	1
	1996-1999	M	(1 Set Per Engine)	GS33377	1
	1988-1993	T	Aluminum Cylinder Heads, Transverse Engine, Rear Head	GS33224	1
		T	Aluminum Cylinder Heads, Transverse Engine, Front Head	GS33225	1
	1990-1992	T	Cast Iron Cylinder Heads	GS33223	2
Cyl. Head Spacer Shim	1988-1994	T	Aluminum Cylinder Heads, Requires Sealing Compound, Transverse Engine		
				<i>Steel</i> 3793S	2
	1993	W	Aluminum Cylinder Heads, Requires Sealing Compound, Transverse Engine	<i>Steel</i> 3793S	2
1990-1991			Aluminum Cylinder Heads, Requires Sealing Compound, Transverse Engine		
				<i>Steel</i> 3793S	2
Valve Cover Set	1999-2003	J		<i>Victo-Tech</i> VS50173	1
		J	(Single Valve Cover)	<i>Victo-Tech</i> VS50174	2
	1993-1999	M		<i>Victo-Tech</i> VS50173	1
		M	(Single Valve Cover)	<i>Victo-Tech</i> VS50174	2
	1988-1994	T	Transverse Engine, (Valve Cover Grommets Not Included)	<i>Victo-Tech</i> VS50053	1
		T	Transverse Engine, (Single Valve Cover, Valve Cover Grommets Not Included)	<i>Victo-Tech</i> VS50120	2
	1993	W	(Valve Cover Grommets Not Included)	<i>Victo-Tech</i> VS50053	1
		W	(Single Valve Cover, Valve Cover Grommets Not Included)	<i>Victo-Tech</i> VS50120	2
	1990-1992	T	Except Transverse Engine	<i>Cork Rubber</i> VS50019	1
Valve Stem Seal, Exh.	1999-2003	J		B45905	6
	1993-1999	M		B45829	6
	1988-1994	T	Transverse Engine	B45612	6
	1990-1992	T	Except Transverse Engine, (O-Ring Type)	B45229	6
	1989-1990	V		B45612	6
Valve Stem Seal, Int.	1999-2003	J		B45905	6
	1993-1999	M		B45829	6
	1988-1994	T	Transverse Engine	B45611	6
	1990-1992	T	Except Transverse Engine, (O-Ring Type)	B45229	6
		T	Except Transverse Engine	<i>Fluoroelastomer</i> B45418	6
	1989-1990	V		B45611	6
Manifold Set, Exhaust	1999-2003	J		MS16173	1
	1993-1999	M		MS16173	1
	1988-1994	T	Transverse Engine	MS15442	1
	1990-1992	T	Except Transverse Engine	MS15310	1
	1989	V	Transverse Engine	MS15442	1
	Manifold Set, Intake	1999-2002	J	(Contains Plenum Chamber Gasket)	MS16259
1997-1999		M	(Contains Plenum Chamber Gasket)	MS16310	1
1995-1996		M	1st Design Without Push Rod Guides On Intake Gasket, (Contains Plenum Chamber Gasket)	MS16166	1
		M	2nd Design With Push Rod Guides On Intake Gasket, (Contains Plenum Chamber Gasket)	MS16310	1
1993-1994		M	(Contains Plenum Chamber Gasket)	MS16166	1
1991-1994		T	Transverse Engine, (Contains Plenum Chamber Gasket)	MS15704A	1
1990-1992		T	Except Transverse Engine	MS15222	1
1988-1990		T	Transverse Engine, (Contains Plenum Chamber Gasket)	MS15704	1
Plenum Chamber Gasket		1999-2003	J		MS17828

41 189 CID (3.1L) Chevrolet V6 Cyl, 3.504in./89mm (1988-2003)

41

(cont.)

(cont.)

Part	Year	VIN	Model/Application	Part Number	Qty.
ENGINE GASKETS (cont.)					
Plenum Chamber Gasket (cont.)	1993-1999	M		MS16157	1
	1991-1994	T	Transverse Engine	MS12414	1
	1988-1990	T	Transverse Engine	MS14752A	1
Oil Pan Set	1999-2003	J	<i>Victo-Tech</i>	OS32132	1
	1994-1999		<i>Victo-Tech</i>	OS32132	1
	1993-1999	M	<i>Victo-Tech</i>	OS32132	1
	1993-1994	T	<i>Victo-Tech</i>	OS32497	1
	1993	W	<i>Victo-Tech</i>	OS32497	1
	1988-1992	T	<i>Tuff-Cork</i>	OS32476TC	1
		T	<i>Victo-Tech</i>	OS32495	1
	1989-1990	V	<i>Tuff-Cork</i>	OS32476TC	1
		V	<i>Victo-Tech</i>	OS32495	1
Rear Main Seal Set	1988-2003			JV544	1
			<i>Teflon</i>	JV1633	1
Timing Cover Set	1999-2003	J		JV1149	1
	1993-1999	M		JV1149	1
	1991-1994	T	Transverse Engine	JV1149	1
	1990-1992	T	Except Transverse Engine	JV1066	1
	1988-1990	T	Transverse Engine	JV1065	1
	Timing Cover Gasket	1999-2003	J		T31259
1993-1999		M		T31259	1
1991-1994		T		T31259	1
1993		W		T31259	1
1989-1990		V		T27635	1
1988-1990		T		T27635	1
Timing Cover Seal		1999-2003	J	<i>3/8" Wide</i>	49328
	J		(Lip Relocator Type) <i>1/2" Wide</i>	65022	1
	1993-1999	M	<i>3/8" Wide</i>	49328	1
		M	(Lip Relocator Type) <i>1/2" Wide</i>	65022	1
	1988-1994	T	<i>3/8" Wide</i>	49328	1
		T	(Lip Relocator Type) <i>1/2" Wide</i>	65022	1
	1993	W	<i>3/8" Wide</i>	49328	1
		W	(Lip Relocator Type) <i>1/2" Wide</i>	65022	1
	1989-1990	V	<i>3/8" Wide</i>	49328	1
		V	(Lip Relocator Type) <i>1/2" Wide</i>	65022	1
Harmonic Balancer Repair Sleeve	1988-1994	T	Use With Part Number A504 <i>Nickel Plated Formed Steel, .013" Thickness</i>	A228-2	1
MISCELLANEOUS GASKETS					
Cam. Cover Gasket	1988-1994	T		H36978	1
	1993	W		H36978	1
	1989-1990	V		H36978	1
E.G.R. Gasket	2000-2003		Valve	G31582	1
	1999	J	Pipe	G31412	1
		J	Valve	G31479	1
	1998-1999	M	Valve	G31479	1
	1996-1999	M	Pipe	G31412	1
	1996-1997	M	Valve	G31513	1
	1993-1995	M	Pipe	G31267	1
		M	Valve	G31268	1
	1990-1994	T	Valve	G31263	1
	1993	W	Valve	G31310	1
	1988-1991	T	(Adapter)	G31100	1
	1988-1989	T, V	Valve	G17797	1
	Exhaust Manifold Extension Gasket	1988-1994	T		F7563
Exhaust Pipe Gasket	2000-2003	J	Century, Grand Prix, Pipe To Manifold	F31588	1

General Motors Corp.

41 189 CID (3.1L) Chevrolet V6 Cyl, 3.504in./89mm (1988-2003) **41**
 (cont.) (cont.)

Part	Year	VIN	Model/Application	Part Number	Qty.
MISCELLANEOUS GASKETS (cont.)					
Exhaust Pipe Gasket (cont.)	1999-2003	J	Malibu, Pipe To Manifold	F31588	1
	2000-2002	J	Century, Grand Prix, Catalytic Converter	F31589	1
	1999-2002	J	Malibu, Catalytic Converter	F10131	1
	2000-2001	J	Lumina, Pipe To Manifold	F31588	1
	1999	J	Cutlass, Catalytic Converter	F10131	1
		J	Cutlass, Pipe To Manifold	F31588	1
	1997-1999	M	Cutlass, Malibu, Catalytic Converter	F10131	1
		M	Century, Cutlass, Grand Prix, Lumina, Malibu, Monte Carlo, Pipe To Manifold	F31588	1
		M	Century, Grand Prix, Catalytic Converter	F31589	1
	1997-1998	M	Achieva, Grand Am, Skylark, Pipe To Manifold	F7506	1
		M	Regal, Pipe To Manifold	F31588	1
		M	Regal, Catalytic Converter	F31589	1
	1994-1998	M	Achieva, Grand Am, Skylark, Catalytic Converter	F10131	1
	1997	M	Cutlass Supreme, Pipe To Manifold	F31588	1
	1994-1996	M	Beretta, Corsica, Catalytic Converter	F10131	1
	1993-1996	M	(Ring Type 'F'), Pipe To Manifold	F12433	1
	1994-1995	M	Somerset, Catalytic Converter	F10131	1
	1991-1994	T	Sunbird, (Ring Type 'F'), Pipe To Manifold	F7210	1
	1990-1994	T	Cavalier, Lumina, (Ring Type 'F'), Pipe To Manifold	F7210	1
	1993	W	Lumina, (Ring Type 'F'), Pipe To Manifold	F7210	1
	1989-1993	T	Beretta, Corsica, Cutlass Supreme, Grand Prix, Regal, (Ring Type 'F'), Pipe To Manifold	F7210	1
	1990-1992	T	Camaro, Firebird, (Ring Type 'F'), Pipe To Manifold	F7210	1
	1990-1991	T	Tempest, (Ring Type 'F'), Pipe To Manifold	F7210	1
	1988-1991	T	6000, (Ring Type 'F'), Pipe To Manifold	F7210	1
	1989-1990	T	Celebrity, (Ring Type 'F'), Pipe To Manifold	F7210	1
V		Grand Prix, (Ring Type 'F'), Pipe To Manifold	F7210	1	
1989	T	Grand Prix, (Ring Type 'F'), Pipe To Manifold	F7210	1	
Injector Nozzle O-Ring	1990-1994	T		GS33276	3
	1993	W		GS33276	3
	1990	V		GS33276	3
	1988-1989			GS33276	3
Oil Filter Adapt Gasket	1999-2002	J		B31606	1
	1993-1999	M		B31606	1
	1988-1994	T	Transverse Engine	B31606	1
	1993	W		B31606	1
	1989-1990	V		B31606	1
Oil Pan Drain Plug Gst.	1999-2003	J		B45828	1
	1993-1999	M		B45828	1
Therm. Housing Gasket	1988-1994	T		<i>Victo-Tech</i> C31156	1
	1993	W		<i>Victo-Tech</i> C31156	1
	1989-1990	V		<i>Victo-Tech</i> C31156	1
Thermostat Seal	1999-2003	J		<i>Victo-Tech</i> C31301	1
	1993-1999	M		<i>Victo-Tech</i> C31301	1
Throttle Body Gasket	2000-2003			G31581	1
	1999	J		G31269	1
	1997-1999	M		G31269	1
	1995-1996	M	Lumina, Monte Carlo	G31269	1
	1994-1996	M	Achieva, Beretta, Corsica, Grand Am, Grand Prix, Regal, Skylark	G31269	1
		M	Century, Cutlass, Cutlass Ciera	G31270	1
	1993-1996	M	Cutlass Supreme	G31269	1
	1994-1995	M	Somerset	G31269	1
	1989-1994	T	Transverse Engine	G31281	1

PASSENGER CAR

41 189 CID (3.1L) Chevrolet V6 Cyl, 3.504in./89mm (1988-2003) **41**
(cont.) (cont.)

Part	Year	VIN	Model/Application	Part Number	Qty.
MISCELLANEOUS GASKETS (cont.)					
Throttle Body Gasket (cont.)	1993	W	Lumina	G31281	1
	1990-1992	T	Except Transverse Engine	G31104	1
	1989-1990	V		G31281	1
Valve Cover Grommet	1990-1994	T	Transverse Engine	GS33305	1
	1993	W	Transverse Engine	GS33305	1
Water By-Pass Gasket	1999	J		C31326	1
	1993-1999	M		C31326	1
	1988-1992	T		C31326	1
	1989-1990	V		C31326	1
Water Outlet Gasket	1999	J	<i>Victo-Tech</i>	C31156	1
	1993-1999	M	<i>Victo-Tech</i>	C31156	1
	1988-1992	T		C30820	1
	1989-1990	V		C30820	1
Water Pump Mount Gasket	1999-2003	J		K30946	1
	1993-1999	M		K30946	1
	1988-1994	T	Transverse Engine	K30946	1
	1990-1992	T	Except Transverse Engine	K30947	1
	1989	V		K30946	1

42 194 CID (3.2L) Chevrolet 6 Cyl, 3.563in./90.5mm (1962-1966) **42**

Part	Year	VIN	Model/Application	Part Number	Qty.
------	------	-----	-------------------	-------------	------

ENGINE GASKETS

Head Set	1962-1966			HS1185E	1
Lower Set	1962-1966		(Requires Head Set To Make Full Set)	CS1185	1
Full Set	1962-1966			FS1185E	1
Engine Kit Gasket Set	1962-1966		(Rear Main Seal Not Included), Use With Part Number JV728	95-3000VR	1
Cylinder Head Gasket	1962-1966		<i>VR2000</i>	3829	1
Valve Cover Set	1962-1966		<i>Cork Rubber</i>	VS39693	1
Valve Stem Seal, Exh.	1962-1966		(O-Ring Type)	B45229	6
Valve Stem Seal, Int.	1962-1966		(O-Ring Type)	B45229	6
Manifold Set, Int. & Exh.	1962-1966			MS16033X	1
Oil Pan Set	1962-1966		<i>Cork Rubber</i>	OS30988X	1
Rear Main Seal Set	1962-1966			JV728	1
Timing Cover Set	1962-1966		(Repair Sleeve Not Included)	JV862	1
			(Contains Repair Sleeve)	JV925	1
Timing Cover Gasket	1962-1966			T14744	1
Timing Cover Seal	1962-1966		<i>3/8" Wide</i>	49328	1
			(Lip Relocator Type) <i>1/2" Wide</i>	65022	1
Harmonic Balancer Repair Sleeve	1962-1966		<i>Ground Steel, .020" Thickness</i>	66597RS	1
			Use With Part Number A504 <i>Nickel Plated Formed Steel, .013" Thickness</i>	A228	1

MISCELLANEOUS GASKETS

Air Cleaner Mount Gasket	1962-1966		1 Barrel Carburetor	G25936	1
Carb. Mount Gasket	1962-1966		1 Barrel Carburetor	G5349AD	1
Dist. Mounting Gasket	1962-1966			B26466	1
Exhaust Pipe Gasket	1962-1966		(Ring Type 'C'), Pipe To Manifold	F17250	1
			(Ring Type 'B'), Pipe To Manifold <i>Sintered Metal</i>	F17250S	1
Fuel Pump Gasket	1962-1966			D27094	1
			<i>Tuff-Cork</i>	D27094TC	1
Push Rod Cover Set	1962-1966		<i>Cork Rubber</i>	PS38113	1

General Motors Corp.

42	194 CID (3.2L) Chevrolet 6 Cyl, 3.563in./90.5mm (1962-1966)	42
(cont.)		(cont.)

Part	Year	VIN	Model/Application	Part Number	Qty.
MISCELLANEOUS GASKETS (cont.)					
Therm. Housing Gasket	1962-1966			C26544	1
Water Outlet Gasket	1962-1966		(Universal Type)	C24109	1
				C25930	1
Water Pump Mount Gasket	1962-1966			K26545	1

43	195 CID (3.2L) Pontiac 4 Cyl, 4.063in./103.2mm (1961-1963)	43
-----------	---	-----------

Part	Year	VIN	Model/Application	Part Number	Qty.
ENGINE GASKETS					
Valve Stem Seal, Exh.	1961-1963		(O-Ring Type)	B45229	4
Valve Stem Seal, Int.	1961-1963		(O-Ring Type)	B45229	4
Manifold Set, Exhaust	1961-1963			MS15085W	1
Manifold Set, Intake	1961-1963			MS15100X	1
Oil Pan Set	1961-1963		Cork Rubber	OS20526A	1
Rear Main Seal Set	1961-1963			JV708	1
Timing Cover Set	1961-1963			JV877	1
Timing Cover Gasket	1961-1963			T27806	1

MISCELLANEOUS GASKETS					
Air Cleaner Mount Gasket	1962-1963		2 Barrel Carburetor	G26410	1
	1961-1963		1 Barrel Carburetor	G25936	1
Carb. Mount Gasket	1961-1963		1 Barrel Carburetor	G7117	1
Dist. Mounting Gasket	1961-1963			B25941	1
Oil Pan Drain Plug Gst.	1961-1963			2051	1
Oil Pump Mounting Gasket	1961-1963			B26457	1

44	196 CID (3.2L) LC9 Buick V6 Cyl, 3.500in./88.9mm (1978-1979)	44
-----------	---	-----------

Part	Year	VIN	Model/Application	Part Number	Qty.
ENGINE GASKETS					
Head Set	1979		(Exhaust Pipe Gasket Not Included, Intake Manifold Gasket Not Included)	HS3741	1
	1978		(Exhaust Pipe Gasket Not Included, Intake Manifold Gasket Not Included)	HS3741A	1
Full Set	1979		(Exhaust Pipe Gasket Not Included, Intake Manifold Gasket Not Included)	FS3741	1
	1978		(Exhaust Pipe Gasket Not Included, Intake Manifold Gasket Not Included)	FS3741A	1
Engine Kit Gasket Set	1979		(Intake Manifold Gasket Not Included, Optional 2 Piece Rubber Rear Main Seal Not Included), Use With Part Numbers MS15958, JV742R	95-3402VR	1
	1978		(Intake Manifold Gasket Not Included, Optional 2 Piece Rubber Rear Main Seal Not Included), Use With Part Numbers MS15948, JV742R	95-3402VR	1
Cylinder Head Gasket	1978-1979		VR2000	5820	2
			Nitroseal	5820SG	2
Valve Cover Set	1978-1979		Cork Rubber	VS39763	1
			Victo-Tech	VS39763R	1
			Tuff-Cork	VS39763TC	1
Valve Stem Seal, Int.	1978-1979			B45497	6
Manifold Set, Exhaust	1979			MS15327	1
	1978			MS15214	1
Manifold Set, Intake	1979			MS15958	1
	1978			MS15948	1
Oil Pan Set	1978-1979		Cork Rubber	OS30668	1

PASSENGER CAR

44 196 CID (3.2L) LC9 Buick V6 Cyl, 3.500in./88.9mm (1978-1979) **44**
(cont.) (cont.)

Part	Year	VIN	Model/Application	Part Number	Qty.
ENGINE GASKETS (cont.)					
Oil Pan Set (cont.)	1978-1979		<i>Tuff-Cork</i>	OS30668TC	1
Rear Main Seal Set	1978-1979		<i>Rope Packing</i>	JV742	1
			<i>Molded Rubber</i>	JV742R	1
Timing Cover Set	1978-1979		<i>Rope Packing</i>	JV906	1
			(Contains Superflex Seal)	JV1051SF	1
Timing Cover Gasket	1978-1979			T27960	1
Timing Cover Seal	1978-1979	(Superflex)		65025SF	1

MISCELLANEOUS GASKETS

Air Cleaner Mount Gasket	1979		2 Barrel Carburetor	G26906	1
	1978		2 Barrel Carburetor	G26617	1
Carb. Mount Gasket	1979		2 Barrel Carburetor	G26696	1
	1978		2 Barrel Carburetor	G26712	1
Dist. Mounting Gasket	1978-1979			72215	1
E.G.R. Gasket	1978-1979			G26315	1
Exhaust Pipe Gasket	1978-1979		(Ring Type 'E'), Pipe To Manifold	F7394	1
Fuel Pump Gasket	1978-1979			D27094	1
			<i>Tuff-Cork</i>	D27094TC	1
Oil Pump Cover Gasket	1978-1979		2nd Design	B45578	1
	1978		1st Design	B45579	1
Water Outlet Gasket	1978-1979			C26515	1
Water Pump Mount Gasket	1978-1979			K27571	1

45 200 CID (3.3L) L26 Chevrolet V6 Cyl, 3.500in./88.9mm (1978-1979) **45**

Part	Year	VIN	Model/Application	Part Number	Qty.
ENGINE GASKETS					
Head Set	1978-1979		(Head Bolts Not Included, Exhaust Pipe Gasket Not Included)	HS3564VC	1
			(Head Bolts Not Included, Exhaust Pipe Gasket Not Included, Contains Beaded Steel Cylinder Head Gasket)	HS3925	1
Full Set	1978-1979		(Head Bolts Not Included, Exhaust Pipe Gasket Not Included)	FS3564VC	1
			(Head Bolts Not Included, Exhaust Pipe Gasket Not Included, Contains Beaded Steel Cylinder Head Gasket)	FS3925	1
Engine Kit Gasket Set	1978-1979			95-3063VR	1
Cylinder Head Gasket	1978-1979		<i>VR2000</i>	3564VC	2
			<i>Beaded Steel</i>	3925	2
			<i>Nitroseal</i>	3925SG	2
Cyl. Head Bolt Set	1978-1979			GS33286	2
Valve Cover Set	1978-1979		<i>Cork Rubber</i>	VS39766	1
			<i>High Temperature Cork Rubber</i>	VS39766H	1
Valve Stem Seal, Exh.	1978-1979		(O-Ring Type)	B45229	6
Valve Stem Seal, Int.	1978-1979		(O-Ring Type)	B45229	6
Manifold Set, Exhaust	1978-1979			MS15251	1
Manifold Set, Intake	1978-1979			MS15224	1
Oil Pan Set	1978-1979		<i>Cork Rubber</i>	OS30934	1
			<i>Tuff-Cork</i>	OS30934TC	1
Rear Main Seal Set	1978-1979		(Lip Relocator Type)	JV1627	1
Timing Cover Set	1978-1979		(Repair Sleeve Not Included)	JV881	1
			(Contains Repair Sleeve)	JV926	1
	1978		(Repair Sleeve Not Included)	<i>Tuff-Cork</i> JV881TC	1
Timing Cover Gasket	1978-1979			T27781	1
Timing Cover Seal	1978-1979			<i>3/8" Wide</i> 49328	1
			(Lip Relocator Type)	<i>1/2" Wide</i> 65022	1

General Motors Corp.

45 200 CID (3.3L) L26 Chevrolet V6 Cyl, 3.500in./88.9mm (1978-1979) **45**
(cont.) (cont.)

Part Year VIN Model/Application Part Number Qty.

ENGINE GASKETS (cont.)

Harmonic Balancer Repair Sleeve	1978-1979		Ground Steel, .020" Thickness	66597RS	1
			Use With Part Number A504 Nickel Plated Formed Steel, .013" Thickness	A228	1

MISCELLANEOUS GASKETS

Air Cleaner Mount Gasket	1978-1979		2 Barrel Carburetor	G26906	1
Carb. Mount Gasket	1978-1979		2 Barrel Carburetor	G26693	1
Dist. Mounting Gasket	1978-1979			B25934	1
E.G.R. Gasket	1978-1979			G17797	1
Exhaust Pipe Gasket	1978-1979		2.5" Pipe, (Ring Type 'C'), Pipe To Manifold	F7139	2
			2.5" Pipe, (Ring Type 'B'), Pipe To Manifold <i>Sintered Metal</i>	F7139S	1
			2" Pipe, (Ring Type 'C'), Pipe To Manifold	F17250	1
			2" Pipe, (Ring Type 'B'), Pipe To Manifold <i>Sintered Metal</i>	F17250S	1
Fuel Pump Gasket	1978-1979		Pump To Plate	D27094	1
			Pump To Plate <i>Tuff-Cork</i>	D27094TC	1
			Plate To Block	D27211	1
Oil Pan Drain Plug Gst.	1978-1979			2051	1
Oil Pump Shaft Retainer	1978-1979			H31354	1
Water Outlet Gasket	1978-1979		(Universal Type)	C24109	1
				C25930	1
Water Pump Mount Gasket	1978-1979			K25935	2

46 204 CID (3.3L) LG7 Buick V6 Cyl, 3.701in./94mm (1989-1993) **46**

Part Year VIN Model/Application Part Number Qty.

ENGINE GASKETS

Head Set	1992-1993		(Head Bolts Not Included, Exhaust Pipe Gasket Not Included)	HS5748A	1
			(Contains Head Bolts, Exhaust Pipe Gasket Not Included)	HS5748WB1	1
	1989-1991		(Head Bolts Not Included, Exhaust Pipe Gasket Not Included)	HS5748	1
			(Contains Head Bolts, Exhaust Pipe Gasket Not Included)	HS5748WB	1
Full Set	1992-1993		(Head Bolts Not Included, Exhaust Pipe Gasket Not Included)	FS5748A	1
	1991		(Head Bolts Not Included, Exhaust Pipe Gasket Not Included)	FS5748W	1
	1989-1990		(Head Bolts Not Included, Exhaust Pipe Gasket Not Included)	FS5748	1
Engine Kit Gasket Set	1991-1993			95-3163VR	1
	1989-1990		(Optional 2 Piece Rubber Rear Main Seal Not Included), Use With Part Number JV742R	95-3163VR	1
Cylinder Head Gasket	1989-1993		<i>Nitroseal</i>	5748	2
Cyl. Head Bolt Set	1989-1993			GS33233	2
Valve Cover Set	1989-1993		<i>Victo-Tech</i>	VS50052	1
			(Single Valve Cover) <i>Victo-Tech</i>	VS50123	2
Valve Stem Seal, Exh.	1989-1993			B45591	6
Valve Stem Seal, Int.	1989-1993			B45484	6
Manifold Set, Exhaust	1990-1993			MS15669	1
	1989-1993			MS15569	1
Manifold Set, Intake	1992-1993		<i>Nitroseal</i>	MS15624X	1
	1989-1991		<i>Nitroseal</i>	MS15624W	1
Oil Pan Set	1989-1993		<i>Victo-Tech</i>	OS32022	1
Rear Main Seal Set	1991-1993			JV599	1
	1989-1990		(Not Contained In Full Set) <i>Rope Packing</i>	JV742	1
				<i>Molded Rubber</i>	JV742R

PASSENGER CAR

46 204 CID (3.3L) LG7 Buick V6 Cyl, 3.701in./94mm (1989-1993) **46**
(cont.) (cont.)

Part Year VIN Model/Application Part Number Qty.

ENGINE GASKETS (cont.)

Crank Repair Sleeve	1991-1993		<i>Nickel Plated Formed Steel, .013" Thickness</i>	A353	1
Timing Cover Set	1989-1993			JV1114	1
Timing Cover Seal	1989-1993			48069	1
Harmonic Balancer Repair Sleeve	1989-1993		<i>Nickel Plated Formed Steel, .013" Thickness</i>	A237	1

MISCELLANEOUS GASKETS

Exhaust Pipe Gasket	1992-1993		(Ring Type 'F'), Crossover Pipe, Pipe To Manifold	F7514	1
			(Ring Type 'F'), Pipe To Manifold	F7514	1
	1989-1993		(Ring Type 'F'), Crossover Pipe	F7514	1
			(Ring Type 'E'), Lower	F10144	1
	1990-1991		Catalytic Converter <i>51mm Inside Diameter</i>	F10131	1
1990		Catalytic Converter <i>58mm Inside Diameter</i>	F10132	1	
Injector Nozzle O-Ring	1989-1991			GS33276	3
Oil Pan Drain Plug Gst.	1989-1993			2051	1
Thermostat O-Ring	1989-1993		<i>Victo-Tech</i>	C31227	1
Throttle Body Gasket	1989-1993			G31364	1
Valve Cover Grommet	1989-1993			GS33304	1
Water Outlet Gasket	1989-1993			C31098	1
Water Pump Mount Gasket	1989-1993			K30793	1

47 207 CID (3.4L) L32 Chevrolet V6 Cyl, 3.622in./92mm (1993-1995) **47**

Part Year VIN Model/Application Part Number Qty.

ENGINE GASKETS

Head Set	1993-1995		(Head Bolts Not Included, Exhaust Pipe Gasket Not Included)	HS4955	1
Lower Set	1993-1995		(Requires Head Set To Make Full Set)	CS4955	1
Cylinder Head Gasket	1993-1995		<i>VR2000</i>	4955	2
Cyl. Head Bolt Set	1993-1995			GS33232	2
Valve Cover Set	1993-1995		<i>Cork Rubber</i>	VS50019	1
Valve Stem Seal, Exh.	1993-1995		(O-Ring Type)	B45229	6
Valve Stem Seal, Int.	1993-1995		(O-Ring Type)	B45229	6
			<i>Fluoroelastomer</i>	B45418	6
Manifold Set, Exhaust	1993-1995			MS15310	1
Manifold Set, Intake	1993-1995		(Requires Valve Cover Set)	MS15307	1
Plenum Chamber Gasket	1993-1995			MS14162	1
Oil Pan Set	1993-1995		<i>Victo-Tech</i>	OS32497	1
Rear Main Seal Set	1993-1995			JV544	1
			<i>Teflon</i>	JV1633	1
Timing Cover Set	1993-1995			JV1203	1
Timing Cover Gasket	1993-1995			T31259	1
Timing Cover Seal	1993-1995		<i>3/8" Wide</i>	49328	1
			(Lip Relocator Type) <i>1/2" Wide</i>	65022	1

MISCELLANEOUS GASKETS

E.G.R. Gasket	1993-1995		Mounting	G31263	1
			(Adapter)	G31265	1
Exhaust Pipe Gasket	1993-1995		(Ring Type 'F'), Pipe To Manifold	F7519	1
			(Ring Type 'F'), Crossover Pipe To Manifold	F10143	1
Injector Nozzle O-Ring	1993-1995			GS33276	3
Oil Filter Adapt Gasket	1993-1995			B31606	1
Oil Pan Drain Plug Gst.	1993-1995			2051	1
Thermostat Seal	1993-1995		<i>Victo-Tech</i>	C31156	1
Throttle Body Gasket	1993-1995			G31269	1

PASSENGER CAR

General Motors Corp.

47	207 CID (3.4L) L32 Chevrolet V6 Cyl, 3.622in./92mm (1993-1995)	47
(cont.)		(cont.)

Part	Year	VIN	Model/Application	Part Number	Qty.
------	------	-----	-------------------	-------------	------

MISCELLANEOUS GASKETS (cont.)

Water Pump Mount Gasket	1993-1995			K30947	1
-------------------------	-----------	--	--	--------	---

48	207 CID (3.4L) LA1 Chevrolet V6 Cyl, 3.622in./92mm (1999-2003)	48
-----------	---	-----------

Part	Year	VIN	Model/Application	Part Number	Qty.
------	------	-----	-------------------	-------------	------

ENGINE GASKETS

Head Set	2000-2003		(Exhaust Pipe Gasket Not Included)	HS4956A	1
	1999		(Exhaust Pipe Gasket Not Included)	HS4956	1
Lower Set	1999-2003		(Requires Head Set To Make Full Set)	CS3793A	1
Cylinder Head Gasket	1999-2003		VR2000	4956	2
Cyl. Head Bolt Set	1999-2003		(1 Set Per Engine)	GS33377	1
Valve Cover Set	1999-2003		Victo-Tech	VS50173	1
			Victo-Tech	VS50174	2
Valve Stem Seal, Exh.	2000-2003			B45905	6
	1999-2000			B45829	6
Valve Stem Seal, Int.	2000-2003			B45905	6
	1999-2000			B45829	6
Manifold Set, Exhaust	1999-2003			MS16173	1
Manifold Set, Intake	1999-2003		(Contains Plenum Chamber Gasket)	MS16259	1
Plenum Chamber Gasket	1999-2003			MS17828	1
Oil Pan Set	1999-2003		Victo-Tech	OS32132	1
Rear Main Seal Set	1999-2003			JV544	1
			Teflon	JV1633	1
Timing Cover Set	1999-2003			JV1149	1
Timing Cover Gasket	1999-2003			T31259	1
Timing Cover Seal	1999-2003		3/8" Wide	49328	1
			1/2" Wide	65022	1

MISCELLANEOUS GASKETS

E.G.R. Gasket	2000-2003		Valve	G31582	1
	1999		Pipe	G31412	1
				Single Exhaust, Valve	G31479
Exhaust Pipe Gasket	1999-2003		Grand Am, Dual Exhaust, Catalytic Converter	F10132	1
				Pipe To Manifold	F31588
	2000-2002		Impala, Monte Carlo, Catalytic Converter	F31589	1
	1999-2002		Alero, Grand Am, Single Exhaust, Catalytic Converter	F10131	1
Oil Filter Adapt Gasket	1999-2003			B31606	1
Oil Pan Drain Plug Gst.	1999-2003			B45828	1
Thermostat Seal	1999-2003		Victo-Tech	C31301	1
Throttle Body Gasket	2000-2003			G31581	1
	1999			G31269	1
Water Pump Mount Gasket	1999-2003			K30946	1

49	207 CID (3.4L) LQ1 DOHC Chevrolet V6 Cyl, 3.622in./92mm (1991-1997)	49
-----------	--	-----------

Part	Year	VIN	Model/Application	Part Number	Qty.
------	------	-----	-------------------	-------------	------

ENGINE GASKETS

Head Set	1996-1997		(Exhaust Pipe Gasket Not Included)	HS4957B	1
	1991-1995		(Exhaust Pipe Gasket Not Included)	HS4957	1
Lower Set	1991-1997		(Requires Head Set To Make Full Set)	CS4957	1
Cylinder Head Gasket	1991-1997			4957	2
Valve Cover Set	1994-1997		Victo-Tech	VS50236	1
	1991-1993		Victo-Tech	VS50235	1
Valve Stem Seal, Exh.	1991-1997			B45672	12

49 207 CID (3.4L) LQ1 DOHC Chevrolet V6 Cyl, 3.622in./92mm (1991-1997) **49**
(cont.) (cont.)

Part	Year	VIN	Model/Application	Part Number	Qty.	
ENGINE GASKETS (cont.)						
Valve Stem Seal, Int.	1991-1997			B45672	12	
Manifold Set, Exhaust	1991-1997			MS16098	1	
	1991-1995			MS12413	1	
Manifold Set, Intake	1996-1997			MS16092	1	
	1991-1995			MS16174	1	
Plenum Chamber Gasket	1996-1997			MS16317	1	
	1991-1995			MS15472	1	
Oil Pan Set	1991-1997		Victo-Tech	OS32497	1	
Rear Main Seal Set	1991-1997			JV544	1	
				Teflon	JV1633	1
Timing Cover Set	1991-1997			JV1199	1	
Timing Cover Gasket	1991-1997			T31270	1	
Timing Cover Seal	1991-1997			3/8" Wide	49328	1
				(Lip Relocator Type)	1/2" Wide	65022

MISCELLANEOUS GASKETS

E.G.R. Gasket	1996-1997		Tube To Throttle Body/EGR Adapter	G31412	1
			Valve To Throttle Body/EGR Adapter	G31479	1
	1991-1995		Adapter To Plenum	G31260	1
			EGR To Adapter	G31261	1
Exhaust Pipe Gasket	1991-1995		(Ring Type 'F'), Pipe To Manifold	F7519	1
Injector Nozzle O-Ring	1991-1997			GS33276	3
Oil Pan Drain Plug Gst.	1995-1997			B45828	1
	1994			MS16364	1
	1991-1994			2051	1
Thermostat Seal	1991-1997		Victo-Tech	C31262	1
Throttle Body Gasket	1996-1997			G31519	1
Water Pump Mount Gasket	1991-1997			K30946	1

50 212 CID (3.5L) LX5 Oldsmobile V6 Cyl, 3.524in./89.5mm (1999-2002) **50**

Part	Year	VIN	Model/Application	Part Number	Qty.
MISCELLANEOUS GASKETS					
Exhaust Pipe Gasket	1999-2002		Intrigue, (Flange Type), Catalytic Converter To Center Pipe	F31589	1
			(Flange Type), Manifold To Exhaust Pipe, Rear	F31593	1
Oil Pan Drain Plug Gst.	1999-2002			B45828	1

51 215 CID (3.5L) Pontiac 6 Cyl, 3.750in./95.3mm (1964-1965) **51**

Part	Year	VIN	Model/Application	Part Number	Qty.
ENGINE GASKETS					
Head Set	1964-1965		(Exhaust Pipe Gasket Not Included)	HS1185E	1
Full Set	1964-1965		(Exhaust Pipe Gasket Not Included)	FS1185E	1
Engine Kit Gasket Set	1964-1965		(Rear Main Seal Not Included), Use With Part Number JV728	95-3000VR	1
Cylinder Head Gasket	1964-1965		VR2000	3829	1
Valve Cover Set	1964-1965		Cork Rubber	VS39693	1
Valve Stem Seal, Exh.	1964-1965		(O-Ring Type)	B45229	6
Valve Stem Seal, Int.	1964-1965		(O-Ring Type)	B45229	6
Manifold Set, Int. & Exh.	1964-1965			MS16033X	1
Oil Pan Set	1964-1965		Cork Rubber	OS30988X	1
Rear Main Seal Set	1964-1965			JV728	1
Timing Cover Set	1964-1965		(Repair Sleeve Not Included)	JV862	1
			(Contains Repair Sleeve)	JV925	1

General Motors Corp.

51 (cont.)	215 CID (3.5L) Pontiac 6 Cyl, 3.750in./95.3mm (1964-1965)				51 (cont.)
----------------------	--	--	--	--	----------------------

<i>Part</i>	<i>Year</i>	<i>VIN</i>	<i>Model/Application</i>	<i>Part Number</i>	<i>Qty.</i>
ENGINE GASKETS (cont.)					
Harmonic Balancer Repair Sleeve	1964-1965		<i>Ground Steel, .020" Thickness</i>	66597RS	1
			Use With Part Number A504 <i>Nickel Plated Formed Steel, .013" Thickness</i>	A228	1

MISCELLANEOUS GASKETS						
Carb. Mount Gasket	1964-1965		1 Barrel Carburetor	G5349AD	1	
Dist. Mounting Gasket	1964-1965			B26466	1	
Exhaust Pipe Gasket	1964-1965		(Ring Type 'C'), Pipe To Manifold	F17250	1	
			(Ring Type 'B'), Pipe To Manifold	<i>Sintered Metal</i>	F17250S	1
Fuel Pump Gasket	1964-1965		Plate To Block	D25932	1	
			Plate To Block	<i>Tuff-Cork</i>	D25932TC	1
			Pump To Plate	D27094	1	
			Pump To Plate	<i>Tuff-Cork</i>	D27094TC	1
Oil Pan Drain Plug Gst.	1964-1965			2051	1	
Push Rod Cover Set	1964-1965		<i>Cork Rubber</i>	PS38113	1	
Therm. Housing Gasket	1964-1965			C26544	1	
Water Outlet Gasket	1964-1965		(Universal Type)	C24109	1	
				C25930	1	
Water Pump Mount Gasket	1964-1965			K26545	1	

52	215 CID (3.5L) Aluminum Block & Heads Buick V8 Cyl, 3.500in./88.9mm (1961-1963)				52
-----------	--	--	--	--	-----------

<i>Part</i>	<i>Year</i>	<i>VIN</i>	<i>Model/Application</i>	<i>Part Number</i>	<i>Qty.</i>
ENGINE GASKETS					
Head Set	1961-1963		(Intake Manifold Gasket Not Included, Exhaust Manifold Gasket Not Included)	HS1174BS	1
Full Set	1961-1963		(Intake Manifold Gasket Not Included, Exhaust Manifold Gasket Not Included)	FS1174BS	1
Cylinder Head Gasket	1961-1963		<i>Beaded Steel</i>	1174BS	2
Valve Cover Set	1961-1963		<i>Cork Rubber</i>	VS38118	1
Manifold Set, Exhaust	1961-1963			MS7184	1
Manifold Set, Intake	1961-1963			MS15806	1
Oil Pan Set	1961-1963		<i>Cork Rubber</i>	OS30665	1
Rear Main Seal Set	1961-1963		<i>Rope Packing</i>	JV742	1
Timing Cover Set	1961-1963			JV844	1
Timing Cover Gasket	1961-1963			T27960	1

MISCELLANEOUS GASKETS					
Air Cleaner Mount Gasket	1961-1963		2 Barrel Carburetor	G25936	1
			4 Barrel Carburetor	G26410	1
Carb. Mount Gasket	1962-1963		2 Barrel Carburetor	G26576	1
	1961		2 Barrel Carburetor, Adapter To Manifold	G26576	1
Dist. Mounting Gasket	1961-1963			72215	1
Fuel Pump Gasket	1961-1963			D27094	1
			<i>Tuff-Cork</i>	D27094TC	1
Heat Riser Gasket	1961-1963			F5421K	4
Oil Pan Drain Plug Gst.	1961-1963			2051	1
Therm. Mount Gasket	1961-1963			C26515	1
Water Pump Mount Gasket	1961-1963			K27571	1

Part	Year	VIN	Model/Application	Part Number	Qty.
ENGINE GASKETS					
Head Set	1950-1952		Powerglide Transmission	HS1065K	1
	1946-1952		Manual Transmission	HS1050K	1
	1940-1942		Manual Transmission	HS1050K	1
	1937-1939			HS1050K	1
Full Set	1946-1952		Manual Transmission	FS1050KX	1
	1940-1942		Manual Transmission	FS1050KX	1
	1937-1939			FS1050K	1
Cylinder Head Gasket	1950-1952		Powerglide Transmission <i>VR2000</i>	1065K	1
	1946-1952		Manual Transmission <i>VR2000</i>	1050K	1
	1940-1942		Manual Transmission <i>VR2000</i>	1050K	1
	1937-1939		<i>VR2000</i>	1050K	1
Valve Cover Set	1946-1952		<i>Cork Rubber</i>	VS39725	1
	1937-1942		<i>Cork Rubber</i>	VS39725	1
Valve Stem Seal, Exh.	1946-1952		(O-Ring Type)	B45229	6
	1937-1942		(O-Ring Type)	B45229	6
Valve Stem Seal, Int.	1946-1952		(O-Ring Type)	B45229	6
	1937-1942		(O-Ring Type)	B45229	6
Manifold Set, Int. & Exh.	1946-1952			MS12185X	1
	1937-1942			MS12185X	1
Oil Pan Set	1946-1952		<i>Cork Rubber</i>	OS30902	1
	1940-1942		<i>Cork Rubber</i>	OS30902	1
	1937-1939		<i>Cork Rubber</i>	OS30977	1
Rear Main Seal Set	1946-1952			JV650	1
	1940-1942			JV650	1
Timing Cover Set	1949-1952			JV754	1
	1946-1948			JV753	1
	1937-1942			JV753	1
Timing Cover Seal	1946-1952		<i>3/8" Wide</i>	49328	1
		(Lip Relocator Type)	<i>1/2" Wide</i>	65022	1
	1937-1942		<i>3/8" Wide</i>	49328	1
		(Lip Relocator Type)	<i>1/2" Wide</i>	65022	1
Harmonic Balancer Repair Sleeve	1946-1952		<i>Ground Steel, .020" Thickness</i>	66597RS	1
		Use With Part Number A504 <i>Nickel Plated Formed Steel, .013" Thickness</i>	A228	1	
	1937-1942		<i>Ground Steel, .020" Thickness</i>	66597RS	1
		Use With Part Number A504 <i>Nickel Plated Formed Steel, .013" Thickness</i>	A228	1	
MISCELLANEOUS GASKETS					
Exhaust Pipe Gasket	1950-1952		(Ring Type 'C'), Pipe To Manifold	F17250	1
			(Ring Type 'B'), Pipe To Manifold <i>Sintered Metal</i>	F17250S	1
			Manual Transmission, (Ring Type 'C'), Pipe To Manifold	F17355	1
	1949		(Flange Type), Pipe To Manifold	F5436AK	3
	1946-1948		(Ring Type 'C'), Pipe To Manifold	F17355	1
	1937-1942		(Ring Type 'C'), Pipe To Manifold	F17355	1
Fuel Pump Bowl Gasket	1946-1952			D34545	1
	1937-1942			D34545	1
Fuel Pump Gasket	1946-1952			D27094	1
			<i>Tuff-Cork</i>	D27094TC	1
	1937-1942			D27094	1
		<i>Tuff-Cork</i>	D27094TC	1	
Fuel Pump Plate Gasket	1946-1952			D25932	1
			<i>Tuff-Cork</i>	D25932TC	1
	1937-1942			D25932	1
			<i>Tuff-Cork</i>	D25932TC	1

General Motors Corp.

53 216 CID (3.5L) Chevrolet 6 Cyl, 3.500in./88.9mm (1937-1952) **53**
(cont.) (cont.)

Part	Year	VIN	Model/Application	Part Number	Qty.
MISCELLANEOUS GASKETS (cont.)					
Manifold Seal, Intake	1946-1952			B17473	1
	1937-1942			B17473	1
Oil Pan Drain Plug Gst.	1946-1952			2051	1
	1937-1942			2051	1
Push Rod Cover Seal	1946-1952			H34510	6
	1937-1942			H34510	6
Push Rod Cover Set	1950-1952		Powerglide Transmission <i>Cork Rubber</i>	PS39685	1
	1946-1952		Manual Transmission <i>Cork Rubber</i>	PS39840	1
	1937-1942		Manual Transmission <i>Cork Rubber</i>	PS39840	1
Therm. Housing Gasket	1946-1952			C24529	1
	1937-1942			C24529	1
Water Outlet Gasket	1946-1952		(Universal Type)	C24109	1
				C25930	1
	1937-1942		(Universal Type)	C24109	1
				C25930	1
Water Pump Mount Gasket	1946-1952			K25739	1
	1940-1942			K25739	1

54 225 CID (3.7L) Buick V6 Cyl, 3.750in./95.3mm (1964-1967) **54**

Part	Year	VIN	Model/Application	Part Number	Qty.
ENGINE GASKETS					
Head Set	1964-1967			HS1193VC	1
Full Set	1964-1967			FS1193VE	1
Cylinder Head Gasket	1964-1967		VR2000	5820	2
Valve Cover Set	1964-1967		<i>Cork Rubber</i>	VS38303	1
Manifold Set, Exhaust	1964-1967			MS15214	1
Manifold Set, Intake	1964-1967			MS15123	1
Oil Pan Set	1964-1967		<i>Cork Rubber</i>	OS30668	1
			<i>Tuff-Cork</i>	OS30668TC	1
Rear Main Seal Set	1964-1967		<i>Rope Packing</i>	JV742	1
			<i>Molded Rubber</i>	JV742R	1
Timing Cover Set	1964-1967		<i>Rope Packing</i>	JV844	1
			(Contains Superflex Seal)	JV1052SF	1
Timing Cover Gasket	1964-1967			T27960	1
Timing Cover Seal	1964-1967		(Superflex)	65025SF	1
MISCELLANEOUS GASKETS					
Air Cleaner Mount Gasket	1964-1967			G25936	1
Carb. Mount Gasket	1966-1967		2 Barrel Carburetor	G7374	1
	1964-1965		1 Barrel Carburetor	G5349AD	1
			1 Barrel Carburetor, 1 Barrel Carburetor	G5349AD	1
	1964		1 Barrel Carburetor	G5349AD	1
Dist. Mounting Gasket	1964-1967			72215	1
Fuel Pump Gasket	1964-1967			D27094	1
			<i>Tuff-Cork</i>	D27094TC	1
Oil Pan Drain Plug Gst.	1964-1967			2051	1
Therm. Mount Gasket	1964-1967			C26515	1
Water Pump Mount Gasket	1964-1967			K27571	1

PASSENGER CAR

Part	Year	VIN	Model/Application	Part Number	Qty.
ENGINE GASKETS					
Head Set	1980-1984		(Head Bolts Not Included, Exhaust Pipe Gasket Not Included, Contains Beaded Steel Cylinder Head Gasket)	HS3564BS	1
			(Head Bolts Not Included, Exhaust Pipe Gasket Not Included)	HS3564VC	1
Full Set	1980-1984		(Head Bolts Not Included, Exhaust Pipe Gasket Not Included, Contains Beaded Steel Cylinder Head Gasket)	FS3564BS	1
			(Head Bolts Not Included, Exhaust Pipe Gasket Not Included)	FS3564VC	1
Engine Kit Gasket Set	1980-1984			95-3063VR	1
Cylinder Head Gasket	1980-1984		<i>Beaded Steel</i>	3564BS	2
			<i>VR2000</i>	3564VC	2
			<i>Nitroseal</i>	3925SG	2
Cyl. Head Bolt Set	1980-1984			GS33286	2
Valve Cover Set	1980-1984		<i>Cork Rubber</i>	VS39766	1
			<i>High Temperature Cork Rubber</i>	VS39766H	1
Valve Stem Seal, Exh.	1981-1984		(Shedder Type)	B45264	6
			(High Temperature)	B45779	6
	1980-1984		(O-Ring Type)	B45229	6
Valve Stem Seal, Int.	1981-1984		(Positive Type) <i>Fluoroelastomer</i>	B45418	6
		1980-1984	(O-Ring Type)	B45229	6
Manifold Set, Exhaust	1980-1984			MS15251	1
Manifold Set, Intake	1980-1984			MS15224	1
Oil Pan Set	1980-1984		<i>Cork Rubber</i>	OS30934	1
			<i>Tuff-Cork</i>	OS30934TC	1
Rear Main Seal Set	1980-1984		(Lip Relocator Type)	JV1627	1
Timing Cover Set	1980-1984		(Repair Sleeve Not Included)	JV881	1
			(Repair Sleeve Not Included) <i>Tuff-Cork</i>	JV881TC	1
			(Contains Repair Sleeve)	JV926	1
Timing Cover Gasket	1980-1984			T27781	1
Timing Cover Seal	1980-1984		<i>3/8" Wide</i>	49328	1
			(Lip Relocator Type) <i>1/2" Wide</i>	65022	1
Harmonic Balancer Repair Sleeve	1980-1984		<i>Ground Steel, .020" Thickness</i>	66597RS	1
			Use With Part Number A504 <i>Nickel Plated Formed Steel, .013" Thickness</i>	A228	1
MISCELLANEOUS GASKETS					
Air Cleaner Mount Gasket	1980-1984		2 Barrel Carburetor	G26906	1
Carb. Mount Gasket	1980-1984		2 Barrel Carburetor	G26693	1
Dist. Mounting Gasket	1980-1984			B25934	1
E.G.R. Gasket	1980-1984			G17797	1
Exhaust Pipe Gasket	1980-1984		(Ring Type 'C'), Pipe To Manifold	F17250	1
			(Ring Type 'B'), Pipe To Manifold <i>Sintered Metal</i>	F17250S	1
Fuel Pump Gasket	1980-1984		Pump To Plate	D27094	1
			Pump To Plate <i>Tuff-Cork</i>	D27094TC	1
			Plate To Block	D27211	1
Oil Pan Drain Plug Gst.	1980-1984			2051	1
Oil Pump Shaft Retainer	1980-1984			H31354	1
Water Outlet Gasket	1980-1984		(Universal Type)	C24109	1
				C25930	1
Water Pump Mount Gasket	1980-1984			K25935	2

General Motors Corp.

56 230 CID (3.8L) Chevrolet 6 Cyl, 3.875in./98.4mm (1964-1970)

56

Part	Year	VIN	Model/Application	Part Number	Qty.
ENGINE GASKETS					
Head Set	1964-1970			HS1185E	1
Lower Set	1964-1970		(Requires Head Set To Make Full Set)	CS1185	1
Full Set	1964-1970			FS1185E	1
Engine Kit Gasket Set	1968-1970			95-3000VR	1
	1964-1967		(Rear Main Seal Not Included), Use With Part Number JV728	95-3000VR	1
Cylinder Head Gasket	1964-1970		VR2000	3829	1
Valve Cover Set	1964-1970		Cork Rubber	VS39693	1
Valve Stem Seal, Exh.	1964-1970		(O-Ring Type)	B45229	6
Valve Stem Seal, Int.	1964-1970		(O-Ring Type)	B45229	6
Manifold Gasket	1964-1970		Intake To Exhaust	B7354	1
Manifold Set, Int. & Exh.	1964-1970			MS16033X	1
Oil Pan Set	1964-1970		Cork Rubber	OS30988X	1
Rear Main Seal Set	1969-1970		(Lip Relocator Type)	JV1627	1
	1968		Except Distributor Boss Stamped F0623 With "R" Under Date, (Lip Relocator Type)	JV1627	1
	1964-1968		Distributor Boss Stamped F0623 With "R" Under Date	JV728	1
	1964-1965			JV728	1
Timing Cover Set	1964-1970		(Repair Sleeve Not Included)	JV862	1
			(Contains Repair Sleeve)	JV925	1
Timing Cover Gasket	1964-1970			T14744	1
Timing Cover Seal	1964-1970		3/8" Wide	49328	1
			(Lip Relocator Type) 1/2" Wide	65022	1
Harmonic Balancer Repair Sleeve	1964-1970		Ground Steel, .020" Thickness	66597RS	1
			Use With Part Number A504 Nickel Plated Formed Steel, .013" Thickness	A228	1

MISCELLANEOUS GASKETS

Air Cleaner Mount Gasket	1964-1970		1 Barrel Carburetor	G25936	1
Carb. Mount Gasket	1964-1970		1 Barrel Carburetor	G5349AD	1
Dist. Mounting Gasket	1964-1970			B26466	1
Exhaust Pipe Gasket	1964-1970		(Ring Type 'C'), Pipe To Manifold	F17250	1
			(Ring Type 'B'), Pipe To Manifold Sintered Metal	F17250S	1
Fuel Pump Gasket	1964-1970			D27094	1
			Tuff-Cork	D27094TC	1
Oil Pan Drain Plug Gst.	1964-1970			2051	1
Push Rod Cover Set	1964-1970		Cork Rubber	PS38113	1
Therm. Housing Gasket	1964-1970			C26544	1
Water Outlet Gasket	1964-1970		(Universal Type)	C24109	1
				C25930	1
Water Pump Mount Gasket	1964-1970			K26545	1

57 230 CID (3.8L) OHC Pontiac 6 Cyl, 3.875in./98.4mm (1966-1967)

57

Part	Year	VIN	Model/Application	Part Number	Qty.
ENGINE GASKETS					
Valve Cover Set	1966-1967			VS29699	1
Valve Stem Seal, Exh.	1966-1967		(O-Ring Type)	B45229	6
Valve Stem Seal, Int.	1966-1967		(O-Ring Type)	B45229	6
				B45299	6
Timing Cover Set	1966-1967			JV857	1
MISCELLANEOUS GASKETS					
Camshaft Seal	1966-1967			47444	1
Carb. Mount Gasket	1967		4 Barrel Carburetor	G14579	1

57 230 CID (3.8L) OHC Pontiac 6 Cyl, 3.875in./98.4mm (1966-1967) **57**
(cont.) (cont.)

Part	Year	VIN	Model/Application	Part Number	Qty.
MISCELLANEOUS GASKETS (cont.)					
Carb. Mount Gasket (cont.)	1966		4 Barrel Carburetor	G26652	1
Fuel Pump Gasket	1966-1967			D27094	1
				Tuff-Cork	D27094TC
Oil Pan Drain Plug Gst.	1966-1967			2051	1
Water Outlet Gasket	1966-1967			C24109	1

58 231 CID (3.8L) Carbureted Buick V6 Cyl, 3.800in./96.5mm (1975-1987) **58**

Part	Year	VIN	Model/Application	Part Number	Qty.
------	------	-----	-------------------	-------------	------

ENGINE GASKETS

Head Set	1986-1987		(Head Bolts Not Included, Exhaust Pipe Gasket Not Included, Intake Manifold Gasket Not Included)	HS3777	1
			(Contains Head Bolts, Exhaust Pipe Gasket Not Included, Intake Manifold Gasket Not Included)	HS3777WB	1
	1979-1985		(Exhaust Pipe Gasket Not Included, Intake Manifold Gasket Not Included, Intake Valve Stem Seals Used With .552" Valve Guides Not Included)	HS5706	1
	1977-1978		(Exhaust Pipe Gasket Not Included, Intake Manifold Gasket Not Included, Exhaust Manifold Gasket Not Included), Use With Part Number MS15214	HS5706	1
	1975-1976		(Exhaust Pipe Gasket Not Included, Intake Manifold Gasket Not Included)	HS3741A	1
Full Set	1986-1987		(Head Bolts Not Included, Exhaust Pipe Gasket Not Included, Intake Manifold Gasket Not Included)	FS3777	1
	1985		(Exhaust Pipe Gasket Not Included, Intake Manifold Gasket Not Included, Intake Valve Stem Seals Used With .552" Valve Guides Not Included)	FS5706X	1
	1979-1984		(Exhaust Pipe Gasket Not Included, Intake Manifold Gasket Not Included, Intake Valve Stem Seals Used With .552" Valve Guides Not Included)	FS5706	1
	1977-1978		(Exhaust Pipe Gasket Not Included, Intake Manifold Gasket Not Included, Exhaust Manifold Gasket Not Included), Use With Part Number MS15214	FS5706	1
	1975-1976		(Exhaust Pipe Gasket Not Included, Intake Manifold Gasket Not Included)	FS3741A	1
Engine Kit Gasket Set	1985-1987		Rear Wheel Drive, (Intake Manifold Gasket Not Included, Optional 2 Piece Rubber Rear Main Seal Not Included), Use With Part Numbers MS15960, JV742R	95-3415VR	1
			1984	Aluminum Intake Manifold, Rear Wheel Drive, (Intake Manifold Gasket Not Included, Optional 2 Piece Rubber Rear Main Seal Not Included), Use With Part Numbers MS15960, JV742R	95-3420VR
	1982-1983		Cast Iron Intake Manifold, Rear Wheel Drive, (Intake Manifold Gasket Not Included, Optional 2 Piece Rubber Rear Main Seal Not Included), Use With Part Numbers MS15958, JV742R	95-3420VR	1
			Aluminum Intake Manifold, Thru 11/30/82, (Intake Manifold Gasket Not Included, Optional 2 Piece Rubber Rear Main Seal Not Included), Use With Part Numbers MS15960, JV742R	95-3402VR	1
			Cast Iron Intake Manifold, Thru 11/30/82, (Intake Manifold Gasket Not Included, Optional 2 Piece Rubber Rear Main Seal Not Included), Use With Part Numbers MS15958, JV742R	95-3402VR	1
			Aluminum Intake Manifold, From 12/1/82, (Intake Manifold Gasket Not Included, Optional 2 Piece Rubber Rear Main Seal Not Included), Use With Part Numbers MS15960, JV742R	95-3420VR	1
		Cast Iron Intake Manifold, From 12/1/82, (Intake Manifold Gasket Not Included, Optional 2 Piece Rubber Rear Main Seal Not Included), Use With Part Numbers MS15958, JV742R	95-3420VR	1	

General Motors Corp.

58 231 CID (3.8L) Carbureted Buick V6 Cyl, 3.800in./96.5mm (1975-1987) **58**
 (cont.) (cont.)

Part Year VIN Model/Application Part Number Qty.

ENGINE GASKETS (cont.)

Engine Kit Gasket Set (cont.)	1979-1981		Aluminum Intake Manifold, (Intake Manifold Gasket Not Included, Optional 2 Piece Rubber Rear Main Seal Not Included), Use With Part Numbers MS15960, JV742R	95-3402VR	1	
			Cast Iron Intake Manifold, (Intake Manifold Gasket Not Included, Optional 2 Piece Rubber Rear Main Seal Not Included), Use With Part Numbers MS15958, JV742R	95-3402VR	1	
	1977-1978		(Intake Manifold Gasket Not Included, Optional 2 Piece Rubber Rear Main Seal Not Included), Use With Part Numbers MS15948, JV742R	95-3402VR	1	
	1975-1976		(Intake Manifold Gasket Not Included, Optional 2 Piece Rubber Rear Main Seal Not Included), Use With Part Numbers MS15940, JV742R	95-3402VR	1	
Cylinder Head Gasket	1986-1987		<i>Nitroseal</i>	3777	2	
	1975-1985		<i>VR2000</i>	5819	2	
			Overbore	<i>VR2000</i>	5820	2
			Overbore	<i>Nitroseal</i>	5820SG	2
Cyl. Head Bolt Set	1986-1987			GS33237	2	
Valve Cover Set	1977-1987		<i>Cork Rubber</i>	VS39763	1	
			<i>High Temperature Cork Rubber</i>	VS39763H	1	
			<i>Victo-Tech</i>	VS39763R	1	
			<i>Tuff-Cork</i>	VS39763TC	1	
	1975-1976		<i>Cork Rubber</i>	VS39752	1	
Valve Stem Seal, Exh.	1984-1987			B45591	6	
Valve Stem Seal, Int.	1984-1987			B45484	6	
	1983		.552" Guide Outside Diameter	B45484	6	
			.605" Guide Outside Diameter	B45497	6	
	1975-1982			B45497	6	
Manifold Set, Exhaust	1979-1987			MS15327	1	
	1975-1978			MS15214	1	
Manifold Set, Intake	1979-1987	A	Aluminum Manifold	MS15960	1	
	1979-1984	A	Except Aluminum Manifold	MS15958	1	
	1979	2		MS15958	1	
	1978	2		MS15948	1	
	1977-1978	A		MS15948	1	
	1977	C		MS15948	1	
	1975-1976	C		MS15940	1	
Oil Pan Set	1985-1987		20 Bolt Pan <i>Victo-Tech</i>	OS32021	1	
	1975-1984		14 Bolt Pan <i>Cork Rubber</i>	OS30668	1	
			14 Bolt Pan <i>Tuff-Cork</i>	OS30668TC	1	
Rear Main Seal Set	1975-1987		<i>Rope Packing</i>	JV742	1	
			<i>Molded Rubber</i>	JV742R	1	
Timing Cover Set	1986-1987		(Requires Oil Pan Set, Contains Rope Packing)	JV1043	1	
			(Requires Oil Pan Set, Contains Superflex Seal)	JV1043SF	1	
	1975-1985		(Contains Rope Packing)	JV906	1	
			(Contains Superflex Seal)	JV1051SF	1	
Timing Cover Gasket	1975-1987			T27960	1	
Timing Cover Seal	1975-1987		(Superflex)	65025SF	1	

MISCELLANEOUS GASKETS

Air Cleaner Mount Gasket	1980-1987		2 Barrel Carburetor	G26906	1
	1975-1979		2 Barrel Carburetor	G26617	1
Carb. Mount Gasket	1979-1983		2 Barrel Carburetor	G26696	1
	1975-1978		2 Barrel Carburetor	G26712	1
Dist. Mounting Gasket	1975-1987			72215	1
E.G.R. Gasket	1975-1987		Valve	G26315	1
Exhaust Pipe Gasket	1977-1987	A	(Ring Type 'E'), Pipe To Manifold	F7394	1
	1978-1979	2	(Ring Type 'E'), Pipe To Manifold	F7394	1
	1975-1977	C	(Ring Type 'E'), Pipe To Manifold	F7394	1

58 231 CID (3.8L) Carbureted Buick V6 Cyl, 3.800in./96.5mm (1975-1987) **58**
(cont.) (cont.)

Part	Year	VIN	Model/Application	Part Number	Qty.
MISCELLANEOUS GASKETS (cont.)					
Fuel Pump Gasket	1986-1987	A		D30720	1
	1975-1985			D27094	1
				Tuff-Cork	D27094TC
Oil Pan Drain Plug Gst.	1975-1987			2051	1
Oil Pump Cover Gasket	1982-1987			B45577	1
	1979-1981			B45578	1
	1978		2nd Design	B45578	1
			1st Design	B45579	1
	1975-1977			B45579	1
Water Outlet Gasket	1977-1987	A		C26515	1
	1978-1979	2		C26515	1
	1975-1977	C		C26515	1
Water Pump Mount Gasket	1977-1987	A		K27571	1
	1978-1979	2		K27571	1
	1975-1977	C		K27571	1

59 231 CID (3.8L) Fuel Injected Buick V6 Cyl, 3.800in./96.5mm (1984-2003) **59**

Part	Year	VIN	Model/Application	Part Number	Qty.
ENGINE GASKETS					
Head Set	1997-2003	K	2nd Design, Locating Pins, (Head Bolts Not Included, Exhaust Pipe Gasket Not Included, Plenum Chamber Gasket Not Included, Exhaust Manifold Gasket Not Included)	HS5912A	1
	1995-1997	K	1st Design, Except Locating Pins, (Head Bolts Not Included, Exhaust Pipe Gasket Not Included, Plenum Chamber Gasket Not Included, Exhaust Manifold Gasket Not Included)	HS5912	1
	1995	L	(Head Bolts Not Included, Exhaust Pipe Gasket Not Included, Plenum Chamber Gasket Not Included)	HS5828	1
	1990-1994	L	(Head Bolts Not Included, Exhaust Pipe Gasket Not Included, Plenum Chamber Gasket Not Included), Use With Part Number MS14638	HS5768W	1
		L	(Contains Head Bolts, Exhaust Pipe Gasket Not Included, Plenum Chamber Gasket Not Included), Use With Part Number MS14638	HS5768WB1	1
	1991	C	(Head Bolts Not Included, Exhaust Pipe Gasket Not Included)	HS5768	1
		C	(Contains Head Bolts, Exhaust Pipe Gasket Not Included)	HS5768WB	1
	1989-1990	C	88 Royale, (Contains Head Bolts, Exhaust Pipe Gasket Not Included)	HS5723WB	1
	1988-1990	C	(Head Bolts Not Included, Exhaust Pipe Gasket Not Included)	HS5723	1
		C	Electra, Ninety Eight, (Contains Head Bolts, Exhaust Pipe Gasket Not Included)	HS5723WB1	1
		C	Bonneville, Le Sabre, Reatta, Riviera, Toronado, (Contains Head Bolts, Exhaust Pipe Gasket Not Included)	HS5723WB	1
	1988	C	Delta 88 Royale, (Contains Head Bolts, Exhaust Pipe Gasket Not Included)	HS5723WB	1
	1986-1988	3	(Head Bolts Not Included, Exhaust Pipe Gasket Not Included, Intake Manifold Gasket Not Included)	HS3777W	1
		3	(Contains Head Bolts, Exhaust Pipe Gasket Not Included, Intake Manifold Gasket Not Included)	HS3777WB2	1
	1986	B	(Head Bolts Not Included, Exhaust Pipe Gasket Not Included, Intake Manifold Gasket Not Included)	HS3777W	1
B		(Contains Head Bolts, Exhaust Pipe Gasket Not Included, Intake Manifold Gasket Not Included)	HS3777WB2	1	

General Motors Corp.

59 231 CID (3.8L) Fuel Injected Buick V6 Cyl, 3.800in./96.5mm (1984-2003) **59**
 (cont.) (cont.)

Part	Year	VIN	Model/Application	Part Number	Qty.	
ENGINE GASKETS (cont.)						
Head Set (cont.)	1984-1985	3	(Head Bolts Not Included, Exhaust Pipe Gasket Not Included, Intake Manifold Gasket Not Included, Intake Valve Stem Seals Used With .552" Valve Guides Not Included)	HS5706W	1	
		3	(Contains Head Bolts, Exhaust Pipe Gasket Not Included, Intake Manifold Gasket Not Included, Intake Valve Stem Seals Used With .552" Valve Guides Not Included)	HS5706WB	1	
Lower Set	1995-2003	K	(Oil Pan Gasket Not Included, Requires Head Set To Make Full Set)	CS5912	1	
	1995	L	(Oil Pan Gasket Not Included, Requires Head Set To Make Full Set)	CS5828	1	
Full Set	1990-1994	L	(Head Bolts Not Included, Exhaust Pipe Gasket Not Included)	FS5768W	1	
	1991	C	(Head Bolts Not Included, Exhaust Pipe Gasket Not Included)	FS5768	1	
	1988-1990	C	(Head Bolts Not Included, Exhaust Pipe Gasket Not Included)	FS5723	1	
	1986-1988	3	(Head Bolts Not Included, Exhaust Pipe Gasket Not Included, Intake Manifold Gasket Not Included)	FS3777W	1	
	1986	B	(Head Bolts Not Included, Exhaust Pipe Gasket Not Included, Intake Manifold Gasket Not Included)	FS3777W	1	
	1984-1985	3	(Head Bolts Not Included, Exhaust Pipe Gasket Not Included, Intake Manifold Gasket Not Included, Intake Valve Stem Seals Used With .552" Valve Guides Not Included)	FS5706W	1	
	Engine Kit Gasket Set	1995-1997	K	1st Design: Intake Manifold Gasket Without Locating Pins, Front Wheel Drive, (Oil Pan Gasket Not Included, Plenum Chamber Gasket Not Included), Use With Part Numbers MS16206, OS32147	95-3500VR	1
K			1st Design: Intake Manifold Gasket Without Locating Pins, Rear Wheel Drive, (Oil Pan Gasket Not Included, Plenum Chamber Gasket Not Included), Use With Part Numbers MS16335, OS32147	95-3501VR	1	
1990-1994		L		95-3164VR	1	
1991		C		95-3165VR	1	
1988-1990		C	(Optional 2 Piece Rubber Rear Main Seal Not Included), Use With Part Number JV742R	95-3166VR	1	
1986-1988		3	Front Wheel Drive, (Intake Manifold Gasket Not Included, Optional 2 Piece Rubber Rear Main Seal Not Included), Use With Part Numbers JV742R, MS15958	95-3411VR	1	
1986		B	Front Wheel Drive, (Intake Manifold Gasket Not Included, Optional 2 Piece Rubber Rear Main Seal Not Included), Use With Part Numbers JV742R, MS15958	95-3411VR	1	
1985		3	14 Bolt Oil Pan, Front Wheel Drive, (Intake Manifold Gasket Not Included, Optional 2 Piece Rubber Rear Main Seal Not Included), Use With Part Numbers MS15958, JV742R	95-3421VR	1	
		3	20 Bolt Oil Pan, Front Wheel Drive, (Intake Manifold Gasket Not Included, Optional 2 Piece Rubber Rear Main Seal Not Included), Use With Part Numbers MS15958, JV742R	95-3422VR	1	
1984		3	Front Wheel Drive, (Intake Manifold Gasket Not Included, Optional 2 Piece Rubber Rear Main Seal Not Included), Use With Part Numbers MS15958, JV742R	95-3421VR	1	
Cylinder Head Gasket		1995-2003	K	Right Head	<i>Nitroseal</i> 5912	1
			K	Left Head	<i>Nitroseal</i> 5913	1
	1995	L	Right Head	<i>Nitroseal</i> 5828	1	
		L	Left Head	<i>Nitroseal</i> 5829	1	
	1990-1994	L		<i>Nitroseal</i> 5768	2	
	1991	C		<i>Nitroseal</i> 5768	2	
	1988-1990	C		<i>Nitroseal</i> 5723	2	
	1986-1988	3		<i>Nitroseal</i> 3777	2	
	1986	B		<i>Nitroseal</i> 3777	2	
	1984-1985	3		<i>VR2000</i> 5819	2	
3		Overbore	<i>VR2000</i> 5820	2		
3		Overbore	<i>Nitroseal</i> 5820SG	2		
Cyl. Head Bolt Set	1995-2003	K		GS33363	2	

PASSENGER CAR

Part	Year	VIN	Model/Application	Part Number	Qty.
ENGINE GASKETS (cont.)					
Cyl. Head Bolt Set (cont.)	1990-1995	L		GS33233	2
	1991	C	88 Royale, Bonneville, Le Sabre	GS33233	2
	1989-1990	C	88 Royale	GS33234	2
	1988-1990	C	Electra, Ninety Eight	GS33233	2
		C	Bonneville, Le Sabre, Reatta, Riviera, Toronado	GS33234	2
	1988	C	Delta 88 Royale	GS33234	2
	1985-1988	3		GS33237	2
1986	B		GS33237	2	
Valve Cover Set	1995-2003	K	<i>Victo-Tech</i>	VS50052	1
		K	(Single Valve Cover) <i>Victo-Tech</i>	VS50123	2
	1990-1995	L	<i>Victo-Tech</i>	VS50052	1
		L	(Single Valve Cover) <i>Victo-Tech</i>	VS50123	2
	1988-1991	C	<i>Victo-Tech</i>	VS50052	1
		C	(Single Valve Cover) <i>Victo-Tech</i>	VS50123	2
	1986-1988	3	<i>Victo-Tech</i>	VS50017	1
		3	(Single Valve Cover) <i>Victo-Tech</i>	VS50122	2
	1986	B	<i>Victo-Tech</i>	VS50017	1
		B	(Single Valve Cover) <i>Victo-Tech</i>	VS50122	2
	1984-1985	3	<i>Cork Rubber</i>	VS39763	1
3		<i>Victo-Tech</i>	VS39763R	1	
Valve Stem Seal, Exh.	1995-2003			B45911	6
	1984-1994			B45591	6
Valve Stem Seal, Int.	1998-2003			B45910	6
	1995-1997			B45840	6
	1984-1994			B45484	6
Manifold Set, Exhaust	1997-2003	K	Front Wheel Drive	MS16108	1
	2000-2002	K	Camaro, Firebird	MS16364	1
	1995-1999	K	Camaro, Firebird	MS16099	1
	1990-1995	L		MS15569	1
	1988-1991	C		MS15569	1
	1986-1988	3		MS15519	1
	1986	B		MS15519	1
	1984-1985	3		MS15327	1
Manifold Set, Intake	1999-2003	K	(Plenum Chamber Gasket Not Included)	MS16203A	1
	1998	K	(Plenum Chamber Gasket Not Included)	MS16191A	1
	1997	K	1st Design, Except Locating Pins, (Plenum Chamber Gasket Not Included)	MS16191	1
		K	2nd Design, Locating Pins, (Plenum Chamber Gasket Not Included)	MS16191A	1
	1995-1996	K	(Plenum Chamber Gasket Not Included)	MS16191	1
	1993-1995	L	(Plenum Chamber Gasket Not Included), Use With Part Number MS14638	<i>Nitroseal</i> MS15634	1
	1990-1992	L	<i>Nitroseal</i>	MS15634	1
	1988-1991	C	<i>Nitroseal</i>	MS15624	1
	1984-1988	3		MS15958	1
	1986	B		MS15958	1
Plenum Chamber Gasket	1995-2003	K	Front Wheel Drive	MS16206	1
	1995-2002		Camaro, Firebird	MS16335	1
	1993-1995	L		MS14638	1
Oil Pan Set	2000-2003		Front Wheel Drive <i>Victo-Tech</i>	OS32225	1
	1995-2002		Camaro, Firebird <i>Victo-Tech</i>	OS32147	1
	1995-1999		<i>Victo-Tech</i>	OS32147	1
	1986-1994		<i>Victo-Tech</i>	OS32022	1
	1985	3	14 Bolt Pan <i>Cork Rubber</i>	OS30589	1
			20 Bolt Pan <i>Victo-Tech</i>	OS32022	1
1984-1985	3	14 Bolt Pan, Front Wheel Drive <i>Cork Rubber</i>	OS30589	1	

General Motors Corp.

59 231 CID (3.8L) Fuel Injected Buick V6 Cyl, 3.800in./96.5mm (1984-2003) **59**
 (cont.) (cont.)

Part Year VIN Model/Application Part Number Qty.

ENGINE GASKETS (cont.)

Rear Main Seal Set	1995-2003	K		JV1632	1	
	1990-1995	L		JV599	1	
	1984-1990			Rope Packing	JV742	1
				Molded Rubber	JV742R	1
Crank Repair Sleeve	1990-1995		Rear Nickel Plated Formed Steel, .013" Thickness	A353	1	
Timing Cover Set	1995-2003	K		JV1207	1	
	1990-1995	L		JV1114	1	
	1988-1991	C		JV1114	1	
	1986-1988	3		JV1046	1	
	1986	B		JV1046	1	
	1984-1985	3		(Contains Rope Packing)	JV906	1
3			(Contains Superflex Seal)	JV1051SF	1	
Timing Cover Gasket	1984			T27960	1	
Timing Cover Seal	1986-2003			48069	1	
	1984-1985		(Superflex)	65025SF	1	
Harmonic Balancer Repair Sleeve	1995-2003	K		Nickel Plated Formed Steel, .013" Thickness	A237	1
	1990-1995	L		Nickel Plated Formed Steel, .013" Thickness	A237	1
	1988-1991	C		Nickel Plated Formed Steel, .013" Thickness	A237	1

MISCELLANEOUS GASKETS

E.G.R. Gasket	1995-1999	K		G31276	1	
	1993-1995	L		G31264	1	
	1988-1991	C	Valve		G31099	1
		C	Adapter To Intake Manifold		G31367	1
			EGR To Adaptor		G31426	1
	1984-1988	3		G26315	1	
	1986	B		G26315	1	
Exhaust Pipe Gasket	2000-2003	K	Impala, (Flange Type), Pipe To Manifold	F31593	1	
		K	Impala, (Ring Type 'F'), Crossover Pipe	F31599	1	
	1998-2003	K	Monte Carlo, (Flange Type), Pipe To Manifold	F31593	1	
		K	Monte Carlo, (Ring Type 'F'), Crossover Pipe	F31599	1	
	1997-2003	K	Bonneville, Grand Prix, Le Sabre, Park Avenue, Regal, (Flange Type), Pipe To Manifold	F31593	1	
		K	Grand Prix, (Ring Type 'F'), Crossover Pipe	F31599	1	
	1996-2003	K	Le Sabre, Regal, (Ring Type 'F'), Crossover Pipe	F31599	1	
	1995-2003	K	Bonneville, Park Avenue, (Ring Type 'F'), Crossover Pipe	F31599	1	
	1995-2002	K	Camaro, Firebird, (Ring Type 'F'), Pipe To Manifold	F31595	2	
			Camaro, Firebird, (Ring Type 'F')	F31595	2	
	1998-1999	K	Intrigue, Lumina, (Flange Type), Pipe To Manifold	F31593	1	
		K	Intrigue, Lumina, (Ring Type 'F'), Crossover Pipe	F31599	1	
	1997-1999	K	88 Royale, LSS, (Flange Type), Pipe To Manifold	F31593	1	
	1996-1999	K	LSS, (Ring Type 'F'), Crossover Pipe	F31599	1	
	1995-1999	K	88 Royale, (Ring Type 'F'), Crossover Pipe	F31599	1	
	1997-1998	K	Regency, (Flange Type), Pipe To Manifold	F31593	1	
		K	Regency, (Ring Type 'F'), Crossover Pipe	F31599	1	
	1997	K	Riviera, (Flange Type), Pipe To Manifold	F31593	1	
		K	Grand Prix, Regency, (Ring Type 'F'), Pipe To Manifold	F31594	1	
	1996-1997	K	LSS, Le Sabre, Regal, (Ring Type 'F'), Pipe To Manifold	F31594	1	
	1995-1997	K	88 Royale, Bonneville, Park Avenue, Riviera, (Ring Type 'F'), Pipe To Manifold	F31594	1	
		K	Riviera, (Ring Type 'F'), Crossover Pipe	F31599	1	
1995-1996	K	Lumina, Ninety Eight, (Ring Type 'F'), Pipe To Manifold	F31594	1		
	K	Lumina, Ninety Eight, (Ring Type 'F'), Crossover Pipe	F31599	1		
1993-1995	L	(Ring Type 'F'), Crossover Pipe	F7515	1		
1990-1995	L	(Ring Type 'F'), Pipe To Manifold	F7523	1		
1990-1992	L	(Ring Type 'F'), Crossover Pipe	F7514	1		
1988-1991	C	(Ring Type 'F'), Pipe To Manifold	F7523	1		

59 231 CID (3.8L) Fuel Injected Buick V6 Cyl, 3.800in./96.5mm (1984-2003) **59**
(cont.) (cont.)

Part	Year	VIN	Model/Application	Part Number	Qty.
MISCELLANEOUS GASKETS (cont.)					
Exhaust Pipe Gasket (cont.)	1986-1988	3	(Ring Type 'F'), Pipe To Manifold	F7210	1
	1986	B	(Ring Type 'F'), Pipe To Manifold	F7210	1
	1984-1985	3	(Ring Type 'E'), Pipe To Manifold	F7394	1
Injector Nozzle O-Ring	1984-1999			GS33276	3
Manifold By-Pass Gasket	1994	L		C31272	1
Oil Pan Drain Plug Gst.	1995-2003			B45828	1
	1984-1994			2051	1
Oil Pump Cover Gasket	1984-1985			B45577	1
Thermostat O-Ring	1990-2003		<i>Victo-Tech</i>	C31227	1
Throttle Body Gasket	2000-2003	K	Impala	G31596	1
	1998-2003	K	Monte Carlo	G31596	1
	1997-2003	K	Grand Prix	G31596	1
	1996-2003	K	Le Sabre, Regal	G31596	1
	1995-2003	K	Bonneville, Park Avenue	G31596	1
	1999-2002	K	Camaro, Firebird	G31592	1
	1998-1999	K	Intrigue, Lumina	G31596	1
	1996-1999	K	LSS	G31596	1
	1995-1999	K	88 Royale	G31596	1
	1997-1998	K	Regency	G31596	1
	1995-1998	K	Camaro, Firebird	G31275	1
	1995-1997	K	Riviera	G31596	1
	1995-1996	K	Lumina, Ninety Eight	G31596	1
	1993-1995	L		G31271	1
	1990-1992	L		G31270	1
	1988-1991	C		G31369	1
	1984-1988	3		G30951	1
	1986	B		G30951	1
	Valve Cover Grommet	1995-2003	K		GS33304
1990-1995		L		GS33304	1
1988-1991		C		GS33304	1
1986-1988		3		GS33334	1
1986		B		GS33334	1
Water By-Pass Gasket	1995-2003	K		C31274	1
Water Outlet Gasket	1990-1995	L		C31271	1
	1988-1991	C	(O-Ring Type)	72222	1
	1986-1988	3	(O-Ring Type)	72222	1
	1986	B	(O-Ring Type)	72222	1
	1984-1985	3		C26515	1
Water Pump Mount Gasket	1995-2003	K		K30793	1
	1990-1995	L		K30793	1
	1988-1991	C		K30793	1
	1986-1988	3		K30793	1
	1986	B		K30793	1
	1984-1985	3		K27444	1

60 231 CID (3.8L) Supercharged Buick V6 Cyl, 3.800in./96.5mm (1991-2003) **60**

Part	Year	VIN	Model/Application	Part Number	Qty.
ENGINE GASKETS					
Head Set	1998-2003		(Head Bolts Not Included)	HS5934A	1
	1997		1st Design Intake Manifold End Seals, (Head Bolts Not Included)	HS5934	1

PASSENGER CAR

General Motors Corp.

60 231 CID (3.8L) Supercharged Buick V6 Cyl, 3.800in./96.5mm (1991-2003) **60**
 (cont.) (cont.)

Part Year VIN Model/Application Part Number Qty.

ENGINE GASKETS (cont.)

Head Set (cont.)	1997		2nd Design Intake Manifold End Seals, (Head Bolts Not Included, Intake Manifold Gasket Not Included)	HS5934	1
	1996		(Head Bolts Not Included)	HS5934	1
	1991-1995		(Head Bolts Not Included)	HS5853	1
Lower Set	1996-2003		(Oil Pan Gasket Not Included, Requires Head Set To Make Full Set)	CS5912	1
	1991-1995		(Oil Pan Gasket Not Included, Requires Head Set To Make Full Set)	CS5853	1
Cylinder Head Gasket	1996-2003		Right Head <i>Nitroseal</i>	5934	1
			Left Head <i>Nitroseal</i>	5935	1
	1991-1995		Right Head <i>Nitroseal</i>	5853	1
			Left Head <i>Nitroseal</i>	5854	1
Cyl. Head Bolt Set	1996-2003			GS33363	2
	1991-1995			GS33233	2
Valve Cover Set	1996-2003		(Contains Grommets)	VS50332	1
	1991-1995		<i>Victo-Tech</i>	VS50052	1
			(Single Valve Cover) <i>Victo-Tech</i>	VS50123	2
Valve Stem Seal, Exh.	1996-2003			B45911	6
	1991-1995			B45591	6
Valve Stem Seal, Int.	1998-2003			B45910	6
	1996-1997			B45840	6
	1991-1995			B45484	6
Manifold Set, Exhaust	1997-2003			MS16108	1
	1991-1996			MS15569	1
Manifold Set, Intake	1998-2003		(Plenum Chamber Gasket Not Included)	MS16203A	1
	1997		1st Design, Except Locating Pins, (Plenum Chamber Gasket Not Included)	MS16203	1
			2nd Design, Locating Pins, (Plenum Chamber Gasket Not Included)	MS16203A	1
	1996		(Plenum Chamber Gasket Not Included)	MS16203	1
1991-1995			MS16202	1	
Plenum Chamber Gasket	1996-2003			MS16355	1
	1991-1995			MS16354	1
Oil Pan Set	2000-2003		<i>Victo-Tech</i>	OS32225	1
	1995-1999		<i>Victo-Tech</i>	OS32147	1
	1991-1994		<i>Victo-Tech</i>	OS32022	1
Rear Main Seal Set	1995-2003			JV1632	1
	1991-1994			JV599	1
Crank Repair Sleeve	1991-1995	Rear	<i>Nickel Plated Formed Steel, .013" Thickness</i>	A353	1
Timing Cover Set	1996-2003			JV1207	1
	1991-1995			JV1114	1
Timing Cover Seal	1991-2002			48069	1
Harmonic Balancer Repair Sleeve	1991-2003		<i>Nickel Plated Formed Steel, .013" Thickness</i>	A237	1

MISCELLANEOUS GASKETS

E.G.R. Gasket	1996-2003			G31276	1
	1994-1995			G31266	1
	1991-1993			G31264	1
Exhaust Pipe Gasket	1997-2003		(Flange Type), Pipe To Manifold	F31593	1
	1996-2003		(Ring Type 'F'), Crossover Pipe	F31599	1
	1996		(Ring Type 'F'), Pipe To Manifold	F31594	1
	1991-1995		(Ring Type 'F'), Crossover Pipe <i>3.000" Outside Diameter</i>	F7515	1
			(Ring Type 'F'), Pipe To Manifold	F7523	1
	1991-1992		(Ring Type 'F'), Crossover Pipe <i>3.226" Outside Diameter</i>	F7514	1
Injector Nozzle O-Ring	1991-1999			GS33276	3
Oil Pan Drain Plug Gst.	1995-2003			B45828	1

60 231 CID (3.8L) Supercharged Buick V6 Cyl, 3.800in./96.5mm (1991-2003) **60**
 (cont.) (cont.)

Part	Year	VIN	Model/Application	Part Number	Qty.
MISCELLANEOUS GASKETS (cont.)					
Oil Pan Drain Plug Gst. (cont.)	1991-1994			2051	1
Thermostat O-Ring	1991-2003		Victo-Tech	C31227	1
Throttle Body Gasket	1994-1995			G31598	1
	1992-1993			G31270	1
Valve Cover Grommet	1991-2003			GS33304	1
Water By-Pass Gasket	2003			C31274	1
Water Outlet Gasket	1997			C31271	1
	1991-1995			C31271	1
Water Pump Mount Gasket	1991-2003			K30793	1

61 231 CID (3.8L) Turbo Buick V6 Cyl, 3.800in./96.5mm (1978-1989) **61**

Part	Year	VIN	Model/Application	Part Number	Qty.	
ENGINE GASKETS						
Head Set	1986-1989	7	(Head Bolts Not Included, Exhaust Pipe Gasket Not Included, Intake Manifold Gasket Not Included)	HS3797	1	
	1986-1987	7	(Contains Head Bolts, Exhaust Pipe Gasket Not Included, Intake Manifold Gasket Not Included)	HS3797WB	1	
	1984-1985	9	(Exhaust Pipe Gasket Not Included, Intake Manifold Gasket Not Included, Intake Valve Stem Seals Used With .552" Valve Guides Not Included)	HS5706	1	
	1978-1983		(Exhaust Pipe Gasket Not Included, Intake Manifold Gasket Not Included, Intake Valve Stem Seals Used With .552" Valve Guides Not Included)	HS5706	1	
Full Set	1986-1989	7	(Head Bolts Not Included, Exhaust Pipe Gasket Not Included, Intake Manifold Gasket Not Included)	FS3797	1	
	1984-1985	9	(Exhaust Pipe Gasket Not Included, Intake Manifold Gasket Not Included, Intake Valve Stem Seals Used With .552" Valve Guides Not Included)	FS5706X	1	
	1978-1983		(Exhaust Pipe Gasket Not Included, Intake Manifold Gasket Not Included, Intake Valve Stem Seals Used With .552" Valve Guides Not Included)	FS5706	1	
Engine Kit Gasket Set	1986-1989	7	(Intake Manifold Gasket Not Included, Optional 2 Piece Rubber Rear Main Seal Not Included), Use With Part Numbers MS15958, JV742R	95-3169VR	1	
	1985	9	(Intake Manifold Gasket Not Included, Optional 2 Piece Rubber Rear Main Seal Not Included), Use With Part Numbers MS15958, JV742R	95-3415VR	1	
	1984	9	(Intake Manifold Gasket Not Included, Optional 2 Piece Rubber Rear Main Seal Not Included), Use With Part Numbers MS15958, JV742R	95-3420VR	1	
	1982-1983			Aluminum Intake Manifold, Thru 11/30/82, (Intake Manifold Gasket Not Included, Optional 2 Piece Rubber Rear Main Seal Not Included), Use With Part Numbers MS15960, JV742R	95-3402VR	1
				Cast Iron Intake Manifold, Thru 11/30/82, (Intake Manifold Gasket Not Included, Optional 2 Piece Rubber Rear Main Seal Not Included), Use With Part Numbers MS15958, JV742R	95-3402VR	1
				Aluminum Intake Manifold, From 12/1/82, (Intake Manifold Gasket Not Included, Optional 2 Piece Rubber Rear Main Seal Not Included), Use With Part Numbers MS15960, JV742R	95-3420VR	1
				Cast Iron Intake Manifold, From 12/1/82, (Intake Manifold Gasket Not Included, Optional 2 Piece Rubber Rear Main Seal Not Included), Use With Part Numbers MS15958, JV742R	95-3420VR	1
1980-1981		(Intake Manifold Gasket Not Included, Optional 2 Piece Rubber Rear Main Seal Not Included), Use With Part Numbers MS15960, JV742R	95-3402VR	1		

PASSENGER CAR

General Motors Corp.

61 231 CID (3.8L) Turbo Buick V6 Cyl, 3.800in./96.5mm (1978-1989) **61**
 (cont.) (cont.)

Part Year VIN Model/Application Part Number Qty.

ENGINE GASKETS (cont.)

Engine Kit Gasket Set (cont.)	1979		(Intake Manifold Gasket Not Included, Optional 2 Piece Rubber Rear Main Seal Not Included), Use With Part Numbers MS15958, JV742R	95-3402VR	1	
	1978		(Intake Manifold Gasket Not Included, Optional 2 Piece Rubber Rear Main Seal Not Included), Use With Part Numbers MS15948, JV742R	95-3402VR	1	
Cylinder Head Gasket	1986-1989		<i>Nitroseal</i>	3797	2	
	1978-1985		<i>VR2000</i>	5819	2	
			Overbore	<i>VR2000</i>	5820	2
			Overbore	<i>Nitroseal</i>	5820SG	2
Cyl. Head Bolt Set	1986-1989	7		GS33237	2	
Valve Cover Set	1989		<i>Victo-Tech</i>	VS50017	1	
			(Single Valve Cover)	<i>Victo-Tech</i>	VS50122	2
	1978-1988			<i>Cork Rubber</i>	VS39763	1
				<i>High Temperature Cork Rubber</i>	VS39763H	1
				<i>Victo-Tech</i>	VS39763R	1
				<i>Tuff-Cork</i>	VS39763TC	1
Valve Stem Seal, Exh.	1989			B45591	6	
	1984-1987			B45591	6	
Valve Stem Seal, Int.	1984-1989			B45484	6	
	1983		.552" Guide Outside Diameter	B45484	6	
			.605" Guide Outside Diameter	B45497	6	
	1978-1982			B45497	6	
Manifold Set, Exhaust	1979-1989			MS15327	1	
	1978			MS15214	1	
Manifold Set, Intake	1979-1989			MS15958	1	
	1978			MS15948	1	
Oil Pan Set	1984-1989		<i>Victo-Tech</i>	OS32021	1	
	1978-1983		<i>Cork Rubber</i>	OS30668	1	
				<i>Tuff-Cork</i>	OS30668TC	1
Rear Main Seal Set	1978-1989		<i>Rope Packing</i>	JV742	1	
				<i>Molded Rubber</i>	JV742R	1
Timing Cover Set	1986-1989		(Contains Rope Packing)	JV1043	1	
			(Contains Superflex Seal)	JV1043SF	1	
	1978-1985		(Contains Rope Packing)	JV906	1	
			(Contains Superflex Seal)	JV1051SF	1	
Timing Cover Gasket	1978-1984			T27960	1	
Timing Cover Seal	1978-1989		(Superflex)	65025SF	1	

MISCELLANEOUS GASKETS

Air Cleaner Mount Gasket	1978-1982		4 Barrel Carburetor	G27098	1
Carb. Mount Gasket	1983		4 Barrel Carburetor	G26652	1
	1981-1983		Carburetor Plenum	G26652	1
	1978-1982		4 Barrel Carburetor	G26652	1
	1978-1979		Carburetor Plenum	G26652	1
Dist. Mounting Gasket	1978-1989			72215	1
E.G.R. Gasket	1986-1989	7	Valve	G26315	1
	1982		Valve	G26315	1
	1978-1981			G26900	1
	1978-1979		Valve	G26315	1
Exhaust Pipe Gasket	1986-1989	7	(Ring Type 'E'), Pipe To Manifold	F7207	1
	1984	9	(Ring Type 'E'), Pipe To Manifold	F7394	1
	1983	8	(Ring Type 'F'), Front Pipe To Intermediate Pipe	F7210	1
		8	(Ring Type 'E'), Pipe To Manifold	F7394	1
	1978-1982	3	(Ring Type 'E')	F7207	1
			(Ring Type 'E')	F7207	1
		3	(Ring Type 'E'), Pipe To Manifold	F7394	1

61 231 CID (3.8L) Turbo Buick V6 Cyl, 3.800in./96.5mm (1978-1989) **61**
(cont.) (cont.)

Part	Year	VIN	Model/Application	Part Number	Qty.
MISCELLANEOUS GASKETS (cont.)					
Exhaust Pipe Gasket (cont.)	1978-1982		(Ring Type 'E'), Pipe To Manifold	F7394	1
	1978	G	(Ring Type 'E'), Pipe To Manifold	F7394	1
Fuel Pump Gasket	1978-1989			D27094	1
				Tuff-Cork D27094TC	1
Oil Pan Drain Plug Gst.	1978-1989			2051	1
Oil Pump Cover Gasket	1982-1989			B45577	1
	1979-1981			B45578	1
	1978		2nd Design	B45578	1
			1st Design	B45579	1
Throttle Body Gasket	1986-1989	7		G31396	1
	1984-1985	9		G30951	1
Turbo Gasket	1978-1983		Turbo Compressor To Manifold	G26901	1
			Drain Connector	G26902	1
			Regal, EGR Chamber To Plenum And Manifold	G26908	1
			Riviera, Plenum To Turbo	G26933	1
			Inlet To Exhaust Pipe	G26951	1
	1978-1982		EGR Chamber To Plenum And Manifold	G26908	1
Turbo Mounting Set	1989	7		GS33283	1
	1986-1987	7		GS33283	1
	1978-1985			GS33073	1
Valve Cover Grommet	1989			GS33334	1
Water Outlet Gasket	1986-1989	7	(O-Ring Type)	72222	1
	1984-1985	9		C26515	1
	1982-1983	8		C26515	1
	1978-1982			C26515	1
		3		C26515	1
	1978	G		C26515	1
Water Pump Mount Gasket	1986-1989	7		K27571	1
	1984-1985	9		K27571	1
	1982-1983	8		K27571	1
	1978-1982	3		K27571	1
				K27571	1
	1978	G		K27571	1

62 235 CID (3.9L) Chevrolet 6 Cyl, 3.563in./90.5mm (1950-1962) **62**

Part	Year	VIN	Model/Application	Part Number	Qty.
ENGINE GASKETS					
Head Set	1954-1962			HS1090KX	1
	1953			HS1090K	1
	1950-1952		Manual Transmission	HS1050K	1
			Powerglide Transmission	HS1065K	1
Full Set	1955-1962			FS1090KY	1
	1954			FS1090KX	1
	1953			FS1090K	1
	1950-1952		Manual Transmission	FS1050KX	1
				95-3010VR	1
Engine Kit Gasket Set	1953-1962				
Cylinder Head Gasket	1953-1962		VR2000	1090K	1
	1950-1952		Manual Transmission	1050K	1
			Powerglide Transmission	VR2000 1065K	1
Valve Cover Set	1954-1962		Cork Rubber	VS39687	1
	1950-1953		Cork Rubber	VS39725	1
Valve Stem Seal, Exh.	1950-1962		(O-Ring Type)	B45229	6
Valve Stem Seal, Int.	1950-1962		(O-Ring Type)	B45229	6

General Motors Corp.

62 (cont.)	235 CID (3.9L) Chevrolet 6 Cyl, 3.563in./90.5mm (1950-1962)				62 (cont.)
----------------------	--	--	--	--	----------------------

<i>Part</i>	<i>Year</i>	<i>VIN</i>	<i>Model/Application</i>	<i>Part Number</i>	<i>Qty.</i>
ENGINE GASKETS (cont.)					
Manifold Set, Int. & Exh.	1950-1962			MS12185X	1
Oil Pan Set	1955-1962		Cork Rubber	OS31116	1
	1950-1954		Cork Rubber	OS30902	1
Rear Main Seal Set	1953-1962		Molded Rubber	JV737	1
	1950-1962		Rope Packing	JV650	1
Timing Cover Set	1950-1962			JV754	1
Timing Cover Seal	1950-1962		3/8" Wide	49328	1
		(Lip Relocator Type)	1/2" Wide	65022	1
Harmonic Balancer Repair Sleeve	1950-1962		Use With Part Number A504 Nickel Plated Formed Steel, .013" Thickness	A228	1

MISCELLANEOUS GASKETS					
Air Cleaner Mount Gasket	1950-1962		1 Barrel Carburetor	G25936	1
Carb. Mount Gasket	1961-1962		1 Barrel Carburetor	G17969	1
	1950-1957		1 Barrel Carburetor	G17969	1
Dist. Mounting Gasket	1950-1962			B26466	1
Exhaust Pipe Gasket	1950-1962		(Ring Type 'C')	F17250	1
			(Ring Type 'B')	Sintered Metal F17250S	1
Fuel Pump Bowl Gasket	1950-1955			D34545	1
Fuel Pump Gasket	1950-1962			D27094	1
				Tuff-Cork D27094TC	1
Fuel Pump Plate Gasket	1955-1962			D25932	1
				Tuff-Cork D25932TC	1
Manifold Seal, Intake	1950-1962		Intake To Exhaust	B17897	1
Oil Pan Drain Plug Gst.	1950-1962			2051	1
Push Rod Cover Seal	1950-1962			H34510	6
Push Rod Cover Set	1950-1962			Cork Rubber PS39685	1
	1950-1952		Manual Transmission	Cork Rubber PS39840	1
Therm. Housing Gasket	1950-1962			C24529	1
Water Outlet Gasket	1950-1962		(Universal Type)	C24109	1
				C25930	1
Water Pump Mount Gasket	1955-1962			K27069	1
	1950-1954			K25739	1

63	235 CID (3.9L) Corvette Chevrolet 6 Cyl, 3.563in./90.5mm (1953-1955)				63
-----------	---	--	--	--	-----------

<i>Part</i>	<i>Year</i>	<i>VIN</i>	<i>Model/Application</i>	<i>Part Number</i>	<i>Qty.</i>
ENGINE GASKETS					
Head Set	1954-1955			HS1090KX	1
	1953			HS1090K	1
Full Set	1955			FS1090KY	1
	1954			FS1090KX	1
	1953			FS1090K	1
Engine Kit Gasket Set	1953-1955			95-3010VR	1
Cylinder Head Gasket	1953-1955		VR2000	1090K	1
Valve Cover Set	1954-1955		Cork Rubber	VS39687	1
	1953		Cork Rubber	VS39725	1
Valve Stem Seal, Exh.	1953-1955		(O-Ring Type)	B45229	6
Valve Stem Seal, Int.	1953-1955		(O-Ring Type)	B45229	6
Manifold Set, Int. & Exh.	1953-1955			MS12185X	1
Oil Pan Set	1955			Cork Rubber OS31116	1

63 235 CID (3.9L) Corvette Chevrolet 6 Cyl, 3.563in./90.5mm (1953-1955) **63**
(cont.) (cont.)

Part Year VIN Model/Application Part Number Qty.

ENGINE GASKETS (cont.)

Oil Pan Set (cont.)	1953-1954			<i>Cork Rubber</i>	OS30902	1
Rear Main Seal Set	1953-1955			<i>Rope Packing</i>	JV650	1
				<i>Molded Rubber</i>	JV737	1
Timing Cover Set	1953-1955				JV754	1
Timing Cover Seal	1953-1955				<i>3/8" Wide</i>	49328
				(Lip Relocator Type)	<i>1/2" Wide</i>	65022
Harmonic Balancer Repair Sleeve	1953-1955				<i>Ground Steel, .020" Thickness</i>	66597RS
				Use With Part Number A504	<i>Nickel Plated Formed Steel, .013" Thickness</i>	A228

MISCELLANEOUS GASKETS

Air Cleaner Mount Gasket	1953-1955		3-1 Barrel Carburetors		G25936	3
Dist. Mounting Gasket	1953-1955				B26466	1
Exhaust Pipe Gasket	1953-1955		(Ring Type 'C')		F17250	1
				(Ring Type 'B')	<i>Sintered Metal</i>	F17250S
Fuel Pump Bowl Gasket	1953-1955				D34545	1
Fuel Pump Gasket	1953-1955				D27094	1
					<i>Tuff-Cork</i>	D27094TC
Fuel Pump Plate Gasket	1955				D25932	1
					<i>Tuff-Cork</i>	D25932TC
Heat Riser Gasket	1953-1955				F5436AK	3
Manifold Seal, Intake	1953-1955		Intake To Exhaust		B17897	1
Oil Pan Drain Plug Gst.	1953-1955				2051	1
Push Rod Cover Seal	1953-1955				H34510	6
Push Rod Cover Set	1953-1955			<i>Cork Rubber</i>	PS39685	1
Therm. Housing Gasket	1953-1955				C24529	1
Water Outlet Gasket	1953-1955		(Universal Type)		C24109	1
					C25930	1
Water Pump Mount Gasket	1955				K27069	1
	1953-1954				K25739	1

64 244 CID (4.0L) L47 Oldsmobile V8 Cyl, 3.425in./87mm (1995-2003) **64**

Part Year VIN Model/Application Part Number Qty.

ENGINE GASKETS

Cylinder Head Gasket	2001-2003		Left	<i>Nitroseal</i>	54358	1
				<i>Nitroseal</i>	54359	1
	1995-1999		Left	<i>Nitroseal</i>	54358	1
				<i>Nitroseal</i>	54359	1
Cyl. Head Bolt Set	2001-2003				GS33387	2
	1995-1999				GS33386	2
Valve Cover Set	2001-2003				VS50331	1
	1995-1999				VS50330	1
Oil Pan Set	2001-2003				OS32243	1
	1995-1999				OS32243	1

MISCELLANEOUS GASKETS

E.G.R. Gasket	2001-2002				G31304	1
	1995-1999				G31304	1
Exhaust Pipe Gasket	1995		1st Design, 2.250" Pipe, Front, Manifold To Exhaust Pipe		F7515	1
			2" Pipe, 2nd Design, Front, Manifold To Exhaust Pipe		F7522	1
Oil Pan Drain Plug Gst.	2001-2002				B45828	1

General Motors Corp.

64 (cont.)	244 CID (4.0L) L47 Oldsmobile V8 Cyl, 3.425in./87mm (1995-2003)				64 (cont.)
---------------	---	--	--	--	---------------

Part	Year	VIN	Model/Application	Part Number	Qty.
------	------	-----	-------------------	-------------	------

MISCELLANEOUS GASKETS (cont.)

Oil Pan Drain Plug Gst. (cont.)	1995-1999			B45828	1
---------------------------------	-----------	--	--	--------	---

65	250 CID (4.1L) Chevrolet 6 Cyl, 3.875in./98.4mm (1966-1979)				65
----	---	--	--	--	----

Part	Year	VIN	Model/Application	Part Number	Qty.
------	------	-----	-------------------	-------------	------

ENGINE GASKETS

Head Set	1975-1979		Integral Head And Intake Manifold, (Exhaust Pipe Gasket Not Included)	HS3829	1
	1966-1979		Separate Head And Intake Manifold, (Exhaust Pipe Gasket Not Included)	HS1185E	1
Lower Set	1966-1979		(Requires Head Set To Make Full Set)	CS1185	1
Full Set	1975-1979		Integral Head And Intake Manifold, (Exhaust Pipe Gasket Not Included)	FS3829	1
	1966-1979		Separate Head And Intake Manifold, (Exhaust Pipe Gasket Not Included)	FS1185E	1
Engine Kit Gasket Set	1975-1979		Integral Head	95-3044VR	1
	1968-1979		Except Integral Head	95-3000VR	1
	1966-1967		(Rear Main Seal Not Included), Use With Part Number JV728	95-3000VR	1
Cylinder Head Gasket	1966-1979		<i>VR2000</i>	3829	1
Valve Cover Set	1975-1979		Integral Head And Intake Manifold <i>Cork Rubber</i>	VS39755	1
	1966-1979		Separate Head And Intake Manifold <i>Cork Rubber</i>	VS39693	1
Valve Stem Seal, Exh.	1966-1979		(O-Ring Type)	B45229	6
Valve Stem Seal, Int.	1966-1979		(O-Ring Type)	B45229	6
Manifold Gasket	1966-1979		Separate Head And Intake Manifold, Intake To Exhaust	B7354	1
Manifold Set, Exhaust	1975-1979		Integral Head And Intake Manifold	MS15750	1
Manifold Set, Int. & Exh.	1966-1979		Separate Head And Intake Manifold	MS16033X	1
Oil Pan Set	1966-1979		<i>Cork Rubber</i>	OS30988X	1
Rear Main Seal Set	1969-1979		(Lip Relocator Type)	JV1627	1
	1968-1972		Except Distributor Boss Stamped F0623 With "R" Under Date, (Lip Relocator Type)	JV1627	1
	1969-1971		(Lip Relocator Type)	JV1627	1
	1966-1968		Distributor Boss Stamped F0623 With "R" Under Date	JV728	1
	1966-1967			JV728	1
Timing Cover Set	1966-1979		(Repair Sleeve Not Included)	JV862	1
			(Contains Repair Sleeve)	JV925	1
Timing Cover Gasket	1966-1979			T14744	1
Timing Cover Seal	1966-1979		<i>3/8" Wide</i>	49328	1
			(Lip Relocator Type) <i>1/2" Wide</i>	65022	1
Harmonic Balancer Repair Sleeve	1966-1979		<i>Ground Steel, .020" Thickness</i>	66597RS	1
			Use With Part Number A504 <i>Nickel Plated Formed Steel, .013" Thickness</i>	A228	1

MISCELLANEOUS GASKETS

Air Cleaner Mount Gasket	1968-1971		2 Barrel Carburetor	G25936	1
Carb. Mount Gasket	1972-1979		1 Barrel Carburetor	G14142	1
	1966-1972		Except Holley Carburetor, 1 Barrel Carburetor	G5349AD	1
Dist. Mounting Gasket	1966-1979			B26466	1
E.G.R. Gasket	1975-1979		Integral Head And Intake Manifold	G17797	1
	1973-1979		Separate Head And Intake Manifold	G26338	1
	1973-1974			G26338	1
Exhaust Pipe Gasket	1966-1979		(Ring Type 'C'), Pipe To Manifold	F17250	1
			(Ring Type 'B'), Pipe To Manifold <i>Sintered Metal</i>	F17250S	1
Fuel Pump Gasket	1966-1979			D27094	1
			<i>Tuff-Cork</i>	D27094TC	1

65 250 CID (4.1L) Chevrolet 6 Cyl, 3.875in./98.4mm (1966-1979) **65**
(cont.) (cont.)

Part	Year	VIN	Model/Application	Part Number	Qty.
MISCELLANEOUS GASKETS (cont.)					
Oil Pan Drain Plug Gst.	1966-1976			2051	1
Push Rod Cover Set	1966-1979		Cork Rubber	PS38113	1
Therm. Housing Gasket	1966-1979			C26544	1
Water Outlet Gasket	1966-1979		(Universal Type)	C24109	1
				C25930	1
Water Pump Mount Gasket	1966-1979			K26545	1

66 250 CID (4.1L) OHC Pontiac 6 Cyl, 3.875in./98.4mm (1968-1969) **66**

Part	Year	VIN	Model/Application	Part Number	Qty.
ENGINE GASKETS					
Valve Cover Set	1968-1969			VS29699	1
Valve Stem Seal, Exh.	1968-1969		(O-Ring Type)	B45229	6
Valve Stem Seal, Int.	1968-1969		(O-Ring Type)	B45229	6
				B45299	6
Timing Cover Set	1968-1969			JV857	1

MISCELLANEOUS GASKETS

Carb. Mount Gasket	1968-1969		4 Barrel Carburetor	G26656	1
Fuel Pump Gasket	1968-1969			D27094	1
				Tuff-Cork	D27094TC
Oil Pan Drain Plug Gst.	1968-1969			2051	1
Water Outlet Gasket	1968-1969			C24109	1

67 252 CID (4.1L) LC4 Buick V6 Cyl, 3.965in./100.7mm (1980-1984) **67**

Part	Year	VIN	Model/Application	Part Number	Qty.
ENGINE GASKETS					
Head Set	1980-1984		(Exhaust Pipe Gasket Not Included, Intake Manifold Gasket Not Included, Intake Valve Stem Seals Used With .552" Valve Guides Not Included)	HS3741	1
Full Set	1980-1984		(Exhaust Pipe Gasket Not Included, Intake Manifold Gasket Not Included, Intake Valve Stem Seals Used With .552" Valve Guides Not Included)	FS3741	1
Engine Kit Gasket Set	1984		(Intake Manifold Gasket Not Included, Optional 2 Piece Rubber Rear Main Seal Not Included), Use With Part Numbers MS15960, JV742R	95-3420VR	1
	1982-1983		Thru 11/30/82, (Intake Manifold Gasket Not Included, Optional 2 Piece Rubber Rear Main Seal Not Included), Use With Part Numbers MS15960, JV742R	95-3402VR	1
				95-3420VR	1
	1982		Thru 11/30/82, (Intake Manifold Gasket Not Included, Optional 2 Piece Rubber Rear Main Seal Not Included), Use With Part Numbers MS15960, JV742	95-3402VR	1
				95-3420VR	1
	1980-1981		(Intake Manifold Gasket Not Included, Optional 2 Piece Rubber Rear Main Seal Not Included), Use With Part Numbers MS15960, JV742R	95-3402VR	1
Cylinder Head Gasket	1980-1984		VR2000	5820	2
			Nitroseal	5820SG	2
Valve Cover Set	1980-1984		Cork Rubber	VS39763	1
			Victo-Tech	VS39763R	1
			Tuff-Cork	VS39763TC	1
Valve Stem Seal, Int.	1983-1984		.552" Guide Outside Diameter	B45484	6

General Motors Corp.

67 (cont.)	252 CID (4.1L) LC4 Buick V6 Cyl, 3.965in./100.7mm (1980-1984)				67 (cont.)
----------------------	--	--	--	--	----------------------

Part	Year	VIN	Model/Application	Part Number	Qty.
------	------	-----	-------------------	-------------	------

ENGINE GASKETS (cont.)

Valve Stem Seal, Int. (cont.)	1980-1983		.605" Guide Outside Diameter	B45497	6
Manifold Set, Exhaust	1980-1984			MS15327	1
Manifold Set, Intake	1980-1984			MS15960	1
Oil Pan Set	1980-1984		Cork Rubber	OS30668	1
			Tuff-Cork	OS30668TC	1
Rear Main Seal Set	1980-1984		Rope Packing	JV742	1
			Molded Rubber	JV742R	1
Timing Cover Set	1980-1984		(Contains Rope Packing)	JV906	1
			(Contains Superflex Seal)	JV1051SF	1
Timing Cover Gasket	1980-1984			T27960	1
Timing Cover Seal	1980-1984		(Superflex)	65025SF	1

MISCELLANEOUS GASKETS

Air Cleaner Mount Gasket	1980-1984		4 Barrel Carburetor	G27098	1
Carb. Mount Gasket	1980-1984		4 Barrel Carburetor	G26717	1
Dist. Mounting Gasket	1980-1984			72215	1
E.G.R. Gasket	1980-1984			G26315	1
Exhaust Pipe Gasket	1980-1984			F7394	1
Fuel Pump Gasket	1980-1984			D27094	1
			Tuff-Cork	D27094TC	1
	1982		Performaseal	D27094VC	1
Oil Pan Drain Plug Gskt.	1980-1984			2051	1
Oil Pump Cover Gasket	1980-1984			B45577	1
Water Outlet Gasket	1980-1984			C26515	1
Water Pump Mount Gasket	1980-1984			K27571	1

68	252 CID (4.1L) Cadillac V8 Cyl, 3.465in./88mm (1982-1988)				68
-----------	--	--	--	--	-----------

Part	Year	VIN	Model/Application	Part Number	Qty.
------	------	-----	-------------------	-------------	------

ENGINE GASKETS

Head Set	1987-1988	7	Allante, (Exhaust Pipe Gasket Not Included)	HS5781	1
	1985-1987	8	(Exhaust Pipe Gasket Not Included, Valve Cover Gasket For Stamped Steel Cover Not Included)	HS3720W	1
	1982-1984	8	(Exhaust Pipe Gasket Not Included, Valve Cover Gasket For Stamped Steel Cover Not Included)	HS3720	1
Full Set	1987-1988	7	Allante, (Exhaust Pipe Gasket Not Included)	FS5781	1
	1985-1987	8	Transverse Engine, (Exhaust Pipe Gasket Not Included, Valve Cover Gasket For Stamped Steel Cover Not Included)	FS3720X	1
	1985-1986	8	Except Transverse Engine, (Exhaust Pipe Gasket Not Included, Valve Cover Gasket For Stamped Steel Cover Not Included)	FS3720W	1
	1982-1984	8	(Exhaust Pipe Gasket Not Included, Valve Cover Gasket For Stamped Steel Cover Not Included)	FS3720	1
Engine Kit Gasket Set	1985-1987	8	Aluminum Valve Cover, Transverse Engine	95-3440VR	1
		8	Steel Valve Covers, Transverse Engine, (Valve Cover Set Not Included), Use With Part Number VS38336TC	95-3440VR	1
		8	Aluminum Valve Cover, Except Transverse Engine, (Valve Cover Set Not Included), Use With Part Number VS50018	95-3441VR	1
	1982-1987	8	Except Transverse Engine, Steel Valve Covers	95-3441VR	1
Cylinder Head Gasket	1987-1988	7	Allante	Nitroseal 5781G	2
	1982-1987	8		Nitroseal 3720G	2
Valve Cover Set	1987-1988	7	Allante, (Intake Manifold Seals Not Included)	Victo-Tech VS50116	1
		7	Allante, (Single Valve Cover, Intake Manifold Seals Not Included)	Victo-Tech VS50127	2
	1986-1987	8		Victo-Tech VS50018	1

68 (cont.)	252 CID (4.1L) Cadillac V8 Cyl, 3.465in./88mm (1982-1988)				68 (cont.)
---------------	---	--	--	--	---------------

Part	Year	VIN	Model/Application	Part Number	Qty.
ENGINE GASKETS (cont.)					
Valve Cover Set (cont.)	1986-1987	8	(Single Valve Cover) <i>Victo-Tech</i>	VS50124	2
	1985	8	Steel Valve Covers <i>Cork Rubber</i>	VS38336	1
		8	Steel Valve Covers <i>Tuff-Cork</i>	VS38336TC	1
		8	Except Steel Valve Cover <i>Victo-Tech</i>	VS50018	1
		8	Except Steel Valve Cover, (Single Valve Cover) <i>Victo-Tech</i>	VS50124	2
	1982-1984	8	<i>Cork Rubber</i>	VS38336	1
8		<i>Tuff-Cork</i>	VS38336TC	1	
Valve Stem Seal, Exh.	1987-1988	7		B45770	8
	1982-1987	8		B45770	8
Valve Stem Seal, Int.	1987-1988	7		B45770	8
	1982-1987	8		B45770	8
Manifold Set, Exhaust	1987-1988	7	Allante	MS15680	1
	1982-1987	8		MS15342	1
Manifold Set, Intake	1987-1988	7	Allante, (Contains Plenum Chamber Gasket)	MS15667	1
	1984-1987	8		MS15341BF	1
	1982-1983	8		MS15341	1
Plenum Chamber Gasket	1987-1988	7	Allante	MS15667A	1
Oil Pan Set	1987-1988	7	Allante <i>Tuff-Cork</i>	OS32472TC	1
	1985-1987	8	Transverse Engine <i>Tuff-Cork</i>	OS32472TC	1
	1982-1985	8	Except Transverse Engine <i>Tuff-Cork</i>	OS30588TC	1
Rear Main Seal Set	1987-1988	7	Allante, (1 Piece)	JV557	1
	1985-1987	8	Transverse Engine, (1 Piece)	JV557	1
	1982-1987	8	Except Transverse Engine, (2 Piece)	JV517	1
	1982-1984	8	(2 Piece)	JV517	1
Crank Repair Sleeve	1982-1988		<i>Nickel Plated Formed Steel, .013" Thickness</i>	A352	1
Timing Cover Set	1987-1988	7	Allante	JV1109	1
	1985-1987	8	Except Bead On Water Pump Flange, Transverse Engine	JV1074	1
		8	Bead On Water Pump Flange, Transverse Engine	JV1109	1
	1982-1986	8	Except Transverse Engine	JV970	1
	1982-1984	8		JV970	1
Timing Cover Gasket	1982-1987			T27247	1
Timing Cover Seal	1982-1987			47937	1
MISCELLANEOUS GASKETS					
Air Cleaner Mount Gasket	1987-1988	7	Electronic Fuel Injection	G27098	1
	1982-1987	8	Digital Fuel Injection	G27098	1
		8	Electronic Fuel Injection, Digital Fuel Injection	G27098	1
Dist. Mounting Gasket	1987-1988	7		72220	1
	1982-1987	8		72220	1
E.G.R. Gasket	1987-1988	7		G17797	1
	1982-1987	8		G17797	1
Exhaust Pipe Gasket	1985-1987	8	Transverse Engine, (Ring Type 'F'), Pipe To Manifold	F7210	1
	1982-1987	8	Except Transverse Engine, (Ring Type 'E'), Pipe To Manifold	F7407	1
Injector Nozzle O-Ring	1987-1988	7	Allante	GS33276	4
Manifold Seal, Intake	1987-1988	7		B45730	4
	1982-1987	8		B45730	4
Therm. Mount Gasket	1982-1984	8	<i>Victo-Tech</i>	C24157	1
Thermostat O-Ring	1985-1987	8	<i>Victo-Tech</i>	C31200	1
Throttle Body Gasket	1982-1987	8		G26697	1
Water Inlet Gasket	1987-1988	7	Lower	C31328	1
	1985-1987	8	Lower	C31328	1
Water Outlet Gasket	1987-1988	7	Allante	GS33253	1
		7	Allante, Lower	GS33271	1
	1985-1987	8	Transverse Engine	GS33253	1
		8	Lower	GS33271	1
	1984-1986	8	Except Transverse Engine	C24005	1

General Motors Corp.

68 (cont.)	252 CID (4.1L) Cadillac V8 Cyl, 3.465in./88mm (1982-1988)				68 (cont.)
----------------------	--	--	--	--	----------------------

<i>Part</i>	<i>Year</i>	<i>VIN</i>	<i>Model/Application</i>	<i>Part Number</i>	<i>Qty.</i>
MISCELLANEOUS GASKETS (cont.)					
Water Outlet Gasket (cont.)	1982-1984	8		C24005	1
Water Pump Mount Gasket	1987-1988	7	Allante	K31092	1
	1986-1987	8	Bead On Water Pump Flange, Transverse Engine	K31092	1
	1985-1986	8	Except Bead On Water Pump Flange, Transverse Engine	K31091	1
	1984-1986	8	Except Transverse Engine	K27450	1
	1982-1984	8		K27450	1

69	260 CID (4.3L) Oldsmobile Diesel V6 Cyl, 4.057in./103mm (1982-1985)				69
-----------	--	--	--	--	-----------

<i>Part</i>	<i>Year</i>	<i>VIN</i>	<i>Model/Application</i>	<i>Part Number</i>	<i>Qty.</i>
ENGINE GASKETS					
Head Set	1982-1984		(Exhaust Pipe Gasket Not Included)	HS3719	1
Full Set	1982-1984		(Exhaust Pipe Gasket Not Included)	FS3719	1
Cylinder Head Gasket	1982-1984			3719	2
Valve Cover Set	1982-1985		Cork Rubber	VS38335	1
Valve Stem Seal, Exh.	1982-1985			B45416	6
Valve Stem Seal, Int.	1982-1985			B45416	6
Manifold Set, Exhaust	1982-1985			MS12283	1
			Stainless Steel Manifold	MS12295	1
Manifold Set, Intake	1982-1985			MS12291	1
Oil Pan Set	1982-1985		Cork Rubber	OS30578	1
Rear Main Seal Set	1982-1985			JV749	1
Timing Cover Set	1982-1985			JV987	1
Timing Cover Gasket	1982-1985			T27823	1
Timing Cover Seal	1982-1985			47398	1
Harmonic Balancer Repair Sleeve	1982-1985		Use With Part Number A500 Nickel Plated Formed Steel, .013" Thickness	A231	1

MISCELLANEOUS GASKETS					
E.G.R. Gasket	1984-1985			G31083	1
	1983-1985		Reverse Flow Exhaust Gas Recirculation	G31083	1
	1982-1983		Except Reverse Flow Exhaust Gas Recirculation	G26280	1
	1982			G26280	1
Exhaust Pipe Gasket	1985		DeVille, Electra, Fleetwood, (Ring Type 'E'), Pipe To Manifold	F7219	1
	1982-1985		6000, Monte Carlo, Ninety Eight, Regal, (Ring Type 'E'), Pipe To Manifold	F7219	1
			Celebrity, Century, Cutlass Ciera, (Ring Type 'E'), Pipe To Manifold	F7270	1
	1982-1984		Cutlass, Cutlass Supreme, (Ring Type 'E'), Pipe To Manifold	F7219	1
	1982-1983		Malibu, (Ring Type 'E'), Pipe To Manifold	F7219	1
	1982		Bonneville, (Ring Type 'E'), Pipe To Manifold	F7270	1
Inj. Pump Mtg. Gasket	1982-1985			B26350	1
Oil Filter Mount Gasket	1982-1985			B26607	1
Water Outlet Gasket	1982-1985			C24111	1
Water Pump Mount Gasket	1985			K27396	1
	1982-1985		Transverse Engine	K27396	1
	1982-1984		Except Transverse Engine	K27398	1

70	260 CID (4.3L) LF7 Oldsmobile Diesel V8 Cyl, 3.500in./88.9mm (1979)				70
-----------	--	--	--	--	-----------

<i>Part</i>	<i>Year</i>	<i>VIN</i>	<i>Model/Application</i>	<i>Part Number</i>	<i>Qty.</i>
ENGINE GASKETS					
Head Set	1979		(Exhaust Pipe Gasket Not Included)	HS3690	1
Full Set	1979		(Exhaust Pipe Gasket Not Included)	FS3690	1

70 (cont.)	260 CID (4.3L) LF7 Oldsmobile Diesel V8 Cyl, 3.500in./88.9mm (1979)				70 (cont.)
----------------------	--	--	--	--	----------------------

<i>Part</i>	<i>Year</i>	<i>VIN</i>	<i>Model/Application</i>	<i>Part Number</i>	<i>Qty.</i>
ENGINE GASKETS (cont.)					
Cylinder Head Gasket	1979			3690	2
Valve Cover Set	1979			<i>Cork Rubber</i> VS38305	1
				<i>High Temperature Cork Rubber</i> VS38305H	1
				<i>Victo-Tech</i> VS38305R	1
				<i>Tuff-Cork</i> VS38305TC	1
Valve Stem Seal, Exh.	1979			B45416	8
Valve Stem Seal, Int.	1979			B45416	8
Manifold Set, Exhaust	1979			MS15141	1
Manifold Set, Intake	1979			MS15122	1
Oil Pan Set	1979			<i>Cork Rubber</i> OS30534	1
				<i>Tuff-Cork</i> OS30534TC	1
Rear Main Seal Set	1979		(Not Contained In Full Set)	<i>Molded Rubber</i> JV748	1
				<i>Rope Packing</i> JV749	1
Timing Cover Set	1979		(Repair Sleeve Not Included)	JV845	1
			(Contains Repair Sleeve)	JV927	1
Timing Cover Gasket	1979			T27823	1
Timing Cover Seal	1979			47398	1
Harmonic Balancer Repair Sleeve	1979		<i>Ground Steel, .020" Thickness</i>	66590RS	1

MISCELLANEOUS GASKETS

Air Cleaner Mount Gasket	1979		Indirect Injection	G27098	1
Exhaust Pipe Gasket	1979			F7207	1
Fuel Pump Gasket	1979			D26606	1
				<i>Tuff-Cork</i> D26606TC	1
Water Outlet Gasket	1979			C24111	1
Water Pump Mount Gasket	1979		Air Conditioning, Heavy Duty Cooling	K27156	1
			Except Air Conditioning, Except Heavy Duty Cooling	K27821A	1

71	260 CID (4.3L) LV8 Oldsmobile V8 Cyl, 3.500in./88.9mm (1975-1982)				71
-----------	--	--	--	--	-----------

<i>Part</i>	<i>Year</i>	<i>VIN</i>	<i>Model/Application</i>	<i>Part Number</i>	<i>Qty.</i>
ENGINE GASKETS					
Head Set	1977-1982		(Exhaust Pipe Gasket Not Included, Intake Manifold Gasket Not Included, Contains Solicor Cylinder Head Gasket)	HS3532	1
	1975-1976		(Exhaust Pipe Gasket Not Included, Intake Manifold Gasket Not Included, Contains Beaded Steel Cylinder Head Gasket)	HS3507	1
Full Set	1977-1982		(Exhaust Pipe Gasket Not Included, Intake Manifold Gasket Not Included, Contains Solicor Cylinder Head Gasket)	FS3532	1
	1975-1976		(Exhaust Pipe Gasket Not Included, Intake Manifold Gasket Not Included, Contains Beaded Steel Cylinder Head Gasket)	FS3507	1
Engine Kit Gasket Set	1977-1982		(Intake Manifold Gasket Not Included), Use With Part Number MS15944	95-3046VR	1
Cylinder Head Gasket	1977-1982			<i>Solicor</i> 3532	2
	1975-1976			<i>Beaded Steel</i> 3507	2
Valve Cover Set	1975-1982			<i>Cork Rubber</i> VS38305	1
				<i>High Temperature Cork Rubber</i> VS38305H	1
				<i>Victo-Tech</i> VS38305R	1
				<i>Tuff-Cork</i> VS38305TC	1
Valve Stem Seal, Exh.	1975-1982			B45416	8
Valve Stem Seal, Int.	1975-1982			B45416	8
Manifold Set, Exhaust	1975-1982			MS15141	1
Manifold Set, Intake	1977-1982			MS15944	1
	1975-1976			MS15932	1
Oil Pan Set	1975-1982			<i>Cork Rubber</i> OS30534	1
				<i>Tuff-Cork</i> OS30534TC	1
Rear Main Seal Set	1975-1982			<i>Molded Rubber</i> JV748	1

General Motors Corp.

71 260 CID (4.3L) LV8 Oldsmobile V8 Cyl, 3.500in./88.9mm (1975-1982) **71**
 (cont.) (cont.)

Part Year VIN Model/Application Part Number Qty.

ENGINE GASKETS (cont.)

Rear Main Seal Set (cont.)	1975-1982		Rope Packing	JV749	1
Timing Cover Set	1975-1982		(Repair Sleeve Not Included)	JV845	1
			(Contains Repair Sleeve)	JV927	1
Timing Cover Gasket	1975-1982			T27823	1
Timing Cover Seal	1975-1982			47398	1
Harmonic Balancer Repair Sleeve	1975-1982		Ground Steel, .020" Thickness	66590RS	1
			Use With Part Number A500 Nickel Plated Formed Steel, .013" Thickness	A222	1

MISCELLANEOUS GASKETS

Air Cleaner Mount Gasket	1975-1982		2 Barrel Carburetor	G26906	1
Carb. Mount Gasket	1978-1982		2 Barrel Carburetor	G26775	1
	1975-1977		2 Barrel Carburetor	G26712	1
Choke Tube Gasket	1975-1982			B45786	1
Dist. Mounting Gasket	1975-1982			72219	1
E.G.R. Gasket	1975-1982			G17797	1
Exhaust Pipe Gasket	1975-1982		(Ring Type 'E'), Pipe To Manifold	F7207	1
Fuel Pump Gasket	1975-1982			D26606	1
				Tuff-Cork D26606TC	1
Oil Filter Mount Gasket	1975-1976			B26607	1
Oil Pump Cover Gasket	1975-1976			B45813	1
Water Outlet Gasket	1975-1982			C24111	1
Water Pump Mount Gasket	1975-1982		Air Conditioning, Heavy Duty Cooling	K27156	1
			Except Air Conditioning, Except Heavy Duty Cooling	K27821A	1

72 262 CID (4.3L) Chevrolet V6 Cyl, 4.000in./101.6mm (1985-1993) **72**

Part Year VIN Model/Application Part Number Qty.

ENGINE GASKETS

Head Set	1993		(Head Bolts Not Included)	HS5744A	1
	1988-1992		(Head Bolts Not Included)	HS5744W	1
	1985-1987		(Head Bolts Not Included)	HS5744	1
Lower Set	1986-1993		(Requires Head Set To Make Full Set)	CS5744A	1
Full Set	1988-1992		(Head Bolts Not Included)	FS5744X	1
	1986-1987		(Head Bolts Not Included)	FS5744W	1
	1985		(Head Bolts Not Included)	FS5744	1
Engine Kit Gasket Set	1993		(Intake Manifold Gasket Not Included), Use With Part Number MS15622	95-3407VR	1
	1986-1992			95-3407VR	1
	1985			95-3442VR	1
Cylinder Head Gasket	1985-1993		(Single Sided Graphite) Nitroseal	5744	2
Cyl. Head Bolt Set	1985-1993			GS33286	2
Valve Cover Set	1985-1993			Tuff-Cork VS50024TC	1
			(Single Valve Cover)	Tuff-Cork VS50125TC	2
				Victo-Tech VS50160	1
			(Single Valve Cover)	Victo-Tech VS50162	2
Valve Stem Seal, Exh.	1985-1993		(O-Ring Type)	B45229	6
			(High Temperature)	B45779	6
Valve Stem Seal, Int.	1985-1993		(O-Ring Type)	B45229	6
			(Positive Type)	Fluoroelastomer B45418	6
Manifold Set, Exhaust	1985-1993			MS15251	1
Manifold Set, Intake	1993			MS15622	1
	1988-1992			MS15373	1

PASSENGER CAR

72 262 CID (4.3L) Chevrolet V6 Cyl, 4.000in./101.6mm (1985-1993) **72**
(cont.) (cont.)

Part	Year	VIN	Model/Application	Part Number	Qty.
ENGINE GASKETS (cont.)					
Manifold Set, Intake (cont.)	1985-1987			MS15352	1
Oil Pan Set	1986-1993		Tuff-Cork	OS32470TC	1
			Victo-Tech	OS32485	1
			(Original Equipment Style Steel Backbone) Victo-Tech	OS32485B	1
	1985		Cork Rubber	OS30934	1
Rear Main Seal Set	1986-1993		(1 Piece)	JV554	1
			(1 Piece) Teflon	JV1634	1
	1985		(2 Piece, Lip Relocator Type)	JV1627	1
Crank Repair Sleeve	1986-1993		Use With Part Number A506, Rear Nickel Plated Formed Steel, .013" Thickness	A338	1
Seal Extender	1986-1993		1 Piece Rear Main Seal	E300	1
Timing Cover Set	1986-1993		Oil Pan Gasket Required	JV1041	1
	1985		(Repair Sleeve Not Included)	JV881	1
			(Contains Repair Sleeve)	JV926	1
Timing Cover Gasket	1985-1993			T27781	1
Timing Cover Seal	1985-1993		3/8" Wide	49328	1
			(Lip Relocator Type) 1/2" Wide	65022	1
Harmonic Balancer Repair Sleeve	1985-1993		Ground Steel, .020" Thickness	66597RS	1
			Use With Part Number A504 Nickel Plated Formed Steel, .013" Thickness	A228	1

MISCELLANEOUS GASKETS

Air Cleaner Mount Gasket	1985-1993		Throttle Body Injection	G27098	1
	1985-1988			G27098	1
	1985-1987		Throttle Body Injection	G27098	1
Dist. Mounting Gasket	1985-1992			B25934	1
E.G.R. Gasket	1990-1993			G31178	1
	1985-1989			G26315	1
Exhaust Pipe Gasket	1993		(Ring Type 'E'), Pipe To Manifold	F7507	2
	1986-1992		(Flange Type), Pipe To Manifold	F14144	2
	1985		(Ring Type 'E'), Pipe To Manifold	F7447	2
Fuel Pump Gasket	1985-1993			D27211	1
Oil Pan Drain Plug Gst.	1985-1993			2051	1
Oil Pump Shaft Retainer	1985-1993			H31354	1
Throttle Body Gasket	1986-1993			G31133	1
Water Outlet Gasket	1985-1993			C25930	1
Water Pump Backing Plate	1985-1993			K27091	1
Water Pump Mount Gasket	1985-1993			K25935	2

73 262 CID (4.3L) Chevrolet V8 Cyl, 3.670in./93.2mm (1975-1976) **73**

Part	Year	VIN	Model/Application	Part Number	Qty.
ENGINE GASKETS					
Head Set	1975-1976		(Head Bolts Not Included, Positive Type Valve Stem Seals Not Included)	HS3514VJ	1
			(Head Bolts Not Included, Contains Positive Type Valve Stem Seals)	HS3514VK	1
Full Set	1975-1976		(Head Bolts Not Included, Positive Type Valve Stem Seals Not Included)	FS3514VJ	1
			(Head Bolts Not Included, Contains Positive Type Valve Stem Seals)	FS3514VK	1
Engine Kit Gasket Set	1975-1976			95-3045VR	1
Cylinder Head Gasket	1975-1976		Nitroseal	3514SG	2

General Motors Corp.

73 262 CID (4.3L) Chevrolet V8 Cyl, 3.670in./93.2mm (1975-1976) **73**
 (cont.) (cont.)

Part	Year	VIN	Model/Application	Part Number	Qty.
ENGINE GASKETS (cont.)					
Cylinder Head Gasket (cont.)	1975-1976		VR2000	3514VC	2
			(Single Sided Graphite)	Nitroseal 5745	2
Cyl. Head Bolt Set	1975-1976			GS33285	2
Valve Cover Set	1975-1976		Cork Rubber	VS38110	1
			High Temperature Cork Rubber	VS38110HA	1
			High Temperature Tuff-Cork	VS38110HTC	1
			Victo-Tech	VS38110R	1
Valve Stem Seal, Exh.	1975-1976		(O-Ring Type)	B45229	8
				B45264	8
			(High Temperature)	B45779	8
Valve Stem Seal, Int.	1975-1976		(O-Ring Type)	B45229	8
				Fluoroelastomer B45418	8
Manifold Set, Exhaust	1975-1976			MS7110X	1
Manifold Set, Intake	1975-1976			MS15315	1
Oil Pan Set	1975-1976		Left Hand Dip Stick	Victo-Tech OS30568RLH	1
				Cork Rubber OS30568Z	1
				Tuff-Cork OS30568ZTC	1
Rear Main Seal Set	1975-1976		(Lip Relocator Type)	JV1627	1
Timing Cover Set	1975-1976		(Repair Sleeve Not Included)	JV881	1
			(Contains Repair Sleeve)	JV926	1
Timing Cover Gasket	1975-1976			T27781	1
Timing Cover Seal	1975-1976			3/8" Wide 49328	1
			(Lip Relocator Type)	1/2" Wide 65022	1
Harmonic Balancer Repair Sleeve	1975-1976		Ground Steel, .020" Thickness	66597RS	1

MISCELLANEOUS GASKETS

Air Cleaner Mount Gasket	1975-1976		2 Barrel Carburetor	G26617	1
	1975		4 Barrel Carburetor	G27098	1
Carb. Mount Gasket	1975-1976		2 Barrel Carburetor	G26711	1
Choke Tube Gasket	1976			B45787	1
Dist. Mounting Gasket	1975-1976			B25934	1
E.G.R. Gasket	1975-1976			G26748	1
Fuel Pump Gasket	1975-1976		Plate To Block	D25932	1
			Plate To Block	Tuff-Cork D25932TC	1
			Pump To Plate	D27094	1
			Pump To Plate	Tuff-Cork D27094TC	1
Oil Pan Drain Plug Gst.	1975-1976			2051	1
Oil Pump Shaft Retainer	1975-1976			H31354	1
Water Outlet Gasket	1975-1976		(Universal Type)	C24109	1
				C25930	1
Water Pump Backing Plate	1975-1976			K27091	1
Water Pump Mount Gasket	1975-1976			K25935	2

74 265 CID (4.3L) Chevrolet V8 Cyl, 3.750in./95.3mm (1955-1957) **74**

Part	Year	VIN	Model/Application	Part Number	Qty.
ENGINE GASKETS					
Head Set	1955-1957		(Head Bolts Not Included)	HS1178VC	1
Lower Set	1955-1957		(Rear Main Seal Not Included, Requires Head Set To Make Full Set)	CS1178	1
Full Set	1955-1957		(Head Bolts Not Included)	FS1178VC	1

74 (cont.)	265 CID (4.3L) Chevrolet V8 Cyl, 3.750in./95.3mm (1955-1957)	74 (cont.)
----------------------	---	----------------------

Part	Year	VIN	Model/Application	Part Number	Qty.
------	------	-----	-------------------	-------------	------

ENGINE GASKETS (cont.)

Engine Kit Gasket Set	1955-1957		(Rear Main Seal Not Included, Intake Manifold Gasket Not Included), Use With Part Numbers MS18680, JV688	95-3033VR	1
Cylinder Head Gasket	1955-1957		<i>VR2000</i>	1178VC	2
Cyl. Head Bolt Set	1955-1957			GS33285	2
Valve Cover Set	1955-1957		<i>Cork Rubber</i>	VS38110	1
			<i>High Temperature Cork Rubber</i>	VS38110HA	1
			<i>High Temperature Tuff-Cork</i>	VS38110HTC	1
			<i>Victo-Tech</i>	VS38110R	1
			<i>Tuff-Cork</i>	VS38110TC	1
Valve Stem Seal, Exh.	1955-1957		(O-Ring Type)	B45229	8
				B45264	8
			(High Temperature)	B45779	8
Valve Stem Seal, Int.	1955-1957		(O-Ring Type)	B45229	8
				B45264	8
			(High Temperature)	B45779	8
Manifold Set, Exhaust	1955-1957			MS7110X	1
Manifold Set, Intake	1955-1957			MS18680	1
Oil Pan Set	1957		<i>Cork Rubber</i>	OS30568X	1
			<i>Tuff-Cork</i>	OS30568XTC	1
	1955-1956		<i>Cork Rubber</i>	OS30568	1
Rear Main Seal Set	1955-1957			JV688	1
Timing Cover Set	1955-1957		(Repair Sleeve Not Included)	JV779	1
			(Contains Repair Sleeve)	JV919	1
Timing Cover Gasket	1955-1957			T27781	1
Timing Cover Seal	1955-1957		<i>3/8" Wide</i>	49328	1
			(Lip Relocator Type) align="right"> <i>1/2" Wide</i>	65022	1
Harmonic Balancer Repair Sleeve	1955-1957		<i>Ground Steel, .020" Thickness</i>	66597RS	1
			Use With Part Number A504 <i>Nickel Plated Formed Steel, .013" Thickness</i>	A228	1

MISCELLANEOUS GASKETS

Air Cleaner Mount Gasket	1955-1957		2 Barrel Carburetor	G25936	1
	1956		2 Barrel Carburetor	G25936	1
	1955-1956		4 Barrel Carburetor	G25936	1
Carb. Mount Gasket	1955-1957		2 Barrel Carburetor	G12216	1
			4 Barrel Carburetor	G14556	2
Dist. Mounting Gasket	1955-1957			B25934	1
Exhaust Pipe Gasket	1955-1957		Crossover Pipe	F5436AK	3
			1.937" Pipe, (Flange Type), Pipe To Manifold	F5436AK	3
			1.875" Pipe, (Ring Type 'E'), Pipe To Manifold	F17355	1
Fuel Pump Gasket	1955-1957		Plate To Block	D25932	1
			Plate To Block align="right"> <i>Tuff-Cork</i>	D25932TC	1
			Pump To Plate	D27094	1
			Pump To Plate align="right"> <i>Tuff-Cork</i>	D27094TC	1
Heat Riser Gasket	1955-1957		2 Bolt align="right"> <i>1.937" Inside Diameter</i>	F5436AK	1
Oil Pan Drain Plug Gst.	1955-1957			2051	1
Water Outlet Gasket	1955-1957		(Universal Type)	C24109	1
				C25930	1
Water Pump Backing Plate	1955-1957			K27091	1
Water Pump Mount Gasket	1955-1957			K25935	2

General Motors Corp.

75 265 CID (4.3L) L99 Chevrolet V8 Cyl, 3.750in./95.3mm (1994-1996)

75

Part	Year	VIN	Model/Application	Part Number	Qty.
ENGINE GASKETS					
Head Set	1994-1996		(Exhaust Pipe Gasket Not Included)	HS5899	1
Lower Set	1994-1996			CS5922	1
Cylinder Head Gasket	1994-1996		VR2000	5899	2
Cyl. Head Bolt Set	1994-1996			GS33285	2
Valve Cover Set	1994-1996		Victo-Tech	VS50161	1
			(Single Valve Cover) Victo-Tech	VS50163	2
Valve Stem Seal, Exh.	1994-1996			B45796	8
Valve Stem Seal, Int.	1994-1996			B45796	8
Manifold Set, Exhaust	1994-1996			MS16107	1
Manifold Set, Intake	1994-1996			MS16134	1
Oil Pan Set	1994-1996		(Original Equipment Style Steel Backbone) Victo-Tech	OS32496B	1
Rear Main Seal Set	1994-1996		(1 Piece)	JV554	1
			(1 Piece) Teflon	JV1634	1
Crank Repair Sleeve	1994-1996		Use With Part Number A506, Rear Nickel Plated Formed Steel, .013" Thickness	A338	1
Seal Extender	1994-1996			E300	1
Timing Cover Set	1994-1996			JV1154	1
Timing Cover Gasket	1994-1996			T31276	1
Timing Cover Seal	1994-1996		3/8" Wide	49328	1
			(Lip Relocator Type) 1/2" Wide	65022	1

MISCELLANEOUS GASKETS

E.G.R. Gasket	1994-1996			G26315	1
Exhaust Pipe Gasket	1994-1996			F10152	2
Injector Nozzle O-Ring	1994-1996			GS33276	4
Oil Pan Drain Plug Gst.	1994-1996			2051	1
Oil Pump Shaft Retainer	1994-1996			H31354	1
Throttle Body Gasket	1994-1996			G31283	1
Valve Cover Grommet	1994-1996			GS33306	1
Water Outlet Gasket	1994-1996		Victo-Tech	C31273	1
Water Pump Mount Gasket	1994-1996			K31277	2

76 265 CID (4.3L) LS5 Pontiac V8 Cyl, 3.750in./95.3mm (1980-1981)

76

Part	Year	VIN	Model/Application	Part Number	Qty.
ENGINE GASKETS					
Head Set	1980-1981			HS3565	1
Full Set	1980-1981			FS3565	1
Engine Kit Gasket Set	1980-1981			95-3048VR	1
Cylinder Head Gasket	1980-1981		VR2000	3565	2
Valve Cover Set	1980-1981		Cork Rubber	VS38291X	1
			High Temperature Cork Rubber	VS38291XH	1
Valve Stem Seal, Exh.	1980-1981		(O-Ring Type)	B45229	8
Valve Stem Seal, Int.	1980-1981		(O-Ring Type)	B45229	8
			(Positive Type) Fluoroelastomer	B45418	8
Manifold Set, Exhaust	1980-1981			MS15217	1
Manifold Set, Intake	1980-1981			MS15216	1
Oil Pan Set	1980-1981		Cork Rubber	OS20491	1
			Tuff-Cork	OS20491TC	1
Rear Main Seal Set	1980-1981			JV708	1
Timing Cover Set	1980-1981		(Repair Sleeve Not Included)	JV877	1
			(Contains Repair Sleeve)	JV920	1
Harmonic Balancer Repair Sleeve	1980-1981		Ground Steel, .020" Thickness	66601RS	1
			Use With Part Number A502 Nickel Plated Formed Steel, .013" Thickness	A229-1	1

76 265 CID (4.3L) LS5 Pontiac V8 Cyl, 3.750in./95.3mm (1980-1981) **76**
(cont.) (cont.)

Part	Year	VIN	Model/Application	Part Number	Qty.
MISCELLANEOUS GASKETS					
Air Cleaner Mount Gasket	1980-1981		2 Barrel Carburetor	G26906	1
Carb. Mount Gasket	1980-1981		2 Barrel Carburetor, Carburetor To Adapter	G26775	1
			2 Barrel Carburetor, Adapter To Manifold	G26954	1
Dist. Mounting Gasket	1980-1981			B25941	1
E.G.R. Gasket	1980-1981			G17797	1
Fuel Pump Gasket	1980-1981			D27094	1
				Tuff-Cork D27094TC	1
Push Rod Cover Set	1980-1981		Cork Rubber	PS38786	1
Water Outlet Gasket	1980-1981			C24109	1
Water Pump Mount Gasket	1980-1981			K27149	2
Water Pump Tube Seal	1980-1981			B45687	2

77 267 CID (4.4L) L39 Chevrolet V8 Cyl, 3.500in./88.9mm (1979-1982) **77**

Part	Year	VIN	Model/Application	Part Number	Qty.
ENGINE GASKETS					
Head Set	1981-1982		(Head Bolts Not Included)	HS3514VK	1
	1979-1980		(Head Bolts Not Included)	HS3514VJ	1
Lower Set	1979-1982		(Requires Head Set To Make Full Set)	CS1178	1
Full Set	1981-1982		(Head Bolts Not Included)	FS3514VK	1
	1979-1980		(Head Bolts Not Included)	FS3514VJ	1
Engine Kit Gasket Set	1981-1982			95-3071VR	1
	1979-1980			95-3045VR	1
Cylinder Head Gasket	1979-1982		Nitroseal	3514SG	2
			VR2000	3514VC	2
			(Single Sided Graphite) Nitroseal	5745	2
Cyl. Head Bolt Set	1979-1982			GS33285	2
Valve Cover Set	1979-1982		Cork Rubber	VS38110	1
			High Temperature Cork Rubber	VS38110HA	1
			High Temperature Tuff-Cork	VS38110HTC	1
			Victo-Tech	VS38110R	1
			Tuff-Cork	VS38110TC	1
Valve Stem Seal, Exh.	1981-1982		(Shedder Type)	B45264	8
			(High Temperature)	B45779	8
	1979-1982		(O-Ring Type)	B45229	8
Valve Stem Seal, Int.	1981-1982		(Positive Type) Fluoroelastomer	B45418	8
	1979-1982		(O-Ring Type)	B45229	8
Manifold Set, Exhaust	1979-1982			MS7110X	1
Manifold Set, Intake	1979-1982		Liquid Propane Gas	MS15219BF	1
			Except Liquid Propane Gas	MS15315	1
Oil Pan Set	1980-1982		Right Hand Dip Stick	Victo-Tech OS30568RRH	1
				Tuff-Cork OS30572TC	1
	1979-1982			Cork Rubber OS30568Z	1
			1979		Left Hand Dip Stick Victo-Tech OS30568RLH
				Tuff-Cork OS30568ZTC	1
Rear Main Seal Set	1979-1982		(Lip Relocator Type)	JV1627	1
Timing Cover Set	1979-1982		(Repair Sleeve Not Included)	JV881	1
			(Contains Repair Sleeve)	JV926	1
Timing Cover Gasket	1979-1982			T27781	1
Timing Cover Seal	1979-1982			3/8" Wide 49328	1
			(Lip Relocator Type)	1/2" Wide 65022	1
Harmonic Balancer Repair Sleeve	1979-1982			Ground Steel, .020" Thickness 66597RS	1
				Use With Part Number A504 Nickel Plated Formed Steel, .013" Thickness A228	1

General Motors Corp.

77 267 CID (4.4L) L39 Chevrolet V8 Cyl, 3.500in./88.9mm (1979-1982) **77**
(cont.) (cont.)

Part	Year	VIN	Model/Application	Part Number	Qty.
MISCELLANEOUS GASKETS					
Air Cleaner Mount Gasket	1979-1982		2 Barrel Carburetor	G26906	1
Carb. Mount Gasket	1979-1982		2 Barrel Carburetor	G26693	1
Choke Tube Gasket	1979			B45784	1
Dist. Mounting Gasket	1979-1982			B25934	1
E.G.R. Gasket	1979-1982			G17797	1
Fuel Pump Gasket	1979-1982		Plate To Block	D25932	1
			Plate To Block	Tuff-Cork D25932TC	1
			Pump To Plate	D27094	1
			Pump To Plate	Tuff-Cork D27094TC	1
Oil Pan Drain Plug Gst.	1979-1982			2051	1
Oil Pump Shaft Retainer	1979-1982			H31354	1
Water Outlet Gasket	1979-1982		(Universal Type)	C24109	1
				C25930	1
Water Pump Backing Plate	1979-1982			K27091	1
Water Pump Mount Gasket	1979-1982			K25935	2

78 273 CID (4.5L) Cadillac V8 Cyl, 3.622in./92mm (1988-1992) **78**

Part	Year	VIN	Model/Application	Part Number	Qty.
ENGINE GASKETS					
Head Set	1989-1992	8	Allante, (Exhaust Pipe Gasket Not Included)	HS5781	1
	1990	3	Commercial Chassis, DeVille, Eldorado, Fleetwood, Seville, (Exhaust Pipe Gasket Not Included)	HS5781	1
	1988-1989	5	Commercial Chassis, DeVille, Eldorado, Fleetwood, Seville, (Exhaust Pipe Gasket Not Included)	HS5781W	1
Full Set	1989-1992	8	Allante, (Exhaust Pipe Gasket Not Included)	FS5781	1
	1990	3	Commercial Chassis, DeVille, Eldorado, Fleetwood, Seville, (Exhaust Pipe Gasket Not Included)	FS5781	1
	1988-1989	5	Commercial Chassis, DeVille, Eldorado, Fleetwood, Seville, (Exhaust Pipe Gasket Not Included)	FS5781W	1
Engine Kit Gasket Set	1989-1992	8		95-3170VR	1
	1990	3		95-3170VR	1
	1988-1989	5		95-3171VR	1
Cylinder Head Gasket	1988-1992		Nitroseal	5781G	2
Valve Cover Set	1989-1992		Allante, (Intake Manifold Seals Not Included) Victo-Tech	VS50116	1
			Allante, (Single Valve Cover, Intake Manifold Seals Not Included) Victo-Tech	VS50127	2
	1990		Commercial Chassis, DeVille, Eldorado, Fleetwood, Seville, (Intake Manifold Seals Not Included) Victo-Tech	VS50116	1
			Commercial Chassis, DeVille, Eldorado, Fleetwood, Seville, (Single Valve Cover, Intake Manifold Seals Not Included) Victo-Tech	VS50127	2
	1988-1989		Commercial Chassis, DeVille, Eldorado, Fleetwood, Seville, (Intake Manifold Seals Not Included) Victo-Tech	VS50018	1
		Commercial Chassis, DeVille, Eldorado, Fleetwood, Seville, (Single Valve Cover, Intake Manifold Seals Not Included) Victo-Tech	VS50124	2	
Valve Stem Seal, Exh.	1988-1992			B45770	8
Valve Stem Seal, Int.	1988-1992			B45770	8
Manifold Set, Exhaust	1988-1992			MS15680	1
Manifold Set, Intake	1989-1992		Allante, (Contains Plenum Chamber Gasket)	MS15667	1
	1990		Commercial Chassis, DeVille, Eldorado, Fleetwood, Seville, (Contains Plenum Chamber Gasket)	MS15667	1
	1988-1989		Commercial Chassis, DeVille, Eldorado, Fleetwood, Seville	MS15669	1
Plenum Chamber Gasket	1989-1992		Allante	MS15667A	1

PASSENGER CAR

78 273 CID (4.5L) Cadillac V8 Cyl, 3.622in./92mm (1988-1992) **78**
 (cont.) (cont.)

Part	Year	VIN	Model/Application	Part Number	Qty.
ENGINE GASKETS (cont.)					
Plenum Chamber Gasket (cont.)	1990		Commercial Chassis, DeVille, Eldorado, Fleetwood, Seville	MS15667A	1
Oil Pan Set	1988-1992		Tuff-Cork	OS32472TC	1
Rear Main Seal Set	1988-1992			JV557	1
Crank Repair Sleeve	1988-1992		Nickel Plated Formed Steel, .013" Thickness	A352	1
Timing Cover Set	1988-1992			JV1109	1
Timing Cover Seal	1988-1992			47937	1

MISCELLANEOUS GASKETS					
Air Cleaner Mount Gasket	1988-1992		Multi-Port Fuel Injection	G27098	1
E.G.R. Gasket	1988-1992			G17797	1
Exhaust Pipe Gasket	1989-1992	8	Allante, (Ring Type 'F'), Pipe To Manifold	F7520	1
	1990	3	Commercial Chassis, DeVille, Eldorado, Fleetwood, Seville, (Ring Type 'F'), Pipe To Manifold	F7520	1
	1989	5	Commercial Chassis, DeVille, Eldorado, Fleetwood, Seville, (Ring Type 'F'), Pipe To Manifold	F7210	1
	1988	5	Commercial Chassis, DeVille, Eldorado, Fleetwood, Seville, (Ring Type 'E'), Pipe To Manifold	F7271	1
Injector Nozzle O-Ring	1990-1992			GS33276	4
Manifold Seal, Intake	1988-1992			B45730	4
Thermostat Seal	1988-1992		Victo-Tech	C31200	1
Throttle Body Gasket	1990		Commercial Chassis, DeVille, Eldorado, Fleetwood, Seville	G31101	1
	1988-1989		Commercial Chassis, DeVille, Eldorado, Fleetwood, Seville	G31365	1
Water Inlet Gasket	1988-1992		Lower	C31328	1
Water Outlet Gasket	1988-1992			GS33253	1
		Lower		GS33271	1
Water Pump Mount Gasket	1988-1992			K31092	1

79 281 CID (4.6L) L37 Cadillac V8 Cyl, 3.661in./93mm (1993-2003) **79**

Part	Year	VIN	Model/Application	Part Number	Qty.
ENGINE GASKETS					
Cylinder Head Gasket	1993-2003		Left	Nitroseal 54356	1
			Right	Nitroseal 54357	1
Cyl. Head Bolt Set	2000-2003			GS33387	2
	1993-1999			GS33386	2
Valve Cover Set	2000-2003			VS50331	1
	1993-1999			VS50330	1
Oil Pan Set	1993-2003			OS32243	1

MISCELLANEOUS GASKETS					
E.G.R. Gasket	2000		Eldorado	C31200	1
	1993-1999			G31304	1
Exhaust Pipe Gasket	1996-2002		2" Pipe, Exhaust Pipe To Intermediate Pipe, Manifold To Exhaust Pipe	F7522	2
			1st Design, 2.225" Pipe, Manifold To Exhaust Pipe	F7515	1
	1993		2" Pipe, 2nd Design, Manifold To Exhaust Pipe	F7522	1
			Allante, 1st Design, 2.225" Pipe, Exhaust Pipe To Intermediate Pipe, Manifold To Exhaust Pipe	F7515	2
Oil Pan Drain Plug Gst.	1993-2002			B45828	1
Therm. Housing Gasket	1993-2002			C31200	1

PASSENGER CAR

General Motors Corp.

80 281 CID (4.6L) LD8 Cadillac V8 Cyl, 3.661in./93mm (1993-2003) 80

Part	Year	VIN	Model/Application	Part Number	Qty.
ENGINE GASKETS					
Cylinder Head Gasket	1993-2003		Left	<i>Nitroseal</i> 54356	1
			Right	<i>Nitroseal</i> 54357	1
Cyl. Head Bolt Set	2000-2003			GS33387	2
	1993-1999			GS33386	2
Valve Cover Set	2000-2003			VS50331	1
	1993-1999			VS50330	1
Oil Pan Set	1993-2003			OS32243	1

MISCELLANEOUS GASKETS					
E.G.R. Gasket	2000		Eldorado	C31200	1
	1993-1999			G31304	1
Exhaust Pipe Gasket	1996-2002		2" Pipe, Exhaust Pipe To Intermediate Pipe, Manifold To Exhaust Pipe	F7522	2
			1993-1995	1st Design, 2.225" Pipe, Manifold To Exhaust Pipe	F7515
			2" Pipe, 2nd Design, Manifold To Exhaust Pipe	F7522	1
Oil Pan Drain Plug Gst.	1993-2002			B45828	1
Therm. Housing Gasket	1993-2002			C31200	1

81 283 CID (4.6L) Chevrolet V8 Cyl, 3.875in./98.4mm (1957-1967) 81

Part	Year	VIN	Model/Application	Part Number	Qty.
ENGINE GASKETS					
Head Set	1957-1967		(Exhaust Pipe Gasket Not Included, Contains Beaded Steel Cylinder Head Gasket)	HS1178BJ	1
			(Exhaust Pipe Gasket Not Included, Contains VR2000 Cylinder Head Gasket)	HS1178VJ	1
Lower Set	1959-1967		(Requires Head Set To Make Full Set)	CS1178	1
	1957-1958		Requires Rear Main Seal, (Rear Main Seal Not Included, Requires Head Set To Make Full Set)	CS1178	1
Full Set	1959-1967		(Exhaust Pipe Gasket Not Included, Contains Beaded Steel Cylinder Head Gasket)	FS1178BJ	1
	1957-1967		(Exhaust Pipe Gasket Not Included, Contains VR2000 Cylinder Head Gasket)	FS1178VJ	1
	1957-1958		Requires Rear Main Seal, (Rear Main Seal Not Included, Exhaust Pipe Gasket Not Included, Contains Beaded Steel Cylinder Head Gasket)	FS1178BJ	1
Engine Kit Gasket Set	1959-1967			95-3033VR	1
	1957-1958		(Rear Main Seal Not Included), Use With Part Number JV688	95-3033VR	1
Cylinder Head Gasket	1957-1967		<i>Beaded Steel</i>	1178BS	2
			<i>Nitroseal, 4.160" Combustion Chamber Opening</i>	1178SG	2
			<i>VR2000</i>	1178VC	2
			<i>Nitroseal, 4.100" Combustion Chamber Opening</i>	54052	2
Cyl. Head Bolt Set	1957-1967			GS33285	2
Valve Cover Set	1957-1967		<i>Cork Rubber</i>	VS38110	1
			<i>High Temperature Cork Rubber</i>	VS38110HA	1
			<i>High Temperature Tuff-Cork</i>	VS38110HTC	1
			<i>Victo-Tech</i>	VS38110R	1
			<i>Tuff-Cork</i>	VS38110TC	1
Valve Stem Seal, Exh.	1957-1967		(O-Ring Type)	B45229	8
				B45264	8
			(High Temperature)	B45779	8
Valve Stem Seal, Int.	1957-1967		(O-Ring Type)	B45229	8
			<i>Fluoroelastomer</i>	B45418	8
Manifold Set, Exhaust	1957-1967			MS7110X	1
Manifold Set, Intake	1957-1967			MS15315	1
Oil Pan Set	1957-1967		<i>Cork Rubber</i>	OS30568X	1
			<i>Tuff-Cork</i>	OS30568XTC	1
Rear Main Seal Set	1959-1967		(Lip Relocator Type)	JV1627	1

81 283 CID (4.6L) Chevrolet V8 Cyl, 3.875in./98.4mm (1957-1967) **81**
(cont.) (cont.)

Part Year VIN Model/Application Part Number Qty.

ENGINE GASKETS (cont.)

Rear Main Seal Set (cont.)	1957-1958			JV688	1
Timing Cover Set	1957-1967		(Repair Sleeve Not Included)	JV779	1
			(Contains Repair Sleeve)	JV919	1
Timing Cover Gasket	1957-1967			T27781	1
Timing Cover Seal	1957-1967		3/8" Wide	49328	1
			(Lip Relocator Type) 1/2" Wide	65022	1
Harmonic Balancer Repair Sleeve	1957-1967		Ground Steel, .020" Thickness	66597RS	1
			Use With Part Number A504 Nickel Plated Formed Steel, .013" Thickness	A228	1

MISCELLANEOUS GASKETS

Air Cleaner Mount Gasket	1957-1967		2 Barrel Carburetor	G25936	1
			4 Barrel Carburetor	G27098	1
Carb. Mount Gasket	1957-1967		2 Barrel Carburetor	G12216	1
	1957-1961		4 Barrel Carburetor	G14116	1
			2-4 Barrel Carburetors	G14556	2
Dist. Mounting Gasket	1957-1967			B25934	1
Exhaust Pipe Gasket	1957-1967		2.5" Pipe, Crossover Pipe	F7139	2
			2" Pipe, (Ring Type 'C'), Crossover Pipe, Pipe To Manifold	F17250	2
			2" Pipe, (Ring Type 'B'), Pipe To Manifold <i>Sintered Metal</i>	F17250S	2
			1.875" Pipe, (Ring Type 'C'), Pipe To Manifold	F17355	1
Fuel Pump Gasket	1957-1967		Plate To Block	D25932	1
			Plate To Block <i>Tuff-Cork</i>	D25932TC	1
			Pump To Plate	D27094	1
			Pump To Plate <i>Tuff-Cork</i>	D27094TC	1
Heat Riser Gasket	1957-1967		3 Bolt <i>2.125" Inside Diameter</i>	F7135	1
			3 Bolt <i>2.437" Inside Diameter</i>	F7192	1
Oil Pan Drain Plug Gst.	1957-1967			2051	1
Water Outlet Gasket	1957-1967		(Universal Type)	C24109	1
				C25930	1
Water Pump Backing Plate	1957-1967			K27091	1
Water Pump Mount Gasket	1957-1967			K25935	2

82 300 CID (4.9L) Buick V8 Cyl, 3.750in./95.3mm (1964-1967) **82**

Part Year VIN Model/Application Part Number Qty.

ENGINE GASKETS

Head Set	1964-1967			HS3364BE	1
Full Set	1964-1967			FS3364BE	1
Cylinder Head Gasket	1964-1967		<i>Beaded Steel</i>	3364BS	2
Valve Cover Set	1964-1967		<i>Cork Rubber</i>	VS38312	1
Valve Stem Seal, Exh.	1965-1967			B45404	8
Valve Stem Seal, Int.	1965-1967			B45404	8
Manifold Set, Intake	1965-1967			MS15144	1
	1964			MS15120	1
Oil Pan Set	1964-1967		<i>Cork Rubber</i>	OS30669	1
Rear Main Seal Set	1964-1967			JV742	1
Timing Cover Set	1964-1967		(Contains Rope Packing)	JV844	1
			(Contains Superflex Seal)	JV1052SF	1
Timing Cover Gasket	1966-1967			T27960	1
Timing Cover Seal	1964-1967		(Superflex)	65025SF	1

General Motors Corp.

82 300 CID (4.9L) Buick V8 Cyl, 3.750in./95.3mm (1964-1967) **82**
 (cont.) (cont.)

Part	Year	VIN	Model/Application	Part Number	Qty.
MISCELLANEOUS GASKETS					
Air Cleaner Mount Gasket	1964-1967		2 Barrel Carburetor	G25936	1
	1964-1965		4 Barrel Carburetor	G26410	1
Carb. Mount Gasket	1965-1967		2 Barrel Carburetor	G7374	1
	1964-1965		4 Barrel Carburetor	G14553	1
	1964		2 Barrel Carburetor	G26576	1
Dist. Mounting Gasket	1964-1967			72215	1
Fuel Pump Gasket	1964-1967			D27094	1
				Tuff-Cork D27094TC	1
Therm. Housing Gasket	1964-1967			C26515	1
Water Outlet Gasket	1964-1967			C26515	1
Water Pump Mount Gasket	1964-1967			K27571	1

83 300 CID (4.9L) L26 Cadillac V8 Cyl, 3.622in./92mm (1991-1995) **83**

Part	Year	VIN	Model/Application	Part Number	Qty.
ENGINE GASKETS					
Head Set	1991-1995		(Exhaust Pipe Gasket Not Included)	HS5781	1
Full Set	1991-1995		(Exhaust Pipe Gasket Not Included)	FS5781	1
Engine Kit Gasket Set	1991-1992			95-3170VR	1
Cylinder Head Gasket	1991-1995		Nitroseal	5781G	2
Valve Cover Set	1991-1995		(Intake Manifold Seals Not Included) Victo-Tech	VS50116	1
			(Single Valve Cover, Intake Manifold Seals Not Included) Victo-Tech	VS50127	2
Valve Stem Seal, Exh.	1991-1995			B45770	8
Valve Stem Seal, Int.	1991-1995			B45770	8
Manifold Set, Exhaust	1991-1995			MS15680	1
Manifold Set, Intake	1991-1995		(Contains Plenum Chamber Gasket)	MS15667	1
Plenum Chamber Gasket	1991-1995			MS15667A	1
Oil Pan Set	1991-1995		Tuff-Cork	OS32472TC	1
Rear Main Seal Set	1991-1995			JV557	1
Crank Repair Sleeve	1991-1995		Nickel Plated Formed Steel, .013" Thickness	A352	1
Timing Cover Set	1991-1995			JV1109	1
Timing Cover Seal	1991-1995			47937	1

MISCELLANEOUS GASKETS					
Air Cleaner Mount Gasket	1991-1993		Multi-Port Fuel Injection	G31176	1
E.G.R. Gasket	1991-1995			G17797	1
Exhaust Pipe Gasket	1994-1995		(Ring Type 'F'), Pipe To Manifold	F7520	1
	1991-1993		(Ring Type 'E'), Pipe To Manifold	F7521	1
Injector Nozzle O-Ring	1991-1995			GS33276	4
Manifold Seal, Intake	1991-1995		(Not Contained In Valve Cover Set)	B45730	4
Oil Pan Drain Plug Gst.	1991-1995			2051	1
Thermostat Seal	1991-1992		Victo-Tech	C31200	1
Throttle Body Gasket	1991-1995			G31101	1
Water Inlet Gasket	1991-1995		Lower	C31328	1
Water Outlet Gasket	1991-1995			GS33253	1
			Lower	GS33271	1
Water Pump Mount Gasket	1991-1995			K31092	1

84 301 CID (4.9L) Pontiac V8 Cyl, 4.000in./101.6mm (1977-1981) 84

Part	Year	VIN	Model/Application	Part Number	Qty.
ENGINE GASKETS					
Head Set	1980-1981		(Exhaust Pipe Gasket Not Included), Turbocharged	HS3539T	1
	1977-1981		Naturally Aspirated	HS3539	1
Full Set	1980-1981		(Exhaust Pipe Gasket Not Included), Turbocharged	FS3539T	1
	1977-1981		Naturally Aspirated	FS3539	1
Engine Kit Gasket Set	1980-1981		Turbocharged, (Exhaust Manifold Gasket Not Included), Turbocharged, Use With Part Number MS15217T	95-3048VR	1
	1977-1981		Naturally Aspirated	95-3048VR	1
Cylinder Head Gasket	1980-1981		Turbocharged Nitroseal	3539TG	2
	1977-1981		Naturally Aspirated VR2000	3539	2
Valve Cover Set	1977-1981		Cork Rubber	VS38291X	1
			High Temperature Cork Rubber	VS38291XH	1
Valve Stem Seal, Exh.	1977-1981		(O-Ring Type)	B45229	8
Valve Stem Seal, Int.	1977-1981		(O-Ring Type)	B45229	8
			Fluoroelastomer	B45418	8
Manifold Set, Exhaust	1980-1981		Turbocharged Nitroseal	MS15217T	1
	1977-1981		Naturally Aspirated	MS15217	1
Manifold Set, Intake	1977-1981			MS15216	1
Oil Pan Set	1977-1981		Cork Rubber	OS20491	1
			Tuff-Cork	OS20491TC	1
Rear Main Seal Set	1977-1981			JV708	1
Timing Cover Set	1977-1981		(Repair Sleeve Not Included)	JV877	1
			(Contains Repair Sleeve)	JV920	1
Timing Cover Gasket	1977-1981			T27812	1
Harmonic Balancer Repair Sleeve	1977-1981		Use With Part Number A502 Nickel Plated Formed Steel, .013" Thickness	A229-1	1
MISCELLANEOUS GASKETS					
Air Cleaner Mount Gasket	1978-1981		4 Barrel Carburetor	G27098	1
	1977-1979		2 Barrel Carburetor	G26906	1
Carb. Mount Gasket	1980-1981	T	4 Barrel Carburetor, Turbocharged, Carburetor Plenum	G26919	1
		T	4 Barrel Carburetor, Turbocharged, Plenum To Manifold	G26992	1
	1978-1981	W	Carburetor To Adapter	G26695	1
		W	4 Barrel Carburetor, Naturally Aspirated, Adapter To Manifold	G26992	1
	1978-1979	Y	Carburetor To Adapter	G26775	1
		Y	Adapter To Manifold	G26954	1
Choke Tube Gasket	1979			B45822	1
	1977			B45819	1
Dist. Mounting Gasket	1977-1981			B25941	1
E.G.R. Gasket	1977-1981			G17797	1
Exhaust Pipe Gasket	1980-1981	T	(Ring Type 'E'), Exhaust Pipe To Turbocharger Outlet	F7207	1
		T	(Ring Type 'D'), Pipe To Manifold	F7208	1
		T	(Ring Type 'D'), Turbocharger Crossover To Manifold	F7218	1
Fuel Pump Gasket	1977-1981			D27094	1
				Tuff-Cork D27094TC	1
Oil Pan Drain Plug Gst.	1977-1981			2051	1
Oil Pump Mounting Gasket	1977			B25941	1
Push Rod Cover Set	1977-1981		Cork Rubber	PS38786	1
Turbo Gasket	1980-1981	T	Drain Connector	G26902	1
		T	Plenum To Turbo	G26920	1
Water Outlet Gasket	1977-1981			C24109	1
Water Pump Mount Gasket	1977-1981			K27149	2
Water Pump Tube Seal	1977-1981			B45687	2

PASSENGER CAR

General Motors Corp.

85 302 CID (5.0L) Chevrolet V8 Cyl, 4.000in./101.6mm (1967-1969)

85

Part	Year	VIN	Model/Application	Part Number	Qty.
ENGINE GASKETS					
Head Set	1968-1969		(Head Bolts Not Included, Exhaust Pipe Gasket Not Included, Contains Beaded Steel Cylinder Head Gasket)	HS1178BJ	1
			(Head Bolts Not Included, Exhaust Pipe Gasket Not Included, Contains VR2000 Cylinder Head Gasket)	HS1178VJ	1
Lower Set	1968-1969		(Requires Head Set To Make Full Set)	CS1178	1
Full Set	1968-1969		(Head Bolts Not Included, Exhaust Pipe Gasket Not Included, Contains Beaded Steel Cylinder Head Gasket)	FS1178BJ	1
			(Head Bolts Not Included, Exhaust Pipe Gasket Not Included, Contains VR2000 Cylinder Head Gasket)	FS1178VJ	1
Engine Kit Gasket Set	1967-1969			95-3033VR	1
Cylinder Head Gasket	1968-1969		<i>Beaded Steel</i>	1178BS	2
			Contoured Combustion Chamber <i>Nitroseal, 4.160" Combustion Chamber Opening</i>	1178SG	2
			<i>VR2000</i>	1178VC	2
			Cylindrical Combustion Chamber <i>Nitroseal</i>	3432SG	2
			Contoured Combustion Chamber <i>Nitroseal, 4.100" Combustion Chamber Opening</i>	54052	2
		1967-1969	(Cylindrical Combustion Chamber Openings, Gasket Has Steam Holes Required For Street Operation) <i>Stainless Steel, 8.8cc Combustion Chamber Volume, 4.190" Combustion Chamber Opening, .040" Compressed Operating Thickness</i>	3512	2
Cyl. Head Bolt Set	1968-1969			GS33285	2
Valve Cover Set	1968-1969		<i>Cork Rubber</i>	VS38110	1
			<i>High Temperature Cork Rubber</i>	VS38110HA	1
			<i>High Temperature Tuff-Cork</i>	VS38110HTC	1
			<i>Victo-Tech</i>	VS38110R	1
			<i>Tuff-Cork</i>	VS38110TC	1
Valve Stem Seal, Exh.	1968-1969		(O-Ring Type)	B45229	8
				B45264	8
			(High Temperature)	B45779	8
Valve Stem Seal, Int.	1968-1969		(O-Ring Type)	B45229	8
			<i>Fluoroelastomer</i>	B45418	8
Manifold Set, Exhaust	1968-1969			MS7110X	1
Manifold Set, Intake	1968-1969			MS15315	1
Oil Pan Set	1968-1969		<i>Cork Rubber</i>	OS30568X	1
			<i>Tuff-Cork</i>	OS30568XTC	1
Rear Main Seal Set	1968-1969		(Lip Relocator Type)	JV1627	1
Timing Cover Set	1968-1969		(Repair Sleeve Not Included)	JV779	1
			(Contains Repair Sleeve)	JV919	1
Timing Cover Gasket	1968-1969			T27781	1
Timing Cover Seal	1968-1969		<i>3/8" Wide</i>	49328	1
			(Lip Relocator Type) <i>1/2" Wide</i>	65022	1
Harmonic Balancer Repair Sleeve	1968-1969		<i>Ground Steel, .020" Thickness</i>	66597RS	1
			Use With Part Number A504 <i>Nickel Plated Formed Steel, .013" Thickness</i>	A228	1
MISCELLANEOUS GASKETS					
Air Cleaner Mount Gasket	1968-1969		4 Barrel Carburetor	G27098	1
Carb. Mount Gasket	1968-1969		4 Barrel Carburetor	G14733	1
Dist. Mounting Gasket	1968-1969			B25934	1
Exhaust Pipe Gasket	1968-1969		(Flange Type), Pipe To Manifold	F7135	1
Fuel Pump Gasket	1968-1969		Plate To Block	D25932	1
			Plate To Block <i>Tuff-Cork</i>	D25932TC	1
			Pump To Plate	D27094	1
			Pump To Plate <i>Tuff-Cork</i>	D27094TC	1
Oil Pan Drain Plug Gst.	1968-1969			2051	1
Water Outlet Gasket	1968-1969		(Universal Type)	C24109	1

85 <small>(cont.)</small>	302 CID (5.0L) Chevrolet V8 Cyl, 4.000in./101.6mm (1967-1969)	85 <small>(cont.)</small>
-------------------------------------	--	-------------------------------------

Part	Year	VIN	Model/Application	Part Number	Qty.
MISCELLANEOUS GASKETS (cont.)					
Water Outlet Gasket (cont.)	1968-1969			C25930	1
Water Pump Backing Plate	1968-1969			K27091	1
Water Pump Mount Gasket	1968-1969			K25935	2

86	305 CID (5.0L) Chevrolet V8 Cyl, 3.736in./95mm (1976-1993)	86
-----------	---	-----------

Part	Year	VIN	Model/Application	Part Number	Qty.	
ENGINE GASKETS						
Head Set	1988-1993	E	(Head Bolts Not Included)	HS3514VN	1	
	1988-1992	E	(Head Bolts Not Included, Contains Graphite Head Gasket)	HS5745W	1	
	1987-1992	F	(Head Bolts Not Included)	HS3514VP	1	
	1988			(Head Bolts Not Included)	HS3514VN	1
				(Head Bolts Not Included, Contains Graphite Head Gasket)	HS5745W	1
	1987-1988	G, H		(Head Bolts Not Included)	HS3514VN	1
		G, H		(Head Bolts Not Included, Contains Graphite Head Gasket)	HS5745W	1
	1986	G, H		(Head Bolts Not Included)	HS3514VL	1
		G, H		(Head Bolts Not Included, Contains Graphite Head Gasket)	HS5745	1
	1985-1986	F		(Head Bolts Not Included)	HS3514VQ	1
	1984-1985	G		(Head Bolts Not Included)	HS3514VK	1
	1980-1985	H		(Head Bolts Not Included)	HS3514VK	1
	1983	S		Crossfire Fuel Injection, (Head Bolts Not Included, Intake Manifold Gasket Not Included)	HS3514VK	1
	1982-1983	7		Crossfire Fuel Injection, (Head Bolts Not Included, Intake Manifold Gasket Not Included)	HS3514VK	1
	1979	G		(Head Bolts Not Included)	HS3514VJ	1
	1978-1979	H		(Head Bolts Not Included)	HS3514VJ	1
	1977-1979	U		(Head Bolts Not Included)	HS3514VJ	1
1977			(Head Bolts Not Included)	HS3514VJ	1	
1976	Q		(Head Bolts Not Included)	HS3514VJ	1	
Lower Set	1986-1993		(Requires Head Set To Make Full Set)	CS1178A	1	
	1976-1985		(Requires Head Set To Make Full Set)	CS1178	1	
Full Set	1988-1993	E	(Head Bolts Not Included)	FS3514VN	1	
	1987-1992	F	(Head Bolts Not Included)	FS3514VP	1	
	1988		(Head Bolts Not Included)	FS3514VN	1	
	1987-1988	G, H	(Head Bolts Not Included)	FS3514VN	1	
	1986	G, H		(Head Bolts Not Included, 4 Piece Oil Pan Set Not Included)	FS3514VL	1
		F		(Head Bolts Not Included, 4 Piece Oil Pan Set Not Included)	FS3514VQ	1
	1985	F	(Head Bolts Not Included)	FS3514VR	1	
	1984-1985	G	(Head Bolts Not Included)	FS3514VK	1	
	1980-1985	H	(Head Bolts Not Included)	FS3514VK	1	
	1983	S		Crossfire Fuel Injection, (Head Bolts Not Included, Intake Manifold Gasket Not Included)	FS3514VK	1
	1982-1983	7		Crossfire Fuel Injection, (Head Bolts Not Included, Intake Manifold Gasket Not Included)	FS3514VK	1
	1979	G		(Head Bolts Not Included)	FS3514VJ	1
	1978-1979	H		(Head Bolts Not Included)	FS3514VJ	1
	1977-1979	U		(Head Bolts Not Included)	FS3514VJ	1
	1977			(Head Bolts Not Included)	FS3514VJ	1
	1976	Q		(Head Bolts Not Included)	FS3514VJ	1
	Engine Kit Gasket Set	1987-1993		4 Barrel Carburetor, Throttle Body Injection	95-3412VR	1
F			Tuned Port Fuel Injection, (Intake Manifold Gasket Not Included), Use With Part Number MS15315W	95-3412VR	1	
1986			4 Barrel Carburetor	95-3443VR	1	
		F	Tuned Port Fuel Injection, (Intake Manifold Gasket Not Included), Use With Part Number MS15315W	95-3443VR	1	

General Motors Corp.

86 305 CID (5.0L) Chevrolet V8 Cyl, 3.736in./95mm (1976-1993) **86**
 (cont.) (cont.)

Part	Year	VIN	Model/Application	Part Number	Qty.
ENGINE GASKETS (cont.)					
Engine Kit Gasket Set (cont.)	1985	F	Tuned Port Fuel Injection, (Intake Manifold Gasket Not Included), Use With Part Number MS15315W	95-3071VR	1
	1981-1985		2 Barrel Carburetor, 4 Barrel Carburetor	95-3071VR	1
	1983	S	Crossfire Fuel Injection, (Intake Manifold Gasket Not Included), Use With Part Number MS15315BF	95-3071VR	1
	1982	7	Crossfire Fuel Injection, (Intake Manifold Gasket Not Included), Use With Part Number MS15315BF	95-3071VR	1
	1976-1980			95-3045VR	1
Cylinder Head Gasket	1976-1993		Nitroseal	3514SG	2
			VR2000	3514VC	2
			(Single Sided Graphite) Nitroseal	5745	2
Cyl. Head Bolt Set	1976-1993			GS33285	2
Valve Cover Set	1987-1993		Tuff-Cork	VS50025TC	1
			(Single Valve Cover) Tuff-Cork	VS50126TC	2
			Victo-Tech	VS50161	1
			(Single Valve Cover) Victo-Tech	VS50163	2
	1976-1986		Cork Rubber	VS38110	1
			High Temperature Cork Rubber, 5/16" Thickness	VS38110H	1
			High Temperature Cork Rubber	VS38110HA	1
			High Temperature Tuff-Cork	VS38110HTC	1
			Victo-Tech	VS38110R	1
			Tuff-Cork	VS38110TC	1
Valve Stem Seal, Exh.	1976-1993		(O-Ring Type)	B45229	8
				B45264	8
			(High Temperature)	B45779	8
Valve Stem Seal, Int.	1976-1993		(O-Ring Type)	B45229	8
			Fluoroelastomer	B45418	8
Manifold Set, Exhaust	1976-1993			MS7110X	1
Manifold Set, Intake	1987-1993		Throttle Body Injection	MS15401	1
	1985-1992		(Contains Plenum Chamber Gasket), Multi-Port Fuel Injection	MS15315W	1
	1976-1986		Except Fuel Injection	MS15315	1
	1976-1985		Liquid Propane Gas	MS15219BF	1
	1983	S	Crossfire Fuel Injection	MS15315BF	1
	1982	7	Crossfire Fuel Injection	MS15315BF	1
Plenum Chamber Gasket	1985-1992	F		MS12343	1
Oil Pan Set	1986-1993		Victo-Tech	OS32496	1
			(Original Equipment Style Steel Backbone) Victo-Tech	OS32496B	1
	1986-1987		Tuff-Cork	OS32471TC	1
	1986		4 Piece Oil Pan Gasket Cork Rubber	OS30568Z	1
	1980-1985		Right Hand Dip Stick Victo-Tech	OS30568RRH	1
				Tuff-Cork	OS30572TC
	1976-1985		Cork Rubber	OS30568Z	1
	1976-1979		Left Hand Dip Stick Victo-Tech	OS30568RLH	1
			Tuff-Cork	OS30568ZTC	1
Rear Main Seal Set	1986-1993		(1 Piece)	JV554	1
			(1 Piece) Teflon	JV1634	1
	1976-1985		(2 Piece, Lip Relocator Type)	JV1627	1
Crank Repair Sleeve	1986-1993		Use With Part Number A506 Nickel Plated Formed Steel, .013" Thickness	A338	1
	1986		Use With Part Number A506, Rear Nickel Plated Formed Steel, .013" Thickness	A338	1
Seal Extender	1986-1993		1 Piece Rear Main Seal	E300	1
Timing Cover Set	1987-1993		(Repair Sleeve Not Included)	JV1041	1
	1986		4 Piece Oil Pan Gasket, (Repair Sleeve Not Included)	JV881	1
			4 Piece Oil Pan Gasket, (Contains Repair Sleeve)	JV926	1

Part	Year	VIN	Model/Application	Part Number	Qty.	
ENGINE GASKETS (cont.)						
Timing Cover Set (cont.)	1986		Except 4 Piece Oil Pan Gasket, (Repair Sleeve Not Included)	JV1041	1	
	1976-1985		(Repair Sleeve Not Included)	JV881	1	
			(Optional, Repair Sleeve Not Included)	<i>Tuff-Cork</i> JV881TC	1	
			(Contains Repair Sleeve)	JV926	1	
Timing Cover Gasket	1976-1993			T27781	1	
Timing Cover Seal	1976-1993		<i>3/8" Wide</i>	49328	1	
			(Lip Relocator Type) <i>1/2" Wide</i>	65022	1	
Harmonic Balancer Repair Sleeve	1976-1993		<i>Ground Steel, .020" Thickness</i>	66597RS	1	
			Use With Part Number A504 <i>Nickel Plated Formed Steel, .013" Thickness</i>	A228	1	
MISCELLANEOUS GASKETS						
Air Cleaner Mount Gasket	1985-1993		4 Barrel Carburetor, Throttle Body Injection	G27098	1	
	1988		4 Barrel Carburetor	G27098	1	
	1978-1988		4 Barrel Carburetor, 4 Barrel Carburetor	G27098	1	
	1982-1983		Crossfire Fuel Injection	G26803	2	
	1979-1981		2 Barrel Carburetor	G26906	1	
	1976-1978		2 Barrel Carburetor	G26617	1	
Carb. Mount Gasket	1988			G26792	1	
	1981-1988		4 Barrel Carburetor	G26792	1	
	1978-1980		4 Barrel Carburetor	G26719	1	
	1979		2 Barrel Carburetor	G26693	1	
	1976-1978		2 Barrel Carburetor	G26711	1	
Choke Tube Gasket	1979		2 Barrel Carburetor	B45784	1	
			4 Barrel Carburetor	B45787	1	
	1978-1979		2 Barrel Carburetor, 4 Barrel Carburetor, 4 Barrel Carburetor	B45787	1	
	1976-1978		2 Barrel Carburetor, 4 Barrel Carburetor	B45787	1	
Dist. Mounting Gasket	1976-1993			B25934	1	
E.G.R. Gasket	1991-1993	E		G31178	1	
	1991-1992	F		G17797	1	
	1988-1990	E	Camaro, Caprice, Firebird, 2 Bolt Triangular Pattern	G26748	2	
	1985-1990	F	Camaro, Firebird, 2 Bolt Triangular Pattern	G26748	2	
	1988		2 Bolt Triangular Pattern	G26748	2	
	1987-1988	H	Corvette, Monte Carlo, 2 Bolt Triangular Pattern	G26748	2	
	1984-1988	G	Camaro, 2 Bolt Triangular Pattern	G26748	2	
	1980-1988	H	Camaro, Caprice, 2 Bolt Triangular Pattern	G26748	2	
	1984-1987	G	Monte Carlo, 2 Bolt Triangular Pattern	G26748	2	
	1983-1987	H	Grand Prix, 2 Bolt Triangular Pattern	G26748	2	
	1980-1987	H	Camaro, Firebird, 2 Bolt Triangular Pattern	G26748	2	
	1978-1987	H	Regal, 2 Bolt Triangular Pattern	G26748	2	
	1984-1986	G	Firebird, 2 Bolt Triangular Pattern	G26748	2	
	1983-1986	H	Parisienne, 2 Bolt Triangular Pattern	G26748	2	
	1981-1986	H	Bonneville, 2 Bolt Triangular Pattern	G26748	2	
	1980-1986	H	Firebird, 2 Bolt Triangular Pattern	G26748	2	
	1978-1986	H	Monte Carlo, 2 Bolt Triangular Pattern	G26748	2	
	1980-1985	H	Impala, 2 Bolt Triangular Pattern	G26748	2	
	1984	H	Eldorado, 2 Bolt Triangular Pattern	G26748	2	
	1983	7		Monte Carlo, 2 Bolt Triangular Pattern	G26748	2
		7, S		Camaro, 2 Bolt Triangular Pattern	G26748	2
		S		Firebird, 2 Bolt Triangular Pattern	G26748	2
	1982-1983	7		Firebird, 2 Bolt Triangular Pattern	G26748	2
	1978-1983	H		Malibu, 2 Bolt Triangular Pattern	G26748	2
	1982	7		Camaro, 2 Bolt Triangular Pattern	G26748	2
	1980-1981	H		Laurentian, 2 Bolt Triangular Pattern	G26748	2
	1978-1981	H		Century, Cutlass, LeMans, 2 Bolt Triangular Pattern	G26748	2

General Motors Corp.

86 305 CID (5.0L) Chevrolet V8 Cyl, 3.736in./95mm (1976-1993) **86**
(cont.) (cont.)

Part	Year	VIN	Model/Application	Part Number	Qty.	
MISCELLANEOUS GASKETS (cont.)						
E.G.R. Gasket (cont.)	1980	H	Grand Prix, 2 Bolt Triangular Pattern	G26748	2	
	1979-1980	H	Grand Am, 2 Bolt Triangular Pattern	G26748	2	
	1978-1980	H	Cutlass Salon, Cutlass Supreme, 2 Bolt Triangular Pattern	G26748	2	
	1979	H		Camaro, Caprice, Corvette, Grand Prix, Impala, 2 Bolt In-Line Pattern	G17797	1
				Camaro, Caprice, Laurentian, Monza, Nova, Omega, Skylark, Starfire, 2 Bolt In-Line Pattern	G17797	1
				Firebird, Phoenix, Sunbird, 2 Bolt In-Line Pattern	G17797	1
	1978	U		Cutlass, Cutlass Salon, Cutlass Supreme, Grand Am, Grand Prix, Laurentian, LeMans, Malibu, Sunbird, 2 Bolt Triangular Pattern	G26748	2
				Camaro, Caprice, Impala, 2 Bolt Triangular Pattern	G26748	2
	1977-1978	U		Camaro, Caprice, Century, Firebird, Impala, Le Sabre, Monte Carlo, Monza, Nova, Omega, Phoenix, Regal, Riviera, Skylark, Starfire, 2 Bolt Triangular Pattern	G26748	2
				Laurentian, 2 Bolt Triangular Pattern	G26748	2
	1977	U		Catalina, Chevelle, Ventura, 2 Bolt Triangular Pattern	G26748	2
				Camaro, Chevelle, Monte Carlo, Monza, Nova, 2 Bolt Triangular Pattern	G26748	2
Exhaust Pipe Gasket	1976-1979		(Ring Type 'C'), Pipe To Manifold	F17250	1	
			(Ring Type 'B'), Pipe To Manifold <i>Sintered Metal</i>	F17250S	1	
Fuel Pump Gasket	1976-1993		Plate To Block	D25932	1	
			Plate To Block <i>Tuff-Cork</i>	D25932TC	1	
			Pump To Plate	D27094	1	
			Pump To Plate <i>Tuff-Cork</i>	D27094TC	1	
Injector Nozzle O-Ring	1985-1993		Multi-Port Fuel Injection	GS33276	4	
Oil Pan Drain Plug Gst.	1976-1993			2051	1	
Oil Pump Shaft Retainer	1976-1993			H31354	1	
Plenum Tube	1985-1992			MS12343A	1	
Throttle Body Gasket	1990-1993	E		G31133	1	
	1989-1992	F		G31413	1	
	1988-1989	E		G30948	1	
	1985-1988	F		G30828	1	
	1983	S	Crossfire Fuel Injection	G31538	2	
	1982	7	Crossfire Fuel Injection	G31538	2	
Water Outlet Gasket	1976-1993		(Universal Type)	C24109	1	
				C25930	1	
Water Pump Backing Plate	1976-1993			K27091	1	
Water Pump Mount Gasket	1976-1993			K25935	2	

87 307 CID (5.0L) Chevrolet V8 Cyl, 3.875in./98.4mm (1968-1973) **87**

Part	Year	VIN	Model/Application	Part Number	Qty.
ENGINE GASKETS					
Head Set	1968-1973		(Head Bolts Not Included, Exhaust Pipe Gasket Not Included, Contains Beaded Steel Cylinder Head Gasket)	HS1178BJ	1
			(Head Bolts Not Included, Exhaust Pipe Gasket Not Included, Contains VR2000 Cylinder Head Gasket)	HS1178VJ	1
Lower Set	1968-1973		(Requires Head Set To Make Full Set)	CS1178	1
Full Set	1968-1973		(Head Bolts Not Included, Exhaust Pipe Gasket Not Included, Contains Beaded Steel Cylinder Head Gasket)	FS1178BJ	1
			(Head Bolts Not Included, Exhaust Pipe Gasket Not Included, Contains VR2000 Cylinder Head Gasket)	FS1178VJ	1
Engine Kit Gasket Set	1968-1973			95-3033VR	1
Cylinder Head Gasket	1968-1973		<i>Beaded Steel</i>	1178BS	2
			<i>Nitroseal, 4.160" Combustion Chamber Opening</i>	1178SG	2

PASSENGER CAR

87 (cont.)	307 CID (5.0L) Chevrolet V8 Cyl, 3.875in./98.4mm (1968-1973)				87 (cont.)
---------------	--	--	--	--	---------------

Part	Year	VIN	Model/Application	Part Number	Qty.
------	------	-----	-------------------	-------------	------

ENGINE GASKETS (cont.)

Cylinder Head Gasket (cont.)	1968-1973		<i>VR2000</i>	1178VC	2
			<i>Nitroseat, 4.100" Combustion Chamber Opening</i>	54052	2
Cyl. Head Bolt Set	1968-1973			GS33285	2
Valve Cover Set	1968-1973		<i>Cork Rubber</i>	VS38110	1
			<i>High Temperature Cork Rubber</i>	VS38110HA	1
			<i>High Temperature Tuff-Cork</i>	VS38110HTC	1
			<i>Victo-Tech</i>	VS38110R	1
			<i>Tuff-Cork</i>	VS38110TC	1
Valve Stem Seal, Exh.	1968-1973	(O-Ring Type)		B45229	8
		(Shedder Type)		B45264	8
		(High Temperature)		B45779	8
Valve Stem Seal, Int.	1968-1973	(O-Ring Type)		B45229	8
		(Positive Type)	<i>Fluoroelastomer</i>	B45418	8
Manifold Set, Exhaust	1968-1973			MS7110X	1
Manifold Set, Intake	1968-1973			MS15315	1
Oil Pan Set	1968-1973		<i>Cork Rubber</i>	OS30568X	1
			<i>Tuff-Cork</i>	OS30568XTC	1
Rear Main Seal Set	1968-1973	(Lip Relocator Type)		JV1627	1
Timing Cover Set	1968-1973	(Repair Sleeve Not Included)		JV779	1
		(Contains Repair Sleeve)		JV919	1
Timing Cover Gasket	1968-1973			T27781	1
Timing Cover Seal	1968-1973		<i>3/8" Wide</i>	49328	1
		(Lip Relocator Type)	<i>1/2" Wide</i>	65022	1
Harmonic Balancer Repair Sleeve	1968-1973		<i>Ground Steel, .020" Thickness</i>	66597RS	1
			<i>Use With Part Number A504 Nickel Plated Formed Steel, .013" Thickness</i>	A228	1

MISCELLANEOUS GASKETS

Air Cleaner Mount Gasket	1968-1973		2 Barrel Carburetor	G25936	1
Carb. Mount Gasket	1970		Except Emission Pump	G12216	1
	1968-1970		Except Emission Pump, 2 Barrel Carburetor	G12216	1
	1968-1969		2 Barrel Carburetor	G12216	1
Dist. Mounting Gasket	1968-1973			B25934	1
Exhaust Pipe Gasket	1968-1973		2.5" Pipe, (Ring Type 'C'), Pipe To Manifold	F7139	2
			2.5" Pipe, (Ring Type 'B'), Pipe To Manifold <i>Sintered Metal</i>	F7139S	1
			2" Pipe, (Ring Type 'C'), Pipe To Manifold	F17250	1
			2" Pipe, (Ring Type 'B'), Pipe To Manifold <i>Sintered Metal</i>	F17250S	1
			1.875" Pipe, (Ring Type 'E'), Pipe To Manifold	F17355	1
Fuel Pump Gasket	1968-1973		Plate To Block	D25932	1
			Plate To Block <i>Tuff-Cork</i>	D25932TC	1
			Pump To Plate	D27094	1
			Pump To Plate <i>Tuff-Cork</i>	D27094TC	1
Heat Riser Gasket	1968-1973		3 Bolt <i>2.125" Inside Diameter</i>	F7135	1
			3 Bolt <i>2.437" Inside Diameter</i>	F7192	1
Oil Pan Drain Plug Gst.	1968-1973			2051	1
Water Outlet Gasket	1968-1973	(Universal Type)		C24109	1
				C25930	1
Water Pump Backing Plate	1968-1973			K27091	1
Water Pump Mount Gasket	1968-1973			K25935	2

General Motors Corp.

88 307 CID (5.0L) Oldsmobile V8 Cyl, 3.800in./96.5mm (1980-1990)

88

Part	Year	VIN	Model/Application	Part Number	Qty.
ENGINE GASKETS					
Head Set	1985-1990		(Exhaust Pipe Gasket Not Included, Intake Manifold Gasket Not Included, Exhaust Manifold Gasket With 1-9/16" X 2-1/8" End Ports Not Included)	HS3680W	1
	1980-1984		(Exhaust Pipe Gasket Not Included, Intake Manifold Gasket Not Included)	HS3680	1
Full Set	1985-1990		(Exhaust Pipe Gasket Not Included, Intake Manifold Gasket Not Included, Exhaust Manifold Gasket With 1-9/16" X 2-1/8" End Ports Not Included)	FS3680W	1
	1980-1984		(Exhaust Pipe Gasket Not Included, Intake Manifold Gasket Not Included)	FS3680	1
Engine Kit Gasket Set	1985-1990		(Intake Manifold Gasket Not Included, Exhaust Manifold Gasket With 1-9/16" X 2-1/8" End Ports Not Included), Use With Part Numbers MS15966, MS15425	95-3408VR	1
	1980-1984		(Intake Manifold Gasket Not Included), Use With Part Number MS15932	95-3403VR	1
Cylinder Head Gasket	1980-1990		VR2000	3680	2
Valve Cover Set	1980-1990		Cork Rubber	VS38305	1
			High Temperature Cork Rubber	VS38305H	1
			Victo-Tech, 3/32"	VS38305R	1
			Victo-Tech, 11/64"	VS38305RT	1
			Tuff-Cork	VS38305TC	1
Valve Stem Seal, Exh.	1980-1990			B45416	8
Valve Stem Seal, Int.	1980-1990			B45416	8
Manifold Set, Exhaust	1985-1990		Except Gaskets With 1.76" X 1.83" End Ports	MS15141	1
			1.76" X 1.83" End Ports	MS15425	1
	1980-1984			MS15141	1
Manifold Set, Intake	1985-1990			MS15966	1
	1980-1984			MS15932	1
Oil Pan Set	1980-1990		Cork Rubber	OS30534	1
			Tuff-Cork	OS30534TC	1
Rear Main Seal Set	1980-1990		Molded Rubber	JV748	1
			Rope Packing	JV749	1
Timing Cover Set	1980-1990		(Repair Sleeve Not Included)	JV845	1
			(Contains Repair Sleeve)	JV927	1
Timing Cover Gasket	1980-1990			T27823	1
Timing Cover Seal	1980-1990			47398	1
Harmonic Balancer Repair Sleeve	1980-1990		Ground Steel, .020" Thickness	66590RS	1
			Use With Part Number A500 Nickel Plated Formed Steel, .013" Thickness	A222	1
MISCELLANEOUS GASKETS					
Air Cleaner Mount Gasket	1980-1990		4 Barrel Carburetor	G27098	1
Carb. Mount Gasket	1980-1990		4 Barrel Carburetor	G26723	1
Choke Tube Gasket	1980-1990			B45786	1
Dist. Mounting Gasket	1980-1990			72219	1
E.G.R. Gasket	1980-1990			G17797	1
Exhaust Pipe Gasket	1986-1990		Fleetwood, (Ring Type 'E'), Pipe To Manifold	F7207	1
	1985-1990		Caprice, Custom Cruiser, Ninety Eight, (Ring Type 'E'), Pipe To Manifold	F7207	1
	1981-1990		Le Sabre, (Ring Type 'E'), Pipe To Manifold	F7207	1
	1987-1989		Safari, (Ring Type 'E'), Pipe To Manifold	F7207	1
	1985-1988		Cutlass Supreme, (Ring Type 'E'), Pipe To Manifold	F7207	1
	1985-1987		Bonneville, Regal, (Ring Type 'E'), Pipe To Manifold	F7207	1
	1986		Electra Estate Wagon, Parisienne, (Ring Type 'E'), Pipe To Manifold	F7207	1
	1985-1986		Monte Carlo, (Ring Type 'E'), Pipe To Manifold	F7207	1
	1985		Delta 88 Royale, Riviera, Toronado, (Ring Type 'E'), Pipe To Manifold	F7207	1
	1984		Regency, (Ring Type 'E'), Pipe To Manifold	F7207	1

PASSENGER CAR

88 307 CID (5.0L) Oldsmobile V8 Cyl, 3.800in./96.5mm (1980-1990) **88**
(cont.) (cont.)

Part	Year	VIN	Model/Application	Part Number	Qty.
MISCELLANEOUS GASKETS (cont.)					
Exhaust Pipe Gasket (cont.)	1980-1984		Cutlass, (Ring Type 'E'), Pipe To Manifold	F7207	1
			Toronado, (Ring Type 'D'), Pipe To Manifold	F7208	1
	1981		Electra Estate Wagon, Laurentian, (Ring Type 'E'), Pipe To Manifold	F7207	1
	1980-1981		Catalina, Delta 88, Ninety Eight, Riviera, (Ring Type 'E'), Pipe To Manifold	F7207	1
Fuel Pump Gasket	1980-1990			D26606	1
				Tuff-Cork D26606TC	1
Oil Filter Mount Gasket	1982-1990		Le Sabre	B26607	1
	1987-1989		Safari	B26607	1
	1986-1989		Fleetwood	B26607	1
	1982-1989		Caprice, Custom Cruiser, Ninety Eight	B26607	1
	1982-1988		Cutlass Supreme	B26607	1
	1984-1987		Regal	B26607	1
	1982-1987		Bonneville	B26607	1
	1986		Electra Estate Wagon, Parisienne	B26607	1
	1982-1986		Monte Carlo	B26607	1
	1982-1985		Delta 88 Royale, Toronado	B26607	1
	1984		Regency	B26607	1
	1982-1984		Cutlass, Electra	B26607	1
	1982-1983		Delta 88	B26607	1
Oil Pan Drain Plug Gst.	1980-1990			2051	1
Oil Pump Cover Gasket	1980-1990			B45813	1
Water Outlet Gasket	1980-1990			C24111	1
Water Pump Mount Gasket	1980-1990		Air Conditioning, Heavy Duty Cooling	K27156	1
			Air Conditioning, Heavy Duty Cooling Tuff-Cork	K27156TC	1
			Except Air Conditioning, Except Heavy Duty Cooling	K27821A	1
			Except Air Conditioning, Except Heavy Duty Cooling Tuff-Cork	K27821ATC	1

89 322 CID (5.3L) Buick V8 Cyl, 4.000in./101.6mm (1953-1956) **89**

Part	Year	VIN	Model/Application	Part Number	Qty.
ENGINE GASKETS					
Valve Cover Set	1953-1956			Cork Rubber VS38117	1
Rear Main Seal Set	1953-1956			JV742	1
Timing Cover Set	1956			JV788	1

90 326 CID (5.3L) Pontiac V8 Cyl, 3.719in./94.5mm (1963-1967) **90**

Part	Year	VIN	Model/Application	Part Number	Qty.
ENGINE GASKETS					
Head Set	1963-1967			HS3493E	1
Full Set	1963-1967			FS3493F	1
Engine Kit Gasket Set	1965-1967		(Push Rod Cover Set Not Included), Use With Part Number PS38776	95-3397VR	1
Cylinder Head Gasket	1963-1967			Layered Steel 3493	2
Valve Cover Set	1963-1967			Cork Rubber VS38291X	1
				High Temperature Cork Rubber VS38291XH	1
Valve Stem Seal, Exh.	1963-1967		(O-Ring Type)	B45229	8
Valve Stem Seal, Int.	1963-1967		(O-Ring Type)	B45229	8
Manifold Set, Exhaust	1963-1967			MS15085W	1
Manifold Set, Intake	1967			MS15135	1
	1965-1967		Late	MS15135	1

General Motors Corp.

90 (cont.)	326 CID (5.3L) Pontiac V8 Cyl, 3.719in./94.5mm (1963-1967)				90 (cont.)
----------------------	---	--	--	--	----------------------

<i>Part</i>	<i>Year</i>	<i>VIN</i>	<i>Model/Application</i>	<i>Part Number</i>	<i>Qty.</i>
ENGINE GASKETS (cont.)					
Manifold Set, Intake (cont.)	1965		Early	MS15100X	1
	1963-1964			MS15100X	1
Oil Pan Set	1963-1967		Cork Rubber	OS20526A	1
Rear Main Seal Set	1963-1967			JV708	1
Timing Cover Set	1963-1967		(Repair Sleeve Not Included)	JV877	1
			(Contains Repair Sleeve)	JV920	1
Harmonic Balancer Repair Sleeve	1963-1967		Ground Steel, .020" Thickness	66601RS	1
			Use With Part Number A502 Nickel Plated Formed Steel, .013" Thickness	A229-1	1

MISCELLANEOUS GASKETS					
Air Cleaner Mount Gasket	1963-1967		4 Barrel Carburetor	G26410	1
			2 Barrel Carburetor	G26617	1
Carb. Mount Gasket	1963-1967		4 Barrel Carburetor	G14554	1
Choke Tube Gasket	1963-1967			B45783	1
Dist. Mounting Gasket	1963-1967			B25941	1
Fuel Pump Gasket	1963-1967			D27094	1
			Tuff-Cork	D27094TC	1
Oil Filter Mount Gasket	1963-1967			B7147	1
Oil Pan Drain Plug Gst.	1963-1967			2051	1
Oil Pump Mounting Gasket	1963-1967			B26457	1
Push Rod Cover Set	1967		Cork Rubber	PS38776	1
	1965-1967		Late Cork Rubber	PS38776	1
	1965		Early Cork Rubber	PS38985	1
	1963-1964		Cork Rubber	PS38985	1
Water Outlet Gasket	1963-1967			C24109	1
Water Pump Mount Gasket	1967			K27818	1
	1965-1967		Late	K27818	1
	1965		Early	K27540	1
	1963-1964			K27540	1

91	327 CID (5.4L) Chevrolet V8 Cyl, 4.000in./101.6mm (1962-1969)				91
-----------	--	--	--	--	-----------

<i>Part</i>	<i>Year</i>	<i>VIN</i>	<i>Model/Application</i>	<i>Part Number</i>	<i>Qty.</i>
ENGINE GASKETS					
Head Set	1962-1969		(Head Bolts Not Included, Exhaust Pipe Gasket Not Included, Contains Beaded Steel Cylinder Head Gasket)	HS1178BJ	1
			(Head Bolts Not Included, Exhaust Pipe Gasket Not Included, Contains VR2000 Cylinder Head Gasket)	HS1178VJ	1
Lower Set	1962-1969		(Requires Head Set To Make Full Set)	CS1178	1
Full Set	1962-1969		(Head Bolts Not Included, Exhaust Pipe Gasket Not Included, Contains Beaded Steel Cylinder Head Gasket)	FS1178BJ	1
			(Head Bolts Not Included, Exhaust Pipe Gasket Not Included, Contains VR2000 Cylinder Head Gasket)	FS1178VJ	1
Engine Kit Gasket Set	1962-1969			95-3033VR	1
Cylinder Head Gasket	1962-1969		Beaded Steel	1178BS	2
			Contoured Combustion Chamber Nitroseal, 4.160" Combustion Chamber Opening	1178SG	2
			VR2000	1178VC	2
			Cylindrical Combustion Chamber Nitroseal	3432SG	2

91 (cont.)	327 CID (5.4L) Chevrolet V8 Cyl, 4.000in./101.6mm (1962-1969)				91 (cont.)
----------------------	--	--	--	--	----------------------

Part	Year	VIN	Model/Application	Part Number	Qty.
ENGINE GASKETS (cont.)					
Cylinder Head Gasket (cont.)	1962-1969		(Cylindrical Combustion Chamber Openings, Gasket Has Steam Holes Required For Street Operation) <i>Stainless Steel, 8.8cc Combustion Chamber Volume, 4.190" Combustion Chamber Opening, .040" Compressed Operating Thickness</i>	3512	2
			Contoured Combustion Chamber <i>Nitroseal, 4.100" Combustion Chamber Opening</i>	54052	2
Cyl. Head Bolt Set	1962-1969			GS33285	2
Valve Cover Set	1962-1969		<i>Cork Rubber</i>	VS38110	1
			<i>High Temperature Cork Rubber</i>	VS38110HA	1
			<i>High Temperature Tuff-Cork</i>	VS38110HTC	1
			<i>Victo-Tech</i>	VS38110R	1
			<i>Tuff-Cork</i>	VS38110TC	1
Valve Stem Seal, Exh.	1962-1969		(O-Ring Type)	B45229	8
			(Shedder Type)	B45264	8
			(High Temperature)	B45779	8
Valve Stem Seal, Int.	1963-1969		(Positive Type) <i>Fluoroelastomer</i>	B45418	8
	1962-1969		(O-Ring Type)	B45229	8
Manifold Set, Exhaust	1962-1969			MS7110X	1
Manifold Set, Intake	1962-1969			MS15315	1
Oil Pan Set	1962-1969		<i>Cork Rubber</i>	OS30568X	1
			<i>Tuff-Cork</i>	OS30568XTC	1
Rear Main Seal Set	1962-1969		(Lip Relocator Type)	JV1627	1
Timing Cover Set	1962-1969		(Repair Sleeve Not Included)	JV779	1
			(Contains Repair Sleeve)	JV919	1
Timing Cover Gasket	1962-1969			T27781	1
Timing Cover Seal	1962-1969		<i>3/8" Wide</i>	49328	1
			(Lip Relocator Type) <i>1/2" Wide</i>	65022	1
Harmonic Balancer Repair Sleeve	1962-1969		<i>Ground Steel, .020" Thickness</i>	66597RS	1
			Use With Part Number A504 <i>Nickel Plated Formed Steel, .013" Thickness</i>	A228	1

MISCELLANEOUS GASKETS

Air Cleaner Mount Gasket	1964-1969		2 Barrel Carburetor	G25936	1
	1962-1969		4 Barrel Carburetor	G27098	1
Carb. Mount Gasket	1969		Bel Air, Biscayne, Caprice, Impala, 1-11/16" Barrel Size, 2 Barrel Carburetor	G12261	1
	1968-1969		4 Barrel Carburetor, Heat Baffle	G12270	1
			4 Barrel Carburetor	G14579	1
	1967-1969		Camaro, 1-7/16" Barrel Size, 2 Barrel Carburetor	G12216	1
	1967-1968		Except Holley Carburetor, 4 Barrel Carburetor, Heat Baffle	G12270	1
			Except Holley Carburetor, 4 Barrel Carburetor	G14579	1
	1966-1968		Caprice, 2 Barrel Carburetor	G12216	1
	1965-1968		Chevy II, 2 Barrel Carburetor	G12216	1
	1964-1968		Chevelle, 2 Barrel Carburetor	G12216	1
	1967		Holley Carburetor, 4 Barrel Carburetor	G14576	1
	1966		Rochester, 4 Barrel Carburetor, Heat Baffle	G12270	1
			Rochester, 4 Barrel Carburetor	G14579	1
			Carter Carburetor, Holley Carburetor, 4 Barrel Carburetor	G14742	1
	1965		Impala, 2 Barrel Carburetor	G12216	1
	1964-1965		Carter Carburetor, Except High Performance, 4 Barrel Carburetor	G14112	1
Carter Carburetor, High Performance Engine, 4 Barrel Carburetor			G14553	1	
Holley Carburetor, 4 Barrel Carburetor			G14576	1	
1963-1965		Carter Carburetor, Except High Performance, Rochester, 4 Barrel Carburetor	G14112	1	
1962-1965		Rochester, 4 Barrel Carburetor	G14112	1	

General Motors Corp.

91 (cont.)	327 CID (5.4L) Chevrolet V8 Cyl, 4.000in./101.6mm (1962-1969)				91 (cont.)
----------------------	--	--	--	--	----------------------

<i>Part</i>	<i>Year</i>	<i>VIN</i>	<i>Model/Application</i>	<i>Part Number</i>	<i>Qty.</i>
MISCELLANEOUS GASKETS (cont.)					
Carb. Mount Gasket (cont.)	1962-1963		Carter Carburetor, 4 Barrel Carburetor	G7360	1
Dist. Mounting Gasket	1962-1969			B25934	1
Exhaust Pipe Gasket	1962-1969		2.5" Pipe, (Ring Type 'C'), Crossover Pipe, Pipe To Manifold	F7139	2
			2.5" Pipe, (Ring Type 'B'), Pipe To Manifold <i>Sintered Metal</i>	F7139S	2
			2" Pipe, (Ring Type 'C'), Crossover Pipe, Pipe To Manifold	F17250	2
			2" Pipe, (Ring Type 'B'), Pipe To Manifold <i>Sintered Metal</i>	F17250S	2
			1.875" Pipe, (Ring Type 'E'), Pipe To Manifold	F17355	2
Fuel Pump Gasket	1962-1969		Plate To Block	D25932	1
			Plate To Block <i>Tuff-Cork</i>	D25932TC	1
			Pump To Plate	D27094	1
			Pump To Plate <i>Tuff-Cork</i>	D27094TC	1
Heat Riser Gasket	1962-1969		3 Bolt <i>2.125" Inside Diameter</i>	F7135	1
			3 Bolt <i>2.437" Inside Diameter</i>	F7192	1
Oil Pan Drain Plug Gst.	1962-1969			2051	1
Oil Pump Shaft Retainer	1962-1969			H31354	1
Water Outlet Gasket	1962-1969		(Universal Type)	C24109	1
				C25930	1
Water Pump Backing Plate	1962-1969			K27091	1
Water Pump Mount Gasket	1962-1969			K25935	2

92	330 CID (5.4L) OHV Oldsmobile V8 Cyl, 3.938in./100mm (1964-1967)				92
-----------	---	--	--	--	-----------

<i>Part</i>	<i>Year</i>	<i>VIN</i>	<i>Model/Application</i>	<i>Part Number</i>	<i>Qty.</i>
ENGINE GASKETS					
Head Set	1964-1967		(Exhaust Pipe Gasket Not Included, Intake Manifold Gasket Not Included)	HS3436VC	1
Full Set	1964-1967		(Exhaust Pipe Gasket Not Included, Intake Manifold Gasket Not Included)	FS3436VC	1
Engine Kit Gasket Set	1967		Prefix 4W Or 8W, (Intake Manifold Gasket Not Included), Use With Part Number MS15925	95-3015VR	1
			Prefix W Or 5W, (Intake Manifold Gasket Not Included), Use With Part Number MS15122	95-3015VR	1
	1964-1966		(Intake Manifold Gasket Not Included), Use With Part Number MS15122	95-3015VR	1
Cylinder Head Gasket	1964-1967		<i>VR2000</i>	3436VC	2
Valve Cover Set	1964-1967		<i>Cork Rubber</i>	VS38305	1
			<i>High Temperature Cork Rubber</i>	VS38305H	1
			<i>Victo-Tech</i>	VS38305R	1
Valve Stem Seal, Exh.	1964-1967			B45416	8
Valve Stem Seal, Int.	1964-1967			B45416	8
Manifold Set, Exhaust	1964-1967			MS15141	1
Manifold Set, Intake	1967		Early	MS15122	1
			Late	MS15925	1
	1964-1966			MS15122	1
Oil Pan Set	1964-1967		<i>Cork Rubber</i>	OS30534	1
			<i>Tuff-Cork</i>	OS30534TC	1
Rear Main Seal Set	1964-1967		<i>Rope Packing</i>	JV741	1
			(Not Contained In Full Set) <i>Molded Rubber</i>	JV748	1
Timing Cover Set	1964-1967		(Repair Sleeve Not Included)	JV845	1
			(Contains Repair Sleeve)	JV927	1
Timing Cover Gasket	1964-1967			T27823	1
Timing Cover Seal	1964-1967			47398	1
Harmonic Balancer Repair Sleeve	1964-1967		<i>Ground Steel, .020" Thickness</i>	66590RS	1

PASSENGER CAR

92 330 CID (5.4L) OHV Oldsmobile V8 Cyl, 3.938in./100mm (1964-1967) **92**
(cont.) (cont.)

Part	Year	VIN	Model/Application	Part Number	Qty.
ENGINE GASKETS (cont.)					
Harmonic Balancer Repair Sleeve (cont.)	1964-1967		Use With Part Number A500 <i>Nickel Plated Formed Steel, .013" Thickness</i>	A222	1
MISCELLANEOUS GASKETS					
Air Cleaner Mount Gasket	1967		2 Barrel Carburetor	G26617	1
	1966-1967		4 Barrel Carburetor	G27098	1
	1964-1965		4 Barrel Carburetor	G26410	1
Carb. Mount Gasket	1966-1967		4 Barrel Carburetor	G26658	1
	1964-1965		4 Barrel Carburetor	G14574	1
Choke Tube Gasket	1964-1967			B45786	1
Dist. Mounting Gasket	1964-1967			72219	1
Fuel Pump Gasket	1964-1967			D26606	1
			<i>Tuff-Cork</i>	D26606TC	1
Oil Pan Drain Plug Gst.	1964-1967			2051	1
Water Outlet Gasket	1964-1967			C24111	1
Water Pump Mount Gasket	1964-1967		Air Conditioning, Heavy Duty Cooling	K27156	1
			Air Conditioning, Heavy Duty Cooling	<i>Tuff-Cork</i> K27156TC	1
			Except Air Conditioning, Except Heavy Duty Cooling	K27821A	1
			Except Air Conditioning, Except Heavy Duty Cooling	<i>Tuff-Cork</i> K27821ATC	1

93 331 CID (5.4L) OHV Cadillac V8 Cyl, 3.8125in./96.8mm (1949-1955) **93**

Part	Year	VIN	Model/Application	Part Number	Qty.
ENGINE GASKETS					
Head Set	1949-1955			HS1083VC	1
Valve Cover Set	1949-1955		<i>Cork Rubber</i>	VS38251	1
Valve Stem Seal, Exh.	1949-1955			B45233	8
Valve Stem Seal, Int.	1949-1955			B45233	8
Manifold Set, Intake	1949-1955			MS15038X	1
Oil Pan Set	1949-1955		<i>Cork Rubber</i>	OS30494	1
Rear Main Seal Set	1949-1955			JV677	1
Timing Cover Set	1949-1955			JV752	1
MISCELLANEOUS GASKETS					
Air Cleaner Mount Gasket	1949-1955			G26410	2
Exhaust Pipe Gasket	1949-1955		(Flange Type), Left	F5436AK	3
Fuel Pump Bowl Gasket	1949-1953			D34545	1
Fuel Pump Gasket	1949-1955			D27094	1
			<i>Tuff-Cork</i>	D27094TC	1
Push Rod Cover Set	1949-1955		<i>Cork Rubber</i>	PS38398	1
Water Pump Mount Gasket	1949-1955			K25917	2

94 340 CID (5.6L) Buick V8 Cyl, 3.750in./95.3mm (1966-1967) **94**

Part	Year	VIN	Model/Application	Part Number	Qty.
ENGINE GASKETS					
Head Set	1966-1967			HS3364BE	1
Full Set	1966-1967			FS3364BE	1
Cylinder Head Gasket	1966-1967		<i>Beaded Steel</i>	3364BS	2
Valve Cover Set	1966-1967		<i>Cork Rubber</i>	VS38312	1
Manifold Set, Intake	1966-1967			MS15144X	1
Oil Pan Set	1966-1967		<i>Cork Rubber</i>	OS30669	1
Rear Main Seal Set	1966-1967			JV742	1

General Motors Corp.

94 (cont.)	340 CID (5.6L) Buick V8 Cyl, 3.750in./95.3mm (1966-1967)				94 (cont.)
----------------------	---	--	--	--	----------------------

Part	Year	VIN	Model/Application	Part Number	Qty.
------	------	-----	-------------------	-------------	------

ENGINE GASKETS (cont.)

Timing Cover Set	1966-1967		(Contains Rope Packing)	JV844	1
			(Contains Superflex Seal)	JV1052SF	1
Timing Cover Gasket	1966-1967			T27960	1
Timing Cover Seal	1966-1967		(Superflex)	65025SF	1

MISCELLANEOUS GASKETS

Air Cleaner Mount Gasket	1966-1967		2 Barrel Carburetor	G25936	1
			4 Barrel Carburetor	G26410	1
Carb. Mount Gasket	1966-1967		2 Barrel Carburetor	G7374	1
			4 Barrel Carburetor	G14553	1
Dist. Mounting Gasket	1966-1967			72215	1
Fuel Pump Gasket	1966-1967			D27094	1
				<i>Tuff-Cork</i> D27094TC	1
Oil Pan Drain Plug Gst.	1966-1967			2051	1
Water Outlet Gasket	1966-1967			C26515	1
Water Pump Mount Gasket	1966-1967			K27571	1

95	346 CID (5.7L) LS1 Chevrolet V8 Cyl, 3.898in./99mm (1997-2003)				95
-----------	---	--	--	--	-----------

Part	Year	VIN	Model/Application	Part Number	Qty.
------	------	-----	-------------------	-------------	------

ENGINE GASKETS

Head Set	2001		Camaro, Firebird, (Head Bolts Not Included, Exhaust Pipe Gasket Not Included)	HS5975	1
	1999-2000		(Head Bolts Not Included, Exhaust Pipe Gasket Not Included)	HS5975	1
Lower Set	2001-2002		Camaro, Firebird, (Requires Head Set To Make Full Set)	CS5975	1
			Corvette, Oil Pan Gasket Required, (Lower Oil Pan Gasket Not Included, Requires Head Set To Make Full Set)	CS5975	1
Cylinder Head Gasket	1997-2001		Right <i>Nitroseal</i>	5975	1
			Left <i>Nitroseal</i>	5976	1
Cyl. Head Bolt Set	1997-2002			GS33380	2
Valve Cover Set	1999-2003		<i>Victo-Tech</i>	VS50250	1
Valve Stem Seal, Exh.	1997-2001			B45919	8
Valve Stem Seal, Int.	1997-2001			B45922	8
Manifold Set, Exhaust	2001-2002		Camaro, Firebird <i>Multi-Layered Steel</i>	MS16124	1
	1997-2000		<i>Multi-Layered Steel</i>	MS16124	1
Manifold Set, Intake	1997-2002			MS16350	1
Oil Pan Set	2001-2002		Corvette, Upper	OS32241	1
			Camaro, Firebird	OS32241	1
	1997-2000			OS32241	1
Rear Main Seal Set	1997-2002			JV1657	1
Timing Cover Set	1997-2002		Requires Oil Pan Set	JV5022	1
Harmonic Balancer Repair Sleeve	1997		<i>Ground Steel, .020" Oversize</i>	66597RS	1
			Use With Part Number A504 <i>Nickel Plated Formed Steel, .013" Oversize</i>	A228	1

MISCELLANEOUS GASKETS

E.G.R. Gasket	1998-2002		Camaro, Firebird, Tube To Exhaust Manifold	G31535	1
			Camaro, Firebird, Valve	G31620	1
			Camaro, Firebird, (O-Ring Type), Pipe	G31626	1
Exhaust Pipe Gasket	1998-2002		Camaro, Firebird, Right	F10152	1
			Camaro, Firebird, Left, Pipe To Manifold	F31630	1
Oil Pan Drain Plug Gst.	1997-2003			B45828	1
Thermostat O-Ring	1997-2002			72141	1

95 346 CID (5.7L) LS1 Chevrolet V8 Cyl, 3.898in./99mm (1997-2003) **95**
(cont.) (cont.)

Part Year VIN Model/Application Part Number Qty.

MISCELLANEOUS GASKETS (cont.)

Throttle Body Gasket	1997-2002			G31632	1
Water Pump Backing Plate	1997-2002		(O-Ring Type)	K31629	1
Water Pump Gasket	1999-2002			K31628	2
	1997-1998			K31627	2

96 346 CID (5.7L) LS6 Chevrolet V8 Cyl, 3.898in./99mm (2001-2003) **96**

Part Year VIN Model/Application Part Number Qty.

ENGINE GASKETS

Cylinder Head Gasket	2001		Right	Nitroseal	5975	1
			Left	Nitroseal	5976	1
Cyl. Head Bolt Set	2001-2002				GS33380	2
Valve Cover Set	2001-2003			Victo-Tech	VS50250	1
Manifold Set, Intake	2001-2002				MS16350	1
Oil Pan Set	2001-2002		Upper		OS32241	1
Rear Main Seal Set	2001-2002				JV1657	1
Timing Cover Set	2001-2002		Requires Oil Pan Set		JV5022	1

MISCELLANEOUS GASKETS

Oil Pan Drain Plug Gst.	2001-2003				B45828	1
Thermostat O-Ring	2001-2002				72141	1
Throttle Body Gasket	2001-2002				G31632	1
Water Pump Backing Plate	2001-2002		(O-Ring Type)		K31629	1
Water Pump Gasket	2001-2002				K31628	2

97 348 CID (5.7L) Chevrolet V8 Cyl, 4.125in./104.8mm (1958-1961) **97**

Part Year VIN Model/Application Part Number Qty.

ENGINE GASKETS

Head Set	1958-1961		(Exhaust Pipe Gasket Not Included, Exhaust Manifold Gasket Not Included)		HS1195VC	1
Full Set	1958-1961		(Exhaust Pipe Gasket Not Included, Exhaust Manifold Gasket Not Included)		FS1195VC	1
Cylinder Head Gasket	1958-1961			VR2000	1195VC	2
Valve Cover Set	1958-1961			Cork Rubber	VS38408	1
Manifold Set, Exhaust	1958-1961				MS15151	1
Manifold Set, Intake	1958-1961				MS18699	1
Oil Pan Set	1958-1961			Cork Rubber	OS30525	1
Rear Main Seal Set	1958-1961				JV699	1
Timing Cover Set	1958-1961				JV802	1
Timing Cover Seal	1958-1961			3/8" Wide	49328	1
			(Lip Relocator Type)	1/2" Wide	65022	1
Harmonic Balancer Repair Sleeve	1958-1961		Use With Part Number A504 Nickel Plated Formed Steel, .013" Thickness		A228	1

MISCELLANEOUS GASKETS

Air Cleaner Mount Gasket	1958-1961		3-2 Barrel Carburetors		G25936	3
			4 Barrel Carburetor		G26410	1
Carb. Mount Gasket	1958-1961		Carter Carburetor, 4 Barrel Carburetor		G7360	1
			Rochester, 4 Barrel Carburetor		G14112	1
Exhaust Pipe Gasket	1958-1961		2.5" Pipe, (Ring Type 'C'), Crossover Pipe, Pipe To Manifold		F7139	2
			2.5" Pipe, (Ring Type 'B'), Pipe To Manifold	Sintered Metal	F7139S	1
			2" Pipe, (Ring Type 'C'), Crossover Pipe, Pipe To Manifold		F17250	1
			2" Pipe, (Ring Type 'B'), Pipe To Manifold	Sintered Metal	F17250S	1
Fuel Pump Gasket	1958-1961		Plate To Block		D25932	1
			Plate To Block	Tuff-Cork	D25932TC	1

General Motors Corp.

97 348 CID (5.7L) Chevrolet V8 Cyl, 4.125in./104.8mm (1958-1961) **97**
 (cont.) (cont.)

Part	Year	VIN	Model/Application	Part Number	Qty.
MISCELLANEOUS GASKETS (cont.)					
Fuel Pump Gasket (cont.)	1958-1961		Pump To Plate	D27094	1
			Pump To Plate	Tuff-Cork D27094TC	1
Heat Riser Gasket	1958-1961		3 Bolt	2.125" Inside Diameter F7135	1
			3 Bolt	2.437" Inside Diameter F7192	1
Oil Pump Shaft Retainer	1958-1961			H31354	1
Water Outlet Gasket	1958-1961		(Universal Type)	C24109	1
				C25930	1
Water Pump Backing Plate	1958-1961			K27078	1
Water Pump Mount Gasket	1958-1961			K26004	2

98 350 CID (5.7L) Buick V8 Cyl, 3.800in./96.5mm (1968-1981) **98**

Part	Year	VIN	Model/Application	Part Number	Qty.
ENGINE GASKETS					
Head Set	1972-1981		(Intake Manifold Gasket Not Included)	HS3899VE	1
	1970-1972		Cylinder Head Number 1240142 Requires Original Equipment Head Gasket, Not Included, (Intake Manifold Gasket Not Included)	HS3899VE	1
	1968-1972		(Intake Manifold Gasket Not Included)	HS3899VE	1
Full Set	1972-1981		(Intake Manifold Gasket Not Included)	FS3899VE	1
	1970-1972		Cylinder Head Number 1240142 Requires Original Equipment Head Gasket, Not Included, (Intake Manifold Gasket Not Included)	FS3899VE	1
	1968-1972		(Intake Manifold Gasket Not Included)	FS3899VE	1
Engine Kit Gasket Set	1968-1981		(Intake Manifold Gasket Not Included), Use With Part Number MS15931	95-3008VR	1
Cylinder Head Gasket	1972-1981		VR2000	3899	2
	1970-1972		Cylinder Head Number 1240142 Requires Original Equipment Head Gasket, Not Included	VR2000 3899	2
	1968-1969		VR2000	3899	2
Valve Cover Set	1968-1981		Cork Rubber	VS38320	1
			Tuff-Cork	VS38320TC	1
Valve Stem Seal, Exh.	1968-1973		Nitrile	B45403	8
Valve Stem Seal, Int.	1968-1981		Nitrile	B45403	8
Manifold Set, Exhaust	1968-1981			MS15201	1
Manifold Set, Intake	1968-1981			MS15931	1
Oil Pan Set	1968-1981		Cork Rubber	OS30669	1
Rear Main Seal Set	1968-1981			JV742	1
Timing Cover Set	1968-1981		(Contains Rope Packing)	JV860	1
			(Contains Superflex Seal)	JV1053SF	1
Timing Cover Gasket	1968-1981			T27960	1
Timing Cover Seal	1968-1981		(Superflex)	65025SF	1

MISCELLANEOUS GASKETS

Air Cleaner Mount Gasket	1976-1981		4 Barrel Carburetor	G27098	1
	1975-1977		2 Barrel Carburetor	G26617	1
	1975-1976			G26617	1
			4 Barrel Carburetor	G27098	1
	1970-1976		2 Barrel Carburetor	G26617	1
	1968-1975		4 Barrel Carburetor	G27098	1
	1968-1969		2 Barrel Carburetor	G25936	1
Carb. Mount Gasket	1976-1981		4 Barrel Carburetor	G26717	1
	1975-1977		2 Barrel Carburetor	G26712	1
	1975-1976			G26712	1
			2 Barrel Carburetor	G26712	1

98 350 CID (5.7L) Buick V8 Cyl, 3.800in./96.5mm (1968-1981) **98**
(cont.) (cont.)

Part	Year	VIN	Model/Application	Part Number	Qty.
MISCELLANEOUS GASKETS (cont.)					
Carb. Mount Gasket (cont.)	1975-1976		4 Barrel Carburetor	G26717	1
	1975		4 Barrel Carburetor	G26717	1
	1970-1974		2 Barrel Carburetor	G25452	1
	1969-1974		4 Barrel Carburetor	G26652	1
	1968-1969		2 Barrel Carburetor	G7374	1
Dist. Mounting Gasket	1968-1981			72215	1
E.G.R. Gasket	1968-1981			G26315	1
Fuel Pump Gasket	1968-1981			D27094	1
				<i>Tuff-Cork</i> D27094TC	1
Oil Pan Drain Plug Gst.	1968-1981			2051	1
Oil Pump Cover Gasket	1978-1981		Except 1st Design	B45577	1
	1975-1978		1st Design	B45579	1
	1968-1976			B45579	1
Water Outlet Gasket	1968-1981			C26515	1
Water Pump Mount Gasket	1968-1981			K27571	1

99 350 CID (5.7L) Carbureted Chevrolet V8 Cyl, 4.000in./101.6mm (1967-1987) **99**

Part	Year	VIN	Model/Application	Part Number	Qty.
ENGINE GASKETS					
Head Set	1987		(Exhaust Pipe Gasket Not Included)	HS1178VL	1
			(Contains Graphite Head Gasket, Exhaust Pipe Gasket Not Included)	HS5746	1
	1975-1986		(Exhaust Pipe Gasket Not Included)	HS1178VK	1
	1967-1974		(Exhaust Pipe Gasket Not Included, Contains Beaded Steel Cylinder Head Gasket)	HS1178BJ	1
			(Exhaust Pipe Gasket Not Included)	HS1178VJ	1
Lower Set	1986-1987		(Requires Head Set To Make Full Set)	CS1178A	1
	1967-1985		(Requires Head Set To Make Full Set)	CS1178	1
Full Set	1987			FS1178VL	1
	1975-1985		(Exhaust Pipe Gasket Not Included)	FS1178VK	1
	1967-1985		(Performer, Contains Stainless Steel Layered Type Head Gasket)	FS3512	1
			(Exhaust Pipe Gasket Not Included, Contains Beaded Steel Cylinder Head Gasket)	FS1178BJ	1
			(Exhaust Pipe Gasket Not Included)	FS1178VJ	1
Engine Kit Gasket Set	1986-1987			95-3444VR	1
	1981-1985			95-3072VR	1
	1967-1980			95-3033VR	1
Cylinder Head Gasket	1967-1987		<i>Beaded Steel</i>	1178BS	2
			Contoured Combustion Chamber <i>Nitroseal, 4.160" Combustion Chamber Opening</i>	1178SG	2
			<i>VR2000</i>	1178VC	2
			Cylindrical Combustion Chamber <i>Nitroseal</i>	3432SG	2
			(Cylindrical Combustion Chamber Openings, Gasket Has Steam Holes Required For Street Operation) <i>Stainless Steel, 8.8cc Combustion Chamber Volume, 4.190" Combustion Chamber Opening, .040" Compressed Operating Thickness</i>	3512	2
			Contoured Combustion Chamber <i>Nitroseal, 4.100" Combustion Chamber Opening</i>	54052	2
Cyl. Head Bolt Set	1967-1987			GS33285	2
Valve Cover Set	1987		<i>Tuff-Cork</i>	VS50025TC	1
			(Single Valve Cover) <i>Tuff-Cork</i>	VS50126TC	2
			<i>Victo-Tech</i>	VS50161	1
			(Single Valve Cover) <i>Victo-Tech</i>	VS50163	2

General Motors Corp.

99 350 CID (5.7L) Carbureted Chevrolet V8 Cyl, 4.000in./101.6mm (1967-1987) **99**
 (cont.) (cont.)

Part Year VIN Model/Application Part Number Qty.

ENGINE GASKETS (cont.)

Valve Cover Set (cont.)	1967-1986		<i>Cork Rubber</i>	VS38110	1
			<i>High Temperature Cork Rubber, 5/16" Thickness</i>	VS38110H	1
			<i>High Temperature Cork Rubber</i>	VS38110HA	1
			<i>High Temperature Tuff-Cork</i>	VS38110HTC	1
			<i>Victo-Tech</i>	VS38110R	1
			<i>Tuff-Cork</i>	VS38110TC	1
Valve Stem Seal, Exh.	1967-1987	(O-Ring Type)		B45229	8
		(Shedder Type)		B45264	8
		(Shedder Type, High Temperature)		B45779	8
Valve Stem Seal, Int.	1967-1987	(O-Ring Type)		B45229	8
		(Positive Type)	<i>Fluoroelastomer</i>	B45418	8
Manifold Set, Exhaust	1967-1987	Stainless Steel Exhaust Manifold		MS7110SS	1
		Except Stainless Steel Manifold		MS7110X	1
Manifold Set, Intake	1987	Cast Iron Cylinder Heads		MS15315W	1
	1967-1986	Except Liquid Propane Gas		MS15315	1
	1967-1985	Liquid Propane Gas		MS15219BF	1
Oil Pan Set	1986-1987		<i>Tuff-Cork</i>	OS32471TC	1
			<i>Victo-Tech</i>	OS32496	1
		(Original Equipment Style Steel Backbone)	<i>Victo-Tech</i>	OS32496B	1
	1980-1985	Right Hand Dip Stick	<i>Victo-Tech</i>	OS30568RRH	1
			<i>Tuff-Cork</i>	OS30572TC	1
	1975-1985		<i>Cork Rubber</i>	OS30568Z	1
	1975-1979	Left Hand Dip Stick	<i>Victo-Tech</i>	OS30568RLH	1
			<i>Tuff-Cork</i>	OS30568ZTC	1
1967-1974		<i>Cork Rubber</i>	OS30568X	1	
		<i>Tuff-Cork</i>	OS30568XTC	1	
Rear Main Seal Set	1986-1987	(1 Piece)		JV554	1
		(1 Piece)	<i>Teflon</i>	JV1634	1
	1967-1985	(2 Piece, Lip Relocator Type)		JV1627	1
Timing Cover Set	1986-1987	(Repair Sleeve Not Included)		JV1041	1
		(Repair Sleeve Not Included)		JV881	1
	1975-1985	(Contains Repair Sleeve)		JV926	1
		(Repair Sleeve Not Included)		JV779	1
		(Contains Repair Sleeve)		JV919	1
1967-1974			T27781	1	
Timing Cover Gasket	1967-1987				1
Timing Cover Seal	1967-1987		<i>3/8" Wide</i>	49328	1
		(Lip Relocator Type)	<i>1/2" Wide</i>	65022	1
Harmonic Balancer Repair Sleeve	1967-1987		<i>Ground Steel, .020" Thickness</i>	66597RS	1
		Use With Part Number A504 <i>Nickel Plated Formed Steel, .013" Oversize</i>		A228	1

MISCELLANEOUS GASKETS

Air Cleaner Mount Gasket	1967-1987	4 Barrel Carburetor, Except Quadrajete Carburetor		G27098	1
	1967-1983	Quadrajete Carburetor, 4 Barrel Carburetor		G31176	1
	1967-1978	2 Barrel Carburetor		G26617	1
Carb. Mount Gasket	1981-1987	4 Barrel Carburetor		G26792	1
	1974-1980	4 Barrel Carburetor		G26719	1
	1974-1977	2 Barrel Carburetor		G26711	1
	1973	Bel Air, Camaro, Caprice, Chevelle, Corvette, Impala, Monte Carlo, Nova, 4 Barrel Carburetor		G26666	1
	1972-1973	Bel Air, Camaro, Caprice, Chevelle, Impala, Monte Carlo, 2 Barrel Carburetor		G25488	1
	1971-1973	Nova, 2 Barrel Carburetor		G12261	1
	1972	Biscayne, 2 Barrel Carburetor		G25488	1
		Bel Air, Biscayne, Camaro, Caprice, Chevelle, Corvette, Impala, Monte Carlo, Nova, Except Special High Performance Engine, 4 Barrel Carburetor		G26666	1

99 350 CID (5.7L) Carbureted Chevrolet V8 Cyl, 4.000in./101.6mm (1967-1987) **99**
 (cont.) (cont.)

Part	Year	VIN	Model/Application	Part Number	Qty.
MISCELLANEOUS GASKETS (cont.)					
Carb. Mount Gasket (cont.)	1971		Bel Air, Biscayne, Camaro, Caprice, Chevelle, Corvette, Impala, Monte Carlo, Nova, Except Special High Performance Engine, 4 Barrel Carburetor, Carburetor To Manifold	G26666	1
	1970-1971		Except Special High Performance Engine, 4 Barrel Carburetor, Shield To Manifold	G18565	1
			Except Special High Performance Engine, 4 Barrel Carburetor, Carburetor To Shield	G26664	1
	1970		Biscayne, Caprice, Impala, Monte Carlo, Except Exhaust Emission Control, 2 Barrel Carburetor	G12261	1
	1969-1970		Camaro, Chevelle, Nova, Except Exhaust Emission Control, 2 Barrel Carburetor	G12261	1
	1967-1969		Rochester, 4 Barrel Carburetor	G14579	1
			Holley Carburetor, 4 Barrel Carburetor	G14733	1
	1967-1968		Camaro, Caprice, 2 Barrel Carburetor	G12261	1
Choke Tube Gasket	1977-1979			B45787	1
Dist. Mounting Gasket	1967-1987			B25934	1
E.G.R. Gasket	1975-1982	L		G26748	2
	1973-1974			G26338	1
Exhaust Pipe Gasket	1975-1985		(Ring Type 'C'), Pipe To Manifold	F17250	1
			(Ring Type 'B'), Pipe To Manifold <i>Sintered Metal</i>	F17250S	1
	1967-1977		2" Pipe, (Ring Type 'C'), Pipe To Manifold	F17250	2
			2" Pipe, (Ring Type 'B'), Pipe To Manifold <i>Sintered Metal</i>	F17250S	2
	1975-1976		(Ring Type 'C'), Pipe To Manifold	F17250	1
			(Ring Type 'B'), Pipe To Manifold <i>Sintered Metal</i>	F17250S	1
	1967-1974		2.5" Pipe, (Ring Type 'C'), Pipe To Manifold	F7139	2
			2.5" Pipe, (Ring Type 'B'), Pipe To Manifold <i>Sintered Metal</i>	F7139S	2
		1.875" Pipe, (Ring Type 'E'), Pipe To Manifold	F17355	1	
Fuel Pump Gasket	1967-1987		Plate To Block	D25932	1
			Plate To Block <i>Tuff-Cork</i>	D25932TC	1
			Pump To Plate	D27094	1
			Pump To Plate <i>Tuff-Cork</i>	D27094TC	1
Heat Riser Gasket	1967-1974		3 Bolt <i>2.125" Inside Diameter</i>	F7135	1
			3 Bolt <i>2.437" Inside Diameter</i>	F7192	1
Oil Pan Drain Plug Gst.	1967-1987			2051	1
Oil Pump Shaft Retainer	1967-1987			H31354	1
Water Outlet Gasket	1967-1987			C25930	1
Water Pump Backing Plate	1967-1987			K27091	1
Water Pump Mount Gasket	1967-1987			K25935	2

100 350 CID (5.7L) Fuel Injected Chevrolet V8 Cyl, 4.000in./101.6mm (1982-1997) **100**

Part	Year	VIN	Model/Application	Part Number	Qty.
ENGINE GASKETS					
Head Set	1993-1997	P	Camaro, Firebird, (Head Bolts Not Included, Exhaust Pipe Gasket Not Included)	HS5922B	1
	1994-1996	P	Brougham, Caprice, Fleetwood, Impala, Roadmaster, (Head Bolts Not Included, Exhaust Pipe Gasket Not Included)	HS5898	1
	1993-1995	P	Corvette, (Head Bolts Not Included, Exhaust Pipe Gasket Not Included)	HS5922A	1
	1990-1993	7	(Head Bolts Not Included, Exhaust Gasket Not Included, Exhaust Pipe Gasket Not Included)	HS5746W	1
	1987-1992	8	Camaro, Firebird, (Head Bolts Not Included, Exhaust Pipe Gasket Not Included)	HS1178VL	1
		8	Camaro, Firebird, (Head Bolts Not Included, Contains Graphite Head Gasket, Exhaust Pipe Gasket Not Included)	HS5746	1

General Motors Corp.

100
(cont.)

350 CID (5.7L) Fuel Injected Chevrolet V8 Cyl, 4.000in./101.6mm (1982-1997)

100
(cont.)

Part	Year	VIN	Model/Application	Part Number	Qty.	
ENGINE GASKETS (cont.)						
Head Set (cont.)	1987-1991	8	Corvette, (Head Bolts Not Included, Exhaust Pipe Gasket Not Included)	HS3781	1	
	1986	8	Corvette, Cast Iron Cylinder Heads, (Head Bolts Not Included, Exhaust Pipe Gasket Not Included)	HS1178VL	1	
		8	Corvette, Aluminum Cylinder Heads, (Head Bolts Not Included, Exhaust Pipe Gasket Not Included)	HS3781	1	
	1985	8	Except Corvette, (Head Bolts Not Included, Exhaust Pipe Gasket Not Included)	HS1178VK	1	
	1984-1985	8	Corvette, (Head Bolts Not Included, Exhaust Pipe Gasket Not Included, Intake Manifold Gasket Not Included)	HS1178VL	1	
	1982	8	Corvette, (Head Bolts Not Included, Exhaust Pipe Gasket Not Included, Intake Manifold Gasket Not Included)	HS1178VL	1	
Lower Set	1992-1997	P	(Requires Head Set To Make Full Set)	CS5922	1	
	1990-1993	7	(Requires Head Set To Make Full Set)	CS1178A	1	
	1986-1992	8	(Requires Head Set To Make Full Set)	CS1178A	1	
	1984-1985		(Requires Head Set To Make Full Set)	CS1178	1	
	1982		(Requires Head Set To Make Full Set)	CS1178	1	
Full Set	1990-1993	7	(Head Bolts Not Included, Exhaust Gasket Not Included)	FS5746W	1	
	1987-1992	8	Camaro, Firebird, (Head Bolts Not Included, Exhaust Pipe Gasket Not Included)	FS1178VL	1	
	1987-1991	8	Corvette, (Head Bolts Not Included, Exhaust Pipe Gasket Not Included)	FS3781	1	
	1986	8	Corvette, Cast Iron Cylinder Heads, (Head Bolts Not Included, Exhaust Pipe Gasket Not Included)	FS1178VL	1	
		8	Corvette, Aluminum Cylinder Heads, (Head Bolts Not Included, Exhaust Pipe Gasket Not Included)	FS3781	1	
	1984-1985		(Head Bolts Not Included, Exhaust Pipe Gasket Not Included)	FS1178VL	1	
	1982		(Head Bolts Not Included, Exhaust Pipe Gasket Not Included, Intake Manifold Gasket Not Included)	FS1178VL	1	
	Engine Kit Gasket Set	1990-1993	7	Throttle Body Injection	95-3418VR	1
		1987-1992	8	Camaro, Tuned Port Fuel Injection	95-3417VR	1
			8	Firebird, Tuned Port Fuel Injection	95-3417VR	1
1984		8	Crossfire Fuel Injection, (Intake Manifold Gasket Not Included), Use With Part Number MS15315BF	95-3072VR	1	
1982		8	Crossfire Fuel Injection, (Intake Manifold Gasket Not Included), Use With Part Number MS15315BF	95-3072VR	1	
Cylinder Head Gasket	1993-1997	P	Camaro, Firebird <i>VR2000</i>	5922	2	
	1996	5	<i>Nitroseal</i>	5930	2	
	1994-1996	P	Brougham, Caprice, Fleetwood, Impala, Roadmaster <i>Nitroseal</i>	5898	2	
	1992-1996	P	Corvette <i>VR2000</i>	5922	2	
	1989-1993	7	(Single Sided Graphite) <i>Nitroseal</i>	5746	2	
	1987-1992	8	Camaro, Firebird <i>Beaded Steel</i>	1178BS	2	
		8	Camaro, Firebird, (Contoured Combustion Chamber Openings) <i>Nitroseal, 4.160" Combustion Chamber Opening</i>	1178SG	2	
		8	Camaro, Firebird <i>VR2000</i>	1178VC	2	
		8	Camaro, Firebird, (Cylindrical Combustion Chamber Openings) <i>Nitroseal</i>	3432SG	2	
		8	Camaro, Firebird, (Cylindrical Combustion Chamber Openings, Gasket Has Steam Holes Required For Street Operation) <i>Stainless Steel, 8.8cc Combustion Chamber Volume, 4.190" Combustion Chamber Opening, .040" Compressed Operating Thickness</i>	3512	2	
		8	Camaro, Firebird, (Single Sided Graphite) <i>Nitroseal</i>	5746	2	
		8	Camaro, Firebird, (Contoured Combustion Chamber Openings) <i>Nitroseal, 4.100" Combustion Chamber Opening</i>	54052	2	
		1987-1991	8	Corvette <i>Nitroseal</i>	3781G	2
	1986	8	Corvette, Cast Iron Cylinder Heads <i>Beaded Steel</i>	1178BS	2	

PASSENGER CAR

100 (cont.)	350 CID (5.7L) Fuel Injected Chevrolet V8 Cyl, 4.000in./101.6mm (1982-1997)	100 (cont.)
-----------------------	--	-----------------------

Part	Year	VIN	Model/Application	Part Number	Qty.	
ENGINE GASKETS (cont.)						
Cylinder Head Gasket (cont.)	1986	8	Corvette, Cast Iron Cylinder Heads, (Contoured Combustion Chamber Openings) <i>Nitroseal, 4.160" Combustion Chamber Opening</i>	1178SG	2	
		8	Corvette, Cast Iron Cylinder Heads <i>VR2000</i>	1178VC	2	
		8	Corvette, Cast Iron Cylinder Heads, (Cylindrical Combustion Chamber Openings, Gasket Has Steam Holes Required For Street Operation) <i>Stainless Steel, 8.8cc Combustion Chamber Volume, 4.190" Combustion Chamber Opening, .040" Compressed Operating Thickness</i>	3512	2	
		8	Corvette, Aluminum Cylinder Heads <i>Nitroseal</i>	3781G	2	
		8	Corvette, Cast Iron Cylinder Heads, (Contoured Combustion Chamber Openings) <i>Nitroseal, 4.100" Combustion Chamber Opening</i>	54052	2	
	1984-1985			<i>Beaded Steel</i>	1178BS	2
			(Contoured Combustion Chamber Openings) <i>Nitroseal, 4.160" Combustion Chamber Opening</i>	1178SG	2	
			<i>VR2000</i>	1178VC	2	
			(Cylindrical Combustion Chamber Openings) <i>Nitroseal</i>	3432SG	2	
			(Cylindrical Combustion Chamber Openings, Gasket Has Steam Holes Required For Street Operation) <i>Stainless Steel, 8.8cc Combustion Chamber Volume, 4.190" Combustion Chamber Opening, .040" Compressed Operating Thickness</i>	3512	2	
			(Contoured Combustion Chamber Openings) <i>Nitroseal, 4.100" Combustion Chamber Opening</i>	54052	2	
	1982			<i>Beaded Steel</i>	1178BS	2
			(Contoured Combustion Chamber Openings) <i>Nitroseal, 4.160" Combustion Chamber Opening</i>	1178SG	2	
			<i>VR2000</i>	1178VC	2	
			(Cylindrical Combustion Chamber Openings) <i>Nitroseal</i>	3432SG	2	
			(Cylindrical Combustion Chamber Openings, Gasket Has Steam Holes Required For Street Operation) <i>Stainless Steel, 8.8cc Combustion Chamber Volume, 4.190" Combustion Chamber Opening, .040" Compressed Operating Thickness</i>	3512	2	
			(Contoured Combustion Chamber Openings) <i>Nitroseal, 4.100" Combustion Chamber Opening</i>	54052	2	
	Cyl. Head Bolt Set	1984-1997			GS33285	2
		1982			GS33285	2
	Valve Cover Set	1993-1997	P	Camaro, Firebird <i>Tuff-Cork</i>	VS50025TC	1
P			Camaro, Firebird, (Single Valve Cover) <i>Tuff-Cork</i>	VS50126TC	2	
P			Camaro, Firebird <i>Victo-Tech</i>	VS50161	1	
P			Camaro, Firebird, (Single Valve Cover) <i>Victo-Tech</i>	VS50163	2	
1996		5	Corvette <i>Victo-Tech</i>	VS50175	1	
		5	Corvette, (Single Valve Cover) <i>Victo-Tech</i>	VS50176	2	
1994-1996		P	Brougham, Caprice, Fleetwood, Impala, Roadmaster <i>Tuff-Cork</i>	VS50025TC	1	
		P	Brougham, Caprice, Fleetwood, Impala, Roadmaster, (Single Valve Cover) <i>Tuff-Cork</i>	VS50126TC	2	
		P	Brougham, Caprice, Fleetwood, Impala, Roadmaster <i>Victo-Tech</i>	VS50161	1	
		P	Brougham, Caprice, Fleetwood, Impala, Roadmaster, (Single Valve Cover) <i>Victo-Tech</i>	VS50163	2	
1992-1996		P	Corvette <i>Victo-Tech</i>	VS50175	1	
		P	Corvette, (Single Valve Cover) <i>Victo-Tech</i>	VS50176	2	
1990-1993		7	<i>Tuff-Cork</i>	VS50025TC	1	
		7	(Single Valve Cover) <i>Tuff-Cork</i>	VS50126TC	2	
		7	<i>Victo-Tech</i>	VS50161	1	
	7	(Single Valve Cover) <i>Victo-Tech</i>	VS50163	2		
1986-1992	8	<i>Tuff-Cork</i>	VS50025TC	1		
	8	<i>Victo-Tech</i>	VS50161	1		

General Motors Corp.

100
(cont.)

350 CID (5.7L) Fuel Injected Chevrolet V8 Cyl, 4.000in./101.6mm (1982-1997)

100
(cont.)

Part	Year	VIN	Model/Application	Part Number	Qty.	
ENGINE GASKETS (cont.)						
Valve Cover Set (cont.)	1986-1991	8	(Single Valve Cover) <i>Tuff-Cork</i>	VS50126TC	2	
		8	(Single Valve Cover) <i>Victo-Tech</i>	VS50163	2	
	1984-1985			<i>Cork Rubber</i>	VS38110	1
				<i>High Temperature Cork Rubber</i>	VS38110HA	1
				<i>High Temperature Tuff-Cork</i>	VS38110HTC	1
				<i>Victo-Tech</i>	VS38110R	1
				<i>Tuff-Cork</i>	VS38110TC	1
	1982			<i>Cork Rubber</i>	VS38110	1
				<i>High Temperature Cork Rubber</i>	VS38110HA	1
				<i>High Temperature Tuff-Cork</i>	VS38110HTC	1
				<i>Victo-Tech</i>	VS38110R	1
				<i>Tuff-Cork</i>	VS38110TC	1
Valve Stem Seal, Exh.	1992-1996			B45796	8	
		P		B45796	8	
	1990-1993	7	(O-Ring Type)		B45229	8
		7			B45264	8
		7	(High Temperature)		B45779	8
	1984-1992	8	(O-Ring Type)		B45229	8
		8			B45264	8
		8	(High Temperature)		B45779	8
	1982	8	(O-Ring Type)		B45229	8
		8			B45264	8
		8	(High Temperature)		B45779	8
	Valve Stem Seal, Int.	1992-1997	P		B45796	8
		1990-1993	7	(O-Ring Type)	B45229	8
7				<i>Fluoroelastomer</i>	B45418	8
1984-1992		8	(O-Ring Type)	B45229	8	
		8		<i>Fluoroelastomer</i>	B45418	8
1982		8	(O-Ring Type)	B45229	8	
		8		<i>Fluoroelastomer</i>	B45418	8
Manifold Set, Exhaust	1993-1997	P	Camaro, Firebird	MS16107	1	
	1996	5	Corvette	MS16106	1	
	1994-1996	P	Brougham, Caprice, Fleetwood, Impala, Roadmaster	MS16107	1	
	1992-1996	P	Corvette	MS16106	1	
	1990-1993	7		MS7110X	1	
	1987-1992	8	Camaro, Firebird	MS7110X	1	
	1987-1991	8	Corvette	MS15477	1	
	1986	8	Corvette, Cast Iron Cylinder Heads, Stainless Steel Exhaust Manifold	MS7110SS	1	
		8	Corvette, Cast Iron Cylinder Heads, Except Stainless Steel Manifold	MS7110X	1	
		8	Corvette, Aluminum Cylinder Heads	MS15477	1	
	1984-1985		Stainless Steel Exhaust Manifold	MS7110SS	1	
			Except Stainless Steel Manifold	MS7110X	1	
	1982		Stainless Steel Exhaust Manifold	MS7110SS	1	
			Except Stainless Steel Manifold	MS7110X	1	
	Manifold Set, Intake	1993-1997	P	Camaro, Firebird	MS16134	1
1994-1996		P	Brougham, Caprice, Fleetwood, Impala, Roadmaster	MS16134	1	
1992-1996		P	Corvette	MS16134	1	
1990-1993		7		MS15401	1	
1987-1992		8	Camaro, Firebird, (Contains Plenum Chamber Gasket)	MS15315W	1	
1987-1991		8	Corvette, (Contains Plenum Chamber Gasket)	MS15401W	1	
1986		8	Corvette, Cast Iron Cylinder Heads, (Contains Plenum Chamber Gasket)	MS15315W	1	
		8	Corvette, Aluminum Cylinder Heads, (Contains Plenum Chamber Gasket)	MS15401W	1	
1985			(Contains Plenum Chamber Gasket)	MS15315W	1	
1984			Crossfire Fuel Injection	MS15315BF	1	

PASSENGER CAR

100 350 CID (5.7L) Fuel Injected Chevrolet V8 Cyl, 4.000in./101.6mm (1982-1997) **100**
 (cont.) (cont.)

Part	Year	VIN	Model/Application	Part Number	Qty.
ENGINE GASKETS (cont.)					
Manifold Set, Intake (cont.)	1982		Crossfire Fuel Injection	MS15315BF	1
Plenum Chamber Gasket	1985-1992	8		MS12343	1
Oil Pan Set	1986-1997		<i>Tuff-Cork</i>	OS32471TC	1
			<i>Victo-Tech</i>	OS32496	1
			(Original Equipment Style Steel Backbone) <i>Victo-Tech</i>	OS32496B	1
	1984-1985		Right Hand Dip Stick <i>Victo-Tech</i>	OS30568RRH	1
			<i>Cork Rubber</i>	OS30568Z	1
			<i>Tuff-Cork</i>	OS30572TC	1
	1982		Right Hand Dip Stick <i>Victo-Tech</i>	OS30568RRH	1
			<i>Cork Rubber</i>	OS30568Z	1
			<i>Tuff-Cork</i>	OS30572TC	1
	Rear Main Seal Set	1997		Camaro, Firebird	JV1620
1986-1996			(1 Piece)	JV554	1
			(1 Piece) <i>Teflon</i>	JV1634	1
1984-1985			(2 Piece, Lip Relocator Type)	JV1627	1
1982			(2 Piece, Lip Relocator Type)	JV1627	1
Crank Repair Sleeve	1986-1996		Use With Part Number A506, Rear <i>Nickel Plated Formed Steel, .013" Oversize</i>	A338	1
Seal Extender	1986-1996			E300	1
Timing Cover Set	1992-1997	P		JV1154	1
	1990-1993	7		JV1041	1
	1986-1992	8		JV1041	1
	1984-1985		(Repair Sleeve Not Included)	JV881	1
			(Contains Repair Sleeve)	JV926	1
	1982		(Repair Sleeve Not Included)	JV881	1
		(Contains Repair Sleeve)	JV926	1	
Timing Cover Gasket	1992-1997	P		T31276	1
	1990-1993	7		T27781	1
	1984-1992	8		T27781	1
	1982	8		T27781	1
Timing Cover Seal	1984-1997		<i>3/8" Wide</i>	49328	1
			(Lip Relocator Type) <i>1/2" Wide</i>	65022	1
	1982		<i>3/8" Wide</i>	49328	1
			(Lip Relocator Type) <i>1/2" Wide</i>	65022	1
Harmonic Balancer Repair Sleeve	1984-1997		<i>Ground Steel, .020" Oversize</i>	66597RS	1
			Use With Part Number A504 <i>Nickel Plated Formed Steel, .013" Oversize</i>	A228	1
	1982		<i>Ground Steel, .020" Thickness</i>	66597RS	1
			Use With Part Number A504 <i>Nickel Plated Formed Steel, .013" Oversize</i>	A228	1
MISCELLANEOUS GASKETS					
Air Cleaner Mount Gasket	1984-1993		Throttle Body Injection	G27098	1
	1984		Crossfire Fuel Injection	G26803	2
	1982		Crossfire Fuel Injection	G26803	2
Dist. Mounting Gasket	1984-1992			B25934	1
	1982			B25934	1
E.G.R. Gasket	1992-1997	P		G26315	1
	1990-1993	7		G26748	1
	1987-1992	8	Camaro, Firebird	G26748	1
	1986-1991	8	Corvette	G17797	1
Exhaust Pipe Gasket	1995-1997		Right	F10152	1
			Left	F10153	1
	1993	7	Brougham, Caprice, Fleetwood, Roadmaster, (Ring Type 'E'), Pipe To Manifold	F10140	1

General Motors Corp.

100 350 CID (5.7L) Fuel Injected Chevrolet V8 Cyl, 4.000in./101.6mm (1982-1997) **100**
 (cont.) (cont.)

Part	Year	VIN	Model/Application	Part Number	Qty.
MISCELLANEOUS GASKETS (cont.)					
Exhaust Pipe Gasket (cont.)	1993	P	Corvette, (Ring Type 'E'), Pipe To Manifold	F10140	1
	1984-1985		(Ring Type 'C'), Pipe To Manifold	F17250	1
			(Ring Type 'B'), Pipe To Manifold	<i>Sintered Metal</i> F17250S	1
	1982		(Ring Type 'C'), Pipe To Manifold	F17250	1
			(Ring Type 'B'), Pipe To Manifold	<i>Sintered Metal</i> F17250S	1
Fuel Pump Gasket	1990-1993	7	Plate To Block	D25932	1
		7	Plate To Block	<i>Tuff-Cork</i> D25932TC	1
		7	Pump To Plate	D27094	1
		7	Pump To Plate	<i>Tuff-Cork</i> D27094TC	1
	1984-1992	8	Plate To Block	D25932	1
		8	Plate To Block	<i>Tuff-Cork</i> D25932TC	1
		8	Pump To Plate	D27094	1
		8	Pump To Plate	<i>Tuff-Cork</i> D27094TC	1
	1982	8	Plate To Block	D25932	1
		8	Plate To Block	<i>Tuff-Cork</i> D25932TC	1
		8	Pump To Plate	D27094	1
		8	Pump To Plate	<i>Tuff-Cork</i> D27094TC	1
	Injector Nozzle O-Ring	1987-1996			GS33276
Oil Pan Drain Plug Gst.	1984-1997			2051	1
	1982			2051	1
Oil Pump Shaft Retainer	1984-1997			H31354	1
	1982			H31354	1
Plenum Tube	1985-1992	8		MS12343A	1
Therm. Housing Gasket	1994-1997	P	<i>Victo-Tech</i>	C31273	1
Throttle Body Gasket	1992-1997	P		G31283	1
	1991-1993	7		G31133	1
	1985-1992	8		G31413	1
	1984	8	Crossfire Fuel Injection	G30828	1
	1982	8	Crossfire Fuel Injection	G30828	1
Valve Cover Grommet	1993-1996			GS33306	1
Water Outlet Gasket	1994-1997	P	<i>Victo-Tech</i>	C31273	1
	1990-1993	7		C25930	1
	1984-1992	8		C25930	1
	1982	8		C25930	1
Water Pump Backing Plate	1984-1993			K27091	1
	1982			K27091	1
Water Pump Mount Gasket	1992-1997	P		K31277	2
	1990-1993	7		K25935	2
	1984-1992	8		K25935	2
	1982	8		K25935	2

101 350 CID (5.7L) LT5 DOHC Chevrolet V8 Cyl, 4.000in./101.6mm (1993) **101**

Part	Year	VIN	Model/Application	Part Number	Qty.
ENGINE GASKETS					
Rear Main Seal Set	1993		(1 Piece)	JV554	1
Crank Repair Sleeve	1993		Use With Part Number A506, Rear <i>Nickel Plated Formed Steel, .013" Oversize</i>	A338	1
MISCELLANEOUS GASKETS					
Injector Nozzle O-Ring	1993			GS33276	4
Oil Pan Drain Plug Gst.	1993			2051	1

PASSENGER CAR

101 350 CID (5.7L) LT5 DOHC Chevrolet V8 Cyl, 4.000in./101.6mm (1993) **101**
(cont.) (cont.)

Part Year VIN Model/Application Part Number Qty.

MISCELLANEOUS GASKETS (cont.)

Oil Pump Shaft Retainer	1993			H31354	1
-------------------------	------	--	--	--------	---

102 350 CID (5.7L) Oldsmobile V8 Cyl, 4.057in./103mm (1968-1980) **102**

Part Year VIN Model/Application Part Number Qty.

ENGINE GASKETS

Head Set	1977-1980		(Exhaust Pipe Gasket Not Included, Intake Manifold Gasket Not Included)	HS3533	1
	1968-1976		(Exhaust Pipe Gasket Not Included, Intake Manifold Gasket Not Included)	HS3436VC	1
Full Set	1977-1980		(Exhaust Pipe Gasket Not Included, Intake Manifold Gasket Not Included)	FS3533	1
	1968-1976		(Exhaust Pipe Gasket Not Included, Intake Manifold Gasket Not Included)	FS3436VC	1
Engine Kit Gasket Set	1977-1980		(Intake Manifold Gasket Not Included), Use With Part Number MS15932	95-3047VR	1
	1973-1976		(Intake Manifold Gasket Not Included), Use With Part Number MS15932	95-3015VR	1
	1968-1972		(Intake Manifold Gasket Not Included), Use With Part Number MS15925	95-3015VR	1
Cylinder Head Gasket	1977-1980		VR2000	3533	2
	1968-1976		VR2000	3436VC	2
Valve Cover Set	1968-1980		Cork Rubber	VS38305	1
			High Temperature Cork Rubber	VS38305H	1
			Victo-Tech	VS38305R	1
			Tuff-Cork	VS38305TC	1
Valve Stem Seal, Exh.	1968-1980			B45416	8
Valve Stem Seal, Int.	1968-1980			B45416	8
Manifold Set, Exhaust	1968-1980			MS15141	1
Manifold Set, Intake	1973-1980			MS15932	1
	1968-1972		(2 Piece)	MS15122	1
			Valley Pan Design	MS15925	1
Oil Pan Set	1968-1980		Cork Rubber	OS30534	1
			Tuff-Cork	OS30534TC	1
Rear Main Seal Set	1974-1980		Molded Rubber	JV748	1
			Rope Packing	JV749	1
			Rope Packing	JV741	1
Timing Cover Set	1968-1980		(Repair Sleeve Not Included)	JV845	1
			(Contains Repair Sleeve)	JV927	1
Timing Cover Gasket	1968-1980			T27823	1
Timing Cover Seal	1968-1980			47398	1
Harmonic Balancer Repair Sleeve	1968-1980		Ground Steel, .020" Thickness	66590RS	1
			Use With Part Number A500 Nickel Plated Formed Steel, .013" Oversize	A222	1

MISCELLANEOUS GASKETS

Air Cleaner Mount Gasket	1968-1980		4 Barrel Carburetor	G27098	1
	1968-1976		2 Barrel Carburetor	G26617	1
Carb. Mount Gasket	1977-1980		4 Barrel Carburetor	G26723	1
	1968-1976		4 Barrel Carburetor	G26658	1
Choke Tube Gasket	1968-1980			B45786	1
Dist. Mounting Gasket	1968-1980			72219	1
E.G.R. Gasket	1977-1980			G17797	1
Exhaust Pipe Gasket	1980		Electra Estate Wagon, (Ring Type 'E'), Pipe To Manifold	F7207	1
	1979-1980		Eldorado, (Ring Type 'D'), Pipe To Manifold	F7208	2
	1977-1980		Custom Cruiser, Electra, Estate Wagon, Fleetwood 75, Le Sabre, Riviera, Skylark, (Ring Type 'E'), Pipe To Manifold	F7207	1

General Motors Corp.

102 350 CID (5.7L) Oldsmobile V8 Cyl, 4.057in./103mm (1968-1980) **102**
 (cont.) (cont.)

Part	Year	VIN	Model/Application	Part Number	Qty.
MISCELLANEOUS GASKETS (cont.)					
Exhaust Pipe Gasket (cont.)	1977-1980		Toronado, (Ring Type 'D'), Pipe To Manifold	F7208	2
	1976-1980		Bonneville, Catalina, Ninety Eight, (Ring Type 'E'), Pipe To Manifold	F7207	1
	1975-1980		Cutlass, Delta 88, Delta 88 Royale, Seville, (Ring Type 'E'), Pipe To Manifold	F7207	1
	1977-1979		Century, LeMans, (Ring Type 'E'), Pipe To Manifold	F7207	1
	1977		Commercial Chassis, Eldorado, Firebird, Grand Prix, Regal, Ventura, (Ring Type 'E'), Pipe To Manifold	F7207	1
	1975-1977		Cutlass 'S', Cutlass Salon, Cutlass Supreme, (Ring Type 'E'), Pipe To Manifold	F7207	1
	1975		Vista Cruiser, (Ring Type 'E'), Pipe To Manifold	F7207	1
	1968-1974		(Ring Type 'D'), Pipe To Manifold	F7187	1
Fuel Pump Gasket	1968-1980			D26606	1
			Tuff-Cork	D26606TC	1
Injector Nozzle O-Ring	1976-1980			GS33280	1
Oil Filter Mount Gasket	1968-1980			B26607	1
Oil Pan Drain Plug Gst.	1968-1980			2051	1
Oil Pump Cover Gasket	1977-1980			B45813	1
Water Outlet Gasket	1968-1980			C24111	1
Water Pump Gasket	1979-1980		Except Air Conditioning, Except Heavy Duty Cooling Tuff-Cork	K27821ATC	1
Water Pump Mount Gasket	1968-1980		Air Conditioning, Heavy Duty Cooling	K27156	1
			Air Conditioning, Heavy Duty Cooling Tuff-Cork	K27156TC	1
			Except Air Conditioning, Except Heavy Duty Cooling	K27821A	1
			Except Air Conditioning, Except Heavy Duty Cooling Tuff-Cork	K27821ATC	1

103 350 CID (5.7L) Oldsmobile Diesel V8 Cyl, 4.057in./103mm (1978-1985) **103**

Part	Year	VIN	Model/Application	Part Number	Qty.
ENGINE GASKETS					
Head Set	1981-1985		2 Stud Air Cleaner, Internal Exhaust Gas Recirculation, (Exhaust Gasket Not Included)	HS3685W	1
			.010" Thicker And .030" Overbore Cylinder Head Gasket, 2 Stud Air Cleaner, Internal Exhaust Gas Recirculation	HS3736W	1
	1978-1981		1 Stud Air Cleaner, External Exhaust Gas Recirculation, (Exhaust Pipe Gasket Not Included)	HS3685	1
			External Exhaust Gas Recirculation, (Exhaust Gasket Not Included)	HS3685	1
Full Set	1981-1985		2 Stud Air Cleaner, Internal Exhaust Gas Recirculation, (Exhaust Gasket Not Included)	FS3685W	1
			.010" Thicker And .030" Overbore Cylinder Head Gasket, 2 Stud Air Cleaner, Internal Exhaust Gas Recirculation, (Exhaust Gasket Not Included)	FS3736W	1
	1978-1981		1 Stud Air Cleaner, External Exhaust Gas Recirculation, (Exhaust Gasket Not Included)	FS3685	1
			.010" Thicker And .030" Overbore Cylinder Head Gasket, 1 Stud Air Cleaner, External Exhaust Gas Recirculation, (Exhaust Gasket Not Included)	FS3736	1
Engine Kit Gasket Set	1981-1985		Internal Exhaust Gas Recirculation, (Intake Manifold Gasket Not Included), Use With Part Number MS15321	95-3085VR	1
	1978-1981		External Exhaust Gas Recirculation, (Intake Manifold Gasket Not Included), Use With Part Number MS15122	95-3085VR	1
Cylinder Head Gasket	1978-1985		Solicor	3685SCR	2

PASSENGER CAR

103 350 CID (5.7L) Oldsmobile Diesel V8 Cyl, 4.057in./103mm (1978-1985)

103

(cont.)

(cont.)

Part	Year	VIN	Model/Application	Part Number	Qty.
ENGINE GASKETS (cont.)					
Cylinder Head Gasket (cont.)	1978-1985		.010" Thicker And .030" Overbore Cylinder Head Gasket <i>Nitroseal</i>	3736	2
Valve Cover Set	1978-1985		<i>Cork Rubber</i>	VS38305	1
			<i>High Temperature Cork Rubber</i>	VS38305H	1
			<i>Victo-Tech</i>	VS38305R	1
			<i>Tuff-Cork</i>	VS38305TC	1
Valve Stem Seal, Exh.	1978-1985			B45416	8
Valve Stem Seal, Int.	1978-1985			B45416	8
Manifold Set, Exhaust	1978-1985			MS15141	1
Manifold Set, Intake	1981-1985		2 Stud Air Cleaner, Internal Exhaust Gas Recirculation	MS15321	1
	1978-1981		1 Stud Air Cleaner, External Exhaust Gas Recirculation	MS15122	1
Oil Pan Set	1978-1985		<i>Tuff-Cork</i>	OS30534TC	1
Rear Main Seal Set	1978-1985		<i>Molded Rubber</i>	JV618	1
			<i>Rope Packing</i>	JV749	1
Timing Cover Set	1978-1985		(Repair Sleeve Not Included)	JV845	1
Timing Cover Gasket	1978-1985			T27823	1
Timing Cover Seal	1978-1985			47398	1
Harmonic Balancer Repair Sleeve	1978-1985		Use With Part Number A500 <i>Nickel Plated Formed Steel, .013" Oversize</i>	A231	1
MISCELLANEOUS GASKETS					
Air Cleaner Mount Gasket	1978-1985		Indirect Injection	G27098	1
Air Crossover Gasket	1981-1985		2 Stud Air Cleaner, Internal Exhaust Gas Recirculation	H30786	2
	1978-1981		1 Stud Air Cleaner, External Exhaust Gas Recirculation	H30787	2
E.G.R. Gasket	1982-1985			G26280	1
Exhaust Pipe Gasket	1985		Rear Wheel Drive, (Ring Type 'E'), Pipe To Manifold	F7219	1
	1979-1985		Front Wheel Drive, (Ring Type 'D'), Pipe To Manifold	F7208	2
	1982-1984		Except Flow Restricting Washer, Rear Wheel Drive, (Ring Type 'E'), Pipe To Manifold	F7207	1
			Flow Restricting Washer, Rear Wheel Drive, (Ring Type 'E'), Pipe To Manifold	F7399	1
	1981-1984		California, Canadian, Except Flow Restricting Washer, Rear Wheel Drive, (Ring Type 'E'), Pipe To Manifold	F7207	1
	1981		California, Canadian, (Ring Type 'E'), Pipe To Manifold	F7207	1
			Except California, Except Canadian Models, (Ring Type 'E'), Pipe To Manifold	F7219	1
	1978-1981		California, Canadian, Rear Wheel Drive, (Ring Type 'E'), Pipe To Manifold	F7207	1
1978-1980		Rear Wheel Drive, (Ring Type 'E'), Pipe To Manifold	F7207	1	
Fuel Pump Gasket	1978-1985			D26606	1
			<i>Tuff-Cork</i>	D26606TC	1
Inj. Pump Mtg. Adapter	1978-1985			72216	1
Inj. Pump Mtg. Gasket	1978-1985			B26350	1
Oil Filter Mount Gasket	1980-1984			B26607	1
Oil Pan Drain Plug Gst.	1978-1985			2051	1
Oil Pump Cover Gasket	1980-1985			B45813	1
Water Outlet Gasket	1978-1985			C24111	1
Water Pump Mount Gasket	1978-1985		Air Conditioning, Heavy Duty Cooling	K27156	1
			Air Conditioning, Heavy Duty Cooling <i>Tuff-Cork</i>	K27156TC	1
			Except Air Conditioning, Except Heavy Duty Cooling	K27821A	1
			Except Air Conditioning, Except Heavy Duty Cooling <i>Tuff-Cork</i>	K27821ATC	1

General Motors Corp.

104 350 CID (5.7L) Pontiac V8 Cyl, 3.875in./98.4mm (1968-1977)

104

Part	Year	VIN	Model/Application	Part Number	Qty.
ENGINE GASKETS					
Head Set	1968-1977			HS3401E	1
Full Set	1972-1977			FS3401X	1
	1968-1971			FS3401W	1
Engine Kit Gasket Set	1972-1977			95-3398VR	1
	1968-1971			95-3397VR	1
Cylinder Head Gasket	1968-1977		VR2000	3401VC	1
Valve Cover Set	1968-1977		Cork Rubber	VS38291X	1
			High Temperature Cork Rubber	VS38291XH	1
Valve Stem Seal, Exh.	1968-1977		(O-Ring Type)	B45229	8
Valve Stem Seal, Int.	1968-1977		(O-Ring Type)	B45229	8
Manifold Set, Exhaust	1968-1977			MS15085W	1
Manifold Set, Intake	1972-1977			MS15186	1
	1968-1971			MS15135	1
Oil Pan Set	1972-1977		Cork Rubber	OS20491	1
			Tuff-Cork	OS20491TC	1
	1968-1971		Cork Rubber	OS20526A	1
Rear Main Seal Set	1968-1977			JV708	1
Timing Cover Set	1968-1977		(Repair Sleeve Not Included)	JV877	1
			(Contains Repair Sleeve)	JV920	1
Timing Cover Gasket	1968-1977			T27812	1
Harmonic Balancer Repair Sleeve	1968-1977		Ground Steel, .020" Thickness	66601RS	1
			Use With Part Number A502 Nickel Plated Formed Steel, .013" Thickness	A229-1	1

MISCELLANEOUS GASKETS

Air Cleaner Mount Gasket	1976-1977		4 Barrel Carburetor	G27098	1
	1968-1976		2 Barrel Carburetor	G26617	1
	1968-1969		4 Barrel Carburetor	G27098	1
Carb. Mount Gasket	1976-1977		4 Barrel Carburetor	G26720	1
	1975-1976		2 Barrel Carburetor	G26725	1
	1973-1974		2 Barrel Carburetor	G26724	1
	1968-1972		2 Barrel Carburetor	G25452	1
	1968-1969		4 Barrel Carburetor	G26656	1
Choke Tube Gasket	1975-1976			B45819	1
Dist. Mounting Gasket	1968-1977			B25941	1
E.G.R. Gasket	1977			G26747	1
	1973-1974			G26747	1
Fuel Pump Gasket	1968-1977			D27094	1
			Tuff-Cork	D27094TC	1
Oil Filter Mount Gasket	1968-1977			B7147	1
Oil Pan Drain Plug Gst.	1968-1977			2051	1
Oil Pump Mounting Gasket	1968-1977			B26457	1
Push Rod Cover Set	1968-1977		Cork Rubber	PS38781	1
Water Outlet Gasket	1968-1977			C24109	1
Water Pump Gasket	1972-1977			K27149	2
Water Pump Mount Gasket	1969-1977			K27149	2
	1968			K27818	2
Water Pump Tube Seal	1968-1971			B45687	2

105 364 CID (6.0L) Buick V8 Cyl, 4.125in./104.8mm (1957-1961)

105

Part	Year	VIN	Model/Application	Part Number	Qty.
ENGINE GASKETS					
Head Set	1957-1961			HS1191VE	1

105 364 CID (6.0L) Buick V8 Cyl, 4.125in./104.8mm (1957-1961) **105**
(cont.) (cont.)

Part	Year	VIN	Model/Application	Part Number	Qty.
ENGINE GASKETS (cont.)					
Full Set	1957-1961			FS1191VE	1
Cylinder Head Gasket	1957-1961		VR2000	1191VC	2
Valve Cover Set	1957-1961		Cork Rubber	VS38117	1
Valve Stem Seal, Int.	1957-1961			B45750	8
Manifold Set, Exhaust	1957-1961			MS15131	1
Manifold Set, Intake	1957-1961			MS15068	1
Oil Pan Set	1957-1961		Cork Rubber	OS30763	1
Rear Main Seal Set	1957-1961			JV742	1
Timing Cover Set	1957-1961			JV788	1

MISCELLANEOUS GASKETS

Air Cleaner Mount Gasket	1957-1961		2 Barrel Carburetor	G25936	1
			4 Barrel Carburetor	G26410	1
Dist. Mounting Gasket	1957-1961			72216	1
Fuel Pump Gasket	1957-1961			D27094	1
				Tuff-Cork	D27094TC
Oil Pan Drain Plug Gst.	1957-1961			2051	1
Push Rod Cover Set	1957-1961		Cork Rubber	PS38525	1
Water Manifold Gasket	1957-1961			C17961	2
Water Man. O-Ring	1957-1961			C45257	1
Water Outlet Gasket	1957-1961			C26565	1
Water Pump Mount Gasket	1957-1961			K27580	1

106 365 CID (6.0L) Cadillac V8 Cyl, 4.000in./101.6mm (1957-1958) **106**

Part	Year	VIN	Model/Application	Part Number	Qty.
ENGINE GASKETS					
Head Set	1957-1958			HS1160BX	1
Full Set	1958		After Engine Number 50990	FS1160BY	1
Cylinder Head Gasket	1957-1958		Beaded Steel	1160BS	2
Valve Cover Set	1957-1958		Cork Rubber	VS38277	1
Valve Stem Seal, Exh.	1957-1958			B45233	8
Valve Stem Seal, Int.	1957-1958			B45233	8
Manifold Set, Exhaust	1957-1958			MS7115	1
Manifold Set, Intake	1957-1958			MS15038X	1
Oil Pan Set	1957-1958		Cork Rubber	OS30494	1
Rear Main Seal Set	1958		After Engine Number 50990	JV705	1
	1957-1958		Thru Engine Number 50990	JV677	1
Timing Cover Set	1957-1958			JV801	1
Timing Cover Seal	1957-1958			46070	1

MISCELLANEOUS GASKETS

Air Cleaner Mount Gasket	1957-1958		4 Barrel Carburetor	G26410	3
Carb. Mount Gasket	1957-1958		3-2 Barrel Carburetors	G7360	2
			4 Barrel Carburetor	G14565	2
Exhaust Pipe Gasket	1957-1958		(Flange Type), Pipe To Manifold	F5436AK	3
Fuel Pump Gasket	1957-1958			D27094	1
				Tuff-Cork	D27094TC
Heat Riser Gasket	1957-1958		(Flange Type)	F5436AK	3
Oil Pan Drain Plug Gst.	1957-1958			2051	1
Push Rod Cover Set	1957-1958		Cork Rubber	PS38398	1
Water Pump Mount Gasket	1957-1958		Body To Cylinder Head	K25916	1
				K25917	2

General Motors Corp.

107 368 CID (6.0L) Cadillac V8 Cyl, 3.800in./96.5mm (1980-1985) 107

Part	Year	VIN	Model/Application	Part Number	Qty.	
ENGINE GASKETS						
Head Set	1980-1985		(Valve Stem Seals Not Included, Exhaust Pipe Gasket Not Included, Intake Manifold Gasket Not Included)	HS3937	1	
Full Set	1980-1985		(Valve Stem Seals Not Included, Exhaust Pipe Gasket Not Included, Intake Manifold Gasket Not Included)	FS3937	1	
Engine Kit Gasket Set	1980-1984		Steel Oil Pan, (Intake Manifold Gasket Not Included), Use With Part Number MS15961	95-3122VR	1	
Cylinder Head Gasket	1980-1985		VR2000	3937	2	
Valve Cover Set	1980-1985		Original Equipment Uses RTV, Plastic Cover	Silicone	JV6	1
			Steel Cover	Cork Rubber	VS38321	1
Manifold Set, Exhaust	1980-1985			MS15337	1	
Manifold Set, Intake	1980-1985			MS15961	1	
Oil Pan Set	1980-1985		Original Equipment Uses RTV, Plastic Pan	Silicone	JV6	1
			Steel Oil Pan		OS20933	1
Rear Main Seal Set	1980-1985			JV600	1	
Timing Cover Set	1980-1985			JV884	1	
Timing Cover Seal	1980-1985			47453	1	

MISCELLANEOUS GASKETS

Air Cleaner Mount Gasket	1980-1985		4 Barrel Carburetor	G27098	1
Carb. Mount Gasket	1980-1985		4 Barrel Carburetor	G14746	1
E.G.R. Gasket	1980-1985			G26315	1
Exhaust Pipe Gasket	1980-1985		(Ring Type 'D'), Pipe To Manifold	F7208	1
Fuel Pump Gasket	1980-1985			D26606	1
				Tuff-Cork	D26606TC
Therm. Mount Gasket	1980-1985			C26181	1
Throttle Body Gasket	1980-1985			G31362	1
Water Outlet Gasket	1980-1985			C26181	1
Water Pump Mount Gasket	1980-1985			K27144	1

108 370 CID (6.1L) Pontiac V8 Cyl, 4.063in./103.2mm (1958) 108

Part	Year	VIN	Model/Application	Part Number	Qty.
ENGINE GASKETS					
Cylinder Head Gasket	1958		Layered Steel	3493	2
Manifold Set, Exhaust	1958			MS15085W	1
Timing Cover Set	1958			JV817	1

109 389 CID (6.4L) Pontiac V8 Cyl, 4.063in./103.2mm (1961-1966) 109

Part	Year	VIN	Model/Application	Part Number	Qty.
ENGINE GASKETS					
Head Set	1961-1966			HS3493E	1
Full Set	1961-1966			FS3493F	1
Engine Kit Gasket Set	1965-1966			95-3397VR	1
Cylinder Head Gasket	1961-1966		Layered Steel	3493	2
Valve Cover Set	1961-1966		Cork Rubber	VS38291X	1
			High Temperature Cork Rubber	VS38291XH	1
Valve Stem Seal, Exh.	1961-1966		(O-Ring Type)	B45229	8
Valve Stem Seal, Int.	1961-1966		(O-Ring Type)	B45229	8
Manifold Set, Exhaust	1961-1966			MS15085W	1
Manifold Set, Intake	1965-1966			MS15135	1
	1961-1964			MS15100X	1
Oil Pan Set	1961-1966		Cork Rubber	OS20526A	1
Rear Main Seal Set	1961-1966			JV708	1
Timing Cover Set	1964-1966		(Repair Sleeve Not Included)	JV877	1
			(Contains Repair Sleeve)	JV920	1
	1961-1963			JV817	1

109 389 CID (6.4L) Pontiac V8 Cyl, 4.063in./103.2mm (1961-1966) **109**
 (cont.) (cont.)

Part Year VIN Model/Application Part Number Qty.

ENGINE GASKETS (cont.)

Timing Cover Gasket	1961-1966			T27806	1
Harmonic Balancer Repair Sleeve	1961-1966		Ground Steel, .020" Oversize	66601RS	1
			Use With Part Number A502 Nickel Plated Formed Steel, .013" Oversize	A229-1	1

MISCELLANEOUS GASKETS

Air Cleaner Mount Gasket	1961-1966		2 Barrel Carburetor	G25936	1
			4 Barrel Carburetor	G26410	1
Carb. Mount Gasket	1966		2 Barrel Carburetor	G25452	1
	1964-1966		4 Barrel Carburetor	G14554	1
	1961-1966		3-2 Barrel Carburetors, Front, Rear	G25452	3
	1961-1965		3-2 Barrel Carburetors, Center	G17937	1
			2 Barrel Carburetor	G25452	1
Choke Tube Gasket	1961-1966			B45783	1
Dist. Mounting Gasket	1961-1966			B25941	1
Exhaust Pipe Gasket	1966		Crossover Pipe	F9835K	2
	1961-1966		Dual Pipe, Performance, (Ring Type 'A'), Crossover Pipe, Pipe To Manifold	F9835K	2
	1961-1964		(Ring Type 'A', For Single Pipe Applications Use 1 Gasket), Pipe To Manifold	F7130	2
Fuel Pump Gasket	1961-1966			D27094	1
			Tuff-Cork	D27094TC	1
Oil Filter Mount Gasket	1961-1966			B7147	1
Oil Pan Drain Plug Gst.	1961-1966			2051	1
Oil Pump Mounting Gasket	1961-1966			B26457	1
Push Rod Cover Set	1965-1966		Cork Rubber	PS38776	1
	1961-1964		Cork Rubber	PS38985	1
Water Outlet Gasket	1961-1966			C24109	1
Water Pump Mount Gasket	1965-1966			K27818	1
	1961-1964			K27540	1

110 390 CID (6.4L) Cadillac V8 Cyl, 4.000in./101.6mm (1959-1963) **110**

Part Year VIN Model/Application Part Number Qty.

ENGINE GASKETS

Head Set	1959-1962			HS1160BX	1
Full Set	1963			FS1160BZ	1
	1959-1962			FS1160BY	1
Cylinder Head Gasket	1959-1963		Beaded Steel	1160BS	2
Valve Cover Set	1963		Cork Rubber	VS38302	1
	1959-1962		Cork Rubber	VS38277	1
Valve Stem Seal, Exh.	1959-1963			B45233	8
Valve Stem Seal, Int.	1959-1963			B45233	8
Manifold Set, Exhaust	1959-1963			MS7115	1
Manifold Set, Intake	1959-1963			MS15038X	1
Oil Pan Set	1963			OS20533X	1
	1959-1962		Cork Rubber	OS30494	1
Rear Main Seal Set	1963			JV735	1
	1959-1962			JV705	1
Timing Cover Set	1963			JV841	1
	1959-1962			JV801	1
Timing Cover Seal	1959-1963			47387	1

General Motors Corp.

110 390 CID (6.4L) Cadillac V8 Cyl, 4.000in./101.6mm (1959-1963) **110**
(cont.) (cont.)

Part	Year	VIN	Model/Application	Part Number	Qty.	
MISCELLANEOUS GASKETS						
Air Cleaner Mount Gasket	1959-1963		4 Barrel Carburetor	G26410	1	
Carb. Mount Gasket	1959-1963		4 Barrel Carburetor	G14565	2	
	1960		3-2 Barrel Carburetors, Center	G17937	1	
Exhaust Pipe Gasket	1959-1963		(Flange Type), Pipe To Manifold	F5436AK	3	
Fuel Pump Gasket	1959-1963			D27094	1	
				Tuff-Cork	D27094TC	1
Heat Riser Gasket	1959-1963			F5436AK	3	
Oil Pan Drain Plug Gst.	1959-1963			2051	1	
Push Rod Cover Set	1959-1963			Cork Rubber	PS38398	1
Water Man. O-Ring	1959-1963			C45380	1	
Water Outlet Gasket	1963			C24109	1	
Water Pump Mount Gasket	1963					
				K27814	1	
	1959-1963		Body To Cylinder Head	K25916	1	
	1959-1962			K25917	2	

111 396 CID (6.6L) Chevrolet V8 Cyl, 4.094in./104mm (1965-1970) **111**

Part	Year	VIN	Model/Application	Part Number	Qty.	
ENGINE GASKETS						
Head Set	1965-1970		(Head Bolts Not Included, Special High Performance Intake Manifold Set Not Included)	HS3805VJ	1	
Lower Set	1965-1970		(Requires Head Set To Make Full Set)	CS3805	1	
Full Set	1965-1970		(Head Bolts Not Included, Special High Performance Intake Manifold Set Not Included)	FS3805VJ	1	
Engine Kit Gasket Set	1965-1970		Except Special High Performance Engine	95-3026VR	1	
			Special High Performance Engine, (Intake Manifold Gasket Not Included), Use With Part Number MS15168	95-3026VR	1	
Cylinder Head Gasket	1965-1970		VR2000	3805VC	2	
			(Stainless Steel Flanges)	VR2000	3868VC	2
			(Stainless Steel Flanges)	Nitroseal	3884SG	2
Cyl. Head Bolt Set	1965-1970			GS33287	2	
Valve Cover Set	1965-1970		Cork Rubber	VS38420	1	
			High Temperature Cork Rubber	VS38420H	1	
			Victo-Tech	VS38420R	1	
			Tuff-Cork	VS38420TC	1	
Valve Stem Seal, Exh.	1965-1970		Fluoroelastomer	B45296	8	
Valve Stem Seal, Int.	1965-1970		Fluoroelastomer	B45296	8	
Manifold Set, Exhaust	1965-1970			MS15164	1	
Manifold Set, Intake	1965-1970		Special High Performance Engine	MS15168	1	
			Except High Performance	MS15188	1	
Oil Pan Set	1965-1970		Cork Rubber	OS30931X	1	
Rear Main Seal Set	1965-1970			JV705	1	
Timing Cover Set	1965-1970		(Repair Sleeve Not Included)	JV866	1	
			(Contains Repair Sleeve)	JV929	1	
Timing Cover Gasket	1965-1970			T27119	1	
Timing Cover Seal	1965-1970			46467	1	
Harmonic Balancer Repair Sleeve	1965-1970		Ground Steel, .020" Oversize	66598RS	1	
			Use With Part Number A503 Nickel Plated Formed Steel, .013" Oversize	A230	1	

MISCELLANEOUS GASKETS					
Air Cleaner Mount Gasket	1965-1970		4 Barrel Carburetor	G27098	1
Carb. Mount Gasket	1970		Rochester, 4 Barrel Carburetor	G18565	1
	1968-1970		Holley Carburetor, 4 Barrel Carburetor	G14733	1

111 396 CID (6.6L) Chevrolet V8 Cyl, 4.094in./104mm (1965-1970) **111**
(cont.) (cont.)

Part	Year	VIN	Model/Application	Part Number	Qty.
MISCELLANEOUS GASKETS (cont.)					
Carb. Mount Gasket (cont.)	1969		2 Barrel Carburetor	G12261	1
	1965-1969		Rochester, 4 Barrel Carburetor	G14579	1
	1965-1967		375 Horsepower Engine, Holley Carburetor, 4 Barrel Carburetor	G14733	1
			Except 375 Horsepower Engine, Holley Carburetor, 4 Barrel Carburetor	G14742	1
Dist. Mounting Gasket	1965-1970			B25934	1
Exhaust Pipe Gasket	1965-1970		(Ring Type 'C'), Pipe To Manifold	F7139	2
			(Ring Type 'B'), Pipe To Manifold <i>Sintered Metal</i>	F7139S	1
Fuel Pump Gasket	1965-1970		Plate To Block	D25932	1
			Plate To Block <i>Tuff-Cork</i>	D25932TC	1
			Pump To Plate	D27094	1
			Pump To Plate <i>Tuff-Cork</i>	D27094TC	1
Heat Riser Gasket	1965-1970			F7192	1
Oil Pan Drain Plug Gst.	1965-1970			2051	1
Water Outlet Gasket	1965-1970		(Universal Type)	C24109	1
				C25930	1
Water Pump Backing Plate	1965-1970			K27078	1
Water Pump Mount Gasket	1965-1970			K26632	2

112 400 CID (6.6L) Buick V8 Cyl, 4.040in./102.6mm (1967-1969) **112**

Part	Year	VIN	Model/Application	Part Number	Qty.
ENGINE GASKETS					
Head Set	1967-1969		(Intake Manifold Gasket Not Included)	HS3492VE	1
Full Set	1967-1969		(Intake Manifold Gasket Not Included)	FS3492VE	1
Engine Kit Gasket Set	1967-1969		(Intake Manifold Gasket Not Included), Use With Part Number MS15921X	95-3009VR	1
Cylinder Head Gasket	1967-1969		<i>VR2000</i>	3492	2
Valve Cover Set	1967-1969		<i>Cork Rubber</i>	VS38319	1
Valve Stem Seal, Exh.	1967-1969		<i>Nitrile</i>	B45403	8
Valve Stem Seal, Int.	1967-1969		<i>Nitrile</i>	B45403	8
Manifold Set, Exhaust	1967-1969			MS15200	1
Manifold Set, Intake	1967-1969			MS15921X	1
Oil Pan Set	1967-1969		<i>Cork Rubber</i>	OS31582	1
Rear Main Seal Set	1967-1969			JV742	1
Timing Cover Set	1967-1969			JV860	1

MISCELLANEOUS GASKETS					
Air Cleaner Mount Gasket	1967-1969			G27098	1
Carb. Mount Gasket	1969		4 Barrel Carburetor	G26652	1
Dist. Mounting Gasket	1967-1969			72215	1
Fuel Pump Gasket	1967-1969			D27094	1
				<i>Tuff-Cork</i> D27094TC	1
Oil Pan Drain Plug Gst.	1967-1969			2051	1
Oil Pump Cover Gasket	1967-1969			B45579	1
Water Outlet Gasket	1967-1969			C26515	1
Water Pump Mount Gasket	1967-1969			K27132	1

General Motors Corp.

113 400 CID (6.6L) Chevrolet V8 Cyl, 4.125in./104.8mm (1970-1976)

113

Part	Year	VIN	Model/Application	Part Number	Qty.	
ENGINE GASKETS						
Head Set	1970-1976		(Head Bolts Not Included)	HS3432VJ	1	
Lower Set	1970-1976		(Requires Head Set To Make Full Set)	CS1178	1	
Full Set	1970-1976		(Head Bolts Not Included)	FS3432VJ	1	
Engine Kit Gasket Set	1970-1976			95-3031VR	1	
Cylinder Head Gasket	1970-1976		<i>Nitroseal</i>	3432SG	2	
			(Cylindrical Combustion Chamber Openings, Gasket Has Steam Holes Required For Street Operation) <i>Stainless Steel, 8.8cc Combustion Chamber Volume, 4.190" Combustion Chamber Opening, .040" Compressed Operating Thickness</i>	3512	2	
Cyl. Head Bolt Set	1970-1976			GS33285	2	
Valve Cover Set	1970-1976		<i>Cork Rubber</i>	VS38110	1	
			<i>High Temperature Cork Rubber</i>	VS38110HA	1	
			<i>High Temperature Tuff-Cork</i>	VS38110HTC	1	
			<i>Victo-Tech</i>	VS38110R	1	
			<i>Tuff-Cork</i>	VS38110TC	1	
Valve Stem Seal, Exh.	1970-1976		(O-Ring Type)	B45229	8	
			(Shedder Type)	B45264	8	
			(Shedder Type, High Temperature)	B45779	8	
Valve Stem Seal, Int.	1970-1976		(O-Ring Type)	B45229	8	
			<i>Fluoroelastomer</i>	B45418	8	
Manifold Set, Exhaust	1970-1976			MS7110X	1	
Manifold Set, Intake	1970-1976			MS15315	1	
Oil Pan Set	1975-1976		Left Hand Dip Stick	<i>Victo-Tech</i>	OS30568RLH	1
				<i>Cork Rubber</i>	OS30568Z	1
				<i>Tuff-Cork</i>	OS30568ZTC	1
	1970-1974			<i>Cork Rubber</i>	OS30568X	1
				<i>Tuff-Cork</i>	OS30568XTC	1
Rear Main Seal Set	1970-1976		Align Bored Engine, (Oversize) <i>2.8406" To 2.8415" Outside Diameter</i>	JV1603	1	
			(Lip Relocator Type)	JV1627	1	
Timing Cover Set	1975-1976		(Repair Sleeve Not Included)	JV881	1	
			(Contains Repair Sleeve)	JV926	1	
	1970-1974		(Repair Sleeve Not Included)	JV779	1	
			(Contains Repair Sleeve)	JV919	1	
Timing Cover Gasket	1970-1976			T27781	1	
Timing Cover Seal	1970-1976		<i>3/8" Wide</i>	49328	1	
			(Lip Relocator Type) <i>1/2" Wide</i>	65022	1	
Harmonic Balancer Repair Sleeve	1970-1976		<i>Ground Steel, .020" Thickness</i>	66597RS	1	
			Use With Part Number A504 <i>Nickel Plated Formed Steel, .013" Oversize</i>	A228	1	
MISCELLANEOUS GASKETS						
Air Cleaner Mount Gasket	1970-1976		2 Barrel Carburetor	<i>3-1/16" Outside Diameter</i>	G25936	1
			2 Barrel Carburetor	<i>3-3/16" Outside Diameter</i>	G26617	1
			4 Barrel Carburetor		G27098	1
Carb. Mount Gasket	1974-1976		4 Barrel Carburetor		G26719	1
	1972-1973		2 Barrel Carburetor		G25488	1
	1971-1973		Except Exhaust Emission Control, Except Special High Performance Engine, 4 Barrel Carburetor		G26666	1
	1970-1971		2 Barrel Carburetor		G12261	1
	1970		Except Exhaust Emission Control, Special High Performance Engine, 4 Barrel Carburetor		G14733	1
			Except Exhaust Emission Control, Except Special High Performance Engine, Exhaust Emission Control, 4 Barrel Carburetor, Insulator To Manifold		G18565	1
Choke Tube Gasket	1976				B45787	1
Dist. Mounting Gasket	1970-1976				B25934	1
E.G.R. Gasket	1975-1976				G26748	1

113 400 CID (6.6L) Chevrolet V8 Cyl, 4.125in./104.8mm (1970-1976) **113**
(cont.) (cont.)

Part	Year	VIN	Model/Application	Part Number	Qty.
MISCELLANEOUS GASKETS (cont.)					
E.G.R. Gasket (cont.)	1973-1974			G26338	1
Exhaust Pipe Gasket	1970-1976		(Ring Type 'C'), Pipe To Manifold	F17250	1
			(Ring Type 'B'), Pipe To Manifold <i>Sintered Metal</i>	F17250S	1
Fuel Pump Gasket	1970-1976		Plate To Block	D25932	1
			Plate To Block <i>Tuff-Cork</i>	D25932TC	1
			Pump To Plate	D27094	1
			Pump To Plate <i>Tuff-Cork</i>	D27094TC	1
Heat Riser Gasket	1970-1976		Monte Carlo <i>2.125" Inside Diameter</i>	F7135	1
			<i>2.437" Inside Diameter</i>	F7192	1
Oil Pan Drain Plug Gst.	1970-1976			2051	1
Oil Pump Shaft Retainer	1970-1976			H31354	1
Water Outlet Gasket	1970-1976		(Universal Type)	C24109	1
				C25930	1
Water Pump Backing Plate	1970-1976			K27091	1
Water Pump Mount Gasket	1970-1976			K25935	2

114 400 CID (6.6L) Oldsmobile V8 Cyl, 3.875in./98.4mm (1968-1969) **114**

Part	Year	VIN	Model/Application	Part Number	Qty.
ENGINE GASKETS					
Head Set	1968-1969		(Exhaust Pipe Gasket Not Included, Intake Manifold Gasket Not Included)	HS3436VC	1
Full Set	1968-1969		(Exhaust Pipe Gasket Not Included, Intake Manifold Gasket Not Included)	FS3436VC	1
Engine Kit Gasket Set	1968-1969		(Intake Manifold Gasket Not Included), Use With Part Number MS15810	95-3015VR	1
Cylinder Head Gasket	1968-1969		<i>VR2000</i>	3436VC	2
Valve Cover Set	1968-1969		<i>Cork Rubber</i>	VS38305	1
			<i>High Temperature Cork Rubber</i>	VS38305H	1
			<i>Victo-Tech</i>	VS38305R	1
			<i>Tuff-Cork</i>	VS38305TC	1
Valve Stem Seal, Exh.	1968-1969			B45416	8
Valve Stem Seal, Int.	1968-1969			B45416	8
Manifold Set, Exhaust	1968-1969			MS15141	1
Manifold Set, Intake	1968-1969			MS15810	1
Oil Pan Set	1968-1969		<i>Cork Rubber</i>	OS30534	1
			<i>Tuff-Cork</i>	OS30534TC	1
Rear Main Seal Set	1968-1969		(Not Contained In Full Set) <i>Molded Rubber</i>	JV618	1
			<i>Rope Packing</i>	JV749	1
Timing Cover Set	1968-1969		(Repair Sleeve Not Included)	JV845	1
			(Contains Repair Sleeve)	JV927	1
Timing Cover Gasket	1968-1969			T27823	1
Timing Cover Seal	1968-1969			47398	1
Harmonic Balancer Repair Sleeve	1968-1969		<i>Ground Steel, .020" Thickness</i>	66590RS	1
			Use With Part Number A500 <i>Nickel Plated Formed Steel, .013" Oversize</i>	A222	1

MISCELLANEOUS GASKETS					
Air Cleaner Mount Gasket	1968-1969		4 Barrel Carburetor	G27098	1
	1968		2 Barrel Carburetor	G26617	1
Carb. Mount Gasket	1968-1969		4 Barrel Carburetor	G26723	1
	1968		2 Barrel Carburetor	G25452	1
Choke Tube Gasket	1968-1969			B45786	1

General Motors Corp.

114 400 CID (6.6L) Oldsmobile V8 Cyl, 3.875in./98.4mm (1968-1969) **114**
(cont.) (cont.)

Part	Year	VIN	Model/Application	Part Number	Qty.
MISCELLANEOUS GASKETS (cont.)					
Dist. Mounting Gasket	1968-1969			72219	1
Exhaust Pipe Gasket	1968-1969		(Ring Type 'D'), Pipe To Manifold	F7187	1
Fuel Pump Gasket	1968-1969			D26606	1
				<i>Tuff-Cork</i>	D26606TC
Oil Pan Drain Plug Gst.	1968-1969			2051	1
Water Outlet Gasket	1968-1969			C24111	1
Water Pump Mount Gasket	1968-1969		Air Conditioning, Heavy Duty Cooling	K27156	1
			Air Conditioning, Heavy Duty Cooling	<i>Tuff-Cork</i> K27156TC	1
			Except Air Conditioning, Except Heavy Duty Cooling	K27821A	1
			Except Air Conditioning, Except Heavy Duty Cooling	<i>Tuff-Cork</i> K27821ATC	1

115 400 CID (6.6L) Oldsmobile V8 Cyl, 4.000in./101.6mm (1965-1967) **115**

Part	Year	VIN	Model/Application	Part Number	Qty.
ENGINE GASKETS					
Head Set	1965-1967		(Exhaust Pipe Gasket Not Included, Intake Manifold Gasket Not Included)	HS3436VC	1
Full Set	1965-1967		(Exhaust Pipe Gasket Not Included, Intake Manifold Gasket Not Included)	FS3436VC	1
Engine Kit Gasket Set	1965-1967		(Intake Manifold Gasket Not Included), Use With Part Number MS15810	95-3015VR	1
Cylinder Head Gasket	1965-1967		<i>VR2000</i>	3436VC	2
Valve Cover Set	1965-1967		<i>Cork Rubber</i>	VS38305	1
			<i>High Temperature Cork Rubber</i>	VS38305H	1
			<i>Victo-Tech</i>	VS38305R	1
			<i>Tuff-Cork</i>	VS38305TC	1
Valve Stem Seal, Exh.	1965-1967			B45416	8
Valve Stem Seal, Int.	1965-1967			B45416	8
Manifold Set, Exhaust	1965-1967			MS15141	1
Manifold Set, Intake	1965-1967			MS15810	1
Oil Pan Set	1965-1967		<i>Cork Rubber</i>	OS30534	1
			<i>Tuff-Cork</i>	OS30534TC	1
Rear Main Seal Set	1965-1967		(Not Contained In Full Set) <i>Molded Rubber</i>	JV618	1
			<i>Rope Packing</i>	JV749	1
Timing Cover Set	1965-1967		(Repair Sleeve Not Included)	JV845	1
			(Contains Repair Sleeve)	JV927	1
Timing Cover Gasket	1965-1967			T27823	1
Timing Cover Seal	1965-1967			47398	1
Harmonic Balancer Repair Sleeve	1965-1967		Use With Part Number A500 <i>Nickel Plated Formed Steel, .013" Oversize</i>	A222	1

MISCELLANEOUS GASKETS

Air Cleaner Mount Gasket	1967		2 Barrel Carburetor	G26617	1
	1966-1967		4 Barrel Carburetor	G27098	1
Carb. Mount Gasket	1967		2 Barrel Carburetor	G25452	1
	1966-1967		4 Barrel Carburetor	G26658	1
	1965		4 Barrel Carburetor	G14574	1
Choke Tube Gasket	1965-1967			B45786	1
Dist. Mounting Gasket	1965-1967			72219	1
Exhaust Pipe Gasket	1965-1967		(Ring Type 'D'), Pipe To Manifold	F7187	1
Fuel Pump Gasket	1965-1967			D26606	1
				<i>Tuff-Cork</i>	D26606TC
Oil Pan Drain Plug Gst.	1965-1967			2051	1
Water Outlet Gasket	1965-1967			C24111	1

115 400 CID (6.6L) Oldsmobile V8 Cyl, 4.000in./101.6mm (1965-1967) **115**
(cont.) (cont.)

Part	Year	VIN	Model/Application	Part Number	Qty.
MISCELLANEOUS GASKETS (cont.)					
Water Pump Mount Gasket	1965-1967		Air Conditioning, Heavy Duty Cooling	K27156	1
			Air Conditioning, Heavy Duty Cooling	<i>Tuff-Cork</i> K27156TC	1
			Except Air Conditioning, Except Heavy Duty Cooling	K27821A	1
			Except Air Conditioning, Except Heavy Duty Cooling	<i>Tuff-Cork</i> K27821ATC	1

116 400 CID (6.6L) Pontiac V8 Cyl, 4.120in./104.6mm (1967-1979) **116**

Part	Year	VIN	Model/Application	Part Number	Qty.
ENGINE GASKETS					
Head Set	1967-1979		(Intake And Exhaust Manifold And Push Rod Gaskets Not Included For Ram Air)	HS3494K	1
Full Set	1972-1979			FS3494E	1
	1967-1971		(Intake And Exhaust Manifold Gasket Not Included For Ram Air)	FS3494J	1
Engine Kit Gasket Set	1972-1979			95-3398VR	1
	1968-1971		Except Ram Air	95-3397VR	1
	1967		Use With Part Number VS38291XH	95-3397VR	1
Cylinder Head Gasket	1967-1979		<i>VR2000</i>	3494VC	2
Valve Cover Set	1967-1979		<i>Cork Rubber</i>	VS38291X	1
			<i>High Temperature Cork Rubber</i>	VS38291XH	1
Valve Stem Seal, Exh.	1967-1979		(O-Ring Type)	B45229	8
Valve Stem Seal, Int.	1967-1979		(O-Ring Type)	B45229	8
			(Positive Type)	B45299	8
Manifold Set, Exhaust	1972-1979			MS15085W	1
	1967-1971		Except Ram Air	MS15085W	1
			Ram Air	MS15177	1
Manifold Set, Intake	1972-1979			MS15186	1
	1967-1971		Except Ram Air	MS15135	1
			Ram Air	MS15174	1
Oil Pan Set	1972-1979		<i>Cork Rubber</i>	OS20491	1
			<i>Tuff-Cork</i>	OS20491TC	1
			<i>Cork Rubber</i>	OS20526A	1
Rear Main Seal Set	1967-1979			JV708	1
Timing Cover Set	1967-1979		(Repair Sleeve Not Included)	JV877	1
			(Contains Repair Sleeve)	JV920	1
Timing Cover Gasket	1975-1979			T27812	1
	1967-1974			T27806	1
Harmonic Balancer Repair Sleeve	1967-1979		<i>Ground Steel, .020" Oversize</i>	66601RS	1
			Use With Part Number A502 <i>Nickel Plated Formed Steel, .013" Oversize</i>	A229-1	1

MISCELLANEOUS GASKETS

Air Cleaner Mount Gasket	1967-1979		2 Barrel Carburetor	G26617	1
			4 Barrel Carburetor	G27098	1
Carb. Mount Gasket	1975-1979		4 Barrel Carburetor	G26720	1
	1975-1976		2 Barrel Carburetor	G26725	1
	1973-1974		2 Barrel Carburetor	G26724	1
	1968-1974		4 Barrel Carburetor	G26658	1
	1972		2 Barrel Carburetor	G25452	1
	1967-1970		2 Barrel Carburetor	G25452	1
	1967		4 Barrel Carburetor, Rochester	G14579	1
Dist. Mounting Gasket	1967-1979			B25941	1
E.G.R. Gasket	1975-1979			G26747	2
Fuel Pump Gasket	1967-1979			D27094	1
			<i>Tuff-Cork</i>	D27094TC	1

General Motors Corp.

116 400 CID (6.6L) Pontiac V8 Cyl, 4.120in./104.6mm (1967-1979) **116**
(cont.) (cont.)

Part	Year	VIN	Model/Application	Part Number	Qty.	
MISCELLANEOUS GASKETS (cont.)						
Oil Filter Mount Gasket	1967-1979		Except High Output Engine, Except Ram Air	B7147	1	
Oil Pan Drain Plug Gst.	1967-1979			2051	1	
Oil Pump Mounting Gasket	1967-1977			B26457	1	
Push Rod Cover Set	1972-1979		Cork Rubber	PS38781	1	
	1967-1971		Ram Air	Cork Rubber	PS38776	1
				Except Ram Air	Cork Rubber	PS38781
Water Outlet Gasket	1967-1979			C24109	1	
Water Pump Mount Gasket	1969-1979			K27149	2	
	1967-1968			K27818	2	
Water Pump Tube Seal	1970-1979			B45687	2	
	1967-1968			B45687	2	

117 401 CID (6.6L) Buick V8 Cyl, 4.188in./106.4mm (1959-1966) **117**

Part	Year	VIN	Model/Application	Part Number	Qty.
ENGINE GASKETS					
Head Set	1959-1966			HS1191VE	1
Full Set	1959-1966			FS1191VE	1
Cylinder Head Gasket	1959-1966		VR2000	1191VC	2
Valve Cover Set	1964-1966		Cork Rubber	VS38122	1
	1959-1963		Cork Rubber	VS38117	1
Valve Stem Seal, Int.	1959-1966			B45750	8
Manifold Set, Exhaust	1959-1966			MS15131	1
Manifold Set, Intake	1959-1966			MS15068	1
Oil Pan Set	1959-1966		Cork Rubber	OS30763	1
Rear Main Seal Set	1959-1966			JV742	1
Timing Cover Set	1959-1966			JV788	1

MISCELLANEOUS GASKETS

Air Cleaner Mount Gasket	1966		High Performance Engine, 4 Barrel Carburetor	G27098	1
	1959-1966		4 Barrel Carburetor	G26410	1
	1962-1963		2 Barrel Carburetor	G26617	1
Carb. Mount Gasket	1959-1966		4 Barrel Carburetor	G14553	1
	1962		Positive Vent, 2 Barrel Carburetor	G17937	1
Dist. Mounting Gasket	1965-1966			72215	1
	1959-1966			72216	1
Fuel Pump Gasket	1959-1966			D27094	1
				Tuff-Cork	D27094TC
Oil Pan Drain Plug Gst.	1959-1966			2051	1
Push Rod Cover Set	1959-1966		Cork Rubber	PS38525	1
Therm. Mount Gasket	1959-1966			C26565	1
Water Manifold Gasket	1959-1966			C17961	2
Water Man. O-Ring	1959-1966			C45257	1
Water Outlet Gasket	1959-1966			C26565	1
Water Pump Mount Gasket	1962-1966			K27580	1

118 402 CID (6.6L) Chevrolet V8 Cyl, 4.125in./104.8mm (1970-1972) **118**

Part	Year	VIN	Model/Application	Part Number	Qty.
ENGINE GASKETS					
Head Set	1970-1972		(Head Bolts Not Included, Contains High Temperature Shedder Type Valve Stem Seals)	HS3805VJ	1

118 402 CID (6.6L) Chevrolet V8 Cyl, 4.125in./104.8mm (1970-1972) **118**
(cont.) (cont.)

Part	Year	VIN	Model/Application	Part Number	Qty.
ENGINE GASKETS (cont.)					
Lower Set	1970-1972		(Requires Head Set To Make Full Set)	CS3805	1
Full Set	1970-1972		(Head Bolts Not Included, Contains High Temperature Shedder Type Valve Stem Seals)	FS3805VJ	1
Engine Kit Gasket Set	1970-1972			95-3026VR	1
Cylinder Head Gasket	1970-1972		VR2000	3805VC	2
			Nitroseal	3884SG	2
Cyl. Head Bolt Set	1970-1972			GS33287	2
Valve Cover Set	1970-1972		Cork Rubber	VS38420	1
			Victo-Tech	VS38420R	1
Valve Stem Seal, Exh.	1970-1972		Fluoroelastomer	B45296	8
Valve Stem Seal, Int.	1970-1972		Fluoroelastomer	B45296	8
Manifold Set, Exhaust	1970-1972			MS15164	1
Manifold Set, Intake	1970-1972			MS15188	1
Oil Pan Set	1970-1972		Cork Rubber	OS30931X	1
Rear Main Seal Set	1970-1972			JV705	1
Timing Cover Set	1970-1972		(Repair Sleeve Not Included)	JV866	1
			(Contains Repair Sleeve)	JV929	1
Timing Cover Gasket	1970-1972			T27119	1
Timing Cover Seal	1970-1972			46467	1
Harmonic Balancer Repair Sleeve	1970-1972		Ground Steel, .020" Oversize	66598RS	1
			Use With Part Number A503 Nickel Plated Formed Steel, .013" Oversize	A230	1

MISCELLANEOUS GASKETS

Air Cleaner Mount Gasket	1970-1972		4 Barrel Carburetor	G27098	1
Carb. Mount Gasket	1971-1972		Except Performance Engine, 4 Barrel Carburetor	G26666	1
	1970		Except Performance Engine, Exhaust Emission Control, 4 Barrel Carburetor, Shield To Manifold	G18565	1
			Except Performance Engine, Exhaust Emission Control, 4 Barrel Carburetor, Carburetor To Shield	G26664	1
Dist. Mounting Gasket	1970-1972			B25934	1
Exhaust Pipe Gasket	1970-1972		(Ring Type 'C'), Pipe To Manifold	F7139	2
			(Ring Type 'B'), Pipe To Manifold	Sintered Metal F7139S	1
Fuel Pump Gasket	1970-1972			D27094	1
			Tuff-Cork	D27094TC	1
Water Outlet Gasket	1970-1972		(Universal Type)	C24109	1
				C25930	1
Water Pump Backing Plate	1970-1972			K27078	1
Water Pump Mount Gasket	1970-1972			K26632	2

119 403 CID (6.6L) L80 Oldsmobile V8 Cyl, 4.351in./110.5mm (1977-1979) **119**

Part	Year	VIN	Model/Application	Part Number	Qty.
ENGINE GASKETS					
Head Set	1977-1979		(Exhaust Pipe Gasket Not Included, Intake Manifold Gasket Not Included)	HS3534	1
Full Set	1977-1979		(Exhaust Pipe Gasket Not Included, Intake Manifold Gasket Not Included)	FS3534	1
Engine Kit Gasket Set	1977-1979		(Intake Manifold Gasket Not Included), Use With Part Number MS15932	95-3086VR	1
Cylinder Head Gasket	1977-1979		Solicor	3534	2
Valve Cover Set	1977-1979		Cork Rubber	VS38305	1
			High Temperature Cork Rubber	VS38305H	1
			Victo-Tech	VS38305R	1
			Tuff-Cork	VS38305TC	1
Valve Stem Seal, Exh.	1977-1979			B45416	8

General Motors Corp.

119 403 CID (6.6L) L80 Oldsmobile V8 Cyl, 4.351in./110.5mm (1977-1979) **119**
 (cont.) (cont.)

Part	Year	VIN	Model/Application	Part Number	Qty.	
ENGINE GASKETS (cont.)						
Valve Stem Seal, Int.	1977-1979			B45416	8	
Manifold Set, Exhaust	1977-1979			MS15141	1	
Manifold Set, Intake	1977-1979			MS15932	1	
Oil Pan Set	1977-1979		Cork Rubber	OS30534	1	
			Tuff-Cork	OS30534TC	1	
Rear Main Seal Set	1977-1979		(Not Contained In Full Set)	Molded Rubber	JV748	1
				Rope Packing	JV749	1
Timing Cover Set	1977-1979		(Repair Sleeve Not Included)		JV845	1
			(Contains Repair Sleeve)		JV927	1
Timing Cover Gasket	1977-1979			T27823	1	
Timing Cover Seal	1977-1979			47398	1	
Harmonic Balancer Repair Sleeve	1977-1979		Ground Steel, .020" Thickness	66590RS	1	
			Use With Part Number A500 Nickel Plated Formed Steel, .013" Oversize	A222	1	

MISCELLANEOUS GASKETS

Air Cleaner Mount Gasket	1977-1979		4 Barrel Carburetor	G27098	1	
Carb. Mount Gasket	1977-1979		4 Barrel Carburetor	G26723	1	
Choke Tube Gasket	1977-1979			B45786	1	
Dist. Mounting Gasket	1977-1979			72219	1	
E.G.R. Gasket	1977-1979			G17797	1	
Exhaust Pipe Gasket	1977-1979		Toronado, (Ring Type 'D')	F7187	1	
			Bonneville, Catalina, Century, Custom Cruiser, Electra, Estate Wagon, Firebird, Le Sabre, Ninety Eight, Riviera, (Ring Type 'E')	F7207	1	
			Delta 88, Delta 88 Royale, (Ring Type 'E')	F7207	1	
	1977		Cutlass, Cutlass 'S', Cutlass Salon, Cutlass Supreme, Grand Prix, LeMans, Regal, (Ring Type 'E')	F7207	1	
Fuel Pump Gasket	1977-1979			D26606	1	
				Tuff-Cork	D26606TC	1
Oil Filter Mount Gasket	1977-1979			B26607	1	
Oil Pump Cover Gasket	1977-1979			B45813	1	
Water Outlet Gasket	1977-1979			C24111	1	
Water Pump Mount Gasket	1977-1979		Air Conditioning, Heavy Duty Cooling	K27156	1	
			Air Conditioning, Heavy Duty Cooling	Tuff-Cork	K27156TC	1
			Except Air Conditioning, Except Heavy Duty Cooling		K27821A	1
			Except Air Conditioning, Except Heavy Duty Cooling	Tuff-Cork	K27821ATC	1

120 409 CID (6.7L) Chevrolet V8 Cyl, 4.313in./109.6mm (1961-1965) **120**

Part	Year	VIN	Model/Application	Part Number	Qty.
ENGINE GASKETS					
Head Set	1961-1965		(Exhaust Pipe Gasket Not Included, Exhaust Manifold Gasket Not Included)	HS1195VC	1
Full Set	1961-1965		(Exhaust Pipe Gasket Not Included, Exhaust Manifold Gasket Not Included)	FS1195VC	1
Cylinder Head Gasket	1961-1965		VR2000	1195VC	2
Valve Cover Set	1961-1965		Cork Rubber	VS38408	1
Manifold Set, Exhaust	1961-1965			MS12254	1
Manifold Set, Intake	1961-1965		Performance	MS15115	1
			Except Performance Package	MS18699	1
Oil Pan Set	1961-1965		Cork Rubber	OS30525	1
Rear Main Seal Set	1961-1965			JV699	1
Timing Cover Set	1961-1965			JV802	1

PASSENGER CAR

120 409 CID (6.7L) Chevrolet V8 Cyl, 4.313in./109.6mm (1961-1965) **120**
(cont.) (cont.)

Part Year VIN Model/Application Part Number Qty.

ENGINE GASKETS (cont.)

Timing Cover Seal	1961-1965		3/8" Wide	49328	1
			(Lip Relocator Type) 1/2" Wide	65022	1
Harmonic Balancer Repair Sleeve	1961-1965		Use With Part Number A504 Nickel Plated Formed Steel, .013" Oversize	A228	1

MISCELLANEOUS GASKETS

Air Cleaner Mount Gasket	1963-1965		2-4 Barrel Carburetors	G26410	2
	1961-1965		4 Barrel Carburetor	G27098	1
Carb. Mount Gasket	1963-1965		4 Barrel Carburetor	G14553	1
	1961-1965		2-4 Barrel Carburetors	G7360	1
Exhaust Pipe Gasket	1961-1965		(Ring Type 'C'), Pipe To Manifold	F7139	2
			(Ring Type 'B'), Pipe To Manifold Sintered Metal	F7139S	1
Fuel Pump Gasket	1961-1965		Plate To Block	D25932	1
			Plate To Block Tuff-Cork	D25932TC	1
			Pump To Plate	D27094	1
			Pump To Plate Tuff-Cork	D27094TC	1
Heat Riser Gasket	1961-1965			F7192	1
Water Outlet Gasket	1961-1965		(Universal Type)	C24109	1
				C25930	1
Water Pump Backing Plate	1961-1965			K27078	1
Water Pump Mount Gasket	1961-1965			K26004	2

121 421 CID (6.9L) Pontiac V8 Cyl, 4.094in./104mm (1963-1966) **121**

Part Year VIN Model/Application Part Number Qty.

ENGINE GASKETS

Head Set	1963-1966			HS3493E	1
Full Set	1963-1966			FS3493F	1
Engine Kit Gasket Set	1965-1966		(Valve Cover Set Not Included), Use With Part Number VS38291XH	95-3397VR	1
Cylinder Head Gasket	1963-1966		Layered Steel	3493	2
Valve Cover Set	1963-1966		Cork Rubber	VS38291X	1
			High Temperature Cork Rubber	VS38291XH	1
Valve Stem Seal, Exh.	1963-1966		(O-Ring Type)	B45229	8
Valve Stem Seal, Int.	1963-1966		(O-Ring Type)	B45229	8
Manifold Set, Exhaust	1963-1966			MS15085W	1
Manifold Set, Intake	1965-1966			MS15135	1
	1963-1964			MS15100X	1
Oil Pan Set	1963-1966		Cork Rubber	OS20526A	1
Rear Main Seal Set	1963-1966			JV742	1
Timing Cover Set	1963-1966		(Repair Sleeve Not Included)	JV877	1
			(Contains Repair Sleeve)	JV920	1
Timing Cover Gasket	1963-1966			T27806	1
Harmonic Balancer Repair Sleeve	1963-1966		Ground Steel, .020" Oversize	66601RS	1
			Use With Part Number A502 Nickel Plated Formed Steel, .013" Oversize	A229-1	1

MISCELLANEOUS GASKETS

Air Cleaner Mount Gasket	1963-1966		3-2 Barrel Carburetors, Center	G25936	1
			4 Barrel Carburetor	G26410	1
			3-2 Barrel Carburetors, Front, Rear	G26617	2
Carb. Mount Gasket	1966		3-2 Barrel Carburetors	G25452	3
	1964-1966		4 Barrel Carburetor	G14554	1
	1963-1965		3-2 Barrel Carburetors, Center	G17937	1
			3-2 Barrel Carburetors, Front, Rear	G25452	2

General Motors Corp.

121 421 CID (6.9L) Pontiac V8 Cyl, 4.094in./104mm (1963-1966) **121**
(cont.) (cont.)

Part Year VIN Model/Application Part Number Qty.

MISCELLANEOUS GASKETS (cont.)

Choke Tube Gasket	1963-1966			B45783	1
Dist. Mounting Gasket	1963-1966			B25941	1
Exhaust Pipe Gasket	1963-1966		(Ring Type 'A'), Pipe To Manifold	F7130	2
Fuel Pump Gasket	1963-1966			D27094	1
				<i>Tuff-Cork</i> D27094TC	1
Oil Filter Mount Gasket	1963-1966			B7147	1
Oil Pump Mounting Gasket	1963-1966			B26457	1
Push Rod Cover Set	1965-1966			<i>Cork Rubber</i> PS38776	1
	1963-1964			<i>Cork Rubber</i> PS38985	1
Water Outlet Gasket	1963-1966			C24109	1
Water Pump Mount Gasket	1963-1966			K27818	1

122 425 CID (7.0L) Buick V8 Cyl, 4.313in./109.6mm (1963-1966) **122**

Part Year VIN Model/Application Part Number Qty.

ENGINE GASKETS

Head Set	1963-1966			HS1191VE	1
Full Set	1963-1966			FS1191VE	1
Cylinder Head Gasket	1963-1966			<i>VR2000</i> 1191VC	2
Valve Cover Set	1963-1966			<i>Cork Rubber</i> VS38122	1
Manifold Set, Exhaust	1963-1966			MS15131	1
Manifold Set, Intake	1963-1966			MS15068	1
Oil Pan Set	1963-1966			<i>Cork Rubber</i> OS30763	1
Rear Main Seal Set	1963-1966			JV742	1
Timing Cover Set	1963-1966			JV788	1

MISCELLANEOUS GASKETS

Air Cleaner Mount Gasket	1963-1966		4 Barrel Carburetor	G26410	1
Carb. Mount Gasket	1963-1966		4 Barrel Carburetor	G14553	1
Dist. Mounting Gasket	1963-1966			72216	1
Fuel Pump Gasket	1963-1966			D27094	1
				<i>Tuff-Cork</i> D27094TC	1
Push Rod Cover Set	1963-1966			<i>Cork Rubber</i> PS38525	1
Therm. Mount Gasket	1963-1966			C26565	1
Water Manifold Gasket	1963-1966			C17961	2
Water Man. O-Ring	1963-1966			C45257	1
Water Outlet Gasket	1963-1966			C26565	1
Water Pump Mount Gasket	1963-1966			K27580	1

123 425 CID (7.0L) Cadillac V8 Cyl, 4.082in./103.7mm (1977-1979) **123**

Part Year VIN Model/Application Part Number Qty.

ENGINE GASKETS

Head Set	1977-1979		(Valve Stem Seals Not Included, Intake Manifold Gasket Not Included)	HS3912	1
Full Set	1977-1979		(Valve Stem Seals Not Included, Intake Manifold Gasket Not Included)	FS3912	1
Engine Kit Gasket Set	1977-1979		(Valve Stem Seals Not Included, Intake Manifold Gasket Not Included), Use With Part Number MS15943X	95-3325VR	1
Cylinder Head Gasket	1977-1979			<i>VR2000</i> 3912	2
Valve Cover Set	1977-1979			<i>Cork Rubber</i> VS38321	1
Manifold Set, Exhaust	1977-1979			MS12271	1
Manifold Set, Intake	1977-1979			MS15943X	1
Oil Pan Set	1977-1979			OS20933	1

123 425 CID (7.0L) Cadillac V8 Cyl, 4.082in./103.7mm (1977-1979) **123**
(cont.) (cont.)

Part Year VIN Model/Application Part Number Qty.

ENGINE GASKETS (cont.)

Rear Main Seal Set	1977-1979			JV600	1
Timing Cover Set	1977-1979			JV884	1
Timing Cover Seal	1977-1979			47453	1

MISCELLANEOUS GASKETS

Air Cleaner Mount Gasket	1977-1979		4 Barrel Carburetor	G27098	1
Carb. Mount Gasket	1977-1979		4 Barrel Carburetor	G14746	1
E.G.R. Gasket	1977-1979		Fuel Injection	G17797	1
			Except Fuel Injection	G26315	1
Fuel Pump Gasket	1977-1979			D26606	1
				<i>Tuff-Cork</i> D26606TC	1
Injector Nozzle O-Ring	1977-1979			GS33280	1
Therm. Mount Gasket	1977-1979			C24109	1
Water Outlet Gasket	1977-1979			C24109	1
Water Pump Mount Gasket	1977-1979			K27144	1

124 425 CID (7.0L) Oldsmobile V8 Cyl, 4.125in./104.8mm (1965-1967) **124**

Part Year VIN Model/Application Part Number Qty.

ENGINE GASKETS

Head Set	1965-1967		(Exhaust Pipe Gasket Not Included, Intake Manifold Gasket Not Included)	HS3436VC	1
Full Set	1965-1967		(Exhaust Pipe Gasket Not Included, Intake Manifold Gasket Not Included)	FS3436VC	1
Engine Kit Gasket Set	1965-1967		(Intake Manifold Gasket Not Included), Use With Part Number MS15810	95-3015VR	1
Cylinder Head Gasket	1965-1967		<i>VR2000</i>	3436VC	2
Valve Cover Set	1965-1967		<i>Cork Rubber</i>	VS38305	1
			<i>High Temperature Cork Rubber</i>	VS38305H	1
			<i>Victo-Tech</i>	VS38305R	1
			<i>Tuff-Cork</i>	VS38305TC	1
Valve Stem Seal, Exh.	1965-1967			B45416	8
Valve Stem Seal, Int.	1965-1967			B45416	8
Manifold Set, Exhaust	1965-1967			MS15141	1
Manifold Set, Intake	1965-1967			MS15810	1
Oil Pan Set	1965-1967		<i>Cork Rubber</i>	OS30534	1
			<i>Tuff-Cork</i>	OS30534TC	1
Rear Main Seal Set	1965-1967		<i>Molded Rubber</i>	JV618	1
			<i>Rope Packing</i>	JV749	1
Timing Cover Set	1965-1967		(Repair Sleeve Not Included)	JV845	1
			(Contains Repair Sleeve)	JV927	1
Timing Cover Gasket	1965-1967			T27823	1
Timing Cover Seal	1965-1967			47398	1
Harmonic Balancer Repair Sleeve	1965-1967		<i>Ground Steel, .020" Thickness</i>	66590RS	1
			Use With Part Number A500 <i>Nickel Plated Formed Steel, .013" Oversize</i>	A222	1

MISCELLANEOUS GASKETS

Air Cleaner Mount Gasket	1966-1967		4 Barrel Carburetor	G27098	1
	1965-1967		2 Barrel Carburetor	G26617	1
	1965		4 Barrel Carburetor	G26410	1
Carb. Mount Gasket	1966-1967		4 Barrel Carburetor	G26658	1
	1965		4 Barrel Carburetor	G14574	2
Choke Tube Gasket	1965-1967			B45786	1
Dist. Mounting Gasket	1965-1967			72219	1
Exhaust Pipe Gasket	1965-1967		(Ring Type 'D'), Pipe To Manifold	F7187	1

General Motors Corp.

124 425 CID (7.0L) Oldsmobile V8 Cyl, 4.125in./104.8mm (1965-1967) **124**
 (cont.) (cont.)

Part	Year	VIN	Model/Application	Part Number	Qty.
MISCELLANEOUS GASKETS (cont.)					
Fuel Pump Gasket	1965-1967			D26606	1
				<i>Tuff-Cork</i> D26606TC	1
Water Outlet Gasket	1965-1967			C24111	1
Water Pump Mount Gasket	1965-1967		Air Conditioning, Heavy Duty Cooling	K27156	1
			Air Conditioning, Heavy Duty Cooling	<i>Tuff-Cork</i> K27156TC	1
			Except Air Conditioning, Except Heavy Duty Cooling	K27821A	1
			Except Air Conditioning, Except Heavy Duty Cooling	<i>Tuff-Cork</i> K27821ATC	1

125 427 CID (7.0L) Chevrolet V8 Cyl, 4.250in./108mm (1966-1969) **125**

Part	Year	VIN	Model/Application	Part Number	Qty.
ENGINE GASKETS					
Head Set	1966-1969		(Head Bolts Not Included, Contains High Temperature Shedder Type Valve Stem Seals, Special High Performance Intake Manifold Set Not Included)	HS3805VJ	1
Lower Set	1966-1969		(Requires Head Set To Make Full Set)	CS3805	1
Full Set	1966-1969		(Head Bolts Not Included, Contains High Temperature Shedder Type Valve Stem Seals, Special High Performance Intake Manifold Set Not Included)	FS3805VJ	1
Engine Kit Gasket Set	1966-1969		Except Special High Performance Engine	95-3026VR	1
			Special High Performance Engine, (Intake Manifold Gasket Not Included), Use With Part Number MS15168	95-3026VR	1
Cylinder Head Gasket	1966-1969		<i>VR2000</i>	3805VC	2
			<i>Nitroseal</i>	3884SG	2
Cyl. Head Bolt Set	1966-1969			GS33287	2
Valve Cover Set	1966-1969		<i>Cork Rubber</i>	VS38420	1
			<i>Victo-Tech</i>	VS38420R	1
			<i>Tuff-Cork</i>	VS38420TC	1
Valve Stem Seal, Exh.	1966-1969		<i>Fluoroelastomer</i>	B45296	8
Valve Stem Seal, Int.	1966-1969		<i>Fluoroelastomer</i>	B45296	8
Manifold Set, Exhaust	1966-1969			MS15164	1
Manifold Set, Intake	1966-1969		Special High Performance Engine	MS15168	1
			Except Special High Performance Engine	MS15188	1
Oil Pan Set	1966-1969		<i>Cork Rubber</i>	OS30931X	1
Rear Main Seal Set	1966-1969			JV705	1
Timing Cover Set	1966-1969		(Repair Sleeve Not Included)	JV866	1
			(Contains Repair Sleeve)	JV929	1
Timing Cover Gasket	1966-1969			T27119	1
Timing Cover Seal	1966-1969			46467	1
Harmonic Balancer Repair Sleeve	1966-1969		<i>Ground Steel, .020" Oversize</i>	66598RS	1
			Use With Part Number A503 <i>Nickel Plated Formed Steel, .013" Oversize</i>	A230	1

MISCELLANEOUS GASKETS

Air Cleaner Mount Gasket	1966-1969		4 Barrel Carburetor	G27098	1
Carb. Mount Gasket	1967-1969		Rochester, 4 Barrel Carburetor	G14579	1
			Holley Carburetor, 4 Barrel Carburetor	G14733	1
			3-2 Barrel Carburetors	G31366	3
	1966		Holley Carburetor, Special High Performance Engine, 4 Barrel Carburetor	G14733	1
			Except Special High Performance Engine, Holley Carburetor, 4 Barrel Carburetor	G14742	1
Dist. Mounting Gasket	1966-1969			B25934	1
Exhaust Pipe Gasket	1966-1969		2.5" Pipe, (Ring Type 'B'), Pipe To Manifold <i>Sintered Metal</i>	F7139S	1
Fuel Pump Gasket	1966-1969			D27094	1
				<i>Tuff-Cork</i> D27094TC	1

125 427 CID (7.0L) Chevrolet V8 Cyl, 4.250in./108mm (1966-1969) **125**
(cont.) (cont.)

Part	Year	VIN	Model/Application	Part Number	Qty.
MISCELLANEOUS GASKETS (cont.)					
Heat Riser Gasket	1966-1969			F7192	1
Oil Pan Drain Plug Gst.	1966-1969			2051	1
Oil Pump Shaft Retainer	1966-1969			H31354	1
Water Outlet Gasket	1966-1969		(Universal Type)	C24109	1
				C25930	1
Water Pump Backing Plate	1966-1969			K27078	1
Water Pump Mount Gasket	1966-1969			K26632	2

126 428 CID (7.0L) Pontiac V8 Cyl, 4.120in./104.6mm (1967-1969) **126**

Part	Year	VIN	Model/Application	Part Number	Qty.
ENGINE GASKETS					
Head Set	1967-1969			HS3494K	1
Full Set	1967-1969			FS3494J	1
Engine Kit Gasket Set	1967-1969		(High Temperature Valve Cover Set Not Included), Use With Part Number VS38291XH	95-3397VR	1
Cylinder Head Gasket	1967-1969		VR2000	3494VC	2
Valve Cover Set	1967-1969		Cork Rubber	VS38291X	1
			High Temperature Cork Rubber	VS38291XH	1
Valve Stem Seal, Exh.	1967-1969		(O-Ring Type)	B45229	8
Valve Stem Seal, Int.	1967-1969		(O-Ring Type)	B45229	8
			(Positive Type)	B45299	8
Manifold Set, Exhaust	1967-1969			MS15085W	1
Manifold Set, Intake	1967-1969			MS15135	1
Oil Pan Set	1967-1969		Cork Rubber	OS20526A	1
Rear Main Seal Set	1967-1969			JV742	1
Timing Cover Set	1967-1969		(Repair Sleeve Not Included, Water Pump Tube Seals Not Included)	JV877	1
			(Contains Repair Sleeve, Water Pump Tube Seals Not Included)	JV920	1
Timing Cover Gasket	1967-1969			T27806	1
Harmonic Balancer Repair Sleeve	1967-1969		Ground Steel, .020" Oversize	66601RS	1
			Use With Part Number A502 Nickel Plated Formed Steel, .013" Oversize	A229-1	1

MISCELLANEOUS GASKETS

Air Cleaner Mount Gasket	1967-1969		4 Barrel Carburetor	G27098	1
Carb. Mount Gasket	1968-1969		4 Barrel Carburetor	G26656	1
	1967		Except Rochester, 4 Barrel Carburetor	G14554	1
Dist. Mounting Gasket	1967-1969		Rochester, 4 Barrel Carburetor	G14579	1
				B25941	1
Fuel Pump Gasket	1967-1969		Plate To Block	D25932	1
			Plate To Block	Tuff-Cork D25932TC	1
			Pump To Plate	D27094	1
			Pump To Plate	Tuff-Cork D27094TC	1
Oil Filter Mount Gasket	1967-1969			B7147	1
Oil Pan Drain Plug Gst.	1967-1969			2051	1
Oil Pump Mounting Gasket	1967-1969			B26457	1
Push Rod Cover Set	1968-1969		Cork Rubber	PS38781	1
	1967		Cork Rubber	PS38776	1
Water Outlet Gasket	1967-1969			C24109	1

General Motors Corp.

126 428 CID (7.0L) Pontiac V8 Cyl, 4.120in./104.6mm (1967-1969) **126**
 (cont.) (cont.)

Part	Year	VIN	Model/Application	Part Number	Qty.
MISCELLANEOUS GASKETS (cont.)					
Water Pump Mount Gasket	1969			K27149	2
	1967-1968			K27818	1
Water Pump Tube Seal	1967-1968			B45687	2

127 429 CID (7.0L) Cadillac V8 Cyl, 4.129in./104.9mm (1964-1967) **127**

Part	Year	VIN	Model/Application	Part Number	Qty.
ENGINE GASKETS					
Head Set	1964-1967			HS3361BS	1
Full Set	1964-1967			FS3361BX	1
Cylinder Head Gasket	1964-1967			3361BS	2
Valve Cover Set	1964-1967		Cork Rubber	VS38302	1
Valve Stem Seal, Exh.	1967			B45264	8
		(High Temperature)		B45779	8
	1965-1967		After VIN 13899	B45264	8
			After VIN 13899, (High Temperature)	B45779	8
	1965		Before VIN 13900	B45233	8
1964			B45233	8	
Valve Stem Seal, Int.	1967			B45264	8
		(High Temperature)		B45779	8
	1965-1967		After VIN 13899	B45264	8
			After VIN 13899, (High Temperature)	B45779	8
	1965		Before VIN 13900	B45233	8
1964			B45233	8	
Manifold Set, Exhaust	1964-1967			MS7115	1
Manifold Set, Intake	1964-1967			MS15038X	1
Oil Pan Set	1964-1967			OS20533X	1
Rear Main Seal Set	1964-1967			JV735	1
Timing Cover Set	1964-1967			JV841	1
Timing Cover Seal	1964-1967			47387	1

MISCELLANEOUS GASKETS					
Air Cleaner Mount Gasket	1964-1967		4 Barrel Carburetor	G26410	1
Carb. Mount Gasket	1967		4 Barrel Carburetor	G14130	1
	1964-1966		4 Barrel Carburetor	G14565	2
Exhaust Pipe Gasket	1964-1967		(Flange Type), Pipe To Manifold	F5436AK	3
Fuel Pump Gasket	1964-1967		Plate To Block	D25932	1
			Plate To Block	Tuff-Cork D25932TC	1
			Pump To Plate	D27094	1
			Pump To Plate	Tuff-Cork D27094TC	1
Heat Riser Gasket	1967		Calais, Fleetwood 75, Fleetwood Special, Series 6200, (Flange Type)	F5436AK	3
	1965-1966		Fleetwood, (Flange Type)	F5436AK	3
	1964		Eldorado Special, Series 6200, (Flange Type)	F5436AK	3
Oil Pan Drain Plug Gst.	1964-1967			2051	1
Push Rod Cover Set	1964-1967		Cork Rubber	PS38398	1
Water Man. O-Ring	1964-1967			C45380	1
Water Outlet Gasket	1964-1967			C24109	1
Water Pump Mount Gasket	1964-1967		Body To Cylinder Head	K25916	1
				K27814	1

128 430 CID (7.0L) Buick V8 Cyl, 4.188in./106.4mm (1967-1969) 128

Part	Year	VIN	Model/Application	Part Number	Qty.
ENGINE GASKETS					
Head Set	1967-1969		(Intake Manifold Gasket Not Included)	HS3492VE	1
Full Set	1967-1969		(Intake Manifold Gasket Not Included)	FS3492VE	1
Engine Kit Gasket Set	1967-1969		(Intake Manifold Gasket Not Included), Use With Part Number MS15921X	95-3009VR	1
Cylinder Head Gasket	1967-1969		VR2000	3492	2
Valve Cover Set	1967-1969		Cork Rubber	VS38319	1
Valve Stem Seal, Exh.	1967-1969		Nitrile	B45403	8
Valve Stem Seal, Int.	1967-1969		Nitrile	B45403	8
Manifold Set, Exhaust	1967-1969			MS15200	1
Manifold Set, Intake	1967-1969			MS15921X	1
Oil Pan Set	1967-1969		Cork Rubber	OS31582	1
Rear Main Seal Set	1967-1969			JV742	1
Timing Cover Set	1967-1969			JV860	1

MISCELLANEOUS GASKETS

Air Cleaner Mount Gasket	1967-1969		4 Barrel Carburetor	G27098	1
Carb. Mount Gasket	1969		4 Barrel Carburetor	G26652	1
Dist. Mounting Gasket	1967-1969			72215	1
Fuel Pump Gasket	1967-1969		Plate To Block	D25932	1
			Plate To Block	Tuff-Cork D25932TC	1
			Pump To Plate	D27094	1
			Pump To Plate	Tuff-Cork D27094TC	1
Oil Pan Drain Plug Gst.	1967-1969			2051	1
Oil Pump Cover Gasket	1967-1969			B45579	1
Water Outlet Gasket	1967-1969			C26515	1
Water Pump Mount Gasket	1967-1969			K27132	1

129 454 CID (7.4L) Chevrolet V8 Cyl, 4.250in./108mm (1970-1976) 129

Part	Year	VIN	Model/Application	Part Number	Qty.
ENGINE GASKETS					
Head Set	1970-1976		(Head Bolts Not Included, Special High Performance Intake Manifold Set Not Included)	HS3805VJ	1
Lower Set	1970-1976		(Requires Head Set To Make Full Set)	CS3805	1
Full Set	1970-1976		(Head Bolts Not Included, Special High Performance Intake Manifold Set Not Included)	FS3805VJ	1
Engine Kit Gasket Set	1970-1976		Except Special High Performance Engine	95-3026VR	1
	1970-1972		Special High Performance Engine, (Intake Manifold Gasket Not Included), Use With Part Number MS15168	95-3026VR	1
Cylinder Head Gasket	1970-1976		VR2000	3805VC	2
			Nitroseal	3884SG	2
Cyl. Head Bolt Set	1970-1976			GS33287	2
Valve Cover Set	1970-1976		Cork Rubber	VS38420	1
			Victo-Tech	VS38420R	1
			Tuff-Cork	VS38420TC	1
Valve Stem Seal, Exh.	1970-1976		Except High Performance, Except Police Car Fluoroelastomer	B45296	8
Valve Stem Seal, Int.	1970-1976		Except High Performance, Except Police Car Fluoroelastomer	B45296	8
Manifold Set, Exhaust	1970-1976			MS15164	1
Manifold Set, Intake	1970-1976		Special High Performance Engine	MS15168	1
			Except Special High Performance Engine	MS15188	1
Oil Pan Set	1970-1976		Cork Rubber	OS30931X	1
			Tuff-Cork	OS30931XTC	1
Rear Main Seal Set	1970-1976			JV705	1
Timing Cover Set	1970-1976		(Repair Sleeve Not Included)	JV866	1

PASSENGER CAR

General Motors Corp.

129 454 CID (7.4L) Chevrolet V8 Cyl, 4.250in./108mm (1970-1976) **129**
 (cont.) (cont.)

Part Year VIN Model/Application Part Number Qty.

ENGINE GASKETS (cont.)

Timing Cover Set (cont.)	1970-1976		(Repair Sleeve Not Included)	<i>Tuff-Cork</i>	JV866TC	1
			(Contains Repair Sleeve)		JV929	1
Timing Cover Gasket	1970-1976				T27119	1
Timing Cover Seal	1970-1976				46467	1
Harmonic Balancer Repair Sleeve	1970-1976			<i>Ground Steel, .020" Oversize</i>	66598RS	1
			Use With Part Number A503	<i>Nickel Plated Formed Steel, .013" Oversize</i>	A230	1

MISCELLANEOUS GASKETS

Air Cleaner Mount Gasket	1970-1976		4 Barrel Carburetor		G27098	1
Carb. Mount Gasket	1974-1976		4 Barrel Carburetor		G26719	1
	1972-1973		4 Barrel Carburetor		G26666	1
	1971		Except Special High Performance Engine, 4 Barrel Carburetor		G26666	1
	1970		4 Barrel Carburetor, Shield To Manifold		G14733	1
Choke Tube Gasket	1976				B45785	1
Dist. Mounting Gasket	1970-1976				B25934	1
E.G.R. Gasket	1975-1976				G17797	1
	1973-1974				G26338	1
Exhaust Pipe Gasket	1970-1976		2.5" Pipe, (Ring Type 'C'), Pipe To Manifold		F7139	2
			2.5" Pipe, (Ring Type 'B'), Pipe To Manifold	<i>Sintered Metal</i>	F7139S	1
Fuel Pump Gasket	1970-1976		Plate To Block		D25932	1
			Plate To Block	<i>Tuff-Cork</i>	D25932TC	1
			Pump To Plate		D27094	1
			Pump To Plate	<i>Tuff-Cork</i>	D27094TC	1
Heat Riser Gasket	1970-1976		Caprice, Impala	<i>2.437" Inside Diameter</i>	F7192	1
	1971-1975		Chevelle	<i>2.125" Inside Diameter</i>	F7135	1
			Bel Air	<i>2.437" Inside Diameter</i>	F7192	1
	1970-1975		Corvette, Monte Carlo	<i>2.437" Inside Diameter</i>	F7192	1
	1970-1972		Biscayne	<i>2.437" Inside Diameter</i>	F7192	1
Oil Pan Drain Plug Gst.	1970-1976				2051	1
Oil Pump Shaft Retainer	1970-1976				H31354	1
Water Outlet Gasket	1970-1976		(Universal Type)		C24109	1
					C25930	1
Water Pump Backing Plate	1970-1976				K27078	1
Water Pump Mount Gasket	1970-1976				K26632	2

130 455 CID (7.5L) Buick V8 Cyl, 4.313in./109.6mm (1970-1976) **130**

Part Year VIN Model/Application Part Number Qty.

ENGINE GASKETS

Head Set	1970-1976		(Intake Manifold Gasket Not Included)		HS3492VE	1
Full Set	1970-1976		(Intake Manifold Gasket Not Included)		FS3492VE	1
Engine Kit Gasket Set	1972-1976		(Intake Manifold Gasket Not Included), Use With Part Number MS15930		95-3009VR	1
	1970-1971		(Intake Manifold Gasket Not Included), Use With Part Number MS15921X		95-3009VR	1
Cylinder Head Gasket	1970-1976			<i>VR2000</i>	3492	2
Valve Cover Set	1970-1976			<i>Cork Rubber</i>	VS38319	1
Valve Stem Seal, Int.	1970-1976		(Positive Type)	<i>Nitrile</i>	B45403	8
Manifold Set, Exhaust	1970-1976				MS15200	1
Manifold Set, Intake	1972-1976				MS15930	1
	1970-1971				MS15921X	1

PASSENGER CAR

130 455 CID (7.5L) Buick V8 Cyl, 4.313in./109.6mm (1970-1976) **130**
(cont.) (cont.)

Part	Year	VIN	Model/Application	Part Number	Qty.
ENGINE GASKETS (cont.)					
Oil Pan Set	1970-1976		Cork Rubber	OS31582	1
Rear Main Seal Set	1970-1976			JV742	1
Timing Cover Set	1970-1976			JV860	1
MISCELLANEOUS GASKETS					
Air Cleaner Mount Gasket	1970-1976		4 Barrel Carburetor	G27098	1
	1974		2 Barrel Carburetor	G26617	1
Carb. Mount Gasket	1975-1976		4 Barrel Carburetor	G26717	1
	1974		2 Barrel Carburetor	G25452	1
	1970-1974		4 Barrel Carburetor	G26652	1
Dist. Mounting Gasket	1970-1976			72215	1
E.G.R. Gasket	1972-1976			G26315	1
Fuel Pump Gasket	1970-1976		Plate To Block	D25932	1
			Plate To Block Tuff-Cork	D25932TC	1
			Pump To Plate	D27094	1
			Pump To Plate Tuff-Cork	D27094TC	1
Oil Pan Drain Plug Gst.	1970-1976			2051	1
Oil Pump Cover Gasket	1970-1976			B45579	1
Water Outlet Gasket	1970-1976			C26515	1
Water Pump Mount Gasket	1970-1976			K27132	1

131 455 CID (7.5L) Oldsmobile V8 Cyl, 4.125in./104.8mm (1968-1976) **131**

Part	Year	VIN	Model/Application	Part Number	Qty.
ENGINE GASKETS					
Head Set	1968-1976		(Exhaust Pipe Gasket Not Included, Intake Manifold Gasket Not Included)	HS3436VC	1
Full Set	1968-1976		(Exhaust Pipe Gasket Not Included, Intake Manifold Gasket Not Included)	FS3436VC	1
Engine Kit Gasket Set	1973-1976		(Intake Manifold Gasket Not Included), Use With Part Number MS15933	95-3015VR	1
	1968-1972		(Intake Manifold Gasket Not Included), Use With Part Number MS15810	95-3015VR	1
Cylinder Head Gasket	1968-1976		VR2000	3436VC	2
Valve Cover Set	1968-1976		Cork Rubber	VS38305	1
			High Temperature Cork Rubber	VS38305H	1
			Victo-Tech	VS38305R	1
			Tuff-Cork	VS38305TC	1
Valve Stem Seal, Exh.	1968-1976			B45416	8
Valve Stem Seal, Int.	1968-1976			B45416	8
Manifold Set, Exhaust	1968-1976			MS15141	1
Manifold Set, Intake	1973-1976			MS15933	1
	1968-1972			MS15810	1
Oil Pan Set	1968-1976		Cork Rubber	OS30534	1
			Tuff-Cork	OS30534TC	1
Rear Main Seal Set	1968-1976		Molded Rubber	JV618	1
			Rope Packing	JV749	1
Timing Cover Set	1968-1976		(Repair Sleeve Not Included)	JV845	1
			(Contains Repair Sleeve)	JV927	1
Timing Cover Gasket	1968-1976			T27823	1
Timing Cover Seal	1968-1976			47398	1
Harmonic Balancer Repair Sleeve	1968-1976		Ground Steel, .020" Thickness	66590RS	1
			Use With Part Number A500 Nickel Plated Formed Steel, .020" Oversize	A222	1

General Motors Corp.

131 455 CID (7.5L) Oldsmobile V8 Cyl, 4.125in./104.8mm (1968-1976) **131**
 (cont.) (cont.)

Part	Year	VIN	Model/Application	Part Number	Qty.
MISCELLANEOUS GASKETS					
Air Cleaner Mount Gasket	1968-1976		4 Barrel Carburetor	G27098	1
	1968-1971		2 Barrel Carburetor	G26617	1
Carb. Mount Gasket	1975-1976		4 Barrel Carburetor	G26723	1
	1968-1974		4 Barrel Carburetor	G26658	1
	1968-1971		2 Barrel Carburetor	G25452	1
Choke Tube Gasket	1968-1976			B45786	1
Dist. Mounting Gasket	1968-1976			72219	1
E.G.R. Gasket	1973-1976			G17797	1
Exhaust Pipe Gasket	1976		Cutlass, Delta 88 Royale, Ninety Eight, (Ring Type 'D'), Pipe To Manifold	F7187	1
	1975-1976		Cutlass Salon, (Ring Type 'D'), Pipe To Manifold	F7187	1
			Toronado, (Ring Type 'E'), Pipe To Manifold	F7207	1
	1970-1976		Cutlass Supreme, (Ring Type 'D'), Pipe To Manifold	F7187	1
	1972-1974		Cutlass, Cutlass 'S', (Ring Type 'D'), Pipe To Manifold	F7187	1
	1971-1974		Custom Cruiser, Vista Cruiser, (Ring Type 'D'), Pipe To Manifold	F7187	1
	1969-1974		Delta 88 Royale, (Ring Type 'D'), Pipe To Manifold	F7187	1
	1968-1974		Delta 88, Ninety Eight, Toronado, (Ring Type 'D'), Pipe To Manifold	F7187	1
	1968-1971		442, (Ring Type 'D'), Pipe To Manifold	F7187	1
	1970		Cutlass, (Ring Type 'D'), Pipe To Manifold	F7187	1
Fuel Pump Gasket	1968-1976			D26606	1
				Tuff-Cork D26606TC	1
				GS33280	1
Injector Nozzle O-Ring	1976				1
Oil Filter Mount Gasket	1968-1976			B26607	1
Oil Pan Drain Plug Gst.	1968-1976			2051	1
Water Outlet Gasket	1968-1976			C24111	1
Water Pump Mount Gasket	1968-1976		Air Conditioning, Heavy Duty Cooling	K27156	1
			Air Conditioning, Heavy Duty Cooling Tuff-Cork	K27156TC	1
			Except Air Conditioning, Except Heavy Duty Cooling	K27821A	1
			Except Air Conditioning, Except Heavy Duty Cooling Tuff-Cork	K27821ATC	1

132 455 CID (7.5L) Pontiac V8 Cyl, 4.151in./105.4mm (1970-1976) **132**

Part	Year	VIN	Model/Application	Part Number	Qty.
ENGINE GASKETS					
Head Set	1970-1976			HS3494K	1
Full Set	1972-1976			FS3494E	1
	1970-1971			FS3494J	1
Engine Kit Gasket Set	1972-1976		Except High Output Engine, Except Super Duty Engine	95-3398VR	1
	1970-1971		Except High Output Engine	95-3397VR	1
Cylinder Head Gasket	1970-1976		VR2000	3494VC	2
Valve Cover Set	1970-1976		Cork Rubber	VS38291X	1
			High Temperature Cork Rubber	VS38291XH	1
Valve Stem Seal, Exh.	1970-1976		(O-Ring Type)	B45229	8
Valve Stem Seal, Int.	1970-1976		(O-Ring Type)	B45229	8
			(Positive Type)	B45299	8
Manifold Set, Exhaust	1970-1976			MS15085W	1
			(High Performance)	MS15177	1
Manifold Set, Intake	1972-1976			MS15186	1
	1970-1971			MS15135	1
			(High Performance)	MS15174	1
Oil Pan Set	1972-1976		Cork Rubber	OS20491	1

PASSENGER CAR

132 455 CID (7.5L) Pontiac V8 Cyl, 4.151in./105.4mm (1970-1976) **132**
(cont.) (cont.)

Part	Year	VIN	Model/Application	Part Number	Qty.
ENGINE GASKETS (cont.)					
Oil Pan Set (cont.)	1972-1976			<i>Tuff-Cork</i> OS20491TC	1
	1970-1971			<i>Cork Rubber</i> OS20526A	1
Rear Main Seal Set	1970-1976			JV742	1
Timing Cover Set	1970-1976		(Repair Sleeve Not Included, Water Pump Tube Seals Not Included)	JV877	1
			(Contains Repair Sleeve, Water Pump Tube Seals Not Included)	JV920	1
Timing Cover Gasket	1975-1976			T27812	1
	1970-1974			T27806	1
Harmonic Balancer Repair Sleeve	1970-1976		<i>Ground Steel, .020" Oversize</i>	66601RS	1
			Use With Part Number A502 <i>Nickel Plated Formed Steel, .013" Oversize</i>	A229-1	1

MISCELLANEOUS GASKETS

Air Cleaner Mount Gasket	1970-1976		4 Barrel Carburetor	G27098	1
	1971-1972		2 Barrel Carburetor	G26617	1
Carb. Mount Gasket	1975-1976		4 Barrel Carburetor	G26720	1
	1970-1974		4 Barrel Carburetor	G26658	1
	1971-1972		2 Barrel Carburetor	G25452	1
Dist. Mounting Gasket	1970-1976			B25941	1
E.G.R. Gasket	1975-1976			G26747	1
	1973-1974			G17797	1
Fuel Pump Gasket	1970-1976		Plate To Block	D25932	1
			Plate To Block	<i>Tuff-Cork</i> D25932TC	1
			Pump To Plate	D27094	1
			Pump To Plate	<i>Tuff-Cork</i> D27094TC	1
Oil Filter Mount Gasket	1970-1976			B7147	1
Oil Pan Drain Plug Gst.	1970-1976			2051	1
Oil Pump Mounting Gasket	1970-1976			B26457	1
Push Rod Cover Set	1970-1976			<i>Cork Rubber</i> PS38781	1
Water Outlet Gasket	1970-1976			C24109	1
Water Pump Mount Gasket	1970-1976			K27149	2
Water Pump Tube Seal	1970-1976			B45687	2

133 472 CID (7.7L) Cadillac V8 Cyl, 4.300in./109.2mm (1968-1974) **133**

Part	Year	VIN	Model/Application	Part Number	Qty.
ENGINE GASKETS					
Head Set	1968-1974		(Valve Stem Seals Not Included, Exhaust Pipe Gasket Not Included, Intake Manifold Gasket Not Included)	HS3852	1
Full Set	1968-1974		(Valve Stem Seals Not Included, Exhaust Pipe Gasket Not Included, Intake Manifold Gasket Not Included)	FS3852	1
Engine Kit Gasket Set	1968-1974		(Valve Stem Seals Not Included, Intake Manifold Gasket Not Included), Use With Part Number MS15943	95-3087VR	1
Cylinder Head Gasket	1968-1974			<i>VR2000</i> 3852	2
Valve Cover Set	1968-1974			<i>Cork Rubber</i> VS38321	1
Manifold Set, Exhaust	1968-1974			MS12271	1
Manifold Set, Intake	1968-1974			MS15943	1
Oil Pan Set	1968-1974			OS20933	1
Rear Main Seal Set	1968-1974			JV600	1
Timing Cover Set	1968-1974			JV863	1
Timing Cover Gasket	1968-1974			T27145	1
Timing Cover Seal	1968-1974			47453	1

General Motors Corp.

133 472 CID (7.7L) Cadillac V8 Cyl, 4.300in./109.2mm (1968-1974) **133**
(cont.) (cont.)

Part	Year	VIN	Model/Application	Part Number	Qty.
MISCELLANEOUS GASKETS					
Air Cleaner Mount Gasket	1968-1974		4 Barrel Carburetor	G27098	1
Carb. Mount Gasket	1970-1974		4 Barrel Carburetor	G14746	1
	1968-1969		4 Barrel Carburetor	G14130	1
E.G.R. Gasket	1973-1974			G26315	1
Fuel Pump Gasket	1968-1974			D26606	1
			Tuff-Cork	D26606TC	1
Injector Nozzle O-Ring	1970-1974			GS33280	1
Oil Pan Drain Plug Gst.	1970-1974			2051	1
Water Outlet Gasket	1968-1974			C24109	1
Water Pump Mount Gasket	1968-1974			K27144	1

134 500 CID (8.2L) Cadillac V8 Cyl, 4.300in./109.2mm (1970-1976) **134**

Part	Year	VIN	Model/Application	Part Number	Qty.
ENGINE GASKETS					
Head Set	1970-1976		(Valve Stem Seals Not Included, Exhaust Pipe Gasket Not Included, Intake Manifold Gasket Not Included)	HS3852	1
Full Set	1970-1976		(Valve Stem Seals Not Included, Exhaust Pipe Gasket Not Included, Intake Manifold Gasket Not Included)	FS3852	1
Engine Kit Gasket Set	1970-1976		(Valve Stem Seals Not Included, Intake Manifold Gasket Not Included), Use With Part Number MS15943	95-3087VR	1
Cylinder Head Gasket	1970-1976		VR2000	3852	2
Valve Cover Set	1970-1976		Cork Rubber	VS38321	1
Manifold Set, Exhaust	1970-1976			MS12271	1
Manifold Set, Intake	1970-1976			MS15943	1
Oil Pan Set	1970-1976			OS20933	1
Rear Main Seal Set	1970-1976			JV600	1
Timing Cover Set	1970-1976			JV863	1
Timing Cover Gasket	1970-1976			T27145	1
Timing Cover Seal	1970-1976			47453	1

MISCELLANEOUS GASKETS					
Air Cleaner Mount Gasket	1970-1976		4 Barrel Carburetor	G27098	1
Carb. Mount Gasket	1970-1976		4 Barrel Carburetor	G14746	1
E.G.R. Gasket	1975-1976		Electronic Fuel Injection	G17797	1
	1973-1976		4 Barrel Carburetor	G26315	1
Fuel Pump Gasket	1970-1976			D26606	1
			Tuff-Cork	D26606TC	1
Injector Nozzle O-Ring	1975-1976			GS33280	1
Oil Pan Drain Plug Gst.	1970-1976			2051	1
Water Outlet Gasket	1970-1976			C24109	1
Water Pump Mount Gasket	1970-1976			K27144	1

Honda

Engine Index

Engine	Year	Block	Engine	Year	Block
1169CC (1.2L) EB1 SOHC	1973	1	1488CC (1.5L) D15A1	1987	9
1237CC (1.2L) EB2 SOHC	1974-1977	2	1488CC (1.5L) D15A2 SOHC	1987	10
1237CC (1.2L) EB3 SOHC	1978-1979	3	1488CC (1.5L) D15A3	1987	11
1335CC (1.3L) EJ1 SOHC	1980-1983	4	1488CC (1.5L) ED1/ED2	1975-1976	12
1335CC (1.3L) EN1	1979-1983	5	1488CC (1.5L) ED3/ED4	1976-1979	13
1342CC (1.3L) D13A2 SOHC	1987	6	1488CC (1.5L) EM1 SOHC	1980-1983	14
1342CC (1.3L) EV1 SOHC	1984-1986	7	1488CC (1.5L) EW1 SOHC	1984-1986	15
1342CC (1.3L) EV2	1984-1986	8	1488CC (1.5L) EW2	1984-1986	16

Engine Index (cont.)

Engine	Year	Block
1488CC (1.5L) EW3 SOHC	1985	17
1488CC (1.5L) EW4	1986	18
1493CC (1.5L) D15B1/D15B2	1988-1991	19
1493CC (1.5L) D15B6 SOHC	1988-1991	20
1493CC (1.5L) D15B7 SOHC	1992-1995	21
1493CC (1.5L) D15B8 SOHC	1992-1995	22
1493CC (1.5L) D15Z1 V-TEC SOHC	1992-1995	23
1590CC (1.6L) D16A6 SOHC	1988-1991	24
1590CC (1.6L) D16B5 V-TEC SOHC	1998-2000	25
1590CC (1.6L) D16Y5 V-TEC-2 SOHC	1996-2000	26
1590CC (1.6L) D16Y7 SOHC	1996-2000	27
1590CC (1.6L) D16Y8 V-TEC SOHC	1996-2000	28
1590CC (1.6L) D16Z6 V-TEC SOHC	1992-1995	29
1595CC (1.6L) B16A2 V-TEC DOHC	1996-2000	30
1595CC (1.6L) B16A3 V-TEC DOHC	1994-1995	31
1599CC (1.6L) EF1 SOHC	1976-1978	32
1599CC (1.6L) EZ1	1984-1985	33
1602CC (1.6L) EL	1979-1985	34
1602CC (1.6L) EL1 (Canadien)	1982-1983	35
1751CC (1.8L) EK1 SOHC	1979-1983	36
1829CC (1.8L) A18A1/A18A2	1987	37
1829CC (1.8L) ES1 SOHC	1983	38
1829CC (1.8L) ES2 Carbureted SOHC	1984-1985	39
1829CC (1.8L) ES3 Fuel Inj. SOHC	1985	40

Engine	Year	Block
1829CC (1.8L) ET	1983-1984	41
1829CC (1.8L) ET1	1984-1985	42
1829CC (1.8L) ET2 SOHC	1984-1986	43
1955CC (2.0L) BS1	1986	44
1955CC (2.0L) A20A1/A20A3/BS/BT1	1985-1989	45
1955CC (2.0L) BT2 SOHC	1986	46
1958CC (2.0L) B20A3 SOHC Carbureted	1988-1990	47
1958CC (2.0L) B20A5 DOHC	1988-1989	48
2056CC (2.1L) B21A1 DOHC	1990-1991	49
2156CC (2.2L) F22A1 SOHC	1990-1996	50
2156CC (2.2L) F22A4 SOHC	1990-1991	51
2156CC (2.2L) F22A6 SOHC	1991-1993	52
2156CC (2.2L) F22B1 V-TEC SOHC	1994-1997	53
2156CC (2.2L) F22B2 SOHC	1994-1997	54
2157CC (2.2L) H22A1 V-TEC DOHC	1993-1996	55
2157CC (2.2L) H22A4 V-TEC DOHC	1997-2001	56
2254CC (2.3L) F23A1 V-TEC SOHC	1998-2001	57
2254CC (2.3L) F23A4 V-TEC SOHC	1998-2002	58
2254CC (2.3L) F23A5 SOHC	1998-2002	59
2259CC (2.3L) H23A1 DOHC	1992-1996	60
2675CC (2.7L) C27A4 SOHC	1995-1997	61
2997CC (3.0L) J30A1 V-TEC SOHC	1998-2002	62
2997CC (3.0L) J30A4 V-TEC SOHC	2003	63

Model Index

Model	Engine	Year	Block
Accord	1599CC (1.6L) EZ1	1984-1985	33
Accord	1599CC (1.6L) EF1 SOHC	1976-1978	32
Accord	1602CC (1.6L) EL	1979-1985	34
Accord	1602CC (1.6L) EL1 (Canadien)	1982-1983	35
Accord	1751CC (1.8L) EK1 SOHC	1979-1983	36
Accord	1829CC (1.8L) ES3 Fuel Inj. SOHC	1985	40
Accord	1829CC (1.8L) ES2 Carbureted SOHC	1984-1985	39
Accord	1829CC (1.8L) ET	1983-1984	41
Accord	1955CC (2.0L) BS1	1986	44
Accord	1955CC (2.0L) BT2 SOHC	1986	46
Accord	1955CC (2.0L) A20A1/A20A3/BS/BT1	1986-1989	45
Accord	2156CC (2.2L) F22B1 V-TEC SOHC	1994-1997	53
Accord	2156CC (2.2L) F22B2 SOHC	1994-1997	54
Accord	2156CC (2.2L) F22A6 SOHC	1991-1993	52
Accord	2156CC (2.2L) F22A1 SOHC	1990-1993	50
Accord	2156CC (2.2L) F22A4 SOHC	1990-1991	51
Accord	2254CC (2.3L) F23A4 V-TEC SOHC	1998-2002	58
Accord	2254CC (2.3L) F23A5 SOHC	1998-2002	59
Accord	2254CC (2.3L) F23A1 V-TEC SOHC	1998-2002	57
Accord	2675CC (2.7L) C27A4 SOHC	1995-1997	61
Accord	2997CC (3.0L) J30A4 V-TEC SOHC	2003-2004	63
Accord	2997CC (3.0L) J30A1 V-TEC SOHC	1998-2002	62
CRX	1342CC (1.3L) EV1 SOHC	1984	7
CRX	1488CC (1.5L) D15A2 SOHC	1987	10
CRX	1488CC (1.5L) D15A3	1987	11
CRX	1488CC (1.5L) EW4	1986	18
CRX	1488CC (1.5L) EW3 SOHC	1985	17
CRX	1488CC (1.5L) EW1 SOHC	1984-1986	15
CRX	1493CC (1.5L) D15B1/D15B2	1988-1991	19
CRX	1493CC (1.5L) D15B6 SOHC	1988-1991	20
CRX	1590CC (1.6L) D16A6 SOHC	1988-1991	24
Civic	1169CC (1.2L) EB1 SOHC	1973	1
Civic	1237CC (1.2L) EB3 SOHC	1977-1979	3
Civic	1237CC (1.2L) EB2 SOHC	1974-1979	2
Civic	1335CC (1.3L) EN1	1979-1984	5
Civic	1335CC (1.3L) EJ1 SOHC	1980-1983	4

Model	Engine	Year	Block
Civic	1342CC (1.3L) D13A2 SOHC	1987	6
Civic	1342CC (1.3L) EV2	1984-1986	8
Civic	1342CC (1.3L) EV1 SOHC	1984-1986	7
Civic	1488CC (1.5L) D15A2 SOHC	1987	10
Civic	1488CC (1.5L) D15A3	1987	11
Civic	1488CC (1.5L) D15A1	1987	9
Civic	1488CC (1.5L) EW4	1986	18
Civic	1488CC (1.5L) EW2	1984-1987	16
Civic	1488CC (1.5L) EW1 SOHC	1984-1986	15
Civic	1488CC (1.5L) EM1 SOHC	1980-1983	14
Civic	1488CC (1.5L) ED3/ED4	1975-1979	13
Civic	1488CC (1.5L) ED1/ED2	1975-1976	12
Civic	1493CC (1.5L) D15B7 SOHC	1992-1995	21
Civic	1493CC (1.5L) D15B8 SOHC	1992-1995	22
Civic	1493CC (1.5L) D15Z1 V-TEC SOHC	1992-1995	23
Civic	1493CC (1.5L) D15B1/D15B2	1988-1991	19
Civic	1590CC (1.6L) D16B5 V-TEC SOHC	1998-2000	25
Civic	1590CC (1.6L) D16Y5 V-TEC-2 SOHC	1996-2000	26
Civic	1590CC (1.6L) D16Y7 SOHC	1996-2000	27
Civic	1590CC (1.6L) D16Y8 V-TEC SOHC	1996-2000	28
Civic	1590CC (1.6L) D16Z6 V-TEC SOHC	1992-1995	29
Civic	1590CC (1.6L) D16A6 SOHC	1988-1991	24
Civic	1595CC (1.6L) B16A2 V-TEC DOHC	1999-2000	30
Del-Sol	1493CC (1.5L) D15B7 SOHC	1993-1995	21
Del-Sol	1590CC (1.6L) D16Y7 SOHC	1996-1997	27
Del-Sol	1590CC (1.6L) D16Y8 V-TEC SOHC	1996-1997	28
Del-Sol	1590CC (1.6L) D16Z6 V-TEC SOHC	1993-1995	29
Del-Sol	1595CC (1.6L) B16A2 V-TEC DOHC	1996-1997	30
Del-Sol	1595CC (1.6L) B16A3 V-TEC DOHC	1994-1995	31
Prelude	1602CC (1.6L) EL	1979-1985	34
Prelude	1751CC (1.8L) EK1 SOHC	1979-1982	36
Prelude	1829CC (1.8L) A18A1/A18A2	1986-1987	37
Prelude	1829CC (1.8L) ET2 SOHC	1984-1986	43
Prelude	1829CC (1.8L) ET1	1983-1985	42

Honda

Model Index (cont.)

Model	Engine	Year	Block	Model	Engine	Year	Block
Prelude	1829CC (1.8L) ET	1983-1984	41	Prelude	2056CC (2.1L) B21A1 DOHC	1990-1991	49
Prelude	1829CC (1.8L) ES1 SOHC	1983	38	Prelude	2156CC (2.2L) F22A1 SOHC	1992-1996	50
Prelude	1955CC (2.0L) BT2 SOHC	1986	46	Prelude	2157CC (2.2L) H22A4 V-TEC DOHC	1997-2001	56
Prelude	1955CC (2.0L) A20A1/A20A3/BS/BT1	1985	45	Prelude	2157CC (2.2L) H22A1 V-TEC DOHC	1993-1996	55
Prelude	1958CC (2.0L) B20A3 SOHC Carbureted	1988-1990	47	Prelude	2259CC (2.3L) H23A1 DOHC	1992-1996	60
Prelude	1958CC (2.0L) B20A5 DOHC	1988-1991	48				

1 1169CC (1.2L) EB1 SOHC 4 Cyl, 2.756in./70mm (1973) 1

Part	Year	VIN	Model/Application	Part Number	Qty.
------	------	-----	-------------------	-------------	------

ENGINE GASKETS

Head Set	1973			HS3641	1
Full Set	1973			FS3641	1
Cylinder Head Gasket	1973		Nitroseal	3641	1
Valve Cover Set	1973		Victo-Tech	VS30040	1
Valve Stem Seal, Int.	1973			B45438	4
Manifold Set, Exhaust	1973			MS15271	1
Manifold Set, Intake	1973			MS15245	1
Oil Pan Set	1973		Victo-Tech	OS30074	1
Rear Main Seal	1973		Rubber	47729	1
Timing Cover Set	1973		(Contains Camshaft Seal, Contains Timing Cover Seal)	JV915	1
Timing Cover Seal	1973			47728	1

MISCELLANEOUS GASKETS

Camshaft Seal	1973			66580	1
Exhaust Pipe Gasket	1973		Thru Chassis Number C2191401, (Ring Type 'A'), Exhaust Pipe To Muffler	F14596	1
			From Chassis Number C2191402, (Ring Type 'A'), Pipe To Manifold	F14619	1
Water Outlet Gasket	1973			C20116	1
Water Pump Mount Gasket	1973		Victo-Tech	K27992	1

2 1237CC (1.2L) EB2 SOHC 4 Cyl, 2.835in./72mm (1974-1977) 2

Part	Year	VIN	Model/Application	Part Number	Qty.
------	------	-----	-------------------	-------------	------

ENGINE GASKETS

Head Set	1974-1977			HS3641	1
Full Set	1975-1977		From Engine Number 2025149	FS3641W	1
	1974-1975		Thru Engine Number 2025148	FS3641	1
Cylinder Head Gasket	1974-1977		Nitroseal	3641	1
Valve Cover Set	1974-1977		Victo-Tech	VS30040	1
Valve Stem Seal, Int.	1974-1977			B45438	4
Manifold Set, Exhaust	1974-1977			MS15271	1
Manifold Set, Intake	1974-1977			MS15245	1
Oil Pan Set	1975-1977		From Engine Number 2025149	Victo-Tech OS30287	1
	1974-1975		Thru Engine Number 2025148	Victo-Tech OS30074	1
Rear Main Seal	1974-1977		Rubber	47729	1
Timing Cover Set	1974-1977		(Contains Camshaft Seal, Contains Timing Cover Seal)	JV915	1
Timing Cover Seal	1974-1977			47728	1

MISCELLANEOUS GASKETS

Camshaft Seal	1974-1977			66580	1
Carb. Mount Gasket	1975-1977		From Engine Number 2025149, 2 Barrel Carburetor	G31151	1
Exhaust Pipe Gasket	1977		(Ring Type 'A'), Exhaust Pipe To Muffler	F14615	1
	1975-1977		(Ring Type 'A'), Exhaust Pipe To Muffler	F14596	1
	1974-1977		(Ring Type 'A'), Pipe To Manifold	F14619	1
Water Outlet Gasket	1974-1977			C20116	1
Water Pump Mount Gasket	1974-1977		Victo-Tech	K27992	1

3 1237CC (1.2L) EB3 SOHC 4 Cyl, 2.835in./72mm (1978-1979)**3**

Part	Year	VIN	Model/Application	Part Number	Qty.
ENGINE GASKETS					
Head Set	1978-1979			HS3641	1
Full Set	1978-1979			FS3641W	1
Cylinder Head Gasket	1978-1979		Nitroseal	3641	1
Valve Cover Set	1978-1979		Victo-Tech	VS30040	1
Valve Stem Seal, Int.	1978-1979			B45438	4
Manifold Set, Exhaust	1978-1979			MS15271	1
Manifold Set, Intake	1978-1979			MS15245	1
Oil Pan Set	1978-1979		Victo-Tech	OS30287	1
Rear Main Seal	1978-1979		Rubber	47729	1
Timing Cover Set	1978-1979		(Contains Camshaft Seal, Contains Timing Cover Seal)	JV915	1
Timing Cover Seal	1978-1979			47728	1

MISCELLANEOUS GASKETS

Camshaft Seal	1978-1979			66580	1
Carb. Mount Gasket	1978-1979		2 Barrel Carburetor	G31151	1
Exhaust Pipe Gasket	1978-1979		(Ring Type 'A'), Exhaust Pipe To Muffler	F14596	1
			(Ring Type 'A'), Pipe To Manifold	F14619	1
Water Outlet Gasket	1978-1979		Thru Serial Number 2015595	C20116	1
			From Serial Number 2015596	Victo-Tech C20322	1
Water Pump Mount Gasket	1978-1979		Victo-Tech	K27992	1

4 1335CC (1.3L) EJ1 SOHC 4 Cyl, 2.835in./72mm (1980-1983)**4**

Part	Year	VIN	Model/Application	Part Number	Qty.
ENGINE GASKETS					
Head Set	1982-1983			HS3713X	1
	1981			HS3713W	1
	1980			HS3713	1
Full Set	1982-1983			FS3713X	1
	1981			FS3713W	1
	1980			FS3713	1
Cylinder Head Gasket	1980-1983		Nitroseal	3713	1
Valve Cover Set	1982-1983		Victo-Tech	VS38331	1
	1980-1981		Victo-Tech	VS38325	1
Valve Stem Oil Seal, Aux.	1981-1983		(Auxiliary Seal)	B45448	4
Valve Stem Seal, Exh.	1980-1983			B45460	4
Valve Stem Seal, Int.	1980-1983			B45459	4
Manifold Set, Int. & Exh.	1981-1983			MS15530	1
	1980			MS15292	1
Oil Pan Set	1980-1983		Victo-Tech	OS30287	1
Rear Main Seal	1980-1983		Rubber	47729	1
Timing Cover Set	1980-1983		(Contains Camshaft Seal, Contains Timing Cover Seal)	JV967	1
Timing Cover Seal	1980-1983			47728	1

MISCELLANEOUS GASKETS

Camshaft Seal	1980-1983			66580	1
Carb. Mount Gasket	1981-1983		2 Barrel Carburetor	G31152	1
	1980		2 Barrel Carburetor	G31151	1
E.G.R. Gasket	1980-1983			G26315	1
Exhaust Pipe Gasket	1981-1983		(Ring Type 'A'), Pipe To Manifold	F14616	1
	1980		(Ring Type 'A'), Pipe To Manifold	F7215	1
Therm. Housing Gasket	1980-1983			C30728	1
Thermostat O-Ring	1980-1983		Victo-Tech	C24096	1
Valve Cover Washer Seal	1980-1981			B45487	2
Water Outlet Gasket	1980-1983		(O-Ring Type)	Victo-Tech C20322	1

Honda

4 (cont.)	1335CC (1.3L) EJ1 SOHC 4 Cyl, 2.835in./72mm (1980-1983)				4 (cont.)
---------------------	--	--	--	--	---------------------

Part	Year	VIN	Model/Application	Part Number	Qty.
------	------	-----	-------------------	-------------	------

MISCELLANEOUS GASKETS (cont.)

Water Pump Mount Gasket	1980-1983			<i>Victo-Tech</i> K27992	1
-------------------------	-----------	--	--	--------------------------	---

5	1335CC (1.3L) EN1 4 Cyl, 2.835in./72mm (1979-1983)				5
----------	---	--	--	--	----------

Part	Year	VIN	Model/Application	Part Number	Qty.
------	------	-----	-------------------	-------------	------

ENGINE GASKETS

Head Set	1979-1983		Canadian	HS3641Z	1
	1980		Canadian	HS3641X	1
Full Set	1981-1983		Canadian	FS3641Z	1
	1980		Canadian	FS3641X	1
Cylinder Head Gasket	1980-1983		Canadian	<i>Nitroseal</i> 3641	1
Valve Cover Set	1981-1983		Canadian	<i>Victo-Tech</i> VS50065	1
	1980		Canadian	<i>Victo-Tech</i> VS30040	1
Valve Stem Seal, Exh.	1980-1983		Canadian	B45460	4
Valve Stem Seal, Int.	1980-1983		Canadian	B45459	4
Manifold Set, Exhaust	1980-1983		Canadian	MS15271	1
Manifold Set, Intake	1980-1983		Canadian	MS15245	1
Oil Pan Set	1980-1983		Canadian	<i>Victo-Tech</i> OS30287	1
Rear Main Seal	1980-1983		Canadian	<i>Rubber</i> 47729	1
Timing Cover Set	1980-1983		Canadian, (Contains Camshaft Seal, Contains Timing Cover Seal)	JV1071	1
Timing Cover Seal	1980-1983		Canadian	47728	1

MISCELLANEOUS GASKETS

Camshaft Seal	1980-1983			66580	1
E.G.R. Gasket	1980-1983		Canadian	G26315	1
Exhaust Pipe Gasket	1980-1983		Canadian, (Ring Type 'A'), Pipe To Manifold	F14616	1
Therm. Housing Gasket	1980-1983		Canadian	C30728	1
Thermostat O-Ring	1980-1983		Canadian	<i>Victo-Tech</i> C24096	1
Water Outlet Gasket	1980-1983		Canadian, (O-Ring Type)	<i>Victo-Tech</i> C20322	1
Water Pump Mount Gasket	1980-1983		Canadian	<i>Victo-Tech</i> K27992	1

6	1342CC (1.3L) D13A2 SOHC 4 Cyl, 2.913in./74mm (1987)				6
----------	---	--	--	--	----------

Part	Year	VIN	Model/Application	Part Number	Qty.
------	------	-----	-------------------	-------------	------

ENGINE GASKETS

Head Set	1987		(Requires Lower Set To Make Full Set)	HS3782A	1
Lower Set	1987		(Requires Head Set To Make Full Set)	CS3782	1
Engine Kit Gasket Set	1987			95-3393VR	1
Cylinder Head Gasket	1987			<i>Nitroseal</i> 3782	1
Valve Cover Set	1987		(Contains Valve Cover Washers)	<i>Victo-Tech</i> VS38379	1
Valve Stem Oil Seal, Aux.	1987		(Auxiliary Seal)	B45524	4
Valve Stem Seal, Exh.	1987			B45521	4
Valve Stem Seal, Int.	1987			B45499	4
Manifold Set, Exhaust	1987			MS10056	1
Manifold Set, Intake	1987			MS15371	1
Oil Pan Set	1987			<i>Victo-Tech</i> OS38142	1
Rear Main Seal	1987			<i>Rubber</i> 67121	1
Timing Cover Set	1987		(Contains Camshaft Seal, Contains Timing Cover Seal)	JV1003	1
Timing Cover Seal	1987			47728	1

MISCELLANEOUS GASKETS

Camshaft Seal	1987			66918	1
E.G.R. Gasket	1987			G26315	1
Exhaust Pipe Gasket	1987		(Ring Type 'A'), Catalytic Converter To Front Exhaust Pipe	F7413	2

6 (cont.)	1342CC (1.3L) D13A2 SOHC 4 Cyl, 2.913in./74mm (1987)				6 (cont.)
---------------------	---	--	--	--	---------------------

<i>Part</i>	<i>Year</i>	<i>VIN</i>	<i>Model/Application</i>	<i>Part Number</i>	<i>Qty.</i>
MISCELLANEOUS GASKETS (cont.)					
Exhaust Pipe Gasket (cont.)	1987		(Flange Type), Manifold To Converter	F10057	1
Water Outlet Gasket	1987		<i>Victo-Tech</i>	C24173	1
Water Pump Mount Gasket	1987		<i>Victo-Tech</i>	K27660	1

7	1342CC (1.3L) EV1 SOHC 4 Cyl, 2.913in./74mm (1984-1986)				7
----------	--	--	--	--	----------

<i>Part</i>	<i>Year</i>	<i>VIN</i>	<i>Model/Application</i>	<i>Part Number</i>	<i>Qty.</i>
ENGINE GASKETS					
Head Set	1984-1986		Civic, (Requires Lower Set To Make Full Set)	HS3782A	1
	1984		CRX, (Valve Cover Gasket Not Included, Requires Lower Set To Make Full Set)	HS3782A	1
			CRX, To Be Replaced By HS3782A	HS3782W	1
Lower Set	1984-1986		(Requires Head Set To Make Full Set)	CS3782	1
Engine Kit Gasket Set	1984-1986			95-3393VR	1
	1984		CRX, HF, (Valve Cover Set Not Included), Use With Part Number VS38379	95-3393VR	1
Cylinder Head Gasket	1984-1986		<i>Nitroseal</i>	3782	1
Valve Cover Set	1984-1986		Civic, (Contains Valve Cover Washers)	<i>Victo-Tech</i> VS38379	1
	1984		CRX	<i>Victo-Tech</i> VS40001	1
Valve Stem Oil Seal, Aux.	1984-1986		(Auxiliary Seal)	B45524	4
Valve Stem Seal, Exh.	1984-1986			B45521	4
Valve Stem Seal, Int.	1984-1986			B45499	4
Manifold Set, Exhaust	1984-1986			MS10056	1
Manifold Set, Intake	1984-1986			MS15371	1
Oil Pan Set	1984-1986		<i>Victo-Tech</i>	OS38142	1
Rear Main Seal	1984-1986		<i>Rubber</i>	67121	1
Timing Cover Set	1984-1986		(Contains Camshaft Seal, Contains Timing Cover Seal)	JV1003	1
Timing Cover Seal	1984-1986			47728	1

MISCELLANEOUS GASKETS

Aux. Valve O-Ring	1984-1986			B45731	4
Aux. Valve Washer	1984-1986			B45526	4
Camshaft Seal	1984-1986			66918	1
E.G.R. Gasket	1984-1986			G26315	1
Exhaust Pipe Gasket	1984-1986		Civic, (Ring Type 'A'), Catalytic Converter To Front Exhaust Pipe	F7413	2
			Civic, (Flange Type), Manifold To Converter	F10057	1
	1984-1985		Civic, (Ring Type 'A'), Intermediate Pipe To Muffler	F12329	1
			Civic, (Ring Type 'F'), Front Pipe To Intermediate Pipe	F12330	1
	1984		CRX, (Ring Type 'A'), Catalytic Converter To Front Exhaust Pipe	F7413	2
			CRX, (Flange Type), Manifold To Converter	F10057	1
Water Outlet Gasket	1984-1986		<i>Victo-Tech</i>	C24173	1
Water Pump Mount Gasket	1984-1986		<i>Victo-Tech</i>	K27660	1

8	1342CC (1.3L) EV2 4 Cyl, 2.913in./74mm (1984-1986)				8
----------	---	--	--	--	----------

<i>Part</i>	<i>Year</i>	<i>VIN</i>	<i>Model/Application</i>	<i>Part Number</i>	<i>Qty.</i>
ENGINE GASKETS					
Head Set	1984-1986		Canadian, (Requires Lower Set To Make Full Set)	HS3782A	1
Lower Set	1984-1986		Canadian, (Requires Head Set To Make Full Set)	CS3782	1
Cylinder Head Gasket	1984-1986		Canadian <i>Nitroseal</i>	3782	1
Valve Cover Set	1984-1986		Canadian, (Contains Valve Cover Washers) <i>Victo-Tech</i>	VS38379	1
Valve Stem Oil Seal, Aux.	1984-1986		(Auxiliary Seal)	B45440	4

Honda

8 (cont.)	1342CC (1.3L) EV2 4 Cyl, 2.913in./74mm (1984-1986)					8 (cont.)
---------------------	---	--	--	--	--	---------------------

<i>Part</i>	<i>Year</i>	<i>VIN</i>	<i>Model/Application</i>	<i>Part Number</i>	<i>Qty.</i>
-------------	-------------	------------	--------------------------	--------------------	-------------

ENGINE GASKETS (cont.)

Valve Stem Seal, Exh.	1984-1986			B45460	4
Valve Stem Seal, Int.	1984-1986			B45459	4
Manifold Set, Exhaust	1984-1986		Canadian	MS10056	1
Manifold Set, Intake	1984-1986		Canadian	MS15413	1
Oil Pan Set	1984-1986		Canadian <i>Victo-Tech</i>	OS38142	1
Rear Main Seal	1984-1986		Canadian <i>Rubber</i>	67121	1
Timing Cover Set	1984-1986		Canadian, (Contains Camshaft Seal, Contains Timing Cover Seal)	JV1003	1
Timing Cover Seal	1984-1986		Canadian	47728	1

MISCELLANEOUS GASKETS

Camshaft Seal	1984-1986			66918	1
E.G.R. Gasket	1984-1986		Canadian	G26315	1
Water Outlet Gasket	1984-1986		<i>Victo-Tech</i>	C24173	1
Water Pump Mount Gasket	1984-1986		<i>Victo-Tech</i>	K27660	1

9	1488CC (1.5L) D15A1 4 Cyl, 2.913in./74mm (1987)					9
----------	--	--	--	--	--	----------

<i>Part</i>	<i>Year</i>	<i>VIN</i>	<i>Model/Application</i>	<i>Part Number</i>	<i>Qty.</i>
-------------	-------------	------------	--------------------------	--------------------	-------------

ENGINE GASKETS

Head Set	1987		Canadian, (Requires Lower Set To Make Full Set)	HS3782A	1
Lower Set	1987		Canadian, (Requires Head Set To Make Full Set)	CS3782	1
Cylinder Head Gasket	1987		Canadian <i>Nitroseal</i>	3782	1
Valve Cover Set	1987		Canadian, (Contains Valve Cover Washers) <i>Victo-Tech</i>	VS38379	1
Valve Stem Oil Seal, Aux.	1987		Canadian, (Auxiliary Seal)	B45440	4
Valve Stem Seal, Exh.	1987		Canadian	B45460	4
Valve Stem Seal, Int.	1987		Canadian	B45459	4
Manifold Set, Exhaust	1987		Canadian	MS10056	1
Manifold Set, Intake	1987		Canadian	MS15413	1
Oil Pan Set	1987		Canadian <i>Victo-Tech</i>	OS38142	1
Rear Main Seal	1987		Canadian <i>Rubber</i>	67121	1
Timing Cover Set	1987		Canadian, (Contains Camshaft Seal, Contains Timing Cover Seal)	JV1003	1
Timing Cover Seal	1987		Canadian	47728	1

MISCELLANEOUS GASKETS

Camshaft Seal	1987		Canadian	66918	1
E.G.R. Gasket	1987		Canadian	G26315	1
Water Outlet Gasket	1987		Canadian <i>Victo-Tech</i>	C24173	1
Water Pump Mount Gasket	1987		Canadian <i>Victo-Tech</i>	K27660	1

10	1488CC (1.5L) D15A2 SOHC 4 Cyl, 2.913in./74mm (1987)					10
-----------	---	--	--	--	--	-----------

<i>Part</i>	<i>Year</i>	<i>VIN</i>	<i>Model/Application</i>	<i>Part Number</i>	<i>Qty.</i>
-------------	-------------	------------	--------------------------	--------------------	-------------

ENGINE GASKETS

Head Set	1987		(Requires Lower Set To Make Full Set)	HS3782A	1
Lower Set	1987		(Requires Head Set To Make Full Set)	CS3782	1
Engine Kit Gasket Set	1987		CRX, Civic, (Valve Cover Set Not Included For Crx HF), Use With Part Number VS38379	95-3393VR	1
Cylinder Head Gasket	1987		<i>Nitroseal</i>	3782	1
Cyl. Head Spacer Shim	1987		Requires Sealing Compound <i>Steel</i>	3782S	1
Sealing Compound	1987		(4 Ounce Brush Top Can)	JV66B	1
			(12 Ounce Spray Can)	JV66S	1
Valve Cover Set	1987		(Contains Valve Cover Washers) <i>Victo-Tech</i>	VS38379	1
Manifold Set, Exhaust	1987			MS10056	1
Manifold Set, Intake	1987			MS15371	1

10 (cont.)	1488CC (1.5L) D15A2 SOHC 4 Cyl, 2.913in./74mm (1987)				10 (cont.)
----------------------	---	--	--	--	----------------------

Part	Year	VIN	Model/Application	Part Number	Qty.
------	------	-----	-------------------	-------------	------

ENGINE GASKETS (cont.)

Oil Pan Set	1987		<i>Victo-Tech</i>	OS38142	1
Rear Main Seal	1987		<i>Rubber</i>	67121	1
Timing Cover Set	1987		(Contains Camshaft Seal, Contains Timing Cover Seal)	JV1003	1

MISCELLANEOUS GASKETS

Camshaft Seal	1987			66918	1
E.G.R. Gasket	1987			G26315	1
Exhaust Pipe Gasket	1987		4 Wheel Drive, (Ring Type 'A'), Middle Pipe To Rear Pipe	F7412	1
			(Ring Type 'A'), Catalytic Converter To Front Exhaust Pipe	F7413	2
			(Flange Type), Manifold To Converter	F10057	1
			Except Station Wagon, (Ring Type 'A'), Converter To Exhaust Pipe	F12329	1
			(Ring Type 'F'), Front Pipe To Intermediate Pipe	F12330	1
			4 Wheel Drive, (Ring Type 'A'), Exhaust Pipe To Muffler	F14592	1
			Front Wheel Drive, (Ring Type 'A'), Converter To Exhaust Pipe	F14592	1
Thermostat O-Ring	1987		<i>Victo-Tech</i>	C24096	1
Water Outlet Gasket	1987		<i>Victo-Tech</i>	C24173	1
Water Pump Mount Gasket	1987		<i>Victo-Tech</i>	K27660	1

11	1488CC (1.5L) D15A3 4 Cyl, 2.913in./74mm (1987)				11
-----------	--	--	--	--	-----------

Part	Year	VIN	Model/Application	Part Number	Qty.
------	------	-----	-------------------	-------------	------

ENGINE GASKETS

Head Set	1987		(Requires Lower Set To Make Full Set)	HS3782B	1
Lower Set	1987		(Requires Head Set To Make Full Set)	CS3782	1
Cylinder Head Gasket	1987		<i>Nitroseal</i>	3782	1
Cyl. Head Spacer Shim	1987		Requires Sealing Compound	<i>Steel</i> 3782S	1
Sealing Compound	1987		(4 Ounce Brush Top Can)	JV66B	1
			(12 Ounce Spray Can)	JV66S	1
Valve Cover Set	1987		(Contains Valve Cover Washers)	<i>Victo-Tech</i> VS50015	1
Valve Stem Seal, Exh.	1987			B45521	4
Valve Stem Seal, Int.	1987			B45499	4
Manifold Set, Exhaust	1987			MS10056	1
Manifold Set, Intake	1987			MS15413	1
Oil Pan Set	1987		<i>Victo-Tech</i>	OS38142	1
Rear Main Seal	1987		<i>Rubber</i>	67121	1
Timing Cover Set	1987		(Contains Camshaft Seal, Contains Timing Cover Seal)	JV1003	1

MISCELLANEOUS GASKETS

Camshaft Seal	1987			66918	1
E.G.R. Gasket	1987			G26315	1
Exhaust Pipe Gasket	1987		(Ring Type 'A'), Converter To Exhaust Pipe	F7412	1
			(Ring Type 'F')	F12331	1
			(Ring Type 'A'), Intermediate Pipe To Muffler	F14592	1
Thermostat O-Ring	1987		<i>Victo-Tech</i>	C24096	1
Water Outlet Gasket	1987		<i>Victo-Tech</i>	C24173	1
Water Pump Mount Gasket	1987		<i>Victo-Tech</i>	K27660	1

12	1488CC (1.5L) ED1/ED2 4 Cyl, 2.913in./74mm (1975-1976)				12
-----------	---	--	--	--	-----------

Part	Year	VIN	Model/Application	Part Number	Qty.
------	------	-----	-------------------	-------------	------

ENGINE GASKETS

Head Set	1975-1976			HS3640	1
Full Set	1975-1976			FS3640	1
Cylinder Head Gasket	1975-1976		<i>Nitroseal</i>	3640	1

Honda

12 (cont.)	1488CC (1.5L) ED1/ED2 4 Cyl, 2.913in./74mm (1975-1976)				12 (cont.)
----------------------	---	--	--	--	----------------------

<i>Part</i>	<i>Year</i>	<i>VIN</i>	<i>Model/Application</i>	<i>Part Number</i>	<i>Qty.</i>
ENGINE GASKETS (cont.)					
Cyl. Head Spacer Shim	1975-1976		Requires Sealing Compound	<i>Steel</i> 3640S	1
Sealing Compound	1975-1976		(4 Ounce Brush Top Can)	JV66B	1
			(12 Ounce Spray Can)	JV66S	1
Valve Cover Set	1975-1976			<i>Victo-Tech</i> VS30039	1
Valve Stem Oil Seal, Aux.	1975-1976		(Auxiliary Seal)	B45440	4
Valve Stem Seal, Exh.	1975-1976			B45439	4
Valve Stem Seal, Int.	1975-1976			B45438	4
Manifold Set, Int. & Exh.	1975-1976			MS15291	1
Oil Pan Set	1975-1976			<i>Victo-Tech</i> OS30287	1
Rear Main Seal	1975-1976			<i>Rubber</i> 47729	1
Timing Cover Set	1975-1976		(Contains Camshaft Seal, Contains Timing Cover Seal)	JV914	1
Timing Cover Seal	1975-1976			47728	1

MISCELLANEOUS GASKETS					
Aux. Valve O-Ring	1975-1976			B45553	4
Camshaft Seal	1975-1976			66580	1
Exhaust Pipe Gasket	1975		(Ring Type 'A'), Exhaust Pipe To Muffler	F14596	1
Therm. Housing Gasket	1975-1976			C30727	1
Thermostat O-Ring	1975-1976			<i>Victo-Tech</i> C24096	1
Water Outlet Gasket	1975-1976			<i>Victo-Tech</i> C20121	1
Water Pump Mount Gasket	1975-1976			<i>Victo-Tech</i> K27992	1

13	1488CC (1.5L) ED3/ED4 4 Cyl, 2.913in./74mm (1976-1979)				13
-----------	---	--	--	--	-----------

<i>Part</i>	<i>Year</i>	<i>VIN</i>	<i>Model/Application</i>	<i>Part Number</i>	<i>Qty.</i>
ENGINE GASKETS					
Head Set	1977-1979		(Exhaust Manifold Gasket For Canada Not Included)	HS3642	1
			Canadian, (Exhaust Manifold Gasket For Canada Not Included)	HS3642	1
	1976			HS3556	1
Full Set	1977-1979		(Exhaust Manifold Gasket For Canada Not Included)	FS3642	1
			Canadian, (Exhaust Manifold Gasket For Canada Not Included)	FS3642	1
	1976			FS3556	1
Engine Kit Gasket Set	1977-1979		(Intake Manifold Gasket Not Included), Use With Part Number MS15292	95-3088VR	1
Cylinder Head Gasket	1977-1979		To Be Replaced By 3714	<i>Nitroseal</i> 3642	1
				<i>Nitroseal</i> 3714	1
	1976			<i>Nitroseal</i> 3556	1
Cyl. Head Spacer Shim	1977-1979		Requires Sealing Compound	<i>Steel</i> 3714S	1
	1976		Requires Sealing Compound	<i>Steel</i> 3556S	1
Sealing Compound	1976-1979		(4 Ounce Brush Top Can)	JV66B	1
			(12 Ounce Spray Can)	JV66S	1
Valve Cover Set	1976-1979			<i>Victo-Tech</i> VS30039	1
Valve Stem Oil Seal, Aux.	1976-1979		(Auxiliary Seal)	B45440	4
Valve Stem Seal, Exh.	1976-1979			B45439	4
Valve Stem Seal, Int.	1976-1979			B45438	4
Manifold Set, Int. & Exh.	1977-1979		Canadian	MS15537	1
	1976-1979		Except Canadian Models	MS15292	1
	1976			MS15292	1
Oil Pan Set	1976-1979			<i>Victo-Tech</i> OS30287	1
Rear Main Seal	1976-1979			<i>Rubber</i> 47729	1

13 1488CC (1.5L) ED3/ED4 4 Cyl, 2.913in./74mm (1976-1979)

(cont.)

13

(cont.)

<i>Part</i>	<i>Year</i>	<i>VIN</i>	<i>Model/Application</i>	<i>Part Number</i>	<i>Qty.</i>
-------------	-------------	------------	--------------------------	--------------------	-------------

ENGINE GASKETS (cont.)

Timing Cover Set	1976-1979		(Contains Camshaft Seal, Contains Timing Cover Seal)	JV914	1
Timing Cover Seal	1976-1979			47728	1

MISCELLANEOUS GASKETS

Aux. Valve O-Ring	1976-1979			B45553	4
Camshaft Seal	1976-1979			66580	1
Exhaust Pipe Gasket	1976-1979		(Ring Type 'A'), Intermediate Pipe To Muffler	F14616	1
			(Ring Type 'A'), Exhaust Pipe To Intermediate Pipe	F14618	1
Therm. Housing Gasket	1976-1979			C30728	1
Thermostat O-Ring	1976-1979		<i>Victo-Tech</i>	C24096	1
Water Outlet Gasket	1976-1979		<i>Victo-Tech</i>	C20322	1
Water Pump Mount Gasket	1976-1979		<i>Victo-Tech</i>	K27992	1

14 1488CC (1.5L) EM1 SOHC 4 Cyl, 2.913in./74mm (1980-1983)**14**

<i>Part</i>	<i>Year</i>	<i>VIN</i>	<i>Model/Application</i>	<i>Part Number</i>	<i>Qty.</i>
-------------	-------------	------------	--------------------------	--------------------	-------------

ENGINE GASKETS

Head Set	1982-1983			HS3714W	1
	1980-1981			HS3714	1
Full Set	1982-1983			FS3714W	1
	1980-1981			FS3714	1
Engine Kit Gasket Set	1982-1983			95-3224VR	1
	1980-1981		(Valve Cover Set Not Included), Use With Part Number VS38325	95-3224VR	1
Cylinder Head Gasket	1980-1983		<i>Nitroseal</i>	3714	1
Cyl. Head Spacer Shim	1980-1983		Requires Sealing Compound <i>Steel</i>	3714S	1
Sealing Compound	1980-1983		(4 Ounce Brush Top Can)	JV66B	1
			(12 Ounce Spray Can)	JV66S	1
Valve Cover Set	1982-1983		(Contains Valve Cover Washers) <i>Victo-Tech</i>	VS38331	1
	1980-1981		<i>Victo-Tech</i>	VS38325	1
Valve Stem Oil Seal, Aux.	1980-1983		(Auxiliary Seal)	B45448	4
Valve Stem Seal, Exh.	1980-1983			B45460	4
Valve Stem Seal, Int.	1980-1983			B45459	4
Manifold Set, Int. & Exh.	1980-1983			MS15530	1
Oil Pan Set	1980-1983		<i>Victo-Tech</i>	OS30287	1
Rear Main Seal	1980-1983		<i>Rubber</i>	47729	1
Timing Cover Set	1980-1983		(Contains Camshaft Seal, Contains Timing Cover Seal)	JV968	1
Timing Cover Seal	1980-1982			47728	1

MISCELLANEOUS GASKETS

Aux. Valve O-Ring	1980-1983			B45553	4
Camshaft Seal	1980-1983			66580	1
Carb. Mount Gasket	1980-1983		2 Barrel Carburetor	G31152	1
E.G.R. Gasket	1980-1983			G26315	1
Exhaust Pipe Gasket	1980-1983		(Ring Type 'A'), Catalytic Converter To Exhaust Pipe	F7412	2
			(Ring Type 'A'), Intermediate Pipe To Muffler	F14592	1
Therm. Housing Gasket	1980-1983			C30728	1
Thermostat O-Ring	1980-1983		<i>Victo-Tech</i>	C24096	1
Valve Cover Washer Seal	1980-1983			B45487	2
Water Outlet Gasket	1980-1983		<i>Victo-Tech</i>	C20322	1
Water Pump Mount Gasket	1980-1983		<i>Victo-Tech</i>	K27992	1

Honda

15 1488CC (1.5L) EW1 SOHC 4 Cyl, 2.913in./74mm (1984-1986)

15

Part	Year	VIN	Model/Application	Part Number	Qty.
ENGINE GASKETS					
Head Set	1985-1986		HF, (Valve Cover Gasket Not Included, Requires Lower Set To Make Full Set)	HS3782A	1
	1984-1986		CRX, Civic, (Requires Lower Set To Make Full Set)	HS3782A	1
	1985		HF, To Be Replaced By HS3782A	HS3782W	1
Lower Set	1984-1986		CRX, Civic, (Requires Head Set To Make Full Set)	CS3782	1
Engine Kit Gasket Set	1985-1986		CRX, HF, (Valve Cover Set Not Included), Use With Part Number VS38379	95-3393VR	1
	1984-1986		CRX, Civic	95-3393VR	1
Cylinder Head Gasket	1984-1986		CRX, Civic <i>Nitroseal</i>	3782	1
Cyl. Head Bolt Set	1984-1986		CRX, Civic	GS33313	1
Cyl. Head Spacer Shim	1984-1986		CRX, Civic, Requires Sealing Compound <i>Steel</i>	3782S	1
Sealing Compound	1984-1986		(4 Ounce Brush Top Can)	JV66B	1
			(12 Ounce Spray Can)	JV66S	1
Valve Cover Set	1985-1986		HF <i>Victo-Tech</i>	VS40001	1
	1984-1986		Civic, (Contains Valve Cover Washers) <i>Victo-Tech</i>	VS38379	1
			CRX, Except CRX 1500HF, (Contains Valve Cover Washers) <i>Victo-Tech</i>	VS38379	1
Valve Stem Oil Seal, Aux.	1984-1985		CRX, Civic, (Auxiliary Seal)	B45524	4
Valve Stem Seal, Exh.	1984-1985		CRX, Civic	B45521	4
Valve Stem Seal, Int.	1984-1985		CRX, Civic	B45499	8
Manifold Set, Exhaust	1984-1986		CRX, Civic	MS10056	1
Manifold Set, Intake	1984-1986		CRX, Civic	MS15371	1
Oil Pan Set	1984-1986		CRX, Civic <i>Victo-Tech</i>	OS38142	1
Rear Main Seal	1984-1986		CRX, Civic <i>Rubber</i>	67121	1
Timing Cover Set	1984-1986		CRX, Civic, (Contains Camshaft Seal, Contains Timing Cover Seal)	JV1003	1

MISCELLANEOUS GASKETS

Camshaft Seal	1984-1986		CRX, Civic	66918	1
E.G.R. Gasket	1984-1986		CRX, Civic	G26315	1
Exhaust Pipe Gasket	1985-1986		Civic, 4 Wheel Drive, (Ring Type 'A'), Middle Pipe To Rear Pipe	F7412	1
			Civic, 4 Wheel Drive, (Ring Type 'A'), Exhaust Pipe To Muffler	F14592	1
	1984-1986		Civic, (Ring Type 'A'), Catalytic Converter To Front Exhaust Pipe	F7413	2
			CRX, Civic, (Flange Type), Manifold To Converter	F10057	1
			CRX, Civic, Except Station Wagon, (Ring Type 'A'), Converter To Exhaust Pipe	F12329	1
			CRX, Civic, (Ring Type 'F'), Front Pipe To Intermediate Pipe	F12330	1
			Civic, Front Wheel Drive, (Ring Type 'A'), Converter To Exhaust Pipe	F14592	1
Thermostat O-Ring	1984-1986		CRX, Civic <i>Victo-Tech</i>	C24096	1
Water Outlet Gasket	1984-1986		CRX, Civic <i>Victo-Tech</i>	C24173	1
Water Pump Mount Gasket	1984-1986		CRX, Civic <i>Victo-Tech</i>	K27660	1

16 1488CC (1.5L) EW2 4 Cyl, 2.913in./74mm (1984-1986)

16

Part	Year	VIN	Model/Application	Part Number	Qty.
ENGINE GASKETS					
Head Set	1984-1986		Canadian, (Requires Lower Set To Make Full Set)	HS3782A	1
Lower Set	1984-1986		Canadian, (Requires Head Set To Make Full Set)	CS3782	1
Cylinder Head Gasket	1984-1986		Canadian <i>Nitroseal</i>	3782	1
Cyl. Head Spacer Shim	1984-1986		Canadian, Requires Sealing Compound <i>Steel</i>	3782S	1
Sealing Compound	1984-1986		(4 Ounce Brush Top Can)	JV66B	1
			(12 Ounce Spray Can)	JV66S	1
Valve Cover Set	1986		Canadian, (Contains Valve Cover Washers) <i>Victo-Tech</i>	VS38379	1

16 (cont.)	1488CC (1.5L) EW2 4 Cyl, 2.913in./74mm (1984-1986)				16 (cont.)
----------------------	---	--	--	--	----------------------

<i>Part</i>	<i>Year</i>	<i>VIN</i>	<i>Model/Application</i>	<i>Part Number</i>	<i>Qty.</i>
ENGINE GASKETS (cont.)					
Valve Stem Oil Seal, Aux.	1984-1986		Canadian, (Auxiliary Seal)	B45440	4
Valve Stem Seal, Exh.	1984-1986		Canadian	B45460	4
Valve Stem Seal, Int.	1984-1986		Canadian	B45459	4
Manifold Set, Exhaust	1984-1986		Canadian	MS10056	1
Manifold Set, Intake	1984-1986		Canadian	MS15413	1
Oil Pan Set	1984-1986		Canadian <i>Victo-Tech</i>	OS38142	1
Rear Main Seal	1984-1986		Canadian <i>Rubber</i>	67121	1
Timing Cover Set	1984-1986		Canadian, (Contains Camshaft Seal, Contains Timing Cover Seal)	JV1003	1

MISCELLANEOUS GASKETS

Camshaft Seal	1984-1986			66918	1
E.G.R. Gasket	1984-1986		Canadian	G26315	1
Thermostat O-Ring	1984-1986		Canadian <i>Victo-Tech</i>	C24096	1
Water Outlet Gasket	1984-1986		Canadian <i>Victo-Tech</i>	C24173	1
Water Pump Mount Gasket	1984-1986		Canadian <i>Victo-Tech</i>	K27660	1

17	1488CC (1.5L) EW3 SOHC 4 Cyl, 2.913in./74mm (1985)				17
-----------	---	--	--	--	-----------

<i>Part</i>	<i>Year</i>	<i>VIN</i>	<i>Model/Application</i>	<i>Part Number</i>	<i>Qty.</i>
ENGINE GASKETS					
Head Set	1985		(Requires Lower Set To Make Full Set)	HS3782B	1
Lower Set	1985		(Requires Head Set To Make Full Set)	CS3782	1
Cylinder Head Gasket	1985		<i>Nitroseal</i>	3782	1
Cyl. Head Bolt Set	1985			GS33313	1
Cyl. Head Spacer Shim	1985		Requires Sealing Compound <i>Steel</i>	3782S	1
Sealing Compound	1985		(4 Ounce Brush Top Can)	JV66B	1
			(12 Ounce Spray Can)	JV66S	1
Valve Cover Set	1985		(Contains Valve Cover Washers) <i>Victo-Tech</i>	VS50015	1
Valve Stem Seal, Exh.	1985			B45521	4
Valve Stem Seal, Int.	1985			B45499	8
Manifold Set, Exhaust	1985			MS10056	1
Manifold Set, Intake	1985			MS15371	1
Oil Pan Set	1985		<i>Victo-Tech</i>	OS38142	1
Rear Main Seal	1985		<i>Rubber</i>	67121	1
Timing Cover Set	1985		(Contains Camshaft Seal, Contains Timing Cover Seal)	JV1003	1

MISCELLANEOUS GASKETS

Camshaft Seal	1985			66918	1
E.G.R. Gasket	1985			G26315	1
Exhaust Pipe Gasket	1985		(Ring Type 'A'), Converter To Exhaust Pipe	F7412	1
			(Ring Type 'F')	F12331	1
			(Ring Type 'A'), Intermediate Pipe To Muffler	F14592	1
Thermostat O-Ring	1985		<i>Victo-Tech</i>	C24096	1
Water Outlet Gasket	1985		<i>Victo-Tech</i>	C24173	1
Water Pump Mount Gasket	1985		<i>Victo-Tech</i>	K27660	1

18	1488CC (1.5L) EW4 4 Cyl, 2.913in./74mm (1986)				18
-----------	--	--	--	--	-----------

<i>Part</i>	<i>Year</i>	<i>VIN</i>	<i>Model/Application</i>	<i>Part Number</i>	<i>Qty.</i>
ENGINE GASKETS					
Head Set	1986			HS3782B	1
Cylinder Head Gasket	1986		<i>Nitroseal</i>	3782	1
Cyl. Head Bolt Set	1986			GS33313	1

Honda

18 (cont.)	1488CC (1.5L) EW4 4 Cyl, 2.913in./74mm (1986)				18 (cont.)
----------------------	--	--	--	--	----------------------

Part	Year	VIN	Model/Application	Part Number	Qty.
------	------	-----	-------------------	-------------	------

ENGINE GASKETS (cont.)

Cyl. Head Spacer Shim	1986		Requires Sealing Compound	<i>Steel</i> 3782S	1
Sealing Compound	1986		(4 Ounce Brush Top Can)	JV66B	1
			(12 Ounce Spray Can)	JV66S	1
Valve Cover Set	1986		(Contains Valve Cover Washers)	<i>Victo-Tech</i> VS50015	1
Valve Stem Seal, Exh.	1986			B45521	4
Valve Stem Seal, Int.	1986			B45499	4
Manifold Set, Exhaust	1986			MS10056	1
Manifold Set, Intake	1986			MS15413	1
Oil Pan Set	1986			<i>Victo-Tech</i> OS38142	1
Rear Main Seal	1986			<i>Rubber</i> 67121	1
Timing Cover Set	1986		(Contains Camshaft Seal, Contains Timing Cover Seal)	JV1003	1

MISCELLANEOUS GASKETS

Camshaft Seal	1986			66918	1
E.G.R. Gasket	1986			G26315	1
Exhaust Pipe Gasket	1986		(Ring Type 'A'), Converter To Exhaust Pipe	F7412	1
			(Ring Type 'F')	F12331	1
			(Ring Type 'A'), Intermediate Pipe To Muffler	F14592	1
Thermostat O-Ring	1986			<i>Victo-Tech</i> C24096	1
Water Outlet Gasket	1986			<i>Victo-Tech</i> C24173	1
Water Pump Mount Gasket	1986			<i>Victo-Tech</i> K27660	1

19	1493CC (1.5L) D15B1/D15B2 4 Cyl, 2.953in./75mm (1988-1991)				19
-----------	---	--	--	--	-----------

Part	Year	VIN	Model/Application	Part Number	Qty.
------	------	-----	-------------------	-------------	------

ENGINE GASKETS

Head Set	1988-1991		To Be Replaced By HS5731A	HS5731	1
			(Requires Lower Set To Make Full Set)	HS5731A	1
Lower Set	1988-1991		(Requires Head Set To Make Full Set)	CS5731A	1
Full Set	1988-1991		To Be Replaced By 95-3394VR	FS5731	1
Engine Kit Gasket Set	1988-1991			95-3394VR	1
				95-3496VR	1
Cylinder Head Gasket	1988-1991			<i>Nitroseal</i> 5731	1
				<i>Multi-Layered Steel</i> 54344	1
Cyl. Head Spacer Shim	1988-1991		Requires Sealing Compound	<i>Steel</i> 5731S	1
Sealing Compound	1988-1991		(4 Ounce Brush Top Can)	JV66B	1
			(12 Ounce Spray Can)	JV66S	1
Valve Cover Set	1988-1991		(Contains Valve Cover Grommets, Contains Spark Plug Tube Seals)	<i>Victo-Tech</i> VS50073	1
Valve Stem Seal, Exh.	1988-1991			B45627	8
Valve Stem Seal, Int.	1988-1991			B45626	8
Manifold Set, Exhaust	1988-1991			MS15487	1
Manifold Set, Intake	1988-1991			MS16160	1
Oil Pan Set	1988-1991			<i>Victo-Tech</i> OS38142	1
Rear Main Seal	1988-1991			<i>Rubber</i> 67121	1
Timing Cover Set	1988-1991		(Camshaft Seal Not Included)	JV1076	1

MISCELLANEOUS GASKETS

Camshaft Seal	1988-1991			66918	1
Camshaft Seal Set	1988-1991			JV1212	1
E.G.R. Gasket	1988-1991			G26315	1
Exhaust Pipe Gasket	1988-1991		(Ring Type 'A'), Pipe To Manifold	F14616	1
Throttle Body Gasket	1988-1991			G31055	1
Water Outlet Gasket	1988-1991			<i>Victo-Tech</i> C31058	1
Water Pump Mount Gasket	1988-1991			<i>Victo-Tech</i> K31057	1

20 1493CC (1.5L) D15B6 SOHC 4 Cyl, 2.953in./75mm (1988-1991)

20

Part	Year	VIN	Model/Application	Part Number	Qty.
ENGINE GASKETS					
Head Set	1988-1991		(Requires Lower Set To Make Full Set)	HS5731A	1
Lower Set	1988-1991		(Requires Head Set To Make Full Set)	CS5731A	1
Engine Kit Gasket Set	1988-1991		HF, (Intake Manifold Gasket Not Included), Use With Part Number MS15488	95-3394VR	1
			(Contains Intake Manifold Gaskets)	95-3496VR	1
Cylinder Head Gasket	1988-1991			<i>Nitroseal</i> 5731	1
				<i>Multi-Layered Steel</i> 54344	1
Cyl. Head Spacer Shim	1988-1991		Requires Sealing Compound	<i>Steel</i> 5731S	1
Sealing Compound	1988-1991		(4 Ounce Brush Top Can)	JV66B	1
			(12 Ounce Spray Can)	JV66S	1
Valve Cover Set	1988-1991		(Contains Valve Cover Grommets, Contains Spark Plug Tube Seals)	<i>Victo-Tech</i> VS50073	1
Valve Stem Seal, Exh.	1988-1991			B45630	4
Valve Stem Seal, Int.	1988-1991			B45629	4
Manifold Set, Exhaust	1988-1991			MS15487	1
Manifold Set, Intake	1988-1991			MS15488	1
Oil Pan Set	1988-1991			<i>Victo-Tech</i> OS38142	1
Rear Main Seal	1988-1991			<i>Rubber</i> 67121	1
Timing Cover Set	1988-1991		(Camshaft Seal Not Included)	JV1076	1

MISCELLANEOUS GASKETS

Camshaft Seal	1988-1991			66918	1
Camshaft Seal Set	1988-1991			JV1212	1
E.G.R. Gasket	1988-1991			G26315	1
Exhaust Pipe Gasket	1988-1991		(Flange Type), Manifold To Converter	F7431	1
			(Ring Type 'A'), Catalytic Converter To Front Exhaust Pipe	F7481	1
Throttle Body Gasket	1988-1991			G31054	1
Throttle Body O-ring	1988-1991		(O-Ring Type)	G31056	1
Water Outlet Gasket	1988-1991			<i>Victo-Tech</i> C31058	1
Water Pump Mount Gasket	1988-1991			<i>Victo-Tech</i> K31057	1

21 1493CC (1.5L) D15B7 SOHC 4 Cyl, 2.953in./75mm (1992-1995)

21

Part	Year	VIN	Model/Application	Part Number	Qty.
ENGINE GASKETS					
Head Set	1992-1995		(Requires Lower Set To Make Full Set)	HS5731A	1
Lower Set	1992-1995		(Requires Head Set To Make Full Set), To Be Replaced By CS5731A	CS5731	1
			(Requires Head Set To Make Full Set)	CS5731A	1
Engine Kit Gasket Set	1992-1995			95-3496VR	1
Cylinder Head Gasket	1992-1995			<i>Nitroseal</i> 5731	1
				<i>Multi-Layered Steel</i> 54344	1
Cyl. Head Spacer Shim	1992-1995		Requires Sealing Compound	<i>Steel</i> 5731S	1
Sealing Compound	1992-1995		(4 Ounce Brush Top Can)	JV66B	1
			(12 Ounce Spray Can)	JV66S	1
Valve Cover Set	1992-1995		(Contains Valve Cover Grommets, Contains Spark Plug Tube Seals)	<i>Victo-Tech</i> VS50073	1
Valve Stem Seal, Exh.	1992-1995			B45627	8
Valve Stem Seal, Int.	1992-1995			B45626	8
Manifold Set, Exhaust	1992-1995			MS15487	1
Manifold Set, Intake	1992-1995			MS16160	1
Oil Pan Set	1992-1995			<i>Victo-Tech</i> OS38142	1
Rear Main Seal	1992-1995			<i>Rubber</i> 67121	1
Timing Cover Set	1992-1995		(Camshaft Seal Not Included)	JV1171	1

MISCELLANEOUS GASKETS

Camshaft Seal	1992-1995			66918	1
---------------	-----------	--	--	-------	---

Honda

21 (cont.)	1493CC (1.5L) D15B7 SOHC 4 Cyl, 2.953in./75mm (1992-1995)				21 (cont.)
----------------------	--	--	--	--	----------------------

Part	Year	VIN	Model/Application	Part Number	Qty.
MISCELLANEOUS GASKETS (cont.)					
E.G.R. Gasket	1992-1995			G26315	1
Exhaust Pipe Gasket	1992-1995		(Ring Type 'A'), Pipe To Manifold	F14616	1
Therm. Housing Gasket	1992-1995			C31391	1
Therm. Mount Gasket	1992-1995		Victo-Tech	C31051	1
Throttle Body Gasket	1992-1995			G31389	1
Timing Cover Dust Seal Set	1992-1995			JV1184	1
Water Outlet Gasket	1992-1995			C31392	1
Water Pump Mount Gasket	1992-1995		Victo-Tech	K31057	1

22	1493CC (1.5L) D15B8 SOHC 4 Cyl, 2.953in./75mm (1992-1995)				22
-----------	--	--	--	--	-----------

Part	Year	VIN	Model/Application	Part Number	Qty.
ENGINE GASKETS					
Head Set	1992-1995		(Requires Lower Set To Make Full Set)	HS5731A	1
Lower Set	1992-1995		(Requires Head Set To Make Full Set), To Be Replaced By CS5731A	CS5731	1
			(Requires Head Set To Make Full Set)	CS5731A	1
Engine Kit Gasket Set	1992-1995			95-3496VR	1
Cylinder Head Gasket	1992-1995		Nitroseal	5731	1
			Multi-Layered Steel	54344	1
Cyl. Head Spacer Shim	1992-1995		Requires Sealing Compound Steel	5731S	1
Sealing Compound	1992-1995		(4 Ounce Brush Top Can)	JV66B	1
			(12 Ounce Spray Can)	JV66S	1
Valve Cover Set	1992-1995		(Contains Valve Cover Grommets, Contains Spark Plug Tube Seals) Victo-Tech	VS50073	1
Valve Stem Seal, Exh.	1992-1995			B45627	4
Valve Stem Seal, Int.	1992-1995			B45626	4
Manifold Set, Exhaust	1992-1995			MS15487	1
Manifold Set, Intake	1992-1995			MS15488	1
Oil Pan Set	1992-1995		Victo-Tech	OS38142	1
Rear Main Seal	1992-1995		Rubber	67121	1
Timing Cover Set	1992-1995		(Camshaft Seal Not Included)	JV1171	1

Part	Year	VIN	Model/Application	Part Number	Qty.
MISCELLANEOUS GASKETS					
Camshaft Seal	1992-1995			66918	1
E.G.R. Gasket	1992-1995			G26315	1
Exhaust Pipe Gasket	1993-1995		California, (Ring Type 'A'), Manifold To Converter	F7506	1
			Except California, (Flange Type), Manifold To Converter	F7431	1
Therm. Housing Gasket	1992-1995			C31391	1
Therm. Mount Gasket	1992-1995		Victo-Tech	C31051	1
Throttle Body Gasket	1992-1995			G31390	1
Timing Cover Dust Seal Set	1992-1995			JV1184	1
Water Outlet Gasket	1992-1995			C31392	1
Water Pump Mount Gasket	1992-1995		Victo-Tech	K31057	1

23	1493CC (1.5L) D15Z1 V-TEC SOHC 4 Cyl, 2.953in./75mm (1992-1995)				23
-----------	--	--	--	--	-----------

Part	Year	VIN	Model/Application	Part Number	Qty.
ENGINE GASKETS					
Head Set	1992-1995			HS5923W	1
Lower Set	1992-1995		(Requires Head Set To Make Full Set)	CS5923	1
Cylinder Head Gasket	1992-1995		Multi-Layered Steel	54234	1

23 1493CC (1.5L) D15Z1 V-TEC SOHC 4 Cyl, 2.953in./75mm (1992-1995)**23
(cont.)**

Part	Year	VIN	Model/Application	Part Number	Qty.
ENGINE GASKETS (cont.)					
Valve Cover Set	1992-1995		(Contains Valve Cover Grommets, Contains Spark Plug Tube Seals) <i>Victo-Tech</i>	VS50206	1
Valve Stem Seal, Exh.	1992-1995			B45627	8
Valve Stem Seal, Int.	1992-1995			B45626	8
Manifold Set, Exhaust	1992-1995			MS15487	1
Manifold Set, Intake	1992-1995			MS16144	1
Oil Pan Set	1992-1995		<i>Victo-Tech</i>	OS38142	1
Rear Main Seal	1992-1995		<i>Rubber</i>	67121	1
Timing Cover Set	1992-1995		(Camshaft Seal Not Included)	JV1171	1

MISCELLANEOUS GASKETS

Camshaft Seal	1992-1995			66918	1
E.G.R. Gasket	1992-1995			G26315	1
Exhaust Pipe Gasket	1992-1995		Manifold To Converter	F7431	1
			(Ring Type 'A'), Pipe To Manifold	F7481	1
Therm. Mount Gasket	1992-1995		<i>Victo-Tech</i>	C31051	1
Throttle Body Gasket	1992-1995			G31390	1
Timing Cover Dust Seal Set	1992-1995			JV1173	1
Water Outlet Gasket	1992-1995			C31392	1
Water Pump Mount Gasket	1992-1995		<i>Victo-Tech</i>	K31332	1

24 1590CC (1.6L) D16A6 SOHC 4 Cyl, 2.953in./75mm (1988-1991)**24**

Part	Year	VIN	Model/Application	Part Number	Qty.
ENGINE GASKETS					
Head Set	1988-1991		To Be Replaced By HS5731A	HS5731	1
			(Requires Lower Set To Make Full Set)	HS5731A	1
Lower Set	1988-1991		(Requires Head Set To Make Full Set)	CS5731A	1
Full Set	1988-1991		To Be Replaced By 95-3394VR	FS5731	1
Engine Kit Gasket Set	1988-1991		Civic Si/Ex, Crx Si	95-3394VR	1
				95-3496VR	1
Cylinder Head Gasket	1988-1991		<i>Nitroseal</i>	5731	1
			<i>Multi-Layered Steel</i>	54344	1
Cyl. Head Spacer Shim	1988-1991		Requires Sealing Compound <i>Steel</i>	5731S	1
Sealing Compound	1988-1991		(4 Ounce Brush Top Can)	JV66B	1
			(12 Ounce Spray Can)	JV66S	1
Valve Cover Set	1988-1991		(Contains Valve Cover Grommets, Contains Spark Plug Tube Seals) <i>Victo-Tech</i>	VS50073	1
Valve Stem Seal, Exh.	1988-1991			B45627	8
Valve Stem Seal, Int.	1988-1991			B45626	8
Manifold Set, Exhaust	1988-1991			MS15487	1
Manifold Set, Intake	1988-1991			MS16160	1
Oil Pan Set	1988-1991		<i>Victo-Tech</i>	OS38142	1
Rear Main Seal	1988-1991		<i>Rubber</i>	67121	1
Timing Cover Set	1988-1991		(Camshaft Seal Not Included)	JV1076	1

MISCELLANEOUS GASKETS

Camshaft Seal	1988-1991			66918	1
E.G.R. Gasket	1988-1991			G26315	1
Exhaust Pipe Gasket	1988-1991		(Ring Type 'A'), Pipe To Manifold	F14616	1
Throttle Body Gasket	1989-1991		Civic	G31053	1
	1988-1991			G31053	1
Water Outlet Gasket	1988-1991		<i>Victo-Tech</i>	C31058	1
Water Pump Gasket	1988		<i>Victo-Tech</i>	K31057	1
Water Pump Mount Gasket	1988-1991		<i>Victo-Tech</i>	K31057	1

Honda

25 1590CC (1.6L) D16B5 V-TEC SOHC 4 Cyl, 2.953in./75mm (1998-2000)

25

Part	Year	VIN	Model/Application	Part Number	Qty.
ENGINE GASKETS					
Head Set	1998-2000			HS54234	1
Lower Set	1998-2000			CS54234A	1
Cylinder Head Gasket	1998-2000		<i>Multi-Layered Steel</i>	54234	1
Valve Cover Set	1998-2000		(Contains Valve Cover Grommets, Contains Spark Plug Tube Seals) <i>Victo-Tech</i>	VS50300	1
Valve Stem Seal, Exh.	1998-2000			B45627	8
Valve Stem Seal, Int.	1998-2000			B45626	8
Manifold Set, Exhaust	1998-2000		<i>Steel</i>	MS15487	1
Manifold Set, Intake	1998-2000			MS16341	1
Oil Pan Set	1998-2000			OS32230	1
Rear Main Seal	1998-2000		<i>Rubber</i>	67121	1

MISCELLANEOUS GASKETS

Camshaft Seal	1998-2000			66918	1
				67604	1
E.G.R. Gasket	1998-2000			G30797	1
Exhaust Pipe Gasket	1998-2000		(Ring Type 'A'), Pipe To Manifold	F7481	1
			Catalytic Converter To Center Pipe	F12387	1
Therm. Mount Gasket	1998-2000		<i>Victo-Tech</i>	C31051	1
Throttle Body Gasket	1998-2000			G31614	1
Water Outlet Gasket	1998-2000			C31392	1
Water Pump Gasket	1998-2000		<i>Victo-Tech</i>	K31332	1

26 1590CC (1.6L) D16Y5 V-TEC-2 SOHC 4 Cyl, 2.953in./75mm (1996-2000)

26

Part	Year	VIN	Model/Application	Part Number	Qty.
ENGINE GASKETS					
Head Set	1996-2000			HS54234	
Lower Set	1996-2000			CS54234A	1
Cylinder Head Gasket	1996-2000		<i>Multi-Layered Steel</i>	54234	1
Valve Cover Set	1996-2000		(Contains Valve Cover Grommets, Contains Spark Plug Tube Seals) <i>Victo-Tech</i>	VS50300	1
Valve Stem Seal, Exh.	1996-2000			B45627	8
Valve Stem Seal, Int.	1996-2000			B45626	8
Manifold Set, Exhaust	1996-2000		<i>Steel</i>	MS15487	1
Manifold Set, Intake	1996-2000			MS16341	1
Oil Pan Set	1996-2000			OS32230	1
Rear Main Seal	1996-2000		<i>Rubber</i>	67121	1

MISCELLANEOUS GASKETS

Camshaft Seal	1996-2000			66918	1
				67604	1
E.G.R. Gasket	1996-2000			G30797	1
Exhaust Pipe Gasket	1996-2000		(Ring Type 'A'), Pipe To Manifold	F7467	1
			(Ring Type 'A'), Pipe To Manifold	F7481	1
Therm. Mount Gasket	1996-2000		<i>Victo-Tech</i>	C31051	1
Throttle Body Gasket	1996-2000			G31614	1
Water Outlet Gasket	1996-2000			C31392	1
Water Pump Gasket	1996-2000		<i>Victo-Tech</i>	K31332	1

27 1590CC (1.6L) D16Y7 SOHC 4 Cyl, 2.953in./75mm (1996-2000)

27

Part	Year	VIN	Model/Application	Part Number	Qty.
ENGINE GASKETS					
Head Set	1996-2000			HS54234	1
Lower Set	1996-2000		Requires Head Set To Make Full Set	CS54234	1
Cylinder Head Gasket	1996-2000		<i>Multi-Layered Steel</i>	54234	1
Valve Cover Set	1996-2000		(Contains Valve Cover Grommets, Contains Spark Plug Tube Seals) <i>Victo-Tech</i>	VS50300	1
Valve Stem Seal, Exh.	1996-2000			B45627	8

27 (cont.)	1590CC (1.6L) D16Y7 SOHC 4 Cyl, 2.953in./75mm (1996-2000)				27 (cont.)
----------------------	--	--	--	--	----------------------

Part	Year	VIN	Model/Application	Part Number	Qty.
------	------	-----	-------------------	-------------	------

ENGINE GASKETS (cont.)

Valve Stem Seal, Int.	1996-2000			B45626	8
Manifold Set, Exhaust	1996-2000			<i>Steel</i> MS15487	1
Manifold Set, Intake	1996-2000			MS16341	1
Oil Pan Set	1996-2000			OS32232	1
Rear Main Seal	1996-2000			<i>Rubber</i> 67121	1

MISCELLANEOUS GASKETS

Camshaft Seal	1996-2000			67604	1
	1996-1998			66918	1
E.G.R. Gasket	1996-2000			G30797	1
Exhaust Pipe Gasket	1996-2000		(Ring Type 'A'), Pipe To Manifold	F7481	1
	1996-1997		Intermediate Pipe To Muffler	F12330	1
Therm. Mount Gasket	1996-2000			<i>Victo-Tech</i> C31051	1
Water Outlet Gasket	1996-2000			C31392	1
Water Pump Gasket	1996-2000			<i>Victo-Tech</i> K31332	1

28	1590CC (1.6L) D16Y8 V-TEC SOHC 4 Cyl, 2.953in./75mm (1996-2000)				28
-----------	--	--	--	--	-----------

Part	Year	VIN	Model/Application	Part Number	Qty.
------	------	-----	-------------------	-------------	------

ENGINE GASKETS

Head Set	1996-2000			HS54234	1
Lower Set	1996-2000			CS54234A	1
Cylinder Head Gasket	1996-2000			<i>Multi-Layered Steel</i> 54234	1
Valve Cover Set	1996-2000		(Contains Valve Cover Grommets, Contains Spark Plug Tube Seals)	<i>Victo-Tech</i> VS50300	1
Valve Stem Seal, Exh.	1996-2000			B45627	8
Valve Stem Seal, Int.	1996-2000			B45626	8
Manifold Set, Exhaust	1996-2000			<i>Steel</i> MS15487	1
Manifold Set, Intake	1996-2000			MS16341	1
Oil Pan Set	1996-2000			OS32230	1
Rear Main Seal	1996-2000			<i>Rubber</i> 67121	1

MISCELLANEOUS GASKETS

Camshaft Seal	1996-2000			67604	1
	1996-1998			66918	1
E.G.R. Gasket	1996-2000			G30797	1
Exhaust Pipe Gasket	1996-2000		(Ring Type 'A'), Pipe To Manifold	F7467	2
			Catalytic Converter To Center Pipe	F12387	1
	1996-1997		Center Pipe To Muffler	F12330	1
Therm. Mount Gasket	1996-2000			<i>Victo-Tech</i> C31051	1
Throttle Body Gasket	1996-2000			G31614	1
Water Outlet Gasket	1996-2000			C31392	1
Water Pump Gasket	1996-2000			<i>Victo-Tech</i> K31332	1

29	1590CC (1.6L) D16Z6 V-TEC SOHC 4 Cyl, 2.953in./75mm (1992-1995)				29
-----------	--	--	--	--	-----------

Part	Year	VIN	Model/Application	Part Number	Qty.
------	------	-----	-------------------	-------------	------

ENGINE GASKETS

Head Set	1992-1995			HS5923W	1
Lower Set	1992-1995		(Requires Head Set To Make Full Set)	CS5923	1
Cylinder Head Gasket	1992-1995			<i>Multi-Layered Steel</i> 54234	1
Valve Cover Set	1992-1995		(Contains Valve Cover Grommets, Contains Spark Plug Tube Seals)	<i>Victo-Tech</i> VS50206	1
Valve Stem Seal, Exh.	1992-1995			B45627	8
Valve Stem Seal, Int.	1992-1995			B45626	8
Manifold Set, Exhaust	1992-1995			MS15487	1
Manifold Set, Intake	1992-1995			MS16160	1
Oil Pan Set	1992-1995			<i>Victo-Tech</i> OS38142	1
Rear Main Seal	1992-1995			<i>Rubber</i> 67121	1

Honda

29 (cont.)	1590CC (1.6L) D16Z6 V-TEC SOHC 4 Cyl, 2.953in./75mm (1992-1995)				29 (cont.)
----------------------	--	--	--	--	----------------------

Part	Year	VIN	Model/Application	Part Number	Qty.
------	------	-----	-------------------	-------------	------

ENGINE GASKETS (cont.)

Timing Cover Set	1992-1995		(Camshaft Seal Not Included)	JV1171	1
------------------	-----------	--	------------------------------	--------	---

MISCELLANEOUS GASKETS

Camshaft Seal	1992-1995			66918	1
E.G.R. Gasket	1992-1995			G30797	1
Exhaust Pipe Gasket	1992-1995		(Ring Type 'A'), Pipe To Manifold	F7467	2
Therm. Mount Gasket	1992-1995		<i>Victo-Tech</i>	C31051	1
Throttle Body Gasket	1992-1995			G31389	1
Timing Cover Dust Seal Set	1992-1995			JV1172	1
Water Outlet Gasket	1992-1995			C31392	1
Water Pump Mount Gasket	1992-1995		<i>Victo-Tech</i>	K31332	1

30	1595CC (1.6L) B16A2 V-TEC DOHC 4 Cyl, 3.189in./81mm (1996-2000)				30
-----------	--	--	--	--	-----------

Part	Year	VIN	Model/Application	Part Number	Qty.
------	------	-----	-------------------	-------------	------

ENGINE GASKETS

Head Set	1999-2000			HS54254	1
	1996-1997			HS54254	1
Lower Set	1999-2000			CS54254	1
	1996-1997			CS54254	1
Cylinder Head Gasket	1999-2000		<i>Multi-Layered Steel</i>	54254	1
	1996-1997		<i>Multi-Layered Steel</i>	54254	1
Valve Cover Set	1999-2000			VS50299	1
	1996-1997			VS50299	1
Valve Stem Seal, Exh.	1999-2000			B45627	8
	1996-1997			B45627	8
Valve Stem Seal, Int.	1999-2000			B45626	8
	1996-1997			B45626	8
Manifold Set, Exhaust	1999-2000		<i>Multi-Layered Steel</i>	MS15679	1
	1996-1997		<i>Multi-Layered Steel</i>	MS15679	1
Manifold Set, Intake	1999-2000			MS16231	1
	1996-1997			MS16231	1
Oil Pan Set	1999-2000			OS32101	1
	1996-1997			OS32101	1
Rear Main Seal	1999-2000		<i>Rubber</i>	67121	1
	1996-1997		<i>Rubber</i>	67121	1
Timing Cover Seal	1999-2000			67152	1
	1996-1997			67152	1

MISCELLANEOUS GASKETS

Camshaft Seal Set	1999-2000			67640	1
	1996-1997			67640	1
Exhaust Pipe Gasket	1999-2000		(Ring Type 'A'), Pipe To Manifold	F7413	2
			Catalytic Converter To Center Pipe	F12387	1
	1996-1997		(Ring Type 'A'), Pipe To Manifold	F7413	2
			Catalytic Converter To Center Pipe	F12387	1
Therm. Mount Gasket	1999-2000		<i>Victo-Tech</i>	C31051	1
	1996-1997		<i>Victo-Tech</i>	C31051	1
Throttle Body Gasket	1999-2000			G31636	1
	1996-1997			G31636	1
Water Pump Gasket	1999-2000			K31158	1
	1996-1997			K31158	1

31 1595CC (1.6L) B16A3 V-TEC DOHC 4 Cyl, 3.189in./81mm (1994-1995)**31**

Part	Year	VIN	Model/Application	Part Number	Qty.
ENGINE GASKETS					
Head Set	1994-1995			HS54254B	1
Lower Set	1994-1995			CS54254B	1
Cylinder Head Gasket	1994-1995		Multi-Layered Steel	54254	1
Valve Cover Set	1994-1995		Victo-Tech	VS50299	1
Valve Stem Seal, Exh.	1994-1995			B45627	8
Valve Stem Seal, Int.	1994-1995			B45626	8
Manifold Set, Exhaust	1994-1995		Multi-Layered Steel	MS15679	1
Manifold Set, Intake	1994-1995			MS16231	1
Oil Pan Set	1994-1995		Victo-Tech	OS32101	1
Rear Main Seal	1994-1995			67121	1
Timing Cover Seal	1994-1995			67152	1

MISCELLANEOUS GASKETS

Camshaft Seal Set	1994-1995			67640	1
Exhaust Pipe Gasket	1994-1995		(Ring Type 'A'), Pipe To Manifold	F7413	1
Therm. Mount Gasket	1994-1995		Victo-Tech	C31051	1
Throttle Body Gasket	1994-1995			G31186	1
Water Pump Gasket	1994-1995		Victo-Tech	GS33389	1

32 1599CC (1.6L) EF1 SOHC 4 Cyl, 2.913in./74mm (1976-1978)**32**

Part	Year	VIN	Model/Application	Part Number	Qty.
ENGINE GASKETS					
Head Set	1976-1978		Canadian Applications Require Exhaust Manifold Gasket	HS3642	1
Full Set	1976-1978		Canadian Applications Require Exhaust Manifold Gasket	FS3642	1
Engine Kit Gasket Set	1976-1978		(Intake Manifold Gasket Not Included), Use With Part Number MS15292	95-3088VR	1
Cylinder Head Gasket	1976-1978		To Be Replaced By 3714	Nitroseal 3642	1
				Nitroseal 3714	1
Cyl. Head Spacer Shim	1976-1978		Requires Sealing Compound	Steel 3714S	1
Sealing Compound	1976-1978		(4 Ounce Brush Top Can)	JV66B	1
			(12 Ounce Spray Can)	JV66S	1
Valve Cover Set	1976-1978		Victo-Tech	VS30039	1
Valve Stem Oil Seal, Aux.	1976-1978		(Auxiliary Seal)	B45440	4
Valve Stem Seal, Exh.	1976-1978			B45439	4
Valve Stem Seal, Int.	1976-1978			B45438	4
Manifold Set, Int. & Exh.	1976-1978		Except Canadian Models	MS15292	1
			Canadian	MS15537	1
Oil Pan Set	1976-1978		Victo-Tech	OS30287	1
Rear Main Seal	1976-1978		Rubber	47729	1
Timing Cover Set	1976-1978		(Contains Camshaft Seal, Contains Timing Cover Seal)	JV914	1
Timing Cover Seal	1976-1978			47728	1

MISCELLANEOUS GASKETS

Aux. Valve O-Ring	1976-1978			B45553	4
Aux. Valve Washer	1976-1978			B45494	8
Camshaft Seal	1976-1978			66580	1
Carb. Mount Gasket	1976-1978		2 Barrel Carburetor	G31151	2
E.G.R. Gasket	1976-1978			G26315	1
Exhaust Pipe Gasket	1976-1978		(Ring Type 'A'), Manifold To Exhaust Pipe	F14616	1
			(Ring Type 'A'), Intermediate Pipe To Muffler	F14617	1
			(Ring Type 'A'), Front Pipe To Intermediate Pipe	F14618	1
Therm. Housing Gasket	1976-1978			C30728	1
Valve Cover Washer Seal	1976-1978			B45487	2
Water Outlet Gasket	1976-1978		Victo-Tech	C20121	1

Honda

32	1599CC (1.6L) EF1 SOHC 4 Cyl, 2.913in./74mm (1976-1978)	32
(cont.)		(cont.)

Part	Year	VIN	Model/Application	Part Number	Qty.
------	------	-----	-------------------	-------------	------

MISCELLANEOUS GASKETS (cont.)

Water Pump Mount Gasket	1976-1978			<i>Victo-Tech</i> K27992	1
-------------------------	-----------	--	--	---------------------------------	---

33	1599CC (1.6L) EZ1 4 Cyl, 3.150in./80mm (1984-1985)	33
-----------	---	-----------

Part	Year	VIN	Model/Application	Part Number	Qty.
------	------	-----	-------------------	-------------	------

ENGINE GASKETS

Head Set	1984-1985		Canadian, (Requires Intake Manifold Gasket)	HS3783	1
Full Set	1984-1985		Canadian, (Requires Intake Manifold Gasket)	FS3783	1
Cylinder Head Gasket	1984-1985		Canadian <i>Nitroseal</i>	3783	1
Valve Cover Set	1984-1985		Canadian, (Contains Valve Cover Washers) <i>Victo-Tech</i>	VS50023	1
Valve Stem Seal, Exh.	1984-1985		Canadian	B45465	4
Valve Stem Seal, Int.	1984-1985		Canadian	B45459	8
Manifold Set, Exhaust	1984-1985		Canadian	MS14149	1
Manifold Set, Intake	1984-1985		Canadian	MS15372	1
Oil Pan Set	1984-1985		Canadian <i>Victo-Tech</i>	OS30599	1
Rear Main Seal	1984-1985		Canadian <i>Rubber</i>	67121	1
Timing Cover Set	1984-1985		Canadian	JV1002	1
Timing Cover Seal	1984-1985		Canadian	66908	1

MISCELLANEOUS GASKETS

Camshaft Seal	1984-1985		Canadian	66918	1
E.G.R. Gasket	1984-1985		Canadian	G26315	1
Valve Cover Washer Seal	1984-1985			B45487	2
Water Outlet Gasket	1984-1985		Canadian <i>Victo-Tech</i>	C24173	1
Water Pump Mount Gasket	1984-1985		Canadian <i>Victo-Tech</i>	K27648	1

34	1602CC (1.6L) EL 4 Cyl, 3.031in./77mm (1979-1985)	34
-----------	--	-----------

Part	Year	VIN	Model/Application	Part Number	Qty.
------	------	-----	-------------------	-------------	------

ENGINE GASKETS

Cylinder Head Gasket	1982-1985		Canadian <i>Nitroseal</i>	3737	1
	1979-1981		Canadian <i>Nitroseal</i>	3712	1
Valve Cover Set	1982-1985		Canadian, (Contains Valve Cover Washers) <i>Victo-Tech</i>	VS38332	1
	1979-1981		Canadian <i>Victo-Tech</i>	VS38324	1
Valve Stem Seal, Exh.	1984-1985		Canadian	B45465	4
Valve Stem Seal, Int.	1984-1985		Canadian	B45447	4
Manifold Set, Intake	1979-1981		Canadian	MS15245	1
Manifold Set, Int. & Exh.	1982-1985		Canadian	MS15964	1
	1979-1981		Canadian	MS15537	1
Oil Pan Set	1979-1985		Canadian <i>Victo-Tech</i>	OS30287	1
Rear Main Seal	1979-1981		Canadian, Thru Serial Number 1250229 <i>Rubber</i>	47618	1
Rear Main Seal Set	1979-1985		Canadian, From Serial Number 1250229	JV518	1
Timing Cover Set	1979-1985		Canadian	JV966	1
Timing Cover Seal	1983-1985		Canadian	66908	1
	1979-1982		Canadian	47728	1

MISCELLANEOUS GASKETS

Camshaft Seal	1979-1985		Canadian	66580	1
Carb. Mount Gasket	1982-1983		Canadian	G31152	2
E.G.R. Gasket	1979-1985		Canadian	G26315	1
Exhaust Pipe Gasket	1979-1985		Canadian, (Ring Type 'A'), Manifold To Exhaust Pipe	F14616	1
			Canadian, (Ring Type 'A'), Intermediate Pipe To Muffler	F14617	1
			Canadian, (Ring Type 'A'), Front Pipe To Intermediate Pipe	F14618	1
Therm. Housing Gasket	1979-1985		Canadian	C30728	1

34 (cont.)	1602CC (1.6L) EL 4 Cyl, 3.031in./77mm (1979-1985)					34 (cont.)
----------------------	--	--	--	--	--	----------------------

Part	Year	VIN	Model/Application	Part Number	Qty.
MISCELLANEOUS GASKETS (cont.)					
Valve Cover Washer Seal	1979-1985			B45487	2
Water Outlet Gasket	1979-1985		Canadian Victo-Tech	C20322	1
Water Pump Mount Gasket	1979-1985		Canadian Victo-Tech	K27992	1

35	1602CC (1.6L) EL1 (Canadien) 4 Cyl, 3.031in./77mm (1982-1983)					35
-----------	--	--	--	--	--	-----------

Part	Year	VIN	Model/Application	Part Number	Qty.
ENGINE GASKETS					
Engine Kit Gasket Set	1982-1983			95-3227VR	1

36	1751CC (1.8L) EK1 SOHC 4 Cyl, 3.031in./77mm (1979-1983)					36
-----------	--	--	--	--	--	-----------

Part	Year	VIN	Model/Application	Part Number	Qty.
ENGINE GASKETS					
Head Set	1982-1983			HS3737	1
	1981			HS3712	1
	1980		Except California And High Altitude Models After Engine Serial Number 2902224	HS3712	1
	1979-1980		California Models After Engine Serial Number 2302651 With Automatic Transaxle	HS3696	1
Full Set	1982-1983			FS3737	1
	1981			FS3712	1
	1980		Except California And High Altitude Models After Engine Serial Number 2902224	FS3712	1
	1979-1980		California Models After Engine Serial Number 2302651 With Automatic Transaxle	FS3696	1
Engine Kit Gasket Set	1982-1983			95-3227VR	1
Cylinder Head Gasket	1982-1983		Nitroseal	3737	1
	1979-1981		Nitroseal	3712	1
Valve Cover Set	1982-1983		(Contains Valve Cover Washers) Victo-Tech	VS38332	1
	1979-1981		Victo-Tech	VS38324	1
Valve Stem Oil Seal, Aux.	1979-1983		(Auxiliary Seal)	B45448	4
Valve Stem Seal, Exh.	1979-1983			B45465	4
Valve Stem Seal, Int.	1979-1983			B45447	4
Manifold Set, Int. & Exh.	1982-1983			MS15964	1
	1981			MS15530	1
	1980-1981		Automatic Transmission, California	MS15530	1
	1979-1980		Except California	MS15292	1
Oil Pan Set	1979-1983		Victo-Tech	OS30287	1
Rear Main Seal	1980		California Models After Engine Serial Number 2014303 With Manual Transaxle, Except California Models From Engine Serial Number 2559682 Rubber	47729	1
	1979		Rubber	47729	1
Rear Main Seal Set	1981-1983		California Models After Engine Serial Number 2302651 With Automatic Transaxle, High Altitude Models After Engine Serial Number 2902224	JV518	1
Timing Cover Set	1979-1983		(Contains Camshaft Seal, Contains Timing Cover Seal)	JV966	1
Timing Cover Seal	1983			66908	1
	1979-1982			47728	1

MISCELLANEOUS GASKETS

Aux. Valve O-Ring	1979-1983			B45554	4
Aux. Valve Washer	1979-1983			B45495	8
Camshaft Seal	1979-1983			66580	1
Carb. Mount Gasket	1979-1983		2 Barrel Carburetor	G31152	1
E.G.R. Gasket	1979-1983			G26315	1

Honda

36 (cont.)	1751CC (1.8L) EK1 SOHC 4 Cyl, 3.031in./77mm (1979-1983)				36 (cont.)
----------------------	--	--	--	--	----------------------

<i>Part</i>	<i>Year</i>	<i>VIN</i>	<i>Model/Application</i>	<i>Part Number</i>	<i>Qty.</i>
MISCELLANEOUS GASKETS (cont.)					
Exhaust Pipe Gasket	1980-1983		(Ring Type 'A'), Exhaust Pipe To Muffler	F7412	1
			(Ring Type 'A'), Intermediate Pipe To Muffler	F14592	1
Therm. Housing Gasket	1979-1983			C30728	1
Thermostat O-Ring	1979-1983		<i>Victo-Tech</i>	C24096	1
Valve Cover Washer Seal	1979-1981			B45487	2
Water Outlet Gasket	1979-1983		<i>Victo-Tech</i>	C20322	1
Water Pump Mount Gasket	1979-1983		<i>Victo-Tech</i>	K27992	1

37	1829CC (1.8L) A18A1/A18A2 4 Cyl, 3.150in./80mm (1987)				37
-----------	--	--	--	--	-----------

<i>Part</i>	<i>Year</i>	<i>VIN</i>	<i>Model/Application</i>	<i>Part Number</i>	<i>Qty.</i>
ENGINE GASKETS					
Head Set	1987			HS5733	1
Full Set	1987			FS5733	1
Cylinder Head Gasket	1987		<i>Nitroseal</i>	4898	1
Valve Cover Set	1987		(Contains Valve Cover Washers) <i>Victo-Tech</i>	VS50023	1
Manifold Set, Exhaust	1987			MS14149	1
Manifold Set, Intake	1987			MS12300	1
Oil Pan Set	1987		<i>Victo-Tech</i>	OS30599	1
Rear Main Seal	1987		<i>Rubber</i>	67121	1
Timing Cover Set	1987			JV1002	1
Timing Cover Seal	1987			66908	1

MISCELLANEOUS GASKETS					
Camshaft Seal	1987			66918	1
E.G.R. Gasket	1987			G26315	1
Exhaust Pipe Gasket	1987		(Ring Type 'A'), Manifold To Exhaust Pipe	F7412	1
			(Ring Type 'A'), Intermediate Pipe To Muffler	F14592	1
Therm. Housing Gasket	1987		<i>Victo-Tech</i>	C24216	1
Water Outlet Gasket	1987		<i>Victo-Tech</i>	C24173	1
Water Pump Mount Gasket	1987		<i>Victo-Tech</i>	K27648	1

38	1829CC (1.8L) ES1 SOHC 4 Cyl, 3.150in./80mm (1983)				38
-----------	---	--	--	--	-----------

<i>Part</i>	<i>Year</i>	<i>VIN</i>	<i>Model/Application</i>	<i>Part Number</i>	<i>Qty.</i>
ENGINE GASKETS					
Head Set	1983			HS3770	1
Full Set	1983			FS3770	1
Cylinder Head Gasket	1983		<i>Nitroseal</i>	3770	1
Valve Cover Set	1983		(Contains Valve Cover Washers) <i>Victo-Tech</i>	VS50023	1
Valve Stem Oil Seal, Aux.	1983		(Auxiliary Seal)	B45448	4
Valve Stem Seal, Exh.	1983			B45465	4
Valve Stem Seal, Int.	1983			B45459	8
Manifold Set, Exhaust	1983			MS14149	1
Manifold Set, Intake	1983			MS15359	1
Oil Pan Set	1983		<i>Victo-Tech</i>	OS30599	1
Rear Main Seal	1983		<i>Rubber</i>	67121	1
Timing Cover Set	1983			JV1002	1
Timing Cover Seal	1983			66908	1
MISCELLANEOUS GASKETS					
Aux. Valve Washer	1983			B45533	4
Camshaft Seal	1983			66918	1

38 (cont.)	1829CC (1.8L) ES1 SOHC 4 Cyl, 3.150in./80mm (1983)	38 (cont.)
----------------------	---	----------------------

Part	Year	VIN	Model/Application	Part Number	Qty.
MISCELLANEOUS GASKETS (cont.)					
E.G.R. Gasket	1983			G26315	1
Exhaust Pipe Gasket	1983		(Ring Type 'A'), Manifold To Exhaust Pipe	F7412	1
			(Ring Type 'A'), Intermediate Pipe To Muffler	F14592	1
Therm. Housing Gasket	1983			<i>Victo-Tech</i> C24216	1
Water Outlet Gasket	1983			<i>Victo-Tech</i> C24173	1
Water Pump Mount Gasket	1983			<i>Victo-Tech</i> K27648	1

39	1829CC (1.8L) ES2 Carbureted SOHC 4 Cyl, 3.150in./80mm (1984-1985)	39
-----------	---	-----------

Part	Year	VIN	Model/Application	Part Number	Qty.
ENGINE GASKETS					
Head Set	1984-1985			HS3770W	1
Full Set	1984-1985			FS3770W	1
Engine Kit Gasket Set	1984-1985			95-3395VR	1
Cylinder Head Gasket	1984-1985			<i>Nitroseal</i> 3770	1
Valve Cover Set	1984-1985		(Contains Valve Cover Washers)	<i>Victo-Tech</i> VS50023	1
Manifold Set, Exhaust	1984-1985			MS14149	1
Manifold Set, Intake	1984-1985			MS15372	1
Oil Pan Set	1984-1985			<i>Victo-Tech</i> OS30599	1
Rear Main Seal	1984-1985			<i>Rubber</i> 67121	1
Timing Cover Set	1984-1985			JV1002	1
Timing Cover Seal	1984-1985			66908	1

MISCELLANEOUS GASKETS

Aux. Valve Washer	1984-1985			B45533	4
Camshaft Seal	1984-1985			66918	1
E.G.R. Gasket	1984-1985			G26315	1
Exhaust Pipe Gasket	1984-1985		(Ring Type 'A'), Manifold To Exhaust Pipe	F7412	1
			(Ring Type 'A'), Intermediate Pipe To Muffler	F14592	1
Therm. Housing Gasket	1984-1985			<i>Victo-Tech</i> C24216	1
Water Outlet Gasket	1984-1985			<i>Victo-Tech</i> C24173	1
Water Pump Mount Gasket	1984-1985			<i>Victo-Tech</i> K27648	1

40	1829CC (1.8L) ES3 Fuel Inj. SOHC 4 Cyl, 3.150in./80mm (1985)	40
-----------	---	-----------

Part	Year	VIN	Model/Application	Part Number	Qty.
ENGINE GASKETS					
Head Set	1985			HS3790	1
Full Set	1985			FS3790	1
Cylinder Head Gasket	1985			<i>Nitroseal</i> 3783	1
Valve Cover Set	1985		(Contains Valve Cover Washers)	<i>Victo-Tech</i> VS50023	1
Manifold Set, Exhaust	1985			MS14149	1
Manifold Set, Intake	1985			MS15383	1
Oil Pan Set	1985			<i>Victo-Tech</i> OS30599	1
Rear Main Seal	1985			<i>Rubber</i> 67121	1
Timing Cover Set	1985			JV1002	1
Timing Cover Seal	1985			66908	1

MISCELLANEOUS GASKETS

Camshaft Seal	1985			66918	1
E.G.R. Gasket	1985			G26315	1
Exhaust Pipe Gasket	1985		(Ring Type 'A'), Manifold To Exhaust Pipe	F7412	1
			(Ring Type 'A'), Intermediate Pipe To Muffler	F14592	1
Therm. Housing Gasket	1985			<i>Victo-Tech</i> C24216	1

Honda

40 <small>(cont.)</small>	1829CC (1.8L) ES3 Fuel Inj. SOHC 4 Cyl, 3.150in./80mm (1985)	40 <small>(cont.)</small>
-------------------------------------	---	-------------------------------------

Part	Year	VIN	Model/Application	Part Number	Qty.
MISCELLANEOUS GASKETS (cont.)					
Water Outlet Gasket	1985		<i>Victo-Tech</i>	C24173	1
Water Pump Mount Gasket	1985		<i>Victo-Tech</i>	K27648	1

41	1829CC (1.8L) ET 4 Cyl, 3.150in./80mm (1983-1984)	41
-----------	--	-----------

Part	Year	VIN	Model/Application	Part Number	Qty.
ENGINE GASKETS					
Cylinder Head Gasket	1983-1984		Accord, Canadian <i>Nitroseal</i>	3783	1
Valve Cover Set	1983-1984		Accord, Canadian, (Contains Valve Cover Washers) <i>Victo-Tech</i>	VS50023	1
Valve Stem Seal, Exh.	1983-1984		Accord, Prelude, Canadian	B45465	4
Valve Stem Seal, Int.	1983-1984		Accord, Prelude, Canadian	B45459	4
Manifold Set, Exhaust	1983-1984		Accord, Canadian	MS14149	1
Manifold Set, Intake	1983-1984		Accord, Prelude, Canadian	MS12300	1
Oil Pan Set	1983-1984		Accord, Prelude, Canadian <i>Victo-Tech</i>	OS30287	1
Rear Main Seal	1983-1984		Accord, Canadian <i>Rubber</i>	67121	1
Timing Cover Set	1983-1984		Accord, Canadian	JV1002	1
Timing Cover Seal	1983-1984		Accord, Canadian	66908	1

MISCELLANEOUS GASKETS					
Camshaft Seal	1983-1984		Accord, Prelude	66918	1
E.G.R. Gasket	1983-1984		Accord, Canadian	G26315	1
Exhaust Pipe Gasket	1983-1984		Accord, Prelude, Canadian, (Ring Type 'A'), Manifold To Exhaust Pipe	F7413	2
			Accord, Prelude, Canadian, (Ring Type 'A'), Intermediate Pipe To Muffler	F14618	1
Therm. Housing Gasket	1983-1984		Accord, Canadian <i>Victo-Tech</i>	C24216	1
Water Outlet Gasket	1983-1984		Accord, Canadian <i>Victo-Tech</i>	C24173	1
Water Pump Mount Gasket	1983-1984		Accord, Prelude, Canadian <i>Victo-Tech</i>	K27992	1

42	1829CC (1.8L) ET1 4 Cyl, 3.150in./80mm (1984-1985)	42
-----------	---	-----------

Part	Year	VIN	Model/Application	Part Number	Qty.
ENGINE GASKETS					
Head Set	1984-1985		Canadian, (Intake Manifold Gasket Not Included)	HS3783	1
Full Set	1984-1985		Canadian, (Intake Manifold Gasket Not Included)	FS3783	1
Cylinder Head Gasket	1984-1985		Canadian <i>Nitroseal</i>	3783	1
Valve Cover Set	1984-1985		Canadian, (Contains Valve Cover Washers) <i>Victo-Tech</i>	VS50023	1
Manifold Set, Exhaust	1984-1985		Canadian	MS14149	1
Manifold Set, Intake	1984-1985		Canadian	MS15372	1
Oil Pan Set	1984-1985		Canadian <i>Victo-Tech</i>	OS30599	1
Rear Main Seal	1984-1985		Canadian <i>Rubber</i>	67121	1
Timing Cover Set	1984-1985		Canadian	JV1002	1
Timing Cover Seal	1984-1985		Canadian	66908	1

MISCELLANEOUS GASKETS					
Camshaft Seal	1984-1985			66918	1
E.G.R. Gasket	1984-1985		Canadian	G26315	1
Exhaust Pipe Gasket	1984		Canadian, (Ring Type 'A'), Manifold To Exhaust Pipe	F7413	2
			Canadian, (Ring Type 'A'), Intermediate Pipe To Muffler	F14618	1
Therm. Housing Gasket	1984-1985		Canadian <i>Victo-Tech</i>	C24216	1
Water Outlet Gasket	1984-1985		Canadian <i>Victo-Tech</i>	C24173	1
Water Pump Mount Gasket	1984-1985		Canadian <i>Victo-Tech</i>	K27648	1

43 1829CC (1.8L) ET2 SOHC 4 Cyl, 3.150in./80mm (1984-1986)**43**

<i>Part</i>	<i>Year</i>	<i>VIN</i>	<i>Model/Application</i>	<i>Part Number</i>	<i>Qty.</i>
ENGINE GASKETS					
Head Set	1986			HS5733	1
	1984-1985		(Intake Manifold Gasket Not Included)	HS3783	1
Full Set	1986			FS5733	1
	1984-1985		(Intake Manifold Gasket Not Included)	FS3783	1
Cylinder Head Gasket	1986			<i>Nitroseal</i> 4898	1
	1984-1985			<i>Nitroseal</i> 3783	1
Valve Cover Set	1984-1986		(Contains Valve Cover Washers)	<i>Victo-Tech</i> VS50023	1
Manifold Set, Exhaust	1984-1986			MS14149	1
Manifold Set, Intake	1984-1986			MS12300	1
Oil Pan Set	1984-1986			<i>Victo-Tech</i> OS30599	1
Rear Main Seal	1984-1986			<i>Rubber</i> 67121	1
Timing Cover Set	1984-1986			JV1002	1
Timing Cover Seal	1984-1986			66908	1

MISCELLANEOUS GASKETS

Aux. Valve Washer	1984-1985			B45533	4
Camshaft Seal	1984-1986			66918	1
E.G.R. Gasket	1984-1986			G26315	1
Therm. Housing Gasket	1984-1986			<i>Victo-Tech</i> C24216	1
Water Outlet Gasket	1984-1986			<i>Victo-Tech</i> C24173	1
Water Pump Mount Gasket	1984-1986			<i>Victo-Tech</i> K27648	1

44 1955CC (2.0L) BS1 4 Cyl, 3.256in./82.7mm (1986)**44**

<i>Part</i>	<i>Year</i>	<i>VIN</i>	<i>Model/Application</i>	<i>Part Number</i>	<i>Qty.</i>
ENGINE GASKETS					
Head Set	1986			HS5735	1
Full Set	1986			FS5735	1
Engine Kit Gasket Set	1986			95-3231VR	1
Cylinder Head Gasket	1986			<i>Nitroseal</i> 5735	1
Cyl. Head Spacer Shim	1986		Requires Sealing Compound	<i>Steel</i> 5735S	1
Sealing Compound	1986		(4 Ounce Brush Top Can)	JV66B	1
			(12 Ounce Spray Can)	JV66S	1
Valve Cover Set	1986		(Contains Valve Cover Washers)	<i>Victo-Tech</i> VS50023	1
Valve Stem Oil Seal, Aux.	1986		(Auxiliary Seal)	B45448	4
Valve Stem Seal, Exh.	1986			B45465	4
Valve Stem Seal, Int.	1986			B45499	8
Manifold Set, Exhaust	1986			MS14149	1
Manifold Set, Intake	1986		(Plenum Chamber Gasket Not Included)	MS15411	1
Plenum Chamber Gasket	1986			MS14632	1
Oil Pan Set	1986			<i>Victo-Tech</i> OS30599	1
Rear Main Seal	1986			<i>Rubber</i> 67121	1
Timing Cover Set	1986			JV1029	1
Timing Cover Seal	1986			66908	1

MISCELLANEOUS GASKETS

Camshaft Seal	1986			66918	1
E.G.R. Gasket	1986			G26315	1
Exhaust Pipe Gasket	1986		(Ring Type 'A'), Pipe To Manifold	F7412	1
Therm. Housing Gasket	1986		Water Outlet To Block	<i>Victo-Tech</i> C24216	1
Water Outlet Gasket	1986			<i>Victo-Tech</i> C24173	1
Water Pump Mount Gasket	1986			<i>Victo-Tech</i> K27648	1

Honda

45 1955CC (2.0L) A20A1/A20A3/BS/BT1 4 Cyl, 3.258in./82.75mm (1985-1989) 45

Part	Year	VIN	Model/Application	Part Number	Qty.
ENGINE GASKETS					
Head Set	1985-1989			HS5735	1
Full Set	1985-1989			FS5735	1
Engine Kit Gasket Set	1985-1989			95-3231VR	1
Cylinder Head Gasket	1985-1989		Nitroseal	5735	1
Cyl. Head Spacer Shim	1985-1989		Requires Sealing Compound Steel	5735S	1
Sealing Compound	1985-1989		(4 Ounce Brush Top Can) (12 Ounce Spray Can)	JV66B	1
				JV66S	1
Valve Cover Set	1985-1989		(Contains Valve Cover Washers) Victo-Tech	VS50023	1
Valve Stem Oil Seal, Aux.	1985-1989		(Auxiliary Seal)	B45448	4
Valve Stem Seal, Exh.	1985-1989			B45465	4
Valve Stem Seal, Int.	1985-1989			B45499	8
Manifold Set, Exhaust	1985-1989			MS14149	1
Manifold Set, Intake	1985-1989		(Plenum Chamber Gasket Not Included)	MS15411	1
Plenum Chamber Gasket	1986-1989			MS14632	1
Oil Pan Set	1985-1989		Victo-Tech	OS30599	1
Rear Main Seal	1985-1989		Rubber	67121	1
Timing Cover Set	1985-1989			JV1029	1
Timing Cover Seal	1985-1989			66908	1

MISCELLANEOUS GASKETS

Camshaft Seal	1985-1989			66918	1
Carb. Mount Gasket	1987-1989		2 Barrel Carburetor	G30693	1
E.G.R. Gasket	1985-1989			G26315	1
Exhaust Pipe Gasket	1985-1989		(Ring Type 'A'), Pipe To Manifold	F7412	1
Therm. Housing Gasket	1985-1989		Water Outlet To Block Victo-Tech	C24216	1
Throttle Body Gasket	1988-1989			G31059	1
Water Outlet Gasket	1985-1989		Victo-Tech	C24173	1
Water Pump Mount Gasket	1985-1989		Victo-Tech	K27648	1

46 1955CC (2.0L) BT2 SOHC 4 Cyl, 3.258in./82.75mm (1986) 46

Part	Year	VIN	Model/Application	Part Number	Qty.
ENGINE GASKETS					
Engine Kit Gasket Set	1986			95-3231VR	1

47 1958CC (2.0L) B20A3 SOHC Carbureted 4 Cyl, 3.189in./81mm (1988-1990) 47

Part	Year	VIN	Model/Application	Part Number	Qty.
ENGINE GASKETS					
Head Set	1988-1990		(Exhaust Pipe Gasket Not Included)	HS5823	1
Full Set	1988-1990		(Exhaust Pipe Gasket Not Included)	FS5823	1
Cylinder Head Gasket	1988-1990		Nitroseal	5823	1
Cyl. Head Spacer Shim	1988-1990		Requires Sealing Compound Steel	5823S	1
Sealing Compound	1988-1990		(4 Ounce Brush Top Can) (12 Ounce Spray Can)	JV66B	1
				JV66S	1
Valve Cover Set	1988-1990		(Contains Valve Cover Washers) Victo-Tech	VS50074	1
Valve Stem Seal, Exh.	1988-1990			B45465	4
Valve Stem Seal, Int.	1988-1990			B45499	8
Manifold Set, Exhaust	1988-1990			MS15489	1
Manifold Set, Intake	1988-1990			MS15490	1
Oil Pan Set	1988-1990		Victo-Tech	OS32056	1
Rear Main Seal	1988-1990		Rubber	67121	1
Timing Cover Set	1988-1990			JV1077	1

47	1958CC (2.0L) B20A3 SOHC Carbureted 4 Cyl, 3.189in./81mm (1988-1990)	47
(cont.)		(cont.)

Part	Year	VIN	Model/Application	Part Number	Qty.
MISCELLANEOUS GASKETS					
Camshaft Seal	1988-1990			66918	1
Camshaft Seal Set	1988-1990			JV1078	1
E.G.R. Gasket	1988-1990			G26315	1
Exhaust Pipe Gasket	1988-1990		(Ring Type 'A'), Catalytic Converter To Exhaust Pipe	F7412	2
			(Ring Type 'A'), Pipe To Manifold	F7467	2
			(Ring Type 'A'), Rear Exhaust Pipe To Muffler	F7468	1
Therm. Housing Gasket	1988-1990		<i>Victo-Tech</i>	C24216	1
Water Outlet Gasket	1988-1990		<i>Victo-Tech</i>	C24173	1
Water Pump Mount Gasket	1988-1990		<i>Victo-Tech</i>	K31060	1

48	1958CC (2.0L) B20A5 DOHC 4 Cyl, 3.189in./81mm (1988-1989)	48
-----------	--	-----------

Part	Year	VIN	Model/Application	Part Number	Qty.
ENGINE GASKETS					
Head Set	1988-1989		(Exhaust Pipe Gasket Not Included)	HS5823X	1
Full Set	1988-1989		(Exhaust Pipe Gasket Not Included)	FS5823X	1
Cylinder Head Gasket	1988-1989		<i>Nitroseal</i>	5823	1
Cyl. Head Spacer Shim	1988-1989		Requires Sealing Compound <i>Steel</i>	5823S	1
Sealing Compound	1988-1989		(4 Ounce Brush Top Can)	JV66B	1
			(12 Ounce Spray Can)	JV66S	1
Valve Cover Set	1988-1989		(Contains Valve Cover Washers, Contains Spark Plug Tube Seals) <i>Victo-Tech</i>	VS50075	1
Valve Stem Seal, Exh.	1988-1989			B45521	8
Valve Stem Seal, Int.	1988-1989			B45499	8
Manifold Set, Exhaust	1988-1989			MS15492	1
Manifold Set, Intake	1988-1989		(Contains Plenum Chamber Gasket)	MS15491	1
Oil Pan Set	1988-1989		<i>Victo-Tech</i>	OS32056	1
Rear Main Seal	1988-1989		<i>Rubber</i>	67121	1
Timing Cover Set	1988-1989			JV1079	1

MISCELLANEOUS GASKETS

Camshaft Seal	1988-1989			66580	2
Camshaft Seal Set	1988-1989			JV1080	1
E.G.R. Gasket	1988-1989			G26315	1
Exhaust Pipe Gasket	1988-1989		(Ring Type 'A'), Catalytic Converter To Exhaust Pipe	F7412	2
			(Ring Type 'A'), Pipe To Manifold	F7467	2
			(Ring Type 'A'), Rear Exhaust Pipe To Muffler	F7468	1
Therm. Housing Gasket	1988-1989		<i>Victo-Tech</i>	C31061	1
Throttle Body Gasket	1988-1989			G31059	1
Water Outlet Gasket	1988-1989		<i>Victo-Tech</i>	C24173	1
Water Pump Mount Gasket	1988-1989		<i>Victo-Tech</i>	K31060	1

49	2056CC (2.1L) B21A1 DOHC 4 Cyl, 3.268in./83mm (1990-1991)	49
-----------	--	-----------

Part	Year	VIN	Model/Application	Part Number	Qty.
ENGINE GASKETS					
Head Set	1990-1991			HS5881	1
Full Set	1990-1991			FS5881	1
Cylinder Head Gasket	1990-1991		<i>Nitroseal</i>	5881	1
Valve Cover Set	1990-1991		(Contains Spark Plug Tube Seals) <i>Victo-Tech</i>	VS50075	1
Valve Stem Seal, Exh.	1990-1991			B45678	8
Valve Stem Seal, Int.	1990-1991			B45634	8
Manifold Set, Exhaust	1990-1991			MS15492	1
Manifold Set, Intake	1990-1991		(Contains Plenum Chamber Gasket)	MS15665	1

Honda

49 (cont.)	2056CC (2.1L) B21A1 DOHC 4 Cyl, 3.268in./83mm (1990-1991)				49 (cont.)
----------------------	--	--	--	--	----------------------

Part	Year	VIN	Model/Application	Part Number	Qty.
------	------	-----	-------------------	-------------	------

ENGINE GASKETS (cont.)

Plenum Chamber Gasket	1990-1991			MS15666	1
Oil Pan Set	1990-1991		Victo-Tech	OS32056	1
Rear Main Seal	1990-1991		Rubber	67121	1
Timing Cover Set	1990-1991			JV1117	1

MISCELLANEOUS GASKETS

Camshaft Seal	1990-1991			66580	2
Camshaft Seal Set	1990-1991			JV1080	1
E.G.R. Gasket	1990-1991			G26315	1
Exhaust Pipe Gasket	1990-1991		(Ring Type 'A'), Pipe To Manifold	F14616	1
Therm. Housing Gasket	1990-1991		Victo-Tech	C31061	1
Water Outlet Gasket	1990-1991		Victo-Tech	C24173	1
Water Pump Mount Gasket	1990-1991		Victo-Tech	K31060	1

50	2156CC (2.2L) F22A1 SOHC 4 Cyl, 3.346in./85mm (1990-1996)				50
-----------	--	--	--	--	-----------

Part	Year	VIN	Model/Application	Part Number	Qty.
------	------	-----	-------------------	-------------	------

ENGINE GASKETS

Head Set	1990-1996			HS5824	1
Full Set	1990-1996			FS5824	1
Engine Kit Gasket Set	1990-1996			95-3487VR	1
Cylinder Head Gasket	1990-1996		Multi-Layered Steel	5824	1
Valve Cover Set	1990-1996		(Contains Valve Cover Washers, Contains Spark Plug Tube Seals) Victo-Tech	VS50072	1
Valve Stem Seal, Exh.	1990-1996			B45627	8
Valve Stem Seal, Int.	1990-1996			B45626	8
Manifold Set, Exhaust	1990-1996			MS15565	1
Manifold Set, Intake	1990-1996		(Contains Plenum Chamber Gasket)	MS15564	1
Oil Pan Set	1990-1996		Victo-Tech	OS32055	1
Rear Main Seal	1990-1996		Rubber	67121	1
Timing Cover Set	1990-1996			JV1075	1

MISCELLANEOUS GASKETS

Camshaft Seal	1990-1996			67032	1
E.G.R. Gasket	1990-1996			G26315	1
Exhaust Pipe Gasket	1991-1996		(Ring Type 'A'), Pipe To Manifold	F7482	1
Therm. Mount Gasket	1990-1996		Victo-Tech	C31051	1
Throttle Body Gasket	1990-1996			G31048	1
Water Outlet Gasket	1990-1996		Victo-Tech	C31052	1
Water Pump Mount Gasket	1990-1996		Victo-Tech	GS31184	1

51	2156CC (2.2L) F22A4 SOHC 4 Cyl, 3.346in./85mm (1990-1991)				51
-----------	--	--	--	--	-----------

Part	Year	VIN	Model/Application	Part Number	Qty.
------	------	-----	-------------------	-------------	------

ENGINE GASKETS

Cylinder Head Gasket	1990-1991		Multi-Layered Steel	5824	1
Valve Cover Set	1990-1991		(Contains Valve Cover Washers, Contains Spark Plug Tube Seals) Victo-Tech	VS50072	1
Valve Stem Seal, Exh.	1990-1991			B45627	8
Valve Stem Seal, Int.	1990-1991			B45626	8
Manifold Set, Exhaust	1990-1991			MS15565	1
Manifold Set, Intake	1990-1991		(Contains Plenum Chamber Gasket)	MS15564	1
Oil Pan Set	1990-1991		Victo-Tech	OS32055	1
Rear Main Seal	1990-1991		Rubber	67121	1

51	2156CC (2.2L) F22A4 SOHC 4 Cyl, 3.346in./85mm (1990-1991)	51
(cont.)		(cont.)

Part	Year	VIN	Model/Application	Part Number	Qty.
MISCELLANEOUS GASKETS					
Camshaft Seal	1990-1991			67032	1
Therm. Mount Gasket	1990-1991		Victo-Tech	C31051	1
Throttle Body Gasket	1991			G31048	1
Water Outlet Gasket	1990-1991		Victo-Tech	C31052	1

52	2156CC (2.2L) F22A6 SOHC 4 Cyl, 3.346in./85mm (1991-1993)	52
-----------	--	-----------

Part	Year	VIN	Model/Application	Part Number	Qty.
ENGINE GASKETS					
Head Set	1991-1993			HS5824W	1
Lower Set	1991-1993		(Requires Head Set To Make Full Set)	CS5824	1
Cylinder Head Gasket	1991-1993		Multi-Layered Steel	5824	1
Valve Cover Set	1991-1993		(Contains Valve Cover Washers, Contains Spark Plug Tube Seals) Victo-Tech	VS50072	1
Valve Stem Seal, Exh.	1991-1993			B45627	8
Valve Stem Seal, Int.	1991-1993			B45626	8
Manifold Set, Exhaust	1991-1993			MS15565	1
Manifold Set, Intake	1991-1993		(Contains Plenum Chamber Gasket)	MS15564W	1
Plenum Chamber Gasket	1991-1993			MS14159	
Oil Pan Set	1991-1993		Victo-Tech	OS32055	1
Rear Main Seal	1991-1993		Rubber	67121	1
Timing Cover Set	1991-1993			JV1075	1

MISCELLANEOUS GASKETS

Camshaft Seal	1991-1993			67032	1
E.G.R. Gasket	1991-1993			G26315	1
Exhaust Pipe Gasket	1992-1993		Middle Pipe To Rear Pipe	F10108	1
	1991-1993		(Ring Type 'A'), Pipe To Manifold	F7467	2
Therm. Mount Gasket	1991-1993		Victo-Tech	C31051	1
Water Outlet Gasket	1991-1993		Victo-Tech	C31052	1
Water Pump Mount Gasket	1991-1993		Victo-Tech	GS31184	1

53	2156CC (2.2L) F22B1 V-TEC SOHC 4 Cyl, 3.346in./85mm (1994-1997)	53
-----------	--	-----------

Part	Year	VIN	Model/Application	Part Number	Qty.
ENGINE GASKETS					
Head Set	1994-1997		(Requires Lower Set To Make Full Set)	HS4051W	1
Lower Set	1994-1997		(Requires Head Set To Make Full Set)	CS4051	1
Cylinder Head Gasket	1994-1997		Multi-Layered Steel	4051	1
Valve Cover Set	1994-1997		(Contains Valve Cover Grommets, Contains Spark Plug Tube Seals) Victo-Tech	VS50222	1
Valve Stem Seal, Exh.	1994-1997			B45627	8
Valve Stem Seal, Int.	1994-1997			B45626	8
Manifold Set, Exhaust	1994-1997			MS16163	1
Manifold Set, Intake	1994-1997		(Contains Plenum Chamber Gasket)	MS16161	1
Plenum Chamber Gasket	1994-1997			MS16162	1
Oil Pan Set	1994-1997		Victo-Tech	OS32055	1
Rear Main Seal	1994-1997		Rubber	67121	1
Timing Cover Set	1994-1997		(Requires Oil Pan Set)	JV1187	1
Timing Cover Seal	1994-1997			67591	1

MISCELLANEOUS GASKETS

Camshaft Seal	1994-1997			67032	1
E.G.R. Gasket	1994-1997			G26315	1
Exhaust Pipe Gasket	1994-1997		(Ring Type 'A'), Pipe To Manifold	F7467	2
			Catalytic Converter To Center Pipe	F12387	1

Honda

53 (cont.)	2156CC (2.2L) F22B1 V-TEC SOHC 4 Cyl, 3.346in./85mm (1994-1997)				53 (cont.)
----------------------	--	--	--	--	----------------------

Part	Year	VIN	Model/Application	Part Number	Qty.
MISCELLANEOUS GASKETS (cont.)					
Therm. Mount Gasket	1994-1997		<i>Victo-Tech</i>	C31051	1
Throttle Body Gasket	1994-1997			G31417	1
Timing Cover Dust Seal Set	1994-1997			JV1192	1
Water Outlet Gasket	1994-1997		<i>Victo-Tech</i>	C31052	1
Water Pump Mount Gasket	1994-1997		<i>Victo-Tech</i>	GS31184	1

54	2156CC (2.2L) F22B2 SOHC 4 Cyl, 3.346in./85mm (1994-1997)				54
-----------	--	--	--	--	-----------

Part	Year	VIN	Model/Application	Part Number	Qty.
ENGINE GASKETS					
Head Set	1994-1997			HS4051	1
Lower Set	1994-1997		(Requires Head Set To Make Full Set)	CS4051	1
Cylinder Head Gasket	1994-1997		<i>Multi-Layered Steel</i>	4051	1
Valve Cover Set	1994-1997		(Contains Valve Cover Grommets, Contains Spark Plug Tube Seals) <i>Victo-Tech</i>	VS50072	1
Valve Stem Seal, Exh.	1994-1997			B45627	8
Valve Stem Seal, Int.	1994-1997			B45626	8
Manifold Set, Exhaust	1994-1997			MS16163	1
Manifold Set, Intake	1994-1997		(Contains Plenum Chamber Gasket)	MS16164	1
Plenum Chamber Gasket	1994-1997			MS16162	1
Oil Pan Set	1994-1997		<i>Victo-Tech</i>	OS32055	1
Rear Main Seal	1994-1997		<i>Rubber</i>	67121	1
Timing Cover Set	1994-1997		(Requires Oil Pan Set)	JV1187	1
Timing Cover Seal	1994-1997			67591	1

Part	Year	VIN	Model/Application	Part Number	Qty.
MISCELLANEOUS GASKETS					
Camshaft Seal	1994-1997			67032	1
E.G.R. Gasket	1994-1997			G26315	1
Exhaust Pipe Gasket	1997		(Ring Type 'A'), Pipe To Manifold	F7482	1
			Center Pipe To Muffler	F10108	1
			Catalytic Converter To Center Pipe, Catalytic Converter To Front Exhaust Pipe, Front Pipe To Front Intermediate Pipe	F12387	3
			Pipe To Manifold	F14616	1
	1996-1997		KL Models, Catalytic Converter To Center Pipe	F12387	1
	1995-1997		Anti-Lock Brakes, KL Models, (Ring Type 'A'), Pipe To Manifold	F7482	1
			KA models, (Ring Type 'A'), Pipe To Manifold	F7482	1
			KL Models, Pipe To Manifold	F7482	1
			Except Anti-Lock Brakes, KL Models, Center Pipe To Muffler	F10108	1
			Anti-Lock Brakes, KL Models, Catalytic Converter To Center Pipe	F12387	1
			Except Anti-Lock Brakes, KL Models, Catalytic Converter To Center Pipe, Catalytic Converter To Front Exhaust Pipe, Front Pipe To Front Intermediate Pipe	F12387	3
			KA models, Catalytic Converter To Center Pipe	F12387	1
			Except Anti-Lock Brakes, KL Models, Pipe To Manifold	F14616	1
	1994		(Ring Type 'A'), Pipe To Manifold	F7482	1
		Catalytic Converter To Center Pipe	F12387	1	
Therm. Mount Gasket	1994-1997		<i>Victo-Tech</i>	C31051	1
Throttle Body Gasket	1994-1997			G31417	1
Timing Cover Dust Seal Set	1994-1997			JV1192	1
Water Outlet Gasket	1994-1997		<i>Victo-Tech</i>	C31052	1
Water Pump Mount Gasket	1994-1997		<i>Victo-Tech</i>	GS31184	1

55 2157CC (2.2L) H22A1 V-TEC DOHC 4 Cyl, 3.425in./87mm (1993-1996)**55**

<i>Part</i>	<i>Year</i>	<i>VIN</i>	<i>Model/Application</i>	<i>Part Number</i>	<i>Qty.</i>
ENGINE GASKETS					
Head Set	1993-1996			HS54362	1
Lower Set	1993-1996		(Requires Head Set To Make Full Set)	CS54362	1
Cylinder Head Gasket	1993-1996		<i>Multi-Layered Steel</i>	54362	1
Valve Cover Set	1993-1996		(Contains Valve Cover Grommets, Contains Spark Plug Tube Seals)	VS17952	1
Valve Stem Seal, Exh.	1993-1996			B45627	8
Valve Stem Seal, Int.	1993-1996			B45626	8
Manifold Set, Exhaust	1993-1996		<i>Multi-Layered Steel</i>	MS17954	1
Manifold Set, Intake	1993-1996		(Plenum Chamber Gasket Not Included)	MS17953	1
Plenum Chamber Gasket	1993-1996			MS14159	1
Oil Pan Set	1993-1996		<i>Victo-Tech</i>	OS32055	1
Rear Main Seal	1993-1996		<i>Rubber</i>	67121	1
Timing Cover Seal	1993-1996			67591	1

MISCELLANEOUS GASKETS

E.G.R. Gasket	1993-1996			G26315	1
Exhaust Pipe Gasket	1993-1996		(Ring Type 'A'), Pipe To Manifold	F7467	2
			Center Pipe To Muffler	F10108	1
			Catalytic Converter To Front Exhaust Pipe	F14616	1
Therm. Mount Gasket	1993-1996		<i>Victo-Tech</i>	C17951	1
Throttle Body Gasket	1993			G31186	1
Water Outlet Gasket	1993-1996		<i>Victo-Tech</i>	C31052	1
Water Pump Mount Gasket	1993-1996		<i>Victo-Tech</i>	K31185	1

56 2157CC (2.2L) H22A4 V-TEC DOHC 4 Cyl, 3.425in./87mm (1997-2001)**56**

<i>Part</i>	<i>Year</i>	<i>VIN</i>	<i>Model/Application</i>	<i>Part Number</i>	<i>Qty.</i>
ENGINE GASKETS					
Head Set	1997-2001			HS54241	1
Lower Set	1997-2001		(Requires Head Set To Make Full Set)	CS54241	1
Cylinder Head Gasket	1997-2001		<i>Multi-Layered Steel</i>	54241	1
Valve Cover Set	1997-2001		(Contains Valve Cover Grommets, Contains Spark Plug Tube Seals)	VS17952	1
Valve Stem Seal, Exh.	1997-2001			B45627	8
Valve Stem Seal, Int.	1997-2001			B45626	8
Manifold Set, Exhaust	1997-2001		<i>Beaded Steel</i>	MS17954	1
Manifold Set, Intake	1997-2001		(Plenum Chamber Gasket Not Included)	MS17953	1
Plenum Chamber Gasket	1997-2001			MS14159	2
Oil Pan Set	1997-2001			OS17943	1
Rear Main Seal	1997-2001			67121	1
Timing Cover Seal	1997-2001			67591	1

MISCELLANEOUS GASKETS

Camshaft Seal Set	1997-2001			67640	1
E.G.R. Gasket	1997-2001			G30797	1
Exhaust Pipe Gasket	1997-2001		(Ring Type 'A'), Pipe To Manifold	F7467	2
			Center Pipe To Muffler	F10108	1
			Catalytic Converter To Center Pipe	F12387	1
Therm. Mount Gasket	1997-2001		<i>Victo-Tech</i>	C17951	1
Throttle Body Gasket	1997-2001		<i>Victo-Foam</i>	G31186	1
Water Outlet Gasket	1997-2001		<i>Victo-Tech</i>	C31052	1
Water Pump Gasket	1997-2001		<i>Victo-Tech</i>	K31185	1

Honda

57 2254CC (2.3L) F23A1 V-TEC SOHC 4 Cyl, 3.386in./86mm (1998-2001)

57

Part	Year	VIN	Model/Application	Part Number	Qty.
ENGINE GASKETS					
Head Set	1998-2001			HS54216	1
Lower Set	1998-2001		(Requires Head Set To Make Full Set)	CS54216	1
Cylinder Head Gasket	1998-2001		<i>Multi-Layered Steel</i>	54216	1
Valve Cover Set	1998-2001		(Contains Valve Cover Grommets, Contains Spark Plug Tube Seals) <i>Victo-Tech</i>	VS50222	1
Valve Stem Seal, Exh.	1998-2001			B45627	8
Valve Stem Seal, Int.	1998-2001			B45626	8
Manifold Set, Exhaust	1998-2001		<i>Beaded Steel</i>	MS17846	1
Manifold Set, Intake	1998-2001		(Contains Plenum Chamber Gasket) <i>Beaded Steel</i>	MS16319	1
Plenum Chamber Gasket	1998-2001		<i>Beaded Steel</i>	MS17800	1
Oil Pan Set	1998-2001		Original Equipment Uses RTV <i>Silicone</i>	JV6	1
Rear Main Seal	1998-2001			67121	1
Timing Cover Seal	1998-2001			67030	1

MISCELLANEOUS GASKETS

Aux. Shaft Seal	1998-2001			67031	1
Camshaft Seal	1998-2001			67032	1
E.G.R. Gasket	1998-2001			G30797	1
Exhaust Pipe Gasket	1998-2001		(Ring Type 'A'), Exhaust Manifold To Converter	F7482	1
			Exhaust Pipe To Muffler	F10108	1
			Converter To Exhaust Pipe	F12387	1
Therm. Mount Gasket	1998-2001		<i>Victo-Tech</i>	C31051	1
Throttle Body Gasket	1998-2001			G17801	1
Water Outlet Gasket	1998-2001		<i>Victo-Tech</i>	C31052	1
Water Pump Mount Gasket	1998-2001		<i>Victo-Tech</i>	GS31184	1

58 2254CC (2.3L) F23A4 V-TEC SOHC 4 Cyl, 3.386in./86mm (1998-2002)

58

Part	Year	VIN	Model/Application	Part Number	Qty.
ENGINE GASKETS					
Head Set	1998-2002			HS54216	1
Lower Set	1998-2002		(Requires Head Set To Make Full Set)	CS54216	1
Cylinder Head Gasket	1998-2002		<i>Multi-Layered Steel</i>	54216	1
Valve Cover Set	1998-2002		(Contains Valve Cover Grommets, Contains Spark Plug Tube Seals) <i>Victo-Tech</i>	VS50222	1
Valve Stem Seal, Exh.	1998-2002			B45627	8
Valve Stem Seal, Int.	1998-2002			B45626	8
Manifold Set, Exhaust	1998-2002		<i>Beaded Steel</i>	MS17846	1
Manifold Set, Intake	1998-2002		(Contains Plenum Chamber Gasket) <i>Beaded Steel</i>	MS16319	1
Plenum Chamber Gasket	1998-2002		<i>Beaded Steel</i>	MS17800	1
Oil Pan Set	1998-2002		Original Equipment Uses RTV <i>Silicone</i>	JV6	1
Rear Main Seal	1998-2002			67121	1
Timing Cover Seal	1998-2002			67030	1

MISCELLANEOUS GASKETS

Aux. Shaft Seal	1998-2002			67031	1
Camshaft Seal	1998-2002			67032	1
E.G.R. Gasket	1998-2002			G30797	1
Exhaust Pipe Gasket	1998-2002		(Ring Type 'A'), Exhaust Manifold To Converter	F7482	1
			Exhaust Pipe To Muffler	F10108	1
			Converter To Exhaust Pipe	F12387	1
Therm. Mount Gasket	1998-2002		<i>Victo-Tech</i>	C31051	1
Throttle Body Gasket	1998-2002			G17801	1
Water Outlet Gasket	1998-2002		<i>Victo-Tech</i>	C31052	1
Water Pump Mount Gasket	1998-2002		<i>Victo-Tech</i>	GS31184	1

59 2254CC (2.3L) F23A5 SOHC 4 Cyl, 3.386in./86mm (1998-2002)**59**

<i>Part</i>	<i>Year</i>	<i>VIN</i>	<i>Model/Application</i>	<i>Part Number</i>	<i>Qty.</i>
ENGINE GASKETS					
Head Set	1998-2002			HS54216	1
Lower Set	1998-2002		(Requires Head Set To Make Full Set)	CS54216	1
Cylinder Head Gasket	1998-2002		<i>Multi-Layered Steel</i>	54216	1
Valve Cover Set	1998-2002		(Contains Valve Cover Grommets, Contains Spark Plug Tube Seals) <i>Victo-Tech</i>	VS50222	1
Valve Stem Seal, Exh.	1998-2002			B45627	8
Valve Stem Seal, Int.	1998-2002			B45626	8
Manifold Set, Exhaust	1998-2002		<i>Beaded Steel</i>	MS17846	1
Manifold Set, Intake	1998-2002		(Contains Plenum Chamber Gasket) <i>Beaded Steel</i>	MS16319	1
Plenum Chamber Gasket	1998-2002		<i>Beaded Steel</i>	MS17800	1
Oil Pan Set	1998-2002		Original Equipment Uses RTV <i>Silicone</i>	JV6	1
Rear Main Seal	1998-2002			67121	1
Timing Cover Seal	1998-2002			67030	1

MISCELLANEOUS GASKETS

Aux. Shaft Seal	1998-2002			67031	1
Camshaft Seal	1998-2002			67032	1
E.G.R. Gasket	1998-2002			G30797	1
Exhaust Pipe Gasket	1998-2002		(Ring Type 'A'), Exhaust Manifold To Converter	F7482	1
			Exhaust Pipe To Muffler	F10108	1
			Converter To Exhaust Pipe	F12387	1
Therm. Mount Gasket	1998-2002		<i>Victo-Tech</i>	C31051	1
Throttle Body Gasket	1998-2002			G17801	1
Water Outlet Gasket	1998-2002		<i>Victo-Tech</i>	C31052	1
Water Pump Mount Gasket	1998-2002		<i>Victo-Tech</i>	GS31184	1

60 2259CC (2.3L) H23A1 DOHC 4 Cyl, 3.425in./87mm (1992-1996)**60**

<i>Part</i>	<i>Year</i>	<i>VIN</i>	<i>Model/Application</i>	<i>Part Number</i>	<i>Qty.</i>
ENGINE GASKETS					
Head Set	1992-1996		(Requires Lower Set To Make Full Set)	HS5897	1
Lower Set	1992-1996		(Requires Head Set To Make Full Set)	CS5897	1
Cylinder Head Gasket	1992-1996		<i>Multi-Layered Steel</i>	5897	1
Valve Cover Set	1992-1996		(Contains Valve Cover Grommets, Contains Spark Plug Tube Seals) <i>Victo-Tech</i>	VS50146	1
Valve Stem Seal, Exh.	1992-1996			B45678	8
Valve Stem Seal, Int.	1992-1996			B45634	8
Manifold Set, Exhaust	1992-1996			MS15565	1
Manifold Set, Intake	1992-1996		(Contains Plenum Chamber Gasket)	MS15564W	1
Plenum Chamber Gasket	1992-1996			MS14159	1
Oil Pan Set	1992-1996		<i>Victo-Tech</i>	OS32055	1
Rear Main Seal	1992-1996		<i>Rubber</i>	67121	1
Timing Cover Set	1992-1996			JV1126	1

MISCELLANEOUS GASKETS

Camshaft Seal	1992-1996			67032	2
E.G.R. Gasket	1992-1996			G26315	1
Exhaust Pipe Gasket	1992-1996		(Ring Type 'A'), Pipe To Manifold	F7467	2
			Exhaust Pipe To Muffler	F10108	1
			(Ring Type 'A'), Catalytic Converter To Exhaust Pipe	F12387	2
Therm. Mount Gasket	1992-1996		<i>Victo-Tech</i>	C31051	1
Throttle Body Gasket	1992-1996			G31186	1
Water Outlet Gasket	1992-1996		<i>Victo-Tech</i>	C31052	1
Water Pump Mount Gasket	1992-1996		<i>Victo-Tech</i>	K31185	1

Honda

61 2675CC (2.7L) C27A4 SOHC V6 Cyl, 3.425in./87mm (1995-1997) 61

Part	Year	VIN	Model/Application	Part Number	Qty.
ENGINE GASKETS					
Cylinder Head Gasket	1995-1997		<i>Nitroseal</i>	5773	2
Valve Cover Set	1995-1997		(Valve Cover End Plugs Not Included) <i>Victo-Tech</i>	VS50276	1
Valve Stem Seal, Exh.	1995-1997			B45678	12
Valve Stem Seal, Int.	1995-1997			B45634	12
Rear Main Seal	1995-1997		<i>Rubber</i>	66986	1
Timing Cover Seal	1995-1997			66984	1

MISCELLANEOUS GASKETS					
Camshaft Seal	1995-1997			66985	2
E.G.R. Gasket	1995-1997		Valve	G26315	1
Exhaust Pipe Gasket	1995-1997		(Ring Type 'A'), Pipe To Manifold	F7413	2
			(Ring Type 'A'), Catalytic Converter To Exhaust Pipe	F12387	2
Push Rod Cover Set	1995-1997			PS39131	1
Valve Cover End Plug	1995-1997		Rear Head	B45620	1

62 2997CC (3.0L) J30A1 V-TEC SOHC V6 Cyl, 3.386in./86mm (1998-2002) 62

Part	Year	VIN	Model/Application	Part Number	Qty.	
ENGINE GASKETS						
Head Set	1998-2002			HS54217	1	
Lower Set	1998-2002		Requires Head Set To Make Full Set	CS54217	1	
Cylinder Head Gasket	1998-2002		<i>Multi-Layered Steel</i>	54217	2	
Valve Cover Set	1998-2002		<i>Victo-Tech</i>	VS17822	1	
Valve Stem Seal, Exh.	1998-2002			B45627	12	
Valve Stem Seal, Int.	1998-2002			B45626	12	
Manifold Set, Exhaust	1998-2002		<i>Steel</i>	MS17814	1	
Manifold Set, Intake	1998-2002		<i>Multi-Layered Steel</i>	MS17808	1	
Plenum Chamber Gasket	1998-2002		Boost Chamber Vacuum Plate To Plenum	B17806	1	
			Plenum To Manifold	<i>Multi-Layered Steel</i>	MS17810	1
			Boost Chamber To Plenum	<i>Multi-Layered Steel</i>	MS17811	1
Oil Pan Set	1998-2002			JV6	1	
Rear Main Seal	1998-2002			66986	1	
Timing Cover Seal	1998-2002			66984	1	

MISCELLANEOUS GASKETS					
Camshaft Seal	1998-2002			67617	2
E.G.R. Gasket	1998-2002			G30797	1
Exhaust Pipe Gasket	1998-2002		(Ring Type 'A'), Pipe To Manifold	F7413	2
Throttle Body Gasket	1998-2002			G17807	1
Water By-Pass Gasket	1998-2002			C17813	1
Water Outlet Gasket	1998-2002			C31207	1
Water Pump Gasket	1998-2002			K17818	1

63 2997CC (3.0L) J30A4 V-TEC SOHC V6 Cyl, 3.386in./86mm (2003) 63

Part	Year	VIN	Model/Application	Part Number	Qty.
ENGINE GASKETS					
Valve Stem Seal, Exh.	2003			B45627	12
Valve Stem Seal, Int.	2003			B45826	12
MISCELLANEOUS GASKETS					
E.G.R. Gasket	2003			G30797	1
Exhaust Pipe Gasket	2003		(Ring Type 'A'), Pipe To Manifold	F7413	2
Water Outlet Gasket	2003			C31207	1

Engine Index

Engine	Year	Block
196 CID (3.2L) L-Head American Motors Co.	1955	1
196 CID (3.2L) OHV American Motors Co.	1956	2

Engine	Year	Block
327 CID (5.4L)	1957	3

Model Index

Model	Engine	Year	Block
	327 CID (5.4L)	1957	3
Rambler	196 CID (3.2L) OHV American Motors Co.	1956	2

Model	Engine	Year	Block
Rambler	196 CID (3.2L) L-Head American Motors Co.	1955	1

1 196 CID (3.2L) L-Head American Motors Co. 6 Cyl, 3.125in./79.4mm (1955) 1

Part	Year	VIN	Model/Application	Part Number	Qty.
------	------	-----	-------------------	-------------	------

ENGINE GASKETS

Head Set	1955			HS1151	1
Cylinder Head Gasket	1955		VR2000	1151	1

MISCELLANEOUS GASKETS

Fuel Pump Gasket	1955			D27094	1
Push Rod Cover Set	1955		Cork Rubber	VS38009	1
Water Outlet Gasket	1955			C25487	1

2 196 CID (3.2L) OHV American Motors Co. 6 Cyl, 3.125in./79.4mm (1956) 2

Part	Year	VIN	Model/Application	Part Number	Qty.
------	------	-----	-------------------	-------------	------

ENGINE GASKETS

Valve Cover Set	1956		Victo-Tech	VS29477	1
-----------------	------	--	------------	---------	---

MISCELLANEOUS GASKETS

Exhaust Pipe Gasket	1956		(Ring Type 'D'), Pipe To Manifold	F7171	1
Fuel Pump Gasket	1956			D27094	1
Push Rod Cover Set	1956		Cork Rubber	VS38009	1
Water Outlet Gasket	1956			C25487	1

3 327 CID (5.4L) V8 Cyl, 4.000in./101.6mm (1957) 3

Part	Year	VIN	Model/Application	Part Number	Qty.
------	------	-----	-------------------	-------------	------

ENGINE GASKETS

Head Set	1957			HS1137VX	1
Full Set	1957			FS1137BX	1
Cylinder Head Gasket	1957		VR2000	1137VC	2
Valve Cover Set	1957		Victo-Tech	VS27546	1
Manifold Set, Intake	1957			MS15054	1
Oil Pan Set	1957		Cork Rubber	OS30569	1
Rear Main Seal Set	1957			JV696	1
Timing Cover Set	1957			JV796	1

MISCELLANEOUS GASKETS

Exhaust Pipe Gasket	1957		(Flange Type), Damper To Manifold, Pipe To Manifold	F5360C	2
Fuel Pump Gasket	1957			D27094	1
Push Rod Cover Set	1957			PS38754	1
Water Outlet Gasket	1957			C25487	1

Hyundai

Engine Index

Engine	Year	Block
1439CC (1.4L) 4G33 Mitsubishi	1984-1987	1
1468CC (1.5L) G4AJ 8 Valve Mitsubishi	1986-1989	2
1468CC (1.5L) G4DJ 8 Valve Mitsubishi	1990-1994	3
1595CC (1.6L) DOHC Mitsubishi	1992-1995	4
1597CC (1.6L) 4G32 SOHC Mitsubishi	1984-1988	5

Engine	Year	Block
1836CC (1.8L) G4CN DOHC Mitsubishi	1993-1995	6
1997CC (2.0L) G4CP DOHC Mitsubishi	1992-1995	7
1997CC (2.0L) G63B SOHC Mitsubishi	1985-1989	8
2351CC (2.4L) G4CS SOHC Mitsubishi	1989-1991	9
2972CC (3.0L) 6G72 SOHC Mitsubishi	1990-1997	10

Hyundai

Model Index

Model	Engine	Year	Block	Model	Engine	Year	Block
Elantra	1595CC (1.6L) DOHC Mitsubishi	1992-1995	4	Scoupe	1468CC (1.5L) G4DJ 8 Valve Mitsubishi	1991-1992	3
Elantra	1836CC (1.8L) G4CN DOHC Mitsubishi	1993-1995	6	Sonata	1997CC (2.0L) G4CP DOHC Mitsubishi	1992-1998	7
Excel	1468CC (1.5L) G4DJ 8 Valve Mitsubishi	1990-1994	3	Sonata	2351CC (2.4L) G4CS SOHC Mitsubishi	1989-1991	9
Excel	1468CC (1.5L) G4AJ 8 Valve Mitsubishi	1986-1989	2	Sonata	2972CC (3.0L) 6G72 SOHC Mitsubishi	1990-1998	10
Pony	1439CC (1.4L) 4G33 Mitsubishi	1984-1988	1	Stellar	1597CC (1.6L) 4G32 SOHC Mitsubishi	1985-1988	5
Pony	1597CC (1.6L) 4G32 SOHC Mitsubishi	1984-1988	5	Stellar	1997CC (2.0L) G63B SOHC Mitsubishi	1985-1989	8

1 1439CC (1.4L) 4G33 Mitsubishi 4 Cyl, 2.874in./73mm (1984-1987) 1

Part	Year	VIN	Model/Application	Part Number	Qty.
ENGINE GASKETS					
Head Set	1984-1987		Canadian	HS5767	1
Full Set	1984-1987		Canadian	FS5767	1
Engine Kit Gasket Set	1984-1987			95-3347VR	1
Cylinder Head Gasket	1984-1987		Canadian Nitroseal	5767	1
Valve Cover Set	1984-1987		Canadian, (Contains Valve Cover Washers) Victo-Tech	VS39753	1
Valve Stem Seal, Exh.	1984-1987		Canadian, (Original Equipment Type)	B45441	4
			Canadian, (Premium)	B45806	4
Valve Stem Seal, Int.	1984-1987		Canadian, (Original Equipment Type)	B45441	4
			Canadian, (Premium)	B45806	4
Manifold Set, Exhaust	1984-1987		Canadian	MS15309	1
Manifold Set, Intake	1984-1987		Canadian	MS15294	1
Oil Pan Set	1984-1987		Canadian Cork Rubber	OS30549	1
Rear Main Seal Set	1984-1987		Canadian	JV506	1
Timing Cover Set	1984-1987		Canadian	JV941	1
Timing Cover Gasket	1984-1987		Canadian	T26807	1
Timing Cover Seal	1984-1987		Canadian	47734	1

MISCELLANEOUS GASKETS

Air Cleaner Mount Gasket	1984-1987		Canadian, 2 Barrel Carburetor	G24090	1
Cam. Semi-Circular Plug	1984-1987		Canadian	B24180	1
Carb. Mount Gasket	1984-1987		Canadian, 2 Barrel Carburetor	G24967	1
E.G.R. Gasket	1984-1987		Canadian	G24092	1
Fuel Pump Gasket	1984-1987		Canadian	D24076	2
Valve Cover Grommet	1984-1987		Canadian	B45729	2
Water Outlet Gasket	1984-1987		Canadian	C24082	1
Water Pump Mount Gasket	1984-1987		Canadian	K26239	1

2 1468CC (1.5L) G4AJ 8 Valve Mitsubishi 4 Cyl, 2.972in./75.5mm (1986-1989) 2

Part	Year	VIN	Model/Application	Part Number	Qty.
ENGINE GASKETS					
Head Set	1986-1989		Canadian, United States, (Exhaust Pipe Gasket Not Included)	HS3798	1
Full Set	1986-1989		Canadian, United States, (Exhaust Pipe Gasket Not Included)	FS3798	1
Engine Kit Gasket Set	1986-1989			95-3349VR	1
Cylinder Head Gasket	1986-1989			3675	1
Valve Cover Set	1986-1989		Victo-Tech	VS38425	1
Valve Stem Oil Seal, Aux.	1986-1989		Canadian, United States, (Jet Valve)	B45471	4
Valve Stem Seal, Exh.	1986-1989		Canadian, United States	B45442	4
Valve Stem Seal, Int.	1986-1989		Canadian, United States	B45442	4
Manifold Set, Exhaust	1986-1989		Canadian, United States	MS15524	1
Manifold Set, Intake	1986-1989		Canadian, United States	MS7391	1

2 (cont.)	1468CC (1.5L) G4AJ 8 Valve Mitsubishi 4 Cyl, 2.972in./75.5mm (1986-1989)				2 (cont.)
---------------------	---	--	--	--	---------------------

Part	Year	VIN	Model/Application	Part Number	Qty.
ENGINE GASKETS (cont.)					
Oil Pan Set	1986-1989			<i>Cork Rubber</i> OS20674	1
Rear Main Seal Set	1986-1989			JV506	1
Timing Cover Set	1986-1989			JV944	1
Timing Cover Gasket	1986-1989		Canadian, United States	T26806	1
Timing Cover Seal	1986-1989		Canadian, United States	47738	1

MISCELLANEOUS GASKETS					
Air Cleaner Mount Gasket	1986-1989		Canadian, United States, 2 Barrel Carburetor	G30652	1
Camshaft Seal	1986-1989			47918	1
Carb. Mount Gasket	1988-1989		Canadian, United States, 2 Barrel Carburetor, Top	G30805	1
			Canadian, United States, 2 Barrel Carburetor, Bottom	G30806	1
E.G.R. Gasket	1986-1987		Canadian, United States, 2 Barrel Carburetor	G25771	1
	1988-1989		Canadian, United States	<i>Nitroseal</i> G30714	1
Exhaust Pipe Gasket	1986-1987		Canadian, United States	G24078	1
	1988-1989		Canadian, United States, (Flange Type), Pipe To Manifold	F7422	1
Exhaust Pipe Gasket	1987-1989		Canadian, United States, (Flange Type), Manifold To Converter	F14761	1
				F14761	1
Fuel Pump Gasket	1986-1989		Canadian, United States	D24085	2
Water Outlet Gasket	1986-1989			C24082	1
Water Pump Mount Gasket	1986-1989			K26379	1

3	1468CC (1.5L) G4DJ 8 Valve Mitsubishi 4 Cyl, 2.972in./75.5mm (1990-1994)				3
----------	---	--	--	--	----------

Part	Year	VIN	Model/Application	Part Number	Qty.
ENGINE GASKETS					
Head Set	1990-1994		(Exhaust Pipe Gasket Not Included)	HS3798X	1
Full Set	1990-1994		(Exhaust Pipe Gasket Not Included)	FS3798X	1
Engine Kit Gasket Set	1990-1994		(Intake Manifold Gasket Not Included), Use With Part Number MS15439	95-3349VR	1
Cylinder Head Gasket	1990-1994			3675	1
Valve Cover Set	1990-1994			<i>Victo-Tech</i> VS38425	1
Valve Stem Seal, Exh.	1990-1994			B45442	4
Valve Stem Seal, Int.	1990-1994			B45442	4
Manifold Set, Exhaust	1990-1994			MS12340	1
Manifold Set, Intake	1990-1994		(Contains Plenum Chamber Gasket)	MS15439	1
Plenum Chamber Gasket	1990-1994			MS12338	1
Oil Pan Set	1990-1994			<i>Cork Rubber</i> OS20674	1
Rear Main Seal Set	1990-1994			JV506	1
Timing Cover Set	1990-1994			JV944	1
Timing Cover Gasket	1990-1992			T26806	1
Timing Cover Seal	1990-1994			47738	1
MISCELLANEOUS GASKETS					
Air Flow Sensor	1990-1994			G30807	1
Camshaft Seal	1990-1994			47918	1
E.G.R. Gasket	1991-1992			<i>Nitroseal</i> G30714	1
Exhaust Pipe Gasket	1990-1994		Excel, (Flange Type), Pipe To Manifold	F12336	1
	1990-1993		Excel, Catalytic Converter To Front Exhaust Pipe	F12419	1
	1991-1992		Scoupe, (Flange Type), Pipe To Manifold	F12336	1
Throttle Body Gasket	1990-1994			G31116	1
Water Outlet Gasket	1990-1994			C24082	1
Water Pump Mount Gasket	1990-1994			K26379	1

Hyundai

4 1595CC (1.6L) DOHC Mitsubishi 4 Cyl, 3.240in./82.3mm (1992-1995) 4

Part	Year	VIN	Model/Application	Part Number	Qty.
ENGINE GASKETS					
Head Set	1992-1995		(Exhaust Pipe Gasket Not Included)	HS5875	1
Full Set	1992-1995		(Exhaust Pipe Gasket Not Included)	FS5875	1
Cylinder Head Gasket	1992-1995		<i>Nitroseal</i>	5875	1
Valve Cover Set	1992-1995		(Contains Spark Plug Tube Seals, Contains Camshaft Semi Circular Plug) <i>Victo-Tech</i>	VS50066	1
Valve Stem Seal, Exh.	1992-1995			B45622	8
Valve Stem Seal, Int.	1992-1995			B45622	8
Manifold Set, Exhaust	1992-1995		<i>Multi-Layered Steel</i>	MS16215	1
Manifold Set, Intake	1992-1995			MS15976	1
Oil Pan Set	1992-1995		<i>Cork Rubber</i>	OS32008	1
Rear Main Seal Set	1992-1995			JV534	1
Timing Cover Set	1992-1995			JV1036	1

MISCELLANEOUS GASKETS					
Cam. Semi-Circular Plug	1992-1995			B45621	1
E.G.R. Gasket	1992-1995		<i>Nitroseal</i>	G30714	1
Exhaust Pipe Gasket	1992-1994		(Flange Type), Catalytic Converter To Exhaust Pipe	F7422	1
			Except California, (Flange Type), Pipe To Manifold	F12336	1
Water Outlet Gasket	1992-1995			C24082	1
Water Pump Mount Gasket	1992-1995			K31039	1

5 1597CC (1.6L) 4G32 SOHC Mitsubishi 4 Cyl, 3.028in./76.9mm (1984-1988) 5

Part	Year	VIN	Model/Application	Part Number	Qty.
ENGINE GASKETS					
Head Set	1984-1988		Canadian	HS3517	1
Full Set	1984-1988		Canadian	FS3517	1
Engine Kit Gasket Set	1985-1988			95-3347VR	1
Cylinder Head Gasket	1984-1988		Canadian <i>Nitroseal</i>	3517	1
Valve Cover Set	1984-1988		Canadian, (Contains Valve Cover Washers) <i>Victo-Tech</i>	VS39753	1
Valve Stem Seal, Exh.	1984-1988		Canadian, (Original Equipment Type)	B45441	4
			Canadian, (Premium)	B45806	4
Valve Stem Seal, Int.	1984-1988		Canadian, (Original Equipment Type)	B45441	4
			Canadian, (Premium)	B45806	4
Manifold Set, Exhaust	1984-1988		Canadian	MS15309	1
Manifold Set, Intake	1984-1988		Canadian	MS15294	1
Oil Pan Set	1984-1988		Canadian <i>Cork Rubber</i>	OS30549	1
Rear Main Seal Set	1984-1988		Canadian	JV506	1
Timing Cover Set	1984-1988		Canadian	JV941	1
Timing Cover Gasket	1984-1988		Canadian	T26807	1
Timing Cover Seal	1984-1988		Canadian	47734	1

MISCELLANEOUS GASKETS					
Air Cleaner Mount Gasket	1984-1988		Canadian, 2 Barrel Carburetor	G24090	1
Cam. Semi-Circular Plug	1984-1988		Canadian	B24180	1
Carb. Mount Gasket	1984-1988		Canadian, 2 Barrel Carburetor	G24967	1
E.G.R. Gasket	1984-1988		Canadian	G24092	1
Fuel Pump Gasket	1984-1988		Canadian	D24076	2
Valve Cover Grommet	1984-1988		Canadian	B45729	2
Water Outlet Gasket	1984-1988		Canadian	C24082	1
Water Pump Mount Gasket	1984-1988		Canadian	K26239	1

6 1836CC (1.8L) G4CN DOHC Mitsubishi 4 Cyl, 3.208in./81.5mm (1993-1995) 6

Part	Year	VIN	Model/Application	Part Number	Qty.
ENGINE GASKETS					
Head Set	1993-1995		(Exhaust Pipe Gasket Not Included)	HS5875	1
Full Set	1993-1995		(Exhaust Pipe Gasket Not Included)	FS5875	1
Cylinder Head Gasket	1993-1995		Nitroseal	5875	1
Valve Cover Set	1993-1995		(Contains Spark Plug Tube Seals, Contains Camshaft Semi Circular Plug) Victo-Tech	VS50066	1
Valve Stem Seal, Exh.	1993-1995			B45622	8
Valve Stem Seal, Int.	1993-1995			B45622	8
Manifold Set, Exhaust	1993-1995		Multi-Layered Steel	MS16215	1
Manifold Set, Intake	1993-1995			MS15976	1
Oil Pan Set	1993-1995		Cork Rubber	OS32008	1
Rear Main Seal Set	1993-1995			JV534	1
Timing Cover Set	1993-1995			JV1036	1

MISCELLANEOUS GASKETS

Cam. Semi-Circular Plug	1993-1995			B45621	1
E.G.R. Gasket	1993-1995		Nitroseal	G30714	1
Exhaust Pipe Gasket	1993-1994		Except California, (Flange Type), Pipe To Manifold	F12336	1
Water Outlet Gasket	1993-1995			C24082	1
Water Pump Mount Gasket	1993-1995			K30615	1

7 1997CC (2.0L) G4CP DOHC Mitsubishi 4 Cyl, 3.346in./85mm (1992-1995) 7

Part	Year	VIN	Model/Application	Part Number	Qty.
ENGINE GASKETS					
Head Set	1992-1994		(Exhaust Pipe Gasket Not Included)	HS5875	1
Full Set	1992-1994		(Exhaust Pipe Gasket Not Included)	FS5875	1
Cylinder Head Gasket	1992-1995		Nitroseal	5875	1
Valve Cover Set	1992-1994		(Contains Spark Plug Tube Seals, Contains Camshaft Semi Circular Plug) Victo-Tech	VS50066	1
Valve Stem Seal, Exh.	1992-1994			B45622	8
Valve Stem Seal, Int.	1992-1994			B45622	8
Manifold Set, Exhaust	1992-1995		Multi-Layered Steel	MS16215	1
Manifold Set, Intake	1992-1995			MS15976	1
Oil Pan Set	1992-1995		Cork Rubber	OS32008	1
Rear Main Seal Set	1992-1995			JV534	1
Timing Cover Set	1992-1995			JV1036	1

MISCELLANEOUS GASKETS

Camshaft Seal	1992-1995			47918	2
E.G.R. Gasket	1992-1994		Nitroseal	G30714	1
Exhaust Pipe Gasket	1992-1994		(Flange Type), Pipe To Manifold	F12336	1
Water Outlet Gasket	1992-1995			C24082	1
Water Pump Mount Gasket	1992-1995			K30615	1

8 1997CC (2.0L) G63B SOHC Mitsubishi 4 Cyl, 3.346in./85mm (1985-1989) 8

Part	Year	VIN	Model/Application	Part Number	Qty.
ENGINE GASKETS					
Engine Kit Gasket Set	1985-1989		2 Barrel Carburetor	95-3133VR	1

9 2351CC (2.4L) G4CS SOHC Mitsubishi 4 Cyl, 3.406in./86.5mm (1989-1991) 9

Part	Year	VIN	Model/Application	Part Number	Qty.
ENGINE GASKETS					
Head Set	1989-1991		(Exhaust Pipe Gasket Not Included)	HS5747X	1
Lower Set	1989-1991		(Requires Head Set To Make Full Set)	CS5747W	1
Full Set	1989-1991		(Exhaust Pipe Gasket Not Included)	FS5747X	1

Hyundai

9 (cont.)	2351CC (2.4L) G4CS SOHC Mitsubishi 4 Cyl, 3.406in./86.5mm (1989-1991)				9 (cont.)
---------------------	--	--	--	--	---------------------

Part	Year	VIN	Model/Application	Part Number	Qty.	
ENGINE GASKETS (cont.)						
Cylinder Head Gasket	1989-1991		<i>Nitroseal</i>	5747	1	
Valve Cover Set	1989-1991		(Valve Cover Grommets Not Included, Camshaft Semi Circular Plug Not Included)	<i>Victo-Tech</i>	VS40003	1
			(Contains Valve Cover Grommets, Contains Camshaft Semi Circular Plug)	<i>Victo-Tech</i>	VS40003CP	1
Valve Stem Seal, Exh.	1989-1991		(Original Equipment Type)		B45441	4
			(Premium)		B45806	4
Valve Stem Seal, Int.	1989-1991		(Original Equipment Type)		B45441	4
			(Premium)		B45806	4
Manifold Set, Exhaust	1989-1991			MS15389	1	
Manifold Set, Intake	1989-1991		(Contains Plenum Chamber Gasket)	MS15387Y	1	
Plenum Chamber Gasket	1989-1991			MS14900	1	
Oil Pan Set	1989-1991		<i>Cork Rubber</i>	OS32008	1	
Rear Main Seal Set	1989-1991			JV534	1	
Timing Cover Set	1989-1991		(Requires Oil Pan Set)	JV1036	1	
Timing Cover Seal	1989-1991			47730	1	

MISCELLANEOUS GASKETS					
Air Flow Sensor	1989-1991			G30807	1
Camshaft Seal	1989-1991			47918	1
Cam. Semi-Circular Plug	1989-1991			B24180	1
E.G.R. Gasket	1989-1991		<i>Nitroseal</i>	G30714	1
Exhaust Pipe Gasket	1989-1991		(Flange Type), Pipe To Manifold	F7422	1
Throttle Body Gasket	1989-1991			G30808	1
Valve Cover Grommet	1989-1991			B45729	2
Water Outlet Gasket	1989-1991			C24082	1
Water Pump Mount Gasket	1989-1991			K30615	1

10	2972CC (3.0L) 6G72 SOHC Mitsubishi V6 Cyl, 3.587in./91.1mm (1990-1997)				10
-----------	---	--	--	--	-----------

Part	Year	VIN	Model/Application	Part Number	Qty.	
ENGINE GASKETS						
Head Set	1997		Thru 2/97, (Exhaust Pipe Gasket Not Included)	HS5765-3	1	
	1990-1996		(Exhaust Pipe Gasket Not Included)	HS5765-3	1	
Lower Set	1997		Thru 2/97, (Requires Head Set To Make Full Set)	CS5765-1	1	
	1990-1996		(Requires Head Set To Make Full Set)	CS5765-1	1	
Engine Kit Gasket Set	1990-1995			95-3192VR	1	
Cylinder Head Gasket	1997		Thru 2/97	<i>Nitroseal</i>	5765	2
	1990-1997			<i>Nitroseal</i>	5765	2
Cyl. Head Bolt Set	1990-1995			GS33327	1	
Cyl. Head Spacer Shim	1997		Requires Sealing Compound, Thru 2/97	<i>Steel</i>	5765S	2
	1990-1996		Requires Sealing Compound	<i>Steel</i>	5765S	2
Sealing Compound	1990-1997		(4 Ounce Brush Top Can)		JV66B	1
			(12 Ounce Spray Can)		JV66S	1
Valve Cover Set	1990-1995		(Contains Valve Cover Grommets)	<i>Victo-Tech</i>	VS50054	1
			(Valve Cover Grommets Not Included, Camshaft Circular Plug Not Included)	<i>Victo-Tech</i>	VS50256	1
Valve Stem Seal, Exh.	1990-1997			<i>Fluoroelastomer</i>	B45790	6
Valve Stem Seal, Int.	1990-1997			<i>Fluoroelastomer</i>	B45790	6
Manifold Set, Exhaust	1990-1997			MS15543	1	
Oil Pan Set	1990-1997			<i>Cork Rubber</i>	OS32054	1
Rear Main Seal Set	1990-1997			JV1062	1	
Crank Repair Sleeve	1990		Use With Part Number A505, Rear <i>Nickel Plated Formed Steel, .013" Thickness</i>	A342	1	
Timing Cover Set	1990-1997			JV565	1	

10 (cont.)	2972CC (3.0L) 6G72 SOHC Mitsubishi V6 Cyl, 3.587in./91.1mm (1990-1997)				10 (cont.)
----------------------	---	--	--	--	----------------------

Part	Year	VIN	Model/Application	Part Number	Qty.
MISCELLANEOUS GASKETS					
Camshaft Seal	1990-1997			47918	2
Cam. Semi-Circular Plug	1990-1997			B45682	2
E.G.R. Gasket	1990-1997		Nitroseal	G30714	1
Fuel Pump Gasket	1990-1997			D24076	2
Valve Cover Grommet	1990-1997			B45729	4
Water Outlet Gasket	1990-1997			C24082	1
Water Pipe O-Ring	1990-1997			B45797	2
Water Pump Mount Gasket	1990-1997		Adapter To Block	K30816	1
			Pump To Adapter	K31160	1

Infiniti

Engine Index

Engine	Year	Block
1998CC (2.0L) SR20DE DOHC Nissan	1991-1994	1
2960CC (3.0L) VG30DE DOHC Nissan	1993-1997	2
2960CC (3.0L) VG30E SOHC Nissan	1990-1992	3

Engine	Year	Block
2987CC (3.0L) VQ30DE DOHC Nissan	1995-2001	4
4494CC (4.5L) VH45DE DOHC	1990-1993	5

Model Index

Model	Engine	Year	Block
G20	1998CC (2.0L) SR20DE DOHC Nissan	1991-1996	1
I30	2987CC (3.0L) VQ30DE DOHC Nissan	1995-2001	4
J30	2960CC (3.0L) VG30DE DOHC Nissan	1993-1997	2

Model	Engine	Year	Block
M30	2960CC (3.0L) VG30E SOHC Nissan	1990-1992	3
Q45	4494CC (4.5L) VH45DE DOHC	1990-1996	5

1	1998CC (2.0L) SR20DE DOHC Nissan 4 Cyl, 3.386in./86mm (1991-1994)				1
----------	--	--	--	--	----------

Part	Year	VIN	Model/Application	Part Number	Qty.
ENGINE GASKETS					
Head Set	1991-1994		(Requires RTV)	HS4917	1
Full Set	1991-1994		(Requires RTV)	FS4917	1
Cylinder Head Gasket	1991-1994		Nitroseal	4917	1
Valve Cover Set	1991-1994		(Contains Spark Plug Tube Seals) Victo-Tech	VS50140	1
Valve Stem Seal, Exh.	1991-1992			B45601	8
Valve Stem Seal, Int.	1991-1992			B45601	8
Manifold Set, Exhaust	1991-1994			MS15684	1
Manifold Set, Intake	1991-1994		(Contains Plenum Chamber Gasket)	MS15683	1
Plenum Chamber Gasket	1991-1992			MS13996	1
Oil Pan Set	1991-1994		Original Equipment Uses RTV Silicone	JV6	1
Rear Main Seal	1991-1994		Rubber	67119	1
Timing Cover Set	1991-1994			JV1147	1

MISCELLANEOUS GASKETS

E.G.R. Gasket	1991-1992			G26315	1
Exhaust Pipe Gasket	1991-1994		(Ring Type 'A'), Pipe To Manifold	F7281	2
	1991-1992		(Flange Type), Catalytic Converter To Exhaust Pipe Composition	F7285	2
Throttle Body Gasket	1991-1992			G31093	1
Water Outlet Gasket	1991-1994		Original Equipment Uses RTV Silicone	JV6	1
Water Pump Mount Gasket	1991-1994		Original Equipment Uses RTV Silicone	JV6	1

Infiniti

2 2960CC (3.0L) VG30DE DOHC Nissan V6 Cyl, 3.425in./87mm (1993-1997) 2

Part	Year	VIN	Model/Application	Part Number	Qty.
------	------	-----	-------------------	-------------	------

ENGINE GASKETS

Valve Cover Set	1993-1997		(Contains End Plugs)	VS50268	1
-----------------	-----------	--	----------------------	---------	---

3 2960CC (3.0L) VG30E SOHC Nissan V6 Cyl, 3.425in./87mm (1990-1992) 3

Part	Year	VIN	Model/Application	Part Number	Qty.
------	------	-----	-------------------	-------------	------

ENGINE GASKETS

Head Set	1990-1992			HS5826	1
Full Set	1990-1992			FS5826	1
Cylinder Head Gasket	1990-1992		Nitroseal	5826	2
Cyl. Head Spacer Shim	1990-1992		Requires Sealing Compound Steel	5826S	1
Sealing Compound	1990-1992		(4 Ounce Brush Top Can)	JV66B	1
			(12 Ounce Spray Can)	JV66S	1
Valve Cover Set	1990-1992		Victo-Tech	VS38376	1
Valve Stem Seal, Exh.	1990-1992			B20183	6
Valve Stem Seal, Int.	1990-1992			B45475	6
Manifold Set, Exhaust	1990-1992			MS15364	1
Manifold Set, Intake	1990-1992			MS15362W	1
Plenum Chamber Gasket	1990-1992			MS15494	1
Oil Pan Set	1990-1992		(Requires RTV) Victo-Tech	OS32080	1
Rear Main Seal Set	1990-1992			JV538	1
Timing Cover Set	1990-1992		(Contains Camshaft Seal)	JV1107	1

MISCELLANEOUS GASKETS

Camshaft Seal	1990-1992			66864	2
E.G.R. Gasket	1990-1992			G20610	2
Exhaust Pipe Gasket	1990-1992		(Flange Type), Pipe To Manifold	F7284	1
			(Flange Type), Catalytic Converter To Exhaust Pipe Composition	F7285	2
Throttle Body Gasket	1990-1992			G30801	1
Water Outlet Gasket	1990-1992		Original Equipment Uses RTV Silicone	JV6	1
Water Pump Mount Gasket	1990-1992		Original Equipment Uses RTV Silicone	JV6	1

4 2987CC (3.0L) VQ30DE DOHC Nissan V6 Cyl, 3.661in./93mm (1995-2001) 4

Part	Year	VIN	Model/Application	Part Number	Qty.
------	------	-----	-------------------	-------------	------

ENGINE GASKETS

Valve Cover Set	1996-2001		(Contains Grommets, Contains Spark Plug Tube Seals)	VS50290	1
-----------------	-----------	--	---	---------	---

MISCELLANEOUS GASKETS

Exhaust Pipe Gasket	2000-2001		From 6/00, (Flange Type), Catalytic Converter To Exhaust Pipe Composition	F7285	2
	1995-2001		(Ring Type 'A'), Exhaust Pipe To Muffler	F7282	1
	1997-1999		(Flange Type), Resonator Metal	F7480	1
	1995-1997		(Flange Type), Catalytic Converter To Exhaust Pipe Composition	F7285	2

5 4494CC (4.5L) VH45DE DOHC V8 Cyl, 3.661in./93mm (1990-1993) 5

Part	Year	VIN	Model/Application	Part Number	Qty.
------	------	-----	-------------------	-------------	------

ENGINE GASKETS

Head Set	1990-1993			HS5918	1
Full Set	1990-1993			FS5918	1
Cylinder Head Gasket	1990-1993		Right	5918	1
			Left	5919	1
Valve Cover Set	1990-1993		(Requires RTV, Contains Camshaft Seal, Contains Valve Cover Washers)	VS50157	1
Valve Stem Seal, Exh.	1990-1993			B45475	16
Valve Stem Seal, Int.	1990-1993			B45475	16

5 4494CC (4.5L) VH45DE DOHC V8 Cyl, 3.661in./93mm (1990-1993) **5**
(cont.) (cont.)

Part	Year	VIN	Model/Application	Part Number	Qty.
ENGINE GASKETS (cont.)					
Manifold Set, Exhaust	1990-1993			MS10090	1
Manifold Set, Intake	1990-1993		(Contains Plenum Chamber Gasket)	MS16072	1
Plenum Chamber Gasket	1990-1993			MS10089	1
Oil Pan Set	1990-1993		Cork Rubber	OS32108	1
Rear Main Seal	1990-1993		Rubber	67119	1
Timing Cover Set	1990-1993			JV1141	1

MISCELLANEOUS GASKETS

Camshaft Seal Set	1990-1993		(O-Ring Type)	JV1142	1
E.G.R. Gasket	1990-1993			G26315	1
Exhaust Pipe Gasket	1990-1993		(Ring Type 'A'), Pipe To Manifold	F10091	2
			Catalytic Converter To Exhaust Pipe	F14144	1
Throttle Body Gasket	1990-1993			G31224	1
Water Outlet Gasket	1990-1993			C31225	1
Water Pump Mount Gasket	1990-1993			K31226	1

Isuzu

Engine Index

Engine	Year	Block	Engine	Year	Block
1471CC (1.5L) 4XC1 SOHC	1985-1989	1	1817CC (1.8L) G180Z SOHC	1981-1984	6
1588CC (1.6L) 4XE1 (RLR) SOHC 12 Valve	1991-1993	2	1949CC (1.9L) G200Z SOHC	1983-1987	7
1588CC (1.6L) 4XE1W DOHC	1989-1991	3	1994CC (2.0L) 4ZC1 SOHC Turbo	1985-1989	8
1809CC (1.8L) 4XF1 DOHC (RLX)	1992-1993	4	2254CC (2.3L) 4ZD1 SOHC	1988-1989	9
1817CC (1.8L) 4FB1 SOHC Diesel	1981-1984	5			

Model Index

Model	Engine	Year	Block	Model	Engine	Year	Block
I-Mark	1471CC (1.5L) 4XC1 SOHC	1985-1989	1	Impulse	1994CC (2.0L) 4ZC1 SOHC Turbo	1985-1989	8
I-Mark	1588CC (1.6L) 4XE1W DOHC	1989	3	Impulse	2254CC (2.3L) 4ZD1 SOHC	1987-1989	9
I-Mark	1817CC (1.8L) 4FB1 SOHC Diesel	1981-1984	5	Stylus	1588CC (1.6L) 4XE1 (RLR) SOHC 12 Valve	1991-1993	2
I-Mark	1817CC (1.8L) G180Z SOHC	1981-1985	6	Stylus	1588CC (1.6L) 4XE1W DOHC	1991	3
Impulse	1588CC (1.6L) 4XE1W DOHC	1990-1991	3	Stylus	1809CC (1.8L) 4XF1 DOHC (RLX)	1992-1993	4
Impulse	1809CC (1.8L) 4XF1 DOHC (RLX)	1992	4				
Impulse	1949CC (1.9L) G200Z SOHC	1983-1987	7				

1 1471CC (1.5L) 4XC1 SOHC 4 Cyl, 3.031in./77mm (1985-1989) **1**

Part	Year	VIN	Model/Application	Part Number	Qty.
ENGINE GASKETS					
Head Set	1985-1989			HS5705	1
Full Set	1985-1989			FS5705	1
Engine Kit Gasket Set	1985-1989			95-3173VR	1
Cylinder Head Gasket	1985-1989			5705	1
Valve Cover Set	1985-1989		Victo-Tech	VS50003	1
Valve Stem Seal, Exh.	1985-1989			B45571	4
Valve Stem Seal, Int.	1985-1989			B45571	4
Manifold Set, Exhaust	1985-1989			MS12319	1
Manifold Set, Intake	1985-1989			MS15399	1
Oil Pan Set	1985-1989		Cork Rubber	OS32024	1
Rear Main Seal Set	1985-1989			JV550	1
Timing Cover Set	1985-1989			JV1025	1

MISCELLANEOUS GASKETS

Camshaft Seal	1985-1989			67111	1
E.G.R. Gasket	1985-1989			G31300	1
Exhaust Pipe Gasket	1987-1989		(Flange Type), Pipe To Manifold	F14635	1
	1985-1989		(Flange Type), Catalytic Converter To Exhaust Pipe	F7277	2

Isuzu

1 (cont.)	1471CC (1.5L) 4XC1 SOHC 4 Cyl, 3.031in./77mm (1985-1989)				1 (cont.)
---------------------	---	--	--	--	---------------------

Part	Year	VIN	Model/Application	Part Number	Qty.
------	------	-----	-------------------	-------------	------

MISCELLANEOUS GASKETS (cont.)

Exhaust Pipe Gasket (cont.)	1985-1986		(Ring Type 'A'), Pipe To Manifold	F7493	1
Fuel Pump Gasket	1985-1989			D30644	1
Water Outlet Gasket	1985-1989			C30643	1
Water Pump Mount Gasket	1985-1989			K30642	1

2	1588CC (1.6L) 4XE1 (RLR) SOHC 12 Valve 4 Cyl, 3.150in./80mm (1991-1993)				2
----------	--	--	--	--	----------

Part	Year	VIN	Model/Application	Part Number	Qty.
------	------	-----	-------------------	-------------	------

ENGINE GASKETS

Head Set	1991-1993			HS5910	1
Full Set	1991-1993			FS5910	1
Cylinder Head Gasket	1991-1993		Nitroseal	5910	1
Valve Cover Set	1991-1993		Victo-Tech	VS50155	1
Manifold Set, Exhaust	1991-1993			MS12397	1
Manifold Set, Intake	1991-1993		(Contains Plenum Chamber Gasket)	MS16061	1
Plenum Chamber Gasket	1991-1993			MS16062	1
Oil Pan Set	1991-1993		Cork Rubber	OS32024	1
Rear Main Seal Set	1991-1993			JV1604	1
Timing Cover Set	1991-1993		(Requires RTV)	JV1025	1

MISCELLANEOUS GASKETS

Exhaust Pipe Gasket	1991-1993		(Ring Type 'A'), Pipe To Manifold	F7493	1
			(Flange Type), Catalytic Converter	F10086	2
Therm. Housing Gasket	1991-1993		Victo-Tech	C31206	1
Throttle Body Gasket	1991-1993			G31205	1
Water Outlet Gasket	1991-1993		Victo-Tech	C31206	1

3	1588CC (1.6L) 4XE1W DOHC 4 Cyl, 3.150in./80mm (1989-1991)				3
----------	--	--	--	--	----------

Part	Year	VIN	Model/Application	Part Number	Qty.
------	------	-----	-------------------	-------------	------

ENGINE GASKETS

Head Set	1989-1991			HS5911	1
Full Set	1990-1991			FS5911	1
Cylinder Head Gasket	1989-1991		Nitroseal	5911	1
Valve Cover Set	1989-1991		Victo-Tech	VS50154	1
Valve Stem Seal, Exh.	1989-1991			B45571	8
Valve Stem Seal, Int.	1989-1991			B45571	8
Manifold Set, Exhaust	1989-1991			MS16065	1
Manifold Set, Intake	1990-1991		(Contains Plenum Chamber Gasket)	MS16063	1
Plenum Chamber Gasket	1989-1991			MS16064	1
Oil Pan Set	1990-1991		Cork Rubber	OS32024	1
	1989		Original Equipment Uses RTV Silicone	JV6	1
Rear Main Seal Set	1990-1991			JV1604	1
	1989			JV550	1
Timing Cover Set	1989-1991		(Requires RTV)	JV1025	1

MISCELLANEOUS GASKETS

Camshaft Seal	1989-1991			66780	2
E.G.R. Gasket	1989-1991			G31211	1
Exhaust Pipe Gasket	1990-1991		(Flange Type), Catalytic Converter To Exhaust Pipe	F10086	2
			Pipe To Manifold	F12398	1
	1989		Pipe To Manifold	F7279	1
Therm. Housing Gasket	1989-1991		Victo-Tech	C31203	1

3 1588CC (1.6L) 4XE1W DOHC 4 Cyl, 3.150in./80mm (1989-1991) **3**
(cont.) (cont.)

Part	Year	VIN	Model/Application	Part Number	Qty.
MISCELLANEOUS GASKETS (cont.)					
Water Outlet Gasket	1989-1991		(2 Holes) <i>Victopac</i>	C20115	1
Water Pump Mount Gasket	1990-1991			K31201	1
	1989			K30642	1

4 1809CC (1.8L) 4XF1 DOHC (RLX) 4 Cyl, 3.150in./80mm (1992-1993) **4**

Part	Year	VIN	Model/Application	Part Number	Qty.
ENGINE GASKETS					
Head Set	1992-1993			HS5917	1
Full Set	1992-1993			FS5917	1
Cylinder Head Gasket	1992-1993		<i>Nitroseal</i>	5917	1
Valve Cover Set	1992-1993		<i>Victo-Tech</i>	VS50154	1
Valve Stem Seal, Exh.	1992-1993			B45571	8
Valve Stem Seal, Int.	1992-1993			B45571	8
Manifold Set, Exhaust	1992-1993			MS16065	1
Manifold Set, Intake	1992-1993		(Contains Plenum Chamber Gasket)	MS16066	1
Plenum Chamber Gasket	1992-1993			MS16051	1
Oil Pan Set	1992-1993		Original Equipment Uses RTV <i>Silicone</i>	JV6	1
Rear Main Seal Set	1992-1993			JV1604	1
Timing Cover Set	1992-1993		(Camshaft Seals Not Included)	JV1025	1

MISCELLANEOUS GASKETS

Camshaft Seal	1992-1993			66780	2
E.G.R. Gasket	1992-1993			G31415	1
Exhaust Pipe Gasket	1992-1993		(Flange Type), Catalytic Converter To Exhaust Pipe	F10086	2
			(Flange Type), Pipe To Manifold	F12398	1
Therm. Housing Gasket	1992-1993			C31214	1
Throttle Body Gasket	1992-1993			G31202	1
Water Inlet Gasket	1992-1993			C31213	1
Water Outlet Gasket	1992-1993			C31215	1
Water Pump Mount Gasket	1992-1993			K31201	1

5 1817CC (1.8L) 4FB1 SOHC Diesel 4 Cyl, 3.307in./84mm (1981-1984) **5**

Part	Year	VIN	Model/Application	Part Number	Qty.
ENGINE GASKETS					
Head Set	1981-1984		(Exhaust Pipe Gasket Not Included)	HS3706	1
Full Set	1981-1984		(Exhaust Pipe Gasket Not Included)	FS3706	1
Cylinder Head Gasket	1981-1984			3706	1
Valve Cover Set	1981-1984		(Contains Valve Cover End Plug) <i>Victo-Tech</i>	VS39364	1
Valve Stem Seal, Exh.	1981-1984			B20183	4
Valve Stem Seal, Int.	1981-1984			B20183	4
Manifold Set, Exhaust	1981-1984			MS15325	1
Manifold Set, Intake	1981-1984			MS15324	1
Oil Pan Set	1981-1984		<i>Victo-Tech</i>	OS30574	1
Rear Main Seal Set	1981-1984			JV525	1
Timing Cover Set	1981-1984			JV986	1

MISCELLANEOUS GASKETS

Camshaft Seal	1981-1984			47953	1
Cylinder Head End Plug	1981-1984			B24165	1
Exhaust Pipe Gasket	1981-1984		(Ring Type 'F'), Pipe To Manifold	F7210	1
Water Outlet Gasket	1981-1984		Housing To Block	C30675	1
				C30676	1

Isuzu

5	1817CC (1.8L) 4FB1 SOHC Diesel 4 Cyl, 3.307in./84mm (1981-1984)	5
(cont.)		(cont.)

Part	Year	VIN	Model/Application	Part Number	Qty.
MISCELLANEOUS GASKETS (cont.)					
Water Pump Mount Gasket	1981-1984		Cover To Block	K27378	1
			Pump To Cover	K27399	1

6	1817CC (1.8L) G180Z SOHC 4 Cyl, 3.307in./84mm (1981-1984)	6
(cont.)		(cont.)

Part	Year	VIN	Model/Application	Part Number	Qty.
ENGINE GASKETS					
Head Set	1981-1984			HS3553	1
Full Set	1981-1984			FS3553	1
Engine Kit Gasket Set	1981-1984			95-3404VR	1
Cylinder Head Gasket	1981-1984		<i>Nitroseal</i>	3553	1
Cyl. Head Spacer Shim	1981-1984		Requires Sealing Compound	<i>Steel</i> 3553S	1
Sealing Compound	1981-1984		(4 Ounce Brush Top Can)	JV66B	1
			(12 Ounce Spray Can)	JV66S	1
Valve Cover Set	1981-1984		(Contains Valve Cover End Plug) <i>Cork Rubber</i>	VS38132	1
Valve Stem Seal, Exh.	1981-1984			B20183	4
Valve Stem Seal, Int.	1981-1984			B20183	4
Manifold Set, Exhaust	1981-1984			MS12282	1
Manifold Set, Intake	1981-1984			MS12279	1
Oil Pan Set	1981-1984		<i>Victo-Tech</i>	OS30164	1
Rear Main Seal Set	1981-1984			JV626	1
Timing Cover Set	1981-1984		(Requires Oil Pan Set, Requires Valve Cover Set)	JV950	1
Timing Cover Seal	1981-1984			47604	1
MISCELLANEOUS GASKETS					
Carb. Mount Gasket	1982-1984		2 Barrel Carburetor	G26781	2
	1981		2 Barrel Carburetor	G26674	2
Cylinder Head End Plug	1981-1984			B24130	2
E.G.R. Gasket	1981-1984		To Manifold	G26276	1
Exhaust Pipe Gasket	1982-1984		(Ring Type 'A'), Pipe To Manifold	F20371	1
	1981-1984		(Flange Type), Catalytic Converter To Exhaust Pipe	F7277	2
	1981		(Ring Type 'B'), Pipe To Manifold	F20223	1
Fuel Pump Gasket	1981-1984			D31016	2
Water Outlet Gasket	1981-1984		(2 Holes) <i>Victopac</i>	C20115	1
Water Pump Mount Gasket	1981-1984			K27272	1

7	1949CC (1.9L) G200Z SOHC 4 Cyl, 3.425in./87mm (1983-1987)	7
(cont.)		(cont.)

Part	Year	VIN	Model/Application	Part Number	Qty.
ENGINE GASKETS					
Head Set	1983-1987		(Exhaust Pipe Gasket Not Included)	HS3716	1
Full Set	1985-1987		(Exhaust Pipe Gasket Not Included)	FS3716W	1
	1983-1984		(Exhaust Pipe Gasket Not Included)	FS3716	1
Engine Kit Gasket Set	1986-1987		(Rear Main Seal Not Included), Use With Part Number JV572	95-3404VR	1
	1983-1985			95-3404VR	1
Cylinder Head Gasket	1983-1987		<i>Nitroseal</i>	3716G	1
Cyl. Head Spacer Shim	1983-1987		Requires Sealing Compound	<i>Steel</i> 3716S	1
Sealing Compound	1983-1987		(4 Ounce Brush Top Can)	JV66B	1
			(12 Ounce Spray Can)	JV66S	1
Valve Cover Set	1983-1987		(Contains Valve Cover End Plug) <i>Cork Rubber</i>	VS38132	1
Valve Stem Seal, Exh.	1983-1987			B20183	4
Valve Stem Seal, Int.	1983-1987			B20183	4
Manifold Set, Exhaust	1983-1987			MS12282	1

7 1949CC (1.9L) G200Z SOHC 4 Cyl, 3.425in./87mm (1983-1987) **7**
(cont.) (cont.)

Part	Year	VIN	Model/Application	Part Number	Qty.
ENGINE GASKETS (cont.)					
Manifold Set, Intake	1983-1987			MS12279	1
Oil Pan Set	1983-1987		<i>Victo-Tech</i>	OS30164	1
Rear Main Seal Set	1985-1987			JV572	1
	1983-1984			JV626	1
Timing Cover Set	1983-1987		(Requires Oil Pan Set, Requires Valve Cover Set)	JV950	1
Timing Cover Seal	1983-1987			47604	1

MISCELLANEOUS GASKETS

Cylinder Head End Plug	1983-1987			B24130	2
E.G.R. Gasket	1983-1987		To Manifold	G26276	1
Exhaust Pipe Gasket	1983-1987		(Flange Type), Pipe To Converter	F7277	2
			(Flange Type), Pipe To Manifold	F7279	1
Fuel Pump Gasket	1983-1984			D27265	1
Throttle Body Gasket	1983-1987			G31073	1
Water Outlet Gasket	1983-1987		(2 Holes) <i>Victopac</i>	C20115	1
Water Pump Mount Gasket	1983-1987			K27272	1

8 1994CC (2.0L) 4ZC1 SOHC Turbo 4 Cyl, 3.465in./88mm (1985-1989) **8**

Part	Year	VIN	Model/Application	Part Number	Qty.
ENGINE GASKETS					
Head Set	1985-1989			HS5734	1
Lower Set	1985-1989		(Requires Head Set To Make Full Set)	CS5734	1
Cylinder Head Gasket	1985-1989		<i>Nitroseal</i>	5734	1
Valve Cover Set	1985-1989		(Contains Valve Cover End Plug) <i>Victo-Tech</i>	VS50041	1
Valve Stem Seal, Exh.	1985-1989			B20183	4
Valve Stem Seal, Int.	1985-1989			B20183	4
Manifold Set, Exhaust	1985-1989			MS15421	1
Manifold Set, Intake	1985-1989		(Contains Plenum Chamber Gasket)	MS15420	1
Plenum Chamber Gasket	1985-1989			MS10095	1
Oil Pan Set	1985-1989		<i>Victo-Tech</i>	OS32042	1
Rear Main Seal Set	1985-1989			JV525	1
Timing Cover Set	1985-1989		(Camshaft Seal Not Included)	JV1058	1
Timing Cover Seal	1985-1989			47927	1

MISCELLANEOUS GASKETS

Camshaft Seal	1985-1989			66780	1
Cylinder Head End Plug	1985-1989			B24130	2
E.G.R. Gasket	1985-1989			G31300	1
Exhaust Pipe Gasket	1985-1989		(Flange Type), Catalytic Converter To Exhaust Pipe	F7277	2
			(Ring Type 'A'), Pipe To Manifold	F20371	1
Throttle Body Gasket	1985-1989			G31073	1
Water Outlet Gasket	1985-1989		(2 Holes) <i>Victopac</i>	C20115	1
Water Pump Mount Gasket	1985-1989			K31320	1

9 2254CC (2.3L) 4ZD1 SOHC 4 Cyl, 3.516in./89.3mm (1988-1989) **9**

Part	Year	VIN	Model/Application	Part Number	Qty.
ENGINE GASKETS					
Head Set	1988-1989			HS5743	1
Engine Kit Gasket Set	1988-1989			95-3302VR	1
Cylinder Head Gasket	1988-1989		<i>Nitroseal</i>	5743	1
Cyl. Head Spacer Shim	1988-1989		Requires Sealing Compound <i>Steel</i>	5743S	1

Isuzu

9 (cont.)	2254CC (2.3L) 4ZD1 SOHC 4 Cyl, 3.516in./89.3mm (1988-1989)				9 (cont.)
---------------------	---	--	--	--	---------------------

Part	Year	VIN	Model/Application	Part Number	Qty.
ENGINE GASKETS (cont.)					
Sealing Compound	1988-1989		(4 Ounce Brush Top Can)	JV66B	1
			(12 Ounce Spray Can)	JV66S	1
Valve Cover Set	1988-1989		(Contains Valve Cover End Plug) <i>Victo-Tech</i>	VS50041	1
Valve Stem Seal, Exh.	1988-1989			B20183	4
Valve Stem Seal, Int.	1988-1989			B20183	4
Manifold Set, Exhaust	1988-1989			MS15424	1
Manifold Set, Intake	1988-1989		(Contains Plenum Chamber Gasket)	MS15617	1
Oil Pan Set	1988-1989		<i>Victo-Tech</i>	OS32042	1
Rear Main Seal Set	1988-1989			JV525	1
Timing Cover Set	1988-1989		(Camshaft Seal Not Included)	JV1058	1

MISCELLANEOUS GASKETS					
Camshaft Seal	1988-1989			66780	1
Cylinder Head End Plug	1988-1989			B24130	2
E.G.R. Gasket	1988-1989			G26276	1
Exhaust Pipe Gasket	1988-1989		Pipe To Manifold	F7279	1
Oil Pump Mounting Gasket	1988-1989			B45701	1
Throttle Body Gasket	1988-1989			G31073	1
Water Outlet Gasket	1988-1989		(2 Holes) <i>Victopac</i>	C20115	1
Water Pump Mount Gasket	1988-1989			K30743	1

Jaguar

Engine Index

Engine	Year	Block	Engine	Year	Block
3590CC (3.6L) DOHC	1988-1989	1	4235CC (4.2L) DOHC	1974-1987	3
3980CC (4.0L) DOHC	1990-1994	2	5343CC (5.3L)	1971-1992	4

Model Index

Model	Engine	Year	Block	Model	Engine	Year	Block
XJ6	3590CC (3.6L) DOHC	1988-1989	1	XJ12C	5343CC (5.3L)	1974-1977	4
XJ6	3980CC (4.0L) DOHC	1990-1997	2	XJ12L	5343CC (5.3L)	1974-1979	4
XJ6	4235CC (4.2L) DOHC	1972-1987	3	XJS	3980CC (4.0L) DOHC	1993-1996	2
XJ6C	4235CC (4.2L) DOHC	1975-1977	3	XJS	5343CC (5.3L)	1976-1992	4
XJ6L	4235CC (4.2L) DOHC	1974-1978	3	XJSC	5343CC (5.3L)	1987	4
XJ12	5343CC (5.3L)	1973-1974	4	XKE	5343CC (5.3L)	1971-1974	4

1	3590CC (3.6L) DOHC 6 Cyl, 3.583in./91mm (1988-1989)				1
----------	--	--	--	--	----------

Part	Year	VIN	Model/Application	Part Number	Qty.
ENGINE GASKETS					
Valve Cover Set	1988-1989		(Contains Valve Cover End Plugs) <i>Victo-Tech</i>	VS50283	1

2	3980CC (4.0L) DOHC 6 Cyl, 3.583in./91mm (1990-1994)				2
----------	--	--	--	--	----------

Part	Year	VIN	Model/Application	Part Number	Qty.
ENGINE GASKETS					
Valve Cover Set	1990-1994		(Contains Valve Cover End Plugs) <i>Victo-Tech</i>	VS50283	1

3	4235CC (4.2L) DOHC 6 Cyl, 3.622in./92mm (1974-1987)				3
----------	--	--	--	--	----------

Part	Year	VIN	Model/Application	Part Number	Qty.
ENGINE GASKETS					
Head Set	1980-1987			HS3958Y	1
	1974-1979		From Engine Serial Number 8L9081, (Valve Stem Seals Not Included)	HS3958W	1
Lower Set	1974-1987		(Requires Head Set And Valve Stem Seals To Make Full Set)	CS3958	1

3 4235CC (4.2L) DOHC 6 Cyl, 3.622in./92mm (1974-1987) **3**
(cont.) (cont.)

Part	Year	VIN	Model/Application	Part Number	Qty.
ENGINE GASKETS (cont.)					
Valve Cover Set	1974-1987			VS50282	1
Valve Stem Seal, Exh.	1974-1987			B45455	6
Valve Stem Seal, Int.	1974-1987			B45455	6
Manifold Set, Exhaust	1974-1987			MS15592	1
Manifold Set, Intake	1974-1987			MS15591	1
Oil Pan Set	1974-1987			OS30196	1
Timing Cover Seal	1974-1987			66697	1

4 5343CC (5.3L) V12 Cyl, 3.543in./90mm (1971-1992) **4**

Part	Year	VIN	Model/Application	Part Number	Qty.
ENGINE GASKETS					
Valve Cover Set	1971-1992		Right	VS50279	1
			Left	VS50280	1
Valve Stem Seal, Exh.	1973-1985			B45455	12
Valve Stem Seal, Int.	1973-1985			B45455	12
MISCELLANEOUS GASKETS					
Exhaust Pipe Gasket	1973-1992		Intermediate Muffler To Over Axle Pipe	F10111	2

Kaiser-Frazer

Engine Index

Engine	Year	Block
134 CID (2.2L) L-Head	1951-1953	1
226 CID (3.7L) Flat Head Continental	1947-1954	2

Model Index

Model	Engine	Year	Block	Model	Engine	Year	Block
Frazer	226 CID (3.7L) Flat Head Continental	1947-1951	2	Kaiser	226 CID (3.7L) Flat Head Continental	1947-1953	2
Henry J	134 CID (2.2L) L-Head	1951-1953	1				

1 134 CID (2.2L) L-Head 4 Cyl, 3.125in./79.4mm (1951-1953) **1**

Part	Year	VIN	Model/Application	Part Number	Qty.
ENGINE GASKETS					
Head Set	1951-1953			HS1023K	1
Full Set	1951-1953			FS1023KJ	1
Cylinder Head Gasket	1951-1953		VR2000	1023K	1
Manifold Set, Int. & Exh.	1951-1953			MS18632	1
Oil Pan Set	1951-1953		Cork Rubber	OS30656	1
Rear Main Seal Set	1951-1953			JV687	1
Timing Cover Set	1951-1953		From Serial Number 54100	JV797	1
			Thru Serial Number 54100	JV855	1
Timing Cover Seal	1951-1953		From Serial Number 54100	49575	1
MISCELLANEOUS GASKETS					
Exhaust Pipe Gasket	1951-1953		(Flange Type), Pipe To Manifold	F5360C	1
Fuel Pump Gasket	1951-1953			D27094	1
Push Rod Cover Set	1951-1953		Cork Rubber	VS38055	1
Water Pump Mount Gasket	1951-1953			K26226	1

2 226 CID (3.7L) Flat Head Continental 6 Cyl, 3.313in./84.1mm (1947-1954) **2**

Part	Year	VIN	Model/Application	Part Number	Qty.
ENGINE GASKETS					
Head Set	1947-1954			HS986SY	1

Kaiser-Frazer

2 (cont.)	226 CID (3.7L) Flat Head Continental 6 Cyl, 3.313in./84.1mm (1947-1954)				2 (cont.)
---------------------	--	--	--	--	---------------------

Part	Year	VIN	Model/Application	Part Number	Qty.
------	------	-----	-------------------	-------------	------

ENGINE GASKETS (cont.)

Full Set	1947-1954			FS986SY	1
Cylinder Head Gasket	1947-1954			986S	1
Valve Cover Set	1947-1954		Cork Rubber	VS38063	1
Manifold Set, Int. & Exh.	1947-1954			MS18651S	1
Oil Pan Set	1947-1954		Cork Rubber	OS20927	1
Rear Main Seal Set	1947-1954			JV663	1
Timing Cover Set	1947-1954			JV768	1
Timing Cover Seal	1947-1954			49575	1

MISCELLANEOUS GASKETS

Carb. Mount Gasket	1954		2 Barrel Carburetor	G7117	1
Exhaust Pipe Gasket	1947-1954		Pipe To Manifold	F5438AK	1
Fuel Pump Gasket	1947-1954			D27094	1

Kia

Engine Index

Engine	Year	Block
1597CC (1.6L) DOHC Mazda	1995-1997	1

Model Index

Model	Engine	Year	Block
Sephia	1597CC (1.6L) DOHC Mazda	1995-1997	1

1	1597CC (1.6L) DOHC Mazda 4 Cyl, 3.071in./78mm (1995-1997)				1
----------	--	--	--	--	----------

Part	Year	VIN	Model/Application	Part Number	Qty.
------	------	-----	-------------------	-------------	------

ENGINE GASKETS

Valve Cover Set	1995-1997		Sephia	Victo-Tech	VS50293	1
-----------------	-----------	--	--------	------------	---------	---

Lexus

Engine Index

Engine	Year	Block	Engine	Year	Block
2507CC (2.5L) 2VZFE DOHC Toyota	1990-1991	1	2995CC (3.0L) 1MZFE DOHC Toyota	1994-2003	3
2959CC (3.0L) 3VZFE DOHC Toyota	1992-1993	2	3969CC (4.0L) 1UZFE DOHC Toyota	1990-1994	4

Model Index

Model	Engine	Year	Block	Model	Engine	Year	Block
ES250	2507CC (2.5L) 2VZFE DOHC Toyota	1990-1991	1	LS400	3969CC (4.0L) 1UZFE DOHC Toyota	1990-2000	4
ES300	2959CC (3.0L) 3VZFE DOHC Toyota	1992-1993	2	SC400	3969CC (4.0L) 1UZFE DOHC Toyota	1992-2000	4
ES300	2995CC (3.0L) 1MZFE DOHC Toyota	1994-2003	3				

1	2507CC (2.5L) 2VZFE DOHC Toyota V6 Cyl, 3.445in./87.5mm (1990-1991)				1
----------	--	--	--	--	----------

Part	Year	VIN	Model/Application	Part Number	Qty.
------	------	-----	-------------------	-------------	------

ENGINE GASKETS

Head Set	1990-1991			HS5859	1
Full Set	1990-1991		(Oil Pan Gasket Not Included)	FS5859	1
Engine Kit Gasket Set	1990-1991			95-3282VR	1
Cylinder Head Gasket	1990-1991	Left	Nitroseal	5859	1
		Right	Nitroseal	5860	1
Cyl. Head Bolt Set	1990-1991			GS33353	2
Valve Cover Set	1990-1991	(Contains Valve Cover Washers, Contains Spark Plug Tube Seals)	Victo-Tech	VS50099	1
		(Single Valve Cover)	Victo-Tech	VS50099S	2
Valve Stem Seal, Exh.	1990-1991			B45657	12

1 (cont.)	2507CC (2.5L) 2VZFE DOHC Toyota V6 Cyl, 3.445in./87.5mm (1990-1991)					1 (cont.)
---------------------	--	--	--	--	--	---------------------

Part	Year	VIN	Model/Application	Part Number	Qty.
------	------	-----	-------------------	-------------	------

ENGINE GASKETS (cont.)

Valve Stem Seal, Int.	1990-1991			B45657	12
Manifold Set, Exhaust	1990-1991			MS15563	1
Manifold Set, Intake	1990-1991		(Contains Plenum Chamber Gasket)	MS15562	1
Oil Pan Set	1990-1991			<i>Silicone</i> JV6	1
				<i>Tuff-Cork</i> OS32095	1
Rear Main Seal	1990-1991			<i>Rubber</i> 67120	1
Timing Cover Set	1990-1991		(Contains Dust Seals, Camshaft Seals Not Included)	JV1108	1
				(Dust Seals Not Included, Camshaft Seals Not Included)	JV1145

MISCELLANEOUS GASKETS

Camshaft Seal	1990-1991			66905	2
E.G.R. Gasket	1990-1991			G31086	2
Exhaust Pipe Gasket	1990-1991		(Ring Type 'A')	F14594	1
Therm. Housing Gasket	1990-1991			C31087	1
Thermostat O-Ring	1990-1991		(O-Ring Type)	<i>Victo-Tech</i> C31090	1
Throttle Body Gasket	1990-1991			G31085	1

2	2959CC (3.0L) 3VZFE DOHC Toyota V6 Cyl, 3.445in./87.5mm (1992-1993)					2
----------	--	--	--	--	--	----------

Part	Year	VIN	Model/Application	Part Number	Qty.
------	------	-----	-------------------	-------------	------

ENGINE GASKETS

Head Set	1992-1993			HS5860	1
Lower Set	1992-1993		(Requires Head Set)	CS5860	1
Engine Kit Gasket Set	1992-1993			95-3459VR	1
Cylinder Head Gasket	1992-1993		Left	<i>Nitroseal</i> 5859	1
			Right	<i>Nitroseal</i> 5860	1
Valve Cover Set	1992-1993		(Contains Spark Plug Tube Seals)	<i>Victo-Tech</i> VS50158	1
Valve Stem Seal, Exh.	1992-1993			B45657	12
Valve Stem Seal, Int.	1992-1993			B45657	12
Manifold Set, Exhaust	1992-1993			MS16075	1
Manifold Set, Intake	1992-1993		(Contains Plenum Chamber Gasket)	MS16074	1
Plenum Chamber Gasket	1992-1993			MS16073	1
Oil Pan Set	1992-1993			<i>Cork Rubber</i> OS32122	1
Rear Main Seal	1992-1993			<i>Rubber</i> 67120	1
Timing Cover Set	1992-1993		(Dust Seals Not Included, Camshaft Seals Not Included)	JV1145	1
				(Contains Dust Seals, Camshaft Seals Not Included)	JV1170

MISCELLANEOUS GASKETS

Camshaft Seal	1992-1993			66905	2
E.G.R. Gasket	1992-1993		Valve	G31221	1
			(Inlet)	G31222	1
Exhaust Pipe Gasket	1992-1993		(Ring Type 'A'), Pipe To Manifold	F20252	2
Throttle Body Gasket	1992-1993			G31085	1
Valve Cover Grommet	1992-1993			B45809	16
Water Pump Mount Gasket	1992-1993			K31218	1

3	2995CC (3.0L) 1MZFE DOHC Toyota V6 Cyl, 3.445in./87.5mm (1994-2003)					3
----------	--	--	--	--	--	----------

Part	Year	VIN	Model/Application	Part Number	Qty.
------	------	-----	-------------------	-------------	------

ENGINE GASKETS

Head Set	1994-2003			HS54339	1
Lower Set	1994-2003			CS54339	1
Cylinder Head Gasket	1994-2003		Left	<i>Multi-Layered Steel</i> 54338	1
			Right	<i>Multi-Layered Steel</i> 54339	1
Valve Cover Set	1994-2003		(Contains Spark Plug Tube Seals)	VS50291	1
Manifold Gasket, Int.	1994-2003			MS16348	1

Lexus

3 (cont.)	2995CC (3.0L) 1MZFE DOHC Toyota V6 Cyl, 3.445in./87.5mm (1994-2003)				3 (cont.)
---------------------	--	--	--	--	---------------------

Part	Year	VIN	Model/Application	Part Number	Qty.
------	------	-----	-------------------	-------------	------

ENGINE GASKETS (cont.)

Plenum Chamber Gasket	1998-2003			MS16073	1
Oil Pan Set	1994-2003		<i>Cork Rubber</i>	OS32237	1
Rear Main Seal Set	1994-2003			JV1655	1
Timing Cover Set	1994-2003			JV1145	1
Timing Cover Seal	1998-2003			67010	1

MISCELLANEOUS GASKETS

Camshaft Seal	1994-2003			66905	2
Camshaft Seal Set	1994-2003			JV5023	1
Exhaust Pipe Gasket	1998-2001		Brazil Spec, Catalytic Converter To Center Pipe	F7460	1
			ES300, Brazil Spec, Inlet Pipe To Catalytic Converter	F7460	1
	1996-2001		Pipe To Manifold	F7572	2
	1995-1996		Catalytic Converter To Center Pipe	F7460	1
	1995		From 8/94, Pipe To Manifold	F7572	2
	1994		Thru 8/94, Pipe To Manifold	F20252	2
Fuel Inj. O-Ring	1998-2003			B45744	6
Fuel Injection Seal	2002		(Grommet), Injector To Fuel Rail	B45854	1
Thermostat O-Ring	1998-2003		<i>Victo-Tech</i>	C31090	1
Throttle Body Gasket	1994-2003			G31624	1
Water Pump Gasket	1994-2003			K31626	1

4	3969CC (4.0L) 1UZFE DOHC Toyota V8 Cyl, 3.445in./87.5mm (1990-1994)				4
----------	--	--	--	--	----------

Part	Year	VIN	Model/Application	Part Number	Qty.
------	------	-----	-------------------	-------------	------

ENGINE GASKETS

Head Set	1990-1994			HS5920	1
Lower Set	1990-1994		(Oil Pan Gasket Not Included, Requires Head Set To Make Full Set)	CS5920	1
Cylinder Head Gasket	1990-1994		Right <i>Nitroseal</i>	5920	1
			Left <i>Nitroseal</i>	5921	1
Valve Cover Set	1990-1994		(Contains Valve Cover Washers, Spark Plug Tube Seals Not Included) <i>Victo-Tech</i>	VS50167	1
Valve Stem Seal, Exh.	1990-1994			B45549	16
Valve Stem Seal, Int.	1990-1994			B45549	16
Manifold Set, Exhaust	1992-1994		SC400	MS16088	1
	1990-1994		LS400	MS16087	1
Manifold Set, Intake	1990-1994		(Contains Plenum Chamber Gasket)	MS16086	1
Plenum Chamber Gasket	1990-1994			MS12405	1
Oil Pan Set	1990-1994		<i>Cork Rubber</i>	OS32112	1
Rear Main Seal Set	1990-1994			JV1605	1
Timing Cover Set	1990-1994		(Dust Seals Not Included, Camshaft Seals Not Included)	JV1146	1
			(Contains Dust Seals, Camshaft Seals Not Included)	JV1148	1

MISCELLANEOUS GASKETS

Camshaft Seal	1990-1994			66905	2
E.G.R. Gasket	1990-1994			GS31237	1
Exhaust Pipe Gasket	1990-1994		(Ring Type 'A'), Pipe To Manifold	F7459	1
Spark Plug Tube Seal	1990-1994			B45778	8
Therm. Housing Gasket	1992-1994		SC400	C31249	4
Thermostat O-Ring	1990-1994		(O-Ring Type) <i>Victo-Tech</i>	C31090	1
Throttle Body Gasket	1990-1994			G31236	1
Water Pump Mount Gasket	1990-1994		Water Inlet	K31257	1

Engine Index

Engine	Year	Block
948CC (0.9L) OHV	1961-1962	1
1098CC (1.1L)	1963-1967	2
1275CC (1.3L)	1968-1974	3

Engine	Year	Block
1493CC (1.5L)	1975-1979	4
1798CC (1.8L)	1963-1980	5

Model Index

Model	Engine	Year	Block
1100	1098CC (1.1L)	1963-1967	2
MGB	1798CC (1.8L)	1963-1980	5
MGB GT	1798CC (1.8L)	1966-1974	5
Midget MK I	948CC (0.9L) OHV	1961-1962	1

Model	Engine	Year	Block
Midget MK I	1098CC (1.1L)	1963-1964	2
Midget MK II	1098CC (1.1L)	1964-1966	2
Midget MK III	1275CC (1.3L)	1967-1974	3
Midget MK IV	1493CC (1.5L)	1975-1980	4

1 948CC (0.9L) OHV 4 Cyl, 2.478in./62.9mm (1961-1962) 1

Part	Year	VIN	Model/Application	Part Number	Qty.
------	------	-----	-------------------	-------------	------

ENGINE GASKETS

Head Set	1961-1962			HS3611	1
Valve Cover Set	1961-1962			VS30025	1
Manifold Set, Int. & Exh.	1961-1962			MS15243	1
Timing Cover Seal	1961-1962			66550	1

MISCELLANEOUS GASKETS

Water Outlet Gasket	1961-1962			C24093	1
---------------------	-----------	--	--	--------	---

2 1098CC (1.1L) 4 Cyl, 2.539in./64.5mm (1963-1967) 2

Part	Year	VIN	Model/Application	Part Number	Qty.
------	------	-----	-------------------	-------------	------

ENGINE GASKETS

Head Set	1963-1967			HS3611	1
Valve Cover Set	1963-1967			VS30025	1
Manifold Set, Int. & Exh.	1963-1967			MS15243	1
Timing Cover Seal	1963-1967			66550	1

MISCELLANEOUS GASKETS

Push Rod Cover Set	1963-1967			PS20316	1
Water Outlet Gasket	1963-1967			C24093	1

3 1275CC (1.3L) 4 Cyl, 2.780in./70.6mm (1968-1974) 3

Part	Year	VIN	Model/Application	Part Number	Qty.
------	------	-----	-------------------	-------------	------

ENGINE GASKETS

Head Set	1968-1974			HS3612	1
Lower Set	1968-1974		(Requires Head Set To Make Full Set)	CS3612	1
Cylinder Head Gasket	1968-1974			3612	1
Valve Cover Set	1968-1974			VS30025	1
Manifold Set, Int. & Exh.	1968-1974			MS15243	1
Oil Pan Set	1968-1974			OS20059	1
Timing Cover Seal	1968-1974			66550	1

MISCELLANEOUS GASKETS

Push Rod Cover Set	1968-1974			PS20316	1
Water Outlet Gasket	1968-1974			C24093	1

4 1493CC (1.5L) 4 Cyl, 2.900in./73.6mm (1975-1979) 4

Part	Year	VIN	Model/Application	Part Number	Qty.
------	------	-----	-------------------	-------------	------

ENGINE GASKETS

Head Set	1975-1979			HS3622	1
Lower Set	1975-1979		(Requires Head Set And Timing Cover Set And Rear Main Seal To Make Full Set)	CS3622	1
Cylinder Head Gasket	1975-1979			3622	1
Valve Cover Set	1975-1979			VS30028	1

MG

4 (cont.)	1493CC (1.5L) 4 Cyl, 2.900in./73.6mm (1975-1979)				4 (cont.)
---------------------	---	--	--	--	---------------------

Part	Year	VIN	Model/Application	Part Number	Qty.
ENGINE GASKETS (cont.)					
Manifold Set, Int. & Exh.	1975-1979			MS15235	1
Oil Pan Set	1975-1979		Cork Rubber	OS20064	1
Rear Main Seal	1975-1979		Rubber	66738	1
Timing Cover Set	1975-1979			JV947	1

MISCELLANEOUS GASKETS					
Push Rod Cover Set	1975-1979			PS20316	1
Water Outlet Gasket	1975-1979			C26651	1

5	1798CC (1.8L) 4 Cyl, 3.159in./80.3mm (1963-1980)				5
----------	---	--	--	--	----------

Part	Year	VIN	Model/Application	Part Number	Qty.
ENGINE GASKETS					
Head Set	1975-1980			HS3614W	1
	1963-1974			HS3614	1
Lower Set	1963-1980		(Requires Head Set And Timing Cover Seal And Rear Main Seal To Make Full Set)	CS3614	1
Cylinder Head Gasket	1963-1980			3614	1
Valve Cover Set	1963-1980			VS30026	1
Valve Stem Seal, Exh.	1963-1980			B45493	4
Valve Stem Seal, Int.	1963-1980			B45493	4
Oil Pan Set	1963-1980			OS20063	1
Rear Main Seal	1963-1980		Rubber	66746	1
Timing Cover Seal	1963-1980			66550	1

MISCELLANEOUS GASKETS					
Push Rod Cover Set	1963-1980			PS20316	1
Water Outlet Gasket	1963-1980			C24093	1

Mazda

Engine Index

Engine	Year	Block	Engine	Year	Block
1146CC (1.1L) 12A	1979-1982	1	1839CC (1.8L) DOHC (BPD)	1990-1998	14
1272CC (1.3L) TC SOHC	1977-1978	2	1839CC (1.8L) SOHC (BPE)	1990-1995	15
1415CC (1.4L) UC SOHC	1979-1980	3	1970CC (2.0L) MA SOHC	1979-1982	16
1489CC (1.5L) Z5-DE DOHC	1995-1998	4	1991CC (2.0L) FS-ZE DOHC	1993-2003	17
1490CC (1.5L) E5 SOHC	1981-1985	5	1998CC (2.0L) FE SOHC	1983-1987	18
1586CC (1.6L) NA SOHC	1970-1977	6	1998CC (2.0L) RF SOHC Diesel	1984-1985	19
1597CC (1.6L) B6 SOHC 16 Valve	1992-1995	7	2184CC (2.2L) F2 SOHC	1988-1992	20
1597CC (1.6L) B6B SOHC 8 Valve	1986-1995	8	2497CC (2.5L) KL-ZE DOHC	1993-2002	21
Non-Turbo			2954CC (3.0L) JE06 SOHC	1988-1989	22
1597CC (1.6L) B6E DOHC 16 Valve Turbo	1988-1989	9	2954CC (3.0L) JE07 SOHC	1988-1989	23
1597CC (1.6L) B6ZE DOHC 16 Valve	1990-2003	10	2954CC (3.0L) JE27 DOHC	1990-1991	24
1796CC (1.8L) VB SOHC	1972-1973	11	2954CC (3.0L) JE39 SOHC	1990-1991	25
1839CC (1.8L) DOHC (FP-DE)	1999-2000	12	2954CC (3.0L) JE48 DOHC	1992-1995	26
1839CC (1.8L) DOHC (BP-ZE)	1994-2003	13			

Model Index

Model	Engine	Year	Block	Model	Engine	Year	Block
323	1597CC (1.6L) B6 SOHC 16 Valve	1992-1995	7	626	1998CC (2.0L) FE SOHC	1983-1987	18
	1597CC (1.6L) B6E DOHC 16 Valve Turbo	1988-1989	9	626	2184CC (2.2L) F2 SOHC	1988-1992	20
323	1597CC (1.6L) B6B SOHC 8 Valve Non-Turbo	1986-1995	8	626	2497CC (2.5L) KL-ZE DOHC	1993-2002	21
	1597CC (1.6L) B6E DOHC 16 Valve Turbo	1988-1989	9	808	1272CC (1.3L) TC SOHC	1976-1977	2
616	1586CC (1.6L) NA SOHC	1970-1972	6	808	1586CC (1.6L) NA SOHC	1972-1977	6
618	1796CC (1.8L) VB SOHC	1972-1973	11	929	2954CC (3.0L) JE48 DOHC	1992-1995	26
626	1970CC (2.0L) MA SOHC	1979-1982	16	929	2954CC (3.0L) JE27 DOHC	1990-1991	24
626	1991CC (2.0L) FS-ZE DOHC	1993-2002	17	929	2954CC (3.0L) JE39 SOHC	1990-1991	25
626	1998CC (2.0L) RF SOHC Diesel	1984-1985	19	929	2954CC (3.0L) JE06 SOHC	1988-1989	22
				929	2954CC (3.0L) JE07 SOHC	1988-1989	23
				GLC	1272CC (1.3L) TC SOHC	1977-1978	2

Model Index (cont.)

Model	Engine	Year	Block	Model	Engine	Year	Block
GLC	1415CC (1.4L) UC SOHC	1979-1980	3	Miata MX5	1839CC (1.8L) DOHC (BP-ZE)	1994-2004	13
GLC	1490CC (1.5L) E5 SOHC	1981-1985	5	Millenia	2497CC (2.5L) KL-ZE DOHC	1995-2002	21
MX3	1597CC (1.6L) B6 SOHC 16 Valve	1992-1993	7	Protege	1489CC (1.5L) Z5-DE DOHC	1995-1998	4
MX3	1597CC (1.6L) B6ZE DOHC 16 Valve	1994-1995	10	Protege	1597CC (1.6L) B6ZE DOHC 16 Valve	1999-2003	10
MX6	1991CC (2.0L) FS-ZE DOHC	1993-1997	17	Protege	1839CC (1.8L) DOHC (FP-DE)	1999-2000	12
MX6	2184CC (2.2L) F2 SOHC	1988-1992	20	Protege	1839CC (1.8L) DOHC (BPD)	1990-1998	14
MX6	2497CC (2.5L) KL-ZE DOHC	1993-1997	21	Protege	1839CC (1.8L) SOHC (BPE)	1990-1995	15
Miata MX5	1597CC (1.6L) B6ZE DOHC 16 Valve	1990-1993	10	Protege	1991CC (2.0L) FS-ZE DOHC	2001-2003	17
				RX7	1146CC (1.1L) 12A	1979-1985	1

1 1146CC (1.1L) 12A 2 Rtr Rotary, in./mm (1979-1982) 1

Part	Year	VIN	Model/Application	Part Number	Qty.
------	------	-----	-------------------	-------------	------

MISCELLANEOUS GASKETS

Exhaust Pipe Gasket	1981-1982		RX7, Pipe To Manifold	F12385	1
	1979-1980		RX7, Catalytic Converter To Exhaust Pipe	F10107	1
			RX7, Air Pipe To Resonator	F12386	1

2 1272CC (1.3L) TC SOHC 4 Cyl, 2.874in./73mm (1977-1978) 2

Part	Year	VIN	Model/Application	Part Number	Qty.
------	------	-----	-------------------	-------------	------

ENGINE GASKETS

Head Set	1977-1978			HS3662	1
Full Set	1977-1978			FS3662	1
Cylinder Head Gasket	1977-1978			3662	1
Valve Cover Set	1977-1978		Cork Rubber	VS30203	1
Valve Stem Seal, Exh.	1977-1978			B45437	4
Valve Stem Seal, Int.	1977-1978			B45437	4
Manifold Set, Exhaust	1977-1978			MS15288	1
Manifold Set, Intake	1977-1978			MS15287	1
Oil Pan Set	1977-1978		Cork Rubber	OS30204	1
Rear Main Seal Set	1977-1978			JV503	1
Timing Cover Set	1977-1978			JV973	1

MISCELLANEOUS GASKETS

Cam. Semi-Circular Plug	1977-1978		(Half Round)	B45464	2
Carb. Mount Gasket	1977-1978		2 Barrel Carburetor	G31153	2
Distributor Seal	1977-1978		(O-Ring Type)	B45781	1
E.G.R. Gasket	1977-1978			G24843	1
Exhaust Pipe Gasket	1977-1978		(Flange Type), Pipe To Manifold	F20282	1
Fuel Pump Gasket	1977-1978			D20208	2
Water Outlet Gasket	1977-1978		(2 Holes) Victopac	C20115	1
Water Pump Backing Plate	1977-1978			K27136	1
Water Pump Mount Gasket	1977-1978			K20207	1

3 1415CC (1.4L) UC SOHC 4 Cyl, 3.031in./77mm (1979-1980) 3

Part	Year	VIN	Model/Application	Part Number	Qty.
------	------	-----	-------------------	-------------	------

ENGINE GASKETS

Head Set	1979-1980			HS3698	1
Full Set	1979-1980			FS3698	1
Cylinder Head Gasket	1979-1980			3698	1
Valve Cover Set	1979-1980		Cork Rubber	VS30203	1
Valve Stem Seal, Exh.	1980			B45490	4
	1979			B45437	4
Valve Stem Seal, Int.	1980			B45490	4
	1979			B45437	4
Manifold Set, Exhaust	1979-1980			MS15288	1

Mazda

3 (cont.)	1415CC (1.4L) UC SOHC 4 Cyl, 3.031in./77mm (1979-1980)	3 (cont.)
---------------------	---	---------------------

Part	Year	VIN	Model/Application	Part Number	Qty.
------	------	-----	-------------------	-------------	------

ENGINE GASKETS (cont.)

Manifold Set, Intake	1979-1980			MS15287	1
Oil Pan Set	1979-1980		Cork Rubber	OS30204	1
Rear Main Seal Set	1979-1980			JV503	1
Timing Cover Set	1979-1980			JV973	1

MISCELLANEOUS GASKETS

Cam. Semi-Circular Plug	1979-1980		(Half Round)	B45464	2
Carb. Mount Gasket	1979-1980		2 Barrel Carburetor	G31153	2
Distributor Seal	1979-1980		(O-Ring Type)	B45781	1
E.G.R. Gasket	1979-1980			G24843	1
Exhaust Pipe Gasket	1979-1980		Except California With Automatic Transmission	F10064	1
			Automatic Transmission, California	F20282	1
Fuel Pump Gasket	1979-1980			D20208	2
Water Outlet Gasket	1979-1980		(2 Holes) Victopac	C20115	1
Water Pump Mount Gasket	1979-1980			K20207	1

4	1489CC (1.5L) Z5-DE DOHC 4 Cyl, 2.965in./75.3mm (1995-1998)	4
----------	--	----------

Part	Year	VIN	Model/Application	Part Number	Qty.
------	------	-----	-------------------	-------------	------

ENGINE GASKETS

Valve Cover Set	1995-1998			Victo-Tech	VS50295	1
Oil Pan Set	1995-1998		(Requires RTV)	Victo-Tech	OS32085	1
Rear Main Seal	1995-1998				66977	1

MISCELLANEOUS GASKETS

Camshaft Seal	1995-1998		Front	66864	2
E.G.R. Gasket	1995-1998		Valve	G31229	1
Exhaust Pipe Gasket	1995-1998		Catalytic Converter To Center Pipe	F16221	1
Fuel Inj. O-Ring	1995-1998			B45744	4
Fuel Reg. O-Ring	1995-1998			B45744	1
Oil Pump Seal	1995-1998		(O-Ring Type)	B45858	1
Throttle Body Gasket	1995-1997		Protege	G31578	1
Water Pump Gasket	1995-1998		Inlet	K30740	1

5	1490CC (1.5L) E5 SOHC 4 Cyl, 3.031in./77mm (1981-1985)	5
----------	---	----------

Part	Year	VIN	Model/Application	Part Number	Qty.
------	------	-----	-------------------	-------------	------

ENGINE GASKETS

Head Set	1981-1985		Station Wagon	HS3698	1
			Hatchback, Sedan	HS3731	1
Full Set	1981-1985		Station Wagon, (Oil Pan Gasket Not Included)	FS3698	1
			Hatchback, Sedan	FS3731	1
Engine Kit Gasket Set	1981-1985		Front Wheel Drive	95-3124VR	1
Cylinder Head Gasket	1981-1985		Station Wagon	3698	1
			Hatchback, Sedan	3731	1
Valve Cover Set	1981-1985		Station Wagon Cork Rubber	VS30203	1
			Hatchback, Sedan Victo-Tech	VS38353	1
Valve Stem Seal, Exh.	1981-1985			B45490	4
Valve Stem Seal, Int.	1981-1985			B45490	4
Manifold Set, Exhaust	1981-1985		Hatchback, Sedan	MS12292	1
			Station Wagon	MS15288	1
Manifold Set, Intake	1981-1985		Hatchback, Sedan	MS12293	1
			Station Wagon	MS15287	1
Oil Pan Set	1981-1985		Station Wagon Cork Rubber	OS30204	1
			Hatchback, Sedan Cork Rubber	OS30581	1
Rear Main Seal Set	1981-1985			JV503	1
Timing Cover Set	1981-1985		Station Wagon	JV973	1

5 (cont.)	1490CC (1.5L) E5 SOHC 4 Cyl, 3.031in./77mm (1981-1985)				5 (cont.)
---------------------	---	--	--	--	---------------------

Part	Year	VIN	Model/Application	Part Number	Qty.
------	------	-----	-------------------	-------------	------

ENGINE GASKETS (cont.)

Timing Cover Set (cont.)	1981-1985		Hatchback, Sedan	JV981	1
--------------------------	-----------	--	------------------	-------	---

MISCELLANEOUS GASKETS

Cam. Semi-Circular Plug	1981-1985		(Half Round)	B45464	2
Carb. Mount Gasket	1981-1985		2 Barrel Carburetor	G30737	2
Distributor Seal	1981-1985		(O-Ring Type)	B45781	1
E.G.R. Gasket	1983-1985			G30702	1
Exhaust Pipe Gasket	1981-1985		(Flange Type), Pre-Catalytic Converter To Exhaust Pipe	F7393	1
			(Flange Type), Manifold To Pre-Catalytic Converter	F7416	1
			(Flange Type), Catalytic Converter To Exhaust Pipe	F7476	2
Fuel Pump Gasket	1981-1985		Station Wagon	D20208	2
Water Outlet Gasket	1981-1985		(2 Holes) <i>Victopac</i>	C20115	1
Water Pump Mount Gasket	1981-1985		Station Wagon	K20207	1
			Hatchback, Sedan, Pump To Cover	K27400	1
			Hatchback, Sedan, Pump To Block	K30731	1

6	1586CC (1.6L) NA SOHC 4 Cyl, 3.071in./78mm (1970-1977)				6
----------	---	--	--	--	----------

Part	Year	VIN	Model/Application	Part Number	Qty.
------	------	-----	-------------------	-------------	------

ENGINE GASKETS

Head Set	1970-1977			HS3683	1
Full Set	1970-1977			FS3683	1
Engine Kit Gasket Set	1970-1977		(Exhaust Manifold Gasket Not Included), Use With Part Number MS85718	95-3366VR	1
Cylinder Head Gasket	1970-1977		<i>Nitroseal</i>	3683	1
Cyl. Head Spacer Shim	1970-1977		Requires Sealing Compound <i>Steel</i>	3683S	1
Sealing Compound	1970-1977		(4 Ounce Brush Top Can)	JV66B	1
			(12 Ounce Spray Can)	JV66S	1
Valve Cover Set	1970-1977		(Half Round Camshaft Seal Not Included) <i>Cork Rubber</i>	VS39754	1
			(Contains Half-Round Camshaft Seal) <i>Cork Rubber</i>	VS39754W	1
			(Half Round Camshaft Seal Not Included) <i>Victo-Tech</i>	VS50144	1
Valve Stem Seal, Exh.	1971-1977			B45437	4
Valve Stem Seal, Int.	1971-1977			B45437	4
Manifold Set, Exhaust	1970-1977			MS85718	1
Manifold Set, Intake	1970-1977			MS85719	1
Oil Pan Set	1970-1977		<i>Cork Rubber</i>	OS30548	1
Rear Main Seal Set	1970-1977			JV627	1
Timing Cover Set	1970-1977			JV963	1

MISCELLANEOUS GASKETS

Cam. Semi-Circular Plug	1970-1977		(Half Round)	B45450	2
Carb. Mount Gasket	1971-1977		2 Barrel Carburetor	G26825	2
Distributor Seal	1970-1977		(O-Ring Type)	B45781	1
Exhaust Pipe Gasket	1971-1977		(Flange Type), Pipe To Manifold	F7393	1
	1970		(Flange Type), Pipe To Manifold	F20252	1
Water Outlet Gasket	1970-1977			C20136	1
Water Pump Mount Gasket	1970-1977			K20222	1

7	1597CC (1.6L) B6 SOHC 16 Valve 4 Cyl, 3.071in./78mm (1992-1995)				7
----------	--	--	--	--	----------

Part	Year	VIN	Model/Application	Part Number	Qty.
------	------	-----	-------------------	-------------	------

ENGINE GASKETS

Lower Set	1992-1995		(Requires Head Set To Make Full Set)	CS5878	1
Sealing Compound	1992-1995		(4 Ounce Brush Top Can)	JV66B	1

Mazda

7 (cont.)	1597CC (1.6L) B6 SOHC 16 Valve 4 Cyl, 3.071in./78mm (1992-1995)				7 (cont.)
---------------------	--	--	--	--	---------------------

<i>Part</i>	<i>Year</i>	<i>VIN</i>	<i>Model/Application</i>	<i>Part Number</i>	<i>Qty.</i>
ENGINE GASKETS (cont.)					
Sealing Compound (cont.)	1992-1995		(12 Ounce Spray Can)	JV66S	1
Valve Cover Set	1992-1995		<i>Victo-Tech</i>	VS50133	1
Valve Stem Seal, Exh.	1992-1995			B45549	8
Valve Stem Seal, Int.	1992-1995			B45549	8
Plenum Chamber Gasket	1992-1995		California	MS14805	1
			Except California	MS15645	1
Oil Pan Set	1992-1995		(Requires RTV) <i>Victo-Tech</i>	OS32096	1
Rear Main Seal	1992-1995		(Requires RTV)	66977	1
Timing Cover Set	1992-1995			JV1044	1

MISCELLANEOUS GASKETS					
Camshaft Seal	1992-1995			47699	1
Exhaust Pipe Gasket	1992-1995		(Flange Type), Pipe To Manifold	F7473	1
Oil Pump Inlet Tube	1992-1995			B45718	1
Oil Pump Mounting Gasket	1992-1995			L45680	1
Thermostat O-Ring	1992-1995		(O-Ring Type) <i>Victo-Tech</i>	B45661	1
Throttle Body Gasket	1992-1995			G31190	1
Water Outlet Gasket	1992-1995		(2 Holes) <i>Victopac</i>	C20115	1
Water Pump Gasket	1992-1995		Inlet	K30740	1
Water Pump Mount Gasket	1992-1995			K30739	1

8	1597CC (1.6L) B6B SOHC 8 Valve Non-Turbo 4 Cyl, 3.071in./78mm (1986-1995)				8
----------	--	--	--	--	----------

<i>Part</i>	<i>Year</i>	<i>VIN</i>	<i>Model/Application</i>	<i>Part Number</i>	<i>Qty.</i>
ENGINE GASKETS					
Head Set	1990-1995			HS5877	1
	1986-1989			HS5736	1
Lower Set	1990-1995		(Requires Head Set To Make Full Set)	CS5878	1
Full Set	1990-1995			FS5877	1
	1986-1989			FS5736	1
Engine Kit Gasket Set	1986-1989			95-3197VR	1
Cylinder Head Gasket	1990-1995		<i>Nitroseal</i>	5877	1
	1986-1989		<i>Nitroseal</i>	5736	1
Cyl. Head Spacer Shim	1990-1995		Requires Sealing Compound <i>Steel</i>	5877S	1
	1986-1989		Requires Sealing Compound <i>Steel</i>	5736S	1
Sealing Compound	1986-1995		(4 Ounce Brush Top Can)	JV66B	1
			(12 Ounce Spray Can)	JV66S	1
Valve Cover Set	1990-1995		<i>Victo-Tech</i>	VS50133	1
	1986-1989		<i>Victo-Tech</i>	VS50037	1
Valve Stem Seal, Exh.	1986-1995			B45588	4
Valve Stem Seal, Int.	1986-1995			B45588	4
Manifold Set, Exhaust	1990-1995			MS12377	1
	1986-1989			MS12322	1
Manifold Set, Intake	1990-1995		(Contains Plenum Chamber Gasket)	MS15644	1
	1986-1989		(Contains Plenum Chamber Gasket)	MS12321	1
Plenum Chamber Gasket	1990-1995			MS15645	1
	1986-1989			MS12347	1
Oil Pan Set	1990-1995		(Requires RTV) <i>Victo-Tech</i>	OS32096	1
	1986-1989		<i>Victo-Tech</i>	OS32475	1
Rear Main Seal	1990-1995			66977	1
Rear Main Seal Set	1986-1989			JV559	1
Timing Cover Set	1986-1995			JV1044	1

8 (cont.)	1597CC (1.6L) B6B SOHC 8 Valve Non-Turbo 4 Cyl, 3.071in./78mm (1986-1995)				8 (cont.)
---------------------	--	--	--	--	---------------------

Part	Year	VIN	Model/Application	Part Number	Qty.
MISCELLANEOUS GASKETS					
Camshaft Seal	1986-1995			47699	1
E.G.R. Gasket	1986-1987			G30741	1
Exhaust Pipe Gasket	1990-1995		(Flange Type), Pipe To Manifold	F7473	1
	1986-1989		(Flange Type), Pipe To Manifold	F7393	1
				Catalytic Converter To Exhaust Pipe	F7476
Fuel Pump Gasket	1986-1989			D20208	2
Oil Pump Inlet Tube	1986-1995			B45718	1
Oil Pump Mounting Gasket	1986-1993			L45680	1
Thermostat O-Ring	1990-1995		<i>Victo-Tech</i>	B45661	1
Throttle Body Gasket	1990-1995			G31181	1
	1986-1989			G30952	2
Valve Cover Grommet	1986-1989			B45795	6
Water Outlet Gasket	1986-1995		(2 Holes) <i>Victopac</i>	C20115	1
Water Pump Gasket	1986-1995		Inlet	K30740	1
Water Pump Mount Gasket	1986-1995			K30739	1

9	1597CC (1.6L) B6E DOHC 16 Valve Turbo 4 Cyl, 3.071in./78mm (1988-1989)				9
----------	---	--	--	--	----------

Part	Year	VIN	Model/Application	Part Number	Qty.
ENGINE GASKETS					
Cylinder Head Gasket	1988-1989		<i>Nitroseal</i>	5868	1
Cyl. Head Spacer Shim	1988-1989		Requires Sealing Compound <i>Steel</i>	5868S	1
Sealing Compound	1988-1989		(4 Ounce Brush Top Can)	JV66B	1
			(12 Ounce Spray Can)	JV66S	1
Valve Cover Set	1988-1989		<i>Victo-Tech</i>	VS50219	1
Manifold Set, Exhaust	1988-1989		<i>Multi-Layered Steel</i>	MS15633	1
Oil Pan Set	1988-1989		(Requires RTV) <i>Victo-Tech</i>	OS32085	1
Rear Main Seal Set	1988-1989			JV559	1
Timing Cover Set	1988-1989			JV1044	1

MISCELLANEOUS GASKETS					
Camshaft Seal	1988-1989			66864	1
Oil Pump Inlet Tube	1988-1989			B45718	1
Oil Pump Mounting Gasket	1988-1989			L45680	1
Water Outlet Gasket	1988-1989		(2 Holes) <i>Victopac</i>	C20115	1
Water Pump Gasket	1988-1989		Inlet	K30740	1
Water Pump Mount Gasket	1988-1989			K30739	1

10	1597CC (1.6L) B6ZE DOHC 16 Valve 4 Cyl, 3.071in./78mm (1990-2003)				10
-----------	--	--	--	--	-----------

Part	Year	VIN	Model/Application	Part Number	Qty.
ENGINE GASKETS					
Head Set	1990-1993			HS5868	1
Full Set	1990-1993		(Requires RTV)	FS5868	1
Cylinder Head Gasket	1990-1993		<i>Nitroseal</i>	5868	1
Cyl. Head Spacer Shim	1990-1993		Requires Sealing Compound <i>Steel</i>	5868S	1
Sealing Compound	1990-1993		(4 Ounce Brush Top Can)	JV66B	1
			(12 Ounce Spray Can)	JV66S	1
Valve Cover Set	1994-1995		<i>Victo-Tech</i>	VS50293	1
	1990-1993		<i>Victo-Tech</i>	VS50109	1
Valve Stem Seal, Exh.	2001-2003			B45549	8
	1990-1993			B45549	8
Valve Stem Seal, Int.	1990-1993			B45549	8

Mazda

10 (cont.)	1597CC (1.6L) B6ZE DOHC 16 Valve 4 Cyl, 3.071in./78mm (1990-2003)					10 (cont.)
----------------------	--	--	--	--	--	----------------------

Part	Year	VIN	Model/Application	Part Number	Qty.
------	------	-----	-------------------	-------------	------

ENGINE GASKETS (cont.)

Manifold Set, Exhaust	1990-1993		<i>Multi-Layered Steel</i>	MS15633	1
Manifold Set, Intake	1990-1993			MS15631	1
Oil Pan Set	1990-1993		(Requires RTV) <i>Victo-Tech</i>	OS32085	1
Rear Main Seal	2001-2003			66977	1
	1990-1993		(Requires RTV)	66977	1
Timing Cover Set	1990-1993		(Camshaft Seals Not Included)	JV1112	1

MISCELLANEOUS GASKETS

Camshaft Seal	2001-2003			66864	2
	1990-1993			66864	2
Exhaust Pipe Gasket	1990-1993		(Flange Type), Pipe To Manifold	F7485	1
Oil Pump Inlet Tube	1990-1993			B45718	1
Oil Pump Mounting Gasket	1990-1993			L45680	1
Oil Pump Seal	2001-2003			67602	1
Therm. Housing Gasket	2001-2003		<i>Victopac</i>	C20115	1
Thermostat O-Ring	1990-1993		(O-Ring Type) <i>Victo-Tech</i>	B45661	1
Throttle Body Gasket	1990-1993			G31081	1
Water Outlet Gasket	1990-1993		(2 Holes) <i>Victopac</i>	C20115	1
Water Pump Gasket	2001-2003			K30740	1
	1990-1993		Inlet	K30740	1
Water Pump Mount Gasket	1990-1993			K30739	1

11	1796CC (1.8L) VB SOHC 4 Cyl, 3.071in./78mm (1972-1973)					11
-----------	---	--	--	--	--	-----------

Part	Year	VIN	Model/Application	Part Number	Qty.
------	------	-----	-------------------	-------------	------

ENGINE GASKETS

Engine Kit Gasket Set	1972-1973		(Exhaust Manifold Gasket Not Included), Use With Part Number MS85718	95-3366VR	1
-----------------------	-----------	--	--	------------------	---

12	1839CC (1.8L) DOHC (FP-DE) 4 Cyl, 3.268in./83mm (1999-2000)					12
-----------	--	--	--	--	--	-----------

Part	Year	VIN	Model/Application	Part Number	Qty.
------	------	-----	-------------------	-------------	------

ENGINE GASKETS

Cylinder Head Gasket	1999-2000		<i>Multi-Layered Steel</i>	5942	1
Valve Stem Seal, Exh.	1999-2000			B45549	8
Valve Stem Seal, Int.	1999-2000			B45866	8
Timing Cover Seal	1999-2000		<i>Rubber</i>	JV5002	1

MISCELLANEOUS GASKETS

Camshaft Seal	1999-2000			66864	2
E.G.R. Gasket	1999-2000			G31229	1
Exhaust Pipe Gasket	1999-2000		(Flange Type), Pipe To Manifold	F16221	1
Oil Pump Inlet Tube	1999-2000		(O-Ring Type), Pump To Housing	B45719	1
Throttle Body Gasket	1999-2000			G31436	1
Water Outlet Gasket	1999-2000			C31307	1

13	1839CC (1.8L) DOHC (BP-ZE) 4 Cyl, 3.268in./83mm (1994-2003)					13
-----------	--	--	--	--	--	-----------

Part	Year	VIN	Model/Application	Part Number	Qty.
------	------	-----	-------------------	-------------	------

ENGINE GASKETS

Head Set	1994-1995		(Exhaust Pipe Flange Gasket Not Included)	HS5878	1
Cylinder Head Gasket	1999-2000		<i>Multi-Layered Steel</i>	5878	1
	1994-1997		<i>Multi-Layered Steel</i>	5878	1
Cyl. Head Spacer Shim	1999-2000		Requires Sealing Compound <i>Steel</i>	5878S	1
	1994-1997		Requires Sealing Compound <i>Steel</i>	5878S	1

13 1839CC (1.8L) DOHC (BP-ZE) 4 Cyl, 3.268in./83mm (1994-2003)

(cont.)

13

(cont.)

Part	Year	VIN	Model/Application	Part Number	Qty.
ENGINE GASKETS (cont.)					
Sealing Compound	1999-2000		(4 Ounce Brush Top Can)	JV66B	1
			(12 Ounce Spray Can)	JV66S	1
	1994-1997		(4 Ounce Brush Top Can)	JV66B	1
			(12 Ounce Spray Can)	JV66S	1
Valve Cover Set	1999-2000		<i>Victo-Tech</i>	VS50135	1
	1994-1997		<i>Victo-Tech</i>	VS50135	1
Valve Stem Seal, Exh.	1999-2003			B45549	8
	1994-1997			B45549	8
Valve Stem Seal, Int.	1994-1997			B45549	8
Manifold Set, Exhaust	1994-1997		<i>Multi-Layered Steel</i>	MS15646	1
Manifold Set, Intake	1994-1997		(Contains Plenum Chamber Gasket)	MS15647	1
Plenum Chamber Gasket	1994-1997			MS14755	1
Oil Pan Set	2001-2003		(Requires RTV)	OS32096	1
	1999-2000		(Requires RTV) <i>Victo-Tech</i>	OS32085	1
	1994-1997		(Requires RTV) <i>Victo-Tech</i>	OS32085	1
Rear Main Seal	1999-2003		(Requires RTV)	66977	1
	1994-1997		(Requires RTV)	66977	1
Timing Cover Set	1999-2003			JV1206	1
	1994-1997			JV1206	1
Timing Cover Seal	1999-2003			JV1206	1

MISCELLANEOUS GASKETS

Camshaft Seal	2001-2003		Intake	66864	1
	1999-2003			66864	2
	1994-1997			66864	2
E.G.R. Gasket	1999-2003		Valve	G31229	1
	1994-1997		Valve	G31229	1
Exhaust Pipe Gasket	1994-1997		(Flange Type), Pipe To Manifold	F7485	1
			(Flange Type), Catalytic Converter To Exhaust Pipe	F7486	2
Fuel Inj. O-Ring	2003			B45744	4
	1999-2003		Upper	B45744	4
	1994-1997		Upper	B45744	4
Fuel Reg. O-Ring	1999-2003			B45744	1
Oil Pump Seal	1999-2003		(O-Ring Type)	B45858	1
Throttle Body Gasket	1999-2003			G31578	1
	1994-1997			G31578	1
Water Outlet Gasket	1999-2003		(2 Holes) <i>Victopac</i>	C20115	1
	1994-1997		(2 Holes) <i>Victopac</i>	C20115	1
Water Pipe O-Ring	1999-2003			B45661	1
	1994-1997			B45661	1
Water Pump Gasket	1999-2003		Inlet	K30740	1
	1994-1997		Inlet	K30740	1
Water Pump Mount Gasket	1994-1997			K30739	1

14 1839CC (1.8L) DOHC (BPD) 4 Cyl, 3.268in./83mm (1990-1998)**14**

Part	Year	VIN	Model/Application	Part Number	Qty.
ENGINE GASKETS					
Head Set	1990-1995		(Plenum Chamber Gasket Not Included, Exhaust Pipe Flange Gasket Not Included)	HS5878	1
Lower Set	1990-1997		(Requires Head Set To Make Full Set)	CS5878	1
Full Set	1990-1994		(Requires RTV)	FS5878	1
Cylinder Head Gasket	1990-1998		<i>Multi-Layered Steel</i>	5878	1
Cyl. Head Spacer Shim	1990-1998		Requires Sealing Compound <i>Steel</i>	5878S	1
Sealing Compound	1990-1998		(4 Ounce Brush Top Can)	JV66B	1

Mazda

14 (cont.)	1839CC (1.8L) DOHC (BPD) 4 Cyl, 3.268in./83mm (1990-1998)				14 (cont.)
----------------------	--	--	--	--	----------------------

Part	Year	VIN	Model/Application	Part Number	Qty.
------	------	-----	-------------------	-------------	------

ENGINE GASKETS (cont.)

Sealing Compound (cont.)	1990-1998		(12 Ounce Spray Can)	JV66S	1
Valve Cover Set	1990-1998		<i>Victo-Tech</i>	VS50135	1
Valve Stem Seal, Exh.	1990-1998			B45549	8
Valve Stem Seal, Int.	1990-1998			B45549	8
Manifold Set, Exhaust	1990-1997			MS15646	1
Manifold Set, Intake	1990-1994		(Contains Plenum Chamber Gasket)	MS15647	1
Plenum Chamber Gasket	1990-1994			MS14755	1
Oil Pan Set	1990-1998		(Requires RTV) <i>Victo-Tech</i>	OS32096	1
Rear Main Seal	1990-1998		(Requires RTV)	66977	1
Timing Cover Set	1990-1994		Thru Chassis Serial Number 237236	JV1119	1
				JV1204	1

MISCELLANEOUS GASKETS

Camshaft Seal	1990-1994			66864	2
Exhaust Pipe Gasket	1994-1998		(Flange Type), Pipe To Manifold	F7547	1
	1990-1995		(Flange Type), Pipe To Manifold	F7473	1
			(Flange Type), Catalytic Converter To Exhaust Pipe, Rear	F10100	1
			(Flange Type), Catalytic Converter To Exhaust Pipe, Front	F12421	1
Throttle Body Gasket	1990-1994		(Flange Type), Exhaust Pipe To Muffler	F10100	1
	1995-1998			G31578	1
	1990-1994			G31190	1
Water Outlet Gasket	1990-1998		(2 Holes) <i>Victopac</i>	C20115	1
Water Pump Gasket	1990-1998		Inlet	K30740	1
Water Pump Mount Gasket	1990-1997			K30739	1

15	1839CC (1.8L) SOHC (BPE) 4 Cyl, 3.268in./83mm (1990-1995)				15
-----------	--	--	--	--	-----------

Part	Year	VIN	Model/Application	Part Number	Qty.
------	------	-----	-------------------	-------------	------

ENGINE GASKETS

Head Set	1990-1994			HS5879	1
Lower Set	1992-1994		(Requires RTV), To Be Replaced By CS5878	CS5879	1
	1991		From Chassis Serial Number 260401, (Requires RTV), To Be Replaced By CS5878	CS5879	1
	1990		(Requires RTV), To Be Replaced By CS5878	CS5879	1
Full Set	1992-1994		(Requires RTV)	FS5879	1
	1991		From Chassis Serial Number 260401, (Requires RTV)	FS5879	1
	1990		(Requires RTV)	FS5879	1
Cylinder Head Gasket	1990-1995		<i>VR2000</i>	5879	1
Cyl. Head Spacer Shim	1990-1995		Requires Sealing Compound <i>Steel</i>	5879S	1
Sealing Compound	1990-1995		(4 Ounce Brush Top Can)	JV66B	1
			(12 Ounce Spray Can)	JV66S	1
Valve Cover Set	1990-1995		<i>Victo-Tech</i>	VS50134	1
Valve Stem Seal, Exh.	1990-1995			B45549	8
Valve Stem Seal, Int.	1990-1995			B45549	8
Manifold Set, Exhaust	1990-1995			MS15649	1
Manifold Set, Intake	1990-1995		(Contains Plenum Chamber Gasket)	MS15648	1
Plenum Chamber Gasket	1990-1995			MS14754	1
Oil Pan Set	1990-1995		(Requires RTV) <i>Victo-Tech</i>	OS32096	1
Rear Main Seal	1990-1995		(Requires RTV)	66977	1
Timing Cover Set	1991-1995		From Chassis Serial Number 260401	JV1206	1
	1991		Thru Chassis Serial Number 260401	JV1044	1
	1990			JV1044	1

15 (cont.)	1839CC (1.8L) SOHC (BPE) 4 Cyl, 3.268in./83mm (1990-1995)				15 (cont.)
----------------------	--	--	--	--	----------------------

<i>Part</i>	<i>Year</i>	<i>VIN</i>	<i>Model/Application</i>	<i>Part Number</i>	<i>Qty.</i>
MISCELLANEOUS GASKETS					
Camshaft Seal	1990-1995			47699	1
Exhaust Pipe Gasket	1990-1995		(Flange Type), Pipe To Manifold	F7473	1
			(Flange Type), Catalytic Converter To Exhaust Pipe, Rear	F10100	1
			(Flange Type), Catalytic Converter To Exhaust Pipe, Front	F12421	1
	1990-1994		(Flange Type), Inlet Pipe To Catalytic Converter	F10100	1
Oil Pump Mounting Gasket	1990-1994			L45680	1
Throttle Body Gasket	1990-1995			G31190	1
Timing Cover Dust Seal Set	1990			JV1044	1
Water Outlet Gasket	1990-1995		(2 Holes) <i>Victopac</i>	C20115	1
Water Pump By-Pass Seal	1990-1994		(O-Ring Type)	B45807	1
Water Pump Gasket	1990-1995		Inlet	K30740	1
Water Pump Mount Gasket	1990-1995			K30739	1

16	1970CC (2.0L) MA SOHC 4 Cyl, 3.150in./80mm (1979-1982)				16
-----------	---	--	--	--	-----------

<i>Part</i>	<i>Year</i>	<i>VIN</i>	<i>Model/Application</i>	<i>Part Number</i>	<i>Qty.</i>
ENGINE GASKETS					
Head Set	1979-1982			HS3683	1
Full Set	1979-1982			FS3683	1
Engine Kit Gasket Set	1979-1982		(Exhaust Manifold Gasket Not Included), Use With Part Number MS12281	95-3366VR	1
Cylinder Head Gasket	1979-1982		<i>Nitroseal</i>	3683	1
Cyl. Head Spacer Shim	1979-1982		Requires Sealing Compound <i>Steel</i>	3683S	1
Sealing Compound	1979-1982		(4 Ounce Brush Top Can)	JV66B	1
			(12 Ounce Spray Can)	JV66S	1
Valve Cover Set	1979-1982		<i>Cork Rubber</i>	VS39754	1
			(Contains Half-Round Camshaft Seal) <i>Cork Rubber</i>	VS39754W	1
			<i>Victo-Tech</i>	VS50144	1
Valve Stem Seal, Exh.	1980-1982			B45490	4
	1979			B45437	4
Valve Stem Seal, Int.	1980-1982			B45490	4
	1979			B45437	4
Manifold Set, Exhaust	1979-1982			MS12281	1
Manifold Set, Intake	1979-1982			MS85719	1
Oil Pan Set	1979-1982		<i>Cork Rubber</i>	OS30548	1
Rear Main Seal Set	1979-1982			JV627	1
Timing Cover Set	1979-1982			JV963	1

MISCELLANEOUS GASKETS

Cam. Semi-Circular Plug	1979-1982		(Half Round)	B45450	2
Carb. Mount Gasket	1979-1982		2 Barrel Carburetor	G26825	2
Dist. Mounting Gasket	1979-1982		(O-Ring Type)	B45781	1
Distributor Seal	1980			66979	1
E.G.R. Gasket	1979-1982			G24843	1
Exhaust Pipe Gasket	1981-1982		(Flange Type), Catalytic Converter To Exhaust Pipe	F10118	1
			(Flange Type), Pipe To Manifold	F7393	1
			(Flange Type), Pipe To Manifold	F12384	1
Water Outlet Gasket	1979-1982			C20136	1
Water Pump Mount Gasket	1979-1982			K27363	1

Mazda

17 1991CC (2.0L) FS-ZE DOHC 4 Cyl, 3.268in./83mm (1993-2003)

17

Part	Year	VIN	Model/Application	Part Number	Qty.
ENGINE GASKETS					
Head Set	1993-1999		(Requires RTV)	HS5942	1
Lower Set	1993-1997		(Requires Head Set To Make Full Set)	CS5942	1
Engine Kit Gasket Set	1993-1997			95-3472VR	1
Cylinder Head Gasket	1993-1999		Multi-Layered Steel	5942	1
Cyl. Head Bolt Set	1993-1997			GS33270	1
Cyl. Head Spacer Shim	1993-1999		Requires Sealing Compound	Steel 5942S	1
Sealing Compound	1993-2002		(4 Ounce Brush Top Can)	JV66B	1
			(12 Ounce Spray Can)	JV66S	1
Valve Cover Set	1993-1997		Victo-Tech	VS50186	1
Valve Stem Seal, Exh.	1993-2003			B45549	8
Valve Stem Seal, Int.	1993-2002			B45549	8
Manifold Set, Exhaust	1993-1999		Multi-Layered Steel	MS16122	1
Manifold Set, Intake	1993-1997		Plenum Chamber Gasket Not Required	MS16121	1
Oil Pan Set	1993-1997		Cork Rubber	OS32515	1
Rear Main Seal Set	1993-2003			JV1615	1
Timing Cover Seal	1993-2000		Rubber	JV5002	1

MISCELLANEOUS GASKETS

Camshaft Seal	1993-2003			66864	2
Dist. Mounting Gasket	1993-1997			72213	1
E.G.R. Gasket	1998-2003			G31229	1
Exhaust Pipe Gasket	2001-2003		Protege, (Flange Type), Manifold To Pre-Catalytic Converter	F16221	1
			626, (Flange Type), Catalytic Converter To Exhaust Pipe, Front	F7486	1
	1998-2002		626, California, (Flange Type), Pipe To Manifold	F16221	1
			(Flange Type), Catalytic Converter To Exhaust Pipe, Rear	F12418	1
	1998-2000		626, Except California, (Flange Type), Pipe To Manifold	F7486	1
	1996-1997		(Flange Type), Pipe To Manifold	F16221	1
	1993-1997		(Flange Type), Catalytic Converter To Exhaust Pipe, Front	F7486	1
			(Flange Type), Intermediate Pipe To Muffler	F7486	1
	1993-1995		(Flange Type), Pipe To Manifold	F7547	1
(Flange Type), Pre-Catalytic Converter To Exhaust Pipe			F12418	1	
Oil Pump Inlet Tube	1993-2003		(O-Ring Type), Pump To Housing	B45719	1
Oil Pump Seal	1993-2003		(O-Ring Type), Cover	B45858	1
Therm. Housing Gasket	1993-1997			C31306	1
Throttle Body Gasket	1993-2003			G31436	1
Water Outlet Gasket	1993-2003			C31307	1
Water Pump Mount Gasket	1993-1997			K31308	1

18 1998CC (2.0L) FE SOHC 4 Cyl, 3.386in./86mm (1983-1987)

18

Part	Year	VIN	Model/Application	Part Number	Qty.
ENGINE GASKETS					
Head Set	1986-1987		Turbocharged	HS5780	1
			Naturally Aspirated	HS3763	1
Lower Set	1983-1987			CS3763	1
Engine Kit Gasket Set	1983-1987			95-3235VR	1
Cylinder Head Gasket	1986-1987		Turbocharged	Nitroseal 5780	1
			Naturally Aspirated	Nitroseal 3763	1
Cyl. Head Spacer Shim	1986-1987		Requires Sealing Compound, Turbocharged	Steel 5780S	1
			Requires Sealing Compound, Naturally Aspirated	Steel 3763S	1
Sealing Compound	1983-1987		(4 Ounce Brush Top Can)	JV66B	1
			(12 Ounce Spray Can)	JV66S	1
Valve Cover Set	1983-1987		Victo-Tech	VS38374	1
Valve Stem Seal, Exh.	1983-1987			B45490	4

18 (cont.)	1998CC (2.0L) FE SOHC 4 Cyl, 3.386in./86mm (1983-1987)				18 (cont.)
----------------------	---	--	--	--	----------------------

Part	Year	VIN	Model/Application	Part Number	Qty.
ENGINE GASKETS (cont.)					
Valve Stem Seal, Int.	1983-1987			B45490	4
Manifold Set, Exhaust	1983-1987			MS12299	1
Manifold Set, Intake	1983-1987		(Contains Plenum Chamber Gasket)	MS15360	1
Plenum Chamber Gasket	1986-1987		Turbocharged	MS12354	1
Oil Pan Set	1983-1987			Cork Rubber OS30598	1
Rear Main Seal Set	1983-1987			JV535	1
Timing Cover Set	1983-1987		(Requires RTV)	JV1001	1

MISCELLANEOUS GASKETS

Camshaft Seal	1983-1987			66864	1
Carb. Mount Gasket	1983-1987		2 Barrel Carburetor	G30804	2
Distributor Seal	1983-1987			66979	1
			(O-Ring Type)	B45781	1
E.G.R. Gasket	1986-1987		Manual Transmission, Naturally Aspirated	G31032	1
Exhaust Pipe Gasket	1986-1987		(Flange Type), Catalytic Converter To Exhaust Pipe	F7393	1
			(Flange Type), Turbocharged, Catalytic Converter To Exhaust Pipe	F7393	1
			(Flange Type), Turbocharged, Pipe To Manifold	F7471	1
			(Flange Type), Pipe To Manifold	F7472	1
	1983-1985		(Flange Type), Manifold To Converter	F7416	1
Fuel Pump Gasket	1983-1987			D24099	2
Throttle Body Gasket	1986-1987		Turbocharged	G30952	2
Water Outlet Gasket	1983-1987		(2 Holes)	Victopac C20115	1
Water Pump Hsg. O-Ring	1983-1987		(O-Ring Type)	B45807	1
Water Pump Mount Gasket	1983-1987			K27625	1

19	1998CC (2.0L) RF SOHC Diesel 4 Cyl, 3.386in./86mm (1984-1985)				19
-----------	--	--	--	--	-----------

Part	Year	VIN	Model/Application	Part Number	Qty.
ENGINE GASKETS					
Head Set	1984-1985			HS3787	1
Full Set	1984-1985			FS3787	1
Cylinder Head Gasket	1984-1985			VR2000 3787	1
Sealing Compound	1984-1985		(4 Ounce Brush Top Can)	JV66B	1
			(12 Ounce Spray Can)	JV66S	1
Valve Cover Set	1984-1985			Victo-Tech VS39470	1
Valve Stem Seal, Exh.	1984-1985			B45548	4
Valve Stem Seal, Int.	1984-1985			B45548	4
Manifold Set, Exhaust	1984-1985			MS15366	1
Manifold Set, Intake	1984-1985			MS15379	1
Oil Pan Set	1984-1985			Cork Rubber OS30993	1
Rear Main Seal Set	1984-1985			JV535	1
Timing Cover Set	1984-1985			JV996	1

MISCELLANEOUS GASKETS

Camshaft Seal	1984-1985		Front	47699	1
			Rear	47743	1
Water Outlet Gasket	1984-1985			C24553	1
Water Pump Backing Plate	1984-1985			K27136	1
Water Pump Mount Gasket	1984-1985			K27984	1

Mazda

20 2184CC (2.2L) F2 SOHC 4 Cyl, 3.386in./86mm (1988-1992)

20

Part	Year	VIN	Model/Application	Part Number	Qty.
ENGINE GASKETS					
Head Set	1988-1992		(Contains Exhaust Manifold Gasket, Exhaust Manifold Heat Shield Gasket Not Included)	HS5851	1
Lower Set	1988-1992		(Requires Head Set To Make Full Set)	CS5851	1
Engine Kit Gasket Set	1988-1992		Naturally Aspirated	95-3201VR	1
			Turbocharged, (Exhaust Manifold Gasket Not Included), Use With Part Number MS15593	95-3201VR	1
Cylinder Head Gasket	1988-1992		<i>Nitroseal</i>	5851	1
Valve Cover Set	1988-1992		<i>Victo-Tech</i>	VS50096	1
Valve Stem Seal, Exh.	1988-1992			B45588	6
Valve Stem Seal, Int.	1988-1992			B45588	6
Manifold Set, Exhaust	1988-1992		(Contains Exhaust Manifold Heat Shield And Gasket), Turbocharged	MS15593	1
			(Contains Exhaust Manifold Heat Shield And Gasket), Naturally Aspirated	MS15621	1
Manifold Set, Intake	1988-1992		(Contains Plenum Chamber Gasket)	MS15619	1
Oil Pan Set	1988-1992		<i>Cork Rubber</i>	OS30598	1
Rear Main Seal Set	1988-1992			JV535	1
Crank Repair Sleeve	1988-1992		Rear <i>Nickel Plated Formed Steel, .013" Thickness</i>	A347	1
Timing Cover Set	1988-1992		(Camshaft Seal Not Included)	JV1105	1

MISCELLANEOUS GASKETS

Camshaft Seal	1988-1992		Naturally Aspirated	66864	1
Distributor Seal	1988-1992			66979	1
E.G.R. Gasket	1988-1992		Automatic Transmission, Naturally Aspirated	G30702	1
			Manual Transmission, Naturally Aspirated	G31071	1
Exhaust Pipe Gasket	1988-1992		(Flange Type), Naturally Aspirated, Pipe To Manifold	F7472	1
			MX6, (Flange Type), Turbocharged, Pipe To Manifold	F7473	1
			Manual Transmission, (Flange Type), Naturally Aspirated, Catalytic Converter To Pre-Silencer	F7476	2
			Automatic Transmission, Front, Pipe To Converter	F12418	1
	1988-1991		(Flange Type), Pipe To Manifold	F7473	1
Fuel Inj. O-Ring	1988-1992		(O-Ring Type)	B45744	4
Fuel Pump Gasket	1988-1992			D24099	2
Throttle Body Gasket	1988-1992			G31070	1
Water Outlet Gasket	1988-1992		(2 Holes) <i>Victopac</i>	C20115	1
Water Pump Gasket	1988-1992		Inlet	C31112	1
Water Pump Mount Gasket	1988-1992			K31069	1
			(O-Ring Type)	K31111	1
Water Pump Mount Set	1988-1992			GS33187	1

21 2497CC (2.5L) KL-ZE DOHC V6 Cyl, 3.327in./84.5mm (1993-2002)

21

Part	Year	VIN	Model/Application	Part Number	Qty.
ENGINE GASKETS					
Head Set	1995-1997		Millenia, (Intake Manifold Gasket Not Included, Exhaust Pipe Flange Gasket Not Included)	HS54060	1
	1993-1997		626, MX6, (Exhaust Pipe Flange Gasket Not Included)	HS54060	1
Lower Set	1993-1997		(Requires Head Set To Make Full Set)	CS54060	1
Cylinder Head Gasket	2002		Millenia, Left Head <i>Multi-Layered Steel</i>	54061	1
	1993-2002		Right Head <i>Multi-Layered Steel</i>	54060	1
			Left Head <i>Multi-Layered Steel</i>	54061	1
Valve Cover Set	1993-2002		(Contains Valve Cover Grommets) <i>Victo-Tech</i>	VS50253	1
Valve Stem Seal, Exh.	1993-2002			B45866	12
Valve Stem Seal, Int.	1993-2002			B45866	12
Manifold Set, Exhaust	1993-2002		<i>Multi-Layered Steel</i>	MS12456	1
Manifold Set, Intake	1995-2002		Millenia <i>Beaded Steel</i>	MS12455	1
	1993-2002		626 <i>Beaded Steel</i>	MS12458	1
	1993-1997		MX6 <i>Beaded Steel</i>	MS12458	1

21 (cont.)	2497CC (2.5L) KL-ZE DOHC V6 Cyl, 3.327in./84.5mm (1993-2002)				21 (cont.)
----------------------	---	--	--	--	----------------------

Part	Year	VIN	Model/Application	Part Number	Qty.
------	------	-----	-------------------	-------------	------

ENGINE GASKETS (cont.)

Rear Main Seal	1993-1997			<i>Rubber</i> 66853	1
Timing Cover Set	1993-1997			JV1209	1
Timing Cover Seal	1993-1998			JV5002	1

MISCELLANEOUS GASKETS

Cam. Circular Plug	1993-2002			B45867	2
Camshaft Seal	1993-2002			47699	2
E.G.R. Gasket	1998-2002		Millenia	G31229	1
Exhaust Pipe Gasket	1998-2002		Millenia, (Flange Type), Pipe To Manifold	F7547	1
	1993-2002		626, (Flange Type), Pipe To Manifold	F7547	1
	1993-1997		MX6, (Flange Type), Pipe To Manifold	F7547	1
Injector Nozzle O-Ring	1993-1997			GS33278	1
Throttle Body Gasket	1995-2000		Millenia	G31545	1
	1998-1999		626	G31545	1
	1993-1997		626, MX6	G31438	1
Water Crossover Mount Set	1993-1997			GS33312	1
Water Pump Gasket	1993-2002			<i>Victo-Tech</i> K31543	1

22	2954CC (3.0L) JE06 SOHC V6 Cyl, 3.543in./90mm (1988-1989)				22
-----------	--	--	--	--	-----------

Part	Year	VIN	Model/Application	Part Number	Qty.
------	------	-----	-------------------	-------------	------

ENGINE GASKETS

Head Set	1988-1989			HS5856	1
Full Set	1988-1989			FS5856	1
Cylinder Head Gasket	1988-1989		Left	<i>Multi-Layered Steel</i> 5856	1
			Right	<i>Multi-Layered Steel</i> 5857	1
Cyl. Head Bolt Set	1988-1989			GS33314	2
Cyl. Head Spacer Shim	1988-1989		Requires Sealing Compound, Left	<i>Steel</i> 5856S	1
			Requires Sealing Compound, Right	<i>Steel</i> 5857S	1
Sealing Compound	1988-1989		(4 Ounce Brush Top Can)	JV66B	1
			(12 Ounce Spray Can)	JV66S	1
Valve Cover Set	1988-1989		(Valve Cover Washers Not Included)	<i>Victo-Tech</i> VS50097	1
Valve Stem Seal, Int.	1988-1989			B45588	12
Manifold Set, Exhaust	1988-1989			<i>Multi-Layered Steel</i> MS15557	1
Manifold Set, Intake	1988-1989		(Contains Plenum Chamber Gasket)	MS15556	1
Oil Pan Set	1988-1989		(Requires RTV)	<i>Cork Rubber</i> OS32081	1
Rear Main Seal Set	1988-1989			JV593	1
Timing Cover Set	1988-1989		(Camshaft Seal Not Included)	JV1104	1

MISCELLANEOUS GASKETS

Valve Stem Seal, Exh.	1988-1989			B45490	6
Camshaft Seal	1988-1989		Rear	B45688	2
Camshaft Seal Set	1988-1989		Front	JV1106	1
E.G.R. Gasket	1988-1989			GS31223	1
Exhaust Pipe Gasket	1988-1989		(Flange Type), Pipe To Manifold	F7280	1
			(Flange Type), Catalytic Converter To Exhaust Pipe	F7486	2
Oil Pump Inlet Tube	1988-1989			B45719	1
Oil Pump Mounting Gasket	1988-1989			L45700	1
Therm. Housing Gasket	1988-1989			C31074	1
Therm. Mount Gasket	1988-1989		Inner	C31345	1
			Outer	C31346	1
Thermostat O-Ring	1988-1989			C31348	1
Throttle Body Gasket	1988-1989			G31078	1
Valve Cover Grommet	1988-1989			B45656	14

Mazda

22 (cont.)	2954CC (3.0L) JE06 SOHC V6 Cyl, 3.543in./90mm (1988-1989)				22 (cont.)
----------------------	--	--	--	--	----------------------

Part	Year	VIN	Model/Application	Part Number	Qty.
------	------	-----	-------------------	-------------	------

MISCELLANEOUS GASKETS (cont.)

Water Pump Mount Gasket	1988-1989			K31077	1
-------------------------	-----------	--	--	--------	---

23	2954CC (3.0L) JE07 SOHC V6 Cyl, 3.543in./90mm (1988-1989)				23
-----------	--	--	--	--	-----------

Part	Year	VIN	Model/Application	Part Number	Qty.
------	------	-----	-------------------	-------------	------

ENGINE GASKETS

Head Set	1988-1989			HS5856	1
Full Set	1988-1989			FS5856	1
Cylinder Head Gasket	1988-1989	Left	Multi-Layered Steel	5856	1
		Right	Multi-Layered Steel	5857	1
Cyl. Head Bolt Set	1988-1989			GS33314	2
Cyl. Head Spacer Shim	1988-1989	Requires Sealing Compound, Left		Steel 5856S	1
		Requires Sealing Compound, Right		Steel 5857S	1
Sealing Compound	1988-1989	(4 Ounce Brush Top Can)		JV66B	1
		(12 Ounce Spray Can)		JV66S	1
Valve Cover Set	1988-1989	(Valve Cover Washers Not Included)		Victo-Tech VS50097	1
Valve Stem Seal, Int.	1988-1989			B45588	12
Manifold Set, Exhaust	1988-1989		Multi-Layered Steel	MS15557	1
Manifold Set, Intake	1988-1989	(Contains Plenum Chamber Gasket)		MS15556	1
Oil Pan Set	1988-1989	(Requires RTV)		Cork Rubber OS32081	1
Rear Main Seal Set	1988-1989			JV593	1
Timing Cover Set	1988-1989	(Camshaft Seal Not Included)		JV1104	1

MISCELLANEOUS GASKETS

Valve Stem Seal, Exh.	1988-1989			B45490	6
Camshaft Seal	1988-1989		Rear	B45688	2
Camshaft Seal Set	1988-1989		Front	JV1106	1
E.G.R. Gasket	1988-1989			GS31223	1
Exhaust Pipe Gasket	1988-1989	(Flange Type), Pipe To Manifold		F7280	1
		(Flange Type), Catalytic Converter To Exhaust Pipe		F7486	2
Oil Pump Inlet Tube	1988-1989			B45719	1
Oil Pump Mounting Gasket	1988-1989			L45700	1
Therm. Housing Gasket	1988-1989			C31074	1
Therm. Mount Gasket	1988-1989	Inner		C31345	1
		Outer		C31346	1
Thermostat O-Ring	1988-1989			C31348	1
Throttle Body Gasket	1988-1989			G31078	1
Valve Cover Grommet	1988-1989			B45656	14
Water Pump Mount Gasket	1988-1989			K31077	1

24	2954CC (3.0L) JE27 DOHC V6 Cyl, 3.543in./90mm (1990-1991)				24
-----------	--	--	--	--	-----------

Part	Year	VIN	Model/Application	Part Number	Qty.
------	------	-----	-------------------	-------------	------

ENGINE GASKETS

Head Set	1990-1991			HS5856W	1
Lower Set	1990-1991	(Requires Head Set To Make Full Set)		CS5856	1
Cylinder Head Gasket	1990-1991	Left	Multi-Layered Steel	5856	1
		Right	Multi-Layered Steel	5857	1
Cyl. Head Bolt Set	1990-1991			GS33342	2
Cyl. Head Spacer Shim	1990-1991	Requires Sealing Compound, Left		Steel 5856S	1
		Requires Sealing Compound, Right		Steel 5857S	1
Sealing Compound	1990-1991	(4 Ounce Brush Top Can)		JV66B	1
		(12 Ounce Spray Can)		JV66S	1

24 2954CC (3.0L) JE27 DOHC V6 Cyl, 3.543in./90mm (1990-1991)

24
(cont.)

Part	Year	VIN	Model/Application	Part Number	Qty.
ENGINE GASKETS (cont.)					
Valve Cover Set	1990-1991		(Valve Cover Washers Not Included), Left	<i>Victo-Tech</i> VS50164	1
			(Valve Cover Washers Not Included), Right	<i>Victo-Tech</i> VS50165	1
Valve Stem Seal, Exh.	1990-1991			B45549	12
Valve Stem Seal, Int.	1990-1991			B45549	12
Manifold Set, Exhaust	1990-1991			MS12402	1
Manifold Set, Intake	1990-1991		(Contains Plenum Chamber Gasket)	MS16080	1
Plenum Chamber Gasket	1990-1991			<i>Beaded Steel</i> MS16085	1
Oil Pan Set	1990-1991		(Requires RTV)	<i>Cork Rubber</i> OS32081	1
Rear Main Seal Set	1990-1991			JV593	1
Timing Cover Set	1990-1991		(Camshaft Seals Not Included)	JV1143	1

MISCELLANEOUS GASKETS

Camshaft Seal Set	1990-1991			JV1144	1
E.G.R. Gasket	1990-1991			G31229	1
Exhaust Pipe Gasket	1990-1991		(Flange Type), Catalytic Converter To Exhaust Pipe	F7486	2
			(Flange Type), Pipe To Manifold	F10094	1
Oil Pump Inlet Tube	1990-1991			B45719	1
Oil Pump Mounting Gasket	1990-1991			L45727	1
Therm. Housing Gasket	1990-1991			C31074	1
Therm. Mount Gasket	1990-1991		Inner	C31345	1
			Outer	C31346	1
Thermostat O-Ring	1990-1991			C31348	1
Throttle Body Gasket	1990-1991			G31228	1
Valve Cover Grommet	1990-1991			B45876	20
Water Pump Mount Gasket	1990-1991			K31077	1

25 2954CC (3.0L) JE39 SOHC V6 Cyl, 3.543in./90mm (1990-1991)

25

Part	Year	VIN	Model/Application	Part Number	Qty.
ENGINE GASKETS					
Head Set	1990-1991			HS5856	1
Full Set	1990-1991			FS5856	1
Cylinder Head Gasket	1990-1991		Left	<i>Multi-Layered Steel</i> 5856	1
			Right	<i>Multi-Layered Steel</i> 5857	1
Cyl. Head Bolt Set	1990-1991			GS33314	2
Cyl. Head Spacer Shim	1990-1991		Requires Sealing Compound, Left	<i>Steel</i> 5856S	1
			Requires Sealing Compound, Right	<i>Steel</i> 5857S	1
Sealing Compound	1990-1991		(4 Ounce Brush Top Can)	JV66B	1
			(12 Ounce Spray Can)	JV66S	1
Valve Cover Set	1990-1991		(Valve Cover Washers Not Included)	<i>Victo-Tech</i> VS50097	1
Valve Stem Seal, Exh.	1990-1991			B45490	6
Valve Stem Seal, Int.	1990-1991			B45588	12
Manifold Set, Exhaust	1990-1991			<i>Multi-Layered Steel</i> MS15557	1
Manifold Set, Intake	1990-1991		(Contains Plenum Chamber Gasket)	MS15556	1
Oil Pan Set	1990-1991		(Requires RTV)	<i>Cork Rubber</i> OS32081	1
Rear Main Seal Set	1990-1991			JV593	1
Timing Cover Set	1990-1991		(Camshaft Seal Not Included)	JV1104	1

MISCELLANEOUS GASKETS

Camshaft Seal	1990-1991		Rear	B45688	2
Camshaft Seal Set	1990-1991		Front	JV1106	1
E.G.R. Gasket	1990-1991			GS31223	1
Exhaust Pipe Gasket	1990-1991		(Flange Type), Pipe To Manifold	F7280	1
			(Flange Type), Catalytic Converter To Exhaust Pipe	F7486	2

Mazda

25 (cont.)	2954CC (3.0L) JE39 SOHC V6 Cyl, 3.543in./90mm (1990-1991)				25 (cont.)
----------------------	--	--	--	--	----------------------

Part	Year	VIN	Model/Application	Part Number	Qty.
------	------	-----	-------------------	-------------	------

MISCELLANEOUS GASKETS (cont.)

Oil Pump Inlet Tube	1990-1991			B45719	1
Oil Pump Mounting Gasket	1990-1991			L45700	1
Therm. Housing Gasket	1990-1991			C31074	1
Therm. Mount Gasket	1990-1991		Inner	C31345	1
			Outer	C31346	1
Thermostat O-Ring	1990-1991			C31348	1
Throttle Body Gasket	1990-1991			G31078	1
Valve Cover Grommet	1990-1991			B45656	14
Water Pump Mount Gasket	1990-1991			K31077	1

26	2954CC (3.0L) JE48 DOHC V6 Cyl, 3.543in./90mm (1992-1995)				26
-----------	--	--	--	--	-----------

Part	Year	VIN	Model/Application	Part Number	Qty.
------	------	-----	-------------------	-------------	------

ENGINE GASKETS

Head Set	1992-1995			HS5856X	1
Lower Set	1992-1995		(Requires Head Set To Make Full Set)	CS5856X	1
Cylinder Head Gasket	1992-1995		Left <i>Multi-Layered Steel</i>	5856	1
			Right <i>Multi-Layered Steel</i>	5857	1
Cyl. Head Bolt Set	1992-1995			GS33342	2
Cyl. Head Spacer Shim	1992-1995		Requires Sealing Compound, Left <i>Steel</i>	5856S	1
			Requires Sealing Compound, Right <i>Steel</i>	5857S	1
Sealing Compound	1992-1995		(4 Ounce Brush Top Can)	JV66B	1
			(12 Ounce Spray Can)	JV66S	1
Valve Cover Set	1992-1995		(Valve Cover Washers Not Included), Left <i>Victo-Tech</i>	VS50164	1
			(Valve Cover Washers Not Included), Right <i>Victo-Tech</i>	VS50166	1
Valve Stem Seal, Exh.	1992-1995			B45549	12
Valve Stem Seal, Int.	1992-1995			B45549	12
Manifold Set, Exhaust	1992-1995		<i>Multi-Layered Steel</i>	MS12404	1
Manifold Set, Intake	1992-1995		(Contains Plenum Chamber Gasket) <i>Multi-Layered Steel</i>	MS16084	1
Plenum Chamber Gasket	1992-1995			MS16082	1
Oil Pan Set	1992-1995		Original Equipment Uses RTV <i>Silicone</i>	JV6	1
Rear Main Seal Set	1992-1995			JV593	1
Timing Cover Set	1992-1995		(Camshaft Seals Not Included)	JV1143	1

MISCELLANEOUS GASKETS

Camshaft Seal Set	1992-1995			JV1144	1
E.G.R. Gasket	1992-1995			G31229	1
Exhaust Pipe Gasket	1992-1995		(Flange Type), Catalytic Converter To Exhaust Pipe	F7486	2
			(Flange Type), Pipe To Manifold	F10100	1
Oil Pump Inlet Tube	1992-1994			B45719	1
Oil Pump Mounting Gasket	1992-1995			L45727	1
Therm. Housing Gasket	1992-1995			C31074	1
Therm. Mount Gasket	1992-1995		Inner	C31345	1
			Outer	C31346	1
Thermostat O-Ring	1992-1995			C31348	1
Throttle Body Gasket	1992-1995			G31230	1
Valve Cover Grommet	1992-1995			B45876	20
Water Pump Mount Gasket	1992-1995			K31077	1

Engine Index

Engine	Year	Block
2197CC (2.2L) 615.912 Diesel	1971-1973	1
2299CC (2.3L)	1984-1993	2
2399CC (2.4L) 616.912 Diesel	1979-1983	3
2404CC (2.4L) 616.912 Diesel	1976-1978	4
2404CC (2.4L) 616.916 Diesel	1973-1976	5
2599CC (2.6L) 103.940	1987-1992	6
2599CC (2.6L) SOHC	1987-1993	7
2746CC (2.7L) 110.921	1973-1976	8
2746CC (2.7L) 110.922	1975-1976	9
2746CC (2.7L) 110.984	1973-1981	10
2746CC (2.7L) 110.985	1977-1980	11

Engine	Year	Block
2778CC (2.8L)	1971	12
2778CC (2.8L) 130.980	1971-1972	13
2962CC (3.0L) SOHC	1986-1992	14
2998CC (3.0L) Diesel	1978-1985	15
2998CC (3.0L) 617.910/617.912 Diesel	1976-1981	16
2998CC (3.0L) 617.912 Diesel	1978-1981	17
2998CC (3.0L) 617.952 Diesel	1981-1985	18
3005CC (3.0L) 617.910 Diesel	1975-1976	19
3839CC (3.8L)	1981-1985	20
5547CC (5.6L) 117.968	1986-1990	21

Model Index

Model	Engine	Year	Block
190E 2.3	2299CC (2.3L)	1984-1993	2
190E 2.3-16	2299CC (2.3L)	1986-1987	2
190E 2.6	2599CC (2.6L) SOHC	1987-1993	7
220D	2197CC (2.2L) 615.912 Diesel	1966-1973	1
240D	2399CC (2.4L) 616.912 Diesel	1979-1983	3
240D	2404CC (2.4L) 616.912 Diesel	1976-1978	4
240D	2404CC (2.4L) 616.916 Diesel	1973-1976	5
260E	2599CC (2.6L) 103.940	1987-1989	6
280	2746CC (2.7L) 110.921	1972-1976	8
280C	2746CC (2.7L) 110.921	1972-1976	8
280CE	2746CC (2.7L) 110.984	1978-1981	10
280CE	2746CC (2.7L) 110.985	1977-1978	11
280E	2746CC (2.7L) 110.984	1973-1982	10
280S	2746CC (2.7L) 110.922	1975-1976	9
280S	2778CC (2.8L)	1968-1972	12
280SE	2746CC (2.7L) 110.985	1977-1980	11
280SE	2778CC (2.8L) 130.980	1967-1972	13
280SEL	2778CC (2.8L) 130.980	1968-1972	13
300CD	2998CC (3.0L)	1977-1981	16
300CD Turbo Diesel	2998CC (3.0L) 617.910/617.912 Diesel	1982-1985	18
300D	2998CC (3.0L) 617.910/617.912 Diesel	1976-1981	16

Model	Engine	Year	Block
300D	3005CC (3.0L) 617.910 Diesel	1975-1976	19
300D Turbo Diesel	2998CC (3.0L) 617.952 Diesel	1982-1985	18
300E	2962CC (3.0L) SOHC	1986-1992	14
300E 2.6	2599CC (2.6L) 103.940	1990-1992	6
300E 4Matic	2962CC (3.0L) SOHC	1990-1993	14
300SD Turbo Diesel	2998CC (3.0L) Diesel	1978-1985	15
300SE	2962CC (3.0L) SOHC	1988-1991	14
300SEL	2962CC (3.0L) SOHC	1988-1991	14
300TD	2998CC (3.0L) 617.912 Diesel	1978-1981	17
300TD Turbo Diesel	2998CC (3.0L) 617.952 Diesel	1981-1985	18
300TE 4Matic Wagon	2962CC (3.0L) SOHC	1990-1993	14
300TE	2962CC (3.0L) SOHC	1988-1992	14
380SE	3839CC (3.8L)	1984-1985	20
380SEC	3839CC (3.8L)	1982-1983	20
380SEL	3839CC (3.8L)	1981-1983	20
380SL	3839CC (3.8L)	1981-1985	20
380SLC	3839CC (3.8L)	1981	20
560SEC	5547CC (5.6L) 117.968	1986-1991	21
560SEL	5547CC (5.6L) 117.968	1986-1991	21

1 2197CC (2.2L) 615.912 Diesel 4 Cyl, 3.425in./87mm (1971-1973) 1

Part	Year	VIN	Model/Application	Part Number	Qty.
------	------	-----	-------------------	-------------	------

ENGINE GASKETS

Valve Cover Set	1971-1973			Victo-Tech VS50281	1
-----------------	-----------	--	--	--------------------	---

2 2299CC (2.3L) 4 Cyl, 3.759in./95.5mm (1984-1993) 2

Part	Year	VIN	Model/Application	Part Number	Qty.
------	------	-----	-------------------	-------------	------

ENGINE GASKETS

Head Set	1985-1988		Engine Serial Number 102.985	HS5750W	1
	1984		Engine 102.961-10 To Serial Number 062509, Engine 102.961-12 To Serial Number 036796	HS5750	1
Lower Set	1984-1988		Engine 102.961-10 To Serial Number 062509, Engine 102.961-12 To Serial Number 036796, Engine Serial Number 102.985, (Requires Head Set To Make Full Set)	CS5750	1
Valve Cover Set	1991-1993		Engine 102.985	Victo-Tech VS50285	1
	1985-1988		Engine 102.985	Victo-Tech VS50285	1

MISCELLANEOUS GASKETS

Exhaust Pipe Gasket	1987-1993		Engine 103.942, Catalytic Converter To Exhaust Pipe, Right	F10082	1
			Engine 103.942, Catalytic Converter To Exhaust Pipe, Left	F10119	1

3 2399CC (2.4L) 616.912 Diesel 4 Cyl, 3.580in./90.9mm (1979-1983) 3

Part	Year	VIN	Model/Application	Part Number	Qty.
------	------	-----	-------------------	-------------	------

ENGINE GASKETS

Head Set	1979-1983			HS3963	1
----------	-----------	--	--	--------	---

Mercedes Benz

3	2399CC (2.4L) 616.912 Diesel 4 Cyl, 3.580in./90.9mm (1979-1983)	3
(cont.)		(cont.)

Part	Year	VIN	Model/Application	Part Number	Qty.
------	------	-----	-------------------	-------------	------

ENGINE GASKETS (cont.)

Full Set	1979-1983			FS3963	1
Valve Cover Set	1979-1983		Victo-Tech	VS50281	1

4	2404CC (2.4L) 616.912 Diesel 4 Cyl, 3.583in./91mm (1976-1978)	4
----------	--	----------

Part	Year	VIN	Model/Application	Part Number	Qty.
------	------	-----	-------------------	-------------	------

ENGINE GASKETS

Head Set	1976-1978			HS3963	1
Full Set	1976-1978			FS3963	1
Valve Cover Set	1976-1978		Victo-Tech	VS50281	1

5	2404CC (2.4L) 616.916 Diesel 4 Cyl, 3.583in./91mm (1973-1976)	5
----------	--	----------

Part	Year	VIN	Model/Application	Part Number	Qty.
------	------	-----	-------------------	-------------	------

ENGINE GASKETS

Head Set	1973-1976			HS3963	1
Full Set	1973-1976			FS3963	1
Valve Cover Set	1973-1976		Victo-Tech	VS50281	1

6	2599CC (2.6L) 103.940 6 Cyl, 3.268in./83mm (1987-1992)	6
----------	---	----------

Part	Year	VIN	Model/Application	Part Number	Qty.
------	------	-----	-------------------	-------------	------

ENGINE GASKETS

Valve Cover Set	1987-1992		Engine 103.940, Engine 103.942	Victo-Tech VS50286	1
-----------------	-----------	--	--------------------------------	--------------------	---

7	2599CC (2.6L) SOHC 6 Cyl, 3.268in./83mm (1987-1993)	7
----------	--	----------

Part	Year	VIN	Model/Application	Part Number	Qty.
------	------	-----	-------------------	-------------	------

ENGINE GASKETS

Valve Cover Set	1987-1993		Engine 103.940, Engine 103.942	Victo-Tech VS50286	1
-----------------	-----------	--	--------------------------------	--------------------	---

8	2746CC (2.7L) 110.921 6 Cyl, 3.386in./86mm (1973-1976)	8
----------	---	----------

Part	Year	VIN	Model/Application	Part Number	Qty.
------	------	-----	-------------------	-------------	------

ENGINE GASKETS

Head Set	1973-1976		280, 280C, 11mm Exhaust Valve Stem	HS3964	1
Lower Set	1973-1976		9mm Exhaust Valve Stem, (Requires Head Set To Make Full Set)	CS3964	1

MISCELLANEOUS GASKETS

Exhaust Pipe Gasket	1973-1976			F10105	2
---------------------	-----------	--	--	--------	---

9	2746CC (2.7L) 110.922 6 Cyl, 3.386in./86mm (1975-1976)	9
----------	---	----------

Part	Year	VIN	Model/Application	Part Number	Qty.
------	------	-----	-------------------	-------------	------

ENGINE GASKETS

Head Set	1975-1976		280S, 11mm Exhaust Valve Stem, Eng 110.922 With AT To SN 056908, Eng 110.922 With MT To SN 034537	HS3964	1
Lower Set	1975-1976		9mm Exhaust Valve Stem, (Requires Head Set To Make Full Set)	CS3964	1

MISCELLANEOUS GASKETS

Exhaust Pipe Gasket	1975-1976			F10105	2
---------------------	-----------	--	--	--------	---

10	2746CC (2.7L) 110.984 6 Cyl, 3.386in./86mm (1973-1981)	10
-----------	---	-----------

Part	Year	VIN	Model/Application	Part Number	Qty.
------	------	-----	-------------------	-------------	------

ENGINE GASKETS

Head Set	1978-1981		280CE, 11mm Exhaust Valve Stem, Eng 110.984 With AT To SN 037716, Eng 110.984 With MT To SN 010931	HS3964	1
----------	-----------	--	--	--------	---

10	2746CC (2.7L) 110.984 6 Cyl, 3.386in./86mm (1973-1981)	10
(cont.)		(cont.)

Part	Year	VIN	Model/Application	Part Number	Qty.
------	------	-----	-------------------	-------------	------

ENGINE GASKETS (cont.)

Head Set (cont.)	1978-1981		280CE, 9mm Exhaust Valve Stem, Eng 110.984 With AT From SN 037717, Eng 110.984 With MT From SN 010932	HS3964X	1
	1973-1981		280E, 11mm Exhaust Valve Stem, Eng 110.984 With AT To SN 037716, Eng 110.984 With MT To SN 010931	HS3964	1
			280E, 9mm Exhaust Valve Stem, Eng 110.984 With AT From SN 037717, Eng 110.984 With MT From SN 010932	HS3964X	1
Lower Set	1973-1981		9mm Exhaust Valve Stem, (Requires Head Set To Make Full Set)	CS3964	1

MISCELLANEOUS GASKETS

Exhaust Pipe Gasket	1973-1981			F10105	2
---------------------	-----------	--	--	--------	---

11	2746CC (2.7L) 110.985 6 Cyl, 3.386in./86mm (1977-1980)	11
-----------	---	-----------

Part	Year	VIN	Model/Application	Part Number	Qty.
------	------	-----	-------------------	-------------	------

ENGINE GASKETS

Head Set	1977-1980		280SE, 11mm Exhaust Valve Stem, Eng 110.985 With AT To SN 038036, Eng 110.985 With MT To SN 007976	HS3964	1
			280SE, 9mm Exhaust Valve Stem, Eng 110.985 With AT From SN 038037, Eng 110.985 With MT From SN 007977	HS3964X	1
	1977-1978		280CE, 11mm Exhaust Valve Stem, Eng 110.985 With AT To SN 038036, Eng 110.985 With MT To SN 007976	HS3964	1
			280CE, 9mm Exhaust Valve Stem, Eng 110.985 With AT From SN 038037, Eng 110.985 With MT From SN 007977	HS3964X	1
Lower Set	1977-1980		9mm Exhaust Valve Stem, (Requires Head Set To Make Full Set)	CS3964	1

MISCELLANEOUS GASKETS

Exhaust Pipe Gasket	1977-1980			F10105	2
---------------------	-----------	--	--	--------	---

12	2778CC (2.8L) 6 Cyl, 3.406in./86.5mm (1971)	12
-----------	--	-----------

Part	Year	VIN	Model/Application	Part Number	Qty.
------	------	-----	-------------------	-------------	------

MISCELLANEOUS GASKETS

Exhaust Pipe Gasket	1971		Engine 130.920, Engine 130.980, Pipe To Manifold	F10106	2
---------------------	------	--	--	--------	---

13	2778CC (2.8L) 130.980 6 Cyl, 3.406in./86.5mm (1971-1972)	13
-----------	---	-----------

Part	Year	VIN	Model/Application	Part Number	Qty.
------	------	-----	-------------------	-------------	------

MISCELLANEOUS GASKETS

Exhaust Pipe Gasket	1971-1972		Engine 130.920, Engine 130.980, Pipe To Manifold	F10106	2
---------------------	-----------	--	--	--------	---

14	2962CC (3.0L) SOHC 6 Cyl, 3.504in./89mm (1986-1992)	14
-----------	--	-----------

Part	Year	VIN	Model/Application	Part Number	Qty.
------	------	-----	-------------------	-------------	------

ENGINE GASKETS

Valve Cover Set	1986-1992		Engine 103.981, Engine 103.983, Engine 103.985 <i>Victo-Tech</i>	VS50286	1
-----------------	-----------	--	---	---------	---

15	2998CC (3.0L) Diesel 5 Cyl, 3.583in./91mm (1978-1985)	15
-----------	--	-----------

Part	Year	VIN	Model/Application	Part Number	Qty.
------	------	-----	-------------------	-------------	------

ENGINE GASKETS

Head Set	1980-1985		Turbocharged	HS3967W	1
Lower Set	1980-1985		(Requires Head Set To Make Full Set), Turbocharged	CS3967W	1
Valve Cover Set	1978-1985		<i>Victo-Tech</i>	VS50284	1

Mercedes Benz

16 2998CC (3.0L) 617.910/617.912 Diesel 5 Cyl, 3.583in./91mm (1976-1981) 16

Part	Year	VIN	Model/Application	Part Number	Qty.
ENGINE GASKETS					
Head Set	1976-1981		Naturally Aspirated	HS3967	1
Full Set	1976-1981		Naturally Aspirated	FS3967	1
Valve Cover Set	1976-1981		<i>Victo-Tech</i>	VS50284	1

17 2998CC (3.0L) 617.912 Diesel 5 Cyl, 3.583in./91mm (1978-1981) 17

Part	Year	VIN	Model/Application	Part Number	Qty.
ENGINE GASKETS					
Valve Cover Set	1978-1981		<i>Victo-Tech</i>	VS50284	1

18 2998CC (3.0L) 617.952 Diesel 5 Cyl, 3.583in./91mm (1981-1985) 18

Part	Year	VIN	Model/Application	Part Number	Qty.
ENGINE GASKETS					
Head Set	1981-1985		Turbocharged	HS3967W	1
Lower Set	1981-1985		(Requires Head Set To Make Full Set), Turbocharged	CS3967W	1
Valve Cover Set	1981-1985		<i>Victo-Tech</i>	VS50284	1

19 3005CC (3.0L) 617.910 Diesel 5 Cyl, 3.583in./91mm (1975-1976) 19

Part	Year	VIN	Model/Application	Part Number	Qty.
ENGINE GASKETS					
Head Set	1975-1976		Naturally Aspirated	HS3967	1
Full Set	1975-1976		Naturally Aspirated	FS3967	1
Valve Cover Set	1975-1976		<i>Victo-Tech</i>	VS50284	1

20 3839CC (3.8L) V8 Cyl, 3.465in./88mm (1981-1985) 20

Part	Year	VIN	Model/Application	Part Number	Qty.	
ENGINE GASKETS						
Head Set	1984-1985		380SE, Engine MB116.960, Engine MB116.961, Engine MB116.962, Engine MB116.963, (Valve Stem Seals Not Included), Left	HS5755	1	
			380SE, Engine MB116.960, Engine MB116.961, Engine MB116.962, Engine MB116.963, (Valve Stem Seals Not Included), Right	HS5756	1	
	1981-1985		380SL, Engine MB116.960, Engine MB116.961, Engine MB116.962, Engine MB116.963, (Valve Stem Seals Not Included), Left	HS5755	1	
			380SL, Engine MB116.960, Engine MB116.961, Engine MB116.962, Engine MB116.963, (Valve Stem Seals Not Included), Right	HS5756	1	
	1982-1983		380SEC, Engine MB116.960, Engine MB116.961, Engine MB116.962, Engine MB116.963, (Valve Stem Seals Not Included), Left	HS5755	1	
			380SEC, Engine MB116.960, Engine MB116.961, Engine MB116.962, Engine MB116.963, (Valve Stem Seals Not Included), Right	HS5756	1	
	1981-1983		380SEL, Engine MB116.960, Engine MB116.961, Engine MB116.962, Engine MB116.963, (Valve Stem Seals Not Included), Left	HS5755	1	
			380SEL, Engine MB116.960, Engine MB116.961, Engine MB116.962, Engine MB116.963, (Valve Stem Seals Not Included), Right	HS5756	1	
	1981		380SLC, Engine MB116.960, Engine MB116.961, Engine MB116.962, Engine MB116.963, (Valve Stem Seals Not Included), Left	HS5755	1	
			380SLC, Engine MB116.960, Engine MB116.961, Engine MB116.962, Engine MB116.963, (Valve Stem Seals Not Included), Right	HS5756	1	
	Valve Cover Set	1981-1985		Engine MB116.960, Engine MB116.961, Engine MB116.962, Engine MB116.963 <i>Victo-Tech</i>	VS50039	1

20 (cont.)	3839CC (3.8L) V8 Cyl, 3.465in./88mm (1981-1985)	20 (cont.)
----------------------	--	----------------------

Part	Year	VIN	Model/Application	Part Number	Qty.
ENGINE GASKETS (cont.)					
Valve Stem Seal Set	1981-1985		Engine MB116.960, Engine MB116.961, Engine MB116.962, Engine MB116.963, Thru Engine Serial Number 023705, Thru Engine Serial Number 042894	GS33141	1
			Engine MB116.962, Engine MB116.963, From Engine Serial Number 023706, From Engine Serial Number 042895	GS33142	1

21	5547CC (5.6L) 117.968 V8 Cyl, 3.799in./96.5mm (1986-1990)	21
-----------	--	-----------

Part	Year	VIN	Model/Application	Part Number	Qty.
MISCELLANEOUS GASKETS					
Exhaust Pipe Gasket	1986-1990		Catalytic Converter	F10115	2

Mitsubishi

Engine Index

Engine	Year	Block
1468CC (1.5L) 4G15 12 Valve	1991-2002	1
1468CC (1.5L) 4G15 8 Valve	1989-1990	2
1468CC (1.5L) G15B	1985-1988	3
1468CC (1.5L) G4AJ 8 Valve	1987-1989	4
1468CC (1.5L) G4DJ 8 Valve	1990-1994	5
1595CC (1.6L) 4G61 DOHC	1989-1992	6
1597CC (1.6L) G32B SOHC	1985-1988	7
1755CC (1.8L) 4G37	1989-1994	8
1794CC (1.8L) G62B	1983-1988	9
1834CC (1.8L) 4G93	1993-1997	10
122 CID (2.0L) DOHC Chrysler	1995-1999	11
1997CC (2.0L) 4G63 DOHC	1989-1996	12
1997CC (2.0L) 4G63 SOHC 16 Valve	1993	13

Engine	Year	Block
1997CC (2.0L) 4G63 SOHC 8 Valve	1989-1993	14
1997CC (2.0L) 4G63T DOHC TURBO	1989-1997	15
1997CC (2.0L) G63B SOHC	1983-1988	16
2351CC (2.4L) 4G64 DOHC	1994	17
2351CC (2.4L) 4G64 SOHC 16 Valve	1994-2002	18
2351CC (2.4L) G64B SOHC	1985-1987	19
2497CC (2.5L) 6G73 24 Valve SOHC	1995	20
2555CC (2.6L) G54B	1983-1989	21
2972CC (3.0L) 6G72 DOHC (Nat. Asp.)	1991-1999	22
2972CC (3.0L) 6G72 DOHC Twin Turbo	1991-1999	23
2972CC (3.0L) 6G72 SOHC 12 Valve	1988-1999	24
2972CC (3.0L) 6G72 SOHC 24 Valve	1999-2001	25
3497CC (3.5L) 6G74 SOHC	1997-2000	26

Model Index

Model	Engine	Year	Block
3000GT	2972CC (3.0L) 6G72 DOHC Twin Turbo	1991-1999	23
3000GT	2972CC (3.0L) 6G72 DOHC (Nat. Asp.)	1991-1999	22
3000GT	2972CC (3.0L) 6G72 SOHC 12 Valve	1997-1999	24
Cordia	1794CC (1.8L) G62B	1983-1988	9
Cordia	1997CC (2.0L) G63B SOHC	1984-1988	16
Diamante	2972CC (3.0L) 6G72 DOHC (Nat. Asp.)	1992-1995	22
Diamante	2972CC (3.0L) 6G72 SOHC 12 Valve	1992-1996	24
Diamante	3497CC (3.5L) 6G74 SOHC	1997-1998	26
Eclipse	122 CID (2.0L) DOHC Chrysler	1995-1999	11
Eclipse	1755CC (1.8L) 4G37	1989-1994	8
Eclipse	1997CC (2.0L) 4G63 DOHC	1989-1994	12
Eclipse	1997CC (2.0L) 4G63T DOHC TURBO	1989-1999	15
Eclipse	2351CC (2.4L) 4G64 SOHC 16 Valve	1996-2004	18
Eclipse	2972CC (3.0L) 6G72 SOHC 24 Valve	2000-2004	25
Galant	1997CC (2.0L) 4G63 DOHC	1989-1993	12
Galant	1997CC (2.0L) 4G63 SOHC 16 Valve	1993	13
Galant	1997CC (2.0L) 4G63T DOHC TURBO	1991-1992	15

Model	Engine	Year	Block
Galant	1997CC (2.0L) 4G63 SOHC 8 Valve	1989-1992	14
Galant	2351CC (2.4L) 4G64 DOHC	1994-1995	17
Galant	2351CC (2.4L) 4G64 SOHC 16 Valve	1994-2003	18
Galant	2351CC (2.4L) G64B SOHC	1985-1987	19
Galant	2497CC (2.5L) 6G73 24 Valve SOHC	1995	20
Galant	2972CC (3.0L) 6G72 SOHC 24 Valve	1999-2003	25
Galant	2972CC (3.0L) 6G72 SOHC 12 Valve	1988-1990	24
Mirage	1468CC (1.5L) 4G15 12 Valve	1991-2002	1
Mirage	1468CC (1.5L) 4G15 8 Valve	1989-1990	2
Mirage	1468CC (1.5L) G15B	1985-1988	3
Mirage	1595CC (1.6L) 4G61 DOHC	1989-1992	6
Mirage	1597CC (1.6L) G32B SOHC	1985-1988	7
Mirage	1834CC (1.8L) 4G93	1993-2002	10
Precis	1468CC (1.5L) G4DJ 8 Valve	1990-1994	5
Precis	1468CC (1.5L) G4AJ 8 Valve	1987-1989	4
Sigma	2972CC (3.0L) 6G72 SOHC 12 Valve	1989-1990	24
Starion	2555CC (2.6L) G54B	1983-1989	21
Tredia	1794CC (1.8L) G62B	1983-1988	9
Tredia	1997CC (2.0L) G63B SOHC	1984-1988	16

1	1468CC (1.5L) 4G15 12 Valve 4 Cyl, 2.972in./75.5mm (1991-2002)	1
----------	---	----------

Part	Year	VIN	Model/Application	Part Number	Qty.
ENGINE GASKETS					
Head Set	1991-1996		(Exhaust Pipe Gasket Not Included)	HS5907A	1
Full Set	1991-1995		(Exhaust Pipe Gasket Not Included)	FS5907	1

Mitsubishi

1 (cont.)	1468CC (1.5L) 4G15 12 Valve 4 Cyl, 2.972in./75.5mm (1991-2002)				1 (cont.)
---------------------	---	--	--	--	---------------------

Part	Year	VIN	Model/Application	Part Number	Qty.
------	------	-----	-------------------	-------------	------

ENGINE GASKETS (cont.)

Engine Kit Gasket Set	1991-1995			95-3352VR	1
	1991-1993		(Intake Manifold Gasket Not Included), Use With Part Number MS15439	95-3349VR	1
Cylinder Head Gasket	1991-1996		<i>Nitroseal</i>	5907	1
Valve Cover Set	1997-2002			VS50296	1
	1991-1996			VS50151	1
Valve Stem Seal, Exh.	1991-1996			B45622	4
Valve Stem Seal, Int.	1991-1996			B45622	8
Manifold Set, Exhaust	1991-1995			MS12395	1
Manifold Set, Intake	1991-1994			MS15983	1
Oil Pan Set	1991-1994		<i>Cork Rubber</i>	OS20674	1
Rear Main Seal Set	1991-1994			JV506	1
Timing Cover Set	1991-1995			JV944	1
Timing Cover Gasket	1991-1996			T26806	1
Timing Cover Seal	1991-1995			47738	1

MISCELLANEOUS GASKETS

Air Cleaner Mount Gasket	1991-1992			G30807	1
Air Flow Sensor	1991-1994			G30807	1
Camshaft Seal	1991-2002			47918	1
E.G.R. Gasket	1991-2002		<i>Nitroseal</i>	G30714	1
Exhaust Pipe Gasket	2001-2002		(Flange Type), Catalytic Converter To Front Exhaust Pipe, Manifold To Pre-Catalytic Converter, Pre-Catalytic Converter To Exhaust Pipe	F7409	3
	1995-2002		(Flange Type), Catalytic Converter To Center Pipe	F7422	1
	1991-2002		(Flange Type), Center Pipe To Muffler	F7464	1
	1997-2000		California, (Flange Type), Catalytic Converter To Front Exhaust Pipe, Manifold To Pre-Catalytic Converter, Pre-Catalytic Converter To Exhaust Pipe	F7409	3
			Except California, (Flange Type), Catalytic Converter To Front Exhaust Pipe, Pipe To Manifold	F7409	2
	1996		Except California, (Flange Type), Pipe To Manifold	F7422	1
	1995-1996		California, (Flange Type), Catalytic Converter To Front Exhaust Pipe, Manifold To Pre-Catalytic Converter	F7409	2
			Except California, (Flange Type), Catalytic Converter To Front Exhaust Pipe	F7409	1
	1993-1994		(Flange Type), Catalytic Converter To Front Exhaust Pipe	F7409	1
			(Flange Type), Catalytic Converter To Center Pipe, Pipe To Manifold	F7422	2
1991-1992		(Flange Type), Catalytic Converter To Center Pipe, Catalytic Converter To Front Exhaust Pipe	F7422	2	
		(Flange Type), Pipe To Manifold	F12336	1	
Throttle Body Gasket	1991-1994			G31116	1
Water Outlet Gasket	1991-1996			C24082	1
Water Pipe O-Ring	1991-1996			B45797	1
Water Pump Mount Gasket	1991-1994			K26379	1

2	1468CC (1.5L) 4G15 8 Valve 4 Cyl, 2.972in./75.5mm (1989-1990)				2
----------	--	--	--	--	----------

Part	Year	VIN	Model/Application	Part Number	Qty.
------	------	-----	-------------------	-------------	------

ENGINE GASKETS

Head Set	1989-1990		(Exhaust Pipe Gasket Not Included)	HS3798X	1
Full Set	1989-1990		(Exhaust Pipe Gasket Not Included)	FS3798X	1
Engine Kit Gasket Set	1989-1990		(Intake Manifold Gasket Not Included), Use With Part Number MS15439	95-3349VR	1
Cylinder Head Gasket	1989-1990			3675	1
Valve Cover Set	1989-1990		<i>Victo-Tech</i>	VS38425	1
Manifold Set, Exhaust	1989-1990			MS12340	1

2 1468CC (1.5L) 4G15 8 Valve 4 Cyl, 2.972in./75.5mm (1989-1990) **2**
(cont.) (cont.)

Part	Year	VIN	Model/Application	Part Number	Qty.
ENGINE GASKETS (cont.)					
Manifold Set, Intake	1989-1990		(Contains Plenum Chamber Gasket)	MS15439	1
Plenum Chamber Gasket	1989-1990			MS12338	1
Oil Pan Set	1989-1990		<i>Cork Rubber</i>	OS20674	1
Rear Main Seal Set	1989-1990			JV506	1
Timing Cover Set	1989-1990			JV944	1
Timing Cover Gasket	1989-1990			T26806	1
Timing Cover Seal	1989-1990			47738	1

MISCELLANEOUS GASKETS					
Air Cleaner Mount Gasket	1989-1990			G30652	1
Air Flow Sensor	1990			G30807	1
Camshaft Seal	1989-1990			47918	1
Carb. Mount Gasket	1989-1990		Top	G30805	1
			Bottom	G30806	1
E.G.R. Gasket	1989-1990		<i>Nitroseal</i>	G30714	1
Exhaust Pipe Gasket	1989-1990		(Flange Type), Catalytic Converter To Center Pipe, Catalytic Converter To Front Exhaust Pipe	F7422	2
			(Flange Type), Center Pipe To Muffler	F7464	1
			(Flange Type), Pipe To Manifold	F12336	1
Throttle Body Gasket	1990			G31116	1
	1989			G30808	1
Water Outlet Gasket	1989-1990			C24082	1
Water Pump Mount Gasket	1989-1990			K26379	1

3 1468CC (1.5L) G15B 4 Cyl, 2.972in./75.5mm (1985-1988) **3**

Part	Year	VIN	Model/Application	Part Number	Qty.
ENGINE GASKETS					
Head Set	1987-1988		(Exhaust Pipe Gasket Not Included)	HS3798W	1
	1985-1986		(Exhaust Pipe Gasket Not Included)	HS3798	1
Full Set	1987-1988		(Exhaust Pipe Gasket Not Included)	FS3798W	1
	1985-1986		(Exhaust Pipe Gasket Not Included)	FS3798	1
Engine Kit Gasket Set	1985-1988			95-3349VR	1
Cylinder Head Gasket	1985-1988			3675	1
Valve Cover Set	1985-1988		<i>Victo-Tech</i>	VS38425	1
Valve Stem Seal, Exh.	1985-1988			B45442	4
Valve Stem Seal, Int.	1985-1988			B45442	4
Manifold Set, Exhaust	1987-1988			MS12340	1
	1985-1986			MS15524	1
Manifold Set, Intake	1985-1988			MS7391	1
Oil Pan Set	1985-1988		<i>Cork Rubber</i>	OS20674	1
Rear Main Seal Set	1985-1988			JV506	1
Timing Cover Set	1985-1988			JV944	1
Timing Cover Gasket	1985-1988			T26806	1
Timing Cover Seal	1985-1988			47738	1

MISCELLANEOUS GASKETS					
Air Cleaner Mount Gasket	1985-1988		2 Barrel Carburetor	G30652	1
Camshaft Seal	1985-1988			47918	1
Carb. Mount Gasket	1987-1988		2 Barrel Carburetor, Top	G30805	1
			2 Barrel Carburetor, Bottom	G30806	1
	1986		Thru 5/86, 2 Barrel Carburetor	G25771	1
			From 6/86, 2 Barrel Carburetor, Top	G30805	1
			From 6/86, 2 Barrel Carburetor, Bottom	G30806	1
1985		2 Barrel Carburetor	G25771	1	

Mitsubishi

3 (cont.)	1468CC (1.5L) G15B 4 Cyl, 2.972in./75.5mm (1985-1988)				3 (cont.)
---------------------	--	--	--	--	---------------------

Part	Year	VIN	Model/Application	Part Number	Qty.
MISCELLANEOUS GASKETS (cont.)					
E.G.R. Gasket	1987-1988			<i>Nitroseal</i> G30714	1
	1985-1986			G24078	1
Exhaust Pipe Gasket	1987-1988		(Flange Type), Pipe To Manifold	F12336	1
	1985-1986		(Flange Type), Pipe To Manifold	F7422	1
				(Flange Type), Manifold To Converter	F14761
Fuel Pump Gasket	1985-1988			D24085	2
Jet Valve Seal	1985-1988			B45471	4
Water Outlet Gasket	1985-1988			C24082	1
Water Pump Mount Gasket	1985-1988			K26379	1

4	1468CC (1.5L) G4AJ 8 Valve 4 Cyl, 2.972in./75.5mm (1987-1989)				4
Part	Year	VIN	Model/Application	Part Number	Qty.

ENGINE GASKETS					
Head Set	1987-1989		(Exhaust Pipe Gasket Not Included)	HS3798W	1
Full Set	1987-1989		(Exhaust Pipe Gasket Not Included)	FS3798W	1
Engine Kit Gasket Set	1987-1989			95-3349VR	1
Cylinder Head Gasket	1987-1989			3675	1
Valve Cover Set	1987-1989			<i>Victo-Tech</i> VS38425	1
Valve Stem Seal, Exh.	1987-1989			B45442	4
Valve Stem Seal, Int.	1987-1989			B45442	4
Manifold Set, Exhaust	1987-1989			MS12340	1
Manifold Set, Intake	1987-1989			MS7391	1
Plenum Chamber Gasket	1989			MS12338	1
Oil Pan Set	1987-1989			<i>Cork Rubber</i> OS20674	1
Rear Main Seal Set	1987-1989			JV506	1
Timing Cover Set	1987-1989			JV944	1
Timing Cover Gasket	1987-1989			T26806	1
Timing Cover Seal	1987-1989			47738	1

MISCELLANEOUS GASKETS					
Air Cleaner Mount Gasket	1987-1989		2 Barrel Carburetor	G30652	1
Air Flow Sensor	1989			G30807	1
Camshaft Seal	1987-1989			47918	1
Carb. Mount Gasket	1987-1989		2 Barrel Carburetor, Top	G30805	1
			2 Barrel Carburetor, Bottom	G30806	1
E.G.R. Gasket	1987-1989			<i>Nitroseal</i> G30714	1
Exhaust Pipe Gasket	1989		(Flange Type), Catalytic Converter To Center Pipe, Pipe To Converter	F7422	1
			(Flange Type), Center Pipe To Muffler	F7464	1
	1987-1989		(Flange Type), Pipe To Manifold	F12336	1
Fuel Pump Gasket	1987-1989			D24085	2
Jet Valve Seal	1987-1989			B45471	4
Water Outlet Gasket	1987-1989			C24082	1
Water Pump Mount Gasket	1987-1989			K26379	1

5	1468CC (1.5L) G4DJ 8 Valve 4 Cyl, 2.972in./75.5mm (1990-1994)				5
Part	Year	VIN	Model/Application	Part Number	Qty.

ENGINE GASKETS					
Head Set	1990-1994		(Exhaust Pipe Gasket Not Included)	HS3798X	1
Full Set	1990-1994		(Exhaust Pipe Gasket Not Included)	FS3798X	1
Engine Kit Gasket Set	1990-1994		(Intake Manifold Gasket Not Included), Use With Part Number MS15439	95-3349VR	1
Cylinder Head Gasket	1990-1994			3675	1

5 1468CC (1.5L) G4DJ 8 Valve 4 Cyl, 2.972in./75.5mm (1990-1994) **5**
(cont.) (cont.)

Part Year VIN Model/Application Part Number Qty.

ENGINE GASKETS (cont.)

Valve Cover Set	1990-1994		<i>Victo-Tech</i>	VS38425	1
Valve Stem Seal, Exh.	1990-1994			B45622	4
Valve Stem Seal, Int.	1990-1994			B45622	4
Manifold Set, Exhaust	1990-1994			MS12340	1
Manifold Set, Intake	1990-1994		(Contains Plenum Chamber Gasket)	MS15439	1
Plenum Chamber Gasket	1990-1994			MS12338	1
Oil Pan Set	1990-1994		<i>Cork Rubber</i>	OS20674	1
Rear Main Seal Set	1990-1994			JV506	1
Timing Cover Set	1990-1994			JV944	1
Timing Cover Gasket	1990-1994			T26806	1
Timing Cover Seal	1990-1994			47738	1

MISCELLANEOUS GASKETS

Air Cleaner Mount Gasket	1991-1992			G30807	1
	1990			G30652	1
Camshaft Seal	1990-1994			47918	1
Carb. Mount Gasket	1990		Top	G30805	1
			Bottom	G30806	1
E.G.R. Gasket	1990-1991		<i>Nitroseal</i>	G30714	1
Exhaust Pipe Gasket	1990-1993		(Flange Type), Pipe To Manifold	F12336	1
	1990-1991		(Flange Type), Catalytic Converter To Center Pipe, Pipe To Converter	F7422	2
	1990		(Flange Type), Center Pipe To Muffler	F7464	1
Throttle Body Gasket	1990-1994			G31116	1
Water Outlet Gasket	1990-1994			C24082	1
Water Pump Mount Gasket	1990-1994			K26379	1

6 1595CC (1.6L) 4G61 DOHC 4 Cyl, 3.240in./82.3mm (1989-1992) **6**

Part Year VIN Model/Application Part Number Qty.

ENGINE GASKETS

Head Set	1989		(Exhaust Pipe Gasket Not Included), Turbocharged	HS5811	1
Lower Set	1989-1992			CS5875	1
Full Set	1989		(Exhaust Pipe Gasket Not Included), Turbocharged	FS5811	1
Engine Kit Gasket Set	1990-1992		Multi-Port Fuel Injection	95-3353VR	1
	1989		Turbocharged	95-3353VR	1
Cylinder Head Gasket	1989-1990		<i>Nitroseal</i>	5875	1
Valve Cover Set	1989		(Contains Spark Plug Tube Seals, Contains Camshaft Semi Circular Plug), Turbocharged <i>Victo-Tech</i>	VS50066	1
Valve Stem Seal, Exh.	1989		Turbocharged	B45622	8
Valve Stem Seal, Int.	1989		Turbocharged	B45622	8
Manifold Set, Exhaust	1989		Turbocharged <i>Multi-Layered Steel</i>	MS16215	1
Manifold Set, Intake	1989		Turbocharged	MS15976	1
Oil Pan Set	1989		Original Equipment Uses RTV, Turbocharged <i>Silicone</i>	JV6	1
Rear Main Seal Set	1989		Turbocharged	JV534	1
Timing Cover Set	1989		Turbocharged	JV1072	1

MISCELLANEOUS GASKETS

Air Flow Sensor	1989		Turbocharged	G30807	1
Camshaft Seal	1989		Turbocharged	47918	2
Cam. Semi-Circular Plug	1989		Turbocharged	B45621	1
E.G.R. Gasket	1989		Turbocharged <i>Nitroseal</i>	G30714	1
Exhaust Pipe Gasket	1989		(Flange Type), Turbocharged, Pipe To Manifold	F7409	1
			(Flange Type), Turbocharged, Catalytic Converter To Center Pipe, Pipe To Converter	F7422	2

Mitsubishi

6 (cont.)	1595CC (1.6L) 4G61 DOHC 4 Cyl, 3.240in./82.3mm (1989-1992)				6 (cont.)
---------------------	---	--	--	--	---------------------

Part	Year	VIN	Model/Application	Part Number	Qty.
MISCELLANEOUS GASKETS (cont.)					
Exhaust Pipe Gasket (cont.)	1989		(Flange Type), Turbocharged, Center Pipe To Muffler	F7464	1
Throttle Body Gasket	1989		Turbocharged	G31040	1
Water Outlet Gasket	1989		Turbocharged	C24082	1
Water Pump Mount Gasket	1989		Turbocharged	K31039	1

7	1597CC (1.6L) G32B SOHC 4 Cyl, 3.028in./76.9mm (1985-1988)				7
----------	---	--	--	--	----------

Part	Year	VIN	Model/Application	Part Number	Qty.
ENGINE GASKETS					
Head Set	1985-1988		(Exhaust Pipe Gasket Not Included), Turbocharged	HS3735T	1
Full Set	1985-1988		(Exhaust Pipe Gasket Not Included), Turbocharged	FS3735T	1
Cylinder Head Gasket	1985-1988		Turbocharged	3735	1
Valve Cover Set	1985-1988		Turbocharged <i>Victo-Tech</i>	VS39797	1
Valve Stem Seal, Exh.	1985-1988		(Original Equipment Type), Turbocharged	B45441	4
			(Premium), Turbocharged	B45806	8
Valve Stem Seal, Int.	1985-1988		(Original Equipment Type), Turbocharged	B45441	4
			(Premium), Turbocharged	B45806	8
Manifold Set, Exhaust	1985-1988		Turbocharged	MS15388	1
Manifold Set, Intake	1985-1988		Turbocharged	MS15386	1
Oil Pan Set	1985-1988		Turbocharged <i>Cork Rubber</i>	OS20673	1
Rear Main Seal Set	1985-1988		Turbocharged	JV506	1
Timing Cover Set	1985-1988		Turbocharged	JV942	1

MISCELLANEOUS GASKETS					
Camshaft Seal	1985-1988		Turbocharged	47918	1
Cam. Semi-Circular Plug	1985-1988		Turbocharged	B24180	1
E.G.R. Gasket	1987-1988		Turbocharged <i>Nitroseal</i>	G30714	1
			Turbocharged	G24078	1
Exhaust Pipe Gasket	1987-1988		(Flange Type), Turbocharged, Pipe To Manifold	F7422	1
			(Flange Type), Turbocharged, Pipe To Manifold	F7409	1
Fuel Inj. Mixer Gasket	1985-1988		Turbocharged	G30639	1
Jet Valve Seal	1985-1988		Turbocharged	B45471	4
Turbo Mounting Set	1985-1988		Turbocharged	GS33076	1
Valve Cover Grommet	1985-1988		Turbocharged	B45729	2
Water Outlet Gasket	1985-1988		Turbocharged	C24082	1
Water Pump Mount Gasket	1985-1988		Turbocharged	K26376	1

8	1755CC (1.8L) 4G37 4 Cyl, 3.173in./80.6mm (1989-1994)				8
----------	--	--	--	--	----------

Part	Year	VIN	Model/Application	Part Number	Qty.
ENGINE GASKETS					
Head Set	1989-1994		(Exhaust Pipe Gasket Not Included)	HS5812	1
Full Set	1989-1994		(Exhaust Pipe Gasket Not Included)	FS5812	1
Cylinder Head Gasket	1989-1994			5812	1
Valve Cover Set	1989-1994		<i>Victo-Tech</i>	VS39797	1
Valve Stem Seal, Exh.	1989-1994		(Original Equipment Type)	B45441	4
			(Premium)	B45806	4
Valve Stem Seal, Int.	1989-1994		(Original Equipment Type)	B45441	4
			(Premium)	B45806	4
Manifold Set, Exhaust	1989-1994			MS15980	1
Manifold Set, Intake	1989-1994		(Contains Plenum Chamber Gasket)	MS15979	1
Plenum Chamber Gasket	1989-1994			MS14802	1
Oil Pan Set	1989-1994		Original Equipment Uses RTV <i>Silicone</i>	JV6	1
Rear Main Seal Set	1989-1994			JV506	1

8 1755CC (1.8L) 4G37 4 Cyl, 3.173in./80.6mm (1989-1994) **8**
(cont.) (cont.)

Part Year VIN Model/Application Part Number Qty.

ENGINE GASKETS (cont.)

Timing Cover Set	1989-1994			JV1038	1
Timing Cover Gasket	1989-1994			T26808	1
Timing Cover Seal	1989-1994			47730	1

MISCELLANEOUS GASKETS

Air Cleaner Mount Gasket	1989-1994		Multi-Port Fuel Injection	G30807	1
Air Flow Sensor	1989-1994			G30807	1
Camshaft Seal	1989-1994			47918	1
Cam. Semi-Circular Plug	1989-1994			B24180	1
E.G.R. Gasket	1989-1994		<i>Nitroseal</i>	G30714	1
Exhaust Pipe Gasket	1989-1994		(Flange Type), Pipe To Converter	F7409	1
			(Flange Type), Catalytic Converter To Center Pipe	F7422	1
			(Flange Type), Center Pipe To Muffler	F7464	1
			(Flange Type), Pipe To Manifold	F12336	1
Fuel Pump Gasket	1989-1994			D24077	2
Throttle Body Gasket	1990-1994			G31115	1
	1989			G30808	1
Valve Cover Grommet	1989-1994			B45729	2
Water Outlet Gasket	1989-1994			C24082	1

9 1794CC (1.8L) G62B 4 Cyl, 3.173in./80.6mm (1983-1988) **9**

Part Year VIN Model/Application Part Number Qty.

ENGINE GASKETS

Head Set	1984-1988		(Exhaust Pipe Gasket Not Included), Turbocharged	HS5712T	1
	1983		(Exhaust Pipe Gasket Not Included)	HS5712	1
Lower Set	1983-1988			CS5875	1
Full Set	1984-1988		(Exhaust Pipe Gasket Not Included), Turbocharged	FS5712T	1
	1983		(Exhaust Pipe Gasket Not Included)	FS5712	1
Cylinder Head Gasket	1983-1988			5712	1
Valve Cover Set	1983-1988		(Valve Cover Grommets Not Included, Camshaft Semi Circular Plug Not Included) <i>Victo-Tech</i>	VS40003	1
			(Contains Valve Cover Grommets, Contains Camshaft Semi Circular Plug) <i>Victo-Tech</i>	VS40003CP	1
Manifold Set, Exhaust	1984-1988		Turbocharged	MS15398	1
	1983			MS15390	1
Manifold Set, Intake	1983-1988			MS15387	1
Oil Pan Set	1983-1988		<i>Cork Rubber</i>	OS32008	1
Rear Main Seal Set	1983-1988			JV534	1
Timing Cover Set	1983-1988			JV994	1

MISCELLANEOUS GASKETS

Exhaust Pipe Gasket	1983-1988		(Flange Type), Pipe To Manifold	F7409	1
Fuel Pump Gasket	1983-1988			D24085	2
Water Outlet Gasket	1983-1988			C24082	1
Water Pump Mount Gasket	1983-1988			K30615	1

10 1834CC (1.8L) 4G93 4 Cyl, 3.189in./81mm (1993-1997) **10**

Part Year VIN Model/Application Part Number Qty.

ENGINE GASKETS

Head Set	1993-1996			HS54172	1
Cylinder Head Gasket	1993-1996		<i>Nitroseal</i>	54172	1
Valve Stem Seal, Exh.	1993-1997			B45870	8
Valve Stem Seal, Int.	1993-1997			B45870	8
Manifold Set, Exhaust	1993-1997		<i>Multi-Layered Steel</i>	MS16278	1

Mitsubishi

10 (cont.)	1834CC (1.8L) 4G93 4 Cyl, 3.189in./81mm (1993-1997)				10 (cont.)
----------------------	--	--	--	--	----------------------

Part	Year	VIN	Model/Application	Part Number	Qty.
------	------	-----	-------------------	-------------	------

ENGINE GASKETS (cont.)

Manifold Set, Intake	1995-1996			MS16506	1
	1993-1994		California	MS16506	1
Oil Pan Set	1993-1996		Cork Rubber	OS32154	1
Rear Main Seal Set	1993-1996			JV1646	1

MISCELLANEOUS GASKETS

Spark Plug Tube Seal	1993-1997			B45881	1
Throttle Body Gasket	1993-1996			G31526	1
Water Pump Mount Gasket	1993-1996			K31521	1

11	122 CID (2.0L) DOHC Chrysler 4 Cyl, 3.445in./87.5mm (1995-1999)				11
-----------	--	--	--	--	-----------

Part	Year	VIN	Model/Application	Part Number	Qty.
------	------	-----	-------------------	-------------	------

ENGINE GASKETS

Head Set	1995-1999			HS54044B	1
Lower Set	1995-1999			CS54044	1
Engine Kit Gasket Set	1995-1999			95-3457VR	1
Cylinder Head Gasket	1995-1999		Multi-Layered Steel	54044A	1
Cyl. Head Bolt Set	1995-1999			GS33341	1
Valve Cover Set	1995-1999		(Contains Valve Cover Grommets, Spark Plug Tube Seals Not Included) Victo-Tech	VS50234	1
			(Contains Valve Cover Gasket Only) Victo-Tech	VS50234A	1
Valve Stem Seal, Exh.	1995-1999			B45844	8
Valve Stem Seal, Int.	1995-1999			B45844	8
Manifold Set, Exhaust	1995-1999			MS12448	1
Manifold Set, Intake	1995-1999		(Contains Plenum Chamber Gasket)	MS16234	1
Plenum Chamber Gasket	1995-1999			MS16235	1
Oil Pan Set	1995-1999		Victo-Tech	OS50225	1
Rear Main Seal Set	1995-1999		(One Piece) Teflon	JV1629	1
			(One Piece) Rubber	JV1654	1
Timing Cover Set	1995-1999			JV1202	1
Timing Cover Gasket	1995-1999		Inner	T31497	1
			Outer	T31499	1

MISCELLANEOUS GASKETS

Camshaft Seal	1995-1999		Front	48392	2
Cam Sensor O-Ring	1995-1999			GS33332	1
E.G.R. Gasket	1995-1999		Valve	G31321	1
			Exhaust Gas Recirculation Tube	G31458	1
Exhaust Pipe Gasket	1995-1999		(Flange Type), Catalytic Converter To Center Pipe, Inlet Pipe To Catalytic Converter, Pipe To Manifold	F7409	3
			Center Pipe To Muffler	F10120	1
	1995-1998		(Ring Type 'F')	F7466	1
Spark Plug Tube Seal	1995-1999			B45843	4
Throttle Body Gasket	1995-1999			G31480	1
Valve Cover Grommet	1995-1998			B45846	8
Water Pump Mount Gasket	1995-1999			K31501	1

12	1997CC (2.0L) 4G63 DOHC 4 Cyl, 3.346in./85mm (1989-1996)				12
-----------	---	--	--	--	-----------

Part	Year	VIN	Model/Application	Part Number	Qty.
------	------	-----	-------------------	-------------	------

ENGINE GASKETS

Head Set	1993-1994		(Exhaust Pipe Gasket Not Included, Turbocharger Gasket Not Included)	HS5875A	1
	1989-1992		(Exhaust Pipe Gasket Not Included)	HS5875	1
Lower Set	1993-1996		Requires Head Set To Make Full Set	CS5875A	1

12 1997CC (2.0L) 4G63 DOHC 4 Cyl, 3.346in./85mm (1989-1996) **12**
(cont.) (cont.)

Part	Year	VIN	Model/Application	Part Number	Qty.
ENGINE GASKETS (cont.)					
Lower Set (cont.)	1989-1992			CS5875	1
Full Set	1989-1992		(Exhaust Pipe Gasket Not Included)	FS5875	1
Engine Kit Gasket Set	1989-1992			95-3353VR	1
Cylinder Head Gasket	1989-1996		<i>Nitroseal</i>	5875	1
Valve Cover Set	1993-1996		(Contains Spark Plug Tube Seals, Contains Camshaft Semi Circular Plug) <i>Victo-Tech</i>	VS50252	1
	1989-1992		(Contains Spark Plug Tube Seals, Contains Camshaft Semi Circular Plug) <i>Victo-Tech</i>	VS50066	1
Manifold Set, Exhaust	1989-1996		<i>Multi-Layered Steel</i>	MS16215	1
Manifold Set, Intake	1989-1994			MS15976	1
Oil Pan Set	1989-1992		<i>Cork Rubber</i>	OS32008	1
Rear Main Seal Set	1989-1994			JV534	1
Timing Cover Set	1989-1992		(Requires Oil Pan Set)	JV1036	1
Timing Cover Seal	1989-1990			47730	1

MISCELLANEOUS GASKETS

Air Flow Sensor	1989-1992			G30807	1
Camshaft Seal	1989-1994			47918	2
Cam. Semi-Circular Plug	1989-1994			B45621	1
E.G.R. Gasket	1989-1994		<i>Nitroseal</i>	G30714	1
Exhaust Pipe Gasket	1990-1993		Front Muffler	F10120	1
	1989-1992		(Flange Type), Pipe To Manifold	F12336	1
Injector Nozzle O-Ring	1989-1996			GS33277	1
Water Outlet Gasket	1989-1994			C24082	1
Water Pump Mount Gasket	1989-1994			K30615	1

13 1997CC (2.0L) 4G63 SOHC 16 Valve 4 Cyl, 3.346in./85mm (1993) **13**

Part	Year	VIN	Model/Application	Part Number	Qty.
ENGINE GASKETS					
Head Set	1993		(Exhaust Pipe Gasket Not Included), Use With Part Number F12336	HS54119	1
Lower Set	1993		(Requires Head Set To Make Full Set)	CS5875A	1
Cylinder Head Gasket	1993		<i>Nitroseal</i>	54119G	1
Valve Cover Set	1993		(Contains Spark Plug Tube Seals) <i>Victo-Tech</i>	VS50267	1
Valve Stem Seal, Exh.	1993			B45870	4
Valve Stem Seal, Int.	1993			B45870	4
Manifold Set, Exhaust	1993			MS16215	1
Manifold Set, Intake	1993			MS16250	1
Oil Pan Set	1993		<i>Cork Rubber</i>	OS32137	1
Rear Main Seal Set	1993			JV1646	1

MISCELLANEOUS GASKETS

Air Flow Sensor	1993			G30807	1
Camshaft Seal	1993			47918	1
E.G.R. Gasket	1993		<i>Nitroseal</i>	G30714	1
Exhaust Pipe Gasket	1993		(Flange Type), Pipe To Converter	F7409	1
			(Flange Type), Catalytic Converter To Center Pipe	F7422	1
			(Flange Type), Center Pipe To Muffler	F7464	1
			(Flange Type), Pipe To Manifold	F12336	1
Injector Nozzle O-Ring	1993		From 6/92	GS33339	1
Spark Plug Tube Seal	1993			B45881	4
Throttle Body Gasket	1993			G31115	1
Water Pump Mount Gasket	1993			K31552	1

Mitsubishi

14 1997CC (2.0L) 4G63 SOHC 8 Valve 4 Cyl, 3.346in./85mm (1989-1993)

14

Part	Year	VIN	Model/Application	Part Number	Qty.
ENGINE GASKETS					
Head Set	1989-1992		(Exhaust Pipe Gasket Not Included)	HS5703Y	1
Full Set	1989-1992		(Exhaust Pipe Gasket Not Included)	FS5703Y	1
Engine Kit Gasket Set	1989-1992			95-3133VR	1
Cylinder Head Gasket	1989-1992		VR2000	5703	1
Cyl. Head Spacer Shim	1989-1992		Steel	5703S	1
Sealing Compound	1989-1992		(4 Ounce Brush Top Can)	JV66B	1
			(12 Ounce Spray Can)	JV66S	1
Valve Cover Set	1989-1992		(Valve Cover Grommets Not Included, Camshaft Semi Circular Plug Not Included) Victo-Tech	VS40003	1
Valve Stem Seal, Exh.	1989-1992		(Original Equipment Type)	B45441	4
			Premium	B45806	4
Valve Stem Seal, Int.	1989-1992		(Original Equipment Type)	B45441	4
			Premium	B45806	4
Manifold Set, Exhaust	1989-1992			MS15389	1
Manifold Set, Intake	1989-1992		(Contains Plenum Chamber Gasket)	MS15387Z	1
Plenum Chamber Gasket	1989-1992			MS14902	1
Oil Pan Set	1989-1992		Cork Rubber	OS32008	1
Rear Main Seal Set	1989-1992			JV534	1
Timing Cover Set	1989-1992		(Requires Oil Pan Set)	JV1036	1
Timing Cover Seal	1989-1990			47730	1

MISCELLANEOUS GASKETS

Air Flow Sensor	1989-1992			G30807	1
Camshaft Seal	1989-1993			47918	1
Cam. Semi-Circular Plug	1989-1992			B24180	1
E.G.R. Gasket	1989-1993		Nitroseal	G30714	1
Exhaust Pipe Gasket	1989-1992		(Flange Type), Pipe To Converter	F7409	1
			(Flange Type), Catalytic Converter To Center Pipe	F7422	1
			(Flange Type), Center Pipe To Muffler	F7464	1
			(Flange Type), Pipe To Manifold	F12336	1
Injector Nozzle O-Ring	1989-1992			GS33339	1
Throttle Body Gasket	1990-1992			G31115	1
	1989			G30808	1
Valve Cover Grommet	1989-1992			B45729	2
Water Outlet Gasket	1989-1992			C24082	1
Water Pump Gasket	1989-1992			K30615	1

15 1997CC (2.0L) 4G63T DOHC TURBO 4 Cyl, 3.346in./85mm (1989-1997)

15

Part	Year	VIN	Model/Application	Part Number	Qty.
ENGINE GASKETS					
Head Set	1993-1994		(Exhaust Pipe Gasket Not Included, Turbocharger Gasket Not Included)	HS5875A	1
	1989-1992		(Exhaust Pipe Gasket Not Included)	HS5875T	1
Lower Set	1993-1997		(Requires Head Set To Make Full Set)	CS5875A	1
Full Set	1989-1992		(Exhaust Pipe Gasket Not Included)	FS5875T	1
Engine Kit Gasket Set	1989-1992			95-3353VR	1
Cylinder Head Gasket	1989-1997		Nitroseal	5875	1
Valve Cover Set	1993-1997		(Contains Spark Plug Tube Seals, Contains Camshaft Semi Circular Plug) Victo-Tech	VS50252	1
	1989-1992		(Contains Spark Plug Tube Seals, Contains Camshaft Semi Circular Plug) Victo-Tech	VS50066	1
Valve Stem Seal, Exh.	1989-1997			B45622	8
Valve Stem Seal, Int.	1989-1997			B45622	8
Manifold Set, Exhaust	1989-1997		Multi-Layered Steel	MS16215	1
Manifold Set, Intake	1989-1994			MS15976	1
Oil Pan Set	1993-1997		Cork Rubber	OS32137	1

15 1997CC (2.0L) 4G63T DOHC TURBO 4 Cyl, 3.346in./85mm (1989-1997) **15**
(cont.) (cont.)

Part Year VIN Model/Application Part Number Qty.

ENGINE GASKETS (cont.)

Oil Pan Set (cont.)	1989-1992		<i>Cork Rubber</i>	OS32008	1
Rear Main Seal Set	1995-1997			JV1646	1
Timing Cover Set	1993-1997		Use With Part Number OS32137	JV5006	1
	1989-1992		Use With Part Number OS32008	JV1036	1
Timing Cover Seal	1989-1997			47730	1

MISCELLANEOUS GASKETS

Camshaft Seal	1989-1997		Front	47918	2
Cam. Semi-Circular Plug	1989-1997			B45621	1
E.G.R. Gasket	1989-1997		<i>Nitroseal</i>	G30714	1
Exhaust Pipe Gasket	1995-1997		(Flange Type), Catalytic Converter To Exhaust Pipe	F7409	1
	1989-1997		(Flange Type), Pipe To Manifold	F7409	1
			(Flange Type), Catalytic Converter To Front Exhaust Pipe, Pipe To Manifold	F7409	2
			Exhaust Pipe To Muffler	F10120	1
	1989-1994		(Flange Type), Catalytic Converter, Front	F7409	1
			(Flange Type), Catalytic Converter To Exhaust Pipe	F7422	1
1991-1992		(Flange Type), Catalytic Converter To Exhaust Pipe	F7409	1	
Injector Nozzle O-Ring	1989-1997			GS33277	1
Therm. Housing Gasket	1995-1997			C31197	1
Throttle Body Gasket	1995-1997			G31558	1
	1991-1994			G31547	1
	1990		From 5/2/90	G31547	1
Turbo Mounting Set	1989-1994			GS33311	1
Water Outlet Gasket	1989-1994			C24082	1
Water Pipe O-Ring	1989-1997			B45797	2
Water Pump Gasket	1997			K31552	1
Water Pump Mount Gasket	1995-1997			K31552	1
	1989-1994			K30615	1

16 1997CC (2.0L) G63B SOHC 4 Cyl, 3.346in./85mm (1983-1988) **16**

Part Year VIN Model/Application Part Number Qty.

ENGINE GASKETS

Head Set	1986-1988			HS5703Y	1
	1985		Thru 4/85	HS5703X	1
				From 5/85	HS5703Y
	1984			HS5703X	1
Lower Set	1984-1988			CS5875	1
Full Set	1986-1988			FS5703Y	1
	1985		Thru 4/85	FS5703X	1
				From 5/85	FS5703Y
1984			FS5703X	1	
Engine Kit Gasket Set	1984-1988		2 Barrel Carburetor	95-3133VR	1
Cylinder Head Gasket	1984-1988		<i>VR2000</i>	5703	1
Cyl. Head Spacer Shim	1984-1988		Requires Sealing Compound	<i>Steel</i> 5703S	1
Sealing Compound	1984-1988		(4 Ounce Brush Top Can)	JV66B	1
			(12 Ounce Spray Can)	JV66S	1
Valve Cover Set	1984-1988		(Valve Cover Grommets Not Included, Camshaft Semi Circular Plug Not Included)	<i>Victo-Tech</i> VS40003	1
			(Contains Valve Cover Grommets, Contains Camshaft Semi Circular Plug)	<i>Victo-Tech</i> VS40003CP	1
Valve Stem Seal, Exh.	1983-1988		(Original Equipment Type)	B45441	4
			(Premium)	B45806	4
Valve Stem Seal, Int.	1983-1988		(Original Equipment Type)	B45441	4

Mitsubishi

16 (cont.)	1997CC (2.0L) G63B SOHC 4 Cyl, 3.346in./85mm (1983-1988)					16 (cont.)
----------------------	---	--	--	--	--	----------------------

<i>Part</i>	<i>Year</i>	<i>VIN</i>	<i>Model/Application</i>	<i>Part Number</i>	<i>Qty.</i>
ENGINE GASKETS (cont.)					
Valve Stem Seal, Int. (cont.)	1983-1988		(Premium)	B45806	4
Manifold Set, Exhaust	1986-1988			MS15389	1
	1985		From 5/85	MS15389	1
				Thru 4/85	MS15390
	1984			MS15390	1
Manifold Set, Intake	1984-1988			MS15387	1
Oil Pan Set	1984-1988		Cork Rubber	OS32008	1
Rear Main Seal Set	1984-1988			JV534	1
Timing Cover Set	1986-1988			JV1036	1
	1985		Thru 4/85	JV994	1
				From 5/85	JV1036
	1984			JV994	1
Timing Cover Seal	1984-1988			47730	1

MISCELLANEOUS GASKETS

Air Cleaner Mount Gasket	1983-1988		2 Barrel Carburetor	G24965	1
Cam. Semi-Circular Plug	1983-1988			B24180	1
Carb. Mount Gasket	1983-1988		2 Barrel Carburetor	G25771	1
E.G.R. Gasket	1987-1988			Nitroseal G30714	1
	1983-1986			G24078	1
Fuel Pump Gasket	1984-1988			D24085	2
Jet Valve Seal	1983-1988			B45471	4
Valve Cover Grommet	1984-1988			B45729	2
Water Pump Mount Gasket	1984-1988			K30615	1

17	2351CC (2.4L) 4G64 DOHC 4 Cyl, 3.406in./86.5mm (1994)					17
-----------	--	--	--	--	--	-----------

<i>Part</i>	<i>Year</i>	<i>VIN</i>	<i>Model/Application</i>	<i>Part Number</i>	<i>Qty.</i>
ENGINE GASKETS					
Lower Set	1994		(Requires Head Set To Make Full Set)	CS5875A	1
Rear Main Seal Set	1994			JV1646	1

MISCELLANEOUS GASKETS

Injector Nozzle O-Ring	1994			GS33277	1
Water Pump Mount Gasket	1994			K31552	1

18	2351CC (2.4L) 4G64 SOHC 16 Valve 4 Cyl, 3.406in./86.5mm (1994-2002)					18
-----------	--	--	--	--	--	-----------

<i>Part</i>	<i>Year</i>	<i>VIN</i>	<i>Model/Application</i>	<i>Part Number</i>	<i>Qty.</i>
ENGINE GASKETS					
Head Set	1994-1997		(Exhaust Pipe Gasket Not Included)	HS54119	1
Lower Set	1994-1997		(Requires Head Set To Make Full Set)	CS5875A	1
Cylinder Head Gasket	1998-2001			Multi-Layered Steel 54329	1
	1994-1997			Nitroseal 54119G	1
Valve Cover Set	1999-2002			VS50297	1
	1994-1998		(Contains Spark Plug Tube Seals)	Victo-Tech VS50267	1
Valve Stem Seal, Exh.	1994-2001			B45870	8
Valve Stem Seal, Int.	1994-2001			B45870	8
Manifold Set, Exhaust	1994-2001			Multi-Layered Steel MS16215	1
Manifold Set, Intake	1994-1997			MS16250	1
Oil Pan Set	1994-1997			Cork Rubber OS32137	1
Rear Main Seal Set	1994-1997			JV1646	1
Timing Cover Seal	2000		Thru 3/00	47730	1
	1994-1999			47730	1

18 2351CC (2.4L) 4G64 SOHC 16 Valve 4 Cyl, 3.406in./86.5mm (1994-2002) **18**
(cont.) (cont.)

Part	Year	VIN	Model/Application	Part Number	Qty.
MISCELLANEOUS GASKETS					
Camshaft Seal	1994-2001		Front	47918	1
E.G.R. Gasket	1994-1998		<i>Nitroseal</i>	G30714	1
Exhaust Pipe Gasket	1994-2001		Center Pipe To Muffler	F10120	1
	1998		California Emission, (Flange Type), Catalytic Converter To Center Pipe, Catalytic Converter To Front Exhaust Pipe, Pre-Catalytic Converter To Exhaust Pipe	F7409	2
	1996-1998		Pipe To Manifold	F12336	1
	1995-1998		California Emission, (Flange Type), Pre-Catalytic Converter To Exhaust Pipe	F7409	1
			Federal Emission, Pipe To Manifold	F12336	1
	1994-1998		(Flange Type), Catalytic Converter To Center Pipe, Catalytic Converter To Front Exhaust Pipe	F7409	2
	1994		California Emission, From 6/94, (Flange Type), Catalytic Converter To Center Pipe, Catalytic Converter To Front Exhaust Pipe, Pre-Catalytic Converter To Exhaust Pipe	F7409	2
			California Emission, From 6/94, (Flange Type), Pre-Catalytic Converter To Exhaust Pipe	F7409	1
		Federal Emission, From 6/94, Pipe To Manifold	F12336	1	
		Thru 6/94, Pipe To Manifold	F12336	1	
Fuel Reg. O-Ring	1999-2001			72011	1
Spark Plug Tube Seal	1994-1997			B45881	4
Throttle Body Gasket	1994-2001			G31558	1
Water Pipe O-Ring	1994-2001			B45797	1
Water Pump Gasket	1994-2001			K31552	1

19 2351CC (2.4L) G64B SOHC 4 Cyl, 3.406in./86.5mm (1985-1987) **19**

Part	Year	VIN	Model/Application	Part Number	Qty.
ENGINE GASKETS					
Head Set	1986-1987		(Exhaust Pipe Gasket Not Included)	HS5747X	1
	1985		Thru 4/85, (Exhaust Pipe Gasket Not Included)	HS5747	1
			From 5/85, (Exhaust Pipe Gasket Not Included)	HS5747X	1
Full Set	1986-1987		(Exhaust Pipe Gasket Not Included)	FS5747X	1
	1985		Thru 4/85, (Exhaust Pipe Gasket Not Included)	FS5747	1
			From 5/85, (Exhaust Pipe Gasket Not Included)	FS5747X	1
Cylinder Head Gasket	1985-1987		<i>Nitroseal</i>	5747	1
Valve Cover Set	1985-1987		(Valve Cover Grommets Not Included, Camshaft Semi Circular Plug Not Included) <i>Victo-Tech</i>	VS40003	1
			(Contains Valve Cover Grommets, Contains Camshaft Semi Circular Plug) <i>Victo-Tech</i>	VS40003CP	1
Valve Stem Seal, Exh.	1985-1987		(Original Equipment Type)	B45441	4
			(Premium)	B45806	4
Valve Stem Seal, Int.	1985-1987		(Original Equipment Type)	B45441	4
			(Premium)	B45806	4
Manifold Set, Exhaust	1986-1987			MS15389	1
	1985		From 5/85	MS15389	1
			Thru 4/85	MS15398	1
Manifold Set, Intake	1985-1987		(Contains Plenum Chamber Gasket)	MS15387W	1
Plenum Chamber Gasket	1985-1987			MS12096	1
Oil Pan Set	1985-1987		<i>Cork Rubber</i>	OS32008	1
Rear Main Seal Set	1985-1987			JV534	1
Timing Cover Set	1986-1987			JV1036	1
	1985		Thru 4/85	JV994	1
			From 5/85	JV1036	1

MISCELLANEOUS GASKETS					
Air Flow Sensor	1985-1987			G30807	1
Camshaft Seal	1985-1987			47918	1

Mitsubishi

19 (cont.)	2351CC (2.4L) G64B SOHC 4 Cyl, 3.406in./86.5mm (1985-1987)				19 (cont.)
----------------------	---	--	--	--	----------------------

Part	Year	VIN	Model/Application	Part Number	Qty.
------	------	-----	-------------------	-------------	------

MISCELLANEOUS GASKETS (cont.)

Cam. Semi-Circular Plug	1985-1987			B24180	1
E.G.R. Gasket	1987		Nitroseal	G30714	1
	1985-1986			G24078	1
Exhaust Pipe Gasket	1987		(Flange Type), Pipe To Manifold	F12336	1
	1985-1986		(Flange Type), Pipe To Manifold	F12287	1
Jet Valve Seal	1985-1987			B45471	4
Throttle Body Gasket	1985-1987			G30808	1
Valve Cover Grommet	1985-1987			B45729	2
Water Outlet Gasket	1985-1987			C24082	1
Water Pump Mount Gasket	1985-1987			K30615	1

20	2497CC (2.5L) 6G73 24 Valve SOHC V6 Cyl, 3.290in./83.5mm (1995)				20
-----------	--	--	--	--	-----------

Part	Year	VIN	Model/Application	Part Number	Qty.
------	------	-----	-------------------	-------------	------

ENGINE GASKETS

Cylinder Head Gasket	1995		Nitroseal	54150G	2
Valve Cover Set	1995		(Contains Spark Plug Tube Seals) Victo-Tech	VS50270	1
Manifold Set, Intake	1995		(Contains Plenum Chamber Gasket)	MS16266	1
Plenum Chamber Gasket	1995			MS16279	1

MISCELLANEOUS GASKETS

Camshaft Seal	1995		Front	47918	2
Exhaust Pipe Gasket	1995		(Flange Type), Catalytic Converter To Center Pipe, Catalytic Converter To Front Exhaust Pipe, Pipe To Manifold	F7409	4
				GS33339	1
Injector Nozzle O-Ring	1995			B45881-A	1
Spark Plug Tube Seal	1995				
Therm. Housing Gasket	1995		Housing To Head	C31509	2
Water Outlet Gasket	1995		Water Outlet To Thermostat Case	C31507	1

21	2555CC (2.6L) G54B 4 Cyl, 3.587in./91.1mm (1983-1989)				21
-----------	--	--	--	--	-----------

Part	Year	VIN	Model/Application	Part Number	Qty.
------	------	-----	-------------------	-------------	------

ENGINE GASKETS

Head Set	1983-1989		Turbocharged	HS3697T	1
Full Set	1983-1989		Turbocharged	FS3697T	1
Engine Kit Gasket Set	1983-1989		Turbocharged	95-3190VR	1
Cylinder Head Gasket	1983-1989		Turbocharged VR2000	3697	1
Cyl. Head Bolt Set	1983-1989		Turbocharged	GS33325	1
Cyl. Head Spacer Shim	1983-1989		Requires Sealing Compound, Turbocharged Steel	3697S	1
Sealing Compound	1983-1989		(4 Ounce Brush Top Can)	JV66B	1
				(12 Ounce Spray Can)	JV66S
Valve Cover Set	1983-1989		(Valve Cover Grommets Not Included, Camshaft Semi Circular Plug Not Included), Turbocharged Victo-Tech	VS39865	1
				(Contains Valve Cover Grommets, Contains Camshaft Semi Circular Plug), Turbocharged Victo-Tech	VS39865CP
Valve Stem Seal, Exh.	1983-1989		(Original Equipment Type), Turbocharged	B45441	4
				(Premium), Turbocharged	B45806
Valve Stem Seal, Int.	1983-1989		(Original Equipment Type), Turbocharged	B45441	4
				(Premium), Turbocharged	B45806
Manifold Set, Exhaust	1983-1989		Turbocharged	MS15396	1
Manifold Set, Intake	1983-1989		Turbocharged Performaseal	MS15320	1
Oil Pan Set	1983-1989		Turbocharged Cork Rubber	OS20776	1
Rear Main Seal Set	1983-1989		Turbocharged	JV534	1

21 2555CC (2.6L) G54B 4 Cyl, 3.587in./91.1mm (1983-1989) **21**
(cont.) (cont.)

Part Year VIN Model/Application Part Number Qty.

ENGINE GASKETS (cont.)

Crank Repair Sleeve	1983-1989		Turbocharged, Use With Part Number A512, Rear <i>Nickel Plated Formed Steel, .013" Thickness</i>	A346	1
Timing Cover Set	1983-1989		Turbocharged	JV943	1
Timing Cover Gasket	1983-1989		Turbocharged	T26234	1
Timing Cover Seal	1983-1989		Turbocharged	47735	1
Harmonic Balancer Repair Sleeve	1983-1989		Turbocharged, Use With Part Number A500 <i>Nickel Plated Formed Steel, .013" Thickness</i>	A238	1

MISCELLANEOUS GASKETS

Cam. Circular Plug	1983-1989		Turbocharged	B45685	1
Cam. Semi-Circular Plug	1983-1989		Turbocharged	B24180	1
E.G.R. Gasket	1983-1989		Turbocharged	G24078	1
Fuel Inj. Mixer Gasket	1983-1989		Turbocharged	G30639	1
Fuel Pump Gasket	1983-1989		Turbocharged	D24076	2
Jet Valve Seal	1983-1989		Turbocharged	B45471	4
Turbo Mounting Set	1983-1989		Turbocharged	GS33077	1
Valve Cover Grommet	1983-1989		Turbocharged	B45729	2
Water Outlet Gasket	1983-1989		Turbocharged	C24082	1
Water Pipe O-Ring	1983-1989		Turbocharged	B45797	2
Water Pump Mount Gasket	1983-1989		Turbocharged	K26487	1

22 2972CC (3.0L) 6G72 DOHC (Nat. Asp.) V6 Cyl, 3.587in./91.1mm (1991-1999) **22**

Part Year VIN Model/Application Part Number Qty.

ENGINE GASKETS

Head Set	1991-1993		(Turbo Mounting Gaskets Not Included)	HS54144	1
Lower Set	1991-1992		(Requires Head Set To Make Full Set)	CS54144	1
Cylinder Head Gasket	1991-1993		<i>Nitroseal</i>	54144G	1
Cyl. Head Bolt Set	1991-1999			GS33327	1
Valve Cover Set	1991-1999		(Contains Spark Plug Tube Seals) <i>Victo-Tech</i>	VS50269	1
Valve Stem Seal, Exh.	1995-1999			B45883	12
	1994		Thru 10/94	B45622	12
				From 10/94	B45883
	1991-1993			B45622	12
Valve Stem Seal, Int.	1994		Thru 10/94	B45622	12
	1991-1993			B45622	12
Manifold Set, Exhaust	1991-1999		<i>Nitroseal</i>	MS16265	1
Manifold Set, Intake	1991-1996		(Plenum Chamber Gasket Not Included)	MS16264A	1
Plenum Chamber Gasket	1991-1999			MS16232	1
Oil Pan Set	1991-1992		<i>Cork Rubber</i>	OS32054	1
Rear Main Seal Set	1991-1999			JV1062	1
			<i>Teflon</i>	JV1637	1

MISCELLANEOUS GASKETS

Exhaust Pipe Gasket	1991-1999		Naturally Aspirated, (Flange Type), Catalytic Converter To Front Exhaust Pipe, Pipe To Manifold, Right Catalytic Converter To Block	F7409	3
	1992-1995		Naturally Aspirated, (Flange Type), Catalytic Converter To Center Pipe, Catalytic Converter To Front Exhaust Pipe, Pipe To Manifold, Right Catalytic Converter To Block	F7409	4
Spark Plug Tube Seal	1991-1999			B45884	1
Therm. Mount Gasket	1991-1999			C31573	1
Throttle Body Gasket	1991-1999			G31547	1
Water Outlet Gasket	1991-1999		Cylinder Block Water Hole, Water Outlet To Thermostat Case	C24219	2
			Inlet	C31507	1
				C31573	1

Mitsubishi

22 (cont.)	2972CC (3.0L) 6G72 DOHC (Nat. Asp.) V6 Cyl, 3.587in./91.1mm (1991-1999)				22 (cont.)
----------------------	--	--	--	--	----------------------

Part	Year	VIN	Model/Application	Part Number	Qty.
------	------	-----	-------------------	-------------	------

MISCELLANEOUS GASKETS (cont.)

Water Pump Gasket	1991-1999			K31555	1
-------------------	-----------	--	--	--------	---

23	2972CC (3.0L) 6G72 DOHC Twin Turbo V6 Cyl, 3.587in./91.1mm (1991-1999)				23
-----------	---	--	--	--	-----------

Part	Year	VIN	Model/Application	Part Number	Qty.
------	------	-----	-------------------	-------------	------

ENGINE GASKETS

Head Set	1993		Thru 5/93, (Turbo Mounting Gaskets Not Included)	HS54144	1
	1991-1992		(Turbo Mounting Gaskets Not Included)	HS54144	1
Lower Set	1991-1992		(Requires Head Set To Make Full Set)	CS54144	1
Cylinder Head Gasket	1993		Thru 5/93	Nitroseal 54144G	2
	1991-1992			Nitroseal 54144G	2
Cyl. Head Bolt Set	1991-1999			GS33327	1
Valve Cover Set	1991-1999		(Contains Spark Plug Tube Seals)	Victo-Tech VS50269	1
Valve Stem Seal, Exh.	1995-1999			B45883	12
	1994		Thru 10/94	B45622	12
				From 10/94	B45883
	1991-1993			B45622	12
Valve Stem Seal, Int.	1994		Thru 10/94	B45622	12
	1991-1993			B45622	12
Manifold Set, Exhaust	1991-1999			Nitroseal MS16265	1
Manifold Set, Intake	1991-1999		(Contains Plenum Chamber Gasket)	MS16264A	1
Plenum Chamber Gasket	1991-1999			MS16232	1
Oil Pan Set	1991-1992			Cork Rubber OS32054	1
Rear Main Seal Set	1991-1999			JV1062	1
				Teflon JV1637	1

MISCELLANEOUS GASKETS

E.G.R. Gasket	1991-1999			Nitroseal G30714	1
Exhaust Pipe Gasket	1991-1999		(Flange Type), Pipe To Manifold, Right	F7409	1
			(Flange Type), Right Catalytic Converter To Block	F7409	1
	1993		Thru 6/93, (Flange Type), Left, Pipe To Manifold	F7409	1
	1991-1992		(Flange Type), Left, Pipe To Manifold	F7409	1
Spark Plug Tube Seal	1991-1999			B45884	1
Therm. Mount Gasket	1991-1999			C31573	1
Throttle Body Gasket	1991-1999			G31547	1
Water Outlet Gasket	1991-1999		Cylinder Block Water Hole, Water Outlet To Thermostat Case	C24219	2
			Inlet	C31507	1
				C31573	1
Water Pump Gasket	1991-1999			K31555	1

24	2972CC (3.0L) 6G72 SOHC 12 Valve V6 Cyl, 3.587in./91.1mm (1988-1999)				24
-----------	---	--	--	--	-----------

Part	Year	VIN	Model/Application	Part Number	Qty.
------	------	-----	-------------------	-------------	------

ENGINE GASKETS

Head Set	1994		Except California, Thru 5/94, (Exhaust Pipe Gasket Not Included)	HS5765-3	1
	1992-1993		(Exhaust Pipe Gasket Not Included)	HS5765-3	1
	1988-1990		(Exhaust Pipe Gasket Not Included)	HS5765-2	1
Lower Set	1994		Except California, Thru 5/94, (Requires Head Set To Make Full Set)	CS5765-1	1
	1992-1993		(Requires Head Set To Make Full Set)	CS5765-1	1
	1988-1990		(Requires Head Set To Make Full Set)	CS5765-1	1
Engine Kit Gasket Set	1992-1995			95-3192VR	1
	1988-1990			95-3192VR	1
Cylinder Head Gasket	1997-1999			Nitroseal 5765	2
	1994		Thru 5/94	Nitroseal 5765	2

24 (cont.)	2972CC (3.0L) 6G72 SOHC 12 Valve V6 Cyl, 3.587in./91.1mm (1988-1999)				24 (cont.)
----------------------	---	--	--	--	----------------------

<i>Part</i>	<i>Year</i>	<i>VIN</i>	<i>Model/Application</i>	<i>Part Number</i>	<i>Qty.</i>
ENGINE GASKETS (cont.)					
Cylinder Head Gasket (cont.)	1992-1993			<i>Nitroseal</i> 5765	2
	1988-1990			<i>Nitroseal</i> 5765	2
Cyl. Head Bolt Set	1992-1999			GS33327	1
	1988-1990			GS33327	1
Cyl. Head Spacer Shim	1988-1990		Requires Sealing Compound	<i>Steel</i> 5765S	2
Sealing Compound	1988-1990		(4 Ounce Brush Top Can)	JV66B	1
			(12 Ounce Spray Can)	JV66S	1
Valve Cover Set	1992-1999		(Contains Valve Cover Grommets)	<i>Victo-Tech</i> VS50054	1
			(Valve Cover Grommets Not Included, Camshaft Circular Plug Not Included)	<i>Victo-Tech</i> VS50256	1
			(Contains Valve Cover Grommets, Contains Camshaft Circular Plugs)	<i>Victo-Tech</i> VS50257	1
	1988-1990		(Contains Valve Cover Grommets)	<i>Victo-Tech</i> VS50054	1
			(Valve Cover Grommets Not Included, Camshaft Circular Plug Not Included)	<i>Victo-Tech</i> VS50256	1
			(Contains Valve Cover Grommets, Contains Camshaft Circular Plugs)	<i>Victo-Tech</i> VS50257	1
Valve Stem Seal, Exh.	1993-1999			<i>Fluoroelastomer</i> B45790	6
	1992		Thru 10/92, (Original Equipment Type)	B45441	6
			From 10/92	<i>Fluoroelastomer</i> B45790	6
	1988-1990			<i>Fluoroelastomer</i> B45790	6
Valve Stem Seal, Int.	1993-1999			<i>Fluoroelastomer</i> B45790	6
	1992		Thru 10/92, (Original Equipment Type)	B45441	6
			From 10/92	<i>Fluoroelastomer</i> B45790	6
	1988-1990			<i>Fluoroelastomer</i> B45790	6
Manifold Set, Exhaust	1992-1999			MS15543	1
	1988-1990			MS15543	1
Manifold Set, Intake	1992-1998		(Contains Plenum Chamber Gasket)	MS15444Z	1
	1988-1990		(Contains Plenum Chamber Gasket)	MS15444Y	1
Oil Pan Set	1992-1995			<i>Cork Rubber</i> OS32054	1
	1988-1990			<i>Cork Rubber</i> OS32054	1
Rear Main Seal Set	1992-1999			JV1062	1
	1988-1990			JV1062	1
Crank Repair Sleeve	1988-1990		Use With Part Number A505, Rear <i>Nickel Plated Formed Steel, .013" Thickness</i>	A342	1
			Front <i>Nickel Plated Formed Steel, .013" Thickness</i>	A357	1
Timing Cover Set	1992-1998			JV1118	1
	1988-1990			JV1118	1

MISCELLANEOUS GASKETS

Air Flow Sensor	1988-1990			G30807	1
Cam. Circular Plug	1992-1999			B45682	2
	1988-1990			B45682	2
Camshaft Seal	1992-1999			47918	2
	1988-1990			47918	1
E.G.R. Gasket	1997-1999		Valve	<i>Nitroseal</i> G30714	1
Exhaust Pipe Gasket	1997-1998		(Flange Type), Catalytic Converter To Front Exhaust Pipe, Pipe To Manifold, Right Catalytic Converter To Block	F7409	3
	1992-1996		(Flange Type), Catalytic Converter To Center Pipe, Catalytic Converter To Front Exhaust Pipe, Pipe To Manifold, Right Catalytic Converter To Block	F7409	4
	1989-1990		(Flange Type), Pipe To Manifold	F7409	1
Throttle Body Gasket	1992-1999			G31547	1
	1988-1990			G31041	1
Valve Cover Grommet	1992-1999			B45729	4
	1988-1990			B45729	4
Water Outlet Gasket	1992-1999			C24082	1

Mitsubishi

24 (cont.)	2972CC (3.0L) 6G72 SOHC 12 Valve V6 Cyl, 3.587in./91.1mm (1988-1999)					24 (cont.)
----------------------	---	--	--	--	--	----------------------

Part	Year	VIN	Model/Application	Part Number	Qty.
MISCELLANEOUS GASKETS (cont.)					
Water Outlet Gasket (cont.)	1988-1990			C24082	1
Water Pump Mount Gasket	1992-1999		Adapter To Block	K30816	1
	1992-1998		Pump To Adapter	K31160	1
	1988-1990		Adapter To Block	K30816	1
			Pump To Adapter	K31160	1

25	2972CC (3.0L) 6G72 SOHC 24 Valve V6 Cyl, 3.587in./91.1mm (1999-2001)					25
-----------	---	--	--	--	--	-----------

Part	Year	VIN	Model/Application	Part Number	Qty.
ENGINE GASKETS					
Cyl. Head Bolt Set	1999-2001			GS33327	1
Valve Cover Set	1999-2001		(Contains Spark Plug Tube Seals) <i>Victo-Tech</i>	VS50270	1
Valve Stem Seal, Exh.	1999-2001			B45870	12
Valve Stem Seal, Int.	1999-2001			B45870	12
Manifold Set, Exhaust	2001			MS16267	1
	2000		California Emission, Thru 6/00	MS16267	1
			From 6/00	MS16267	1
	1999		California Emission	MS16267	1
Manifold Set, Intake	1999-2001		(Contains Plenum Chamber Gasket)	MS16266	1
Rear Main Seal Set	2000		Thru 3/00	JV1062	1
	1999			JV1062	1

MISCELLANEOUS GASKETS					
Camshaft Seal	1999-2001			47918	1
E.G.R. Gasket	1999-2001		Valve <i>Nitroseal</i>	G30714	1
Throttle Body Gasket	1999-2001			G31567	1
Water Outlet Gasket	1999-2001			C31507	1
Water Outlet Hsg. Gasket	1999-2001			C31509	2

26	3497CC (3.5L) 6G74 SOHC V6 Cyl, 3.661in./93mm (1997-2000)					26
-----------	--	--	--	--	--	-----------

Part	Year	VIN	Model/Application	Part Number	Qty.
ENGINE GASKETS					
Head Set	1997-2000		(Head Bolts Not Included, Exhaust Pipe Gasket Not Included, Exhaust Manifold Gasket Not Included), Use With Part Number MS16280	HS54143	1
Lower Set	1997-2000		(Requires Head Set To Make Full Set)	CS54142	1
Cylinder Head Gasket	1997-2000		<i>Multi-Layered Steel</i>	54143S	2
Valve Cover Set	1997-2000		(Contains Spark Plug Tube Seals) <i>Victo-Tech</i>	VS50270	1
Valve Stem Seal, Exh.	1997-2000			B45870A	12
Valve Stem Seal, Int.	1997-2000			B45870A	12
Manifold Set, Exhaust	1997-2000			MS16280	1
Manifold Set, Intake	1997-2000		(Contains Plenum Chamber Gasket)	MS16266	1
Oil Pan Set	1997-2000		(Contains RTV for Upper Pan Gasket)	OS32203	1
Rear Main Seal Set	1997-2000			JV1649	1

MISCELLANEOUS GASKETS					
Injector Nozzle O-Ring	1997-2000			GS33340	1
Spark Plug Tube Seal	1997-2000			B45881-A	1
Throttle Body Gasket	1997-2000			G31568	1

Engine Index

Engine	Year	Block
184 CID (3.0L) L-Head	1953-1954	1
196 CID (3.2L) L-Head American Motors Co.	1953-1955	2

Engine	Year	Block
196 CID (3.2L) OHV American Motors Co.	1956	3
327 CID (5.4L) American Motors Co.	1957	4

Model Index

Model	Engine	Year	Block
Ambassador	327 CID (5.4L) American Motors Co.	1957	4
Rambler	184 CID (3.0L) L-Head	1953-1954	1
Rambler	196 CID (3.2L) OHV American Motors Co.	1956-1960	3
Rambler	196 CID (3.2L) L-Head American Motors Co.	1953-1955	2

Model	Engine	Year	Block
Statesman	196 CID (3.2L) OHV American Motors Co.	1956	3
Statesman	196 CID (3.2L) L-Head American Motors Co.	1952-1955	2

1 184 CID (3.0L) L-Head 6 Cyl, 3.125in./79.4mm (1953-1954) 1

Part	Year	VIN	Model/Application	Part Number	Qty.
------	------	-----	-------------------	-------------	------

ENGINE GASKETS

Head Set	1953-1954			HS1151	1
Cylinder Head Gasket	1953-1954		VR2000	1151	1

MISCELLANEOUS GASKETS

Fuel Pump Gasket	1953-1954			D27094	1
Push Rod Cover Set	1953-1954		Cork Rubber	VS38009	1
Water Outlet Gasket	1953-1954			C25487	1

2 196 CID (3.2L) L-Head American Motors Co. 6 Cyl, 3.125in./79.4mm (1953-1955) 2

Part	Year	VIN	Model/Application	Part Number	Qty.
------	------	-----	-------------------	-------------	------

ENGINE GASKETS

Head Set	1953-1955			HS1151	1
Cylinder Head Gasket	1953-1955		VR2000	1151	1

MISCELLANEOUS GASKETS

Fuel Pump Gasket	1953-1955			D27094	1
Push Rod Cover Set	1953-1955		Cork Rubber	VS38009	1
Water Outlet Gasket	1953-1955			C25487	1

3 196 CID (3.2L) OHV American Motors Co. 6 Cyl, 3.125in./79.4mm (1956) 3

Part	Year	VIN	Model/Application	Part Number	Qty.
------	------	-----	-------------------	-------------	------

ENGINE GASKETS

Valve Cover Set	1956		Victo-Tech	VS29477	1
-----------------	------	--	------------	---------	---

MISCELLANEOUS GASKETS

Fuel Pump Gasket	1956			D27094	1
Push Rod Cover Set	1956		Cork Rubber	VS38009	1
Water Outlet Gasket	1956			C25487	1

4 327 CID (5.4L) American Motors Co. V8 Cyl, 4.000in./101.6mm (1957) 4

Part	Year	VIN	Model/Application	Part Number	Qty.
------	------	-----	-------------------	-------------	------

ENGINE GASKETS

Head Set	1957			HS1137VX	1
Full Set	1957			FS1137BX	1
Cylinder Head Gasket	1957		VR2000	1137VC	2
Valve Cover Set	1957		Victo-Tech	VS27546	1
Manifold Set, Intake	1957			MS15054	1
Oil Pan Set	1957		Cork Rubber	OS30569	1
Rear Main Seal Set	1957			JV696	1
Timing Cover Set	1957			JV796	1

MISCELLANEOUS GASKETS

Exhaust Pipe Gasket	1957		(Flange Type), Pipe To Manifold	F5360C	2
Fuel Pump Gasket	1957			D27094	1

Nash

4 (cont.)	327 CID (5.4L) American Motors Co. V8 Cyl, 4.000in./101.6mm (1957)				4 (cont.)
---------------------	---	--	--	--	---------------------

Part	Year	VIN	Model/Application	Part Number	Qty.
MISCELLANEOUS GASKETS (cont.)					
Push Rod Cover Set	1957			PS38754	1
Water Outlet Gasket	1957			C25487	1

Nissan

Engine Index

Engine	Year	Block	Engine	Year	Block
1171CC (1.2L) A12	1971-1973	1	1952CC (2.0L) Z20S	1980-1981	22
1237CC (1.2L) A12A	1980-1982	2	1974CC (2.0L) CA20E	1984-1989	23
1288CC (1.3L) A13	1974	3	1974CC (2.0L) CA20S	1982-1983	24
1299CC (1.3L) J13	1965-1967	4	1998CC (2.0L) SR20DE DOHC	1991-1994	25
1397CC (1.4L) A14	1975-1982	5	2187CC (2.2L) Z22E SOHC	1982-1983	26
1488CC (1.5L) A15	1979-1982	6	2389CC (2.4L) KA24DE DOHC	1991-1999	27
1488CC (1.5L) E15/E15S	1982-1984	7	2389CC (2.4L) KA24E SOHC	1989-1992	28
1488CC (1.5L) E15T	1983-1984	8	2393CC (2.4L) L24 SOHC	1970-1973	29
1595CC (1.6L) L16	1968-1973	9	2393CC (2.4L) L24E SOHC	1977-1984	30
1595CC (1.6L) R16	1965-1970	10	2565CC (2.6L) L26	1974	31
1597CC (1.6L) E16	1983-1986	11	2753CC (2.8L) L28E SOHC	1975-1983	32
1597CC (1.6L) E16/E16S	1986-1988	12	2753CC (2.8L) L28ET SOHC Turbo	1981-1983	33
1597CC (1.6L) GA16DE	1991-1999	13	2793CC (2.8L) LD28 SOHC Diesel	1981-1983	34
1597CC (1.6L) GA16I	1989-1990	14	2960CC (3.0L) VE30DE DOHC	1992-1994	35
1597CC (1.6L) CA16DE	1987	15	2960CC (3.0L) VG30 SOHC	1984-1989	36
1680CC (1.7L) CD17 Diesel	1983-1990	16	2960CC (3.0L) VG30DE DOHC	1989-1996	37
1770CC (1.8L) L18	1973-1974	17	2960CC (3.0L) VG30DETT DOHC Twin Turbo	1990-1996	38
1809CC (1.8L) CA18DE	1988-1989	18	2960CC (3.0L) VG30E SOHC	1984-1994	39
1809CC (1.8L) CA18ET Turbo	1984-1987	19	2960CC (3.0L) VG30T SOHC Turbo	1984-1989	40
1952CC (2.0L) L20B	1974-1979	20	2987CC (3.0L) VQ30DE DOHC	1995-2001	41
1952CC (2.0L) Z20E	1980-1981	21			

Model Index

Model	Engine	Year	Block	Model	Engine	Year	Block
200SX	1597CC (1.6L) GA16DE	1995-1998	13	710	1770CC (1.8L) L18	1974	17
200SX	1809CC (1.8L) CA18ET Turbo	1984-1987	19	710	1952CC (2.0L) L20B	1975-1977	20
200SX	1952CC (2.0L) Z20E	1980-1981	21	810	2393CC (2.4L) L24E SOHC	1977-1981	30
200SX	1952CC (2.0L) L20B	1977-1979	20	810	2793CC (2.8L) LD28 SOHC Diesel	1981	34
200SX	1974CC (2.0L) CA20E	1984-1988	23	1200 (B110)	1171CC (1.2L) A12	1970-1973	1
200SX	2187CC (2.2L) Z22E SOHC	1982-1983	26	1600 (SPL311)	1595CC (1.6L) R16	1965-1970	10
200SX	2960CC (3.0L) VG30E SOHC	1987-1988	39	Altima	2389CC (2.4L) KA24DE DOHC	1993-2001	27
210	1237CC (1.2L) A12A	1979-1981	2	B210	1171CC (1.2L) A12	1970-1973	1
210	1397CC (1.4L) A14	1979-1982	5	B210	1288CC (1.3L) A13	1973-1974	3
210	1488CC (1.5L) A15	1979-1981	6	B210	1397CC (1.4L) A14	1975-1978	5
240SX	2389CC (2.4L) KA24DE DOHC	1991-1998	27	Bluebird	1595CC (1.6L) R16	1965-1970	10
240SX	2389CC (2.4L) KA24E SOHC	1989-1990	28	F10	1397CC (1.4L) A14	1976-1978	5
240Z	2393CC (2.4L) L24 SOHC	1970-1973	29	Maxima	2393CC (2.4L) L24E SOHC	1982-1984	30
260Z	2565CC (2.6L) L26	1974	31	Maxima	2793CC (2.8L) LD28 SOHC Diesel	1982-1983	34
280Z	2753CC (2.8L) L28E SOHC	1975-1978	32	Maxima	2960CC (3.0L) VE30DE DOHC	1992-1994	35
280ZX	2753CC (2.8L) L28ET SOHC Turbo	1981-1983	33	Maxima	2960CC (3.0L) VG30E SOHC	1984-1994	39
280ZX	2753CC (2.8L) L28E SOHC	1979-1983	32	Maxima	2987CC (3.0L) VQ30DE DOHC	1995-2001	41
300ZX	2960CC (3.0L) VG30DETT DOHC Twin Turbo	1989-1996	38	Multi	1974CC (2.0L) CA20E	1984-1988	23
300ZX	2960CC (3.0L) VG30DE DOHC	1989-1996	37	NX	1597CC (1.6L) GA16DE	1991-1993	13
300ZX	2960CC (3.0L) VG30T SOHC Turbo	1984-1989	40	NX	1998CC (2.0L) SR20DE DOHC	1991-1993	25
300ZX	2960CC (3.0L) VG30 SOHC	1984-1989	36	Pulsar	1488CC (1.5L) E15T	1983-1984	8
310	1397CC (1.4L) A14	1979-1980	5	Pulsar	1597CC (1.6L) GA16I	1989-1990	14
310	1488CC (1.5L) E15/E15S	1982	7	Pulsar	1597CC (1.6L) CA16DE	1987	15
310	1488CC (1.5L) A15	1981	6	Pulsar	1597CC (1.6L) E16/E16S	1986-1988	12
411	1299CC (1.3L) J13	1965-1969	4	Pulsar	1597CC (1.6L) E16	1983-1986	11
411	1595CC (1.6L) R16	1965-1970	10	Pulsar	1809CC (1.8L) CA18DE	1988-1989	18
510	1595CC (1.6L) L16	1968-1973	9	Pulsar NX	1597CC (1.6L) GA16I	1989-1990	14
510	1952CC (2.0L) Z20S	1980-1981	22	Pulsar NX	1597CC (1.6L) E16/E16S	1986-1988	12
510	1952CC (2.0L) L20B	1978-1979	20	Pulsar NX	1597CC (1.6L) E16	1983-1986	11
610	1770CC (1.8L) L18	1973	17				
610	1952CC (2.0L) L20B	1974-1976	20				

Model Index (cont.)

Model	Engine	Year	Block	Model	Engine	Year	Block
Sentra	1488CC (1.5L) E15/E15S	1982-1984	7	Sentra	1998CC (2.0L) SR20DE	1991-1994	25
Sentra	1597CC (1.6L) GA16DE	1991-1999	13		DOHC		
Sentra	1597CC (1.6L) GA16I	1989-1990	14	Stanza	1974CC (2.0L) CA20E	1984-1989	23
Sentra	1597CC (1.6L) E16I/E16S	1986-1988	12	Stanza	1974CC (2.0L) CA20S	1982-1983	24
Sentra	1597CC (1.6L) E16	1983-1986	11	Stanza	2389CC (2.4L) KA24E SOHC	1990-1992	28
Sentra	1680CC (1.7L) CD17 Diesel	1983-1990	16				

1 1171CC (1.2L) A12 4 Cyl, 2.874in./73mm (1971-1973) 1

Part	Year	VIN	Model/Application	Part Number	Qty.
------	------	-----	-------------------	-------------	------

ENGINE GASKETS

Head Set	1971-1973			HS3602	1
Full Set	1971-1973			FS3602	1
Cylinder Head Gasket	1971-1973			<i>Victo-Tech</i> 3602	1
Valve Cover Set	1971-1973			<i>Cork Rubber</i> VS30018	1
Valve Stem Seal, Exh.	1973		(Positive Type)	B20182	4
			(Umbrella Type)	B45443	4
	1972		From 6/72, (Positive Type)	B20182	4
			Thru 6/72, (O-Ring Type)	B20184	4
			From 7/72, (Umbrella Type)	B45443	4
1971		(O-Ring Type)	B20184	4	
Valve Stem Seal, Int.	1973		(Positive Type)	B20182	4
			(Umbrella Type)	B45443	4
	1972		From 6/72, (Positive Type)	B20182	4
			Thru 6/72, (O-Ring Type)	B20184	4
			From 7/72, (Umbrella Type)	B45443	4
1971		(O-Ring Type)	B20184	4	
Manifold Set, Int. & Exh.	1971-1973			MS15232	1
Oil Pan Set	1971-1973			<i>Cork Rubber</i> OS30053	1
Rear Main Seal Set	1971-1973			JV500	1
Timing Cover Set	1971-1973		(Oil Pan Gasket Must Be Replaced)	JV917	1

MISCELLANEOUS GASKETS

E.G.R. Gasket	1971-1973			G26315	1
Fuel Pump Gasket	1971-1973			D24076	2
Water Outlet Gasket	1971-1973			C20116	1

2 1237CC (1.2L) A12A 4 Cyl, 2.953in./75mm (1980-1982) 2

Part	Year	VIN	Model/Application	Part Number	Qty.
------	------	-----	-------------------	-------------	------

ENGINE GASKETS

Head Set	1980-1982			HS3693	1
Full Set	1980-1982			FS3693	1
Engine Kit Gasket Set	1980-1982			95-3436VR	1
Cylinder Head Gasket	1980-1982			3693	1
Valve Cover Set	1980-1982			<i>Cork Rubber</i> VS30018	1
Valve Stem Seal, Exh.	1980-1982			B20182	4
Valve Stem Seal, Int.	1980-1982			B20182	4
Manifold Set, Int. & Exh.	1980-1982		(Intake To Exhaust Manifold Gasket Included)	MS15316	1
Oil Pan Set	1980-1982			OS30055	1
Rear Main Seal Set	1980-1982			JV500	1
Timing Cover Set	1980-1982		(Oil Pan Gasket Must Be Replaced)	JV917	1

MISCELLANEOUS GASKETS

Manifold Gasket	1980-1982		Canadian, Intake To Exhaust	B45589	2
E.G.R. Gasket	1980-1982			G26315	1
Fuel Pump Gasket	1980-1982			D24076	2
Water Outlet Gasket	1982			C26075	1
Water Pump Mount Gasket	1980-1982			K27384	1

Nissan

3 1288CC (1.3L) A13 4 Cyl, 2.874in./73mm (1974) 3

Part	Year	VIN	Model/Application	Part Number	Qty.
ENGINE GASKETS					
Head Set	1974			HS3607	1
Full Set	1974			FS3607	1
Cylinder Head Gasket	1974		VR2000	3607	1
Valve Cover Set	1974		Cork Rubber	VS30018	1
Valve Stem Seal, Exh.	1974			B20182	4
Valve Stem Seal, Int.	1974			B20182	4
Manifold Set, Int. & Exh.	1974			MS15242	1
Oil Pan Set	1974			OS30055	1
Rear Main Seal Set	1974			JV500	1
Timing Cover Set	1974		(Oil Pan Gasket Must Be Replaced)	JV917	1

MISCELLANEOUS GASKETS					
E.G.R. Gasket	1974			G26315	1
Fuel Pump Gasket	1974			D24076	2
Water Outlet Gasket	1974			C20116	1
Water Pump Mount Gasket	1974			K27384	1

4 1299CC (1.3L) J13 4 Cyl, 2.874in./73mm (1965-1967) 4

Part	Year	VIN	Model/Application	Part Number	Qty.
ENGINE GASKETS					
Head Set	1965-1967			HS3597	1
Full Set	1965-1967			FS3597	1
Cylinder Head Gasket	1965-1967		VR2000	3597	1
Valve Cover Set	1965-1967		Cork Rubber	VS30016	1
Manifold Set, Int. & Exh.	1965-1967			MS15233	1
Oil Pan Set	1965-1967		Cork Rubber	OS30054	1
Rear Main Seal Set	1965-1967			JV639	1
Timing Cover Gasket	1965-1967			T20131	1
Timing Cover Seal	1965-1967			66533	1

MISCELLANEOUS GASKETS					
Exhaust Pipe Gasket	1965-1967		(Flange Type), Pipe To Manifold	F14601	1
Water Outlet Gasket	1965-1967			C24093	1

5 1397CC (1.4L) A14 4 Cyl, 2.992in./76mm (1975-1982) 5

Part	Year	VIN	Model/Application	Part Number	Qty.
ENGINE GASKETS					
Head Set	1981-1982		210, Canadian Applications Require Intake And Exhaust Manifold Gasket	HS3605X	1
	1980		210, 310	HS3605W	1
	1979		210, 310, Except California	HS3605	1
			210, 310, California	HS3605W	1
	1976-1978		F10	HS3605	1
	1975-1978		B210, Except California	HS3605	1
			B210, California	HS3605W	1
Full Set	1981-1982		210, Canadian Applications Require Intake And Exhaust Manifold Gasket	FS3605X	1
	1980		210, 310	FS3605W	1
	1979		210, 310, Except California	FS3605	1
			210, 310, California	FS3605W	1
	1976-1978		F10	FS3606	1
	1975-1978		B210, Except California	FS3605	1
			B210, California	FS3605W	1
Engine Kit Gasket Set	1979-1982			95-3436VR	1

5 (cont.)	1497CC (1.4L) A14 4 Cyl, 2.992in./76mm (1975-1982)				5 (cont.)
---------------------	---	--	--	--	---------------------

Part	Year	VIN	Model/Application	Part Number	Qty.	
ENGINE GASKETS (cont.)						
Engine Kit Gasket Set (cont.)	1976-1978		Front Wheel Drive, (Oil Pan Gasket Not Included), Use With Part Number OS30148	95-3436VR	1	
			Rear Wheel Drive	95-3436VR	1	
	1975			95-3436VR	1	
Cylinder Head Gasket	1975-1982			3605	1	
Valve Cover Set	1975-1982		<i>Cork Rubber</i>	VS30018	1	
Valve Stem Seal, Exh.	1975-1982			B20182	4	
Valve Stem Seal, Int.	1975-1982			B20182	4	
Manifold Set, Int. & Exh.	1981-1982		210, Canadian	MS15316	1	
			210, Except Canadian Models	MS15326	1	
	1980		210, 310	MS15316	1	
	1979		210, 310, Except California	MS15272		
			210, 310, California	MS15316	1	
	1976-1978		F10	MS15272	1	
	1975-1978		B210, Except California	MS15272	1	
		B210, California	MS15316	1		
Oil Pan Set	1979-1982		210	OS30055	1	
	1979-1980		310	OS30055	1	
	1976-1978		F10	<i>Cork Rubber</i>	OS30148	1
	1975-1978		B210	OS30055	1	
Rear Main Seal Set	1975-1982			JV500	1	
Timing Cover Set	1975-1982		(Oil Pan Gasket Must Be Replaced)	JV917	1	

MISCELLANEOUS GASKETS

E.G.R. Gasket	1979-1982			G26315	1
Exhaust Pipe Gasket	1975-1979		(Flange Type), Catalytic Converter	F20188	2
Fuel Pump Gasket	1975-1982			D24076	2
Oil Pump Inlet Tube	1976-1982			B45712	1
Water Outlet Gasket	1975-1982			C26075	1
Water Pump Mount Gasket	1975-1982			K27384	1

6	1488CC (1.5L) A15 4 Cyl, 2.992in./76mm (1979-1982)				6
----------	---	--	--	--	----------

Part	Year	VIN	Model/Application	Part Number	Qty.
ENGINE GASKETS					
Head Set	1981-1982			HS3605X	1
	1980			HS3605W	1
	1979		Except California	HS3605	1
			California	HS3605W	1
Full Set	1981-1982			FS3605X	1
	1980			FS3605W	1
	1979		Except California	FS3605	1
			California	FS3605W	1
Engine Kit Gasket Set	1979-1982			95-3436VR	1
Cylinder Head Gasket	1979-1982			3605	1
Valve Cover Set	1979-1982		<i>Cork Rubber</i>	VS30018	1
Valve Stem Seal, Exh.	1979-1982			B20182	4
Valve Stem Seal, Int.	1979-1982			B20182	4
Manifold Set, Int. & Exh.	1981-1982			MS15326	1
				MS15316	1
	1980			MS15316	1
				MS15316	1
1979		Except California	MS15272	1	
		California	MS15316	1	
Oil Pan Set	1979-1982			OS30055	1
Rear Main Seal Set	1979-1982			JV500	1
Timing Cover Set	1979-1982		(Oil Pan Gasket Must Be Replaced)	JV917	1

Nissan

6 (cont.)	1488CC (1.5L) A15 4 Cyl, 2.992in./76mm (1979-1982)				6 (cont.)
---------------------	---	--	--	--	---------------------

Part	Year	VIN	Model/Application	Part Number	Qty.
MISCELLANEOUS GASKETS					
E.G.R. Gasket	1979-1982			G26315	1
Fuel Pump Gasket	1981-1982			D24076	2
Oil Pump Inlet Tube	1979-1982			B45712	1
Water Outlet Gasket	1979-1982			C26075	1
Water Pump Mount Gasket	1979-1982			K27384	1

7	1488CC (1.5L) E15/E15S 4 Cyl, 2.992in./76mm (1982-1984)				7
----------	--	--	--	--	----------

Part	Year	VIN	Model/Application	Part Number	Qty.
ENGINE GASKETS					
Head Set	1982-1984			HS3762	1
Full Set	1982-1984			FS3762	1
Engine Kit Gasket Set	1982-1984			95-3355VR	1
Cylinder Head Gasket	1982-1984		Nitroseal	5757	1
Cyl. Head Spacer Shim	1982-1984		Requires Sealing Compound Steel	5757S	1
Sealing Compound	1982-1984		(4 Ounce Brush Top Can)	JV66B	1
				(12 Ounce Spray Can)	JV66S
Valve Cover Set	1982-1984		(Contains Valve Cover Washers) Victo-Tech	VS38328	1
Valve Stem Seal, Exh.	1982-1984			B45474	4
Valve Stem Seal, Int.	1982-1984			B45474	4
Manifold Set, Exhaust	1982-1984			MS14622	1
Manifold Set, Intake	1982-1984		(Contains Plenum Chamber Gasket)	MS15343	1
Oil Pan Set	1982-1984		Cork Rubber	OS30582	1
Rear Main Seal Set	1982-1984			JV520	1
Timing Cover Set	1982-1984		(Contains Camshaft Seal)	JV975	1

MISCELLANEOUS GASKETS					
Camshaft Seal	1982-1984			66641	1
Dist. Mounting Gasket	1983-1984			B45794	1
E.G.R. Gasket	1982-1984			G26315	1
Exhaust Pipe Gasket	1982-1984		(Flange Type), Pipe To Manifold	F14602	1
Fuel Pump Gasket	1982-1984			D24098	1
Oil Pump Inlet Tube	1982-1984			B45706	1
Oil Pump Mounting Gasket	1982-1984			B45705	1
Therm. Housing Gasket	1982-1984			C24133	1
Water Outlet Gasket	1982-1984			C24131	1
Water Pump Mount Gasket	1982-1984			K27408	1

8	1488CC (1.5L) E15T 4 Cyl, 2.992in./76mm (1983-1984)				8
----------	--	--	--	--	----------

Part	Year	VIN	Model/Application	Part Number	Qty.
ENGINE GASKETS					
Head Set	1983-1984		Pulsar, Turbocharged	HS3732W	1
Full Set	1983-1984		Pulsar, Turbocharged	FS3732W	1
Engine Kit Gasket Set	1983-1984		(Exhaust Manifold Gasket Not Included), Turbocharged, Use With Part Number MS15533	95-3355VR	1
Cylinder Head Gasket	1983-1984		Pulsar, Turbocharged Nitroseal	5757	1
Cyl. Head Spacer Shim	1983-1984		Pulsar, Requires Sealing Compound, Turbocharged Steel	5757S	1
Sealing Compound	1983-1984		(4 Ounce Brush Top Can)	JV66B	1
				(12 Ounce Spray Can)	JV66S
Valve Cover Set	1983-1984		Pulsar, (Contains Valve Cover Washers), Turbocharged Victo-Tech	VS38328	1
Valve Stem Seal, Exh.	1983-1984		Pulsar, Turbocharged	B20182	4

8 (cont.)	1488CC (1.5L) E15T 4 Cyl, 2.992in./76mm (1983-1984)				8 (cont.)
---------------------	--	--	--	--	---------------------

Part	Year	VIN	Model/Application	Part Number	Qty.
ENGINE GASKETS (cont.)					
Valve Stem Seal, Int.	1983-1984		Pulsar, Turbocharged	B20182	4
Manifold Set, Exhaust	1983-1984		Pulsar, Turbocharged	MS15533	1
Manifold Set, Intake	1983-1984		Pulsar, (Contains Plenum Chamber Gasket), Turbocharged	MS15343	1
Plenum Chamber Gasket	1983-1984		Pulsar, Turbocharged	MS12356	1
Oil Pan Set	1983-1984		Pulsar, Turbocharged <i>Cork Rubber</i>	OS30582	1
Rear Main Seal Set	1983-1984		Pulsar, Turbocharged	JV520	1
Timing Cover Set	1983-1984		Pulsar, (Contains Camshaft Seal), Turbocharged	JV975	1

MISCELLANEOUS GASKETS

Camshaft Seal	1983-1984		Pulsar, Turbocharged	66641	1
E.G.R. Gasket	1983-1984		Pulsar, Turbocharged	G20610	2
Oil Pump Inlet Tube	1983-1984		Pulsar, Turbocharged	B45706	1
Oil Pump Mounting Gasket	1983-1984		Pulsar, Turbocharged	B45705	1
Therm. Housing Gasket	1983-1984		Pulsar, Turbocharged	C24133	1
Throttle Body Gasket	1983-1984		Pulsar, Turbocharged	G30953	1
Turbo Gasket Set	1984		Pulsar, Turbocharged	GS27695	1
Water Outlet Gasket	1983-1984		Pulsar, Turbocharged	C24131	1
Water Pump Mount Gasket	1983-1984		Pulsar, Turbocharged	K27408	1

9	1595CC (1.6L) L16 4 Cyl, 3.268in./83mm (1968-1973)				9
----------	---	--	--	--	----------

Part	Year	VIN	Model/Application	Part Number	Qty.
ENGINE GASKETS					
Head Set	1968-1973		510	HS3603	1
Full Set	1968-1973		510	FS3603	1
Engine Kit Gasket Set	1968-1973			95-3354VR	1
Cylinder Head Gasket	1968-1973		510 <i>VR2000</i>	3603	1
Sealing Compound	1968-1973		(4 Ounce Brush Top Can)	JV66B	1
			(12 Ounce Spray Can)	JV66S	1
Valve Cover Set	1968-1973		510 <i>Cork Rubber</i>	VS30015	1
Valve Stem Seal, Exh.	1968-1973		510	B20183	4
Valve Stem Seal, Int.	1968-1973		510	B20183	4
Manifold Set, Int. & Exh.	1968-1973		510	MS15241	1
Oil Pan Set	1968-1973		510 <i>Cork Rubber</i>	OS30051	1
Rear Main Seal Set	1968-1973		510	JV637	1
Timing Cover Set	1968-1973		510	JV916	1
Timing Cover Seal	1968-1973		510	47658	1

MISCELLANEOUS GASKETS

E.G.R. Gasket	1968-1973		510	G26315	1
Exhaust Pipe Gasket	1968-1973		510, (Flange Type), Pipe To Manifold	F14599	1
Fuel Pump Gasket	1968-1973		510	D24076	2
Water Outlet Gasket	1968-1973		510, (2 Holes) <i>Victopac</i>	C20115	1
Water Pump Mount Gasket	1968-1973		510	K26081	1

10	1595CC (1.6L) R16 4 Cyl, 3.433in./87.2mm (1965-1970)				10
-----------	---	--	--	--	-----------

Part	Year	VIN	Model/Application	Part Number	Qty.
ENGINE GASKETS					
Head Set	1965-1970		1600 (SPL311) , 411, Bluebird	HS3600	1
Cylinder Head Gasket	1965-1970		1600 (SPL311) , 411, Bluebird <i>Nitrosea</i>	3598	1
Valve Cover Set	1965-1970		1600 (SPL311) , 411, Bluebird <i>Cork Rubber</i>	VS30017	1
Valve Stem Seal, Exh.	1965-1970		1600 (SPL311) , 411, Bluebird	B45566	4

Nissan

10 <small>(cont.)</small>	1595CC (1.6L) R16 4 Cyl, 3.433in./87.2mm (1965-1970)	10 <small>(cont.)</small>
-------------------------------------	---	-------------------------------------

Part	Year	VIN	Model/Application	Part Number	Qty.
ENGINE GASKETS (cont.)					
Valve Stem Seal, Int.	1965-1970		1600 (SPL311) , 411, Bluebird	B45566	4
Oil Pan Set	1965-1970		1600 (SPL311) , 411, Bluebird <i>Cork Rubber</i>	OS20052	1
Rear Main Seal Set	1965-1967		1600 (SPL311) , 411, Bluebird, 3 Main Bearings, Thru Engine Serial Number R40000	JV639	1
Timing Cover Seal	1965-1970		1600 (SPL311) , 411, Bluebird	66514	1

MISCELLANEOUS GASKETS					
Exhaust Pipe Gasket	1965-1970		1600 (SPL311) , 411, Bluebird, (Flange Type), Pipe To Manifold	F14601	1
Therm. Housing Gasket	1965-1970		1600 (SPL311) , 411, Bluebird	C26084	1
Water Outlet Gasket	1965-1970		1600 (SPL311) , 411, Bluebird	C24093	1

11	1597CC (1.6L) E16 4 Cyl, 2.992in./76mm (1983-1986)	11
-----------	---	-----------

Part	Year	VIN	Model/Application	Part Number	Qty.
------	------	-----	-------------------	-------------	------

ENGINE GASKETS					
Head Set	1983-1986		Pulsar, Pulsar NX, Sentra	HS3762	1
Full Set	1983-1986		Pulsar, Pulsar NX, Sentra	FS3762	1
Engine Kit Gasket Set	1983-1986		2 Barrel Carburetor	95-3355VR	1
Cylinder Head Gasket	1983-1986		Pulsar, Pulsar NX, Sentra <i>Nitroseal</i>	5757	1
Cyl. Head Spacer Shim	1983-1986		Pulsar, Pulsar NX, Sentra, Requires Sealing Compound <i>Steel</i>	5757S	1
Sealing Compound	1983-1986		(4 Ounce Brush Top Can)	JV66B	1
			(12 Ounce Spray Can)	JV66S	1
Valve Cover Set	1983-1986		Pulsar, Pulsar NX, Sentra, (Contains Valve Cover Washers) <i>Victo-Tech</i>	VS38328	1
Valve Stem Seal, Exh.	1983-1986		Pulsar, Pulsar NX, Sentra	B45474	4
Valve Stem Seal, Int.	1983-1986		Pulsar, Pulsar NX, Sentra	B45474	4
Manifold Set, Exhaust	1983-1986		Pulsar, Pulsar NX, Sentra	MS14622	1
Manifold Set, Intake	1983-1986		Pulsar, Pulsar NX, Sentra, (Contains Plenum Chamber Gasket)	MS15343	1
Oil Pan Set	1983-1986		Pulsar, Pulsar NX, Sentra <i>Cork Rubber</i>	OS30582	1
Rear Main Seal Set	1983-1986		Pulsar, Pulsar NX, Sentra	JV520	1
Timing Cover Set	1983-1986		Pulsar, Pulsar NX, Sentra, (Contains Camshaft Seal)	JV975	1

MISCELLANEOUS GASKETS					
Camshaft Seal	1983-1986		Pulsar, Pulsar NX, Sentra	66641	1
Dist. Mounting Gasket	1983-1986		Pulsar, Pulsar NX, Sentra	B45794	1
E.G.R. Gasket	1983-1986		Pulsar, Pulsar NX, Sentra	G26315	1
Fuel Pump Gasket	1983-1986		Pulsar, Pulsar NX, Sentra	D24098	1
Oil Pump Inlet Tube	1983-1986		Pulsar, Pulsar NX, Sentra	B45706	1
Oil Pump Mounting Gasket	1983-1986		Pulsar, Pulsar NX, Sentra	B45705	1
Therm. Housing Gasket	1983-1986		Pulsar, Pulsar NX, Sentra	C24133	1
Water Outlet Gasket	1983-1986		Pulsar, Pulsar NX, Sentra	C24131	1
Water Pump Mount Gasket	1983-1986		Pulsar, Pulsar NX, Sentra	K27408	1

12	1597CC (1.6L) E16I/E16S 4 Cyl, 2.992in./76mm (1986-1988)	12
-----------	---	-----------

Part	Year	VIN	Model/Application	Part Number	Qty.
------	------	-----	-------------------	-------------	------

ENGINE GASKETS					
Head Set	1986-1988			HS5757	1
Full Set	1986-1988		(Oil Pan Gasket Not Included)	FS5757	1
Engine Kit Gasket Set	1986-1988			95-3356VR	1
Cylinder Head Gasket	1986-1988		<i>Nitroseal</i>	5757	1
Cyl. Head Spacer Shim	1986-1988		Requires Sealing Compound <i>Steel</i>	5757S	1

12 1597CC (1.6L) E161/E16S 4 Cyl, 2.992in./76mm (1986-1988)

(cont.)

12

(cont.)

<i>Part</i>	<i>Year</i>	<i>VIN</i>	<i>Model/Application</i>	<i>Part Number</i>	<i>Qty.</i>
ENGINE GASKETS (cont.)					
Sealing Compound	1986-1988		(4 Ounce Brush Top Can)	JV66B	1
			(12 Ounce Spray Can)	JV66S	1
Valve Cover Set	1986-1988		<i>Victo-Tech</i>	VS50036	1
Valve Stem Seal, Exh.	1986-1988			B45474	4
Valve Stem Seal, Int.	1986-1988			B45474	4
Manifold Set, Exhaust	1986-1988			MS12371	1
Manifold Set, Intake	1986-1988		(Contains Plenum Chamber Gasket)	MS15343	1
Oil Pan Set	1986-1988			OS32090	1
Rear Main Seal Set	1986-1988			JV520	1
Timing Cover Set	1986-1988		(Contains Camshaft Seal)	JV975	1

MISCELLANEOUS GASKETS

Camshaft Seal	1986-1988			66641	1
Carb. Mount Gasket	1987-1988		Except California, Upper	G31277	1
			Except California, Lower	G31278	1
			California, Upper	G31279	1
			California, Lower	G31280	1
	1986-1988		Except California, 2 Barrel Carburetor, Upper	G31277	1
			Except California, Upper	G31277	1
			Except California, 2 Barrel Carburetor, Lower	G31278	1
			Except California, Lower	G31278	1
			California, 2 Barrel Carburetor, Upper	G31279	1
			California, Upper	G31279	1
			California, 2 Barrel Carburetor, Lower	G31280	1
			California, Lower	G31280	1
	1986-1987		Except California, 2 Barrel Carburetor, Upper	G31277	1
			Except California, 2 Barrel Carburetor, Lower	G31278	1
California, 2 Barrel Carburetor, Upper			G31279	1	
California, 2 Barrel Carburetor, Lower			G31280	1	
Dist. Mounting Gasket	1987			B45794	1
Exhaust Pipe Gasket	1986-1988		(Flange Type), Pipe To Manifold	F7433	1
			(Flange Type), Catalytic Converter To Exhaust Pipe	F7434	1
Fuel Pump Gasket	1986			D24077	2
Oil Pan Seal	1986-1988		(Requires RTV), Front	B45586	1
			(Requires RTV), Rear	B45587	1
Oil Pump Inlet Tube	1986-1988			B45706	1
Oil Pump Mounting Gasket	1986-1988			B45705	1
Therm. Housing Gasket	1986-1988			C24133	1
Valve Cover Washer Seal	1986-1988			B45865	2
Water Outlet Gasket	1986-1988			C24131	1
Water Pump Mount Gasket	1986-1988			K27408	1

13 1597CC (1.6L) GA16DE 4 Cyl, 2.992in./76mm (1991-1999)**13**

<i>Part</i>	<i>Year</i>	<i>VIN</i>	<i>Model/Application</i>	<i>Part Number</i>	<i>Qty.</i>
ENGINE GASKETS					
Head Set	1995-1999			HS4895A	1
	1991-1994			HS4895	1
Lower Set	1991-1999			CS4895	1
Full Set	1991-1994		(Requires RTV)	FS4895	1
Cylinder Head Gasket	1991-1999		<i>Nitroseal</i>	4895	1
Cyl. Head Spacer Shim	1991-1999		Requires Sealing Compound <i>Steel</i>	4895S	1
Sealing Compound	1991-1999		(4 Ounce Brush Top Can)	JV66B	1

Nissan

13 (cont.)	1597CC (1.6L) GA16DE 4 Cyl, 2.992in./76mm (1991-1999)				13 (cont.)
----------------------	--	--	--	--	----------------------

Part	Year	VIN	Model/Application	Part Number	Qty.
------	------	-----	-------------------	-------------	------

ENGINE GASKETS (cont.)

Sealing Compound (cont.)	1991-1999		(12 Ounce Spray Can)	JV66S	1
Valve Cover Set	1995-1999		(Single Valve Cover)	VS50288	1
			(Contains Valve Cover End Plug, Spark Plug Tube Seals Not Included/Cannot Be Serviced)	VS50289	1
	1991-1994		(Contains Spark Plug Tube Seals) <i>Victo-Tech</i>	VS50139	1
Valve Stem Seal, Exh.	1991-1999			B45722	8
Valve Stem Seal, Int.	1991-1999			B45722	8
Manifold Set, Exhaust	1991-1999			MS12370	1
Manifold Set, Intake	1995-1999		(Contains Plenum Chamber Gasket)	MS16345	1
	1991-1994		(Contains Plenum Chamber Gasket)	MS15548	1
Plenum Chamber Gasket	1995-1999			MS16346	1
	1991-1994			MS13999	1
Oil Pan Set	1991-1999			OS32100	1
Rear Main Seal	1991-1999		<i>Rubber</i>	67119	1
Rear Main Seal Set	1991-1999			JV1650	1
Timing Cover Set	1995-1999			JV5005	1
	1991-1994		Use With Part Numbers OS32100, VS50102	JV5005	1
Timing Cover Seal	1991-1999		(Requires RTV)	67124	1

MISCELLANEOUS GASKETS

E.G.R. Gasket	1991-1999			G20610	2
Exhaust Pipe Gasket	1991-1999		(Ring Type 'A'), Pipe To Manifold	F7283	1
			(Flange Type), Catalytic Converter To Exhaust Pipe <i>Composition</i>	F7285	2
			Front Muffler	F10121	1
Oil Pump Inlet Tube	1991-1999			B45707	1
Throttle Body Gasket	1991-1999			G31161	1
Water Outlet Gasket	1991-1999			C31511	1
Water Pump Mount Gasket	1991-1999			K31621	1

14	1597CC (1.6L) GA16I 4 Cyl, 2.992in./76mm (1989-1990)				14
-----------	---	--	--	--	-----------

Part	Year	VIN	Model/Application	Part Number	Qty.
------	------	-----	-------------------	-------------	------

ENGINE GASKETS

Head Set	1989-1990			HS5864	1
Full Set	1989-1990		(Oil Pan Gasket Not Included)	FS5864	1
Engine Kit Gasket Set	1989-1990			95-3357VR	1
Cylinder Head Gasket	1989-1990		<i>Nitroseal</i>	5864	1
Cyl. Head Spacer Shim	1989-1990		Requires Sealing Compound <i>Steel</i>	5864S	1
Sealing Compound	1989-1990		(4 Ounce Brush Top Can)	JV66B	1
			(12 Ounce Spray Can)	JV66S	1
Valve Cover Set	1989-1990		<i>Victo-Tech</i>	VS50102	1
Valve Stem Seal, Exh.	1989-1990			B45658	4
Valve Stem Seal, Int.	1989-1990			B45601	4
Manifold Set, Exhaust	1989-1990			MS15662	1
Manifold Set, Intake	1989-1990			MS15659	1
Oil Pan Set	1989-1990			OS32100	1
Rear Main Seal	1989-1990		<i>Rubber</i>	67119	1
Timing Cover Set	1989-1990		Use With Part Numbers OS32100, VS50102	JV5005	1
Timing Cover Seal	1989-1990		(Requires RTV)	67124	1

MISCELLANEOUS GASKETS

E.G.R. Gasket	1989-1990			G20610	2
Exhaust Pipe Gasket	1989-1990		(Ring Type 'A'), Pipe To Manifold	F7283	1
			(Flange Type), Catalytic Converter To Exhaust Pipe <i>Metal</i>	F7480	2

14	1597CC (1.6L) GA16I 4 Cyl, 2.992in./76mm (1989-1990)	14
(cont.)		(cont.)

Part	Year	VIN	Model/Application	Part Number	Qty.
MISCELLANEOUS GASKETS (cont.)					
Oil Pump Inlet Tube	1989-1990			B45707	1
Water Outlet Gasket	1989-1990			C31511	1
Water Pump Mount Gasket	1989-1990		Original Equipment Uses RTV <i>Silicone</i>	JV6	1

15	1597CC (1.6L) CA16DE 4 Cyl, 3.071in./78mm (1987)	15
-----------	---	-----------

Part	Year	VIN	Model/Application	Part Number	Qty.
ENGINE GASKETS					
Head Set	1987			HS5766	1
Full Set	1987		(Oil Pan Gasket Not Included)	FS5766	1
Cylinder Head Gasket	1987		<i>Nitroseal</i>	5766	1
Cyl. Head Spacer Shim	1987		Requires Sealing Compound <i>Steel</i>	5766S	1
Sealing Compound	1987		(4 Ounce Brush Top Can)	JV66B	1
			(12 Ounce Spray Can)	JV66S	1
Valve Cover Set	1987		(Contains Valve Cover Washers, Contains Valve Cover End Plug), Right <i>Victo-Tech</i>	VS50055	1
			(Contains Valve Cover Washers, Contains Valve Cover End Plug), Left <i>Victo-Tech</i>	VS50056	1
Valve Stem Seal, Exh.	1987			B45601	8
Valve Stem Seal, Int.	1987			B45601	8
Manifold Set, Exhaust	1987			MS12345	1
Manifold Set, Intake	1987		(Contains Plenum Chamber Gasket)	MS15453	1
Plenum Chamber Gasket	1987			MS12357	1
Oil Pan Set	1987		To Be Replaced By OS32479	OS32091	1
Rear Main Seal Set	1987			JV521	1
Timing Cover Set	1987			JV1064	1

MISCELLANEOUS GASKETS

Camshaft Seal	1987			66991	2
E.G.R. Gasket	1987		<i>Nitroseal</i>	G31088	1
			Gallery Cover	G31452	1
Exhaust Pipe Gasket	1987		(Flange Type), Catalytic Converter To Exhaust Pipe	F7434	1
			(Flange Type), Pipe To Manifold	F10047	1
Oil Pan Seal	1987		(Requires RTV), Front	B45599	1
			(Requires RTV), Rear	B45600	1
Oil Pump Inlet Tube	1987			B45704	1
Oil Pump Mounting Gasket	1987			H45691	1
Throttle Body Gasket	1987			G30823	1
Valve Cover End Plug	1987		(Half Round)	B45619	2
Water Outlet Gasket	1987			C24179	1
Water Pump Mount Gasket	1987			K27423	1

16	1680CC (1.7L) CD17 Diesel 4 Cyl, 3.150in./80mm (1983-1990)	16
-----------	---	-----------

Part	Year	VIN	Model/Application	Part Number	Qty.
ENGINE GASKETS					
Head Set	1986-1990		Canadian, (Head Gasket Not Included, Thickness Is Identified By Groove In Edge Of Gasket, Replacement Gasket Must Be Of Same Thickness As One Removed)	HS3759	1
	1983-1985		(Head Gasket Not Included, Thickness Is Identified By Groove In Edge Of Gasket, Replacement Gasket Must Be Of Same Thickness As One Removed)	HS3759	1
Full Set	1983-1985		(Head Gasket Not Included, Thickness Is Identified By Groove In Edge Of Gasket, Replacement Gasket Must Be Of Same Thickness As One Removed)	FS3759	1

Nissan

16 (cont.)	1680CC (1.7L) CD17 Diesel 4 Cyl, 3.150in./80mm (1983-1990)				16 (cont.)
----------------------	---	--	--	--	----------------------

Part	Year	VIN	Model/Application	Part Number	Qty.
------	------	-----	-------------------	-------------	------

ENGINE GASKETS (cont.)

Cylinder Head Gasket	1986-1990		Canadian, (1 Groove) Nitroseal, 1.15mm Thickness	3759	1
			Canadian, (2 Grooves) 1.20mm Thickness	3760	1
			Canadian, (3 Grooves) 1.25mm Thickness	3761	1
	1983-1985		(1 Groove) Nitroseal, 1.15mm Thickness	3759	1
			(2 Grooves) 1.20mm Thickness	3760	1
			(3 Grooves) 1.25mm Thickness	3761	1
Valve Cover Set	1986-1990		Canadian Victo-Tech	VS38365	1
	1983-1985		Victo-Tech	VS38365	1
Valve Stem Seal, Exh.	1983-1990			B45475	4
Valve Stem Seal, Int.	1983-1990			B45475	4
Manifold Set, Int. & Exh.	1983-1990			MS15354	1
Oil Pan Set	1983-1990		Victo-Tech	OS30584	1
Rear Main Seal Set	1983-1990			JV521	1
Timing Cover Set	1983-1985		(Requires Oil Pan Set)	JV1000	1
Timing Cover Seal	1983-1985			66881	1

MISCELLANEOUS GASKETS

Camshaft Seal	1986-1990		Front	66864	1
	1983-1990		Rear	66868	1
E.G.R. Gasket	1983-1985			G26315	1
Exhaust Pipe Gasket	1983-1990		(Flange Type), Pipe To Manifold	F10047	1
Oil Pump Inlet Tube	1983-1990			B45703	1
Oil Pump Mounting Gasket	1983-1990			H45691	1
Water Outlet Gasket	1983-1990			C24093	1
Water Pump Mount Gasket	1983-1990			K27354	1

17	1770CC (1.8L) L18 4 Cyl, 3.346in./85mm (1973-1974)				17
-----------	---	--	--	--	-----------

Part	Year	VIN	Model/Application	Part Number	Qty.
------	------	-----	-------------------	-------------	------

ENGINE GASKETS

Head Set	1973-1974			HS3603	1
Full Set	1973-1974			FS3603	1
Engine Kit Gasket Set	1973-1974			95-3354VR	1
Cylinder Head Gasket	1973-1974		VR2000	3603	1
Sealing Compound	1973-1974		(4 Ounce Brush Top Can)	JV66B	1
			(12 Ounce Spray Can)	JV66S	1
Valve Cover Set	1973-1974		Cork Rubber	VS30015	1
Valve Stem Seal, Exh.	1974		Thru 8/74	B20183	4
	1973			B20183	4
Valve Stem Seal, Int.	1974		Thru 8/74	B20183	4
	1973			B20183	4
Manifold Set, Int. & Exh.	1973-1974			MS15241	1
Oil Pan Set	1973-1974		Cork Rubber	OS30051	1
Rear Main Seal Set	1973-1974			JV637	1
Timing Cover Set	1973-1974			JV916	1
Timing Cover Seal	1973-1974			47658	1

MISCELLANEOUS GASKETS

E.G.R. Gasket	1973-1974			G26315	1
Exhaust Pipe Gasket	1973-1974		(Flange Type), Pipe To Manifold	F14599	1
Fuel Pump Gasket	1973-1974			D24076	2
Therm. Housing Gasket	1973-1974			C26084	1
Water Outlet Gasket	1973-1974		(2 Holes) Victopac	C20115	1
			(3 Holes)	C24179	1

17 (cont.)	1770CC (1.8L) L18 4 Cyl, 3.346in./85mm (1973-1974)	17 (cont.)
----------------------	---	----------------------

Part	Year	VIN	Model/Application	Part Number	Qty.
------	------	-----	-------------------	-------------	------

MISCELLANEOUS GASKETS (cont.)

Water Pump Mount Gasket	1973-1974			K26081	1
-------------------------	-----------	--	--	--------	---

18	1809CC (1.8L) CA18DE 4 Cyl, 3.268in./83mm (1988-1989)	18
-----------	--	-----------

Part	Year	VIN	Model/Application	Part Number	Qty.
------	------	-----	-------------------	-------------	------

ENGINE GASKETS

Head Set	1988-1989			HS5862	1
Full Set	1988-1989			FS5862	1
Cylinder Head Gasket	1988-1989		Nitroseal	5862	1
Valve Cover Set	1988-1989		(Contains Valve Cover Washers, Contains Valve Cover End Plug), Right <i>Victo-Tech</i>	VS50055	1
			(Contains Valve Cover Washers, Contains Valve Cover End Plug), Left <i>Victo-Tech</i>	VS50056	1
Valve Stem Seal, Exh.	1988-1989			B45601	8
Valve Stem Seal, Int.	1988-1989			B45601	8
Manifold Set, Exhaust	1988-1989			MS12345	1
Manifold Set, Intake	1988-1989		(Contains Plenum Chamber Gasket)	MS15453	1
Plenum Chamber Gasket	1988-1989			MS12357	1
Oil Pan Set	1988-1989		(Requires RTV) <i>Victo-Tech</i>	OS32479	1
Rear Main Seal Set	1988-1989			JV521	1
Timing Cover Set	1988-1989			JV1064	1

MISCELLANEOUS GASKETS

Camshaft Seal	1988-1989			66991	2
E.G.R. Gasket	1988-1989			G26315	1
			Gallery Cover	G31452	1
Exhaust Pipe Gasket	1988-1989		(Flange Type), Catalytic Converter To Exhaust Pipe <i>Metal</i>	F7480	2
			(Flange Type), Pipe To Manifold	F10047	1
Oil Pump Inlet Tube	1988-1989			B45704	1
Oil Pump Mounting Gasket	1988-1989			H45691	1
Throttle Body Gasket	1988-1989			G30823	1
Water Outlet Gasket	1988-1989			C24179	1
Water Pump Mount Gasket	1988-1989			K27423	1

19	1809CC (1.8L) CA18ET Turbo 4 Cyl, 3.268in./83mm (1984-1987)	19
-----------	--	-----------

Part	Year	VIN	Model/Application	Part Number	Qty.
------	------	-----	-------------------	-------------	------

ENGINE GASKETS

Head Set	1984-1987			HS4833	1
Lower Set	1984-1987		(Contains 1 Piece Oil Pan Gasket)	CS3784	1
Full Set	1987		(Requires Oil Pan Set)	FS4833	1
	1986		From 7/1/86, (Requires Oil Pan Set)	FS4833	1
	1984-1985			FS4833	1
Cylinder Head Gasket	1984-1987		Nitroseal	4833	1
Valve Cover Set	1984-1987		(Contains Valve Cover Washers) <i>Victo-Tech</i>	VS38330	1
Valve Stem Seal, Exh.	1984-1987			B45475	4
Valve Stem Seal, Int.	1984-1987			B45475	4
Manifold Set, Exhaust	1984-1987			MS10053	1
Manifold Set, Intake	1984-1987		(Contains Plenum Chamber Gasket)	MS15370	1
Oil Pan Set	1987		To Be Replaced By OS32479	OS32091	1
	1986		Thru 6/30/86 <i>Victo-Tech</i>	OS30584	1
			From 7/1/86, To Be Replaced By OS32479	OS32091	1
1984-1985		<i>Victo-Tech</i>	OS30584	1	
Rear Main Seal Set	1984-1987			JV521	1
Timing Cover Set	1984-1987		(Requires Oil Pan Set)	JV1005	1

Nissan

19 (cont.)	1809CC (1.8L) CA18ET Turbo 4 Cyl, 3.268in./83mm (1984-1987)				19 (cont.)
----------------------	--	--	--	--	----------------------

Part	Year	VIN	Model/Application	Part Number	Qty.
------	------	-----	-------------------	-------------	------

ENGINE GASKETS (cont.)

Timing Cover Seal	1984-1987			66881	1
-------------------	-----------	--	--	-------	---

MISCELLANEOUS GASKETS

Camshaft Seal	1984-1987			66864	1
E.G.R. Gasket	1984-1986			G26315	1
Exhaust Pipe Gasket	1987		(Flange Type), Catalytic Converter To Exhaust Pipe <i>Composition</i>	F7285	2
			From 3/86, (Flange Type), Catalytic Converter To Exhaust Pipe <i>Composition</i>	F7285	2
	1986		Thru 2/86, (Flange Type), Catalytic Converter To Exhaust Pipe	F20188	2
			(Flange Type), Catalytic Converter To Exhaust Pipe	F20188	2
Oil Pump Inlet Tube	1984-1987			B45703	1
Oil Pump Mounting Gasket	1984-1987			H45691	1
Throttle Body Gasket	1984-1987			G30954	1
Turbo Gasket Set	1984-1985			GS27699	1
Water Outlet Gasket	1984-1987			C24179	1
Water Pump Mount Gasket	1984-1987			K27423	1

20	1952CC (2.0L) L20B 4 Cyl, 3.346in./85mm (1974-1979)				20
-----------	--	--	--	--	-----------

Part	Year	VIN	Model/Application	Part Number	Qty.
------	------	-----	-------------------	-------------	------

ENGINE GASKETS

Head Set	1978-1979		510	HS3603W	1
	1977-1979		200SX	HS3603W	1
	1977		710	HS3603W	1
	1976		610, 710, From 11/76	HS3603W	1
			Thru 10/76	HS3603Y	1
	1975			HS3603Y	1
	1974		610, 710	HS3603	1
Full Set	1978-1979		510	FS3603W	1
	1977-1979		200SX	FS3603W	1
	1977		710	FS3603W	1
			610, 710, From 11/76	FS3603W	1
	1976		610, 710, Thru 10/76	FS3603Y	1
			610, 710	FS3603Y	1
	1974		610	FS3603	1
Engine Kit Gasket Set	1977-1979			95-3079VR	1
	1974-1976			95-3354VR	1
Cylinder Head Gasket	1974-1979		VR2000	3603	1
Sealing Compound	1974-1979		(4 Ounce Brush Top Can)	JV66B	1
			(12 Ounce Spray Can)	JV66S	1
Valve Cover Set	1974-1979		Cork Rubber	VS30015	1
Valve Stem Seal, Exh.	1974-1979			B20183	4
Valve Stem Seal, Int.	1974-1979			B20183	4
Manifold Set, Int. & Exh.	1978-1979		510, (Contains Intake To Exhaust Manifold Gasket)	MS15284	1
	1977-1979		200SX, (Contains Intake To Exhaust Manifold Gasket)	MS15284	1
	1977		710, (Contains Intake To Exhaust Manifold Gasket)	MS15284	1
			710, From 11/76, (Contains Intake To Exhaust Manifold Gasket)	MS15284	1
	1976		610, 710, Thru 10/76, (Contains Intake To Exhaust Manifold Gasket)	MS15580	1
			610, 710, (Contains Intake To Exhaust Manifold Gasket)	MS15580	1
	1974		610	MS15241	1
Oil Pan Set	1974-1979		Cork Rubber	OS30051	1
Rear Main Seal Set	1974-1979			JV637	1

20 (cont.)	1952CC (2.0L) L20B 4 Cyl, 3.346in./85mm (1974-1979)				20 (cont.)
----------------------	--	--	--	--	----------------------

Part	Year	VIN	Model/Application	Part Number	Qty.
------	------	-----	-------------------	-------------	------

ENGINE GASKETS (cont.)

Timing Cover Set	1974-1979			JV916	1
Timing Cover Seal	1974-1979			47658	1

MISCELLANEOUS GASKETS

Manifold Gasket	1975-1979		Intake To Exhaust	B45589	1
Carb. Mount Gasket	1977-1979		200SX, 2 Barrel Carburetor	G31154	1
E.G.R. Gasket	1974-1979			G26315	1
Exhaust Pipe Gasket	1975-1979		(Flange Type), Catalytic Converter To Exhaust Pipe	F20188	2
	1974		610, (Flange Type), Pipe To Manifold	F14599	1
Fuel Pump Gasket	1974-1979			D24076	2
Oil Pump Inlet Tube	1974-1979			B45711	1
Oil Pump Mounting Gasket	1974-1979			B45694	1
Therm. Housing Gasket	1974-1979			C26084	1
Water Inlet Gasket	1974-1979			C26076	1
Water Outlet Gasket	1974-1979		(2 Holes) <i>Victopac</i>	C20115	1
			(3 Holes)	C24179	1
Water Pump Mount Gasket	1974-1979			K26081	1

21	1952CC (2.0L) Z20E 4 Cyl, 3.346in./85mm (1980-1981)				21
-----------	--	--	--	--	-----------

Part	Year	VIN	Model/Application	Part Number	Qty.
------	------	-----	-------------------	-------------	------

ENGINE GASKETS

Head Set	1980-1981		200SX, (Requires Throttle Body Gasket)	HS3691	1
Full Set	1980-1981		200SX, (Requires Throttle Body Gasket)	FS3691	1
Cylinder Head Gasket	1980-1981		200SX <i>VR2000</i>	3691	1
Valve Cover Set	1980-1981		200SX, (Contains Valve Cover End Plugs) <i>Cork Rubber</i>	VS20344	1
Valve Stem Seal, Exh.	1980-1981		200SX	B20183	4
Valve Stem Seal, Int.	1980-1981		200SX	B20183	4
Manifold Set, Exhaust	1980-1981		200SX	MS12275	1
Manifold Set, Intake	1980-1981		200SX	MS15322	1
Oil Pan Set	1980-1981		200SX <i>Cork Rubber</i>	OS30051	1
Rear Main Seal Set	1980-1981		200SX	JV637	1
Timing Cover Set	1980-1981		200SX	JV916	1

MISCELLANEOUS GASKETS

E.G.R. Gasket	1980-1981		200SX	G20610	2
Exhaust Pipe Gasket	1980-1981		200SX, (Flange Type), Pipe To Manifold	F10047	1
Oil Pump Inlet Tube	1980-1981		200SX	B45711	1
Oil Pump Mounting Gasket	1980-1981			B45694	1
Throttle Body Gasket	1981		200SX	GS33155	1
	1980		200SX	GS33160	1
Valve Cover End Plug	1980-1981		200SX, (Half Round)	B45488	2
Water Outlet Gasket	1980-1981		200SX, (2 Holes) <i>Victopac</i>	C20115	1
Water Pump Mount Gasket	1980-1981		200SX	K26081	1

22	1952CC (2.0L) Z20S 4 Cyl, 3.346in./85mm (1980-1981)				22
-----------	--	--	--	--	-----------

Part	Year	VIN	Model/Application	Part Number	Qty.
------	------	-----	-------------------	-------------	------

ENGINE GASKETS

Head Set	1981		510	HS3691	1
	1980		510, California Intake Manifold Gasket Not Included	HS3691W	1
Full Set	1981		510	FS3691	1
	1980		510, California Intake Manifold Gasket Not Included	FS3691W	1
Cylinder Head Gasket	1980-1981		510 <i>VR2000</i>	3691	1

Nissan

22 (cont.)	1952CC (2.0L) Z20S 4 Cyl, 3.346in./85mm (1980-1981)	22 (cont.)
----------------------	--	----------------------

Part	Year	VIN	Model/Application	Part Number	Qty.
ENGINE GASKETS (cont.)					
Valve Cover Set	1980-1981		510, (Contains Valve Cover End Plugs) <i>Cork Rubber</i>	VS20344	1
Valve Stem Seal, Exh.	1980-1981		510	B20183	4
Valve Stem Seal, Int.	1980-1981		510	B20184	4
Manifold Set, Exhaust	1981		510	MS12275	1
	1980		510	MS12286	1
Manifold Set, Intake	1981		510	MS15322	1
	1980		510, Except California	MS10032	1
				510, California	MS15322
Oil Pan Set	1980-1981		510 <i>Cork Rubber</i>	OS30051	1
Rear Main Seal Set	1980-1981		510	JV637	1
Timing Cover Set	1980-1981		510	JV916	1

MISCELLANEOUS GASKETS					
E.G.R. Gasket	1980-1981		510	G26315	1
Fuel Pump Gasket	1980-1981		510	D24076	2
Valve Cover End Plug	1980-1981		510, (Half Round)	B45488	2
Water Outlet Gasket	1980-1981		510, (2 Holes) <i>Victopac</i>	C20115	1
Water Pump Mount Gasket	1980-1981		510	K26081	1

23	1974CC (2.0L) CA20E 4 Cyl, 3.327in./84.5mm (1984-1989)	23
-----------	---	-----------

Part	Year	VIN	Model/Application	Part Number	Qty.
ENGINE GASKETS					
Head Set	1987-1989		Stanza, (Requires Throttle Body Gasket)	HS3784Z	1
	1987-1988		200SX, (Requires Throttle Body Gasket)	HS3784Y	1
	1986-1988		Stanza, Station Wagon, (Requires Throttle Body Gasket)	HS3784W	1
	1986		Stanza, Hatchback, Sedan, (Requires Throttle Body Gasket)	HS3784X	1
	1984-1986		200SX, (Requires Throttle Body Gasket)	HS3784	1
	1984-1985		Stanza, (Requires Throttle Body Gasket)	HS3784	1
Lower Set	1984-1989		(Contains 1 Piece Oil Pan Gasket)	CS3784	1
Full Set	1986		Stanza, Hatchback, Sedan, (Requires RTV, Requires Throttle Body Gasket)	FS3784X	1
Engine Kit Gasket Set	1987-1989		200SX, Stanza Wagon	95-3238VR	1
			200SX, Stanza Wagon, Stanza, (Valve Cover Gasket Not Included), Use With Part Number VS50034	95-3238VR	1
			Stanza, (Valve Cover Gasket Not Included), Use With Part Number VS50034	95-3238VR	1
	1984-1986			95-3238VR	1
Cylinder Head Gasket	1984-1989		<i>Nitroseal</i>	3784	1
Cyl. Head Spacer Shim	1984-1989		Requires Sealing Compound <i>Steel</i>	3784S	1
Sealing Compound	1984-1989		(4 Ounce Brush Top Can)	JV66B	1
			(12 Ounce Spray Can)	JV66S	1
Valve Cover Set	1987-1989		Stanza, Hatchback, Sedan, (Contains Valve Cover Washers) <i>Victo-Tech</i>	VS50034	1
	1987-1988		Stanza, Station Wagon, (Contains Valve Cover Washers) <i>Victo-Tech</i>	VS38330	1
	1984-1988		200SX, (Contains Valve Cover Washers) <i>Victo-Tech</i>	VS38330	1
	1984-1986		Stanza, (Contains Valve Cover Washers) <i>Victo-Tech</i>	VS38330	1
Valve Stem Seal, Exh.	1984-1989			B45475	4
Valve Stem Seal, Int.	1984-1989			B45475	4
Manifold Set, Exhaust	1986-1989		Stanza	MS10062	1
	1984-1988		200SX	MS10053	1
	1984-1985		Stanza	MS10053	1
Manifold Set, Intake	1984-1989		(Contains Plenum Chamber Gasket)	MS15370	1
Plenum Chamber Gasket	1985-1989		Stanza	MS12355	1
	1984-1988		200SX	MS12348	1

23 1974CC (2.0L) CA20E 4 Cyl, 3.327in./84.5mm (1984-1989)**23**

(cont.)

(cont.)

Part	Year	VIN	Model/Application	Part Number	Qty.
ENGINE GASKETS (cont.)					
Oil Pan Set	1987-1989			<i>Victo-Tech</i> OS32479	1
	1984-1986			<i>Victo-Tech</i> OS30584	1
Rear Main Seal Set	1984-1989			JV521	1
Timing Cover Set	1987-1988		200SX, (Requires RTV)	JV1060	1
	1984-1986		(Requires RTV)	JV1006	1
Timing Cover Seal	1984-1989		(Requires RTV)	66881	1

MISCELLANEOUS GASKETS

Camshaft Seal	1984-1989			66864	1
E.G.R. Gasket	1984-1989			G26315	1
Exhaust Pipe Gasket	1986-1989		Stanza, (Flange Type), Pipe To Manifold	F7434	1
			Stanza, (Flange Type), Catalytic Converter To Exhaust Pipe <i>Metal</i>	F7480	2
	1984-1988		200SX, (Flange Type), Pipe To Manifold	F10047	1
	1984-1985		Stanza, (Flange Type), Pipe To Manifold	F10047	1
Oil Pump Inlet Tube	1984-1989			B45703	1
Oil Pump Mounting Gasket	1984-1989			H45691	1
Throttle Body Gasket	1985-1989		Stanza	GS30955	1
	1984-1988		200SX	GS30812	1
Water Outlet Gasket	1984-1989		(2 Holes) <i>Victopac</i>	C20115	1
Water Pump Mount Gasket	1984-1989			K27423	1

24 1974CC (2.0L) CA20S 4 Cyl, 3.327in./84.5mm (1982-1983)**24**

Part	Year	VIN	Model/Application	Part Number	Qty.
ENGINE GASKETS					
Head Set	1982-1983		Stanza, (Requires Carburetor Mounting Gasket)	HS3733	1
Lower Set	1982-1983		(Contains 1 Piece Oil Pan Gasket)	CS3784	1
Cylinder Head Gasket	1982-1983		Stanza, To Be Replaced By 3784	3733	1
			Stanza <i>Nitroseal</i>	3784	1
Cyl. Head Spacer Shim	1982-1983		Stanza, Requires Sealing Compound <i>Steel</i>	3733S	1
Sealing Compound	1982-1983		(4 Ounce Brush Top Can)	JV66B	1
			(12 Ounce Spray Can)	JV66S	1
Valve Cover Set	1982-1983		Stanza, (Contains Valve Cover Washers) <i>Victo-Tech</i>	VS38330	1
Valve Stem Seal, Exh.	1982-1983		Stanza	B45475	4
Valve Stem Seal, Int.	1982-1983		Stanza	B45475	4
Manifold Set, Exhaust	1982-1983		Stanza	MS10045	1
Manifold Set, Intake	1982-1983		Stanza	MS15338	1
Oil Pan Set	1982-1983		Stanza <i>Victo-Tech</i>	OS30584	1
Rear Main Seal Set	1982-1983		Stanza	JV521	1
Timing Cover Set	1982-1983		Stanza, (Requires Oil Pan Set)	JV976	1
Timing Cover Seal	1982-1983		Stanza	66881	1
MISCELLANEOUS GASKETS					
Camshaft Seal	1982-1983		Stanza	66864	1
Carb. Mount Gasket	1982-1983		Stanza, 2 Barrel Carburetor	GS33158	1
E.G.R. Gasket	1982-1983		Stanza	G26315	1
Fuel Pump Gasket	1982-1983		Stanza	D30815	1
Oil Pump Inlet Tube	1982-1983		Stanza	B45703	1
Oil Pump Mounting Gasket	1982-1983		Stanza	H45691	1
Water Outlet Gasket	1982-1983		Stanza, (2 Holes) <i>Victopac</i>	C20115	1
Water Pump Mount Gasket	1982-1983		Stanza	K27423	1

Nissan

25 1998CC (2.0L) SR20DE DOHC 4 Cyl, 3.386in./86mm (1991-1994)

25

Part	Year	VIN	Model/Application	Part Number	Qty.
ENGINE GASKETS					
Head Set	1991-1994		(Requires RTV)	HS4917	1
Full Set	1991-1994		(Requires RTV)	FS4917	1
Cylinder Head Gasket	1991-1994		<i>Nitroseal</i>	4917	1
Cyl. Head Spacer Shim	1991-1994		Requires Sealing Compound <i>Steel</i>	4917S	1
Sealing Compound	1991-1994		(4 Ounce Brush Top Can)	JV66B	1
			(12 Ounce Spray Can)	JV66S	1
Valve Cover Set	1991-1994		(Contains Valve Cover Washers, Contains Spark Plug Tube Seals) <i>Victo-Tech</i>	VS50140	1
Valve Stem Seal, Exh.	1991-1994			B45601	8
Valve Stem Seal, Int.	1991-1994			B45601	8
Manifold Set, Exhaust	1991-1994			MS15684	1
Manifold Set, Intake	1991-1994		(Contains Plenum Chamber Gasket)	MS15683	1
Plenum Chamber Gasket	1991-1992			MS13996	1
Oil Pan Set	1991-1993		Original Equipment Uses RTV <i>Silicone</i>	JV6	1
Rear Main Seal	1991-1994		<i>Rubber</i>	67119	1
Timing Cover Seal	1991-1994		(Requires RTV)	67122	1

MISCELLANEOUS GASKETS

Dist. Mounting Gasket	1991-1994			D27228	1
E.G.R. Gasket	1991-1994			G26315	1
Exhaust Pipe Gasket	1991-1994		(Ring Type 'A'), Pipe To Manifold	F7281	2
			(Flange Type), Catalytic Converter To Exhaust Pipe <i>Composition</i>	F7285	2
Oil Pump Inlet Tube	1991			B45693	1
Throttle Body Gasket	1991-1994			G31093	1
Water Outlet Gasket	1991-1994			C24093	1
Water Pump Mount Gasket	1991-1994		Original Equipment Uses RTV <i>Silicone</i>	JV6	1

26 2187CC (2.2L) Z22E SOHC 4 Cyl, 3.425in./87mm (1982-1983)

26

Part	Year	VIN	Model/Application	Part Number	Qty.
ENGINE GASKETS					
Head Set	1982-1983		(Requires Throttle Body Gasket)	HS3724	1
Full Set	1982-1983		(Requires Throttle Body Gasket)	FS3724	1
Engine Kit Gasket Set	1982-1983			95-3240VR	1
Cylinder Head Gasket	1982-1983		<i>VR2000</i>	3724	1
Valve Cover Set	1982-1983		(Contains Valve Cover End Plug) <i>Cork Rubber</i>	VS20344	1
Valve Stem Seal, Exh.	1982-1983			B20183	4
Valve Stem Seal, Int.	1982-1983			B20183	4
Manifold Set, Exhaust	1982-1983			MS12275	1
Manifold Set, Intake	1982-1983		(Contains Plenum Chamber Gasket)	MS15322	1
Plenum Chamber Gasket	1982-1983			MS12363	1
Oil Pan Set	1982-1983		<i>Cork Rubber</i>	OS30051	1
Rear Main Seal Set	1982-1983			JV637	1
Timing Cover Set	1982-1983			JV916	1
MISCELLANEOUS GASKETS					
E.G.R. Gasket	1982-1983			G26315	1
Exhaust Pipe Gasket	1982-1983		(Flange Type), Pipe To Manifold	F10047	1
Fuel Pump Gasket	1982-1983			D24076	2
Oil Pump Inlet Tube	1982-1983			B45711	1
Oil Pump Mounting Gasket	1982-1983			B45694	1
Throttle Body Gasket	1982-1983			GS33155	1
Valve Cover End Plug	1982-1983		(Half Round)	B45488	2
Water Outlet Gasket	1982-1983		(2 Holes) <i>Victopac</i>	C20115	1

26 (cont.)	2187CC (2.2L) Z22E SOHC 4 Cyl, 3.425in./87mm (1982-1983)				26 (cont.)
----------------------	---	--	--	--	----------------------

Part	Year	VIN	Model/Application	Part Number	Qty.
------	------	-----	-------------------	-------------	------

MISCELLANEOUS GASKETS (cont.)

Water Pump Mount Gasket	1982-1983			K26081	1
-------------------------	-----------	--	--	--------	---

27	2389CC (2.4L) KA24DE DOHC 4 Cyl, 3.504in./89mm (1991-1999)				27
-----------	---	--	--	--	-----------

Part	Year	VIN	Model/Application	Part Number	Qty.
------	------	-----	-------------------	-------------	------

ENGINE GASKETS

Head Set	1993-1999		Altima	HS54098	1
	1991-1994		240SX, (Requires RTV)	HS5742	1
Lower Set	1993-1999		Altima	CS54098	1
	1991-1998		240SX	CS5742	1
Engine Kit Gasket Set	1991-1999			95-3497VR	1
Cylinder Head Gasket	1993-1999		Altima Nitroseal	54098G	1
	1991-1994		240SX Nitroseal	5742	1
Valve Cover Set	1993-1999		Altima, (Valve Cover Grommets Not Included) Victo-Tech	VS50255	1
	1991-1994		240SX, (Contains Camshaft Semi Circular Plug) Victo-Tech	VS50150	1
Valve Stem Seal, Exh.	1993-1999		Altima	B45475	8
	1991-1998		240SX	B45475	8
Valve Stem Seal, Int.	1993-1999		Altima	B45475	8
	1991-1998		240SX	B45475	8
Manifold Set, Exhaust	1993-1999		Altima	MS7488	1
	1991-1998		240SX	MS7488	1
Manifold Set, Intake	1993-1999		Altima	MS16251	1
	1991-1998		240SX, (Contains Plenum Chamber Gasket)	MS16058	1
Plenum Chamber Gasket	1991-1998		240SX	MS12393	1
Oil Pan Set	1993-1999		Altima, Lower Pan To Upper Pan Cork Rubber	OS32157	1
			Altima, Upper Pan To Block	OS32184	1
	1991-1998		240SX Cork Rubber	OS32110	1
Rear Main Seal	1993-1999		Altima Rubber	67123	1
	1991-1998		240SX Rubber	67123	1
Timing Cover Set	1993-1999		Altima, (Requires RTV)	JV1147	1
	1991-1998		240SX, (Requires RTV)	JV1147	1
Timing Cover Seal	1991-1999			67122	1

MISCELLANEOUS GASKETS

Cam. Semi-Circular Plug	1991-1994		240SX	B45849	2
E.G.R. Gasket	1995-1998		240SX	G26315	1
	1993-1994		Altima, Valve	G26315	1
E.G.R. Gasket Set	1993-1998		Altima	GS31232	1
	1991-1998		240SX	GS31232	1
Exhaust Pipe Gasket	1995-1999		Altima, (Flange Type), Catalytic Converter To Exhaust Pipe Composition	F7285	2
	1993-1999		Altima, (Flange Type), Pipe To Manifold	F7281	2
	1995-1998		240SX, (Ring Type 'A'), Pipe To Manifold	F10091	2
	1991-1997		240SX, (Flange Type), Catalytic Converter To Exhaust Pipe Composition	F7285	2
	1994		Altima, Automatic Transmission, California Emission, (Flange Type), Catalytic Converter To Exhaust Pipe Composition	F7285	2
			Altima, Manual Transmission, (Flange Type), Catalytic Converter To Exhaust Pipe Composition	F7285	2
			Altima, Automatic Transmission, Federal Emission, (Flange Type), Catalytic Converter To Exhaust Pipe Metal	F7480	2
	1991-1994		240SX, (Ring Type 'A'), Pipe To Manifold	F7281	2
1993		Altima, (Flange Type), Catalytic Converter To Exhaust Pipe Metal	F7480	2	
Therm. Housing Gasket	1991-1998		240SX	C31234	1

Nissan

27 (cont.)	2389CC (2.4L) KA24DE DOHC 4 Cyl, 3.504in./89mm (1991-1999)	27 (cont.)
----------------------	---	----------------------

Part	Year	VIN	Model/Application	Part Number	Qty.
MISCELLANEOUS GASKETS (cont.)					
Throttle Body Gasket	1993-1999		Altima	G31093	1
	1991-1998		240SX	G31093	1
Valve Cover Grommet	1998-1999		Altima	B45878	1
	1993-1997		Altima	B45877	1
Water Outlet Gasket	1991-1995		240SX	C31233	1
Water Pump Gasket	1998		240SX	K31231	1
Water Pump Mount Gasket	1991-1997		240SX	K31231	1

28	2389CC (2.4L) KA24E SOHC 4 Cyl, 3.504in./89mm (1989-1992)	28
-----------	--	-----------

Part	Year	VIN	Model/Application	Part Number	Qty.
ENGINE GASKETS					
Head Set	1990-1992		Stanza, (Requires RTV)	HS5863	1
	1989-1990		240SX, (Requires RTV)	HS5863W	1
Full Set	1990-1992		Stanza, (Requires RTV)	FS5863	1
	1989-1990		240SX, (Requires RTV)	FS5863W	1
Engine Kit Gasket Set	1989-1990		240SX	95-3241VR	1
Cylinder Head Gasket	1989-1992		<i>Nitroseal</i>	5863	1
Cyl. Head Spacer Shim	1989-1992		Requires Sealing Compound <i>Steel</i>	5863S	1
Sealing Compound	1989-1992		(4 Ounce Brush Top Can)	JV66B	1
			(12 Ounce Spray Can)	JV66S	1
Valve Cover Set	1990-1992		Stanza, (Contains Camshaft Semi Circular Plug) <i>Victo-Tech</i>	VS50100	1
	1989-1990		240SX, (Contains Camshaft Semi Circular Plug) <i>Victo-Tech</i>	VS50101	1
Valve Stem Seal, Exh.	1989-1992			B45683	4
Valve Stem Seal, Int.	1989-1992			B45475	8
Manifold Set, Exhaust	1989-1992			MS15661	1
Manifold Set, Intake	1990-1992		Stanza	MS15653	1
	1989-1990		240SX	MS15658	1
Oil Pan Set	1990-1992		Stanza	OS32152	1
	1989-1990		240SX	OS32151	1
Rear Main Seal	1989-1992		<i>Rubber</i>	67123	1
Timing Cover Set	1989-1992			JV5004	1
Timing Cover Seal	1989-1992		(Requires RTV)	67122	1

MISCELLANEOUS GASKETS					
Cam. Semi-Circular Plug	1989-1992			B45849	2
Dist. Mounting Gasket	1989-1992			D27228	1
E.G.R. Gasket	1989-1992			G26315	1
Exhaust Pipe Gasket	1989-1992		(Ring Type 'A'), Pipe To Manifold	F7281	2
			(Flange Type), Catalytic Converter To Exhaust Pipe <i>Composition</i>	F7285	2
Throttle Body Gasket	1989-1992			G31093	1
Water Outlet Gasket	1990-1992		Stanza	C31295	1
	1989-1990		240SX, Original Equipment Uses RTV <i>Silicone</i>	JV6	1
Water Pump Mount Gasket	1990-1992		Stanza	K31296	1
	1989-1990		240SX	K31231	1

29	2393CC (2.4L) L24 SOHC 6 Cyl, 3.268in./83mm (1970-1973)	29
-----------	--	-----------

Part	Year	VIN	Model/Application	Part Number	Qty.
ENGINE GASKETS					
Head Set	1970-1973			HS3947	1
Lower Set	1970-1973			CS3947	1

29 2393CC (2.4L) L24 SOHC 6 Cyl, 3.268in./83mm (1970-1973)

(cont.)

29

(cont.)

Part	Year	VIN	Model/Application	Part Number	Qty.	
ENGINE GASKETS (cont.)						
Cylinder Head Gasket	1970-1973			3947	1	
Valve Cover Set	1970-1973			Cork Rubber	VS30020	1
				Tuff-Cork	VS30020TC	1
Valve Stem Seal, Exh.	1970-1973			B20183	6	
Valve Stem Seal, Int.	1970-1973			B20183	6	
Manifold Set, Int. & Exh.	1970-1973			MS16707	1	
Oil Pan Set	1970-1973		Cork Rubber	OS30050	1	
Rear Main Seal Set	1970-1973			JV637	1	
Timing Cover Set	1970-1973			JV916	1	

MISCELLANEOUS GASKETS

Carb. Mount Gasket	1973		2 Side Draft Carburetors	G30706	1	
	1971-1972		2 Side Draft Carburetors	G30694	1	
E.G.R. Gasket	1970-1973			G26315	1	
Exhaust Pipe Gasket	1970-1973		(Flange Type), Pipe To Manifold	F14600	1	
Fuel Pump Gasket	1970-1973			D27325	2	
Therm. Housing Gasket	1970-1973		(3 Holes)	C26084	1	
Water Outlet Gasket	1970-1973		(2 Holes)	Victopac	C20115	1
				(3 Holes)	C24179	1
Water Pump Mount Gasket	1970-1973			K26081	1	

30 2393CC (2.4L) L24E SOHC 6 Cyl, 3.268in./83mm (1977-1984)**30**

Part	Year	VIN	Model/Application	Part Number	Qty.	
ENGINE GASKETS						
Head Set	1981-1984			HS4824	1	
	1980		To Be Replaced By HS4824	HS3947X	1	
	1977-1979		To Be Replaced By HS4824	HS3947W	1	
Lower Set	1977-1984			CS3947	1	
Engine Kit Gasket Set	1977-1984			95-3053VR	1	
Cylinder Head Gasket	1977-1984			3947	1	
Valve Cover Set	1977-1984			Cork Rubber	VS30020	1
				Tuff-Cork	VS30020TC	1
Valve Stem Seal, Exh.	1977-1984			B20183	6	
Valve Stem Seal, Int.	1977-1984			B20183	6	
Manifold Set, Int. & Exh.	1977-1984			MS16717	1	
Oil Pan Set	1977-1984		Cork Rubber	OS30050	1	
Rear Main Seal Set	1977-1984			JV637	1	
Timing Cover Set	1977-1984			JV916	1	

MISCELLANEOUS GASKETS

E.G.R. Gasket	1977-1984			G26315	1	
Exhaust Pipe Gasket	1980-1984		(Flange Type), Pipe To Manifold	F14602	1	
Fuel Pump Gasket	1977-1980			D27325	2	
Therm. Housing Gasket	1977-1979		(3 Holes)	C26084	1	
Throttle Body Gasket	1981-1984			G30696	1	
Water Outlet Gasket	1981-1984		(2 Holes)	Victopac	C20115	1
	1977-1980		(3 Holes)	Victopac	C24179	1
	1977-1979		(2 Holes)	Victopac	C20115	1
Water Pump Mount Gasket	1977-1984			K26081	1	

Nissan

31 2565CC (2.6L) L26 6 Cyl, 3.268in./83mm (1974)
31

Part	Year	VIN	Model/Application	Part Number	Qty.
ENGINE GASKETS					
Head Set	1974			HS3947	1
Lower Set	1974			CS3947	1
Cylinder Head Gasket	1974			3947	1
Valve Cover Set	1974			<i>Cork Rubber</i> VS30020	1
				<i>Tuff-Cork</i> VS30020TC	1
Valve Stem Seal, Exh.	1974			B20183	6
Valve Stem Seal, Int.	1974			B20183	6
Manifold Set, Int. & Exh.	1974			MS16707	1
Oil Pan Set	1974		<i>Cork Rubber</i>	OS30050	1
Rear Main Seal Set	1974			JV637	1
Timing Cover Set	1974			JV916	1

MISCELLANEOUS GASKETS

Carb. Mount Gasket	1974		2 Side Draft Carburetors	G30706	1
E.G.R. Gasket	1974			G26315	1
Exhaust Pipe Gasket	1974		(Flange Type), Pipe To Manifold	F14600	1
Fuel Pump Gasket	1974			D27325	2
Therm. Housing Gasket	1974			C26084	1
Water Outlet Gasket	1974		(2 Holes) <i>Victopac</i>	C20115	1
Water Pump Mount Gasket	1974			K26081	1

32 2753CC (2.8L) L28E SOHC 6 Cyl, 3.386in./86mm (1975-1983)
32

Part	Year	VIN	Model/Application	Part Number	Qty.
ENGINE GASKETS					
Head Set	1982-1983			HS3987	1
	1981		280ZX, Thru 2/81	HS3949X	1
			From 3/81	HS3987	1
	1979-1980		280ZX	HS3949X	1
	1977-1978		280Z	HS3949W	1
	1975-1976			HS3949	1
Lower Set	1975-1983			CS3947	1
Full Set	1977-1978		280Z	FS3949W	1
Engine Kit Gasket Set	1975-1980			95-3053VR	1
Cylinder Head Gasket	1982-1983			3987	1
	1981		Thru 2/81	3949	1
			From 3/81	3987	1
	1975-1980			3949	1
Valve Cover Set	1975-1983			<i>Cork Rubber</i> VS30020	1
				<i>Tuff-Cork</i> VS30020TC	1
Valve Stem Seal, Exh.	1975-1983			B20183	6
Valve Stem Seal, Int.	1975-1983			B20183	6
Manifold Set, Int. & Exh.	1979-1983		280ZX	MS16717	1
	1977-1978		280Z	MS16717	1
	1975-1976		280Z	MS16708	1
Oil Pan Set	1975-1983		<i>Cork Rubber</i>	OS30050	1
Rear Main Seal Set	1975-1983			JV637	1
Timing Cover Set	1975-1983			JV916	1

MISCELLANEOUS GASKETS

E.G.R. Gasket	1975-1983			G26315	1
Exhaust Pipe Gasket	1975-1983		(Flange Type), Pipe To Manifold	F14602	1
			(Flange Type), Catalytic Converter To Exhaust Pipe	F20188	2
Fuel Pump Gasket	1975-1983			D27325	2
Oil Pump Inlet Tube	1975-1983			B45710	1

32 (cont.)	2753CC (2.8L) L28E SOHC 6 Cyl, 3.386in./86mm (1975-1983)	32 (cont.)
----------------------	---	----------------------

Part	Year	VIN	Model/Application	Part Number	Qty.
MISCELLANEOUS GASKETS (cont.)					
Oil Pump Mounting Gasket	1975-1983			B45694	1
Therm. Housing Gasket	1982-1983			C30726	1
	1975-1981			C26084	1
Throttle Body Gasket	1981-1983		280ZX	G30696	1
	1979-1980		280ZX	G30695	1
	1978		280Z	G30695	1
Water Outlet Gasket	1975-1983		(3 Holes)	C24179	1
	1981		Thru 2/81, (2 Holes)	Victopac C20115	1
	1975-1980		(2 Holes)	Victopac C20115	1
Water Pump Mount Gasket	1975-1983			K26081	1

33	2753CC (2.8L) L28ET SOHC Turbo 6 Cyl, 3.386in./86mm (1981-1983)	33
-----------	--	-----------

Part	Year	VIN	Model/Application	Part Number	Qty.
ENGINE GASKETS					
Head Set	1982-1983			HS3987	1
	1981		From 3/81	HS3987	1
Lower Set	1981-1983			CS3947	1
Cylinder Head Gasket	1982-1983			3987	1
	1981		From 3/81	3987	1
Valve Cover Set	1981-1983			Cork Rubber VS30020	1
				Tuff-Cork VS30020TC	1
Valve Stem Seal, Exh.	1981-1983			B20183	6
Valve Stem Seal, Int.	1981-1983			B20183	6
Manifold Set, Int. & Exh.	1981-1983			MS16717	1
Oil Pan Set	1981-1983			Cork Rubber OS30050	1
Rear Main Seal Set	1981-1983			JV637	1
Timing Cover Set	1981-1983			JV916	1

MISCELLANEOUS GASKETS

E.G.R. Gasket	1981-1983			G26315	1
Exhaust Pipe Gasket	1981-1983		(Flange Type), Pipe To Manifold	F14602	1
			(Flange Type), Catalytic Converter To Exhaust Pipe	F20188	2
Fuel Pump Gasket	1981-1983			D27325	2
Oil Pump Inlet Tube	1981-1983			B45710	1
Oil Pump Mounting Gasket	1981-1983			B45694	1
Therm. Housing Gasket	1982-1983			C30726	1
	1981			C26084	1
Throttle Body Gasket	1981-1983			G30696	1
Turbo Gasket Set	1981-1983			GS33262	1
Water Outlet Gasket	1981-1983		(3 Holes)	C24179	1
Water Pump Mount Gasket	1981-1983			K26081	1

34	2793CC (2.8L) LD28 SOHC Diesel 6 Cyl, 3.327in./84.5mm (1981-1983)	34
-----------	--	-----------

Part	Year	VIN	Model/Application	Part Number	Qty.
ENGINE GASKETS					
Head Set	1981-1983		(Head Gasket Not Included, Thickness Is Identified By Groove In Edge Of Gasket, Replacement Gasket Must Be Of Same Thickness As One Removed)	HS3999	1
Full Set	1981-1983		(Head Gasket Not Included, Thickness Is Identified By Groove In Edge Of Gasket, Replacement Gasket Must Be Of Same Thickness As One Removed)	FS3999	1

Nissan

34 (cont.)	2793CC (2.8L) LD28 SOHC Diesel 6 Cyl, 3.327in./84.5mm (1981-1983)				34 (cont.)
----------------------	--	--	--	--	----------------------

Part	Year	VIN	Model/Application	Part Number	Qty.
------	------	-----	-------------------	-------------	------

ENGINE GASKETS (cont.)

Cylinder Head Gasket	1981-1983		(1 Groove)	VR2000, 1.12mm Thickness	3996	1
			(2 Grooves)	VR2000, 1.2mm Thickness	3997	1
			(3 Grooves)	VR2000, 1.28mm Thickness	3998	1
			(No Groove)	Nitroseal, 1.3mm Thickness	3999	1
Valve Cover Set	1981-1983			Victo-Tech	VS38333	1
Valve Stem Seal, Exh.	1981-1983				B20183	6
Valve Stem Seal, Int.	1981-1983				B20183	6
Plenum Chamber Gasket	1981-1983				MS12353	1
Manifold Set, Int. & Exh.	1981-1983		(Contains Plenum Chamber Gasket)		MS16052	1
Oil Pan Set	1981-1983			Cork Rubber	OS30050	1
Rear Main Seal Set	1981-1983				JV637	1
Timing Cover Set	1981-1983				JV977	1

MISCELLANEOUS GASKETS

E.G.R. Gasket	1981-1983				G26315	1
Exhaust Pipe Gasket	1981-1983		(Flange Type), Pipe To Manifold		F14602	1
Water Outlet Gasket	1981-1983				C24093	1
Water Pump Mount Gasket	1981-1983				K26081	1

35	2960CC (3.0L) VE30DE DOHC V6 Cyl, 3.425in./87mm (1992-1994)				35
-----------	--	--	--	--	-----------

Part	Year	VIN	Model/Application	Part Number	Qty.
------	------	-----	-------------------	-------------	------

ENGINE GASKETS

Valve Cover Set	1992-1994		(Contains Valve Cover Gasket Only)		VS50287	1
-----------------	-----------	--	------------------------------------	--	---------	---

36	2960CC (3.0L) VG30 SOHC V6 Cyl, 3.425in./87mm (1984-1989)				36
-----------	--	--	--	--	-----------

Part	Year	VIN	Model/Application	Part Number	Qty.
------	------	-----	-------------------	-------------	------

ENGINE GASKETS

Head Set	1988-1989		300ZX		HS5826	1
	1987		300ZX, Thru 3/87		HS3774	1
			300ZX, From 4/87		HS5826	1
	1984-1986		300ZX		HS3774	1
Full Set	1988-1989		300ZX, (Requires RTV)		FS5826	1
	1987		300ZX, Thru 3/87, (Requires RTV)		FS3774	1
			300ZX, From 4/87, (Requires RTV)		FS5826	1
1984-1986		300ZX, (Requires RTV)		FS3774	1	
Engine Kit Gasket Set	1984-1987				95-3358VR	1
Cylinder Head Gasket	1988-1989		300ZX	Nitroseal	5826	2
	1987		300ZX, Thru 3/87	Nitroseal	5758	2
			300ZX, From 4/87		Nitroseal	5826
	1984-1986		300ZX	Nitroseal	5758	2
Cyl. Head Spacer Shim	1988-1989		300ZX, Requires Sealing Compound	Steel	5826S	1
			300ZX, Requires Sealing Compound, Thru 3/87	Steel	5758S	1
	1987		300ZX, From 4/87, Requires Sealing Compound	Steel	5826S	1
			300ZX, Requires Sealing Compound	Steel	5758S	1
Sealing Compound	1984-1989		(4 Ounce Brush Top Can)		JV66B	1
			(12 Ounce Spray Can)		JV66S	1
Valve Cover Set	1984-1989		300ZX	Victo-Tech	VS38376	1
Valve Stem Seal, Exh.	1984-1989		300ZX		B20183	6
Valve Stem Seal, Int.	1984-1989		300ZX		B45475	6
Manifold Set, Exhaust	1984-1989		300ZX		MS15364	1
Manifold Set, Intake	1984-1989		300ZX, (Contains Plenum Chamber Gasket)		MS15362W	1
Plenum Chamber Gasket	1984-1989		300ZX		MS15494	1

36 2960CC (3.0L) VG30 SOHC V6 Cyl, 3.425in./87mm (1984-1989)**36
(cont.)**

<i>Part</i>	<i>Year</i>	<i>VIN</i>	<i>Model/Application</i>	<i>Part Number</i>	<i>Qty.</i>
ENGINE GASKETS (cont.)					
Oil Pan Set	1988-1989		300ZX, (Requires Timing Cover Set) <i>Victo-Tech</i>	OS32080	1
	1987		300ZX, Thru 3/87, (Requires Timing Cover Set) <i>Victo-Tech</i>	OS30606	1
			300ZX, From 4/87, (Requires Timing Cover Set) <i>Victo-Tech</i>	OS32080	1
	1984-1986		300ZX, (Requires Timing Cover Set) <i>Victo-Tech</i>	OS30606	1
Rear Main Seal Set	1984-1989		300ZX	JV538	1
Timing Cover Set	1984-1989		300ZX, (Requires RTV, Contains Camshaft Seal)	JV1004	1
Timing Cover Seal	1984-1989		300ZX	66881	1

MISCELLANEOUS GASKETS

Dist. Mounting Gasket	1984-1989		300ZX	72212	1
E.G.R. Gasket	1984-1989		300ZX	G20610	2
Exhaust Pipe Gasket	1988-1989		300ZX, (Flange Type), Pipe To Manifold	F7284	1
	1984-1989		300ZX, (Flange Type), Catalytic Converter To Exhaust Pipe <i>Composition</i>	F7285	2
		1987		300ZX, From 4/87, (Flange Type), Pipe To Manifold	F7284
			300ZX, Thru 3/87, (Flange Type), Pipe To Manifold	F12301	1
	1984-1986		300ZX, (Flange Type), Pipe To Manifold	F12301	1
Oil Pump Inlet Tube	1984-1989		300ZX	B45693	1
Oil Pump Mounting Gasket	1984-1989			H45692	1
Therm. Housing Gasket	1988-1989		300ZX, Original Equipment Uses RTV <i>Silicone</i>	JV6	1
			300ZX, Thru 2/87	C24212	1
	1987		300ZX, From 3/87, Original Equipment Uses RTV <i>Silicone</i>	JV6	1
			300ZX	C24212	1
Throttle Body Gasket	1984-1989		300ZX	G30801	1
Water Outlet Gasket	1987		300ZX, Thru 4/87	C24211	1
	1984-1986		300ZX	C24211	1
Water Pump Mount Gasket	1984-1987		300ZX	K27661	1

37 2960CC (3.0L) VG30DE DOHC V6 Cyl, 3.425in./87mm (1989-1996)**37**

<i>Part</i>	<i>Year</i>	<i>VIN</i>	<i>Model/Application</i>	<i>Part Number</i>	<i>Qty.</i>
ENGINE GASKETS					
Head Set	1989-1993		300ZX, (Requires RTV)	HS5865	1
Full Set	1989-1993		300ZX, (Requires RTV)	FS5865	1
Cylinder Head Gasket	1989-1996		300ZX <i>Nitroseal</i>	5865	2
Valve Cover Set	1989-1996		300ZX, (Contains RTV) <i>Victo-Tech</i>	VS50268	1
Valve Stem Seal, Exh.	1989-1996		300ZX	B45601	12
Valve Stem Seal, Int.	1989-1996		300ZX	B45601	12
Manifold Set, Exhaust	1989-1996		300ZX	MS15660	1
Manifold Set, Intake	1989-1996		300ZX, (Contains Plenum Chamber Gasket)	MS15656	1
Plenum Chamber Gasket	1989-1996		300ZX	MS15655	1
Oil Pan Set	1989-1996		300ZX, (Requires RTV) <i>Victo-Tech</i>	OS32080	1
Rear Main Seal Set	1989-1996		300ZX	JV538	1
Timing Cover Set	1989-1996		300ZX	JV1113	1

MISCELLANEOUS GASKETS

Camshaft Seal	1989-1992		300ZX	66991	4
E.G.R. Gasket	1989-1993		300ZX, Valve	G31106	2
	1989-1992		300ZX, Passage	G31107	2
Exhaust Pipe Gasket	1989-1996		300ZX, (Ring Type 'A'), Pipe To Manifold	F7282	2
	1989-1992		300ZX, (Flange Type), Catalytic Converter To Exhaust Pipe <i>Metal</i>	F7480	4
Oil Pump Inlet Tube	1990-1995		300ZX	B45709	1
Oil Pump Mounting Gasket	1989-1996		300ZX	L45708	1

Nissan

37 (cont.)	2960CC (3.0L) VG30DE DOHC V6 Cyl, 3.425in./87mm (1989-1996)				37 (cont.)
----------------------	--	--	--	--	----------------------

Part	Year	VIN	Model/Application	Part Number	Qty.
------	------	-----	-------------------	-------------	------

MISCELLANEOUS GASKETS (cont.)

Throttle Body Gasket	1989-1996		300ZX	G31105	2
Water Outlet Gasket	1989-1996		300ZX, Original Equipment Uses RTV	<i>Silicone</i> JV6	1
Water Pump Mount Gasket	1994-1996		300ZX	K27661	1
	1989-1993		300ZX, Original Equipment Uses RTV	<i>Silicone</i> JV6	1

38	2960CC (3.0L) VG30DETT DOHC Twin Turbo V6 Cyl, 3.425in./87mm (1990-1996)				38
-----------	---	--	--	--	-----------

Part	Year	VIN	Model/Application	Part Number	Qty.
------	------	-----	-------------------	-------------	------

ENGINE GASKETS

Head Set	1990-1996			<i>Nitroseal</i> HS54158	1
Full Set	1990-1996			<i>Nitroseal</i> FS54158	1
Cylinder Head Gasket	1990-1996			<i>Nitroseal</i> 54158	2
Valve Cover Set	1990-1996			<i>Victo-Tech</i> VS50268	1
Valve Stem Seal, Exh.	1990-1996			B45601	12
Valve Stem Seal, Int.	1990-1996			B45601	12
Manifold Set, Exhaust	1990-1996			MS15660	1
Manifold Set, Intake	1990-1996			MS15656	1
Plenum Chamber Gasket	1990-1996			MS15655	1
Oil Pan Set	1990-1996			<i>Victo-Tech</i> OS32080	1
Timing Cover Set	1990-1996			JV1113	1

MISCELLANEOUS GASKETS

Camshaft Seal	1990-1996			66991	4
Oil Pump Inlet Tube	1990-1996			B45709	1
Oil Pump Mounting Gasket	1990-1996			L45708	1
Throttle Body Gasket	1990-1996			G31105	2

39	2960CC (3.0L) VG30E SOHC V6 Cyl, 3.425in./87mm (1984-1994)				39
-----------	---	--	--	--	-----------

Part	Year	VIN	Model/Application	Part Number	Qty.
------	------	-----	-------------------	-------------	------

ENGINE GASKETS

Head Set	1989-1994		Maxima	HS5826X	1
	1988		200SX, Maxima	HS5826	1
	1987		Thru 3/87	HS3774	1
			From 4/87	HS5826	1
	1984-1986			HS3774	1
Full Set	1989-1994		Maxima, (Requires RTV)	FS5826X	1
	1988		200SX, Maxima, (Requires RTV)	FS5826	1
	1987		Thru 3/87, (Requires RTV)	FS3774	1
			From 4/87, (Requires RTV)	FS5826	1
	1984-1986		(Requires RTV)	FS3774	1
Engine Kit Gasket Set	1984-1987			95-3358VR	1
Cylinder Head Gasket	1988-1994			<i>Nitroseal</i> 5826	2
	1987		Thru 3/87	<i>Nitroseal</i> 5758	2
			From 4/87	<i>Nitroseal</i> 5826	2
	1984-1986			<i>Nitroseal</i> 5758	2
Cyl. Head Spacer Shim	1988-1994		Requires Sealing Compound	<i>Steel</i> 5826S	1
			Requires Sealing Compound, Thru 3/87	<i>Steel</i> 5758S	1
	1987		From 4/87, Requires Sealing Compound	<i>Steel</i> 5826S	1
			Requires Sealing Compound	<i>Steel</i> 5758S	1
Sealing Compound	1984-1994		(4 Ounce Brush Top Can)	JV66B	1
			(12 Ounce Spray Can)	JV66S	1
Valve Cover Set	1984-1994			<i>Victo-Tech</i> VS38376	1
Valve Stem Seal, Exh.	1984-1994			B20183	6

39 2960CC (3.0L) VG30E SOHC V6 Cyl, 3.425in./87mm (1984-1994)

(cont.)

39

(cont.)

Part	Year	VIN	Model/Application	Part Number	Qty.
ENGINE GASKETS (cont.)					
Valve Stem Seal, Int.	1984-1994			B45475	6
Manifold Set, Exhaust	1984-1994			MS15364	1
Manifold Set, Intake	1989-1994		(Contains Plenum Chamber Gasket)	MS15362X	1
	1984-1988		(Contains Plenum Chamber Gasket)	MS15362W	1
Plenum Chamber Gasket	1989-1994			MS15494X	1
	1984-1988			MS15494	1
Oil Pan Set	1988-1994		(Requires Timing Cover Set) <i>Victo-Tech</i>	OS32080	1
	1987		Thru 3/87, (Requires Timing Cover Set) <i>Victo-Tech</i>	OS30606	1
			From 4/87, (Requires Timing Cover Set) <i>Victo-Tech</i>	OS32080	1
	1984-1986		(Requires Timing Cover Set) <i>Victo-Tech</i>	OS30606	1
Rear Main Seal Set	1984-1994			JV538	1
Timing Cover Set	1989-1994		(Requires RTV, Contains Camshaft Seal)	JV1107	1
	1984-1988		(Requires RTV, Contains Camshaft Seal)	JV1004	1
Timing Cover Seal	1984-1992			66881	1

MISCELLANEOUS GASKETS

Camshaft Seal	1989-1992			66864	2
Dist. Mounting Gasket	1984-1994			72212	1
E.G.R. Gasket	1993-1994			G26315	1
	1984-1992			G20610	2
Exhaust Pipe Gasket	1989-1994		(Ring Type 'A'), Pipe To Manifold	F7479	2
	1985-1994		(Flange Type), Catalytic Converter To Exhaust Pipe <i>Composition</i>	F7285	2
			(Flange Type), Catalytic Converter To Exhaust Pipe <i>Metal</i>	F7480	2
	1988		(Flange Type), Pipe To Manifold	F7284	1
	1987		From 4/87, (Flange Type), Pipe To Manifold	F7284	1
			Thru 3/87, (Flange Type), Pipe To Manifold	F12301	1
	1986		From 2/86, (Flange Type), Catalytic Converter To Exhaust Pipe <i>Metal</i>	F7480	2
			(Flange Type), Pipe To Manifold	F12301	1
Oil Pump Inlet Tube	1987-1988			B45693	1
Oil Pump Mounting Gasket	1987-1988			H45692	1
Therm. Housing Gasket	1988-1992		Original Equipment Uses RTV <i>Silicone</i>	JV6	1
			Thru 2/87	C24212	1
	1987		From 3/87, Original Equipment Uses RTV <i>Silicone</i>	JV6	1
				C24212	1
Throttle Body Gasket	1989-1992			G31079	1
	1984-1988			G30801	1
Water Outlet Gasket	1987		Thru 4/87	C24211	1
	1984-1986			C24211	1
Water Pump Mount Gasket	1984-1994			K27661	1

40 2960CC (3.0L) VG30T SOHC Turbo V6 Cyl, 3.425in./87mm (1984-1989)**40**

Part	Year	VIN	Model/Application	Part Number	Qty.
ENGINE GASKETS					
Head Set	1987-1989			<i>Nitroseal</i> HS5826T	1
	1986		300ZX, Thru 9/86	HS3774W	1
	1984-1985		300ZX	HS3774W	1
Full Set	1987-1989		300ZX	FS5826T	1
	1986		300ZX, Thru 9/86, (Requires RTV)	FS3774W	1
	1984-1985		300ZX, (Requires RTV)	FS3774W	1
Engine Kit Gasket Set	1984-1987		(Exhaust Manifold Gasket Not Included), Use With Part Number MS15363	95-3358VR	1
Cylinder Head Gasket	1988-1989		300ZX <i>Nitroseal</i>	5826	2

Nissan

40 (cont.)	2960CC (3.0L) VG30T SOHC Turbo V6 Cyl, 3.425in./87mm (1984-1989)				40 (cont.)
----------------------	---	--	--	--	----------------------

Part	Year	VIN	Model/Application	Part Number	Qty.
------	------	-----	-------------------	-------------	------

ENGINE GASKETS (cont.)

Cylinder Head Gasket (cont.)	1987		300ZX, Thru 3/87	<i>Nitroseal</i> 5758	2
			300ZX, From 4/87	<i>Nitroseal</i> 5826	2
	1984-1986		300ZX	<i>Nitroseal</i> 5758	2
Cyl. Head Spacer Shim	1988-1989		300ZX, Requires Sealing Compound	<i>Steel</i> 5826S	1
	1987		300ZX, Requires Sealing Compound, Thru 3/87	<i>Steel</i> 5758S	1
			300ZX, From 4/87, Requires Sealing Compound	<i>Steel</i> 5826S	1
1984-1986		300ZX, Requires Sealing Compound	<i>Steel</i> 5758S	1	
Sealing Compound	1984-1989		(4 Ounce Brush Top Can)	JV66B	1
			(12 Ounce Spray Can)	JV66S	1
Valve Cover Set	1984-1989		300ZX	<i>Victo-Tech</i> VS38376	1
Manifold Set, Exhaust	1984-1989		300ZX	MS15363	1
Manifold Set, Intake	1984-1989		300ZX, (Contains Plenum Chamber Gasket)	MS15362W	1
Plenum Chamber Gasket	1984-1989		300ZX	MS15494	1
Oil Pan Set	1987		300ZX, Thru 4/87, (Requires Timing Cover Set)	<i>Victo-Tech</i> OS30606	1
	1984-1986		300ZX, (Requires Timing Cover Set)	<i>Victo-Tech</i> OS30606	1
Rear Main Seal Set	1984-1989		300ZX	JV538	1
Timing Cover Set	1987		300ZX, Thru 4/87, (Requires RTV, Contains Camshaft Seal)	JV1004	1
	1984-1986		300ZX, (Requires RTV, Contains Camshaft Seal)	JV1004	1
Timing Cover Seal	1984-1989		300ZX	66881	1

MISCELLANEOUS GASKETS

Camshaft Seal	1984-1989		300ZX	66864	2
Dist. Mounting Gasket	1984-1989		300ZX	72212	1
Exhaust Pipe Gasket	1984-1989		300ZX, (Flange Type), Pipe To Manifold	F12301	1
Oil Pump Inlet Tube	1984-1989		300ZX	B45693	1
Oil Pump Mounting Gasket	1984-1989			H45692	1
Therm. Housing Gasket	1988-1989		300ZX, Original Equipment Uses RTV	<i>Silicone</i> JV6	1
	1987		300ZX, Thru 2/87	C24212	1
			300ZX, From 3/87, Original Equipment Uses RTV	<i>Silicone</i> JV6	1
1984-1986		300ZX	C24212	1	
Throttle Body Gasket	1984-1989		300ZX	G30801	1
Turbo Gasket Set	1984-1985		300ZX	GS27691	1
Water Outlet Gasket	1987		300ZX, Thru 4/87	C24211	1
	1984-1986		300ZX	C24211	1
Water Pump Mount Gasket	1984-1989		300ZX	K27661	1

41	2987CC (3.0L) VQ30DE DOHC V6 Cyl, 3.661in./93mm (1995-2001)				41
-----------	--	--	--	--	-----------

Part	Year	VIN	Model/Application	Part Number	Qty.
------	------	-----	-------------------	-------------	------

ENGINE GASKETS

Valve Cover Set	1995-2001		(Contains Valve Cover Grommets, Contains Spark Plug Tube Seals)	VS50290	1
-----------------	-----------	--	---	----------------	---

MISCELLANEOUS GASKETS

Exhaust Pipe Gasket	2000-2001		From 6/00, (Flange Type), Catalytic Converter To Exhaust Pipe	<i>Composition</i> F7285	2
	1995-2001		(Ring Type 'A'), Exhaust Pipe To Muffler	F7282	1
	1997-2000		Thru 6/00, (Flange Type), Resonator	<i>Metal</i> F7480	1
	1995-1997		Thru 6/97, (Flange Type), Catalytic Converter To Exhaust Pipe	<i>Composition</i> F7285	2

Engine Index

Engine	Year	Block
1491CC (1.5L)	1968	1
1817CC (1.8L) SOHC Isuzu	1976-1979	2

Engine	Year	Block
1897CC (1.9L)	1968-1975	3

Model Index

Model	Engine	Year	Block
1900	1897CC (1.9L)	1971-1974	3
Coupe	1491CC (1.5L)	1968	1
GT	1897CC (1.9L)	1969-1973	3
Isuzu	1817CC (1.8L) SOHC Isuzu	1976-1979	2
Kadett	1491CC (1.5L)	1968	1

Model	Engine	Year	Block
Kadett	1897CC (1.9L)	1965-1974	3
Manta	1897CC (1.9L)	1973-1974	3
Olympia	1897CC (1.9L)	1965-1974	3
Rekord	1897CC (1.9L)	1965-1974	3

1 1491CC (1.5L) 4 Cyl, 3.248in./82.5mm (1968) 1

Part	Year	VIN	Model/Application	Part Number	Qty.
------	------	-----	-------------------	-------------	------

ENGINE GASKETS

Valve Cover Set	1968			Cork Rubber	VS30013	1
Oil Pan Set	1968				OS30049	1

2 1817CC (1.8L) SOHC Isuzu 4 Cyl, 3.307in./84mm (1976-1979) 2

Part	Year	VIN	Model/Application	Part Number	Qty.
------	------	-----	-------------------	-------------	------

ENGINE GASKETS

Head Set	1976-1979				HS3553	1
Full Set	1976-1979				FS3553	1
Engine Kit Gasket Set	1976-1979				95-3404VR	1
Cylinder Head Gasket	1976-1979			Nitroseal	3553	1
Cyl. Head Spacer Shim	1976-1979		Requires Sealing Compound	Steel	3553S	1
Sealing Compound	1976-1979		(4 Ounce Brush Top Can)		JV66B	1
					(12 Ounce Spray Can)	JV66S
Valve Cover Set	1976-1979		(Contains Valve Cover End Plugs)	Cork Rubber	VS38132	1
Valve Stem Seal, Exh.	1976-1979				B20183	4
Valve Stem Seal, Int.	1976-1979				B20183	4
Manifold Set, Exhaust	1976-1979				MS12282	1
Manifold Set, Intake	1976-1979				MS12279	1
Oil Pan Set	1976-1979			Victo-Tech	OS30164	1
Rear Main Seal Set	1976-1979				JV626	1
Timing Cover Set	1976-1979		(Requires Oil Pan Set, Requires Valve Cover Set)		JV950	1

MISCELLANEOUS GASKETS

Carb. Mount Gasket	1976-1979		2 Barrel Carburetor		G26707	2
Exhaust Pipe Gasket	1976-1979		(Ring Type 'B'), Pipe To Manifold		F20223	1
Water Outlet Gasket	1976-1979		(2 Holes)	Victopac	C20115	1
Water Pump Mount Gasket	1976-1979				K27272	1

3 1897CC (1.9L) 4 Cyl, 3.661in./93mm (1968-1975) 3

Part	Year	VIN	Model/Application	Part Number	Qty.
------	------	-----	-------------------	-------------	------

ENGINE GASKETS

Head Set	1973-1975		1900, Kadett, Manta, Olympia, Rekord, (Valve Stem Seals Not Included)		HS3595	1
	1973		GT, (Valve Stem Seals Not Included)		HS3595	1
	1969-1972		GT, (Valve Stem Seals Not Included)		HS3596	1
Cylinder Head Gasket	1973-1975			VR2000	3595	1
	1968-1972			VR2000	3589	1
Valve Cover Set	1968-1975			Cork Rubber	VS30013	1
Valve Stem Seal, Exh.	1968-1975				B20216	4
Valve Stem Seal, Int.	1968-1975				B20216	4
Oil Pan Set	1968-1975				OS30049	1
Rear Main Seal	1968-1975			Rubber	66690	1

Opel

3 (cont.)	1897CC (1.9L) 4 Cyl, 3.661in./93mm (1968-1975)				3 (cont.)
---------------------	---	--	--	--	---------------------

Part	Year	VIN	Model/Application	Part Number	Qty.
------	------	-----	-------------------	-------------	------

MISCELLANEOUS GASKETS

Therm. Housing Gasket	1968-1975			C20113	1
Water Outlet Gasket	1968-1975			C24109	1

Passport

Engine Index

Engine	Year	Block
122 CID (2.0L) OHC Pontiac	1989-1990	1

Model Index

Model	Engine	Year	Block
Optima	122 CID (2.0L) OHC Pontiac	1989-1990	1

1	122 CID (2.0L) OHC Pontiac 4 Cyl, 3.386in./86mm (1989-1990)				1
----------	--	--	--	--	----------

Part	Year	VIN	Model/Application	Part Number	Qty.
------	------	-----	-------------------	-------------	------

ENGINE GASKETS

Engine Kit Gasket Set	1989-1990			95-3251VR	1
-----------------------	-----------	--	--	-----------	---

Peugeot

Engine Index

Engine	Year	Block
1971CC (2.0L) XN6	1980-1987	1
2304CC (2.3L) XD2 Diesel	1977-1984	2
2304CC (2.3L) XD2S Turbo Diesel	1981-1984	3

Engine	Year	Block
2664CC (2.7L) ZM	1977-1978	4
2849CC (2.8L) ZN3J	1988-1990	5

Model Index

Model	Engine	Year	Block
504	2304CC (2.3L) XD2 Diesel	1977-1983	2
505	1971CC (2.0L) XN6	1980-1987	1
505	2304CC (2.3L) XD2S Turbo Diesel	1980-1985	3
505	2304CC (2.3L) XD2 Diesel	1980-1984	2

Model	Engine	Year	Block
505	2849CC (2.8L) ZN3J	1987-1991	5
604	2304CC (2.3L) XD2S Turbo Diesel	1981-1984	3
604	2664CC (2.7L) ZM	1977-1978	4

1	1971CC (2.0L) XN6 4 Cyl, 3.465in./88mm (1980-1987)				1
----------	---	--	--	--	----------

Part	Year	VIN	Model/Application	Part Number	Qty.
------	------	-----	-------------------	-------------	------

ENGINE GASKETS

Head Set	1980-1987		XN2, XN6 Fuel Injected Engine, (Valve Stem Seals Not Included)	HS3661	1
Full Set	1980-1987		XN2, XN6 Fuel Injected Engine, (Rear Main Seal Not Required, Valve Stem Seals Not Included, Timing Cover Seal Not Required)	FS3661	1
Cylinder Head Gasket	1980-1987		XN2, XN6 Fuel Injected Engine	3661	1
Valve Cover Set	1980-1987		XN2, XN6 Fuel Injected Engine, (Spark Plug Tube Seals Not Included)	VS30226	1
Valve Stem Seal, Exh.	1980-1987		XN2, XN6 Fuel Injected Engine	B45472	4
Valve Stem Seal, Int.	1980-1987		XN2, XN6 Fuel Injected Engine	B45472	4
Manifold Set, Exhaust	1980-1987		XN2, XN6 Fuel Injected Engine	MS15254	1
Manifold Set, Intake	1980-1987		XN2, XN6 Fuel Injected Engine	MS15286	1

MISCELLANEOUS GASKETS

Exhaust Pipe Gasket	1980-1987		XN2, XN6 Fuel Injected Engine, (Flange Type), Pipe To Manifold	F7456	1
Spark Plug Tube Seal	1980-1987		XN2, XN6 Fuel Injected Engine	B45732	4
Water Pump Mount Gasket	1980-1987		XN2, XN6 Fuel Injected Engine	K31019	1

2 2304CC (2.3L) XD2 Diesel 4 Cyl, 3.701in./94mm (1977-1984) 2

Part	Year	VIN	Model/Application	Part Number	Qty.
ENGINE GASKETS					
Head Set	1977-1983		(Head Gasket Not Included, Replacement Gasket Must Be Of Same Thickness As One Removed)	HS4850LH	1
Full Set	1977-1983		(Head Gasket Not Included, Replacement Gasket Must Be Of Same Thickness As One Removed)	FS4850LH	1
Cylinder Head Gasket	1980-1984		Piston Protrusion Greater Than 0.84mm, (3 Notches) 1.70mm Thickness	4849	1
Valve Cover Set	1977-1984			VS50006	1
Valve Stem Seal, Exh.	1977-1984			B45552	4
Valve Stem Seal, Int.	1977-1984			B45552	4
Manifold Set, Exhaust	1977-1983			MS10061	1
Manifold Set, Intake	1977-1983			MS10063	1
Oil Pan Set	1980-1984		Upper	OS32003	1
	1977-1984		Lower	OS32059	1
Rear Main Seal Set	1977-1984			JV546	1

MISCELLANEOUS GASKETS

Water Pump Mount Gasket	1977-1984			K31018	1
-------------------------	-----------	--	--	--------	---

3 2304CC (2.3L) XD2S Turbo Diesel 4 Cyl, 3.701in./94mm (1981-1984) 3

Part	Year	VIN	Model/Application	Part Number	Qty.
ENGINE GASKETS					
Head Set	1981-1984		(Head Gasket Not Included, Replacement Gasket Must Be Of Same Thickness As One Removed)	HS4849LH	1
Full Set	1981-1984		(Head Gasket Not Included, Replacement Gasket Must Be Of Same Thickness As One Removed)	FS4849LH	1
Cylinder Head Gasket	1982-1984		Piston Protrusion Greater Than 0.84mm, (3 Notches) 1.70mm Thickness	4849	1
Valve Cover Set	1981-1984			VS50006	1
Valve Stem Seal, Exh.	1981-1984			B45552	4
Valve Stem Seal, Int.	1981-1984			B45552	4
Manifold Set, Exhaust	1981-1984			MS10060	1
Manifold Set, Intake	1981-1984			MS10059	1
Oil Pan Set	1981-1984		Upper	OS32003	1
			Lower	OS32059	1
Rear Main Seal Set	1981-1984			JV546	1

MISCELLANEOUS GASKETS

Water Pump Mount Gasket	1981-1984			K31018	1
-------------------------	-----------	--	--	--------	---

4 2664CC (2.7L) ZM V6 Cyl, 3.465in./88mm (1977-1978) 4

Part	Year	VIN	Model/Application	Part Number	Qty.
ENGINE GASKETS					
Valve Cover Set	1977-1978			VS30276	1
Valve Stem Seal, Exh.	1977-1978		Teflon	B45423	6
			Fluoroelastomer	B45546	6
Valve Stem Seal, Int.	1977-1978		Teflon	B45423	6
			Fluoroelastomer	B45546	6
Manifold Set, Exhaust	1977-1978			MS16715	1
Manifold Set, Intake	1977-1978			MS10037	1
Rear Main Seal Set	1977-1978			JV512	1
Timing Cover Set	1977-1978		(Valve Cover Gasket Must Be Replaced With Timing Cover Set)	JV960	1

MISCELLANEOUS GASKETS

Exhaust Pipe Gasket	1977-1978		(Flange Type), Pipe To Manifold	F5360C	2
Water Outlet Gasket	1977-1978			C20280	1

Peugeot

5 2849CC (2.8L) ZN3J V6 Cyl, 3.583in./91mm (1988-1990) 5

Part	Year	VIN	Model/Application	Part Number	Qty.
ENGINE GASKETS					
Cylinder Head Gasket	1988-1990		Left	5715	1
			Right	5716	1
Valve Cover Set	1988-1990			VS30276	1
Manifold Set, Exhaust	1988-1990			MS16715	1
Rear Main Seal Set	1988-1990			JV512	1
Timing Cover Set	1988-1990			JV960	1
MISCELLANEOUS GASKETS					
Water Outlet Gasket	1988-1990			C20280	1

Porsche

Engine Index

Engine	Year	Block	Engine	Year	Block
1679CC (1.7L) 022	1970-1973	1	1985CC (2.0L)	1977-1982	3
1795CC (1.8L) 021	1974-1976	2	2479CC (2.5L)	1983-1989	4

Model Index

Model	Engine	Year	Block	Model	Engine	Year	Block
914	1679CC (1.7L) 022	1970-1973	1	944	2479CC (2.5L)	1983-1988	4
914	1795CC (1.8L) 021	1974-1976	2	944 Turbo	2479CC (2.5L)	1986-1988	4
924	1985CC (2.0L)	1977-1982	3	944S	2479CC (2.5L)	1987-1988	4
924S	2479CC (2.5L)	1987	4				

1 1679CC (1.7L) 022 4 Cyl, 3.543in./90mm (1970-1973) 1

Part	Year	VIN	Model/Application	Part Number	Qty.
ENGINE GASKETS					
Full Set	1970-1973		(Valve Stem Seals Not Included)	FS3579	1
Valve Cover Set	1970-1973		Cork Rubber	VS30004	1
Valve Stem Seal, Exh.	1970-1973			B45429	4
Valve Stem Seal, Int.	1970-1973			B45429	4
Rear Main Seal	1970-1973		Rubber	66941	1
Timing Cover Set	1970-1973			JV631	1
MISCELLANEOUS GASKETS					
Oil Strainer Gasket Set	1970-1973			OS20100	1

2 1795CC (1.8L) 021 4 Cyl, 3.661in./93mm (1974-1976) 2

Part	Year	VIN	Model/Application	Part Number	Qty.
ENGINE GASKETS					
Full Set	1974-1976		(Valve Stem Seals Not Included)	FS3575	1
Valve Cover Set	1974-1976		Cork Rubber	VS30004	1
Valve Stem Seal, Exh.	1974-1976			B45429	4
Valve Stem Seal, Int.	1974-1976			B45429	4
Rear Main Seal	1974-1976		Rubber	66941	1
Timing Cover Set	1974-1976			JV631	1
MISCELLANEOUS GASKETS					
Oil Strainer Gasket Set	1974-1976			OS20100	1

3 1985CC (2.0L) 4 Cyl, 3.406in./86.5mm (1977-1982) 3

Part	Year	VIN	Model/Application	Part Number	Qty.
ENGINE GASKETS					
Head Set	1977-1982			HS3649	1
Lower Set	1977-1982		(Requires Head Set To Make Full Set)	CS3649	1
Cylinder Head Gasket	1977-1979		VR2000	3649	1
Valve Cover Set	1977-1982			VS30228	1
Valve Stem Seal, Exh.	1977-1982			B20169	4

3 1985CC (2.0L) 4 Cyl, 3.406in./86.5mm (1977-1982) **3**
(cont.) (cont.)

Part	Year	VIN	Model/Application	Part Number	Qty.
ENGINE GASKETS (cont.)					
Valve Stem Seal, Int.	1977-1982			B20169	4
Manifold Set, Exhaust	1977-1982			MS15253	1
Manifold Set, Intake	1977-1982			MS15319	1
Oil Pan Set	1977-1982			OS30229	1
Rear Main Seal Set	1977-1982			JV510	1
Timing Cover Set	1977-1979			JV956	1

MISCELLANEOUS GASKETS

Exhaust Pipe Gasket	1977-1979		(Flange Type), Pipe To Manifold	F20318	1
Water Outlet Gasket	1977-1982			C20315	1
Water Pump Mount Gasket	1977-1982			K27256	1

4 2479CC (2.5L) 4 Cyl, 3.937in./100mm (1983-1989) **4**

Part	Year	VIN	Model/Application	Part Number	Qty.
------	------	-----	-------------------	-------------	------

ENGINE GASKETS

Head Set	1983-1988		Single Overhead Camshaft Engine	HS5728	1
Lower Set	1985-1989		Single Overhead Camshaft Engine, (Requires Head Set To Make Full Set)	CS5728W	1
	1983-1984		(Requires Head Set To Make Full Set)	CS5728	1
Cylinder Head Gasket	1983-1988		Single Overhead Camshaft Engine	5728	1
Valve Stem Seal, Exh.	1983-1988		944	B45568	4
Valve Stem Seal, Int.	1983-1988		944	B45568	4
Manifold Set, Exhaust	1983-1988		Single Overhead Camshaft Engine	MS10067	1
Manifold Set, Intake	1983-1988		Single Overhead Camshaft Engine	MS10066	1
Oil Pan Set	1983-1989		Single Overhead Camshaft Engine <i>Victo-Tech</i>	OS32033	1
Rear Main Seal	1983-1988		<i>Rubber</i>	66972	1
Timing Cover Seal	1985-1988			66993	1
	1983-1984			66971	1

MISCELLANEOUS GASKETS

Cam. Cover Gasket	1983-1989			VS50021	1
Exhaust Pipe Gasket	1983-1988		Single Overhead Camshaft Engine, (Flange Type), Pipe To Manifold	F10068	1
Water Pump Mount Gasket	1983-1989		Single Overhead Camshaft Engine	K30683	1
	1987-1988			K30683	1

Renault

Engine Index

Engine	Year	Block
1289CC (1.3L) 8.5 to 1 Compression	1976-1979	1
1397CC (1.4L)	1983-1987	2
1397CC (1.4L) 8.8 to 1 Compression	1980-1983	3

Engine	Year	Block
1647CC (1.6L) 8.6 to 1 Compression	1981-1983	4
105 CID/1721CC (1.7L) F3N	1985-1987	5
1965CC (2.0L) F3R	1987	6

Model Index

Model	Engine	Year	Block
18i	1647CC (1.6L) 8.6 to 1 Compression	1981-1983	4
Alliance	105 CID/1721CC (1.7L) F3N	1985-1987	5
Alliance	1397CC (1.4L)	1983-1987	2
Encore	105 CID/1721CC (1.7L) F3N	1985-1986	5
Encore	1397CC (1.4L)	1984-1986	2
Fuego	1647CC (1.6L) 8.6 to 1 Compression	1982-1983	4

Model	Engine	Year	Block
GTA	1965CC (2.0L) F3R	1987	6
R5	1289CC (1.3L) 8.5 to 1 Compression	1976-1979	1
R5	1397CC (1.4L) 8.8 to 1 Compression	1980-1983	3

Renault

1 1289CC (1.3L) 8.5 to 1 Compression 4 Cyl, 2.874in./73mm (1976-1979) 1

Part	Year	VIN	Model/Application	Part Number	Qty.
------	------	-----	-------------------	-------------	------

ENGINE GASKETS

Manifold Set, Int. & Exh.	1976-1979			MS15255	1
Rear Main Seal	1976-1979		Rubber	66748	1
Timing Cover Gasket	1976-1979			T20343	1

MISCELLANEOUS GASKETS

Cam & Idler Seal	1976-1979			66630	1
Exhaust Pipe Gasket	1976-1979		(Flange Type), Pipe To Manifold	F20233	1
Water Outlet Gasket	1976-1979		Silicone	JV6	1

2 1397CC (1.4L) 4 Cyl, 2.992in./76mm (1983-1987) 2

Part	Year	VIN	Model/Application	Part Number	Qty.
------	------	-----	-------------------	-------------	------

ENGINE GASKETS

Head Set	1983-1987			HS3738W	1
Lower Set	1983-1987		(Requires Oil Pan Set, Requires Head Set To Make Full Set)	CS3738W	1
Engine Kit Gasket Set	1983-1987			95-3098VR	1
Cylinder Head Gasket	1983-1987			3738	1
Manifold Gasket	1983-1987		Intake To Exhaust	B45597	1
Manifold Set, Int. & Exh.	1983-1987			MS15346	1
Oil Pan Set	1983-1987		Cork Rubber	OS32093	1
Rear Main Seal	1983-1987		Rubber	66748	1
Timing Cover Seal	1983-1987			66747	1

MISCELLANEOUS GASKETS

Cam & Idler Seal	1983-1987			66630	1
Cyl. Liner Seal Set	1983-1987			GS33146	1
E.G.R. Gasket	1983-1987			G17797	1
Exhaust Pipe Gasket	1983-1987		(Flange Type), Pipe To Manifold	F7434	1
Water Outlet Gasket	1983-1987		Silicone	JV6	1
Water Pump Mount Gasket	1983-1987		Pump To Block	K30611	1
			Housing	K31024	1

3 1397CC (1.4L) 8.8 to 1 Compression 4 Cyl, 2.992in./76mm (1980-1983) 3

Part	Year	VIN	Model/Application	Part Number	Qty.
------	------	-----	-------------------	-------------	------

ENGINE GASKETS

Lower Set	1980-1983		(Requires Oil Pan Set, Requires Head Set To Make Full Set)	CS3738	1
Cylinder Head Gasket	1980-1983			3738	1
Manifold Set, Int. & Exh.	1980-1983			MS15255	1
Rear Main Seal	1980-1983		Rubber	66748	1
Timing Cover Gasket	1980-1983			T20343	1

MISCELLANEOUS GASKETS

Cam & Idler Seal	1980-1983			66630	1
E.G.R. Gasket	1980-1983			G17797	1
Fuel Pump Gasket	1980-1983		Fuel Pump To Spacer	D31021	1
Water Outlet Gasket	1980-1983		Silicone	JV6	1

4 1647CC (1.6L) 8.6 to 1 Compression 4 Cyl, 3.110in./79mm (1981-1983) 4

Part	Year	VIN	Model/Application	Part Number	Qty.
------	------	-----	-------------------	-------------	------

ENGINE GASKETS

Valve Cover Set	1981-1983		Victo-Tech	VS50022	1
Valve Stem Seal, Exh.	1981-1983			B45472	4
Valve Stem Seal, Int.	1981-1983			B45472	4

4 (cont.)	1647CC (1.6L) 8.6 to 1 Compression 4 Cyl, 3.110in./79mm (1981-1983)				4 (cont.)
---------------------	--	--	--	--	---------------------

<i>Part</i>	<i>Year</i>	<i>VIN</i>	<i>Model/Application</i>	<i>Part Number</i>	<i>Qty.</i>
-------------	-------------	------------	--------------------------	--------------------	-------------

ENGINE GASKETS (cont.)

Oil Pan Set	1981-1983			OS32036	1
Rear Main Seal	1981-1983		Rubber	66748	1

MISCELLANEOUS GASKETS

Exhaust Pipe Gasket	1981-1983		(Flange Type), Pipe To Manifold	F7434	1
Water Pump Mount Gasket	1981-1983			K30684	1

5	105 CID/1721CC (1.7L) F3N 4 Cyl, 3.189in./81mm (1985-1987)				5
----------	---	--	--	--	----------

<i>Part</i>	<i>Year</i>	<i>VIN</i>	<i>Model/Application</i>	<i>Part Number</i>	<i>Qty.</i>
-------------	-------------	------------	--------------------------	--------------------	-------------

ENGINE GASKETS

Head Set	1985-1987			HS5710	1
Cylinder Head Gasket	1985-1987			5710	1
Valve Cover Set	1985-1987		(Contains Valve Cover Washers)	VS50008	1
Valve Stem Seal, Exh.	1985-1987		Teflon	B45423	4
Valve Stem Seal, Int.	1985-1987		Teflon	B45423	4
Manifold Set, Int. & Exh.	1985-1987			MS15353	1
Oil Pan Set	1985-1987		Cork Rubber	OS32092	1
Rear Main Seal	1985-1987		Rubber	66954	1
Timing Cover Set	1985-1987			JV1015	1

MISCELLANEOUS GASKETS

Cam & Idler Seal	1985-1987		Front	66966	1
			Rear	66967	1
E.G.R. Gasket	1985-1987			G26315	1
Exhaust Pipe Gasket	1985-1987		(Flange Type), Pipe To Manifold	F7434	1
Water Outlet Gasket	1985-1987			C20634	1
Water Pump Mount Gasket	1985-1987			K30635	1

6	1965CC (2.0L) F3R 4 Cyl, 3.228in./82mm (1987)				6
----------	--	--	--	--	----------

<i>Part</i>	<i>Year</i>	<i>VIN</i>	<i>Model/Application</i>	<i>Part Number</i>	<i>Qty.</i>
-------------	-------------	------------	--------------------------	--------------------	-------------

ENGINE GASKETS

Head Set	1987			HS5710	1
Cylinder Head Gasket	1987			5710	1
Valve Cover Set	1987			VS50008	1
Valve Stem Seal, Exh.	1987		Teflon	B45423	4
Valve Stem Seal, Int.	1987		Teflon	B45423	4
Manifold Set, Int. & Exh.	1987			MS15353	1
Oil Pan Set	1987		Cork Rubber	OS32092	1
Rear Main Seal	1987		Rubber	66954	1
Timing Cover Set	1987			JV1015	1

MISCELLANEOUS GASKETS

Cam & Idler Seal	1987		Front	66966	1
			Rear	66967	1
E.G.R. Gasket	1987			G26315	1
Exhaust Pipe Gasket	1987		(Flange Type), Pipe To Manifold	F7434	1
Water Outlet Gasket	1987			C20634	1
Water Pump Mount Gasket	1987			K30635	1

Saab

Engine Index

Engine	Year	Block	Engine	Year	Block
1985CC (2.0L) B201 SOHC	1973-1988	1	1985CC (2.0L) B202 DOHC	1981-1992	2

Model Index

Model	Engine	Year	Block	Model	Engine	Year	Block
99	1985CC (2.0L) B201 SOHC	1973-1980	1	9000	1985CC (2.0L) B202 DOHC	1986-1992	2
900	1985CC (2.0L) B202 DOHC	1981-1993	2	9000	1985CC (2.0L) B201 SOHC	1987-1989	1
900	1985CC (2.0L) B201 SOHC	1979-1989	1				

1	1985CC (2.0L) B201 SOHC 4 Cyl, 3.543in./90mm (1973-1988)					1
Part	Year	VIN	Model/Application	Part Number	Qty.	

ENGINE GASKETS

Head Set	1981-1988		(Exhaust Pipe Gasket Not Included, Exhaust Manifold Gasket Not Included)	HS5753	1
	1981-1984		Turbocharged	HS5753T	1
	1979-1980		Except Turbocharged	HS3667W	1
	1973-1978		Except Turbocharged, (Exhaust Pipe Gasket Not Included)	HS3667	1
Lower Set	1973-1980		Except Turbocharged, (Exhaust Pipe Gasket Not Included, Requires Head Set To Make Full Set)	CS3667	1
Full Set	1981-1988		(Exhaust Pipe Gasket Not Included, Exhaust Manifold Gasket Not Included)	FS5753	1
Cylinder Head Gasket	1981-1988		1.4mm Thickness	5753	1
Valve Cover Set	1981-1988			VS50035	1
	1979-1980		Except Turbocharged	VS30234	1
Manifold Set, Exhaust	1981-1988			MS15651	1
	1979-1980		Except Turbocharged	MS15468	1
Manifold Set, Intake	1982-1988			MS15541	1
	1979-1980		Except Turbocharged	MS15329	1
Manifold Set, Int. & Exh.	1973-1978			MS15285	1
Oil Pan Set	1973-1988		Except Turbocharged	OS30290	1
Rear Main Seal Set	1981-1988			JV558	1
Timing Cover Set	1981-1988			JV1045	1
	1979-1980		Except Turbocharged	JV1069	1
Timing Cover Seal	1981-1984		Turbocharged	67127	1

MISCELLANEOUS GASKETS

Exhaust Pipe Gasket	1987-1988		9000, Except Turbocharged, (Flange Type), Pipe To Manifold	F12328	1
	1981-1988		900, Except Turbocharged, (Flange Type), Pipe To Manifold	F12328	1
	1979-1980		99, Except California, Except Turbocharged, (Flange Type), Pipe To Manifold	F5645	2
			99, California, Except Turbocharged, (Flange Type), Pipe To Manifold	F12328	1
	1973-1978		99, Except Turbocharged, (Flange Type), Pipe To Manifold	F20293	1
Therm. Housing Gasket	1979-1984		900, Turbocharged	C30734	1
Water Outlet Gasket	1981-1984		900, Turbocharged	Victo-Tech C20283	1
	1974-1980			Victo-Tech C20283	1
Water Pump Mount Gasket	1979-1980		Except Turbocharged	K31025	1

2	1985CC (2.0L) B202 DOHC 4 Cyl, 3.543in./90mm (1981-1992)					2
Part	Year	VIN	Model/Application	Part Number	Qty.	

ENGINE GASKETS

Cylinder Head Gasket	1985-1992		Turbocharged/Intercooled	5827	1
Valve Cover Set	1985-1992		Turbocharged/Intercooled	Victo-Tech VS50147	1
Oil Pan Set	1985-1992		Turbocharged/Intercooled	OS30290	1

MISCELLANEOUS GASKETS

Therm. Housing Gasket	1981-1989		Turbocharged/Intercooled	C30734	1
Water Outlet Gasket	1985-1989		Turbocharged/Intercooled	Victo-Tech C20283	1

Engine Index

Engine	Year	Block
116 CID (1.9L) L24 SOHC	1995-2001	1
116 CID (1.9L) LK0 SOHC	1991-1994	2

Engine	Year	Block
116 CID (1.9L) LL0 DOHC	1991-2001	3

Model Index

Model	Engine	Year	Block
SC1	116 CID (1.9L) L24 SOHC	1995-2002	1
SC1	116 CID (1.9L) LK0 SOHC	1993-1994	2
SC2	116 CID (1.9L) LL0 DOHC	1993-2002	3
SC	116 CID (1.9L) LL0 DOHC	1991-1992	3
SL1	116 CID (1.9L) L24 SOHC	1995-2002	1
SL1	116 CID (1.9L) LK0 SOHC	1991-1994	2
SL2	116 CID (1.9L) LL0 DOHC	1991-2002	3

Model	Engine	Year	Block
SL	116 CID (1.9L) L24 SOHC	1995-2002	1
SL	116 CID (1.9L) LK0 SOHC	1991-1994	2
SW1	116 CID (1.9L) L24 SOHC	1995-1999	1
SW1	116 CID (1.9L) LK0 SOHC	1993-1994	2
SW2	116 CID (1.9L) LL0 DOHC	1993-2001	3
SWP	116 CID (1.9L) L24 SOHC	1999-2000	1

1 116 CID (1.9L) L24 SOHC 4 Cyl, 3.230in./82mm (1995-2001) 1

Part	Year	VIN	Model/Application	Part Number	Qty.
------	------	-----	-------------------	-------------	------

ENGINE GASKETS

Head Set	1995-1999		(Contains Valve Cover Gasket)	HS5992A	1
Lower Set	1995-1999		(Requires Head Set To Make Full Set)	CS5992	1
Engine Kit Gasket Set	1995-1997			95-3463VR	1
Cylinder Head Gasket	1995-2001		VR2000	5992	1
Valve Cover Set	1995-1997		Victo-Tech	VS50216	1
Valve Stem Seal, Exh.	1995-2001			B45811	4
Valve Stem Seal, Int.	1995-2001			B45811	4
Manifold Set, Exhaust	1995-1999			MS16146	1
Manifold Set, Intake	1995-1997			MS16155	1
Oil Pan Set	1995-1999		Original Equipment Uses RTV Silicone	JV6	1
Rear Main Seal Set	1995-2000			JV1619	1
Timing Cover Set	1995-1997			JV1174	1
Timing Cover Seal	1995-2001			48373	1

MISCELLANEOUS GASKETS

E.G.R. Gasket	1995-2001			G31356	1
Exhaust Pipe Gasket	1995-2001		Catalytic Converter To Front Exhaust Pipe	F7551	1
	1995-1999		Pipe To Manifold	F7530	1
Thermostat Seal	1995-2001			C31358	1
Throttle Body Gasket	1995-1997			G31341	1
Valve Cover Grommet	1995-1999			B45815	2
Water Outlet Gasket	1995-1999			C31347	1
Water Pump Mount Gasket	1995-1999			K31357	1

2 116 CID (1.9L) LK0 SOHC 4 Cyl, 3.230in./82mm (1991-1994) 2

Part	Year	VIN	Model/Application	Part Number	Qty.
------	------	-----	-------------------	-------------	------

ENGINE GASKETS

Head Set	1991-1994		(Contains Valve Cover Gasket)	HS5992	1
Lower Set	1991-1994		(Requires Head Set To Make Full Set)	CS5992	1
Engine Kit Gasket Set	1991-1994			95-3463VR	1
Cylinder Head Gasket	1991-1994		VR2000	5992	1
Valve Cover Set	1991-1994		Victo-Tech	VS50216	1
Valve Stem Seal, Exh.	1991-1994			B45811	4
Valve Stem Seal, Int.	1991-1994			B45811	4
Manifold Set, Exhaust	1991-1994			MS16146	1
Manifold Set, Intake	1991-1994			MS16145	1
Oil Pan Set	1991-1994		Original Equipment Uses RTV Silicone	JV6	1
Rear Main Seal Set	1991-1994			JV1619	1
Timing Cover Set	1991-1994			JV1174	1
Timing Cover Seal	1991-1994			48373	1

MISCELLANEOUS GASKETS

E.G.R. Gasket	1991-1994			G17797	1
Exhaust Pipe Gasket	1993-1994		Catalytic Converter	F7551	1

Saturn

2 (cont.)	116 CID (1.9L) LK0 SOHC 4 Cyl, 3.230in./82mm (1991-1994)				2 (cont.)
---------------------	---	--	--	--	---------------------

Part	Year	VIN	Model/Application	Part Number	Qty.
MISCELLANEOUS GASKETS (cont.)					
Exhaust Pipe Gasket (cont.)	1991-1994		Pipe To Manifold	F7530	1
	1991-1992		Catalytic Converter	F7559	1
Thermostat Seal	1991-1994			C31358	1
Throttle Body Gasket	1991-1994			G31340	1
Valve Cover Grommet	1991-1994			B45815	2
Water Outlet Gasket	1991-1994			C31347	1
Water Pump Mount Gasket	1991-1994			K31357	1

3	116 CID (1.9L) LL0 DOHC 4 Cyl, 3.230in./82mm (1991-2001)				3
----------	---	--	--	--	----------

Part	Year	VIN	Model/Application	Part Number	Qty.
ENGINE GASKETS					
Head Set	1991-1997		(Valve Cover Gasket Not Included)	HS5993	1
Lower Set	1991-1999		(Requires Head Set To Make Full Set)	CS5992	1
Engine Kit Gasket Set	1991-1997		(Contains Plastic Valve Cover Gasket, Valve Cover Gasket For Aluminum Cover Not Included), Use With Part Number VS50217	95-3462VR	1
Cylinder Head Gasket	1991-2001		<i>VR2000</i>	5993	1
Valve Cover Set	1994-1998		Plastic Cover <i>Victo-Tech</i>	VS50218	1
	1991-1995		Aluminum Cover <i>Victo-Tech</i>	VS50217	1
Valve Stem Seal, Exh.	1991-1998			B45811	8
Valve Stem Seal, Int.	1991-1998			B45811	8
Manifold Set, Exhaust	1991-1997			MS16148	1
Manifold Set, Intake	1991-1999			MS16147	1
Oil Pan Set	1991-1999		Original Equipment Uses RTV <i>Silicone</i>	JV6	1
Rear Main Seal	2000			JV1619	1
Rear Main Seal Set	1991-1999			JV1619	1
Timing Cover Set	1991-2001			JV1174	1
Timing Cover Seal	1991-2001			48373	1

MISCELLANEOUS GASKETS					
E.G.R. Gasket	1995-1999			G31356	1
	1991-1994		Except California	G30797	1
				California	G31356
Exhaust Pipe Gasket	1993-2001		Pipe To Manifold	F7530	1
			Catalytic Converter	F7551	1
	1991-1992		Pipe To Manifold	F7557	1
			Catalytic Converter	F7558	1
Thermostat Seal	1991-2001			C31358	1
Throttle Body Gasket	1991-1999			G31341	1
Valve Cover Grommet	1994-1999		Plastic Valve Cover	GS33304	1
	1991-1995		Aluminum Valve Cover	B45816	12
Water Outlet Gasket	1991-1999			C31347	1
Water Pump Mount Gasket	1991-1999			K31357	1

Sterling

Engine Index

Engine	Year	Block
2494CC (2.5L) C25A1 SOHC Honda	1987-1988	1
2675CC (2.7L) C27A1 SOHC Honda	1989-1991	2

Model Index

Model	Engine	Year	Block	Model	Engine	Year	Block
825	2494CC (2.5L) C25A1 SOHC Honda	1987-1988	1	827	2675CC (2.7L) C27A1 SOHC Honda	1988-1991	2

1	2494CC (2.5L) C25A1 SOHC Honda V6 Cyl, 3.307in./84mm (1987-1988)	1
----------	---	----------

Part	Year	VIN	Model/Application	Part Number	Qty.
ENGINE GASKETS					
Head Set	1987-1988		(Requires Lower Set To Make Full Set)	HS5760	1
Lower Set	1987-1988		(Requires Head Set To Make Full Set)	CS5760	1
Cylinder Head Gasket	1987-1988			Nitroseal 5760	2
Valve Cover Set	1987-1988		(Valve Cover End Plugs Not Included)	Victo-Tech VS50276	1
Valve Stem Seal, Exh.	1987-1988			B45595	12
Valve Stem Seal, Int.	1987-1988			B45594	12
Manifold Set, Exhaust	1987-1988			MS15437	1
Manifold Set, Intake	1987-1988			MS15436	1
Plenum Chamber Gasket	1987-1988			MS12349	1
Oil Pan Set	1987-1988			Victo-Tech OS32047	1
Rear Main Seal	1987-1988			Rubber 66986	1
Timing Cover Set	1987-1988		(Camshaft Seal Not Included)	JV1054	1

MISCELLANEOUS GASKETS

Camshaft Seal	1987-1988			66985	2
E.G.R. Gasket	1987-1988			G30797	1
Exhaust Pipe Gasket	1987-1988		(Ring Type 'A'), Pipe To Manifold	F7413	1
			(Ring Type 'A'), Catalytic Converter	F14616	2
Push Rod Cover Set	1987-1988			PS39131	1
Valve Cover End Plug	1987-1988			B45620	1
Water Outlet Gasket	1987-1988			Victo-Tech C24173	1

2	2675CC (2.7L) C27A1 SOHC Honda V6 Cyl, 3.425in./87mm (1989-1991)	2
----------	---	----------

Part	Year	VIN	Model/Application	Part Number	Qty.
ENGINE GASKETS					
Head Set	1989-1991		(Requires Lower Set To Make Full Set)	HS5773	1
Lower Set	1989-1991		(Requires Head Set To Make Full Set)	CS5760	1
Cylinder Head Gasket	1989-1991			Nitroseal 5773	2
Valve Cover Set	1989-1991		(Valve Cover End Plugs Not Included)	Victo-Tech VS50276	1
Valve Stem Seal, Exh.	1989-1991			B45595	12
Valve Stem Seal, Int.	1989-1991			B45594	12
Manifold Set, Exhaust	1989-1991			MS15437	1
Manifold Set, Intake	1989-1991		(Contains Plenum Chamber Gasket)	MS12341	1
Plenum Chamber Gasket	1989-1991			MS12351	1
Oil Pan Set	1989-1991			Victo-Tech OS32047	1
Rear Main Seal	1989-1991			Rubber 66986	1
Timing Cover Set	1989-1991		(Camshaft Seal Not Included)	JV1054	1

MISCELLANEOUS GASKETS

Camshaft Seal	1989-1991			66985	2
E.G.R. Gasket	1989-1991			G30797	1
Exhaust Pipe Gasket	1989-1991		(Ring Type 'A'), Pipe To Manifold	F7413	1
			(Ring Type 'A'), Catalytic Converter	F14616	2
Push Rod Cover Set	1989-1991			PS39131	1
Valve Cover End Plug	1989-1991			B45620	1
Water Outlet Gasket	1989-1991			Victo-Tech C24173	1
Water Pump Mount Gasket	1989-1991			K31030	1

Studebaker

Engine Index

Engine	Year	Block
169 CID (2.8L)	1941-1954	1
194 CID (3.2L) Chevrolet	1965-1966	2
224 CID (3.7L) OHV	1955-1956	3
230 CID (3.8L) Chevrolet	1966	4
259 CID (4.2L) OHV	1955-1964	5
283 CID (4.6L) Chevrolet	1965-1966	6

Engine	Year	Block
289 CID (4.7L)	1960-1964	7
289 CID (4.7L) OHV	1960-1964	8
289 CID (4.7L) R1	1963-1964	9
289 CID (4.7L) R2	1963-1964	10
304 CID (5.0L)	1964	11
304 CID (5.0L) R3	1964	12

Model Index

Model	Engine	Year	Block
	169 CID (2.8L)	1941-1954	1
	194 CID (3.2L) Chevrolet	1965-1966	2
	224 CID (3.7L) OHV	1955-1956	3
	230 CID (3.8L) Chevrolet	1966	4
	259 CID (4.2L) OHV	1955-1964	5
	283 CID (4.6L) Chevrolet	1965-1966	6
	289 CID (4.7L)	1956-1964	7
	304 CID (5.0L)	1964	11
Avanti	289 CID (4.7L) R1	1963-1964	9
Avanti	289 CID (4.7L) R2	1963-1964	10
Avanti	304 CID (5.0L) R3	1964	12
Commander	194 CID (3.2L) Chevrolet	1965-1966	2
Commander	224 CID (3.7L) OHV	1955	3
Commander	230 CID (3.8L) Chevrolet	1966	4
Commander	259 CID (4.2L) OHV	1955-1957	5
Commander	283 CID (4.6L) Chevrolet	1965-1966	6
Cruiser	194 CID (3.2L) Chevrolet	1965-1966	2

Model	Engine	Year	Block
Daytona	194 CID (3.2L) Chevrolet	1966	2
Daytona	230 CID (3.8L) Chevrolet	1966	4
Daytona	283 CID (4.6L) Chevrolet	1965-1966	6
Grand	289 CID (4.7L) OHV	1962-1964	8
Truismo			
Hawk			
Hawk	259 CID (4.2L) OHV	1960-1961	5
Hawk	289 CID (4.7L) OHV	1961	8
Lark	259 CID (4.2L) OHV	1959-1964	5
Lark	289 CID (4.7L) OHV	1961-1964	8
President	259 CID (4.2L) OHV	1955	5
Silver Hawk	259 CID (4.2L) OHV	1959	5
Silver Hawk	289 CID (4.7L) OHV	1957-1961	8
Wagonaire	194 CID (3.2L) Chevrolet	1966	2
Wagonaire	230 CID (3.8L) Chevrolet	1966	4
Wagonaire	283 CID (4.6L) Chevrolet	1966	6

1 169 CID (2.8L) 6 Cyl, 3.000in./76.2mm (1941-1954) 1

Part	Year	VIN	Model/Application	Part Number	Qty.
------	------	-----	-------------------	-------------	------

ENGINE GASKETS

Cylinder Head Gasket	1941-1954		VR2000	1060	1
Manifold Set, Int. & Exh.	1941-1954			MS15032Y	1

MISCELLANEOUS GASKETS

Exhaust Pipe Gasket	1941-1954			F17802	1
Fuel Pump Bowl Gasket	1941-1954			D35288	1
Fuel Pump Gasket	1941-1954			D27094	1
Vlv. Cover Stud Washer	1941-1954			2007	4

2 194 CID (3.2L) Chevrolet 6 Cyl, 3.563in./90.5mm (1965-1966) 2

Part	Year	VIN	Model/Application	Part Number	Qty.
------	------	-----	-------------------	-------------	------

ENGINE GASKETS

Head Set	1965-1966			HS1185E	1
Lower Set	1965-1966		(Requires Head Set To Make Full Set)	CS1185	1
Full Set	1965-1966			FS1185E	1
Cylinder Head Gasket	1965-1966		VR2000	3829	1
Valve Cover Set	1965-1966		Cork Rubber	VS39693	1
Valve Stem Seal, Exh.	1965-1966			B45229	6
Valve Stem Seal, Int.	1965-1966			B45229	6
Manifold Set, Int. & Exh.	1965-1966			MS16033X	1
Oil Pan Set	1965-1966		Cork Rubber	OS30988X	1
Rear Main Seal Set	1965-1966			JV728	1
Timing Cover Set	1965-1966			JV862	1
			(Contains Repair Sleeve)	JV925	1
Timing Cover Gasket	1965-1966			T14744	1
Timing Cover Seal	1965-1966		3/8" Wide	49328	1
			(Lip Relocator Type) 1/2" Wide	65022	1
Harmonic Balancer Repair Sleeve	1965-1966		Ground Steel, .020" Thickness	66597RS	1

2 194 CID (3.2L) Chevrolet 6 Cyl, 3.563in./90.5mm (1965-1966) **2**
(cont.) (cont.)

Part Year VIN Model/Application Part Number Qty.

ENGINE GASKETS (cont.)

Harmonic Balancer Repair Sleeve (cont.)	1965-1966		Use With Part Number A504 <i>Nickel Plated Formed Steel, .013" Thickness</i>	A228	1
---	-----------	--	---	------	---

MISCELLANEOUS GASKETS

Air Cleaner Mount Gasket	1965-1966		1 Barrel Carburetor	G25936	1
Carb. Mount Gasket	1965-1966		1 Barrel Carburetor	G5349AD	1
Dist. Mounting Gasket	1965-1966			B26466	1
Exhaust Pipe Gasket	1965-1966		(Ring Type 'C'), Pipe To Manifold	F17250	1
			(Ring Type 'B'), Pipe To Manifold	<i>Sintered Metal</i> F17250S	1
Fuel Pump Gasket	1965-1966			D27094	1
				<i>Tuff-Cork</i> D27094TC	1
Push Rod Cover Set	1965-1966			<i>Cork Rubber</i> PS38113	1
Therm. Housing Gasket	1965-1966			C26544	1
Therm. Mount Gasket	1965-1966			C26544	1
Water Outlet Gasket	1965-1966			C24109	1
Water Pump Mount Gasket	1965-1966			K26545	1

3 224 CID (3.7L) OHV V8 Cyl, 3.563in./90.5mm (1955-1956) **3**

Part Year VIN Model/Application Part Number Qty.

ENGINE GASKETS

Valve Stem Seal, Exh.	1955-1956		Early 1955	B45233	8
			Except Early 1955	B45264	8
Valve Stem Seal, Int.	1955-1956		Early 1955	B45233	8
			Except Early 1955	B45264	8

MISCELLANEOUS GASKETS

Air Cleaner Mount Gasket	1955-1956		2 Barrel Carburetor	G25936	1
Exhaust Pipe Gasket	1955-1956		(Flange Type), Pipe To Manifold	F5436AK	3
Fuel Pump Bowl Gasket	1955			D35288	1
Fuel Pump Gasket	1955-1956			D27094	1

4 230 CID (3.8L) Chevrolet 6 Cyl, 3.875in./98.4mm (1966) **4**

Part Year VIN Model/Application Part Number Qty.

ENGINE GASKETS

Head Set	1966			HS1185E	1
Lower Set	1966		(Requires Head Set To Make Full Set)	CS1185	1
Full Set	1966			FS1185E	1
Engine Kit Gasket Set	1966		(Rear Main Seal Not Included), Use With Part Number JV728	95-3000VR	1
Cylinder Head Gasket	1966		<i>VR2000</i>	3829	1
Valve Cover Set	1966		<i>Cork Rubber</i>	VS39693	1
Valve Stem Seal, Exh.	1966		(O-Ring Type)	B45229	6
Valve Stem Seal, Int.	1966		(O-Ring Type)	B45229	6
Manifold Gasket	1966		Intake To Exhaust	B7354	1
Manifold Set, Int. & Exh.	1966			MS16033X	1
Oil Pan Set	1966		<i>Cork Rubber</i>	OS30988X	1
Rear Main Seal Set	1966			JV728	1
Timing Cover Set	1966		(Repair Sleeve Not Included)	JV862	1
			(Contains Repair Sleeve)	JV925	1
Timing Cover Gasket	1966			T14744	1
Timing Cover Seal	1966		<i>3/8" Wide</i>	49328	1
			(Lip Relocator Type) <i>1/2" Wide</i>	65022	1

Studebaker

4 (cont.)	230 CID (3.8L) Chevrolet 6 Cyl, 3.875in./98.4mm (1966)				4 (cont.)
--------------	--	--	--	--	--------------

Part	Year	VIN	Model/Application	Part Number	Qty.
------	------	-----	-------------------	-------------	------

ENGINE GASKETS (cont.)

Harmonic Balancer Repair Sleeve	1966		Ground Steel, .020" Thickness	66597RS	1
			Use With Part Number A504 Nickel Plated Formed Steel, .013" Thickness	A228	1

MISCELLANEOUS GASKETS

Air Cleaner Mount Gasket	1966		1 Barrel Carburetor	G25936	1
Carb. Mount Gasket	1966		1 Barrel Carburetor	G5349AD	1
Dist. Mounting Gasket	1966			B26466	1
Exhaust Pipe Gasket	1966		(Ring Type 'C'), Pipe To Manifold	F17250	1
			(Ring Type 'B'), Pipe To Manifold <i>Sintered Metal</i>	F17250S	1
Fuel Pump Gasket	1966			D27094	1
				<i>Tuff-Cork</i> D27094TC	1
Oil Pan Drain Plug Gst.	1966			2051	1
Therm. Housing Gasket	1966			C26544	1
Water Outlet Gasket	1966		(Universal Type)	C24109	1

5	259 CID (4.2L) OHV V8 Cyl, 3.563in./90.5mm (1955-1964)				5
---	--	--	--	--	---

Part	Year	VIN	Model/Application	Part Number	Qty.
------	------	-----	-------------------	-------------	------

ENGINE GASKETS

Valve Stem Seal, Exh.	1955-1964			B45264	8
Valve Stem Seal, Int.	1955-1964			B45264	8

MISCELLANEOUS GASKETS

Air Cleaner Mount Gasket	1955-1962		2 Barrel Carburetor	G25936	1
			4 Barrel Carburetor	G26410	1
Exhaust Pipe Gasket	1955-1964		(Flange Type), Pipe To Manifold	F5436AK	3
Fuel Pump Gasket	1955-1964			D27094	1
Water Outlet Gasket	1960-1964			C24109	1

6	283 CID (4.6L) Chevrolet V8 Cyl, 3.875in./98.4mm (1965-1966)				6
---	--	--	--	--	---

Part	Year	VIN	Model/Application	Part Number	Qty.
------	------	-----	-------------------	-------------	------

ENGINE GASKETS

Head Set	1965-1966			HS1178VJ	1
Full Set	1965-1966		(Exhaust Pipe Gasket Not Included)	FS1178VJ	1
Engine Kit Gasket Set	1965-1966			95-3033VR	1
Cylinder Head Gasket	1965-1966		VR2000	1178VC	2
Cyl. Head Bolt Set	1965-1966			GS33285	2
Valve Cover Set	1965-1966		<i>Cork Rubber</i>	VS38110	1
			<i>High Temperature Cork Rubber</i>	VS38110H	1
			<i>High Temperature Cork Rubber</i>	VS38110HA	1
Valve Stem Seal, Exh.	1965-1966			B45229	8
				B45264	8
			(High Temperature)	B45779	8
Valve Stem Seal, Int.	1965-1966			B45229	8
			<i>Fluoroelastomer</i>	B45418	8
Manifold Set, Exhaust	1965-1966			MS7110X	1
Manifold Set, Intake	1965-1966			MS15315	1
Oil Pan Set	1965-1966		<i>Cork Rubber</i>	OS30568X	1
			<i>Tuff-Cork</i>	OS30568XTC	1
Rear Main Seal Set	1965-1966		(Lip Relocator Type)	JV1627	1
Timing Cover Set	1965-1966			JV779	1
			(Contains Repair Sleeve)	JV919	1

6 283 CID (4.6L) Chevrolet V8 Cyl, 3.875in./98.4mm (1965-1966) **6**
(cont.) (cont.)

Part	Year	VIN	Model/Application	Part Number	Qty.
ENGINE GASKETS (cont.)					
Timing Cover Gasket	1965-1966			T27781	1
Timing Cover Seal	1965-1966		3/8" Wide	49328	1
Harmonic Balancer Repair Sleeve	1965-1966		Ground Steel, .020" Thickness	66597RS	1
			Use With Part Number A504 Nickel Plated Formed Steel, .013" Thickness	A228	1
MISCELLANEOUS GASKETS					
Air Cleaner Mount Gasket	1965-1966		4 Barrel Carburetor	G25936	1
Carb. Mount Gasket	1965-1966		4 Barrel Carburetor	G14116	1
Dist. Mounting Gasket	1965-1966			B25934	1
Exhaust Pipe Gasket	1965-1966		2" Pipe, (Ring Type 'C'), Pipe To Manifold	F17250	2
			2" Pipe, (Ring Type 'B'), Pipe To Manifold	Sintered Metal F17250S	2
			1.875" Pipe, (Ring Type 'C'), Pipe To Manifold	F17355	1
Fuel Pump Gasket	1965-1966		Plate To Block	D25932	1
			Plate To Block	Tuff-Cork D25932TC	1
			Pump To Plate	D27094	1
			Pump To Plate	Tuff-Cork D27094TC	1
Heat Riser Gasket	1965-1966			F7135	1
Oil Pan Drain Plug Gst.	1965-1966			2051	1
Water Outlet Gasket	1965-1966			C24109	1
				C25930	1
Water Pump Backing Plate	1965-1966		Pump To Plate	K27091	1
Water Pump Mount Gasket	1965-1966			K25935	2

7 289 CID (4.7L) V8 Cyl, 3.563in./90.5mm (1960-1964) **7**

Part	Year	VIN	Model/Application	Part Number	Qty.
ENGINE GASKETS					
Valve Stem Seal, Exh.	1961-1964			B45264	8
Valve Stem Seal, Int.	1961-1964			B45264	8
MISCELLANEOUS GASKETS					
Air Cleaner Mount Gasket	1960-1962		4 Barrel Carburetor	G26410	1
Exhaust Pipe Gasket	1960-1964		(Flange Type), Pipe To Manifold	F5436AK	3
Fuel Pump Gasket	1960-1964			D27094	1
Vlv. Cover Stud Washer	1960-1964			2007	3
Water Outlet Gasket	1960-1964			C24109	1

8 289 CID (4.7L) OHV V8 Cyl, 3.563in./90.5mm (1960-1964) **8**

Part	Year	VIN	Model/Application	Part Number	Qty.
ENGINE GASKETS					
Valve Stem Seal, Exh.	1961-1964			B45264	8
Valve Stem Seal, Int.	1961-1964			B45264	8
MISCELLANEOUS GASKETS					
Air Cleaner Mount Gasket	1960-1962		2 Barrel Carburetor	G25936	1
			4 Barrel Carburetor	G26410	1
Exhaust Pipe Gasket	1960-1964		(Flange Type), Pipe To Manifold	F5436AK	3
Fuel Pump Gasket	1960-1964			D27094	1
Vlv. Cover Stud Washer	1960-1964			2007	3
Water Outlet Gasket	1960-1964			C24109	1

Studebaker

9	289 CID (4.7L) R1 V8 Cyl, 3.563in./90.5mm (1963-1964)	9
----------	--	----------

Part	Year	VIN	Model/Application	Part Number	Qty.
ENGINE GASKETS					
Valve Stem Seal, Exh.	1963-1964			B45264	8
Valve Stem Seal, Int.	1963-1964			B45264	8

MISCELLANEOUS GASKETS					
Exhaust Pipe Gasket	1963-1964		(Flange Type), Pipe To Manifold	F5436AK	3
Fuel Pump Gasket	1963-1964			D27094	1
Vlv. Cover Stud Washer	1963-1964			2007	3
Water Outlet Gasket	1963-1964			C24109	1

10	289 CID (4.7L) R2 V8 Cyl, 3.563in./90.5mm (1963-1964)	10
-----------	--	-----------

Part	Year	VIN	Model/Application	Part Number	Qty.
ENGINE GASKETS					
Valve Stem Seal, Exh.	1963-1964			B45264	8
Valve Stem Seal, Int.	1963-1964			B45264	8

MISCELLANEOUS GASKETS					
Exhaust Pipe Gasket	1963-1964		(Flange Type), Pipe To Manifold	F5436AK	3
Fuel Pump Gasket	1963-1964			D27094	1
Vlv. Cover Stud Washer	1963-1964			2007	3
Water Outlet Gasket	1963-1964			C24109	1

11	304 CID (5.0L) V8 Cyl, 3.656in./92.9mm (1964)	11
-----------	--	-----------

Part	Year	VIN	Model/Application	Part Number	Qty.
ENGINE GASKETS					
Valve Stem Seal, Exh.	1964			B45264	8
Valve Stem Seal, Int.	1964			B45264	8

MISCELLANEOUS GASKETS					
Exhaust Pipe Gasket	1964		(Flange Type), Pipe To Manifold	F5436AK	3
Fuel Pump Gasket	1964			D27094	1
Vlv. Cover Stud Washer	1964			2007	3
Water Outlet Gasket	1964			C24109	1

12	304 CID (5.0L) R3 V8 Cyl, 3.656in./92.9mm (1964)	12
-----------	---	-----------

Part	Year	VIN	Model/Application	Part Number	Qty.
ENGINE GASKETS					
Valve Stem Seal, Exh.	1964			B45264	8
Valve Stem Seal, Int.	1964			B45264	8

MISCELLANEOUS GASKETS					
Exhaust Pipe Gasket	1964		(Flange Type), Pipe To Manifold	F5436AK	3
Fuel Pump Gasket	1964			D27094	1
Vlv. Cover Stud Washer	1964			2007	3
Water Outlet Gasket	1964			C24109	1

Engine Index

Engine	Year	Block
1189CC (1.2L) EF12	1987-1994	1
1361CC (1.4L) EA63	1973-1976	2
1595CC (1.6L) EA71	1976-1989	3
1781CC (1.8L) EA81 OHV	1980-1989	4
1781CC (1.8L) EA81T Turbo	1983-1984	5
1781CC (1.8L) EA82C OHC	1985-1987	6

Engine	Year	Block
1781CC (1.8L) EA82S OHC	1985-1994	7
1781CC (1.8L) EA82T OHC Turbo	1985-1990	8
1820CC (1.8L) EJ18E	1993-1997	9
2212CC (2.2L) EJ22E	1990-1995	10
2212CC (2.2L) EJ22T Turbo	1991-1994	11
2457CC (2.5L) EJ25D DOHC	1996-1998	12

Model Index

Model	Engine	Year	Block
1400	1361CC (1.4L) EA63	1973-1976	2
1600	1595CC (1.6L) EA71	1976-1989	3
1800	1781CC (1.8L) EA81 OHV	1980-1989	4
1800	1781CC (1.8L) EA82S OHC	1985-1989	7
1800	1781CC (1.8L) EA82C OHC	1985-1987	6
1800	1781CC (1.8L) EA82T OHC	1985-1989	8
	Turbo		
1800	1781CC (1.8L) EA81T Turbo	1983-1984	5
Impreza	1820CC (1.8L) EJ18E	1993-1997	9
Impreza	2212CC (2.2L) EJ22E	1993-2001	10
Impreza	2457CC (2.5L) EJ25D DOHC	1998-1999	12

Model	Engine	Year	Block
Justy	1189CC (1.2L) EF12	1987-1994	1
Legacy	2212CC (2.2L) EJ22T Turbo	1991-1994	11
Legacy	2212CC (2.2L) EJ22E	1990-1999	10
Legacy	2457CC (2.5L) EJ25D DOHC	1996-1999	12
Loyale	1781CC (1.8L) EA82S OHC	1990-1994	7
Loyale	1781CC (1.8L) EA82T OHC	1990	8
	Turbo		
XT	1781CC (1.8L) EA82S OHC	1985-1991	7
XT	1781CC (1.8L) EA82T OHC	1985-1987	8
	Turbo		

1 1189CC (1.2L) EF12 3 Cyl, 3.071in./78mm (1987-1994) 1

Part	Year	VIN	Model/Application	Part Number	Qty.
------	------	-----	-------------------	-------------	------

ENGINE GASKETS

Head Set	1990-1994		Multi-Port Fuel Injection	HS5762W	1
	1987-1992		2 Barrel Carburetor	HS5762	1
Lower Set	1990-1994		(Requires Head Set To Make Full Set)	CS5762	1
Full Set	1987-1992		2 Barrel Carburetor	FS5762	1
Cylinder Head Gasket	1987-1994			Nitroseal 5762	1
Valve Cover Set	1987-1994			Victo-Tech VS50046	1
Valve Stem Seal, Exh.	1987-1994			B45563	3
Valve Stem Seal, Int.	1987-1994			B45564	6
Manifold Set, Exhaust	1990-1994		Multi-Port Fuel Injection	MS12408	1
	1987-1992		2 Barrel Carburetor	MS12335	1
Manifold Set, Intake	1990-1994		Multi-Port Fuel Injection	MS12409	1
	1987-1992		2 Barrel Carburetor	MS12334	1
Plenum Chamber Gasket	1990-1994			MS12410	1
Oil Pan Set	1987-1994			Cork Rubber OS32048	1
Rear Main Seal Set	1987-1994			JV1616	1
Timing Cover Set	1987-1994			JV1055	1

MISCELLANEOUS GASKETS

Air Cleaner Mount Gasket	1987-1992		2 Barrel Carburetor	G31503	1
Camshaft Seal	1987-1994			66988	2
Carb. Mount Gasket	1987-1992		2 Barrel Carburetor	G30800	2
E.G.R. Gasket	1987-1992			G30691	1
Exhaust Pipe Gasket	1987-1994		(Flange Type), Catalytic Converter To Exhaust Pipe	F10098	1
			(Flange Type), Exhaust Manifold To Converter	F14153	1
	1987-1988		(Flange Type), Pipe To Manifold	F12284	1
Throttle Body Gasket	1990-1994			G31523	1
Water Outlet Gasket	1990-1994		Multi-Port Fuel Injection	Victo-Tech C24184	1
	1987-1992		2 Barrel Carburetor	C30798	1
Water Pump Mount Gasket	1987-1994			K30799	1

2 1361CC (1.4L) EA63 4 Cyl, 3.347in./85mm (1973-1976) 2

Part	Year	VIN	Model/Application	Part Number	Qty.
------	------	-----	-------------------	-------------	------

ENGINE GASKETS

Head Set	1976			HS3653	1
	1973-1975			HS3653W	1

Subaru

2 (cont.)	1361CC (1.4L) EA63 4 Cyl, 3.347in./85mm (1973-1976)				2 (cont.)
---------------------	--	--	--	--	---------------------

Part	Year	VIN	Model/Application	Part Number	Qty.
------	------	-----	-------------------	-------------	------

ENGINE GASKETS (cont.)

Full Set	1976		(Water Pump Mounting Gasket Not Included)	FS3653	1
	1973-1975		(Water Pump Mounting Gasket Not Included)	FS3653W	1
Cylinder Head Gasket	1973-1976			3653	2
Valve Cover Set	1973-1976		(Contains Valve Cover Washers) <i>Cork Rubber</i>	VS30235	1
Valve Stem Seal, Int.	1973-1976			B45434	4
Manifold Set, Intake	1976			MS15279	1
	1973-1975			MS15269	1
Oil Pan Set	1973-1976		<i>Cork Rubber</i>	OS30304	1
Rear Main Seal	1973-1976		<i>Rubber</i>	66704	1
Timing Cover Seal	1973-1976			66701	1

MISCELLANEOUS GASKETS

E.G.R. Gasket	1973-1976			G26315	1
Exhaust Pipe Gasket	1976		(Flange Type), Pipe To Manifold	F12284	2
	1975		(Flange Type), Pre-Muffler	F20239	2
	1973-1975		(Flange Type), Pipe To Manifold	F10041	4
	1973-1974		(Flange Type), Pre-Muffler	F10042	3
Oil Pump Mounting Gasket	1973-1976			B45720	1
Water Outlet Gasket	1973-1976			C20238	1
Water Pump Mount Gasket	1973-1976			K20203	1

3	1595CC (1.6L) EA71 4 Cyl, 3.622in./92mm (1976-1989)				3
----------	--	--	--	--	----------

Part	Year	VIN	Model/Application	Part Number	Qty.
------	------	-----	-------------------	-------------	------

ENGINE GASKETS

Head Set	1980-1989			HS3708	1
	1976-1979			HS3656	1
Full Set	1980-1989			FS3708	1
	1976-1979		(Water Pump Mounting Gasket Not Included)	FS3656	1
Cylinder Head Gasket	1976-1989		<i>VR2000</i>	3708	2
Valve Cover Set	1976-1989		(Contains Valve Cover Washers) <i>Cork Rubber</i>	VS30235	1
Valve Stem Seal, Int.	1976-1989			B45434	4
Manifold Set, Intake	1976-1989			MS15279	1
Oil Pan Set	1976-1989		<i>Cork Rubber</i>	OS30304	1
Rear Main Seal	1976-1989		<i>Rubber</i>	66704	1
Timing Cover Seal	1976-1989			66701	1

MISCELLANEOUS GASKETS

Carb. Mount Gasket	1976-1988		2 Barrel Carburetor	G30800	2
E.G.R. Gasket	1976-1989			G26315	1
Exhaust Pipe Gasket	1976-1989		(Flange Type), Pipe To Manifold	F12284	2
			(Flange Type), Pre-Muffler	F20239	2
Oil Pump Mounting Gasket	1976-1988			B45720	1
Water Outlet Gasket	1976-1989			C20238	1
Water Pump Gasket	1980-1989			K27668	1
	1976-1979			K20203	1
Water Pump Mount Gasket	1980-1987			K27668	1
	1976-1979			K20203	1

4	1781CC (1.8L) EA81 OHV 4 Cyl, 3.622in./92mm (1980-1989)				4
----------	--	--	--	--	----------

Part	Year	VIN	Model/Application	Part Number	Qty.
------	------	-----	-------------------	-------------	------

ENGINE GASKETS

Head Set	1980-1989			HS3709	1
Full Set	1980-1989			FS3709	1

4 (cont.)	1781CC (1.8L) EA81 OHV 4 Cyl, 3.622in./92mm (1980-1989)				4 (cont.)
---------------------	--	--	--	--	---------------------

<i>Part</i>	<i>Year</i>	<i>VIN</i>	<i>Model/Application</i>	<i>Part Number</i>	<i>Qty.</i>
ENGINE GASKETS (cont.)					
Cylinder Head Gasket	1980-1989		VR2000	3709	2
Valve Cover Set	1980-1989		(Contains Valve Cover Washers) Cork Rubber	VS39796	1
Valve Stem Seal, Int.	1980-1989			B45434	4
Manifold Set, Intake	1980-1989			MS15279	1
Oil Pan Set	1980-1989		Cork Rubber	OS30575	1
Rear Main Seal	1980-1989		Rubber	66853	1
Timing Cover Seal	1980-1989			66852	1

MISCELLANEOUS GASKETS					
Carb. Mount Gasket	1985-1989		2 Barrel Carburetor	G30800	2
Exhaust Pipe Gasket	1980-1989		(Flange Type), Exhaust Pipe To Muffler	F7429	1
			(Flange Type), Pipe To Manifold	F12284	2
			(Flange Type), Pre-Muffler	F20239	2
Oil Pump Mounting Gasket	1980-1989			B45721	1
Water Outlet Gasket	1980-1989			C30647	1
Water Pump Gasket	1980-1984			K27668	1
Water Pump Mount Gasket	1980-1989			K27668	1

5	1781CC (1.8L) EA81T Turbo 4 Cyl, 3.622in./92mm (1983-1984)				5
----------	---	--	--	--	----------

<i>Part</i>	<i>Year</i>	<i>VIN</i>	<i>Model/Application</i>	<i>Part Number</i>	<i>Qty.</i>
ENGINE GASKETS					
Full Set	1983-1984			FS3785	1
Cylinder Head Gasket	1983-1984		Nitroseal	3785	2
Valve Cover Set	1983-1984		(Contains Valve Cover Washers) Cork Rubber	VS39796	1
Valve Stem Seal, Int.	1983-1984			B45434	4
Manifold Set, Intake	1983-1984			MS15279	1
Oil Pan Set	1983-1984		Cork Rubber	OS30575	1
Rear Main Seal	1983-1984		Rubber	66853	1
Timing Cover Seal	1983-1984			66852	1

MISCELLANEOUS GASKETS					
E.G.R. Gasket	1983-1984			G26315	1
Exhaust Pipe Gasket	1983-1984		(Flange Type), Exhaust Pipe To Muffler	F7429	1
			(Flange Type), Pipe To Manifold	F12284	2
			(Flange Type), Pre-Muffler	F20239	2
Oil Pump Mounting Gasket	1983-1984			B45721	1
Water Outlet Gasket	1983-1984			C20238	1
Water Pump Gasket	1983-1984			K20203	1

6	1781CC (1.8L) EA82C OHC 4 Cyl, 3.622in./92mm (1985-1987)				6
----------	---	--	--	--	----------

<i>Part</i>	<i>Year</i>	<i>VIN</i>	<i>Model/Application</i>	<i>Part Number</i>	<i>Qty.</i>
ENGINE GASKETS					
Head Set	1985-1987			HS5714	1
Full Set	1985-1987			FS5714	1
Cylinder Head Gasket	1985-1987			5714	2
Valve Cover Set	1985-1987		(Contains Valve Cover Washers) Cork Rubber	VS50013	1
Valve Stem Seal, Exh.	1985-1987			B45563	4
Valve Stem Seal, Int.	1985-1987			B45563	4
Manifold Set, Exhaust	1985-1987			MS14626	1
Manifold Set, Intake	1985-1987			MS15279	1
Oil Pan Set	1985-1987		Cork Rubber	OS32032	1
Rear Main Seal	1985-1987		Rubber	66853	1
Timing Cover Set	1985-1987			JV1028	1
Timing Cover Seal	1985-1987			66852	1

Subaru

6 (cont.)	1781CC (1.8L) EA82C OHC 4 Cyl, 3.622in./92mm (1985-1987)				6 (cont.)
---------------------	---	--	--	--	---------------------

<i>Part</i>	<i>Year</i>	<i>VIN</i>	<i>Model/Application</i>	<i>Part Number</i>	<i>Qty.</i>
MISCELLANEOUS GASKETS					
Cam Carrier Set	1985-1987			JV1030	1
Camshaft Seal	1985-1987			66701	2
E.G.R. Gasket	1985-1987		Valve	G30691	1
			Inlet	G30692	1
Exhaust Pipe Gasket	1985-1987		(Ring Type 'F'), Pipe To Manifold	F7428	1
			(Flange Type), Exhaust Pipe To Muffler	F7429	1
			(Flange Type), Pre-Muffler	F20239	2
Oil Pump Mounting Gasket	1985-1987			B45702	1
Oil Pump Seal	1985-1987			67254	1
Water Outlet Gasket	1985-1987			C30647	1
Water Pump Mount Gasket	1985-1987			K30648	1

7	1781CC (1.8L) EA82S OHC 4 Cyl, 3.622in./92mm (1985-1994)				7
----------	---	--	--	--	----------

<i>Part</i>	<i>Year</i>	<i>VIN</i>	<i>Model/Application</i>	<i>Part Number</i>	<i>Qty.</i>
ENGINE GASKETS					
Head Set	1985-1994			HS5714W	1
	1987			HS5714	1
Full Set	1985-1994			FS5714W	1
	1987			FS5714	1
Cylinder Head Gasket	1985-1994			5714	2
Valve Cover Set	1985-1994		(Contains Valve Cover Washers) <i>Cork Rubber</i>	VS50013	1
Valve Stem Seal, Exh.	1985-1994			B45563	4
Valve Stem Seal, Int.	1985-1994			B45563	4
Manifold Set, Exhaust	1985-1990			MS14625	1
	1987			MS14626	1
Manifold Set, Intake	1985-1990		(Contains Plenum Chamber Gasket)	MS14624	1
	1987			MS15279	1
Oil Pan Set	1985-1994		<i>Cork Rubber</i>	OS32032	1
Rear Main Seal	1985-1994		<i>Rubber</i>	66853	1
Timing Cover Set	1985-1994			JV1028	1
Timing Cover Seal	1985-1994			66852	1

MISCELLANEOUS GASKETS					
Cam Carrier Set	1985-1994			JV1030	1
Camshaft Seal	1985-1994			66701	2
E.G.R. Gasket	1985-1990		Valve	G30691	1
			Inlet	G30692	1
Exhaust Pipe Gasket	1985-1994		(Ring Type 'F'), Pipe To Manifold	F7428	1
			(Flange Type), Exhaust Pipe To Muffler	F7429	1
			(Flange Type), Pre-Muffler	F20239	2
Oil Pump Mounting Gasket	1985-1994			B45702	1
Oil Pump Seal	1985-1994			67254	1
Throttle Body Gasket	1985-1994			G31561	1
Water Outlet Gasket	1985-1994			C30647	1
Water Pump Gasket	1985-1989			K30648	1
Water Pump Mount Gasket	1985-1994			K30648	1

8	1781CC (1.8L) EA82T OHC Turbo 4 Cyl, 3.622in./92mm (1985-1990)				8
----------	---	--	--	--	----------

<i>Part</i>	<i>Year</i>	<i>VIN</i>	<i>Model/Application</i>	<i>Part Number</i>	<i>Qty.</i>
ENGINE GASKETS					
Head Set	1985-1990		(Requires Turbocharger Mounting Set)	HS5714W	1
Full Set	1985-1990		(Requires Turbocharger Mounting Set)	FS5714W	1

8 (cont.)	1781CC (1.8L) EA82T OHC Turbo 4 Cyl, 3.622in./92mm (1985-1990)					8 (cont.)
---------------------	---	--	--	--	--	---------------------

<i>Part</i>	<i>Year</i>	<i>VIN</i>	<i>Model/Application</i>	<i>Part Number</i>	<i>Qty.</i>
ENGINE GASKETS (cont.)					
Valve Cover Set	1985-1990		(Contains Valve Cover Washers) <i>Cork Rubber</i>	VS50013	1
Valve Stem Seal, Exh.	1985-1990			B45563	4
Valve Stem Seal, Int.	1985-1990			B45563	4
Manifold Set, Exhaust	1985-1990			MS14625	1
Manifold Set, Intake	1985-1990		(Contains Plenum Chamber Gasket)	MS14624	1
Oil Pan Set	1985-1990		<i>Cork Rubber</i>	OS32032	1
Rear Main Seal	1985-1990		<i>Rubber</i>	66853	1
Timing Cover Set	1985-1990			JV1028	1
Timing Cover Seal	1985-1990			66852	1

MISCELLANEOUS GASKETS

Cam Carrier Set	1985-1990			JV1030	1
Camshaft Seal	1985-1990			66701	2
E.G.R. Gasket	1985-1990		Valve	G30691	1
			Inlet	G30692	1
Exhaust Pipe Gasket	1985-1990		(Ring Type 'F'), Pipe To Manifold	F7428	1
			(Flange Type), Exhaust Pipe To Muffler	F7429	1
			(Flange Type), Pre-Muffler	F20239	2
Oil Pump Mounting Gasket	1985-1990			B45702	1
Oil Pump Seal	1985-1990			67254	1
Throttle Body Gasket	1985-1990			G30960	1
Turbo Gasket Set	1985-1990			GS33145	1
Water Outlet Gasket	1985-1990			C30647	1
Water Pump Mount Gasket	1985-1990			K30648	1

9	1820CC (1.8L) EJ18E 4 Cyl, 3.461in./87.9mm (1993-1997)					9
----------	---	--	--	--	--	----------

<i>Part</i>	<i>Year</i>	<i>VIN</i>	<i>Model/Application</i>	<i>Part Number</i>	<i>Qty.</i>
ENGINE GASKETS					
Valve Cover Set	1993-1997		<i>Victo-Tech</i>	VS50149	1
Valve Stem Seal, Exh.	1993-1997			B45736	8
Valve Stem Seal, Int.	1993-1997			B45735	8
Manifold Set, Exhaust	1993-1997			MS12392	1
Manifold Set, Intake	1993-1997			MS12391	1
Oil Pan Set	1993-1997			OS32153	1
Rear Main Seal Set	1993-1995			JV1601	1
Timing Cover Seal	1993-1997			67209	1

MISCELLANEOUS GASKETS

Camshaft Seal Set	1993-1997			JV1128	1
E.G.R. Gasket	1993-1997			G30691	1
Water Outlet Gasket	1993-1997		<i>Victo-Tech</i>	C31197	1
Water Pump Mount Gasket	1993-1997			K31196	1

10	2212CC (2.2L) EJ22E 4 Cyl, 3.815in./96.9mm (1990-1995)					10
-----------	---	--	--	--	--	-----------

<i>Part</i>	<i>Year</i>	<i>VIN</i>	<i>Model/Application</i>	<i>Part Number</i>	<i>Qty.</i>
ENGINE GASKETS					
Full Set	1990-1995			FS5905	1
Cylinder Head Gasket	1990-1995		<i>Nitroseal</i>	5905	2
Valve Cover Set	1990-1995		(Contains Valve Cover Washers) <i>Victo-Tech</i>	VS50149	1
Valve Stem Seal, Exh.	1990-1995			B45736	8
Valve Stem Seal, Int.	1990-1995			B45735	8
Manifold Set, Exhaust	1990-1995			MS12392	1
Manifold Set, Intake	1990-1995			MS12391	1
Oil Pan Set	1990-1995			OS32153	1

Subaru

10	2212CC (2.2L) EJ22E 4 Cyl, 3.815in./96.9mm (1990-1995)	10
(cont.)		(cont.)

Part	Year	VIN	Model/Application	Part Number	Qty.
------	------	-----	-------------------	-------------	------

ENGINE GASKETS (cont.)

Rear Main Seal Set	1990-1995			JV1601	1
Timing Cover Set	1990-1995		(Valve Cover Gasket Not Included)	JV1127	1
Timing Cover Seal	1990-1995			67209	1

MISCELLANEOUS GASKETS

Camshaft Seal	1990-1995			67211	2
Camshaft Seal Set	1990-1995			JV1128	1
Throttle Body Gasket	1990-1995			G31198	1
Water Outlet Gasket	1990-1995		<i>Victo-Tech</i>	C31197	1
Water Pump Mount Gasket	1990-1995			K31196	1

11	2212CC (2.2L) EJ22T Turbo 4 Cyl, 3.815in./96.9mm (1991-1994)	11
-----------	---	-----------

Part	Year	VIN	Model/Application	Part Number	Qty.
------	------	-----	-------------------	-------------	------

ENGINE GASKETS

Valve Cover Set	1991-1994		(Contains Valve Cover Washers) <i>Victo-Tech</i>	VS50149	1
Valve Stem Seal, Exh.	1991-1994			B45736	8
Valve Stem Seal, Int.	1991-1994			B45735	8
Manifold Set, Intake	1991-1994			MS12391	1
Oil Pan Set	1991-1994			OS32153	1
Rear Main Seal Set	1991-1994			JV1601	1
Timing Cover Seal	1991-1994			67209	1

MISCELLANEOUS GASKETS

Camshaft Seal	1991-1994			67211	2
Camshaft Seal Set	1991-1994			JV1128	1
Throttle Body Gasket	1991-1994			G31198	1
Water Outlet Gasket	1991-1994		<i>Victo-Tech</i>	C31197	1
Water Pump Mount Gasket	1991-1994			K31196	1

12	2457CC (2.5L) EJ25D DOHC 4 Cyl, 3.917in./99.5mm (1996-1998)	12
-----------	--	-----------

Part	Year	VIN	Model/Application	Part Number	Qty.
------	------	-----	-------------------	-------------	------

ENGINE GASKETS

Cylinder Head Gasket	1996-1998		<i>Multi-Layered Steel</i>	54334	2
Valve Cover Set	1997-1998			VS50304	1

Suzuki

Engine Index

Engine	Year	Block
993CC (1.0L) SOHC	1991-1993	1
1298CC (1.3L) SOHC	1989-1994	2

Model Index

Model	Engine	Year	Block	Model	Engine	Year	Block
Cultus 1000	993CC (1.0L) SOHC	1987-1993	1	Swift	1298CC (1.3L) SOHC	1989-2001	2

1	993CC (1.0L) SOHC 3 Cyl, 2.913in./74mm (1991-1993)	1
----------	---	----------

Part	Year	VIN	Model/Application	Part Number	Qty.
------	------	-----	-------------------	-------------	------

ENGINE GASKETS

Engine Kit Gasket Set	1991-1993			95-3426VR	1
-----------------------	-----------	--	--	-----------	---

2 1298CC (1.3L) SOHC 4 Cyl, 2.913in./74mm (1989-1994)**2**

Part	Year	VIN	Model/Application	Part Number	Qty.
ENGINE GASKETS					
Valve Cover Set	1989-1994		(Contains Valve Cover Washers)	Cork Rubber VS50042	1

Toyota*Engine Index*

Engine	Year	Block	Engine	Year	Block
1077CC (1.1L) KC OHV	1968-1974	1	1858CC (1.9L) 8RC SOHC	1969-1971	24
1166CC (1.2L) 3KC OHV	1970-1979	2	1897CC (1.9L) 3RC OHV	1965-1970	25
1290CC (1.3L) 4KC OHV	1981-1982	3	1968CC (2.0L) 18RC SOHC	1972-1974	26
1290CC (1.3L) 4KE OHV	1983-1984	4	1995CC (2.0L) 2SELC SOHC	1983-1986	27
1452CC (1.5L) 1AC SOHC	1980	5	1998CC (2.0L) 3SFE DOHC	1987-1991	28
1452CC (1.5L) 3AC SOHC	1981-1988	6	1998CC (2.0L) 3SGELC DOHC	1986-1989	29
1456CC (1.5L) 3E SOHC 12 Valve	1987-1990	7	1998CC (2.0L) 3SGTE DOHC	1988-1994	30
1456CC (1.5L) 3EE SOHC 12 Valve	1990-1994	8	2164CC (2.2L) 5SFE DOHC	1990-2001	31
1497CC (1.5L) 5EFE DOHC	1991-1998	9	2189CC (2.2L) 20R SOHC	1975-1980	32
1587CC (1.6L) 4AC SOHC	1983-1987	10	2253CC (2.3L) 2M SOHC	1968-1972	33
1587CC (1.6L) 4AF DOHC	1988-1989	11	2366CC (2.4L) 22R SOHC	1981-1983	34
1587CC (1.6L) 4AFE DOHC	1988-1997	12	2366CC (2.4L) 22REC SOHC	1983-1985	35
1587CC (1.6L) 4AGE DOHC	1988-1991	13	2507CC (2.5L) 2VZFE DOHC	1988-1991	36
1587CC (1.6L) 4AGEC DOHC	1985-1987	14	2563CC (2.6L) 4M SOHC	1971-1979	37
1587CC (1.6L) 4AGELC DOHC	1985-1988	15	2563CC (2.6L) 4ME SOHC	1979-1980	38
1587CC (1.6L) 4ALC SOHC	1984-1988	16	2759CC (2.8L) 5ME SOHC	1981-1982	39
1588CC (1.6L) 2TC OHV	1971-1979	17	2759CC (2.8L) 5MGE DOHC	1982-1988	40
1762CC (1.8L) 7AFE DOHC	1993-1997	18	2954CC (3.0L) 7MGE DOHC	1986-1993	41
1770CC (1.8L) 3TC OHV	1980-1982	19	2954CC (3.0L) 7MGTE DOHC Turbocharged	1987-1993	42
1794CC (1.8L) 1ZZFE DOHC	1998-1999	20	2959CC (3.0L) 3VZFE DOHC	1992-1993	43
1794CC (1.8L) 1ZZFE DOHC VVTi	2000-2001	21	2995CC (3.0L) 1MZFE DOHC	1994-2003	44
1839CC (1.8L) 1CLC SOHC Diesel	1984-1985	22	2997CC (3.0L) 2JZGE DOHC	1993-1997	45
1839CC (1.8L) 1CTLC SOHC Turbo Diesel	1984-1985	23			

Model Index

Model	Engine	Year	Block	Model	Engine	Year	Block
Avalon	2995CC (3.0L) 1MZFE DOHC	1995-2004	44	Corolla	1587CC (1.6L) 4ALC SOHC	1984-1988	16
Camry	1839CC (1.8L) 1CTLC SOHC	1984-1985	23	Corolla	1587CC (1.6L) 4AC SOHC	1983-1987	10
	Turbo Diesel			Corolla	1588CC (1.6L) 2TC OHV	1971-1979	17
Camry	1995CC (2.0L) 2SELC SOHC	1983-1986	27	Corolla	1762CC (1.8L) 7AFE DOHC	1993-1997	18
Camry	1998CC (2.0L) 3SFE DOHC	1987-1991	28	Corolla	1770CC (1.8L) 3TC OHV	1980-1982	19
Camry	2164CC (2.2L) 5SFE DOHC	1992-2001	31	Corolla	1794CC (1.8L) 1ZZFE DOHC	2000-2004	21
Camry	2507CC (2.5L) 2VZFE DOHC	1988-1991	36		VVTi		
Camry	2959CC (3.0L) 3VZFE DOHC	1992-1993	43	Corolla	1794CC (1.8L) 1ZZFE DOHC	1998-1999	20
Camry	2995CC (3.0L) 1MZFE DOHC	1994-2004	44	Corolla	1839CC (1.8L) 1CLC SOHC	1984-1985	22
Carina	1588CC (1.6L) 2TC OHV	1971-1979	17		Diesel		
Celica	1587CC (1.6L) 4AFE DOHC	1990-1993	12	Corona	1858CC (1.9L) 8RC SOHC	1970-1971	24
Celica	1762CC (1.8L) 7AFE DOHC	1994-1997	18	Corona	1897CC (1.9L) 3RC OHV	1965-1970	25
Celica	1794CC (1.8L) 1ZZFE DOHC	2000-2004	21	Corona	1968CC (2.0L) 18RC SOHC	1972-1973	26
	VVTi			Corona	2189CC (2.2L) 20R SOHC	1975-1980	32
Celica	1858CC (1.9L) 8RC SOHC	1969-1971	24	Corona	2366CC (2.4L) 22R SOHC	1981-1982	34
Celica	1968CC (2.0L) 18RC SOHC	1972-1974	26	Corona Mk II	1858CC (1.9L) 8RC SOHC	1969-1971	24
Celica	1995CC (2.0L) 2SELC SOHC	1986	27	Corona Mk II	1968CC (2.0L) 18RC SOHC	1972	26
Celica	1998CC (2.0L) 3SGTE DOHC	1988-1993	30	Corona Mk II	2253CC (2.3L) 2M SOHC	1972	33
Celica	1998CC (2.0L) 3SFE DOHC	1987-1989	28	Corona Mk II	2563CC (2.6L) 4M SOHC	1973-1976	37
Celica	1998CC (2.0L) 3SGELC DOHC	1986-1989	29	Cressida	2563CC (2.6L) 4ME SOHC	1980	38
	DOHC			Cressida	2563CC (2.6L) 4M SOHC	1978-1979	37
Celica	2164CC (2.2L) 5SFE DOHC	1990-1999	31	Cressida	2759CC (2.8L) 5MGE DOHC	1983-1988	40
Celica	2189CC (2.2L) 20R SOHC	1975-1980	32	Cressida	2759CC (2.8L) 5ME SOHC	1981-1982	39
Celica	2366CC (2.4L) 22REC SOHC	1983-1985	35	Cressida	2954CC (3.0L) 7MGE DOHC	1989-1992	41
Celica	2366CC (2.4L) 22R SOHC	1981-1983	34	Crown	2253CC (2.3L) 2M SOHC	1968-1971	33
Celica Supra	2563CC (2.6L) 4ME SOHC	1979-1980	38	Crown	2563CC (2.6L) 4M SOHC	1971-1974	37
Celica Supra	2759CC (2.8L) 5MGE DOHC	1982-1986	40	MR2	1587CC (1.6L) 4AGELC DOHC	1985-1989	15
Celica Supra	2759CC (2.8L) 5ME SOHC	1981	39				
Corolla	1077CC (1.1L) KC OHV	1968-1974	1	MR2	1998CC (2.0L) 3SGTE DOHC	1990-1994	30
Corolla	1166CC (1.2L) 3KC OHV	1970-1979	2	MR2	2164CC (2.2L) 5SFE DOHC	1990-1995	31
Corolla	1587CC (1.6L) 4AFE DOHC	1988-1997	12	MR2 Spyder	1794CC (1.8L) 1ZZFE DOHC	2000-2004	21
Corolla	1587CC (1.6L) 4AGE DOHC	1988-1991	13		VVTi		
Corolla	1587CC (1.6L) 4AF DOHC	1988-1989	11	Paseo	1497CC (1.5L) 5EFE DOHC	1991-1998	9
Corolla	1587CC (1.6L) 4AGELC DOHC	1987-1988	15	Solara	2164CC (2.2L) 5SFE DOHC	1999-2001	31
	DOHC			Solara	2995CC (3.0L) 1MZFE DOHC	1999-2003	44
Corolla	1587CC (1.6L) 4AGEC DOHC	1985-1987	14	Starlet	1290CC (1.3L) 4KE OHV	1983-1984	4

Toyota

Model Index (cont.)

Model	Engine	Year	Block	Model	Engine	Year	Block
Starlet	1290CC (1.3L) 4KC OHV	1980-1982	3	Tercel	1452CC (1.5L) 1AC SOHC	1980	5
Supra	2954CC (3.0L) 7MGTE DOHC Turbocharged	1987-1993	42	Tercel	1456CC (1.5L) 3EE SOHC 12 Valve	1990-1994	8
Supra	2954CC (3.0L) 7MGE DOHC	1986-1993	41	Tercel	1456CC (1.5L) 3E SOHC 12 Valve	1987-1990	7
Supra	2997CC (3.0L) 2JZGE DOHC	1993-1998	45				
Tercel	1452CC (1.5L) 3AC SOHC	1981-1988	6	Tercel	1497CC (1.5L) 5EFE DOHC	1995-1999	9

1 1077CC (1.1L) KC OHV 4 Cyl, 2.953in./75mm (1968-1974) 1

Part	Year	VIN	Model/Application	Part Number	Qty.
------	------	-----	-------------------	-------------	------

ENGINE GASKETS

Head Set	1968-1974			HS3583	1
Full Set	1968-1974			FS3583	1
Cylinder Head Gasket	1968-1974		Nitroseal	3583	1
Valve Cover Set	1968-1974		(Contains Valve Cover Washers, Spark Plug Tube Seals Not Included) Victo-Tech	VS30006	1
Valve Stem Seal, Exh.	1968-1974		(O-Ring Type)	B20212	4
Valve Stem Seal, Int.	1968-1974		(O-Ring Type)	B20212	4
Manifold Set, Int. & Exh.	1968-1974			MS12277	1
Oil Pan Set	1968-1974			OS30043	1
Rear Main Seal Set	1968-1974			JV633	1
Timing Cover Set	1968-1974		(Requires Oil Pan Set)	JV909	1

MISCELLANEOUS GASKETS

Exhaust Pipe Gasket	1968-1974		(Ring Type 'A'), Pipe To Manifold	F14595	1
Fuel Pump Gasket	1968-1974			D20249	1
Spark Plug Tube Seal	1968-1974			B45479	4
Therm. Housing Gasket	1968-1974			C20244	1
Water Outlet Gasket	1968-1974			C20245	1
Water Pump Mount Gasket	1968-1974			K20246	1

2 1166CC (1.2L) 3KC OHV 4 Cyl, 2.953in./75mm (1970-1979) 2

Part	Year	VIN	Model/Application	Part Number	Qty.
------	------	-----	-------------------	-------------	------

ENGINE GASKETS

Head Set	1978-1979			HS3645	1
	1977		Thru 4/77	HS3583X	1
			From 5/77	HS3645	1
	1975-1976			HS3583X	1
	1974		Thru 3/74	HS3583	1
			From 4/74	HS3583X	1
1970-1973			HS3583	1	
Full Set	1979			FS3645X	1
	1978		Thru 1/78	FS3645	1
			From 2/78	FS3645X	1
	1977		Thru 4/77	FS3583X	1
			From 5/77	FS3645	1
	1975-1976			FS3583X	1
	1974		Thru 3/74	FS3583	1
		From 4/74	FS3583X	1	
1970-1973			FS3583	1	
Cylinder Head Gasket	1978-1979		Nitroseal	3645	1
	1977		Thru 4/77	Nitroseal 3583	1
			From 5/77	Nitroseal 3645	1
	1970-1976		Nitroseal	3583	1
Valve Cover Set	1979		Thru 8/79, (Contains Valve Cover Washers, Spark Plug Tube Seals Not Included) Victo-Tech	VS30006	1
	1971-1978		(Contains Valve Cover Washers, Spark Plug Tube Seals Not Included) Victo-Tech	VS30006	1
Valve Stem Seal, Exh.	1971-1979		(O-Ring Type)	B20219	4

2 1166CC (1.2L) 3KC OHV 4 Cyl, 2.953in./75mm (1970-1979) **2**
(cont.) (cont.)

Part Year VIN Model/Application Part Number Qty.

ENGINE GASKETS (cont.)

Valve Stem Seal, Int.	1971-1979		(O-Ring Type)	B20219	4	
Manifold Set, Int. & Exh.	1978-1979		Intake To Manifold	MS15301	1	
			(Contains Plenum Chamber Gasket)	MS15302	1	
	1977		Thru 4/77	MS12277	1	
			From 5/77, Intake To Manifold	MS15301	1	
			From 5/77, (Contains Plenum Chamber Gasket)	MS15302	1	
1970-1976			MS12277	1		
Oil Pan Set	1979		<i>Victo-Tech</i>	OS30576	1	
	1978		Thru 1/78	<i>Victo-Tech</i>	OS30149	1
			From 2/78	<i>Victo-Tech</i>	OS30576	1
	1975-1977		<i>Victo-Tech</i>	OS30149	1	
	1974		Thru 3/74		OS30043	1
			From 4/74	<i>Victo-Tech</i>	OS30149	1
1970-1973			OS30043	1		
Rear Main Seal Set	1970-1979			JV633	1	
Timing Cover Set	1978-1979		(Requires Oil Pan Set)	JV910	1	
	1977		Thru 4/77, (Requires Oil Pan Set)	JV909	1	
			From 5/77, (Requires Oil Pan Set)	JV910	1	
	1970-1976		(Requires Oil Pan Set)	JV909	1	

MISCELLANEOUS GASKETS

Exhaust Pipe Gasket	1977-1979		(Ring Type 'A'), Catalytic Converter To Exhaust Pipe, Rear	F14592	1
			(Ring Type 'A'), Catalytic Converter To Exhaust Pipe, Front	F20252	1
	1975-1979		(Flange Type), Pipe To Manifold	F14623	1
	1974		Thru 3/74, (Ring Type 'A'), Pipe To Manifold	F14595	1
			Thru 3/74, (Ring Type 'A'), Center Pipe To Muffler	F14596	1
	1970-1973		From 4/74, (Flange Type), Pipe To Manifold	F14623	1
		(Ring Type 'A'), Pipe To Manifold	F14595	1	
		(Ring Type 'A'), Center Pipe To Muffler	F14596	1	
Fuel Pump Gasket	1970-1979			D20249	1
Spark Plug Tube Seal	1970-1979			B45479	4
Therm. Housing Gasket	1970-1979			C20244	1
Water Outlet Gasket	1970-1979			C20245	1
Water Pump Mount Gasket	1970-1979			K20246	1

3 1290CC (1.3L) 4KC OHV 4 Cyl, 2.953in./75mm (1981-1982) **3**

Part Year VIN Model/Application Part Number Qty.

ENGINE GASKETS

Head Set	1981-1982			HS3645	1
Full Set	1981-1982			FS3645W	1
Cylinder Head Gasket	1981-1982		<i>Nitroseal</i>	3645	1
Valve Cover Set	1981-1982		(Contains Valve Cover Washers, Spark Plug Tube Seals Not Included) <i>Victo-Tech</i>	VS30006	1
Valve Stem Seal, Exh.	1981-1982			B20219	4
Valve Stem Seal, Int.	1981-1982			B20219	4
Manifold Set, Int. & Exh.	1981-1982		Intake To Exhaust	MS15301	1
			(Contains Plenum Chamber Gasket)	MS15302	1
Oil Pan Set	1981-1982			OS30365	1
Rear Main Seal Set	1981-1982			JV633	1
Timing Cover Set	1981-1982			JV910	1

MISCELLANEOUS GASKETS

E.G.R. Gasket	1981-1982			G26353	1
Exhaust Pipe Gasket	1981-1982		(Ring Type 'A'), Catalytic Converter To Exhaust Pipe	F7458	1

PASSENGER CAR

Toyota

3 (cont.)	1290CC (1.3L) 4KC OHV 4 Cyl, 2.953in./75mm (1981-1982)				3 (cont.)
---------------------	---	--	--	--	---------------------

Part	Year	VIN	Model/Application	Part Number	Qty.
------	------	-----	-------------------	-------------	------

MISCELLANEOUS GASKETS (cont.)

Exhaust Pipe Gasket (cont.)	1981-1982		(Ring Type 'A'), Pipe To Manifold	F14595	2
Fuel Pump Gasket	1981-1982			D20249	2
Spark Plug Tube Seal	1981-1982			B45479	4
Therm. Housing Gasket	1981-1982			C20244	1
Water Outlet Gasket	1981-1982			C20245	1
Water Pump Mount Gasket	1981-1982			K20246	1

4	1290CC (1.3L) 4KE OHV 4 Cyl, 2.953in./75mm (1983-1984)				4
----------	---	--	--	--	----------

Part	Year	VIN	Model/Application	Part Number	Qty.
------	------	-----	-------------------	-------------	------

ENGINE GASKETS

Head Set	1983-1984			HS3645Y	1
Full Set	1984			FS3645Z	1
	1983			FS3645Y	1
Cylinder Head Gasket	1983-1984		<i>Nitroseal</i>	3645	1
Valve Cover Set	1983-1984		(Contains Valve Cover Washers, Spark Plug Tube Seals Not Included) <i>Victo-Tech</i>	VS30006	1
Valve Stem Seal, Exh.	1983-1984			B20219	4
Valve Stem Seal, Int.	1983-1984			B20219	4
Plenum Chamber Gasket	1983-1984			MS12361	1
Manifold Set, Int. & Exh.	1983-1984		Intake To Exhaust	MS15301	1
			(Contains Plenum Chamber Gasket)	MS15302	1
Oil Pan Set	1984		<i>Victo-Tech</i>	OS30372	1
	1983			OS30365	1
Rear Main Seal Set	1983-1984			JV1606	1
Timing Cover Set	1983-1984			JV910	1

MISCELLANEOUS GASKETS

E.G.R. Gasket	1983-1984			G26353	1
Exhaust Pipe Gasket	1983-1984		(Ring Type 'A'), Catalytic Converter To Exhaust Pipe	F7458	1
			(Ring Type 'A'), Pipe To Manifold	F14592	1
Fuel Inj. O-Ring	1983-1984			B45744	4
Fuel Pump Gasket	1983-1984			D20249	2
Spark Plug Tube Seal	1983-1984			B45479	4
Therm. Housing Gasket	1983-1984			C20244	1
Throttle Body Gasket	1983-1984			G30701	1
Water Outlet Gasket	1983-1984			C20245	1
Water Pump Mount Gasket	1983-1984			K20246	1

5	1452CC (1.5L) 1AC SOHC 4 Cyl, 3.051in./77.5mm (1980)				5
----------	---	--	--	--	----------

Part	Year	VIN	Model/Application	Part Number	Qty.
------	------	-----	-------------------	-------------	------

ENGINE GASKETS

Head Set	1980			HS3694	1
Full Set	1980			FS3694	1
Cylinder Head Gasket	1980		<i>Nitroseal</i>	3694	1
Cyl. Head Spacer Shim	1980		Requires Sealing Compound <i>Steel</i>	3694S	1
Sealing Compound	1980		(4 Ounce Brush Top Can)	JV66B	1
			(12 Ounce Spray Can)	JV66S	1
Valve Cover Set	1980		(Contains Valve Cover Washers, Contains Valve Cover End Plug) <i>Victo-Tech</i>	VS20348	1
Valve Stem Seal, Exh.	1980			B45476	4

5 1452CC (1.5L) 1AC SOHC 4 Cyl, 3.051in./77.5mm (1980) **5**
(cont.) (cont.)

Part	Year	VIN	Model/Application	Part Number	Qty.
ENGINE GASKETS (cont.)					
Valve Stem Seal, Int.	1980			B45476	4
Manifold Set, Int. & Exh.	1980			MS15318	1
Oil Pan Set	1980		Cork Rubber	OS30349	1
Rear Main Seal Set	1980		To Be Replaced By JV532	JV505	1
				JV532	1
Timing Cover Set	1980			JV955	1

MISCELLANEOUS GASKETS					
Camshaft Seal	1980			66807	1
E.G.R. Gasket	1980			G26262	1
Exhaust Pipe Gasket	1980		(Ring Type 'A'), Pipe To Manifold	F14592	1
Oil Pump Inlet Tube	1980			B45713	1
Oil Pump Mounting Gasket	1980			H45696	1
Valve Cover End Plug	1980		(Half Round)	B45470	1
Water Outlet Gasket	1980			C20350	1
			Water Outlet To Block	C24213	1
Water Pump Mount Gasket	1980		(O-Ring Type)	B45550	2
				K27440	1

6 1452CC (1.5L) 3AC SOHC 4 Cyl, 3.051in./77.5mm (1981-1988) **6**

Part	Year	VIN	Model/Application	Part Number	Qty.
ENGINE GASKETS					
Head Set	1983-1988			HS3755	1
	1981-1982			HS3694	1
Lower Set	1983-1988			CS3756	1
Full Set	1983-1988		(Oil Pan Gasket Not Included)	FS3755	1
	1981-1982			FS3694	1
Engine Kit Gasket Set	1983-1988			95-3125VR	1
	1982		From 6/82	95-3125VR	1
Cylinder Head Gasket	1983-1988		Nitroseal	3755	1
	1981-1982		Nitroseal	3694	1
Cyl. Head Spacer Shim	1983-1988		Requires Sealing Compound Steel	3755S	1
	1981-1982		Requires Sealing Compound Steel	3694S	1
Sealing Compound	1981-1988		(4 Ounce Brush Top Can)	JV66B	1
			(12 Ounce Spray Can)	JV66S	1
Valve Cover Set	1981-1988		(Contains Valve Cover Washers, Contains Valve Cover End Plug) Victo-Tech	VS20348	1
Valve Stem Seal, Exh.	1981-1988			B45476	4
Valve Stem Seal, Int.	1981-1988			B45476	4
Manifold Set, Int. & Exh.	1981-1988			MS15318	1
Oil Pan Set	1981-1988		Cork Rubber	OS30349	1
Rear Main Seal Set	1983-1988			JV532	1
	1981-1982		To Be Replaced By JV532	JV505	1
Timing Cover Set	1983-1988			JV992	1
	1981-1982			JV955	1

MISCELLANEOUS GASKETS					
Camshaft Seal	1981-1988			66807	1
Carb. Mount Gasket	1983-1988		2 Barrel Carburetor	G31031	2
E.G.R. Gasket	1987-1988			G26262	1
	1981-1986			G20262	1
Exhaust Pipe Gasket	1984-1988		Except California, (Ring Type 'A'), Catalytic Converter To Exhaust Pipe, Rear	F20252	1

Toyota

6 (cont.)	1452CC (1.5L) 3AC SOHC 4 Cyl, 3.051in./77.5mm (1981-1988)				6 (cont.)
---------------------	--	--	--	--	---------------------

Part	Year	VIN	Model/Application	Part Number	Qty.
------	------	-----	-------------------	-------------	------

MISCELLANEOUS GASKETS (cont.)

Exhaust Pipe Gasket (cont.)	1983-1988		(Ring Type 'A'), Catalytic Converter To Exhaust Pipe, Front	F7458	1
	1981-1988		(Ring Type 'A'), Pipe To Manifold	F14592	1
	1983		California, (Ring Type 'A'), Catalytic Converter To Exhaust Pipe, Rear	F7461	1
Oil Pump Inlet Tube	1981-1988			B45713	1
Oil Pump Mounting Gasket	1981-1988			H45696	1
Valve Cover End Plug	1981-1987		(Half Round)	B45470	1
Water Outlet Gasket	1981-1988			C20350	1
			Water Outlet To Block	C24213	1
Water Pump Mount Gasket	1981-1988		(O-Ring Type)	B45550	2
				K27440	1

7	1456CC (1.5L) 3E SOHC 12 Valve 4 Cyl, 2.874in./73mm (1987-1990)				7
----------	--	--	--	--	----------

Part	Year	VIN	Model/Application	Part Number	Qty.
------	------	-----	-------------------	-------------	------

ENGINE GASKETS

Head Set	1987-1990			HS5787	1
Lower Set	1987-1990			CS5787A	1
Engine Kit Gasket Set	1987-1990			95-3268VR	1
Cylinder Head Gasket	1987-1990		Nitroseal	5787	1
Valve Cover Set	1987-1990		(Contains Valve Cover Washers) Victo-Tech	VS50058	1
Valve Stem Seal, Exh.	1987-1990			B45792	4
Valve Stem Seal, Int.	1987-1990			B45791	8
Manifold Set, Exhaust	1987-1990			MS10074	1
Manifold Set, Intake	1990			MS16137	1
Oil Pan Set	1987-1990		Cork Rubber	OS32087	1
Rear Main Seal Set	1987-1990			JV597	1
Timing Cover Set	1987-1990		(Requires RTV)	JV1185	1

MISCELLANEOUS GASKETS

Camshaft Seal	1987-1990			66807	1
Carb. Mount Gasket	1987-1990		1 Barrel Carburetor, Upper	G31003	1
			1 Barrel Carburetor, Lower	G31004	1
Dist. Mounting Gasket	1987-1990		(O-Ring Type)	B45860	1
E.G.R. Gasket	1987-1990		Valve	G31005	1
			Inlet	G31520	1
Exhaust Pipe Gasket	1987-1990		(Ring Type 'A'), Exhaust Pipe To Muffler	F7273	1
			(Ring Type 'A'), Pipe To Manifold	F7458	1
			(Ring Type 'A'), Catalytic Converter To Exhaust Pipe	F14592	1
Fuel Pump Gasket	1987-1990			D30983	2
Water Outlet Gasket	1987-1990		(O-Ring Type) Victo-Tech	C24184	1
			(O-Ring Type), Inlet	C31514	1
Water Pump Mount Gasket	1989-1990			K31006	1

8	1456CC (1.5L) 3EE SOHC 12 Valve 4 Cyl, 2.874in./73mm (1990-1994)				8
----------	---	--	--	--	----------

Part	Year	VIN	Model/Application	Part Number	Qty.
------	------	-----	-------------------	-------------	------

ENGINE GASKETS

Head Set	1990-1994			HS5787Y	1
Lower Set	1990-1994		(Oil Pan Gasket Not Included, Requires Head Set To Make Full Set), To Be Replaced By CS5787A	CS5787	1
Engine Kit Gasket Set	1990-1994			95-3268VR	1
Cylinder Head Gasket	1990-1994		Nitroseal	5787	1
Cyl. Head Bolt Set	1990-1994			GS33319	1
Valve Cover Set	1990-1994		(Contains Valve Cover Washers) Victo-Tech	VS50058	1

8 1456CC (1.5L) 3EE SOHC 12 Valve 4 Cyl, 2.874in./73mm (1990-1994) **8**
(cont.) (cont.)

Part Year VIN Model/Application Part Number Qty.

ENGINE GASKETS (cont.)

Valve Stem Seal, Exh.	1991-1994			B45792	4
	1990		From 3/90	B45792	4
Valve Stem Seal, Int.	1991-1994			B45791	8
	1990		From 3/90	B45791	8
Manifold Set, Exhaust	1990-1994			MS10074	1
Manifold Set, Intake	1990-1994			MS16137	1
Oil Pan Set	1990-1994		Cork Rubber	OS32087	1
Rear Main Seal Set	1990-1994			JV597	1
Timing Cover Set	1991-1994			JV1204	1
	1990			JV1185	1

MISCELLANEOUS GASKETS

Camshaft Seal	1990-1994			66807	1
Dist. Mounting Gasket	1990-1994		(O-Ring Type)	B45859	1
E.G.R. Gasket	1990-1994		Inlet	G31518	1
Exhaust Pipe Gasket	1990-1994		(Ring Type 'A'), Exhaust Pipe To Muffler	F7273	1
			2 Required, (Ring Type 'A'), Catalytic Converter To Exhaust Pipe, Pipe To Manifold	F7458	2
Fuel Inj. O-Ring	1990-1994		(O-Ring Type)	B45744	2
Fuel Injection Seal	1990		(Grommet), Injector To Fuel Rail	B45854	1
Throttle Body Gasket	1990-1994			G31515	1
Turbo Mounting Set	1990-1994			GS33293	1
Water Outlet Gasket	1991-1994		(O-Ring Type) Victo-Tech	C24184	1
	1990-1994		(O-Ring Type), Inlet	C31514	1
Water Pump Mount Gasket	1990-1994			K31006	1

9 1497CC (1.5L) 5EFE DOHC 4 Cyl, 2.913in./74mm (1991-1998) **9**

Part Year VIN Model/Application Part Number Qty.

ENGINE GASKETS

Cylinder Head Gasket	1991-1998		Multi-Layered Steel	54347	1
Valve Cover Set	1995-1998		(Contains Spark Plug Tube Seals) Victo-Tech	VS50241	1
	1991-1994		(Contains Spark Plug Tube Seals) Victo-Tech	VS50240	1
Valve Stem Seal, Exh.	1991-1996			B45549	8
Valve Stem Seal, Int.	1991-1996			B45549	8
Oil Pan Set	1991-1996		Cork Rubber	OS32087	1
Rear Main Seal Set	1991-1996			JV543	1
Timing Cover Set	1991-1996			JV1185	1

MISCELLANEOUS GASKETS

Camshaft Seal	1991-1996			66807	2
Exhaust Pipe Gasket	1995		Paseo, Except California, (Ring Type 'A'), Pipe To Manifold	F14592	1
	1991-1994		(Ring Type 'A'), Pipe To Manifold	F14592	1
Fuel Inj. O-Ring	1991-1996			B45744	4
Spark Plug Tube Seal	1991-1996			B45778	8
Throttle Body Gasket	1991-1995			G30961	1
Water Outlet Gasket	1991-1996		(O-Ring Type) Victo-Tech	C24184	1
Water Pump Mount Gasket	1991-1996			K31006	1

10 1587CC (1.6L) 4AC SOHC 4 Cyl, 3.189in./81mm (1983-1987) **10**

Part Year VIN Model/Application Part Number Qty.

ENGINE GASKETS

Head Set	1986-1987			HS3756X	1
	1983-1985			HS3756	1
Lower Set	1983-1987			CS3756	1

PASSENGER CAR

Toyota

10 (cont.)	1587CC (1.6L) 4AC SOHC 4 Cyl, 3.189in./81mm (1983-1987)				10 (cont.)
----------------------	--	--	--	--	----------------------

Part	Year	VIN	Model/Application	Part Number	Qty.
------	------	-----	-------------------	-------------	------

ENGINE GASKETS (cont.)

Engine Kit Gasket Set	1986-1987		(Valve Cover Gasket Not Included), Use With Part Number VS50047	95-3429VR	1
	1983-1985		(Valve Cover Gasket Not Included), Use With Part Number VS20348	95-3429VR	1
Cylinder Head Gasket	1983-1987		<i>Nitroseal</i>	3756	1
Cyl. Head Spacer Shim	1983-1987		Requires Sealing Compound <i>Steel</i>	3756S	1
Sealing Compound	1983-1987		(4 Ounce Brush Top Can)	JV66B	1
			(12 Ounce Spray Can)	JV66S	1
Valve Cover Set	1986-1987		(Contains Valve Cover Washers, Contains Valve Cover End Plug) <i>Victo-Tech</i>	VS50047	1
	1983-1985		(Contains Valve Cover Washers, Contains Valve Cover End Plug) <i>Victo-Tech</i>	VS20348	1
Valve Stem Seal, Exh.	1983-1987			B45476	4
Valve Stem Seal, Int.	1983-1987			B45476	4
Manifold Set, Int. & Exh.	1983-1987			MS15318	1
Oil Pan Set	1983-1987		<i>Cork Rubber</i>	OS30349	1
Rear Main Seal Set	1983-1987			JV532	1
Timing Cover Set	1983-1987		(Camshaft Seal Not Included)	JV992	1

MISCELLANEOUS GASKETS

Camshaft Seal	1984-1987			66807	2
Carb. Mount Gasket	1983-1987		2 Barrel Carburetor	G31031	2
E.G.R. Gasket	1983-1987			G20262	1
Exhaust Pipe Gasket	1983-1987		(Ring Type 'A'), Pipe To Manifold	F14592	1
			(Ring Type 'A'), Catalytic Converter To Exhaust Pipe	F20252	2
Fuel Pump Gasket	1983-1987			D30983	2
Oil Pump Inlet Tube	1983-1987			B45713	1
Oil Pump Mounting Gasket	1983-1987			H45696	1
Valve Cover End Plug	1983-1987		(Half Round)	B45470	1
Water Outlet Gasket	1983-1987			C20350	1
			Water Outlet To Block	C24213	1
Water Pump Mount Gasket	1983-1987		(O-Ring Type)	B45550	2
				K27440	1

11	1587CC (1.6L) 4AF DOHC 4 Cyl, 3.189in./81mm (1988-1989)				11
-----------	--	--	--	--	-----------

Part	Year	VIN	Model/Application	Part Number	Qty.
------	------	-----	-------------------	-------------	------

ENGINE GASKETS

Head Set	1988-1989			HS4899	1
Full Set	1988-1989		(Oil Pan Gasket Not Included)	FS4899	1
Engine Kit Gasket Set	1988-1989			95-3271VR	1
Cylinder Head Gasket	1988-1989		<i>Nitroseal</i>	4899	1
Valve Cover Set	1988-1989		(Contains Valve Cover Grommets, Contains Spark Plug Tube Seals) <i>Victo-Tech</i>	VS50098	1
Valve Stem Seal, Exh.	1988-1989			B45549	8
Valve Stem Seal, Int.	1988-1989			B45556	8
Manifold Set, Exhaust	1988-1989			MS15560	1
Manifold Set, Intake	1988-1989			MS15559	1
Oil Pan Set	1988-1989			OS32088	1
Rear Main Seal Set	1988-1989			JV532	1
Timing Cover Set	1988-1989		(Camshaft Seals Not Included)	JV992	1

MISCELLANEOUS GASKETS

Camshaft Seal	1988-1989			66807	2
Carb. Mount Gasket	1988-1989		2 Barrel Carburetor, Upper	G31080	1
			2 Barrel Carburetor, Lower	G31081	1

11 1587CC (1.6L) 4AF DOHC 4 Cyl, 3.189in./81mm (1988-1989) **11**
(cont.) (cont.)

Part	Year	VIN	Model/Application	Part Number	Qty.
MISCELLANEOUS GASKETS (cont.)					
E.G.R. Gasket	1988-1989			G31083	1
Exhaust Pipe Gasket	1988-1989		1 Required, (Ring Type 'A'), Catalytic Converter To Exhaust Pipe, Pipe To Manifold	F20252	2
Fuel Inj. O-Ring	1988-1989			B45744	4
Oil Pump Inlet Tube	1988-1989			B45713	1
Oil Pump Mounting Gasket	1988-1989			H45696	1
Water Outlet Gasket	1988-1989		(O-Ring Type) <i>Victo-Tech</i>	C24184	1
Water Pump Mount Gasket	1988-1989			K27440	1

12 1587CC (1.6L) 4AFE DOHC 4 Cyl, 3.189in./81mm (1988-1997) **12**

Part	Year	VIN	Model/Application	Part Number	Qty.
ENGINE GASKETS					
Head Set	1990-1993		Celica, (Head Bolts Not Included)	HS4899W	1
			Celica, (Contains Head Bolts)	HS4899WB	1
	1990-1992		(Head Bolts Not Included)	HS4899W	1
			(Contains Head Bolts)	HS4899WB	1
Full Set	1988-1992		(Oil Pan Gasket Not Included)	FS4899W	1
Engine Kit Gasket Set	1988-1993		Celica	95-3271VR	1
	1988-1992			95-3271VR	1
Cylinder Head Gasket	1990-1993		Celica <i>Nitroseal</i>	4899	1
	1988-1992		<i>Nitroseal</i>	4899	1
Cyl. Head Bolt Set	1988-1997			GS33240	1
Valve Cover Set	1993-1997		(Contains Spark Plug Tube Seals And Washers) <i>Victo-Tech</i>	VS50228	1
	1988-1992		(Contains Valve Cover Grommets, Contains Spark Plug Tube Seals) <i>Victo-Tech</i>	VS50098	1
Valve Stem Seal, Exh.	1997			B45791	8
	1991-1995			B45791	8
	1988-1990			B45549	8
Valve Stem Seal, Int.	1997			B45549	8
	1991-1995			B45549	8
	1988-1990			B45556	8
Manifold Set, Exhaust	1988-1997			MS15560	1
Manifold Set, Intake	1990-1997		California	MS15559	1
			Except California	MS15561	1
Oil Pan Set	1988-1997			OS32088	1
Rear Main Seal Set	1988-1997			JV532	1
Timing Cover Set	1988-1997		(Camshaft Seals Not Included)	JV992	1

MISCELLANEOUS GASKETS					
Camshaft Seal	1988-1997		Front	66807	2
Dist. Mounting Gasket	1992-1994			B45859	1
	1991		From 3/91	B45859	1
			Thru 3/91	B45860	1
	1988-1990			B45860	1
E.G.R. Gasket	1993-1996		Corolla	G26262	1
	1990-1993		Celica	G31083	1
	1990-1992		Corolla	G31083	1
	1988-1989		Exhaust Gas Recirculation Tube	G26246	1
Exhaust Pipe Gasket	1997		California Emission, (Ring Type 'A'), Catalytic Converter To Front Exhaust Pipe	F7461	1
			(Ring Type 'A'), Pipe To Manifold	F7572	1
			California Emission, Federal Emission, (Ring Type 'A'), Catalytic Converter To Center Pipe, Catalytic Converter To Front Exhaust Pipe	F20252	2

PASSENGER CAR

MISCELLANEOUS GASKETS (cont.)

Exhaust Pipe Gasket (cont.)	1996-1997		Corolla, California Emission, (Ring Type 'A'), Catalytic Converter To Exhaust Pipe, Catalytic Converter To Front Exhaust Pipe, Front	F7461	1
	1993-1997		Corolla, (Ring Type 'A'), Manifold To Exhaust Pipe, Pipe To Manifold	F7572	1
			(Ring Type 'A'), Exhaust Pipe To Muffler	F7573	1
			California Emission, (Ring Type 'A'), Catalytic Converter To Center Pipe	F20252	1
			Federal Emission, (Ring Type 'A'), Catalytic Converter To Center Pipe, Catalytic Converter To Front Exhaust Pipe	F20252	2
	1988-1996		Corolla, (Ring Type 'A'), Catalytic Converter To Exhaust Pipe, Rear	F20252	1
	1993-1995		Corolla, California Emission, (Ring Type 'A'), Catalytic Converter To Exhaust Pipe, Catalytic Converter To Front Exhaust Pipe, Front	F7458	1
			Corolla, (Ring Type 'A'), Manifold To Exhaust Pipe	F7572	1
			Corolla, (Ring Type 'A'), Exhaust Pipe To Muffler	F7573	1
	1990-1993		Celica, (Ring Type 'A'), Catalytic Converter To Exhaust Pipe, Rear	F7458	1
			Celica, 1 Required, California, (Ring Type 'A'), Exhaust Pipe To Muffler	F7458	1
			Celica, California, (Ring Type 'A'), Exhaust Pipe To Muffler	F7458	1
			California Emission, (Ring Type 'A'), Exhaust Pipe To Muffler	F7458	1
			Celica, (Ring Type 'A'), Catalytic Converter To Exhaust Pipe, Front	F7461	1
			Celica, 1 Required, Except California, (Ring Type 'A'), Exhaust Pipe To Muffler	F14592	1
			Celica, California, (Ring Type 'A'), Manifold To Exhaust Pipe	F14592	2
			California Emission, (Ring Type 'A'), Pipe To Manifold	F14592	1
			Celica, Except California, (Ring Type 'A'), Exhaust Pipe To Muffler	F14592	1
			Celica, Except California, (Ring Type 'A'), Manifold To Exhaust Pipe	F14596	2
	1991-1992		Corolla, (Ring Type 'A'), Catalytic Converter To Exhaust Pipe, Front	F20252	1
1988-1992		Corolla, (Ring Type 'A'), Manifold To Exhaust Pipe	F20252	1	
1988-1990		Corolla, (Ring Type 'A'), Catalytic Converter To Exhaust Pipe, Exhaust Pipe To Muffler, Front	F14592	1	
1988-1989		Corolla, (Ring Type 'A'), Catalytic Converter To Exhaust Pipe, Center	F7461	1	
Fuel Inj. O-Ring	1988-1997			B45744	4
Fuel Injection Seal	1988-1997		(Grommet), Injector To Fuel Rail	B45854	4
Fuel Reg. O-Ring	1988-1997			B45744	1
Oil Pump Inlet Tube	1988-1997			B45713	1
Oil Pump Mounting Gasket	1988-1992			H45696	1
Spark Plug Tube Seal	1988-1997			B45778	4
Throttle Body Gasket	1997			G31382	1
	1993-1995		Corolla	G31382	1
	1990-1993		Celica	G31082	1
	1990-1992		Corolla	G31084	1
	1988-1989		Corolla	G31082	1
Water Outlet Gasket	1988-1997		<i>Victo-Tech</i>	C24184	1
Water Pump Gasket	1997		(O-Ring Type)	B45610	1
	1995		Thru 5/95	K27440	1
	1988-1994			K27440	1
Water Pump Mount Gasket	1988-1996		(O-Ring Type)	B45610	1
				K27440	1

13 1587CC (1.6L) 4AGE DOHC 4 Cyl, 3.189in./81mm (1988-1991) 13

Part	Year	VIN	Model/Application	Part Number	Qty.
ENGINE GASKETS					
Head Set	1990-1991		(Head Bolts Not Included)	HS5797W	1
			(Contains Head Bolts)	HS5797WB1	1
	1988-1989		(Head Bolts Not Included)	HS5797	1
			(Contains Head Bolts)	HS5797WB	1
Full Set	1990-1991		(Oil Pan Gasket Not Included)	FS5797W	1
	1988-1989		(Oil Pan Gasket Not Included)	FS5797	1
Cylinder Head Gasket	1988-1991		Nitroseal	5797	1
Cyl. Head Bolt Set	1988-1991			GS33240	1
Cyl. Head Spacer Shim	1988-1991		Requires Sealing Compound Steel	5797S	1
Sealing Compound	1988-1991		(4 Ounce Brush Top Can)	JV66B	1
			(12 Ounce Spray Can)	JV66S	1
Valve Cover Set	1990-1991		(Contains Valve Cover Grommets) Victo-Tech	VS50117	1
	1988-1989		(Contains Valve Cover Washers, Spark Plug Tube Seals Not Included) Victo-Tech	VS38395	1
Valve Stem Seal, Exh.	1990-1991			B45556	8
	1988-1989			B45549	8
Valve Stem Seal, Int.	1990-1991			B45677	8
	1988-1989			B45549	8
Manifold Set, Exhaust	1988-1991			MS15382	1
Manifold Set, Intake	1990-1991			MS15643	1
	1988-1989			MS15566	1
Oil Pan Set	1988-1991			OS32088	1
Rear Main Seal Set	1988-1991			JV532	1
Timing Cover Set	1988-1991			JV1012	1

MISCELLANEOUS GASKETS

Camshaft Seal	1988-1991			66807	2
E.G.R. Gasket	1988-1991			G26246	1
Exhaust Pipe Gasket	1990-1991		(Ring Type 'A'), Catalytic Converter To Exhaust Pipe	F14594	2
	1988-1991		(Ring Type 'A'), Pipe To Manifold	F14592	2
	1988-1989		(Ring Type 'A'), Catalytic Converter To Exhaust Pipe	F20252	2
Fuel Inj. O-Ring	1988-1991			B45744	4
Oil Pump Inlet Tube	1988-1991			B45713	1
Oil Pump Mounting Gasket	1988-1991			H45696	1
Throttle Body Gasket	1988-1991			G31089	1
Water Outlet Gasket	1988-1991		(O-Ring Type) Victo-Tech	C24184	1
			Water Outlet To Block Victo-Tech	C24220	1
Water Pump Mount Gasket	1988-1991		(O-Ring Type)	B45550	2
				K27440	1

14 1587CC (1.6L) 4AGEC DOHC 4 Cyl, 3.189in./81mm (1985-1987) 14

Part	Year	VIN	Model/Application	Part Number	Qty.
ENGINE GASKETS					
Head Set	1985-1987			HS3794	1
Full Set	1985-1987		(Oil Pan Gasket Not Included)	FS3794	1
Cylinder Head Gasket	1985-1987		Nitroseal	5797	1
Cyl. Head Spacer Shim	1985-1987		Requires Sealing Compound Steel	3794S	1
Sealing Compound	1985-1987		(4 Ounce Brush Top Can)	JV66B	1
			(12 Ounce Spray Can)	JV66S	1
Valve Cover Set	1985-1987		(Contains Valve Cover Washers, Spark Plug Tube Seals Not Included) Victo-Tech	VS38395	1
Manifold Set, Exhaust	1985-1987			MS15382	1
Manifold Set, Intake	1985-1987			MS15566	1
Oil Pan Set	1985-1987			OS32088	1
Rear Main Seal Set	1985-1987			JV532	1

PASSENGER CAR

Toyota

14 (cont.)	1587CC (1.6L) 4AGEC DOHC 4 Cyl, 3.189in./81mm (1985-1987)					14 (cont.)
----------------------	--	--	--	--	--	----------------------

Part	Year	VIN	Model/Application	Part Number	Qty.
------	------	-----	-------------------	-------------	------

ENGINE GASKETS (cont.)

Timing Cover Set	1985-1987			JV1012	1
------------------	-----------	--	--	--------	---

MISCELLANEOUS GASKETS

Camshaft Seal	1985-1987			66807	2
E.G.R. Gasket	1985-1987			G26246	1
Exhaust Pipe Gasket	1985-1987		(Ring Type 'A'), Pipe To Manifold	F14592	2
			(Ring Type 'A'), Catalytic Converter To Exhaust Pipe	F20252	2
Fuel Inj. O-Ring	1985-1987			B45744	4
Oil Pump Inlet Tube	1985-1987			B45713	1
Oil Pump Mounting Gasket	1985-1987			H45696	1
Water Pump Mount Gasket	1985-1987		(O-Ring Type)	B45550	2
				K27440	1

15	1587CC (1.6L) 4AGELC DOHC 4 Cyl, 3.189in./81mm (1985-1988)					15
-----------	---	--	--	--	--	-----------

Part	Year	VIN	Model/Application	Part Number	Qty.
------	------	-----	-------------------	-------------	------

ENGINE GASKETS

Head Set	1985-1988			HS3794W	1
Full Set	1985-1988		(Oil Pan Gasket Not Included)	FS3794W	1
Cylinder Head Gasket	1985-1988			<i>Nitroseal</i> 5797	1
Cyl. Head Spacer Shim	1985-1988		Requires Sealing Compound	<i>Steel</i> 3794S	1
Sealing Compound	1985-1988		(4 Ounce Brush Top Can)	JV66B	1
			(12 Ounce Spray Can)	JV66S	1
Valve Cover Set	1985-1988		(Contains Valve Cover Washers, Spark Plug Tube Seals Not Included)	<i>Victo-Tech</i> VS38395	1
Valve Stem Seal, Exh.	1985-1988			B45549	8
Valve Stem Seal, Int.	1985-1988			B45549	8
Manifold Set, Exhaust	1985-1988			MS15382	1
Manifold Set, Intake	1985-1988			MS15566	1
Oil Pan Set	1985-1988			OS32088	1
Rear Main Seal Set	1985-1988			JV532	1
Timing Cover Set	1985-1988			JV1012	1

MISCELLANEOUS GASKETS

E.G.R. Gasket	1985-1988			G26246	1
Exhaust Pipe Gasket	1985-1988		(Ring Type 'A'), Catalytic Converter To Exhaust Pipe, Rear	F7458	1
			(Ring Type 'A'), Pipe To Manifold	F14592	1
			(Ring Type 'A'), Catalytic Converter To Exhaust Pipe, Front	F20252	1
Fuel Inj. O-Ring	1985-1988			B45744	4
Oil Pump Inlet Tube	1985-1988			B45713	1
Oil Pump Mounting Gasket	1985-1988			H45696	1
Water Outlet Gasket	1985-1988		(O-Ring Type)	<i>Victo-Tech</i> C24184	1
			Water Outlet To Block	<i>Victo-Tech</i> C24220	1
Water Pump Mount Gasket	1985-1988		(O-Ring Type)	B45550	2
				K27440	1

16	1587CC (1.6L) 4ALC SOHC 4 Cyl, 3.189in./81mm (1984-1988)					16
-----------	---	--	--	--	--	-----------

Part	Year	VIN	Model/Application	Part Number	Qty.
------	------	-----	-------------------	-------------	------

ENGINE GASKETS

Head Set	1986-1988			HS3756Y	1
	1984-1985			HS3756W	1
Lower Set	1984-1988			CS3756	1
Engine Kit Gasket Set	1986-1988		(Valve Cover Gasket Not Included), Use With Part Number VS50047	95-3409VR	1

16 1587CC (1.6L) 4ALC SOHC 4 Cyl, 3.189in./81mm (1984-1988) **16**
 (cont.) (cont.)

Part Year VIN Model/Application Part Number Qty.

ENGINE GASKETS (cont.)

Engine Kit Gasket Set (cont.)	1984-1985		(Valve Cover Gasket Not Included), Use With Part Number VS20348	95-3409VR	1
Cylinder Head Gasket	1984-1988		<i>Nitroseal</i>	3756	1
Cyl. Head Spacer Shim	1984-1988		Requires Sealing Compound <i>Steel</i>	3756S	1
Sealing Compound	1984-1988		(4 Ounce Brush Top Can)	JV66B	1
			(12 Ounce Spray Can)	JV66S	1
Valve Cover Set	1986-1988		(Contains Valve Cover Washers, Contains Valve Cover End Plug) <i>Victo-Tech</i>	VS50047	1
	1984-1985		(Contains Valve Cover Washers, Contains Valve Cover End Plug) <i>Victo-Tech</i>	VS20348	1
Valve Stem Seal, Exh.	1984-1988			B45476	4
Valve Stem Seal, Int.	1984-1988			B45476	4
Manifold Set, Int. & Exh.	1984-1988			MS15318	1
Oil Pan Set	1984-1988		<i>Cork Rubber</i>	OS30349	1
Rear Main Seal Set	1984-1988			JV532	1
Timing Cover Set	1984-1988			JV1009	1

MISCELLANEOUS GASKETS

Camshaft Seal	1984-1988			66807	2
Carb. Mount Gasket	1984-1988		2 Barrel Carburetor, Lower	G31031	2
			2 Barrel Carburetor, Upper	G31150	1
E.G.R. Gasket	1984-1988			G20262	1
Exhaust Pipe Gasket	1984-1988		(Ring Type 'A'), Catalytic Converter To Exhaust Pipe, Front	F7458	1
			(Ring Type 'A'), Pipe To Manifold	F14592	1
			(Ring Type 'A'), Catalytic Converter To Exhaust Pipe, Rear	F20252	1
Fuel Pump Gasket	1984-1988			D30983	2
Oil Pump Inlet Tube	1984-1988			B45713	1
Oil Pump Mounting Gasket	1984-1988			H45696	1
Valve Cover End Plug	1984-1987		(Half Round)	B45470	4
Water Outlet Gasket	1984-1988		(O-Ring Type) <i>Victo-Tech</i>	C24184	1
			Water Outlet To Block	C24213	1
Water Pump Mount Gasket	1984-1988		(O-Ring Type)	B45550	2
				K27440	1

17 1588CC (1.6L) 2TC OHV 4 Cyl, 3.346in./85mm (1971-1979) **17**

Part Year VIN Model/Application Part Number Qty.

ENGINE GASKETS

Head Set	1971-1979			HS3591	1
Full Set	1971-1979			FS3591	1
Engine Kit Gasket Set	1977-1979			95-3073VR	1
Cylinder Head Gasket	1971-1979		<i>Nitroseal</i>	3591	1
Valve Cover Set	1971-1979		(Contains Spark Plug Tube Seals) <i>Victo-Tech</i>	VS30008	1
Valve Stem Seal, Exh.	1973-1979		(O-Ring Type)	B20219	4
			Thru 7/72	B20212	4
	1971		From 8/72, (O-Ring Type)	B20219	4
				B20212	4
Valve Stem Seal, Int.	1973-1979		(O-Ring Type)	B20219	4
	1972		Thru 7/72, (O-Ring Type)	B20212	4
			From 8/72, (O-Ring Type)	B20219	4
	1971		(O-Ring Type)	B20212	4
Manifold Set, Exhaust	1971-1979		(Heat Shield Gasket May Require Replacement)	MS15239	1
Manifold Set, Intake	1971-1979			MS15240	1
Oil Pan Set	1971-1979		<i>Cork Rubber</i>	OS30044	1
Rear Main Seal Set	1971-1979			JV634	1

PASSENGER CAR

Toyota

17 (cont.)	1588CC (1.6L) 2TC OHV 4 Cyl, 3.346in./85mm (1971-1979)				17 (cont.)
----------------------	---	--	--	--	----------------------

Part	Year	VIN	Model/Application	Part Number	Qty.
ENGINE GASKETS (cont.)					
Timing Cover Set	1971-1979			JV907	1
MISCELLANEOUS GASKETS					
Carb. Mount Gasket	1975-1979		2 Barrel Carburetor	G30699	1
E.G.R. Gasket	1971-1979			G20264	1
Exhaust Pipe Gasket	1979		Thru 8/79, (Ring Type 'A'), Pipe To Manifold	F14596	2
	1976-1979		(Ring Type 'A'), Catalytic Converter To Exhaust Pipe	F20252	1
	1978		(Ring Type 'A'), Pipe To Manifold	F14596	2
	1977		Thru 8/77, (Ring Type 'A'), Pipe To Manifold	F14592	2
			From 9/77, (Ring Type 'A'), Pipe To Manifold	F14596	2
	1972-1976		(Ring Type 'A'), Pipe To Manifold	F14592	2
Fuel Pump Gasket	1971-1979			D20187	2
			(Spacer)	D31189	1
				MS15431	1
Heat Shield Gasket	1971-1979			MS15431	1
Spark Plug Tube Seal	1971-1979			B20334	4
Therm. Housing Gasket	1979		Thru 7/79	C30729	1
	1977-1978			C30729	1
	1976		Thru 7/76	C20244	1
			From 8/76	C30729	1
1971-1975			C20244	1	
Water Outlet Gasket	1971-1979			C26085	1
Water Pump Mount Gasket	1971-1979			K20317	1

18	1762CC (1.8L) 7AFE DOHC 4 Cyl, 3.189in./81mm (1993-1997)				18
-----------	---	--	--	--	-----------

Part	Year	VIN	Model/Application	Part Number	Qty.
ENGINE GASKETS					
Head Set	1993-1997		<i>Multi-Layered Steel</i>	HS54354	1
Lower Set	1993-1997			CS54354	1
Cylinder Head Gasket	1993-1997		<i>Multi-Layered Steel</i>	54354	1
Valve Cover Set	1993-1997		(Contains Spark Plug Tube Seals And Washers) <i>Victo-Tech</i>	VS50228	1
Valve Stem Seal, Exh.	1993-1997			B45791	8
Valve Stem Seal, Int.	1993-1997			B45549	8
Manifold Set, Exhaust	1993-1997			MS15560	1
Oil Pan Set	1993-1997			OS32138	1
Rear Main Seal Set	1993-1997		To Be Replaced By JV532	JV505	1
				JV532	1
Timing Cover Set	1993-1997		(Camshaft Seals Not Included)	JV5025	1
MISCELLANEOUS GASKETS					
Camshaft Seal	1993-1997			66807	1
E.G.R. Gasket	1996-1997			G31083	1
	1993-1995			G26262	1
Exhaust Pipe Gasket	1995		(Ring Type 'A'), Catalytic Converter To Exhaust Pipe, Front	F14594	1
	1993-1995		(Ring Type 'A'), Catalytic Converter To Exhaust Pipe, Rear	F20252	1
Fuel Inj. O-Ring	1993-1997			B45744	4
Spark Plug Tube Seal	1993-1997			B45778	4
Throttle Body Gasket	1993-1995		Corolla	G31382	1
Water Outlet Gasket	1993-1997		(O-Ring Type) <i>Victo-Tech</i>	C24184	1
Water Pump Mount Gasket	1993-1997		(O-Ring Type)	B45610	1
				K27440	1

19 1770CC (1.8L) 3TC OHV 4 Cyl, 3.346in./85mm (1980-1982) 19

Part	Year	VIN	Model/Application	Part Number	Qty.
ENGINE GASKETS					
Head Set	1981-1982			HS3591X	1
	1980			HS3591	1
Full Set	1981-1982			FS3591X	1
	1980			FS3591	1
Engine Kit Gasket Set	1980			95-3073VR	1
Cylinder Head Gasket	1980-1982		Nitroseal	3591	1
Valve Cover Set	1981-1982		(Contains Spark Plug Tube Seals) Victo-Tech	VS38138	1
	1980		(Contains Spark Plug Tube Seals) Victo-Tech	VS30008	1
Valve Stem Seal, Exh.	1980-1982			B20219	4
Valve Stem Seal, Int.	1980-1982			B20219	4
Manifold Set, Exhaust	1980-1982			MS15239	1
Manifold Set, Intake	1980-1982			MS15240	1
Oil Pan Set	1980-1982		Cork Rubber	OS30044	1
Rear Main Seal Set	1980-1982			JV634	1
Timing Cover Set	1980-1982			JV907	1

MISCELLANEOUS GASKETS

Carb. Mount Gasket	1980-1982		2 Barrel Carburetor	G30699	1
E.G.R. Gasket	1980-1982			G20264	1
Exhaust Pipe Gasket	1980-1982		(Ring Type 'A'), Pipe To Manifold	F14596	2
Fuel Pump Gasket	1980-1982			D20187	2
			(Spacer)	D31189	1
Spark Plug Tube Seal	1980-1982			B20334	4
Therm. Housing Gasket	1980-1982			C30729	1
Water Outlet Gasket	1980-1982			C26085	1
Water Pump Mount Gasket	1980-1982			K20317	1

20 1794CC (1.8L) 1ZZFE DOHC 4 Cyl, 3.110in./79mm (1998-1999) 20

Part	Year	VIN	Model/Application	Part Number	Qty.
MISCELLANEOUS GASKETS					
Fuel Inj. O-Ring	1998-1999			B45744	4
Therm. Housing Gasket	1998-1999			C31090	1

21 1794CC (1.8L) 1ZZFE DOHC VVTi 4 Cyl, 3.110in./79mm (2000-2001) 21

Part	Year	VIN	Model/Application	Part Number	Qty.
MISCELLANEOUS GASKETS					
Fuel Inj. O-Ring	2000-2001			B45744	4
Therm. Housing Gasket	2000-2001			C31090	1

22 1839CC (1.8L) 1CLC SOHC Diesel 4 Cyl, 3.268in./83mm (1984-1985) 22

Part	Year	VIN	Model/Application	Part Number	Qty.
ENGINE GASKETS					
Head Set	1984-1985			HS3771	1
Full Set	1984-1985		(Oil Pan Gasket Not Included)	FS3771	1
Cylinder Head Gasket	1984-1985		Nitroseal	3771	1
Valve Cover Set	1984-1985		(Contains Valve Cover Washers) Victo-Tech	VS38392	1
Valve Stem Seal, Exh.	1984-1985			B20219	4
Valve Stem Seal, Int.	1984-1985			B20219	4
Manifold Set, Exhaust	1984-1985			MS15376	1
Manifold Set, Intake	1984-1985			MS15355	1
Oil Pan Set	1984-1985			OS32086	1
Rear Main Seal Set	1984-1985			JV541	1

Toyota

22 (cont.)	1839CC (1.8L) 1CLC SOHC Diesel 4 Cyl, 3.268in./83mm (1984-1985)					22 (cont.)
----------------------	--	--	--	--	--	----------------------

Part	Year	VIN	Model/Application	Part Number	Qty.
------	------	-----	-------------------	-------------	------

ENGINE GASKETS (cont.)

Timing Cover Set	1984-1985			JV1008	1
------------------	-----------	--	--	--------	---

MISCELLANEOUS GASKETS

Camshaft Seal	1984-1985			66905	1
E.G.R. Gasket	1984-1985			G30704	1
Exhaust Pipe Gasket	1984-1985		1 Required, (Ring Type 'A'), Catalytic Converter To Exhaust Pipe, Pipe To Manifold	F14592	3
Oil Pump Inlet Tube	1984-1985			B45714	1
Oil Pump Mounting Gasket	1984-1985			B45697	1
Water Outlet Gasket	1984-1985		(O-Ring Type) <i>Victo-Tech</i>	C24184	1
Water Pump Mount Gasket	1984-1985			K27662	1

23	1839CC (1.8L) 1CTL Turbo Diesel 4 Cyl, 3.268in./83mm (1984-1985)					23
-----------	---	--	--	--	--	-----------

Part	Year	VIN	Model/Application	Part Number	Qty.
------	------	-----	-------------------	-------------	------

ENGINE GASKETS

Head Set	1984-1985			HS3771W	1
Full Set	1984-1985		(Oil Pan Gasket Not Included)	FS3771W	1
Cylinder Head Gasket	1984-1985		<i>Nitroseal</i>	3771	1
Valve Cover Set	1984-1985		(Contains Valve Cover Washers) <i>Victo-Tech</i>	VS38392	1
Valve Stem Seal, Exh.	1984-1985			B20219	4
Valve Stem Seal, Int.	1984-1985			B20219	4
Manifold Set, Exhaust	1984-1985			MS15356	1
Manifold Set, Intake	1984-1985			MS15355	1
Oil Pan Set	1984-1985			OS32086	1
Rear Main Seal Set	1984-1985			JV541	1
Timing Cover Set	1984-1985			JV1008	1

MISCELLANEOUS GASKETS

E.G.R. Gasket	1984-1985			G30704	1
Exhaust Pipe Gasket	1984-1985		(Ring Type 'A'), Catalytic Converter To Exhaust Pipe, Pipe To Manifold	F20252	1
Oil Pump Inlet Tube	1984-1985			B45714	1
Oil Pump Mounting Gasket	1984-1985			B45697	1
Turbo Gasket Set	1984-1985			GS27692	1
Water Outlet Gasket	1984-1985		(O-Ring Type) <i>Victo-Tech</i>	C24184	1
Water Pump Mount Gasket	1984-1985			K27662	1

24	1858CC (1.9L) 8RC SOHC 4 Cyl, 3.386in./86mm (1969-1971)					24
-----------	--	--	--	--	--	-----------

Part	Year	VIN	Model/Application	Part Number	Qty.
------	------	-----	-------------------	-------------	------

ENGINE GASKETS

Head Set	1969-1971			HS3588	1
Full Set	1969-1971			FS3588	1
Cylinder Head Gasket	1969-1971		<i>VR2000</i>	3588	1
Valve Cover Set	1969-1971		(Valve Cover End Plug May Require Replacement) <i>Cork Rubber</i>	VS30007	1
Valve Stem Seal, Exh.	1969-1971			B20211	4
Valve Stem Seal, Int.	1969-1971			B20211	4
Manifold Set, Int. & Exh.	1969-1971			MS15231	1
Oil Pan Set	1969-1971		<i>Cork Rubber</i>	OS30042	1
Rear Main Seal Set	1969-1971			JV635	1
Timing Cover Set	1969-1971			JV911	1

24 1858CC (1.9L) 8RC SOHC 4 Cyl, 3.386in./86mm (1969-1971) **24**
(cont.) (cont.)

Part	Year	VIN	Model/Application	Part Number	Qty.
MISCELLANEOUS GASKETS					
Exhaust Pipe Gasket	1969-1971		(Flange Type), Pipe To Manifold	F14593	1
Fuel Pump Gasket	1969-1971			D20187	2
			(Spacer)	D31189	1
Valve Cover End Plug	1969-1971		(Half Round)	B45466	2
Water Outlet Gasket	1969-1971			C26085	1
Water Pump Cover Gasket	1969-1971			K30730	1

25 1897CC (1.9L) 3RC OHV 4 Cyl, 3.465in./88mm (1965-1970) **25**

Part	Year	VIN	Model/Application	Part Number	Qty.
ENGINE GASKETS					
Head Set	1965-1970			HS3581	1
Full Set	1965-1970			FS3581	1
Cylinder Head Gasket	1965-1970		VR2000	3581	1
Valve Cover Set	1965-1970		Victo-Tech	VS30005	1
Manifold Set, Int. & Exh.	1965-1970			MS15340	1
Oil Pan Set	1965-1970		Cork Rubber	OS30041	1
Rear Main Seal Set	1968-1970			JV632	1
Timing Cover Seal	1968-1970			66859	1

MISCELLANEOUS GASKETS					
Exhaust Pipe Gasket	1968-1970		Single Pipe, (Ring Type 'A'), Pipe To Manifold	F14592	1
			Dual Pipe, (Flange Type), Pipe To Manifold	F14593	2
Fuel Pump Gasket	1968-1970			D20187	2
			(Spacer)	D31189	1
Water Pump Mount Gasket	1965-1970			K27631	1

26 1968CC (2.0L) 18RC SOHC 4 Cyl, 3.484in./88.5mm (1972-1974) **26**

Part	Year	VIN	Model/Application	Part Number	Qty.
ENGINE GASKETS					
Head Set	1972-1974			HS3588	1
Full Set	1972-1974			FS3588	1
Cylinder Head Gasket	1972-1974		VR2000	3588	1
Valve Cover Set	1972-1974		(Valve Cover End Plug May Require Replacement) Cork Rubber	VS30007	1
Valve Stem Seal, Exh.	1972-1974			B20211	4
Valve Stem Seal, Int.	1972-1974			B20211	4
Manifold Set, Int. & Exh.	1972-1974			MS15231	1
Oil Pan Set	1972-1974		Cork Rubber	OS30042	1
Rear Main Seal Set	1972-1974			JV635	1
Timing Cover Set	1972-1974			JV911	1

MISCELLANEOUS GASKETS					
Exhaust Pipe Gasket	1972-1974		(Flange Type), Front, Pipe To Manifold	F14593	1
			(Ring Type 'A'), Center	F14596	1
Fuel Pump Gasket	1972-1974			D20187	2
			(Spacer)	D31189	1
Valve Cover End Plug	1972-1974		(Half Round)	B45466	2
Water Outlet Gasket	1972-1974			C26085	1
Water Pump Cover Gasket	1972-1974			K30730	1

PASSENGER CAR

Toyota

27 1995CC (2.0L) 2SELC SOHC 4 Cyl, 3.307in./84mm (1983-1986)

27

Part	Year	VIN	Model/Application	Part Number	Qty.
ENGINE GASKETS					
Head Set	1983-1986			HS3757	1
Full Set	1983-1986			FS3757	1
Engine Kit Gasket Set	1983-1986			95-3273VR	1
Cylinder Head Gasket	1983-1986		Nitroseal	3757	1
Cyl. Head Spacer Shim	1983-1986		Requires Sealing Compound Steel	3757S	1
Sealing Compound	1983-1986		(4 Ounce Brush Top Can)	JV66B	1
				(12 Ounce Spray Can)	JV66S
Valve Cover Set	1983-1986		(Contains Valve Cover Washers)	VS38375	1
Valve Stem Seal, Exh.	1983-1986			B20219	4
Valve Stem Seal, Int.	1983-1986			B20219	4
Plenum Chamber Gasket	1983-1986			MS12359	1
Manifold Set, Int. & Exh.	1983-1986		(Contains Plenum Chamber Gasket)	MS15357	1
Oil Pan Set	1983-1986		Cork Rubber	OS30597	1
Rear Main Seal Set	1983-1986			JV530	1
Timing Cover Set	1983-1986		(Requires Oil Pan Set)	JV991	1

MISCELLANEOUS GASKETS

Camshaft Seal	1983-1986			66905	1
E.G.R. Gasket	1983-1986		Nitroseal	G31310	1
Exhaust Pipe Gasket	1986		(Ring Type 'A'), Catalytic Converter To Exhaust Pipe, Rear	F7458	1
	1983-1986		(Ring Type 'A'), Catalytic Converter To Exhaust Pipe, Front	F7461	1
			(Ring Type 'A'), Pipe To Manifold	F14596	1
	1983-1985		(Ring Type 'A'), Catalytic Converter To Exhaust Pipe, Rear	F20252	1
Fuel Inj. O-Ring	1983-1986			B45744	4
Oil Pump Inlet Tube	1983-1986			B45716	1
Oil Pump Mounting Gasket	1983-1986			L45699	1
Throttle Body Gasket	1983-1986			G30961	1
Water Outlet Gasket	1983-1986		(O-Ring Type) Victo-Tech	C24184	1
Water Pump Mount Gasket	1983-1986			K28357	1

28 1998CC (2.0L) 3SFE DOHC 4 Cyl, 3.386in./86mm (1987-1991)

28

Part	Year	VIN	Model/Application	Part Number	Qty.
ENGINE GASKETS					
Head Set	1991		(Contains Multi-layered Steel Head Gasket)	HS4920A	1
	1987-1990		Multi-Layered Steel	HS4920B	1
Full Set	1990-1991			FS5788W	1
	1987-1989		(Oil Pan Gasket Not Included)	FS5788	1
Engine Kit Gasket Set	1987-1991			95-3276VR	1
Cylinder Head Gasket	1987-1991		Nitroseal	4920	1
			Multi-Layered Steel	4920S	1
Cyl. Head Bolt Set	1990-1991			GS33355	1
	1987-1989			GS33320	1
Cyl. Head Spacer Shim	1987-1991		Requires Sealing Compound Steel	5788S	1
Sealing Compound	1987-1991		(4 Ounce Brush Top Can)	JV66B	1
				(12 Ounce Spray Can)	JV66S
Valve Cover Set	1987-1991		(Contains Spark Plug Tube Seals) Victo-Tech	VS50059	1
Valve Stem Seal, Exh.	1987-1991			B45549	8
Valve Stem Seal, Int.	1987-1991			B45549	8
Manifold Set, Exhaust	1987-1991		Multi-Layered Steel	MS16509	1
Manifold Set, Intake	1990-1991			MS16056	1
Oil Pan Set	1987-1991		Cork Rubber	OS30597	1
Rear Main Seal Set	1987-1991			JV530	1
Timing Cover Set	1987-1991		(Camshaft Seals Not Included)	JV1067	1

28 1998CC (2.0L) 3SFE DOHC 4 Cyl, 3.386in./86mm (1987-1991) **28**
(cont.) (cont.)

Part	Year	VIN	Model/Application	Part Number	Qty.
MISCELLANEOUS GASKETS					
Camshaft Seal	1987-1991			66905	1
E.G.R. Gasket	1987-1991		Nitroseal	G31310	1
Exhaust Pipe Gasket	1990-1991		Camry, (Ring Type 'A'), Pipe To Manifold	F14594	1
	1987-1991		Camry, (Ring Type 'A'), Catalytic Converter To Exhaust Pipe	F20252	1
	1987-1989		Camry, (Ring Type 'A'), Pipe To Manifold	F7454	1
			Celica, (Ring Type 'A'), Pipe To Manifold	F14594	1
			Celica, (Ring Type 'A'), Catalytic Converter To Exhaust Pipe	F20252	1
Fuel Inj. O-Ring	1987-1991		B45744	4	
Oil Pump Inlet Tube	1987-1991		B45716	1	
Oil Pump Mounting Gasket	1987-1991		L45699	1	
Therm. Housing Gasket	1987-1991	(O-Ring Type)	Victo-Tech	C24184	1
Throttle Body Gasket	1987-1991			G31008	1
Water Outlet Gasket	1987-1991			C30632	1
Water Pump Mount Gasket	1987-1991	(O-Ring Type)		B45742	1
				K31007	1
	1987-1989	(O-Ring Type)		B45610	1

29 1998CC (2.0L) 3SGELC DOHC 4 Cyl, 3.386in./86mm (1986-1989) **29**

Part	Year	VIN	Model/Application	Part Number	Qty.
ENGINE GASKETS					
Head Set	1986-1989			HS5709	1
Full Set	1986-1989		(Oil Pan Gasket Not Included)	FS5709	1
Engine Kit Gasket Set	1986-1989			95-3275VR	1
Cylinder Head Gasket	1986-1989		Nitroseal	5709	1
Cyl. Head Spacer Shim	1986-1989		Requires Sealing Compound		
				Steel	5709S
Sealing Compound	1986-1989		(4 Ounce Brush Top Can)	JV66B	1
			(12 Ounce Spray Can)	JV66S	1
Valve Cover Set	1986-1989		Left	Victo-Tech	VS50011
			Right	Victo-Tech	VS50048
Valve Stem Seal, Exh.	1986-1989			B45549	8
Valve Stem Seal, Int.	1986-1989			B45549	8
Manifold Set, Exhaust	1986-1989		Multi-Layered Steel	MS16509	1
Manifold Set, Intake	1986-1989		(Contains Plenum Chamber Gasket)	MS15586	1
Plenum Chamber Gasket	1986-1989			MS15458	1
Oil Pan Set	1986-1989		Cork Rubber	OS30597	1
Rear Main Seal Set	1986-1989			JV530	1
Timing Cover Set	1986-1989			JV1022	1

Part	Year	VIN	Model/Application	Part Number	Qty.
MISCELLANEOUS GASKETS					
Camshaft Seal	1986-1989			66807	2
E.G.R. Gasket	1986-1989			G30633	1
Exhaust Pipe Gasket	1986-1989		(Ring Type 'A'), Catalytic Converter To Exhaust Pipe, Front	F7459	1
			(Ring Type 'A'), Catalytic Converter To Exhaust Pipe, Rear	F7460	1
			(Ring Type 'A'), Pipe To Manifold	F14592	2
Fuel Inj. O-Ring	1986-1989			B45744	4
Oil Pump Inlet Tube	1986-1989			B45716	1
Oil Pump Mounting Gasket	1986-1989			L45699	1
Therm. Housing Gasket	1986-1989			C30632	1
Throttle Body Gasket	1986-1989			G31011	1
Water Outlet Gasket	1986-1989	(O-Ring Type)	Victo-Tech	C24184	1

PASSENGER CAR

Toyota

29 (cont.)	1998CC (2.0L) 3SGELC DOHC 4 Cyl, 3.386in./86mm (1986-1989)				29 (cont.)
----------------------	---	--	--	--	----------------------

Part	Year	VIN	Model/Application	Part Number	Qty.
------	------	-----	-------------------	-------------	------

MISCELLANEOUS GASKETS (cont.)

Water Pump Mount Gasket	1986-1989			K20624	1
-------------------------	-----------	--	--	--------	---

30	1998CC (2.0L) 3SGTE DOHC 4 Cyl, 3.386in./86mm (1988-1994)				30
-----------	--	--	--	--	-----------

Part	Year	VIN	Model/Application	Part Number	Qty.
------	------	-----	-------------------	-------------	------

ENGINE GASKETS

Engine Kit Gasket Set	1991-1994		(Valve Cover Gasket Not Included)	95-3275VR	1
	1988-1990		Turbocharged	95-3275VR	1
Valve Stem Seal, Exh.	1988-1994			B45549	8
Valve Stem Seal, Int.	1994			B45549	8
	1990-1993			B45556	8
Manifold Set, Exhaust	1988-1994		Multi-Layered Steel	MS16509	1
Rear Main Seal Set	1990-1994			JV1630	1
Timing Cover Set	1988-1994			JV1137	1

MISCELLANEOUS GASKETS

Camshaft Seal	1988-1994			66807	2
E.G.R. Gasket	1988-1994			G30633	1
Exhaust Pipe Gasket	1988-1994		(Ring Type 'A'), Pipe To Manifold	F20257	1
Thermostat O-Ring	1988-1994		(O-Ring Type) Victo-Tech	C31090	1
Valve Cover Washer	1990-1994			B45809	10
Water Pump Mount Gasket	1988-1994			K28357	1

31	2164CC (2.2L) 5SFE DOHC 4 Cyl, 3.425in./87mm (1990-2001)				31
-----------	---	--	--	--	-----------

Part	Year	VIN	Model/Application	Part Number	Qty.
------	------	-----	-------------------	-------------	------

ENGINE GASKETS

Head Set	1999-2001		Solara, (Contains Multi-layered Steel Head Gasket)	HS4920A	1
	1992-2001		Camry, (Contains Multi-layered Steel Head Gasket)	HS4920A	1
	1990-1999		Celica, (Contains Multi-layered Steel Head Gasket)	HS4920A	1
	1990-1995		MR2, (Contains Multi-layered Steel Head Gasket)	HS4920A	1
Full Set	1994-1997		Celica	FS4920	1
	1995		Camry, Thru 8/95	FS4920	1
	1990-1995		MR2	FS4920	1
	1992-1994		Camry	FS4920	1
Cylinder Head Gasket	1990-2001		Multi-Layered Steel	4920S	1
	1996-1997		Camry, Celica, Thru 12/96 Nitroseal	4920	1
	1992-1996		Camry Nitroseal	4920	1
	1994-1995		Celica Nitroseal	4920	1
	1990-1995		MR2 Nitroseal	4920	1
Cyl. Head Bolt Set	1990-2001			GS33355	1
Valve Cover Set	1990-2001		(Contains Spark Plug Tube Seals) Victo-Tech	VS50059	1
Valve Stem Seal, Exh.	1990-2001			B45549	8
Valve Stem Seal, Int.	1997-2001			B45549	8
	1992-1996		Camry	B45549	8
	1990-1996		Celica	B45549	8
	1990-1995		MR2	B45556	8
Manifold Set, Exhaust	1990-2001		Multi-Layered Steel	MS16509	1
Manifold Set, Intake	1990-2001			MS16056	1
Oil Pan Set	1990-2001		Cork Rubber	OS30597	1
Rear Main Seal Set	1996-1998		Celica	JV530	1
	1992-1998		Camry	JV530	1
	1992-1995		MR2	JV530	1
Timing Cover Set	1992-1998		(Camshaft Seals Not Included)	JV1137	1

MISCELLANEOUS GASKETS

Camshaft Seal	1990-2001			66905	1
---------------	-----------	--	--	-------	---

31
(cont.)

2164CC (2.2L) 5SFE DOHC 4 Cyl, 3.425in./87mm (1990-2001)

31
(cont.)

Part	Year	VIN	Model/Application	Part Number	Qty.
MISCELLANEOUS GASKETS (cont.)					
Dist. Mounting Gasket	1990-1994		(O-Ring Type)	B45859	1
	1992		Thru 1/92, (O-Ring Type)	B45859	1
	1990-1991		(O-Ring Type)	B45859	1
E.G.R. Gasket	1990-2001		<i>Nitroseal</i>	G31310	1
Exhaust Pipe Gasket	1995-1999		Catalytic Converter To Front Exhaust Pipe	F7458	1
	1990-1999		(Ring Type 'A'), Manifold To Pre-Catalytic Converter	F7454	1
			(Ring Type 'A'), Catalytic Converter To Center Pipe	F20252	1
	1997-1998		Camry, Except California, (Ring Type 'A'), Catalytic Converter To Exhaust Pipe, Front	F7459	1
			Camry, Except California, (Ring Type 'A'), Catalytic Converter To Exhaust Pipe, Rear	F7460	1
			Camry, California, (Ring Type 'A'), Catalytic Converter To Exhaust Pipe, Exhaust Pipe To Muffler	F20252	1
	1994-1998		Celica, (Ring Type 'A'), Manifold To Converter, Pipe To Manifold	F7454	1
			Celica, (Ring Type 'A'), Center Pipe To Muffler, Pipe To Tail Assembly	F14592	1
			Celica, (Ring Type 'A'), Center	F20252	1
	1992-1998		Camry, Except California, Federal Emission, (Ring Type 'A'), Catalytic Converter To Exhaust Pipe, Catalytic Converter To Front Exhaust Pipe, Front	F7459	1
			Camry, Except California, Federal Emission, (Ring Type 'A'), Catalytic Converter To Center Pipe, Catalytic Converter To Exhaust Pipe, Rear	F7460	1
			Camry, (Ring Type 'A'), Pipe To Manifold	F14594	1
			Camry, (Ring Type 'A'), Exhaust Pipe To Muffler	F20252	1
	1994		California Emission, Catalytic Converter To Front Exhaust Pipe	F7458	1
	1990-1994		(Ring Type 'A'), Pipe To Manifold	F14594	1
	1993		MR2, Thru 11/93, (Ring Type 'A'), Manifold To Converter	F7454	1
			MR2, Thru 11/93, (Ring Type 'A'), Pipe To Manifold	F14594	1
	1992-1993		California Emission, (Ring Type 'A'), Manifold To Pre-Catalytic Converter	F7454	1
			California Emission, (Ring Type 'A'), Catalytic Converter To Center Pipe	F20252	1
	1990-1993		(Ring Type 'A'), Manifold To Pre-Catalytic Converter	F7454	1
		(Ring Type 'A'), Center Pipe To Muffler	F20252	1	
		(Ring Type 'A'), Catalytic Converter To Center Pipe, Center Pipe To Muffler	F20252	1	
1990-1992		MR2, (Ring Type 'A'), Manifold To Converter	F7454	1	
Fuel Inj. O-Ring	1990-1998			B45744	4
Fuel Injection Seal	1990-2001		(Grommet), Injector To Fuel Rail	B45854	4
Oil Pump Inlet Tube	1990-1993			B45716	1
Therm. Housing Gasket	1990-2001			C30632	1
Throttle Body Gasket	1990-1999			G31008	1
Timing Cover Dust Seal Set	1990-1995			JV1151	1
Water By-Pass Gasket	1990-2001		(O-Ring Type)	B45772	1
Water Outlet Gasket	1992-2001		(O-Ring Type) <i>Victo-Tech</i>	C24184	1
	1992-1996		Camry, (O-Ring Type) <i>Victo-Tech</i>	C24184	1
	1990-1995		MR2	C31546	1
Water Pump Mount Gasket	1990-1998			K31007	1

Toyota

32 2189CC (2.2L) 20R SOHC 4 Cyl, 3.484in./88.5mm (1975-1980)

32

Part	Year	VIN	Model/Application	Part Number	Qty.
ENGINE GASKETS					
Head Set	1975-1980			HS3592X	1
Full Set	1975-1980			FS3592X	1
Engine Kit Gasket Set	1975-1980			95-3126VR	1
Cylinder Head Gasket	1975-1980		<i>Nitroseal</i>	3592	1
Valve Cover Set	1975-1980		(Contains Valve Cover Washers, Contains Valve Cover End Plugs) <i>Victo-Tech</i>	VS30011	1
Valve Stem Seal, Exh.	1975-1980			B20219	4
Valve Stem Seal, Int.	1975-1980			B20219	4
Manifold Set, Exhaust	1975-1980			MS15282A	1
Manifold Set, Intake	1975-1980			MS15266	1
Oil Pan Set	1975-1980		<i>Cork Rubber</i>	OS30047	1
Rear Main Seal Set	1975-1980			JV501	1
Crank Repair Sleeve	1975-1980		Use With Part Number A512 <i>Nickel Plated Formed Steel, .013" Thickness</i>	A346	1
Timing Cover Set	1975-1980			JV912	1
Timing Cover Seal	1975-1980			66514	1
Harmonic Balancer Repair Sleeve	1975-1980		Use With Part Number A504 <i>Nickel Plated Formed Steel, .013" Thickness</i>	A233	1

MISCELLANEOUS GASKETS

Carb. Mount Gasket	1975-1980		2 Barrel Carburetor	G30698	2
E.G.R. Gasket	1979-1980			G20364	1
	1975-1978			G26262	1
Exhaust Pipe Gasket	1979-1980		(Ring Type 'A'), Pipe To Manifold	F14596	2
	1975-1980		(Ring Type 'A'), Catalytic Converter To Exhaust Pipe	F14592	1
	1975-1978		(Ring Type 'A'), Pipe To Manifold	F20252	1
Fuel Pump Gasket	1975-1980			D20187	2
			(Spacer)	D31189	1
Oil Pump Inlet Tube	1975-1980			B45715	1
Oil Pump Mounting Gasket	1975-1980			B45698	1
Valve Cover End Plug	1975-1980		(Half Round)	B45468	2
Valve Cover Washer	1975-1980			B45486	4
Water Outlet Gasket	1975-1980			C26085	1
Water Pump Mount Gasket	1975-1980			K27381	1

33 2253CC (2.3L) 2M SOHC 6 Cyl, 2.953in./75mm (1968-1972)

33

Part	Year	VIN	Model/Application	Part Number	Qty.
ENGINE GASKETS					
Head Set	1968-1972			HS3945	1
Cylinder Head Gasket	1968-1972		<i>VR2000</i>	3945	1
Valve Cover Set	1968-1972		(Valve Cover End Plug May Require Replacement) <i>Cork Rubber</i>	VS30009	1
Valve Stem Seal, Exh.	1968-1972			B20215	6
Valve Stem Seal, Int.	1968-1972			B20211	6
Manifold Set, Exhaust	1968-1972			MS15259	1
Manifold Set, Intake	1968-1972			MS15311	1
Oil Pan Set	1968-1972		<i>Cork Rubber</i>	OS30045	1
Rear Main Seal Set	1968-1972			JV635	1
Timing Cover Set	1968-1972			JV908	1
MISCELLANEOUS GASKETS					
Exhaust Pipe Gasket	1968-1972		(Flange Type), Pipe To Manifold	F14593	1
Valve Cover End Plug	1968-1972		(Half Round)	B45469	2
Water Outlet Gasket	1968-1972			C26085	1

34 2366CC (2.4L) 22R SOHC 4 Cyl, 3.622in./92mm (1981-1983)

34

Part	Year	VIN	Model/Application	Part Number	Qty.
ENGINE GASKETS					
Head Set	1983			HS5707B	1
	1981-1982		To Be Replaced By HS5707A	HS3705	1
					HS5707A
Lower Set	1981-1983		(Requires Head Set To Make Full Set)	CS5707A	1
Engine Kit Gasket Set	1983			95-3427VR	1
	1981-1982		(Exhaust Manifold Gasket Not Included), Use With Part Number MS15282A	95-3427VR	1
Cylinder Head Gasket	1981-1983		(Original Style Flange) Nitroseal	5707	1
			(New Style Flange)	54355	1
Cyl. Head Spacer Shim	1981-1983		Requires Sealing Compound Steel	5707S	1
Sealing Compound	1981-1983		(4 Ounce Brush Top Can)	JV66B	1
			(12 Ounce Spray Can)	JV66S	1
Valve Cover Set	1981-1983		(Contains Valve Cover Washers, Contains Valve Cover End Plugs) Victo-Tech	VS30011	1
Valve Stem Seal, Exh.	1981-1983			B20219	4
Valve Stem Seal, Int.	1981-1983			B20219	4
Manifold Set, Exhaust	1983			MS16241	1
	1981-1982			MS15282A	1
Manifold Set, Intake	1981-1983		To Be Replaced By MS16240	MS15578	1
				MS16240	1
				OS30047	1
Oil Pan Set	1981-1983		Cork Rubber	OS30047	1
Rear Main Seal Set	1981-1983			JV501	1
Crank Repair Sleeve	1981-1983		Use With Part Number A512 Nickel Plated Formed Steel	A346	1
Timing Cover Set	1981-1983			JV912	1
Timing Cover Seal	1981-1983			66514	1
Harmonic Balancer Repair Sleeve	1981-1983		Use With Part Number A504 Nickel Plated Formed Steel, .013" Thickness	A233	1

MISCELLANEOUS GASKETS

Carb. Mount Gasket	1983		(Heater Gasket), 2 Barrel Carburetor	G30700	1
E.G.R. Gasket	1981			G20364	1
Exhaust Pipe Gasket	1983		(Ring Type 'A'), Pipe To Manifold	F14596	1
	1981-1982		(Ring Type 'A'), Pipe To Manifold	F20252	1
Fuel Pump Gasket	1981-1983			D20187	2
			(Spacer)	D31189	1
Oil Pump Inlet Tube	1981-1983			B45715	1
Oil Pump Mounting Gasket	1981-1983			B45698	1
Valve Cover End Plug	1981-1983		(Half Round)	B45468	2
Valve Cover Washer	1981-1983			B45486	4
Water Outlet Gasket	1983		(O-Ring Type) Victo-Tech	C26118	1
	1981-1982			C26085	1
Water Pump Mount Gasket	1981-1983			K27381	1

35 2366CC (2.4L) 22REC SOHC 4 Cyl, 3.622in./92mm (1983-1985)

35

Part	Year	VIN	Model/Application	Part Number	Qty.
ENGINE GASKETS					
Head Set	1985			HS5707C	1
	1983-1984			HS5707B	1
Lower Set	1985		(Requires Head Set To Make Full Set)	CS5707B	1
	1983-1984		(Requires Head Set To Make Full Set)	CS5707A	1
Engine Kit Gasket Set	1985			95-3428VR	1
	1983-1985			95-3427VR	1
Cylinder Head Gasket	1983-1985		(Original Style Flange) Nitroseal	5707	1
			(New Style Flange)	54355	1
Cyl. Head Spacer Shim	1983-1985		Requires Sealing Compound Steel	5707S	1

Toyota

35 (cont.)	2366CC (2.4L) 22REC SOHC 4 Cyl, 3.622in./92mm (1983-1985)				35 (cont.)
----------------------	--	--	--	--	----------------------

Part	Year	VIN	Model/Application	Part Number	Qty.
ENGINE GASKETS (cont.)					
Sealing Compound	1983-1985		(4 Ounce Brush Top Can)	JV66B	1
			(12 Ounce Spray Can)	JV66S	1
Valve Cover Set	1985		(Contains Valve Cover Washers, Contains Valve Cover End Plugs) <i>Victo-Tech</i>	VS50012	1
	1983-1984		(Contains Valve Cover Washers, Contains Valve Cover End Plugs) <i>Victo-Tech</i>	VS30011	1
Valve Stem Seal, Exh.	1983-1985			B20219	4
Valve Stem Seal, Int.	1983-1985			B20219	4
Manifold Set, Exhaust	1985			MS16242	1
	1983-1984			MS16241	1
Manifold Set, Intake	1983-1985		(Contains Plenum Chamber Gasket)	MS16240	1
	1983-1984		To Be Replaced By MS16240	MS15578	1
Plenum Chamber Gasket	1983-1985			MS12358	1
Oil Pan Set	1983-1985		<i>Cork Rubber</i>	OS30047	1
Rear Main Seal Set	1983-1985			JV501	1
Crank Repair Sleeve	1983-1985		Use With Part Number A512 <i>Nickel Plated Formed Steel</i>	A346	1
Timing Cover Set	1985			JV1021	1
	1983-1984			JV912	1
Timing Cover Seal	1983-1985			66514	1
Harmonic Balancer Repair Sleeve	1983		Use With Part Number A504 <i>Nickel Plated Formed Steel, .013" Thickness</i>	A233	1

MISCELLANEOUS GASKETS

E.G.R. Gasket	1983-1985			G30703	1
Exhaust Pipe Gasket	1983-1985		(Ring Type 'A'), Pipe To Manifold	F14596	1
Fuel Pump Gasket	1983-1984			D20187	2
			(Spacer)	D31189	1
Oil Pump Inlet Tube	1983-1985			B45715	1
Oil Pump Mounting Gasket	1983-1985			B45698	1
Throttle Body Gasket	1983-1985			G30958	1
Valve Cover End Plug	1983-1985		(Half Round)	B45468	2
Valve Cover Washer	1985			B45555	4
	1983-1984			B45486	4
Water Outlet Gasket	1983-1985		(O-Ring Type) <i>Victo-Tech</i>	C26118	1
Water Pump Mount Gasket	1985			K31563	1
	1983-1984			K27381	1

36	2507CC (2.5L) 2VZFE DOHC V6 Cyl, 3.445in./87.5mm (1988-1991)				36
-----------	---	--	--	--	-----------

Part	Year	VIN	Model/Application	Part Number	Qty.
ENGINE GASKETS					
Head Set	1988-1991			HS5859	1
Full Set	1988-1991		(Oil Pan Gasket Not Included)	FS5859	1
Engine Kit Gasket Set	1988-1991			95-3282VR	1
Cylinder Head Gasket	1988-1991		Left <i>Nitroseal</i>	5859	1
			Right <i>Nitroseal</i>	5860	1
Cyl. Head Bolt Set	1988-1991			GS33353	2
Cyl. Head Washer Set	1988-1991			GS33354	2
Valve Cover Set	1988-1991		(Contains Spark Plug Tube Seals And Washers) <i>Victo-Tech</i>	VS50099	1
			(Single Valve Cover, Valve Cover Washers Not Included, Spark Plug Tube Seals Not Included) <i>Victo-Tech</i>	VS50099S	1
Valve Stem Seal, Exh.	1988-1991			B45657	12
Valve Stem Seal, Int.	1988-1991			B45657	12
Manifold Set, Exhaust	1988-1991			MS15563	1
Manifold Set, Intake	1988-1991		(Contains Plenum Chamber Gasket)	MS15562	1

36 2507CC (2.5L) 2VZFE DOHC V6 Cyl, 3.445in./87.5mm (1988-1991) **36**
(cont.) (cont.)

Part *Year* *VIN* *Model/Application* *Part Number* *Qty.*

ENGINE GASKETS (cont.)

Oil Pan Set	1988-1991			<i>Tuff-Cork</i>	OS32095	1
Rear Main Seal	1988-1991			<i>Rubber</i>	67120	1
Timing Cover Set	1988-1991		(Camshaft Seals Not Included)		JV1108	1
Timing Cover Seal	1988-1991				67010	1

MISCELLANEOUS GASKETS

Camshaft Seal	1988-1991				66905	1
E.G.R. Gasket	1988-1991				G31086	2
Exhaust Pipe Gasket	1988-1991		(Ring Type 'A'), Pipe To Manifold		F14594	1
Therm. Housing Gasket	1988-1991				C31087	1
Thermostat O-Ring	1988-1991		(O-Ring Type)	<i>Victo-Tech</i>	C31090	1
Throttle Body Gasket	1988-1991				G31085	1

37 2563CC (2.6L) 4M SOHC 6 Cyl, 3.150in./80mm (1971-1979) **37**

Part *Year* *VIN* *Model/Application* *Part Number* *Qty.*

ENGINE GASKETS

Head Set	1979		Cressida, (Requires Valve Cover Set)		HS3985	1
	1978		Cressida, From 3/78, (Requires Valve Cover Set)		HS3985	1
	1976		Corona Mk II, From 12/76		HS3985	1
	1974		Corona Mk II, Crown, Thru 11/74		HS3946	1
	1973		Corona Mk II		HS3946	1
	1971-1973		Crown		HS3946	1
Full Set	1979		Cressida, (Requires Valve Cover Set)		FS3985	1
	1978		Cressida, From 3/78, (Requires Valve Cover Set)		FS3985	1
	1976		Corona Mk II		FS3985	1
Cylinder Head Gasket	1978-1979		Cressida	<i>VR2000</i>	3985	1
			Corona Mk II, Thru 11/76	<i>VR2000</i>	3946	1
	1976		Corona Mk II, From 12/76	<i>VR2000</i>	3985	1
			Corona Mk II	<i>VR2000</i>	3946	1
	1974		Crown, Thru 11/74	<i>VR2000</i>	3946	1
	1971-1973		Crown	<i>VR2000</i>	3946	1
Valve Cover Set	1979		Cressida, (Contains Valve Cover End Plug)	<i>Victo-Tech</i>	VS30141	1
	1978		Cressida, From 3/78, (Contains Valve Cover End Plug)	<i>Victo-Tech</i>	VS30141	1
	1976		Corona Mk II, Thru 11/76, (Valve Cover End Plug May Require Replacement)	<i>Cork Rubber</i>	VS30009	1
			Corona Mk II, From 12/76, (Valve Cover End Plug May Require Replacement)	<i>Victo-Tech</i>	VS30142	1
	1973-1975		Corona Mk II, (Valve Cover End Plug May Require Replacement)	<i>Cork Rubber</i>	VS30009	1
	1971-1974		Crown, (Valve Cover End Plug May Require Replacement)	<i>Cork Rubber</i>	VS30009	1
Valve Stem Seal, Exh.	1978-1979		Cressida		B20215	6
	1973-1976		Corona Mk II		B20215	6
	1973-1974		Crown		B20215	6
Valve Stem Seal, Int.	1978-1979		Cressida		B20211	6
	1973-1976		Corona Mk II		B20211	6
	1973-1974		Crown		B20211	6
Manifold Set, Exhaust	1978-1979		Cressida		MS15527	1
	1976		Corona Mk II, From 12/76		MS15527	1
	1974		Corona Mk II, Crown, Thru 11/74		MS15259	1
	1973		Corona Mk II		MS15259	1
	1971-1973		Crown		MS15259	1
Manifold Set, Intake	1978-1979		Cressida		MS15528	1
	1976		Corona Mk II, Thru 11/76		MS15311	1
			Corona Mk II, From 12/76		MS15528	1
1973-1975		Corona Mk II		MS15311	1	

Toyota

37 2563CC (2.6L) 4M SOHC 6 Cyl, 3.150in./80mm (1971-1979)

(cont.)

37

(cont.)

Part Year VIN Model/Application Part Number Qty.

ENGINE GASKETS (cont.)

Manifold Set, Intake (cont.)	1974		Crown, Thru 11/74	MS15311	1
	1971-1973		Crown	MS15311	1
Oil Pan Set	1978-1979		Cressida <i>Cork Rubber</i>	OS30045	1
	1973-1976		Corona Mk II <i>Cork Rubber</i>	OS30045	1
	1974		Crown, Thru 11/74 <i>Cork Rubber</i>	OS30045	1
	1971-1973		Crown <i>Cork Rubber</i>	OS30045	1
Rear Main Seal Set	1978-1979		Cressida	JV635	1
	1973-1976		Corona Mk II	JV635	1
	1974		Crown, Thru 11/74	JV635	1
	1971-1973		Crown	JV635	1
Timing Cover Set	1978-1979		Cressida	JV908	1
	1973-1976		Corona Mk II	JV908	1
	1974		Crown, Thru 11/74	JV908	1
	1971-1973		Crown	JV908	1

MISCELLANEOUS GASKETS

E.G.R. Gasket	1978-1979		Cressida	G26259	1
	1973-1976		Corona Mk II	G26259	1
	1974		Crown, Thru 11/74	G26259	1
	1971-1973		Crown	G26259	1
Exhaust Pipe Gasket	1978-1979		Cressida, (Ring Type 'A'), Pipe To Manifold	F10038	1
	1978		Cressida, Catalytic Converter	F10116	2
	1976		Corona Mk II, From 12/76, (Ring Type 'A'), Pipe To Manifold	F10038	1
			Corona Mk II, Thru 11/76, (Ring Type 'A'), Pipe To Manifold	F14592	1
	1975		Corona Mk II, (Ring Type 'A'), Pipe To Manifold	F14592	1
	1974		Corona Mk II, Crown, From 12/74, (Ring Type 'A'), Pipe To Manifold	F14592	1
			Corona Mk II, Crown, Thru 11/74, (Flange Type), Pipe To Manifold	F14593	1
1973		Corona Mk II, (Flange Type), Pipe To Manifold	F14593	1	
1971-1973		Crown, (Flange Type), Pipe To Manifold	F14593	1	
Fuel Pump Gasket	1978-1979		Cressida	D27094	2
	1973-1976		Corona Mk II	D27094	2
	1974		Crown, Thru 11/74	D27094	2
	1971-1973		Crown	D27094	2
Valve Cover End Plug	1979		Cressida, Thru 8/79	B45467	2
	1978		Cressida	B45467	2
	1976		Corona Mk II, From 12/76	B45467	2
			Corona Mk II, Thru 11/76	B45469	2
	1973-1975		Corona Mk II	B45469	2
Water Outlet Gasket	1978-1979		Cressida	C26085	1
	1973-1976		Corona Mk II	C26085	1
	1974		Crown, Thru 11/74	C26085	1
	1971-1973		Crown	C26085	1
Water Pump Cover Gasket	1978-1979		Cressida	K30730	1
	1973-1976		Corona Mk II	K30730	1
	1974		Crown, Thru 11/74	K30730	1
	1971-1973		Crown	K30730	1
Water Pump Mount Gasket	1978-1979		Cressida	K27443	1
	1973-1976		Corona Mk II	K27443	1
	1974		Crown, Thru 11/74	K27443	1
	1971-1973		Crown	K27443	1

38 2563CC (2.6L) 4ME SOHC 6 Cyl, 3.150in./80mm (1979-1980)**38**

Part	Year	VIN	Model/Application	Part Number	Qty.
ENGINE GASKETS					
Head Set	1980			HS3985X	1
	1979		From 1/79	HS3985X	1
Full Set	1980			FS3985X	1
	1979		From 1/79	FS3985X	1
Cylinder Head Gasket	1980		VR2000	3985	1
	1979		From 1/79 VR2000	3985	1
Valve Cover Set	1980		(Contains Valve Cover End Plug) Victo-Tech	VS30141	1
	1979		From 1/79, (Contains Valve Cover End Plug) Victo-Tech	VS30141	1
Valve Stem Seal, Exh.	1980			B20215	6
	1979		From 1/79	B20215	6
Valve Stem Seal, Int.	1980			B20215	6
	1979		From 1/79	B20215	6
Manifold Set, Exhaust	1980			MS15527	1
	1979		From 1/79	MS15527	1
Manifold Set, Intake	1980		(Contains Plenum Chamber Gasket)	MS15529	1
	1979		From 1/79, (Contains Plenum Chamber Gasket)	MS15529	1
Plenum Chamber Gasket	1980			MS12352	1
	1979		From 1/79	MS12352	1
Oil Pan Set	1980		Cork Rubber	OS30045	1
	1979		From 1/79 Cork Rubber	OS30045	1
Rear Main Seal Set	1980			JV635	1
	1979		From 1/79	JV635	1
Timing Cover Set	1980			JV908	1
	1979		From 1/79	JV908	1

MISCELLANEOUS GASKETS

E.G.R. Gasket	1980		Valve	G26272	1
	1979-1980		From 1/79, Inlet	G26355	1
	1979		From 1/79, Valve	G26272	1
Exhaust Pipe Gasket	1980		(Ring Type 'A'), Pipe To Manifold	F14592	1
	1979		From 1/79, (Ring Type 'A'), Pipe To Manifold	F14592	1
Fuel Pump Gasket	1980			D27094	2
	1979		From 1/79	D27094	2
Throttle Body Gasket	1980			G30956	1
	1979		From 1/79	G30956	1
Valve Cover End Plug	1980		(Half Round)	B45467	2
	1979		From 1/79, (Half Round)	B45467	2
Water Outlet Gasket	1980			C26085	1
	1979		From 1/79	C26085	1
Water Pump Cover Gasket	1980			K30730	1
	1979		From 1/79	K30730	1
Water Pump Mount Gasket	1980			K27443	1
	1979		From 1/79	K27443	1

39 2759CC (2.8L) 5ME SOHC 6 Cyl, 3.268in./83mm (1981-1982)**39**

Part	Year	VIN	Model/Application	Part Number	Qty.
ENGINE GASKETS					
Head Set	1981-1982			HS3986	1
Full Set	1981-1982			FS3986	1
Cylinder Head Gasket	1981-1982		Nitroseal	3986	1
Valve Cover Set	1982		(Contains Valve Cover Washers) Victo-Tech	VS38344	1
	1981-1982		(Contains Valve Cover End Plug) Victo-Tech	VS30141	1
Valve Stem Seal, Exh.	1981-1982			B20215	6
Valve Stem Seal, Int.	1981-1982			B20211	6
Manifold Set, Exhaust	1981-1982			MS15527	1

Toyota

39 (cont.)	2759CC (2.8L) 5ME SOHC 6 Cyl, 3.268in./83mm (1981-1982)				39 (cont.)
----------------------	--	--	--	--	----------------------

Part	Year	VIN	Model/Application	Part Number	Qty.
ENGINE GASKETS (cont.)					
Manifold Set, Intake	1981-1982		(Contains Plenum Chamber Gasket)	MS15529	1
Plenum Chamber Gasket	1981-1982			MS12352	1
Oil Pan Set	1981-1982		<i>Cork Rubber</i>	OS30045	1
Rear Main Seal Set	1981-1982			JV635	1
Timing Cover Set	1981-1982			JV908	1

MISCELLANEOUS GASKETS					
E.G.R. Gasket	1981-1982		Valve	G26272	1
			Inlet	G26355	1
			Cooler	G31484	1
Exhaust Pipe Gasket	1981-1982		(Ring Type 'A'), Pipe To Manifold	F14592	1
Fuel Pump Gasket	1981-1982			D27094	2
Throttle Body Gasket	1981-1982			G30956	1
Valve Cover End Plug	1981-1982		(Half Round)	B45467	2
Water Outlet Gasket	1981-1982			C26085	1
Water Pump Cover Gasket	1981-1982			K30730	1
Water Pump Mount Gasket	1981-1982			K27443	1

40	2759CC (2.8L) 5MGE DOHC 6 Cyl, 3.268in./83mm (1982-1988)				40
-----------	---	--	--	--	-----------

Part	Year	VIN	Model/Application	Part Number	Qty.
ENGINE GASKETS					
Head Set	1984-1988			HS3990W	1
	1982-1983			HS3990	1
Full Set	1984-1988			FS3990W	1
	1982-1983			FS3990	1
Engine Kit Gasket Set	1982-1988			95-3279VR	1
Cylinder Head Gasket	1982-1988		<i>Nitroseal</i>	3990	1
Valve Cover Set	1982-1988		(Contains Valve Cover Washers, Complete Cam Carrier And Cover Set) <i>Victo-Tech</i>	VS38344	1
Valve Stem Seal, Exh.	1982-1988			B20219	6
Valve Stem Seal, Int.	1982-1988			B20219	6
Manifold Set, Exhaust	1982-1988			MS15339	1
Manifold Set, Intake	1982-1988		(Contains Plenum Chamber Gasket)	MS15542	1
Plenum Chamber Gasket	1982-1988			MS12350	1
Oil Pan Set	1982-1988		<i>Cork Rubber</i>	OS30045	1
Rear Main Seal Set	1982-1988			JV635	1
Timing Cover Set	1982-1988		(Camshaft Seals Not Included)	JV974	1

MISCELLANEOUS GASKETS						
Camshaft Seal	1982-1988			66859	2	
E.G.R. Gasket	1985-1988		Valve	G31489	1	
			Cooler	G31483	1	
	1982-1988		Inlet	G31490	1	
		1985		Thru 12/85, Inlet	G31490	1
		1984		Thru 7/84, Valve	G26265	1
				From 8/84, Valve	G31489	1
	1982-1983		Valve	G26265	1	
Exhaust Pipe Gasket	1982-1988		(Ring Type 'A'), Catalytic Converter To Exhaust Pipe, Front	F7461	1	
			(Ring Type 'A'), Pipe To Manifold	F14592	1	
			(Ring Type 'A'), Catalytic Converter To Exhaust Pipe, Rear	F20252	1	
Fuel Pump Gasket	1982-1988			D27094	2	
Throttle Body Gasket	1982-1988			G30957	1	
Water Outlet Gasket	1982-1988			C24095	1	

40 2759CC (2.8L) 5MGE DOHC 6 Cyl, 3.268in./83mm (1982-1988) **40**
(cont.) (cont.)

Part Year VIN Model/Application Part Number Qty.

MISCELLANEOUS GASKETS (cont.)

Water Pump Mount Gasket	1982-1988			K27387	1
-------------------------	-----------	--	--	--------	---

41 2954CC (3.0L) 7MGE DOHC 6 Cyl, 3.268in./83mm (1986-1993) **41**

Part Year VIN Model/Application Part Number Qty.

ENGINE GASKETS

Head Set	1986-1992			HS5769	1
Full Set	1986-1992		(Oil Pan Gasket Not Included)	FS5769	1
Engine Kit Gasket Set	1986-1993			95-3281VR	1
Cylinder Head Gasket	1986-1992			<i>Nitroseal</i> 5769	1
Valve Cover Set	1986-1992		(Contains Valve Cover Washers)	<i>Victo-Tech</i> VS50049	1
Valve Stem Seal, Exh.	1986-1992			B45657	12
Valve Stem Seal, Int.	1986-1992			B45657	12
Manifold Set, Exhaust	1986-1992			MS15339	1
Manifold Set, Intake	1986-1992		(Contains Plenum Chamber Gasket)	MS15972	1
Plenum Chamber Gasket	1986-1992			MS12366	1
Oil Pan Set	1986-1992			<i>Cork Rubber</i> OS30045	1
Rear Main Seal Set	1986-1992			JV635	1
Timing Cover Set	1986-1992		(Camshaft Seals Not Included)	JV1056	1

MISCELLANEOUS GASKETS

Camshaft Seal	1986-1991			66807	1
E.G.R. Gasket	1989-1992		Inlet	G31512	1
			Valve	G30803	1
			Cooler	G31482	1
Exhaust Pipe Gasket	1986-1992		(Ring Type 'A'), Catalytic Converter To Exhaust Pipe, Front	F7459	1
			(Ring Type 'A'), Catalytic Converter To Exhaust Pipe, Rear	F7460	1
			(Ring Type 'A'), Pipe To Manifold	F14592	1
Therm. Housing Gasket	1986-1992			C31012	1
Throttle Body Gasket	1986-1992			G30964	1
Water Outlet Gasket	1986-1992		(O-Ring Type)	<i>Victo-Tech</i> C26118	1
Water Pump Mount Gasket	1986-1992			K30802	1

42 2954CC (3.0L) 7MGTE DOHC Turbocharged 6 Cyl, 3.268in./83mm (1987-1993) **42**

Part Year VIN Model/Application Part Number Qty.

ENGINE GASKETS

Head Set	1987-1993			HS5769W	1
Full Set	1987-1993		(Oil Pan Gasket Not Included)	FS5769W	1
Engine Kit Gasket Set	1987-1993			95-3281VR	1
Cylinder Head Gasket	1987-1993			<i>Nitroseal</i> 5769	1
Valve Cover Set	1987-1993		(Contains Valve Cover Washers)	<i>Victo-Tech</i> VS50049	1
Valve Stem Seal, Exh.	1987-1993			B45657	12
Valve Stem Seal, Int.	1987-1993			B45657	12
Manifold Set, Exhaust	1987-1993			MS15339	1
Manifold Set, Intake	1987-1993		(Contains Plenum Chamber Gasket)	MS15972	1
Plenum Chamber Gasket	1987-1993			MS12366	1
Oil Pan Set	1987-1993			<i>Cork Rubber</i> OS30045	1
Rear Main Seal Set	1987-1993			JV635	1
Timing Cover Set	1987-1993		(Camshaft Seals Not Included)	JV1056	1

MISCELLANEOUS GASKETS

Camshaft Seal	1987-1991			66807	1
E.G.R. Gasket	1987-1992			G30803	1

Toyota

42 (cont.)	2954CC (3.0L) 7MGTE DOHC Turbocharged 6 Cyl, 3.268in./83mm (1987-1993)				42 (cont.)
----------------------	---	--	--	--	----------------------

Part	Year	VIN	Model/Application	Part Number	Qty.
MISCELLANEOUS GASKETS (cont.)					
Exhaust Pipe Gasket	1987-1993		(Ring Type 'A'), Catalytic Converter To Exhaust Pipe, Front	F7459	1
			(Ring Type 'A'), Catalytic Converter To Exhaust Pipe, Rear	F7460	1
			(Ring Type 'A'), Pipe To Manifold	F10038	1
Therm. Housing Gasket	1987-1993			C31012	1
Throttle Body Gasket	1987-1993			G30963	1
Turbo Mounting Set	1987-1993			GS33293	1
Water Outlet Gasket	1987-1993		(O-Ring Type) <i>Victo-Tech</i>	C26118	1
Water Pump Mount Gasket	1987-1993			K30802	1

43	2959CC (3.0L) 3VZFE DOHC V6 Cyl, 3.445in./87.5mm (1992-1993)				43
-----------	---	--	--	--	-----------

Part	Year	VIN	Model/Application	Part Number	Qty.
ENGINE GASKETS					
Head Set	1992-1993			HS5860	1
Lower Set	1992-1993		(Requires Head Set)	CS5860	1
Engine Kit Gasket Set	1992-1993			95-3459VR	1
Cylinder Head Gasket	1992-1993		Left <i>Nitroseal</i>	5859	1
			Right <i>Nitroseal</i>	5860	1
Cyl. Head Bolt Set	1992-1993			GS33353	2
Cyl. Head Washer Set	1992-1993		(Requires One Set Per Head)	GS33354	2
Valve Cover Set	1992-1993		(Contains Spark Plug Tube Seals) <i>Victo-Tech</i>	VS50158	1
Valve Stem Seal, Exh.	1992-1993			B45657	12
Valve Stem Seal, Int.	1992-1993			B45657	12
Manifold Set, Exhaust	1992-1993			MS16075	1
Manifold Set, Intake	1992-1993		(Contains Plenum Chamber Gasket)	MS16074	1
Plenum Chamber Gasket	1992-1993			MS16073	1
Oil Pan Set	1992-1993		<i>Cork Rubber</i>	OS32122	1
Rear Main Seal	1992-1993		<i>Rubber</i>	67120	1
Timing Cover Set	1992-1993		(Dust Seals Not Included, Camshaft Seals Not Included)	JV1145	1
			(Contains Dust Seals, Camshaft Seals Not Included)	JV1170	1
Timing Cover Seal	1992-1993			67010	1

MISCELLANEOUS GASKETS

Camshaft Seal	1992-1993			66905	2
E.G.R. Gasket	1992-1993		Valve	G31221	1
			Inlet	G31222	1
Exhaust Pipe Gasket	1992-1993		(Ring Type 'A'), Catalytic Converter To Exhaust Pipe	F7460	2
			(Ring Type 'A'), Pipe To Manifold	F20252	2
Fuel Inj. O-Ring	1992-1993			B45744	4
Therm. Housing Gasket	1992-1993			C31087	1
Thermostat O-Ring	1992-1993		(O-Ring Type) <i>Victo-Tech</i>	C31090	1
Throttle Body Gasket	1992-1993			G31085	1
Valve Cover Washer	1992-1993			B45809	16
Water Pump Mount Gasket	1992-1993			K31218	1

44	2995CC (3.0L) 1MZFE DOHC V6 Cyl, 3.445in./87.5mm (1994-2003)				44
-----------	---	--	--	--	-----------

Part	Year	VIN	Model/Application	Part Number	Qty.
ENGINE GASKETS					
Head Set	2001-2003		Camry, Solara	HS54336	1
	2002		Avalon, Thru 8/02	HS54339	1
	2001		Avalon	HS54339	1
	1994-2000			HS54339	1
Lower Set	1994-2003			CS54339	1

44
(cont.)

2995CC (3.0L) 1MZFE DOHC V6 Cyl, 3.445in./87.5mm (1994-2003)

44
(cont.)

Part	Year	VIN	Model/Application	Part Number	Qty.
ENGINE GASKETS (cont.)					
Cylinder Head Gasket	2001-2003		Camry, Solara, Left	Multi-Layered Steel 54336	1
			Camry, Solara, Right	Multi-Layered Steel 54337	1
	2002		Avalon, Thru 8/02, Left	Multi-Layered Steel 54338	1
			Avalon, Thru 8/02, Right	Multi-Layered Steel 54339	1
	2001		Avalon, Left	Multi-Layered Steel 54338	1
			Avalon, Right	Multi-Layered Steel 54339	1
1994-2000		Left	Multi-Layered Steel 54338	1	
		Right	Multi-Layered Steel 54339	1	
Valve Cover Set	1994-2003		(Contains Spark Plug Tube Seals)	VS50291	1
Manifold Set, Exhaust	1994-2003			Multi-Layered Steel MS16344	1
Manifold Set, Intake	1994-2003			MS16348	1
Plenum Chamber Gasket	1994-2003			MS16073	1
Oil Pan Set	1994-2003			Cork Rubber OS32237	1
	1994-1997		Original Equipment Uses RTV	Silicone JV6	1
Rear Main Seal Set	1994-2003			JV1655	1
Timing Cover Set	1994-2003			JV1145	1
Timing Cover Seal	1994-2003			67010	1

MISCELLANEOUS GASKETS

Camshaft Seal	1994-2003			66905	2
Camshaft Seal Set	1994-2003			JV5023	1
Exhaust Pipe Gasket	1996-2002		Pipe To Manifold	F7572	2
	1996		Catalytic Converter To Center Pipe, Inlet Pipe To Catalytic Converter	F7460	2
	1995-1996		Catalytic Converter To Center Pipe	F7460	1
	1995		From 8/94, Catalytic Converter To Center Pipe, Inlet Pipe To Catalytic Converter	F7460	2
			From 8/94, Pipe To Manifold	F7572	2
1994		Thru 8/94, Pipe To Manifold	F20252	2	
Fuel Inj. O-Ring	1994-2003			B45744	6
Fuel Injection Seal	2002-2003		(Grommet), Injector To Fuel Rail	B45854	1
	1994-2001		(Grommet), Injector To Fuel Rail	B45917	1
Thermostat O-Ring	1994-2003			Victo-Tech C31090	1
Throttle Body Gasket	1994-2003			G31624	1
Water Pump Mount Gasket	1994-2003			K31626	1

45

2997CC (3.0L) 2JZGE DOHC 6 Cyl, 3.386in./86mm (1993-1997)

45

Part	Year	VIN	Model/Application	Part Number	Qty.
ENGINE GASKETS					
Head Set	1993-1997			HS54034	1
Lower Set	1993-1997		(Requires Head Set To Make Full Set)	CS54034	1
Cylinder Head Gasket	1993-1997			Multi-Layered Steel 54034	1
Valve Cover Set	1993-1997			Victo-Tech VS50221	1
Valve Stem Seal, Exh.	1993-1997			B45549	12
Valve Stem Seal, Int.	1993-1997			B45549	12
Manifold Set, Exhaust	1993-1997			MS12444	1
Manifold Set, Intake	1993-1997		(Contains Plenum Chamber Gasket)	MS18568	1
Oil Pan Set	1993-1997		Original Equipment Uses RTV	Silicone JV6	1
Rear Main Seal Set	1993-1997			JV1625	1
Timing Cover Set	1993-1997		Lower	JV1190	1
			Upper	JV1191	1
Timing Cover Seal	1993-1997			67594	1
MISCELLANEOUS GASKETS					
Air Cleaner Mount Gasket	1993-1997		Multi-Port Fuel Injection	G31453	1

Toyota

45 (cont.)	2997CC (3.0L) 2JZGE DOHC 6 Cyl, 3.386in./86mm (1993-1997)	45 (cont.)
----------------------	--	----------------------

Part	Year	VIN	Model/Application	Part Number	Qty.
MISCELLANEOUS GASKETS (cont.)					
Camshaft Seal	1993-1997			67593	2
Dist. Mounting Gasket	1993-1997			B45833	1
E.G.R. Gasket	1993-1997		Cooler	G31451	1
			Valve	G31454	1
Exhaust Pipe Gasket	1993-1997		Pipe To Manifold	F10151	2
			(Ring Type 'A'), Center	F20252	2
			(Ring Type 'A'), Catalytic Converter To Exhaust Pipe	F20257	2
Fuel Inj. O-Ring	1993-1997			B45744	6
Therm. Housing Gasket	1993-1997			C31448	1
Thermostat O-Ring	1993-1997		<i>Victo-Tech</i>	C31090	1
Throttle Body Gasket	1993-1997			G31450	1
Water Outlet Gasket	1993-1997		Water By-Pass	C21447	1
Water Pump Mount Gasket	1993-1997			K31449	1

Triumph

Engine Index

Engine	Year	Block	Engine	Year	Block
1296CC (1.3L) 9.0 to 1 Compression	1967-1972	1	1998CC (2.0L) 9.5 to 1 Compression	1967-1970	5
1493CC (1.5L) 7.5 to 1 Compression	1973-1980	2	2138CC (2.1L) 9.0 to 1 Compression	1963-1967	6
1998CC (2.0L) 8.0 to 1 Compression	1975-1981	3	2498CC (2.5L) 7.5 to 1 Compression	1972-1976	7
1998CC (2.0L) 8.0 to 1 Compression	1971-1973	4	2498CC (2.5L) 8.6 to 1 Compression	1969-1976	8

Model Index

Model	Engine	Year	Block	Model	Engine	Year	Block
GT6	1998CC (2.0L) 8.0 to 1 Compression	1971-1973	4	TR4	2138CC (2.1L) 9.0 to 1 Compression	1962-1964	6
GT6	1998CC (2.0L) 9.5 to 1 Compression	1966-1970	5	TR4A	2138CC (2.1L) 9.0 to 1 Compression	1965-1967	6
Herald	1296CC (1.3L) 9.0 to 1 Compression	1966-1971	1	TR6	2498CC (2.5L) 7.5 to 1 Compression	1972-1976	7
Spitfire	1296CC (1.3L) 9.0 to 1 Compression	1968-1972	1	TR6	2498CC (2.5L) 8.6 to 1 Compression	1969-1976	8
Spitfire	1493CC (1.5L) 7.5 to 1 Compression	1973-1980	2	TR7	1998CC (2.0L) 8.0 to 1 Compression	1975-1981	3

1	1296CC (1.3L) 9.0 to 1 Compression 4 Cyl, 2.913in./74mm (1967-1972)	1
----------	--	----------

Part	Year	VIN	Model/Application	Part Number	Qty.
------	------	-----	-------------------	-------------	------

ENGINE GASKETS

Head Set	1971-1972		From Engine Serial Number FK250001	HS3622	1
Lower Set	1971-1972		From Engine Serial Number FK250001, (Requires Head Set And Timing Cover Set And Rear Main Seal To Make Full Set)	CS3622	1
Cylinder Head Gasket	1971-1972		From Engine Serial Number FK250001	3622	1
Valve Cover Set	1967-1972			VS30028	1
Manifold Set, Int. & Exh.	1967-1972			MS15235	1
Oil Pan Set	1971-1972		From Engine Serial Number FK250001 <i>Cork Rubber</i>	OS20064	1
Rear Main Seal	1967-1972		<i>Rubber</i>	66738	1
Timing Cover Set	1970-1972			JV947	1
Timing Cover Seal	1967-1970		Thru Engine Serial Number FK250000	46070	1

MISCELLANEOUS GASKETS

Water Outlet Gasket	1967-1972			C26651	1
Water Pump Mount Gasket	1967-1972			K31022	1

2 1493CC (1.5L) 7.5 to 1 Compression 4 Cyl, 2.913in./74mm (1973-1980) 2

<i>Part</i>	<i>Year</i>	<i>VIN</i>	<i>Model/Application</i>	<i>Part Number</i>	<i>Qty.</i>
ENGINE GASKETS					
Head Set	1975-1980			HS3622X	1
	1973-1974			HS3622	1
Lower Set	1973-1980		(Requires Head Set And Timing Cover Set And Rear Main Seal To Make Full Set)	CS3622	1
Cylinder Head Gasket	1973-1980			3622	1
Valve Cover Set	1973-1980			VS30028	1
Manifold Set, Int. & Exh.	1973-1980			MS15235	1
Oil Pan Set	1973-1980		Cork Rubber	OS20064	1
Rear Main Seal	1973-1980		Rubber	66738	1
Timing Cover Set	1973-1980			JV947	1

MISCELLANEOUS GASKETS

Fuel Pump Gasket	1975-1980			D20187	1
Water Outlet Gasket	1973-1980			C26651	1
Water Pump Mount Gasket	1975-1980			K31022	1
	1973-1974		.020" Thickness	K31023	1

3 1998CC (2.0L) 8.0 to 1 Compression 4 Cyl, 3.555in./90.3mm (1975-1981) 3

<i>Part</i>	<i>Year</i>	<i>VIN</i>	<i>Model/Application</i>	<i>Part Number</i>	<i>Qty.</i>
ENGINE GASKETS					
Head Set	1975-1981			HS3618	1
Manifold Set, Intake	1975-1981			MS15236	1
Rear Main Seal Set	1975-1981			JV642	1

MISCELLANEOUS GASKETS

Exhaust Pipe Gasket	1975-1981		(Flange Type), Pipe To Manifold	F20319	1
Fuel Pump Gasket	1975-1981			D20187	1
Water Outlet Gasket	1975-1981			C26651	1

4 1998CC (2.0L) 8.0 to 1 Compression 6 Cyl, 2.953in./75mm (1971-1973) 4

<i>Part</i>	<i>Year</i>	<i>VIN</i>	<i>Model/Application</i>	<i>Part Number</i>	<i>Qty.</i>
ENGINE GASKETS					
Valve Cover Set	1971-1973			VS30029	1
Manifold Set, Int. & Exh.	1971-1973			MS15256	1
Oil Pan Set	1971-1973			OS20065	1
Rear Main Seal	1971-1973		Rubber	66738	1
Timing Cover Seal	1971-1973			64579	1

MISCELLANEOUS GASKETS

Water Outlet Gasket	1971-1973			C26651	1
---------------------	-----------	--	--	--------	---

5 1998CC (2.0L) 9.5 to 1 Compression 6 Cyl, 2.953in./75mm (1967-1970) 5

<i>Part</i>	<i>Year</i>	<i>VIN</i>	<i>Model/Application</i>	<i>Part Number</i>	<i>Qty.</i>
ENGINE GASKETS					
Valve Cover Set	1967-1970			VS30029	1
Manifold Set, Int. & Exh.	1967-1970			MS15256	1
Oil Pan Set	1967-1970			OS20065	1
Rear Main Seal	1967-1970		Rubber	66738	1
Timing Cover Seal	1967-1970			64579	1

MISCELLANEOUS GASKETS

Water Outlet Gasket	1967-1970			C26651	1
---------------------	-----------	--	--	--------	---

Triumph

6 2138CC (2.1L) 9.0 to 1 Compression 4 Cyl, 3.386in./86mm (1963-1967) 6

Part	Year	VIN	Model/Application	Part Number	Qty.
ENGINE GASKETS					
Timing Cover Seal	1963-1967			47594	1

MISCELLANEOUS GASKETS

Water Outlet Gasket	1963-1967			C26651	1
---------------------	-----------	--	--	--------	---

7 2498CC (2.5L) 7.5 to 1 Compression 6 Cyl, 2.941in./74.7mm (1972-1976) 7

Part	Year	VIN	Model/Application	Part Number	Qty.
ENGINE GASKETS					

Head Set	1972-1976		From Engine Serial Number CC75001	HS3621	1
Valve Cover Set	1972-1976			VS30029	1
Manifold Set, Int. & Exh.	1972-1976		From Engine Serial Number CC75001	MS15256	1
Oil Pan Set	1972-1976			OS20065	1
Rear Main Seal	1972-1976		Rubber	66738	1
Timing Cover Seal	1972-1976			64579	1

MISCELLANEOUS GASKETS

Water Outlet Gasket	1972-1976			C26651	1
---------------------	-----------	--	--	--------	---

8 2498CC (2.5L) 8.6 to 1 Compression 6 Cyl, 2.941in./74.7mm (1969-1976) 8

Part	Year	VIN	Model/Application	Part Number	Qty.
ENGINE GASKETS					

Head Set	1971-1976		From Engine Serial Number CC75001	HS3621	1
Valve Cover Set	1969-1976			VS30029	1
Manifold Set, Int. & Exh.	1971-1976		From Engine Serial Number CC75001	MS15256	1
Oil Pan Set	1969-1976			OS20065	1
Rear Main Seal	1969-1976		Rubber	66738	1
Timing Cover Seal	1969-1976			64579	1

MISCELLANEOUS GASKETS

Water Outlet Gasket	1969-1976			C26651	1
---------------------	-----------	--	--	--------	---

Volkswagen

Engine Index

Engine	Year	Block	Engine	Year	Block
1285CC (1.3L) F	1966	1	1715CC (1.7L) EN	1981-1984	21
1457CC (1.5L) EH/FX	1978-1980	2	1715CC (1.7L) JF	1982-1984	22
1471CC (1.5L) CK Diesel	1977-1980	3	1715CC (1.7L) WT	1982-1983	23
1471CC (1.5L) FC/FG/XR/XS Gas	1974-1975	4	1780CC (1.8L) 2H/ABG/HT/PF/PG/RD/RV/UM	1985-1993	24
1471CC (1.5L) XV/XW/XY/XZ Gas	1974	5	1780CC (1.8L) GX (SOHC)	1985-1987	25
1493CC (1.5L) H	1967-1969	6	1780CC (1.8L) JH (SOHC)	1983-1989	26
1584CC (1.6L)	1966-1979	7	1780CC (1.8L) JN	1984-1990	27
1588CC (1.6L) CR Diesel	1981-1982	8	1780CC (1.8L) PL DOHC - 16 Valve	1986-1989	28
1588CC (1.6L) JK Diesel	1984	9	1795CC (1.8L) EC	1974	29
1588CC (1.6L) CY Turbo Diesel	1982-1984	10	1984CC (2.0L) 9A DOHC	1990-1994	30
1588CC (1.6L) EE	1977	11	1984CC (2.0L) ABA SOHC	1993-2002	31
1588CC (1.6L) EJ	1979-1980	12	1984CC (2.0L) AVH	2001-2003	32
1588CC (1.6L) FN	1976	13	1984CC (2.0L) AZG	2001-2003	33
1588CC (1.6L) MD Turbo Diesel	1985	14	1984CC (2.0L) AEG	1998-2001	34
1588CC (1.6L) ME Diesel	1985-1992	15	2144CC (2.2L) KM	1984	35
1588CC (1.6L) MF Turbo Diesel	1985-1986	16	2144CC (2.2L) WE	1983	36
1588CC (1.6L) YG	1976-1980	17	2226CC (2.2L) JT/KX	1985-1988	37
1588CC (1.6L) YH	1976-1980	18	2792CC (2.8L) AAA	1992-1999	38
1588CC (1.6L) YK	1976-1980	19			
1679CC (1.7L)	1971-1973	20			

Model Index

Model	Engine	Year	Block	Model	Engine	Year	Block
Beetle	1285CC (1.3L) F	1966	1	Beetle	1584CC (1.6L)	1970-1979	7
Beetle	1493CC (1.5L) H	1967-1969	6	Cabrio	1984CC (2.0L) ABA SOHC	1995-2002	31

Model Index (cont.)

Model	Engine	Year	Block	Model	Engine	Year	Block
Cabriolet	1780CC (1.8L) 2H/ABG/HT/PF/PG/RD/RV/UM	1990-1993	24	Karmann	1493CC (1.5L) H	1967-1969	6
Cabriolet	1780CC (1.8L) JH (SOHC)	1984-1989	26	Ghia			
Corrado	1780CC (1.8L) 2H/ABG/HT/PF/PG/RD/RV/UM	1990-1992	24	Karmann	1584CC (1.6L)	1970-1974	7
Corrado	2792CC (2.8L) AAA	1992-1995	38	Ghia			
Dasher	1471CC (1.5L) CK Diesel	1979-1980	3	New Beetle	1984CC (2.0L) AVH	2001-2003	32
Dasher	1471CC (1.5L) FC/FG/XR/XS Gas	1975	4	New Beetle	1984CC (2.0L) AZG	2001-2003	33
Dasher	1471CC (1.5L) XV/XW/XY/XZ Gas	1974	5	New Beetle	1984CC (2.0L) AEG	1998-2001	34
Dasher	1588CC (1.6L) CR Diesel	1981	8	Passat	1780CC (1.8L) 2H/ABG/HT/PF/PG/RD/RV/UM	1991-1993	24
Dasher	1588CC (1.6L) YG	1976-1980	17	Passat	1984CC (2.0L) ABA SOHC	1995-1997	31
Dasher	1588CC (1.6L) YH	1976-1980	18	Passat	1984CC (2.0L) 9A DOHC	1990-1994	30
Dasher	1588CC (1.6L) YK	1976-1980	19	Passat	2792CC (2.8L) AAA	1992-1997	38
Fox	1780CC (1.8L) 2H/ABG/HT/PF/PG/RD/RV/UM	1987-1993	24	Quantum	1588CC (1.6L) MD Turbo Diesel	1985	14
Fox	1780CC (1.8L) JN	1986-1990	27	Quantum	1588CC (1.6L) CY Turbo Diesel	1982-1984	10
GTI	1984CC (2.0L) AEG	1999-2000	34	Quantum	1715CC (1.7L) WT	1982-1983	23
Golf	1588CC (1.6L) ME Diesel	1985-1986	15	Quantum	1780CC (1.8L) JN	1984-1985	27
Golf	1780CC (1.8L) PL DOHC - 16 Valve	1987-1989	28	Quantum	2144CC (2.2L) KM	1984	35
Golf	1780CC (1.8L) GX (SOHC)	1985-1986	25	Quantum	2144CC (2.2L) WE	1983	36
Golf	1780CC (1.8L) 2H/ABG/HT/PF/PG/RD/RV/UM	1985-1992	24	Quantum	2226CC (2.2L) JT/KX	1985-1988	37
Golf	1984CC (2.0L) AVH	2001-2003	32	Rabbit	1457CC (1.5L) EH/FX	1978-1979	2
Golf	1984CC (2.0L) AZG	2001-2003	33	Rabbit	1471CC (1.5L) CK Diesel	1977-1980	3
Golf	1984CC (2.0L) AEG	1999-2001	34	Rabbit	1471CC (1.5L) FC/FG/XR/XS Gas	1975	4
Golf	1984CC (2.0L) ABA SOHC	1993-1999	31	Rabbit	1588CC (1.6L) JK Diesel	1984	9
Golf	1984CC (2.0L) 9A DOHC	1990-1992	30	Rabbit	1588CC (1.6L) CY Turbo Diesel	1982-1984	10
Golf	2792CC (2.8L) AAA	1995-1998	38	Rabbit	1588CC (1.6L) CR Diesel	1981-1982	8
Jetta	1457CC (1.5L) EH/FX	1980	2	Rabbit	1588CC (1.6L) EJ	1980	12
Jetta	1588CC (1.6L) ME Diesel	1985-1992	15	Rabbit	1588CC (1.6L) EE	1977	11
Jetta	1588CC (1.6L) MF Turbo Diesel	1985-1986	16	Rabbit	1588CC (1.6L) FN	1976	13
Jetta	1588CC (1.6L) JK Diesel	1984	9	Rabbit	1715CC (1.7L) JF	1982-1984	22
Jetta	1588CC (1.6L) CY Turbo Diesel	1982-1984	10	Rabbit	1715CC (1.7L) EN	1981-1984	21
Jetta	1588CC (1.6L) CR Diesel	1981-1982	8	Rabbit	1780CC (1.8L) JH (SOHC)	1983-1984	26
Jetta	1588CC (1.6L) EJ	1980	12	Scirocco	1457CC (1.5L) EH/FX	1978	2
Jetta	1715CC (1.7L) EN	1981-1984	21	Scirocco	1471CC (1.5L) FC/FG/XR/XS Gas	1974-1975	4
Jetta	1780CC (1.8L) PL DOHC - 16 Valve	1987-1989	28	Scirocco	1588CC (1.6L) EJ	1979-1980	12
Jetta	1780CC (1.8L) GX (SOHC)	1985-1987	25	Scirocco	1588CC (1.6L) EE	1977	11
Jetta	1780CC (1.8L) 2H/ABG/HT/PF/PG/RD/RV/UM	1985-1992	24	Scirocco	1588CC (1.6L) FN	1976	13
Jetta	1780CC (1.8L) JH (SOHC)	1984	26	Scirocco	1715CC (1.7L) EN	1981-1983	21
Jetta	1984CC (2.0L) AVH	2001-2003	32	Scirocco	1780CC (1.8L) PL DOHC - 16 Valve	1986-1988	28
Jetta	1984CC (2.0L) AZG	2001-2003	33	Scirocco	1780CC (1.8L) JH (SOHC)	1983-1988	26
Jetta	1984CC (2.0L) AEG	1999-2001	34	Super Beetle	1584CC (1.6L)	1971-1974	7
Jetta	1984CC (2.0L) ABA SOHC	1993-1998	31	Thing	1584CC (1.6L)	1973-1974	7
Jetta	1984CC (2.0L) 9A DOHC	1990-1992	30	Type 3 (Fastback/ Squareback)	1584CC (1.6L)	1966-1973	7
Jetta	2792CC (2.8L) AAA	1993-1999	38	Type 4	1679CC (1.7L)	1971-1972	20
Karmann	1285CC (1.3L) F	1966	1	Type 4	1795CC (1.8L) EC	1973-1974	29
Ghia							

1 1285CC (1.3L) F 4 Cyl, 3.031in./77mm (1966) 1

Part	Year	VIN	Model/Application	Part Number	Qty.
ENGINE GASKETS					
Full Set	1966			FS3574	1
Valve Cover Set	1966			Cork Rubber VS30003	1
Valve Stem Seal, Exh.	1966			B45429	4
Valve Stem Seal, Int.	1966			B45429	4
Manifold Set, Exhaust	1966			F14591	4
Manifold Set, Intake	1966			MS10099	1
Rear Main Seal Set	1966			Rubber JV629	1
MISCELLANEOUS GASKETS					
Carb. Mount Gasket	1966		1 Barrel Carburetor	G20102	1

Volkswagen

1 (cont.)	1285CC (1.3L) F 4 Cyl, 3.031in./77mm (1966)				1 (cont.)
---------------------	--	--	--	--	---------------------

Part	Year	VIN	Model/Application	Part Number	Qty.
MISCELLANEOUS GASKETS (cont.)					
Cylinder Base Gasket	1966			3578	4
Exhaust Pipe Gasket	1966		(Ring Type 'C'), Muffler To Tailpipe	F7274	1
			(Flange Type), Pipe To Manifold	F14591	1
Oil Cooler Mount Grommet	1966			H20095	2
Oil Cooler Sealing Kit	1966			OS30099	1
Oil Strainer Gasket Set	1966			OS20098	1
Push Rod Tube Seal	1966			B45427	16

2	1457CC (1.5L) EH/FX 4 Cyl, 3.130in./79.5mm (1978-1980)				2
----------	---	--	--	--	----------

Part	Year	VIN	Model/Application	Part Number	Qty.
ENGINE GASKETS					
Head Set	1978-1980			HS3609	1
Full Set	1978-1980			FS3609	1
Engine Kit Gasket Set	1978-1980			95-3095VR	1
Cylinder Head Gasket	1978-1980		VR2000	3609	1
Cyl. Head Spacer Shim	1978-1980		Requires Sealing Compound Steel	3609S	1
Sealing Compound	1978-1980		(4 Ounce Brush Top Can)	JV66B	1
			(12 Ounce Spray Can)	JV66S	1
Valve Cover Set	1978-1980		(Contains Valve Cover End Plug) Cork Rubber	VS30024	1
			(Contains Valve Cover End Plug) Tuff-Cork	VS30024TC	1
Valve Stem Seal, Exh.	1978-1980		Teflon	B45423	4
			Fluoroelastomer	B45546	4
Valve Stem Seal, Int.	1978-1980		Teflon	B45423	4
			Fluoroelastomer	B45546	4
Manifold Set, Exhaust	1978-1980		To Be Replaced By MS12375	MS10030W	1
				MS12375	1
Manifold Set, Intake	1978-1980			MS12278	1
Oil Pan Set	1978-1980		Victo-Tech	OS20056	1
Rear Main Seal Set	1978-1980			JV644	1
Timing Cover Set	1978-1980			JV982	1
Timing Cover Seal	1978-1980			66960	1

MISCELLANEOUS GASKETS					
Camshaft Seal	1978-1980		Front	66960	1
Cam. Semi-Circular Plug	1978-1980		Rear	B45453	1
Carb. Mount Gasket	1978-1980		1 Barrel Carburetor	G26834	1
Dist. Mounting Gasket	1978-1980			B25941	1
E.G.R. Gasket	1978-1980			G20270	1
Exhaust Pipe Gasket	1978-1980		(Flange Type), Pipe To Manifold	F14603	1
			(Flange Type), Center, Pipe To Manifold	F14604	1
Fuel Pump Gasket	1978-1980			D24097	1
Intermediate Shaft Set	1978-1980			JV983	1
Oil Cooler Mount Grommet	1978-1980			B45793	4
Oil Cooler Sealing Kit	1978-1980			OS30099	1
Water Outlet Gasket	1978-1980		Victo-Tech	C20119	1
Water Pump Hsg. O-Ring	1978-1980		Pump To Block		
			Victo-Tech	C20119	1
Water Pump Mount Gasket	1978-1980			K20118	1

3 1471CC (1.5L) CK Diesel 4 Cyl, 3.012in./76.5mm (1977-1980)**3**

Part	Year	VIN	Model/Application	Part Number	Qty.
ENGINE GASKETS					
Head Set	1977-1980		(Head Gasket Not Included, Thickness Is Identified By Groove In Edge Of Gasket, Replacement Gasket Must Be Of Same Thickness As One Removed)	HS3664W	1
Full Set	1977-1980		(Head Gasket Not Included, Thickness Is Identified By Groove In Edge Of Gasket, Replacement Gasket Must Be Of Same Thickness As One Removed)	FS3664W	1
Cylinder Head Gasket	1977-1980		(3 Grooves) 1.4mm Thickness	3664	1
			(5 Grooves) 1.6mm Thickness	3665	1
			(4 Grooves) 1.5mm Thickness	3669	1
Valve Cover Set	1977-1980		(Contains Valve Cover End Plug) Cork Rubber	VS30024	1
			(Contains Valve Cover End Plug) Tuff-Cork	VS30024TC	1
Valve Stem Seal, Exh.	1977-1980		Teflon	B45423	4
			Fluoroelastomer	B45546	4
Valve Stem Seal, Int.	1977-1980		Teflon	B45423	4
			Fluoroelastomer	B45546	4
Manifold Set, Exhaust	1977-1980		To Be Replaced By MS12375	MS10030W	1
				MS12375	1
Manifold Set, Intake	1977-1980			MS12278	1
Oil Pan Set	1977-1980		Victo-Tech	OS20056	1
Rear Main Seal Set	1977-1980			JV567	1
Timing Cover Set	1977-1980			JV982	1
Timing Cover Seal	1977-1980			66960	1

MISCELLANEOUS GASKETS

Camshaft Seal	1977-1980		Front	66960	1
Cam. Semi-Circular Plug	1977-1980		Rear	B45453	1
E.G.R. Gasket	1979-1980		Dasher	G20269	1
	1977-1980		Rabbit	G20270	1
Exhaust Pipe Gasket	1977-1980		(Flange Type), Pipe To Manifold	F14603	1
Intermediate Shaft Set	1977-1980			JV983	1
Oil Cooler Mount Grommet	1977-1980			B45793	4
Oil Cooler Sealing Kit	1977-1980			OS30099	1
Water Outlet Gasket	1977-1980		Victo-Tech	C20119	1
Water Pump Hsg. O-Ring	1977-1980		Pump To Block Victo-Tech	C20119	1
Water Pump Mount Gasket	1977-1980			K20118	1

4 1471CC (1.5L) FC/FG/XR/XS Gas 4 Cyl, 3.012in./76.5mm (1974-1975)**4**

Part	Year	VIN	Model/Application	Part Number	Qty.
ENGINE GASKETS					
Head Set	1974-1975			HS3608	1
Full Set	1974-1975		(Requires Rear Main Seal After 10/74)	FS3608	1
Cylinder Head Gasket	1974-1975		VR2000	3608	1
Valve Cover Set	1974-1975		(Contains Valve Cover End Plug) Cork Rubber	VS30024	1
			(Contains Valve Cover End Plug) Tuff-Cork	VS30024TC	1
Valve Stem Seal, Exh.	1974-1975		Teflon	B45423	4
			Fluoroelastomer	B45546	4
Valve Stem Seal, Int.	1974-1975		Teflon	B45423	4
			Fluoroelastomer	B45546	4
Manifold Set, Exhaust	1974-1975		To Be Replaced By MS12375	MS10030W	1
				MS12375	1
Manifold Set, Intake	1974-1975			MS12278	1
Oil Pan Set	1974-1975		Victo-Tech	OS20056	1
Rear Main Seal Set	1974-1975			JV644	1
	1974		Thru 9/74	JV643	1
Timing Cover Set	1974-1975			JV982	1

Volkswagen

4 (cont.)	1471CC (1.5L) FC/FG/XR/XS Gas 4 Cyl, 3.012in./76.5mm (1974-1975)				4 (cont.)
--------------	--	--	--	--	--------------

Part	Year	VIN	Model/Application	Part Number	Qty.
------	------	-----	-------------------	-------------	------

ENGINE GASKETS (cont.)

Timing Cover Seal	1974-1975			66960	1
-------------------	-----------	--	--	-------	---

MISCELLANEOUS GASKETS

Camshaft Seal	1974-1975		Front	66960	1
Cam. Semi-Circular Plug	1974-1975		Rear	B45453	1
Carb. Mount Gasket	1974-1975		2 Barrel Carburetor	G26834	1
Dist. Mounting Gasket	1974-1975			B25941	1
E.G.R. Gasket	1974-1975			G20270	1
Exhaust Pipe Gasket	1974-1975		(Flange Type), Pipe To Manifold	F14603	1
			(Flange Type), Pipe To Center	F14604	1
Fuel Pump Gasket	1974-1975			D24097	2
Intermediate Shaft Set	1974-1975			JV983	1
Oil Cooler Mount Grommet	1974-1975			B45793	4
Oil Cooler Sealing Kit	1974-1975			OS30099	1
Water Outlet Gasket	1974-1975		<i>Victo-Tech</i>	C20119	1
Water Pump Hsg. O-Ring	1974-1975		Pump To Block	<i>Victo-Tech</i> C20119	1
Water Pump Mount Gasket	1974-1975			K20118	1

5	1471CC (1.5L) XV/XW/XY/XZ Gas 4 Cyl, 3.012in./76.5mm (1974)				5
---	---	--	--	--	---

Part	Year	VIN	Model/Application	Part Number	Qty.
------	------	-----	-------------------	-------------	------

ENGINE GASKETS

Head Set	1974			HS3608	1
Full Set	1974		(Requires Rear Main Seal After 10/74)	FS3608	1
Cylinder Head Gasket	1974		<i>VR2000</i>	3608	1
Valve Cover Set	1974		(Contains Valve Cover End Plug) <i>Cork Rubber</i>	VS30024	1
			(Contains Valve Cover End Plug) <i>Tuff-Cork</i>	VS30024TC	1
Valve Stem Seal, Exh.	1974		<i>Teflon</i>	B45423	4
			<i>Fluoroelastomer</i>	B45546	4
Valve Stem Seal, Int.	1974		<i>Teflon</i>	B45423	4
			<i>Fluoroelastomer</i>	B45546	4
Manifold Set, Exhaust	1974		To Be Replaced By MS12375	MS10030W	1
				MS12375	1
Manifold Set, Intake	1974			MS12278	1
Oil Pan Set	1974		<i>Victo-Tech</i>	OS20056	1
Rear Main Seal Set	1974		Thru 9/74	JV643	1
			From 10/74	JV644	1
Timing Cover Set	1974			JV982	1
Timing Cover Seal	1974			66960	1

MISCELLANEOUS GASKETS

Camshaft Seal	1974		Front	66960	1
Cam. Semi-Circular Plug	1974		Rear	B45453	1
Carb. Mount Gasket	1974		2 Barrel Carburetor	G26834	1
Dist. Mounting Gasket	1974			B25941	1
E.G.R. Gasket	1974			G20270	1
Exhaust Pipe Gasket	1974		(Flange Type), Pipe To Manifold	F14603	1
			(Flange Type), Pipe To Center	F14604	1
Fuel Pump Gasket	1974			D24097	2
Intermediate Shaft Set	1974			JV983	1
Oil Cooler Mount Grommet	1974			B45793	4
Oil Cooler Sealing Kit	1974			OS30099	1
Water Outlet Gasket	1974		<i>Victo-Tech</i>	C20119	1

5 1471CC (1.5L) XV/XW/XY/XZ Gas 4 Cyl, 3.012in./76.5mm (1974) **5**
(cont.) (cont.)

Part	Year	VIN	Model/Application	Part Number	Qty.
MISCELLANEOUS GASKETS (cont.)					
Water Pump Hsg. O-Ring	1974		Pump To Block <i>Victo-Tech</i>	C20119	1
Water Pump Mount Gasket	1974			K20118	1

6 1493CC (1.5L) H 4 Cyl, 3.268in./83mm (1967-1969) **6**

Part	Year	VIN	Model/Application	Part Number	Qty.
ENGINE GASKETS					
Full Set	1967-1969			FS3574	1
Valve Cover Set	1967-1969		<i>Cork Rubber</i>	VS30003	1
Valve Stem Seal, Exh.	1967-1969			B45429	4
Valve Stem Seal, Int.	1967-1969			B45429	4
Manifold Set, Exhaust	1967-1969			F14591	4
Manifold Set, Intake	1967-1969			MS10099	1
Rear Main Seal Set	1967-1969		<i>Rubber</i>	JV629	1

MISCELLANEOUS GASKETS					
Bearing Cover Oil Ring	1967-1969		Rear Axle	B45426	1
Carb. Mount Gasket	1967-1969		1 Barrel Carburetor	G20102	1
Cylinder Base Gasket	1967-1969			3578	4
Exhaust Pipe Gasket	1967-1969		(Ring Type 'C'), Muffler To Tailpipe	F7274	1
			(Flange Type), Pipe To Manifold	F14591	1
Oil Cooler Mount Grommet	1967-1969			H20095	2
Oil Cooler Sealing Kit	1967-1969			OS30099	1
Oil Strainer Gasket Set	1967-1969			OS20098	1
Push Rod Tube Seal	1967-1969			B45427	16

7 1584CC (1.6L) 4 Cyl, 3.366in./85.5mm (1966-1979) **7**

Part	Year	VIN	Model/Application	Part Number	Qty.
ENGINE GASKETS					
Full Set	1966-1979		(Intake Manifold Gasket For Fuel Injected Engine Not Included)	FS3574	1
Valve Cover Set	1966-1979		<i>Cork Rubber</i>	VS30003	1
Valve Stem Seal, Exh.	1966-1979			B45429	4
Valve Stem Seal, Int.	1966-1979			B45429	4
Manifold Set, Exhaust	1966-1979			F14591	4
Manifold Set, Intake	1975-1979		Electronic Fuel Injection	MS15264	1
	1970-1974		1 Barrel Carburetor	MS10099	1
	1968-1973		Electronic Fuel Injection	MS15264	1
	1966-1967		1 Barrel Carburetor	MS10099	1
Rear Main Seal Set	1966-1979		<i>Rubber</i>	JV629	1

MISCELLANEOUS GASKETS					
Bearing Cover Oil Ring	1970-1977			B45426	1
Carb. Mount Gasket	1970		1 Barrel Carburetor	G20102	1
	1966-1967		1 Barrel Carburetor	G20102	1
Cylinder Base Gasket	1966-1979			3578	4
Exhaust Pipe Gasket	1975-1979		(Flange Type), Pipe To Manifold	F12327	1
	1966-1979		(Ring Type 'C'), Muffler To Tailpipe	F7274	1
	1966-1974		(Flange Type), Pipe To Manifold	F14591	1
Oil Cooler Mount Grommet	1970-1979			B45793	4
	1966-1969			H20095	2
Oil Cooler Sealing Kit	1968-1979			OS30099	1
Oil Strainer Gasket Set	1966-1979			OS20098	1

Volkswagen

7 (cont.)	1584CC (1.6L) 4 Cyl, 3.366in./85.5mm (1966-1979)				7 (cont.)
---------------------	---	--	--	--	---------------------

<i>Part</i>	<i>Year</i>	<i>VIN</i>	<i>Model/Application</i>	<i>Part Number</i>	<i>Qty.</i>
-------------	-------------	------------	--------------------------	--------------------	-------------

MISCELLANEOUS GASKETS (cont.)

Push Rod Tube Seal	1966-1979			B45427	16
--------------------	-----------	--	--	--------	----

8	1588CC (1.6L) CR Diesel 4 Cyl, 3.012in./76.5mm (1981-1982)				8
----------	---	--	--	--	----------

<i>Part</i>	<i>Year</i>	<i>VIN</i>	<i>Model/Application</i>	<i>Part Number</i>	<i>Qty.</i>
-------------	-------------	------------	--------------------------	--------------------	-------------

ENGINE GASKETS

Head Set	1981-1982		Jetta, Rabbit, (Head Gasket Not Included, Thickness Is Identified By Groove In Edge Of Gasket, Replacement Gasket Must Be Of Same Thickness As One Removed)	HS3664W	1
	1981		Dasher, (Head Gasket Not Included, Thickness Is Identified By Groove In Edge Of Gasket, Replacement Gasket Must Be Of Same Thickness As One Removed)	HS3664W	1
Full Set	1981-1982		Jetta, Rabbit, (Head Gasket Not Included, Thickness Is Identified By Groove In Edge Of Gasket, Replacement Gasket Must Be Of Same Thickness As One Removed)	FS3664W	1
	1981		Dasher, (Head Gasket Not Included, Thickness Is Identified By Groove In Edge Of Gasket, Replacement Gasket Must Be Of Same Thickness As One Removed)	FS3664W	1
Cylinder Head Gasket	1981-1982		Jetta, Rabbit, 11.5mm Head Bolt Diameter, (1 Groove) <i>1.4mm Thickness</i>	3728	1
			Jetta, Rabbit, 11.5mm Head Bolt Diameter, (2 Grooves) <i>1.5mm Thickness</i>	3729	1
			Jetta, Rabbit, 11.5mm Head Bolt Diameter, (3 Grooves) <i>1.6mm Thickness</i>	3730	1
			Jetta, Rabbit, 12.5mm Head Bolt Diameter, (2 Grooves) <i>1.5mm Thickness</i>	3765	1
			Jetta, Rabbit, 12.5mm Head Bolt Diameter, (3 Grooves) <i>1.6mm Thickness</i>	3766	1
			Jetta, Rabbit, 12.5mm Head Bolt Diameter, (1 Groove) <i>1.4mm Thickness</i>	5763	1
	1981		Dasher, 11.5mm Head Bolt Diameter, (1 Groove) <i>1.4mm Thickness</i>	3728	1
			Dasher, 11.5mm Head Bolt Diameter, (2 Grooves) <i>1.5mm Thickness</i>	3729	1
			Dasher, 11.5mm Head Bolt Diameter, (3 Grooves) <i>1.6mm Thickness</i>	3730	1
Valve Cover Set	1981-1982		Jetta, Rabbit, (Contains Valve Cover End Plug) <i>Cork Rubber</i>	VS30024	1
			Jetta, Rabbit, (Contains Valve Cover End Plug) <i>Tuff-Cork</i>	VS30024TC	1
	1981		Dasher, (Contains Valve Cover End Plug) <i>Cork Rubber</i>	VS30024	1
Valve Stem Seal, Exh.	1982		Rabbit <i>Fluoroelastomer</i>	B45546	4
	1981-1982		Jetta <i>Fluoroelastomer</i>	B45546	4
Valve Stem Seal, Int.	1982		Rabbit <i>Fluoroelastomer</i>	B45546	4
	1981-1982		Jetta <i>Fluoroelastomer</i>	B45546	4
Manifold Set, Exhaust	1981-1982		Jetta, Rabbit, To Be Replaced By MS12375	MS10030W	1
			Jetta, Rabbit	MS12375	1
	1981		Dasher, To Be Replaced By MS12375	MS10030W	1
			Dasher	MS12375	1
Manifold Set, Intake	1981-1982		Jetta, Rabbit	MS12278	1
	1981		Dasher	MS12278	1
Oil Pan Set	1981-1982		Jetta, Rabbit <i>Victo-Tech</i>	OS20056	1
	1981		Dasher <i>Victo-Tech</i>	OS20056	1
Rear Main Seal Set	1981-1982		Jetta, Rabbit	JV567	1
	1981		Dasher	JV567	1
Timing Cover Set	1981-1982		Jetta, Rabbit	JV982	1
	1981		Dasher	JV982	1
Timing Cover Seal	1981-1982		Jetta, Rabbit	66960	1
	1981		Dasher	66960	1

MISCELLANEOUS GASKETS

Camshaft Seal	1981-1982		Rabbit, Front	66960	1
---------------	-----------	--	---------------	-------	---

8 1588CC (1.6L) CR Diesel 4 Cyl, 3.012in./76.5mm (1981-1982) **8**
(cont.) (cont.)

Part	Year	VIN	Model/Application	Part Number	Qty.
MISCELLANEOUS GASKETS (cont.)					
Camshaft Seal (cont.)	1981-1982		Rabbit	66960	1
	1981		Dasher, Front	66960	1
Cam. Semi-Circular Plug	1981-1982		Rabbit, Rear	B45453	1
	1981		Dasher, Rear	B45453	1
E.G.R. Gasket	1981-1982		Rabbit	G20270	1
	1981		Dasher	G20269	1
Exhaust Pipe Gasket	1982		Jetta, Rabbit, (Flange Type), Pipe To Manifold	F7426	1
			Jetta, Rabbit, (Ring Type 'F'), Pipe To Manifold	F7442	1
	1981		Dasher, Jetta, Rabbit, (Flange Type), Pipe To Manifold	F14604	1
Intermediate Shaft Set	1981-1982		Jetta, Rabbit	JV983	1
	1981		Dasher	JV983	1
Water Outlet Gasket	1981-1982		Jetta, Rabbit <i>Victo-Tech</i>	C20119	1
	1981		Dasher <i>Victo-Tech</i>	C20119	1
Water Pump Hsg. O-Ring	1981-1982		Rabbit, Pump To Block <i>Victo-Tech</i>	C20119	1
	1981		Dasher, Pump To Block <i>Victo-Tech</i>	C20119	1
Water Pump Mount Gasket	1981-1982		Jetta, Rabbit	K20118	1
	1981		Dasher	K20118	1

9 1588CC (1.6L) JK Diesel 4 Cyl, 3.012in./76.5mm (1984) **9**

Part	Year	VIN	Model/Application	Part Number	Qty.
------	------	-----	-------------------	-------------	------

ENGINE GASKETS

Head Set	1984		Jetta, Rabbit, (Head Gasket Not Included, Thickness Is Identified By Groove In Edge Of Gasket, Replacement Gasket Must Be Of Same Thickness As One Removed)	HS3664W	1
			Jetta, Rabbit, Engines With Mechanical Lifters, (Head Gasket Not Included, Thickness Is Identified By Groove In Edge Of Gasket, Replacement Gasket Must Be Of Same Thickness As One Removed)	HS3664W	1
Full Set	1984		Jetta, Rabbit, (Head Gasket Not Included, Thickness Is Identified By Groove In Edge Of Gasket, Replacement Gasket Must Be Of Same Thickness As One Removed)	FS3664W	1
Cylinder Head Gasket	1984		Jetta, Rabbit, (2 Grooves) <i>1.5mm Thickness</i>	3765	1
			Jetta, Rabbit, 12.5mm Head Bolt Diameter, (2 Grooves) <i>1.5mm Thickness</i>	3765	1
			Jetta, Rabbit, (3 Grooves) <i>1.6mm Thickness</i>	3766	1
			Jetta, Rabbit, 12.5mm Head Bolt Diameter, (3 Grooves) <i>1.6mm Thickness</i>	3766	1
			Jetta, Rabbit, (1 Groove) <i>1.4mm Thickness</i>	5763	1
			Jetta, Rabbit, 12.5mm Head Bolt Diameter, (1 Groove) <i>1.4mm Thickness</i>	5763	1
Valve Cover Set	1984		Jetta, Rabbit, (Contains Valve Cover End Plug) <i>Cork Rubber</i>	VS30024	1
			Jetta, Rabbit, (Contains Valve Cover End Plug) <i>Tuff-Cork</i>	VS30024TC	1
Valve Stem Seal, Exh.	1984		Jetta, Rabbit <i>Fluoroelastomer</i>	B45546	4
Valve Stem Seal, Int.	1984		Jetta, Rabbit <i>Fluoroelastomer</i>	B45546	4
Manifold Set, Exhaust	1984		Jetta, Rabbit, To Be Replaced By MS12375	MS10030W	1
			Jetta, Rabbit	MS12375	1
Manifold Set, Intake	1984		Jetta, Rabbit	MS12278	1
Oil Pan Set	1984		Jetta, Rabbit <i>Victo-Tech</i>	OS20056	1
Rear Main Seal Set	1984		Jetta, Rabbit	JV567	1
Timing Cover Set	1984		Jetta, Rabbit	JV982	1
Timing Cover Seal	1984		Jetta, Rabbit	66960	1

MISCELLANEOUS GASKETS

Camshaft Seal	1984		Jetta, Rabbit, Front	66960	1
---------------	------	--	----------------------	-------	---

Volkswagen

9 (cont.)	1588CC (1.6L) JK Diesel 4 Cyl, 3.012in./76.5mm (1984)				9 (cont.)
---------------------	--	--	--	--	---------------------

Part	Year	VIN	Model/Application	Part Number	Qty.
------	------	-----	-------------------	-------------	------

MISCELLANEOUS GASKETS (cont.)

Cam. Semi-Circular Plug	1984		Jetta, Rabbit, Rear	B45453	1
Exhaust Pipe Gasket	1984		Jetta, Rabbit, (Flange Type), Pipe To Manifold	F7426	1
			Jetta, Rabbit, (Ring Type 'F'), Pipe To Manifold	F7442	1
Intermediate Shaft Set	1984		Jetta, Rabbit	JV983	1
Water Outlet Gasket	1984		Jetta, Rabbit <i>Victo-Tech</i>	C20119	1
Water Pump Hsg. O-Ring	1984		Jetta <i>Rubber</i>	C20119	1
Water Pump Mount Gasket	1984		Jetta, Rabbit	K20118	1

10	1588CC (1.6L) CY Turbo Diesel 4 Cyl, 3.130in./79.5mm (1982-1984)				10
-----------	---	--	--	--	-----------

Part	Year	VIN	Model/Application	Part Number	Qty.
------	------	-----	-------------------	-------------	------

ENGINE GASKETS

Head Set	1983-1984		Jetta, Quantum, Rabbit, (Head Gasket Not Included, Thickness Is Identified By Groove In Edge Of Gasket, Replacement Gasket Must Be Of Same Thickness As One Removed)	HS3664W	1		
Full Set	1983-1984		Jetta, Quantum, Rabbit, (Head Gasket Not Included, Thickness Is Identified By Groove In Edge Of Gasket, Replacement Gasket Must Be Of Same Thickness As One Removed)	FS3664W	1		
Cylinder Head Gasket	1984		Jetta, (2 Grooves) <i>1.5mm Thickness</i>	3765	1		
			Jetta, (3 Grooves) <i>1.6mm Thickness</i>	3766	1		
			Jetta, (1 Groove) <i>1.4mm Thickness</i>	5763	1		
	1983-1984		Quantum, Rabbit, (2 Grooves) <i>1.5mm Thickness</i>	3765	1		
			Quantum, Rabbit, (3 Grooves) <i>1.6mm Thickness</i>	3766	1		
			Quantum, Rabbit, (1 Groove) <i>1.4mm Thickness</i>	5763	1		
	1982-1984		Jetta, 11.5mm Head Bolt Diameter, (1 Groove) <i>1.4mm Thickness</i>	3728	1		
			Jetta, 11.5mm Head Bolt Diameter, (2 Grooves) <i>1.5mm Thickness</i>	3729	1		
			Jetta, 11.5mm Head Bolt Diameter, (3 Grooves) <i>1.6mm Thickness</i>	3730	1		
			Jetta, Rabbit, 12.5mm Head Bolt Diameter, (2 Grooves) <i>1.5mm Thickness</i>	3765	1		
			Jetta, Rabbit, 12.5mm Head Bolt Diameter, (3 Grooves) <i>1.6mm Thickness</i>	3766	1		
			Jetta, Rabbit, 12.5mm Head Bolt Diameter, (1 Groove) <i>1.4mm Thickness</i>	5763	1		
			1982		Quantum, Rabbit, 11.5mm Head Bolt Diameter, (1 Groove) <i>1.4mm Thickness</i>	3728	1
					Quantum, Rabbit, 11.5mm Head Bolt Diameter, (2 Grooves) <i>1.5mm Thickness</i>	3729	1
	Quantum, Rabbit, 11.5mm Head Bolt Diameter, (3 Grooves) <i>1.6mm Thickness</i>	3730			1		
	Quantum, 12.5mm Head Bolt Diameter, (2 Grooves) <i>1.5mm Thickness</i>	3765			1		
Quantum, 12.5mm Head Bolt Diameter, (3 Grooves) <i>1.6mm Thickness</i>	3766	1					
Quantum, 12.5mm Head Bolt Diameter, (1 Groove) <i>1.4mm Thickness</i>	5763	1					
Valve Cover Set	1982-1984		Jetta, Quantum, Rabbit, (Contains Valve Cover End Plug) <i>Cork Rubber</i>	VS30024	1		
			Jetta, Quantum, Rabbit, (Contains Valve Cover End Plug) <i>Tuff-Cork</i>	VS30024TC	1		
Valve Stem Seal, Exh.	1983-1984		Jetta, Quantum <i>Teflon</i>	B45423	4		
Valve Stem Seal, Int.	1983-1984		Jetta, Quantum <i>Teflon</i>	B45423	4		
Manifold Set, Exhaust	1983-1984		Jetta, Quantum, Rabbit, To Be Replaced By MS12375	MS10030W	1		
			Jetta, Quantum, Rabbit	MS12375	1		
Manifold Set, Intake	1983-1984		Jetta, Quantum	MS12278	1		

10 1588CC (1.6L) CY Turbo Diesel 4 Cyl, 3.130in./79.5mm (1982-1984) **10**
(cont.) (cont.)

Part Year VIN Model/Application Part Number Qty.

ENGINE GASKETS (cont.)

Manifold Set, Intake (cont.)	1982-1984		Rabbit		MS12278	1
Oil Pan Set	1983-1984		Quantum	<i>Victo-Tech</i>	OS20056	1
	1982-1984		Jetta, Rabbit	<i>Victo-Tech</i>	OS20056	1
Rear Main Seal Set	1983-1984		Jetta, Quantum		JV567	1
	1982-1984		Rabbit		JV567	1
Timing Cover Set	1983-1984		Jetta, Quantum, Rabbit		JV982	1
Timing Cover Seal	1983-1984		Rabbit		66960	1
	1982-1984		Jetta, Quantum		66960	1

MISCELLANEOUS GASKETS

Camshaft Seal	1984		Jetta, Front		66960	1
	1982-1984		Quantum, Rabbit, Front		66960	1
Cam. Semi-Circular Plug	1984		Jetta, Rear		B45453	1
	1982-1984		Quantum, Rabbit, Rear		B45453	1
Exhaust Pipe Gasket	1983-1984		Jetta, Quantum, Rabbit, (Flange Type), Pipe To Manifold		F10049	1
			Rabbit, (Flange Type)		F10049	1
Intermediate Shaft Set	1983-1984		Jetta, Quantum, Rabbit		JV983	1
Water Outlet Gasket	1984		Jetta	<i>Victo-Tech</i>	C20119	1
	1983-1984		Rabbit	<i>Victo-Tech</i>	C20119	1
	1982-1984		Quantum	<i>Victo-Tech</i>	C20119	1
Water Pump Hsg. O-Ring	1983-1984		Rabbit, (Flange Type), Pump To Block	<i>Victo-Tech</i>	C20119	1
	1982-1984		Jetta, Quantum, Pump To Block	<i>Rubber</i>	C20119	1
Water Pump Mount Gasket	1983-1984		Rabbit, Pump To Block		K20118	1
			Jetta		K20118	1
	1982-1984		Quantum, Rabbit		K20118	1

11 1588CC (1.6L) EE 4 Cyl, 3.130in./79.5mm (1977) **11**

Part Year VIN Model/Application Part Number Qty.

ENGINE GASKETS

Head Set	1977				HS3609	1
Full Set	1977				FS3609	1
Cylinder Head Gasket	1977			<i>VR2000</i>	3609	1
Cyl. Head Spacer Shim	1977		Requires Sealing Compound	<i>Steel</i>	3609S	1
Sealing Compound	1977		(4 Ounce Brush Top Can)		JV66B	1
			(12 Ounce Spray Can)		JV66S	1
Valve Cover Set	1977		(Contains Valve Cover End Plug)	<i>Cork Rubber</i>	VS30024	1
			(Contains Valve Cover End Plug)	<i>Tuff-Cork</i>	VS30024TC	1
Valve Stem Seal, Exh.	1977			<i>Teflon</i>	B45423	4
				<i>Fluoroelastomer</i>	B45546	4
Valve Stem Seal, Int.	1977			<i>Teflon</i>	B45423	4
				<i>Fluoroelastomer</i>	B45546	4
Manifold Set, Exhaust	1977		To Be Replaced By MS12375		MS10030W	1
					MS12375	1
Manifold Set, Intake	1977				MS12278	1
Oil Pan Set	1977			<i>Victo-Tech</i>	OS20056	1
Rear Main Seal Set	1977				JV644	1
Timing Cover Set	1977				JV982	1
Timing Cover Seal	1977				66960	1

MISCELLANEOUS GASKETS

Camshaft Seal	1977		Front		66960	1
Cam. Semi-Circular Plug	1977		Rear		B45453	1

Volkswagen

11 (cont.)	1588CC (1.6L) EE 4 Cyl, 3.130in./79.5mm (1977)					11 (cont.)
----------------------	---	--	--	--	--	----------------------

Part	Year	VIN	Model/Application	Part Number	Qty.
MISCELLANEOUS GASKETS (cont.)					
Carb. Mount Gasket	1977			G26834	1
Dist. Mounting Gasket	1977			B25941	1
E.G.R. Gasket	1977			G20270	1
Exhaust Pipe Gasket	1977		(Flange Type), Pipe To Manifold	F14603	1
Fuel Pump Gasket	1977			D24097	1
Intermediate Shaft Set	1977			JV983	1
Oil Cooler Mount Grommet	1977			B45793	4
Oil Cooler Sealing Kit	1977			OS30099	1
Water Outlet Gasket	1977		Victo-Tech	C20119	1
Water Pump Hsg. O-Ring	1977		Rabbit, Pump To Block Victo-Tech	C20119	1
Water Pump Mount Gasket	1977			K20118	1

12	1588CC (1.6L) EJ 4 Cyl, 3.130in./79.5mm (1979-1980)					12
-----------	--	--	--	--	--	-----------

Part	Year	VIN	Model/Application	Part Number	Qty.
ENGINE GASKETS					
Head Set	1979-1980			HS3609	1
Full Set	1979-1980			FS3609	1
Cylinder Head Gasket	1979-1980		VR2000	3609	1
Cyl. Head Spacer Shim	1979-1980		Requires Sealing Compound Steel	3609S	1
Sealing Compound	1980		Jetta, Rabbit, (4 Ounce Brush Top Can)	JV66B	1
			Jetta, Rabbit, (12 Ounce Spray Can)	JV66S	1
	1979-1980		Scirocco, (4 Ounce Brush Top Can)	JV66B	1
			Scirocco, (12 Ounce Spray Can)	JV66S	1
Valve Cover Set	1979-1980		(Contains Valve Cover End Plug) Cork Rubber	VS30024	1
			(Contains Valve Cover End Plug) Tuff-Cork	VS30024TC	1
Valve Stem Seal, Exh.	1980		Rabbit Teflon	B45323	4
	1979-1980		Teflon	B45423	4
			Fluoroelastomer	B45546	4
Valve Stem Seal, Int.	1979-1980		Teflon	B45423	4
			Fluoroelastomer	B45546	4
Manifold Set, Exhaust	1979-1980		To Be Replaced By MS12375	MS10030W	1
Manifold Set, Intake	1979-1980			MS12278	1
Oil Pan Set	1979-1980		Victo-Tech	OS20056	1
Rear Main Seal Set	1979-1980			JV644	1
Timing Cover Set	1979-1980			JV982	1
Timing Cover Seal	1979-1980			66960	1

MISCELLANEOUS GASKETS					
Camshaft Seal	1979-1980		Front	66960	1
Cam. Semi-Circular Plug	1979-1980		Rear	B45453	1
Carb. Mount Gasket	1980		Rabbit	G26834	1
Dist. Mounting Gasket	1980		Jetta, Rabbit	B25941	1
	1979-1980		Scirocco	B25941	1
E.G.R. Gasket	1980		Rabbit	G20270	1
	1979-1980		Scirocco	G20270	1
Exhaust Pipe Gasket	1980		Jetta, Rabbit, (Flange Type), Pipe To Manifold	F14603	1
	1979-1980		Scirocco, (Flange Type), Pipe To Manifold	F14603	1
Fuel Pump Gasket	1980		Jetta, Rabbit	D24097	2
	1979-1980		Scirocco	D24097	2
Intermediate Shaft Set	1980		Jetta, Rabbit	JV983	1
	1979-1980		Scirocco	JV983	1
Oil Cooler Mount Grommet	1980		Jetta, Rabbit	B45793	4

12 1588CC (1.6L) EJ 4 Cyl, 3.130in./79.5mm (1979-1980) **12**
(cont.) (cont.)

Part	Year	VIN	Model/Application	Part Number	Qty.
MISCELLANEOUS GASKETS (cont.)					
Oil Cooler Mount Grommet (cont.)	1979-1980		Scirocco	B45793	4
Oil Cooler Sealing Kit	1980		Jetta, Rabbit	OS30099	1
	1979-1980		Scirocco	OS30099	1
Water Outlet Gasket	1980		Jetta, Rabbit <i>Victo-Tech</i>	C20119	1
	1979-1980		Scirocco <i>Victo-Tech</i>	C20119	1
Water Pump Hsg. O-Ring	1980		Jetta, Rabbit, Pump To Block <i>Victo-Tech</i>	C20119	1
	1979-1980		Scirocco, Pump To Block <i>Victo-Tech</i>	C20119	1
Water Pump Mount Gasket	1980		Jetta, Rabbit	K20118	1
	1979-1980		Scirocco	K20118	1

13 1588CC (1.6L) FN 4 Cyl, 3.130in./79.5mm (1976) **13**

Part	Year	VIN	Model/Application	Part Number	Qty.
ENGINE GASKETS					
Head Set	1976			HS3609	1
Full Set	1976			FS3609	1
Cylinder Head Gasket	1976		<i>VR2000</i>	3609	1
Cyl. Head Spacer Shim	1976		Requires Sealing Compound <i>Steel</i>	3609S	1
Sealing Compound	1976		(4 Ounce Brush Top Can)	JV66B	1
			(12 Ounce Spray Can)	JV66S	1
Valve Cover Set	1976		(Contains Valve Cover End Plug) <i>Cork Rubber</i>	VS30024	1
			(Contains Valve Cover End Plug) <i>Tuff-Cork</i>	VS30024TC	1
Valve Stem Seal, Exh.	1976		<i>Teflon</i>	B45423	4
			<i>Fluoroelastomer</i>	B45546	4
Valve Stem Seal, Int.	1976		<i>Teflon</i>	B45423	4
			<i>Fluoroelastomer</i>	B45546	4
Manifold Set, Exhaust	1976		To Be Replaced By MS12375	MS10030W	1
				MS12375	1
Manifold Set, Intake	1976			MS12278	1
Oil Pan Set	1976		<i>Victo-Tech</i>	OS20056	1
Rear Main Seal Set	1976			JV644	1
Timing Cover Set	1976			JV982	1
Timing Cover Seal	1976			66960	1

MISCELLANEOUS GASKETS					
Camshaft Seal	1976		Front	66960	1
Cam. Semi-Circular Plug	1976		Rear	B45453	1
Carb. Mount Gasket	1976			G26834	1
Dist. Mounting Gasket	1976			B25941	1
E.G.R. Gasket	1976			G20270	1
Exhaust Pipe Gasket	1976		(Flange Type), Pipe To Manifold	F14603	1
Fuel Pump Gasket	1976			D24097	2
Intermediate Shaft Set	1976			JV983	1
Oil Cooler Mount Grommet	1976			B45793	4
Oil Cooler Sealing Kit	1976			OS30099	1
Water Outlet Gasket	1976		<i>Victo-Tech</i>	C20119	1
Water Pump Hsg. O-Ring	1976		Pump To Block <i>Victo-Tech</i>	C20119	1
Water Pump Mount Gasket	1976			K20118	1

Volkswagen

14 1588CC (1.6L) MD Turbo Diesel 4 Cyl, 3.130in./79.5mm (1985)

14

Part	Year	VIN	Model/Application	Part Number	Qty.
ENGINE GASKETS					
Head Set	1985		(Head Gasket Not Included, Thickness Is Identified By Groove In Edge Of Gasket, Replacement Gasket Must Be Of Same Thickness As One Removed)	HS3664W	1
Full Set	1985		(Head Gasket Not Included, Thickness Is Identified By Groove In Edge Of Gasket, Replacement Gasket Must Be Of Same Thickness As One Removed)	FS3664W	1
Cylinder Head Gasket	1985		(2 Grooves) <i>1.5mm Thickness</i>	3765	1
			(3 Grooves) <i>1.6mm Thickness</i>	3766	1
			(1 Groove) <i>1.4mm Thickness</i>	5763	1
Valve Cover Set	1985		(Contains Valve Cover End Plug) <i>Cork Rubber</i>	VS30024	1
			(Contains Valve Cover End Plug) <i>Tuff-Cork</i>	VS30024TC	1
Valve Stem Seal, Exh.	1985		<i>Teflon</i>	B45423	4
Valve Stem Seal, Int.	1985		<i>Teflon</i>	B45423	4
Manifold Set, Exhaust	1985		To Be Replaced By MS12375	MS10030W	1
				MS12375	1
Manifold Set, Intake	1985			MS12278	1
Oil Pan Set	1985		<i>Victo-Tech</i>	OS20056	1
Rear Main Seal Set	1985			JV567	1
Timing Cover Set	1985			JV982	1
Timing Cover Seal	1985			66960	1

MISCELLANEOUS GASKETS

Camshaft Seal	1985		Front	66960	1
Cam. Semi-Circular Plug	1985		Rear	B45453	1
Exhaust Pipe Gasket	1985		(Flange Type), Pipe To Manifold	F10049	1
			(Flange Type)	F10049	1
Intermediate Shaft Set	1985		Quantum	JV983	1
Water Outlet Gasket	1985		<i>Victo-Tech</i>	C20119	1
Water Pump Hsg. O-Ring	1985		Pump To Block <i>Victo-Tech</i>	C20119	1
Water Pump Mount Gasket	1985			K20118	1

15 1588CC (1.6L) ME Diesel 4 Cyl, 3.130in./79.5mm (1985-1992)

15

Part	Year	VIN	Model/Application	Part Number	Qty.
ENGINE GASKETS					
Head Set	1985-1992		Engines With Mechanical Lifters, (Head Gasket Not Included, Thickness Is Identified By Groove In Edge Of Gasket, Replacement Gasket Must Be Of Same Thickness As One Removed)	HS3664W	1
Full Set	1985-1992		(Head Gasket Not Included, Thickness Is Identified By Groove In Edge Of Gasket, Replacement Gasket Must Be Of Same Thickness As One Removed)	FS3664W	1
Cylinder Head Gasket	1986-1992		From Engine Serial Number ME519909, (1 Hole) <i>1.53mm Thickness</i>	5902	1
			From Engine Serial Number ME519909, (2 Holes) <i>1.57mm Thickness</i>	5903	1
			From Engine Serial Number ME519909, (3 Holes) <i>1.61mm Thickness</i>	5904	1
	1985-1986		Thru Engine Serial Number ME519908, (1 Groove) <i>1.4mm Thickness</i>	3728	1
			Thru Engine Serial Number ME519908, (2 Grooves) <i>1.5mm Thickness</i>	3729	1
			Thru Engine Serial Number ME519908, (3 Grooves) <i>1.6mm Thickness</i>	3730	1
Valve Cover Set	1985-1992		(Contains Valve Cover End Plug) <i>Cork Rubber</i>	VS30024	1
			(Contains Valve Cover End Plug) <i>Tuff-Cork</i>	VS30024TC	1
Valve Stem Seal, Exh.	1985-1986		Jetta <i>Fluoroelastomer</i>	B45546	4
Valve Stem Seal, Int.	1985-1986		Jetta <i>Fluoroelastomer</i>	B45546	4
Manifold Set, Exhaust	1985-1992		To Be Replaced By MS12375	MS10030W	1

15 1588CC (1.6L) ME Diesel 4 Cyl, 3.130in./79.5mm (1985-1992) **15**
(cont.) (cont.)

Part	Year	VIN	Model/Application	Part Number	Qty.
ENGINE GASKETS (cont.)					
Manifold Set, Exhaust (cont.)	1985-1992			MS12375	1
Manifold Set, Intake	1985-1992			MS12278	1
Oil Pan Set	1985-1992		Victo-Tech	OS20056	1
Rear Main Seal Set	1985-1992			JV567	1
Timing Cover Set	1985-1992			JV982	1
Timing Cover Seal	1985-1992			66960	1

MISCELLANEOUS GASKETS					
Camshaft Seal	1987-1992		Front	66960	1
Cam. Semi-Circular Plug	1987-1992		Jetta, Rear	B45453	1
Exhaust Pipe Gasket	1986-1992		Jetta, (Flange Type), Pipe To Manifold	F10049	1
	1985-1988		Jetta, (Ring Type 'F'), Pipe To Manifold	F7442	1
	1986-1987		Golf, (Flange Type), Pipe To Manifold	F10049	1
	1985-1987		Golf, (Ring Type 'F'), Pipe To Manifold	F7442	1
	1985		Golf, Jetta, (Flange Type), Pipe To Manifold	F7426	1
			Jetta, (Flange Type)	F7426	1
Intermediate Shaft Set	1985-1992		Jetta	JV983	1
	1985-1987		Golf	JV983	1
Water Pump Hsg. O-Ring	1985-1992		Jetta, Pump To Block	Rubber C20119	1
	1985-1987		Golf, Pump To Block	Victo-Tech C20119	1
Water Pump Mount Gasket	1985-1992		Jetta	K20118	1
	1985-1987		Golf	K20118	1

16 1588CC (1.6L) MF Turbo Diesel 4 Cyl, 3.130in./79.5mm (1985-1986) **16**

Part	Year	VIN	Model/Application	Part Number	Qty.
ENGINE GASKETS					
Head Set	1985-1986		(Head Gasket Not Included, Thickness Is Identified By Groove In Edge Of Gasket, Replacement Gasket Must Be Of Same Thickness As One Removed)	HS3664W	1
Full Set	1985-1986		(Head Gasket Not Included, Thickness Is Identified By Groove In Edge Of Gasket, Replacement Gasket Must Be Of Same Thickness As One Removed)	FS3664W	1
Cylinder Head Gasket	1986		(1 Hole) 1.53mm Thickness	5902	1
			(2 Holes) 1.57mm Thickness	5903	1
			(3 Holes) 1.61mm Thickness	5904	1
	1985		(2 Grooves) 1.5mm Thickness	3765	1
			12.5mm Head Bolt Diameter, (2 Grooves) 1.5mm Thickness	3765	1
			(3 Grooves) 1.6mm Thickness	3766	1
			12.5mm Head Bolt Diameter, (3 Grooves) 1.6mm Thickness	3766	1
			(1 Groove) 1.4mm Thickness	5763	1
			12.5mm Head Bolt Diameter, (1 Groove) 1.4mm Thickness	5763	1
Valve Cover Set	1985-1986		(Contains Valve Cover End Plug) Cork Rubber	VS30024	1
			(Contains Valve Cover End Plug) Tuff-Cork	VS30024TC	1
Valve Stem Seal, Exh.	1985		Teflon	B45423	4
Valve Stem Seal, Int.	1985		Teflon	B45423	4
Manifold Set, Exhaust	1985-1986		To Be Replaced By MS12375	MS10030W	1
				MS12375	1
Manifold Set, Intake	1985-1986			MS12278	1
Oil Pan Set	1985-1986		Victo-Tech	OS20056	1
Rear Main Seal Set	1985-1986			JV567	1
Timing Cover Set	1985-1986			JV982	1
Timing Cover Seal	1985-1986			66960	1

Volkswagen

16 (cont.)	1588CC (1.6L) MF Turbo Diesel 4 Cyl, 3.130in./79.5mm (1985-1986)				16 (cont.)
----------------------	---	--	--	--	----------------------

<i>Part</i>	<i>Year</i>	<i>VIN</i>	<i>Model/Application</i>	<i>Part Number</i>	<i>Qty.</i>
MISCELLANEOUS GASKETS					
Camshaft Seal	1985-1986		Front	66960	1
Cam. Semi-Circular Plug	1985-1986		Rear	B45453	1
Exhaust Pipe Gasket	1985-1986		(Flange Type), Pipe To Manifold	F10049	1
Intermediate Shaft Set	1985-1986			JV983	1
Water Pump Mount Gasket	1985-1986			K20118	1

17	1588CC (1.6L) YG 4 Cyl, 3.130in./79.5mm (1976-1980)				17
-----------	--	--	--	--	-----------

<i>Part</i>	<i>Year</i>	<i>VIN</i>	<i>Model/Application</i>	<i>Part Number</i>	<i>Qty.</i>
ENGINE GASKETS					
Head Set	1976-1980			HS3609	1
Full Set	1976-1980			FS3609	1
Engine Kit Gasket Set	1976-1980			95-3095VR	1
Cylinder Head Gasket	1976-1980		VR2000	3609	1
Cyl. Head Spacer Shim	1979-1980		Requires Sealing Compound Steel	3609S	1
Sealing Compound	1976-1980		(4 Ounce Brush Top Can)	JV66B	1
			(12 Ounce Spray Can)	JV66S	1
Valve Cover Set	1980		(Contains Valve Cover End Plug) Cork Rubber	VS30024	1
	1976-1980		(Contains Valve Cover End Plug) Tuff-Cork	VS30024TC	1
	1976-1978		(Contains Valve Cover End Plug) Cork Rubber	VS30024	1
Valve Stem Seal, Exh.	1976-1980		Teflon	B45423	4
			Fluoroelastomer	B45546	4
Valve Stem Seal, Int.	1976-1980		Teflon	B45423	4
			Fluoroelastomer	B45546	4
Manifold Set, Exhaust	1976-1980		To Be Replaced By MS12375	MS10030W	1
				MS12375	1
Manifold Set, Intake	1976-1980			MS12278	1
Oil Pan Set	1976-1980		Victo-Tech	OS20056	1
Rear Main Seal Set	1976-1980			JV644	1
Timing Cover Set	1976-1980			JV982	1
Timing Cover Seal	1979-1980			66960	1

MISCELLANEOUS GASKETS					
Camshaft Seal	1979-1980		Front	66960	1
Cam. Semi-Circular Plug	1979-1980		Rear	B45453	1
Dist. Mounting Gasket	1976-1980			B25941	1
E.G.R. Gasket	1977-1980			G20269	1
	1976			G20270	1
Exhaust Pipe Gasket	1976-1980		(Flange Type), Pipe To Manifold	F14603	1
Fuel Pump Gasket	1976-1980			D24097	2
Intermediate Shaft Set	1976-1980			JV983	1
Oil Cooler Mount Grommet	1976-1980			B45793	4
Oil Cooler Sealing Kit	1976-1980			OS30099	1
Water Outlet Gasket	1979-1980		Victo-Tech	C20119	1
Water Pump Hsg. O-Ring	1976-1980		Pump To Block Victo-Tech	C20119	1
Water Pump Mount Gasket	1976-1980			K20118	1

18	1588CC (1.6L) YH 4 Cyl, 3.130in./79.5mm (1976-1980)				18
-----------	--	--	--	--	-----------

<i>Part</i>	<i>Year</i>	<i>VIN</i>	<i>Model/Application</i>	<i>Part Number</i>	<i>Qty.</i>
ENGINE GASKETS					
Head Set	1976-1980			HS3609	1

18 (cont.)	1588CC (1.6L) YH 4 Cyl, 3.130in./79.5mm (1976-1980)	18 (cont.)
----------------------	--	----------------------

Part	Year	VIN	Model/Application	Part Number	Qty.
ENGINE GASKETS (cont.)					
Full Set	1976-1980			FS3609	1
Engine Kit Gasket Set	1976-1980			95-3095VR	1
Cylinder Head Gasket	1976-1980		VR2000	3609	1
Cyl. Head Spacer Shim	1976-1980		Requires Sealing Compound Steel	3609S	1
Sealing Compound	1976-1980		(4 Ounce Brush Top Can)	JV66B	1
			(12 Ounce Spray Can)	JV66S	1
Valve Cover Set	1980		(Contains Valve Cover End Plug) Cork Rubber	VS30024	1
	1976-1980		(Contains Valve Cover End Plug) Tuff-Cork	VS30024TC	1
	1976-1978		(Contains Valve Cover End Plug) Cork Rubber	VS30024	1
Valve Stem Seal, Exh.	1976-1980		Teflon	B45423	4
			Fluoroelastomer	B45546	4
Valve Stem Seal, Int.	1976-1980		Teflon	B45423	4
			Fluoroelastomer	B45546	4
Manifold Set, Exhaust	1976-1980		To Be Replaced By MS12375	MS10030W	1
				MS12375	1
Manifold Set, Intake	1976-1980			MS12278	1
Oil Pan Set	1976-1980		Victo-Tech	OS20056	1
Rear Main Seal Set	1976-1980			JV644	1
Timing Cover Set	1976-1980			JV982	1
Timing Cover Seal	1976-1980			66960	1

MISCELLANEOUS GASKETS

Camshaft Seal	1976-1980		Front	66960	1
Cam. Semi-Circular Plug	1976-1980		Rear	B45453	1
Dist. Mounting Gasket	1976-1980			B25941	1
E.G.R. Gasket	1977-1980			G20269	1
	1976			G20270	1
Exhaust Pipe Gasket	1976-1980		(Flange Type), Pipe To Manifold	F14603	1
Fuel Pump Gasket	1976-1980			D24097	2
Intermediate Shaft Set	1976-1980			JV983	1
Oil Cooler Mount Grommet	1976-1980			B45793	4
Oil Cooler Sealing Kit	1976-1980			OS30099	1
Water Outlet Gasket	1976-1980		Victo-Tech	C20119	1
Water Pump Hsg. O-Ring	1976-1980		Pump To Block Victo-Tech	C20119	1
Water Pump Mount Gasket	1976-1980			K20118	1

19	1588CC (1.6L) YK 4 Cyl, 3.130in./79.5mm (1976-1980)	19
-----------	--	-----------

Part	Year	VIN	Model/Application	Part Number	Qty.
ENGINE GASKETS					
Head Set	1976-1980			HS3609	1
Full Set	1976-1980			FS3609	1
Cylinder Head Gasket	1976-1980		VR2000	3609	1
Cyl. Head Spacer Shim	1976-1980		Requires Sealing Compound Steel	3609S	1
Sealing Compound	1976-1980		(4 Ounce Brush Top Can)	JV66B	1
			(12 Ounce Spray Can)	JV66S	1
Valve Cover Set	1976-1980		(Contains Valve Cover End Plug) Cork Rubber	VS30024	1
			(Contains Valve Cover End Plug) Tuff-Cork	VS30024TC	1
Valve Stem Seal, Exh.	1976-1980		Teflon	B45423	4
			Fluoroelastomer	B45546	4
Valve Stem Seal, Int.	1976-1980		Teflon	B45423	4
			Fluoroelastomer	B45546	4
Manifold Set, Exhaust	1976-1980		To Be Replaced By MS12375	MS10030W	1

Volkswagen

19 1588CC (1.6L) YK 4 Cyl, 3.130in./79.5mm (1976-1980) **19**
(cont.) (cont.)

Part	Year	VIN	Model/Application	Part Number	Qty.
ENGINE GASKETS (cont.)					
Manifold Set, Exhaust (cont.)	1976-1980			MS12375	1
Manifold Set, Intake	1976-1980			MS12278	1
Oil Pan Set	1976-1980		Victo-Tech	OS20056	1
Rear Main Seal Set	1976-1980			JV644	1
Timing Cover Set	1976-1980			JV982	1
Timing Cover Seal	1976-1980			66960	1

MISCELLANEOUS GASKETS					
Camshaft Seal	1976-1980		Front	66960	1
Cam. Semi-Circular Plug	1976-1980		Rear	B45453	1
Carb. Mount Gasket	1976-1980			G26834	1
Dist. Mounting Gasket	1976-1980			B25941	1
E.G.R. Gasket	1977-1980			G20269	1
	1976			G20270	1
Exhaust Pipe Gasket	1976-1980		(Flange Type), Pipe To Manifold	F14603	1
Fuel Pump Gasket	1976-1980			D24097	2
Intermediate Shaft Set	1976-1980			JV983	1
Oil Cooler Mount Grommet	1976-1980			B45793	4
Oil Cooler Sealing Kit	1976-1980			OS30099	1
Water Outlet Gasket	1976-1980		Victo-Tech	C20119	1
Water Pump Hsg. O-Ring	1976-1980		Pump To Block Rubber	C20119	1
Water Pump Mount Gasket	1976-1980			K20118	1

20 1679CC (1.7L) 4 Cyl, 3.543in./90mm (1971-1973) **20**

Part	Year	VIN	Model/Application	Part Number	Qty.
ENGINE GASKETS					
Full Set	1971-1973		(Valve Stem Seals Not Included)	FS3579	1
Valve Cover Set	1971-1973		Cork Rubber	VS30004	1
Valve Stem Seal, Exh.	1971-1973			B45429	4
Valve Stem Seal, Int.	1971-1973			B45429	4
Rear Main Seal	1971-1973		Rubber	66941	1
Timing Cover Set	1971-1973			JV631	1

MISCELLANEOUS GASKETS					
Bearing Cover Oil Ring	1971-1973		Rear Axle	B45426	1
Exhaust Pipe Gasket	1971-1973		(Flange Type), Pipe To Manifold	F20331	1
Oil Cooler Mount Grommet	1971-1973			B45793	4
Oil Cooler Sealing Kit	1971-1973			OS30099	1
Oil Strainer Gasket Set	1971-1973			OS20100	1
Push Rod Tube Seal	1971-1973		21.3mm	B45430	16
			25.1mm	B45431	16

21 1715CC (1.7L) EN 4 Cyl, 3.130in./79.5mm (1981-1984) **21**

Part	Year	VIN	Model/Application	Part Number	Qty.
ENGINE GASKETS					
Head Set	1981-1984			HS3609	1
Full Set	1981-1984			FS3609	1
Engine Kit Gasket Set	1981-1984			95-3095VR	1
Cylinder Head Gasket	1981-1984		VR2000	3609	1
Cyl. Head Spacer Shim	1981-1984		Steel	3609S	1

21 1715CC (1.7L) EN 4 Cyl, 3.130in./79.5mm (1981-1984) **21**
(cont.) (cont.)

Part	Year	VIN	Model/Application	Part Number	Qty.
ENGINE GASKETS (cont.)					
Cyl. Head Spacer Shim (cont.)	1981-1984		Requires Sealing Compound	Steel 3609S	1
Sealing Compound	1981-1984		(4 Ounce Brush Top Can)	JV66B	1
			(12 Ounce Spray Can)	JV66S	1
Valve Cover Set	1981-1984		(Contains Valve Cover End Plug)	Cork Rubber VS30024	1
			(Contains Valve Cover End Plug)	Tuff-Cork VS30024TC	1
Valve Stem Seal, Exh.	1981-1984			Teflon B45423	4
				Fluoroelastomer B45546	4
Valve Stem Seal, Int.	1981-1984			Teflon B45423	4
				Fluoroelastomer B45546	4
Manifold Set, Exhaust	1981-1984		To Be Replaced By MS12375	MS10030W	1
				MS12375	1
Manifold Set, Intake	1981-1984			MS12278	1
Oil Pan Set	1981-1984			Victo-Tech OS20056	1
Rear Main Seal Set	1981-1984			JV644	1
Timing Cover Set	1981-1984			JV982	1
Timing Cover Seal	1981-1984			66960	1

MISCELLANEOUS GASKETS

Camshaft Seal	1981-1984		Front	66960	1
Cam. Semi-Circular Plug	1981-1984		Rear	B45453	1
Dist. Mounting Gasket	1981-1984			B25941	1
E.G.R. Gasket	1981-1982		Rabbit, Scirocco	G20270	1
Exhaust Pipe Gasket	1981-1984		(Flange Type), Pipe To Manifold	F14603	1
			(Flange Type), Pipe To Converter	F14604	1
Fuel Pump Gasket	1981-1984			D24097	2
Intermediate Shaft Set	1981-1984			JV983	1
Water Outlet Gasket	1981-1984			Victo-Tech C20119	1
Water Pump Hsg. O-Ring	1981-1984		Pump To Block	Victo-Tech C20119	1
Water Pump Mount Gasket	1981-1984			K20118	1

22 1715CC (1.7L) JF 4 Cyl, 3.130in./79.5mm (1982-1984) **22**

Part	Year	VIN	Model/Application	Part Number	Qty.
ENGINE GASKETS					
Head Set	1982-1984			HS3609	1
Full Set	1982-1984			FS3609	1
Engine Kit Gasket Set	1982-1984			95-3095VR	1
Cylinder Head Gasket	1982-1984			VR2000 3609	1
Cyl. Head Spacer Shim	1982-1984			Steel 3609S	1
			Requires Sealing Compound	Steel 3609S	1
Sealing Compound	1982-1984		(4 Ounce Brush Top Can)	JV66B	1
			(12 Ounce Spray Can)	JV66S	1
Valve Cover Set	1982-1984		(Contains Valve Cover End Plug)	Cork Rubber VS30024	1
			(Contains Valve Cover End Plug)	Tuff-Cork VS30024TC	1
Valve Stem Seal, Exh.	1982-1984			Teflon B45423	4
				Fluoroelastomer B45546	4
Valve Stem Seal, Int.	1982-1984			Teflon B45423	4
				Fluoroelastomer B45546	4
Manifold Set, Exhaust	1982-1984		To Be Replaced By MS12375	MS10030W	1
				MS12375	1
Manifold Set, Intake	1982-1984			MS12278	1
Oil Pan Set	1982-1984			Victo-Tech OS20056	1
Rear Main Seal Set	1982-1984			JV644	1

Volkswagen

22 (cont.)	1715CC (1.7L) JF 4 Cyl, 3.130in./79.5mm (1982-1984)				22 (cont.)
----------------------	--	--	--	--	----------------------

<i>Part</i>	<i>Year</i>	<i>VIN</i>	<i>Model/Application</i>	<i>Part Number</i>	<i>Qty.</i>
-------------	-------------	------------	--------------------------	--------------------	-------------

ENGINE GASKETS (cont.)

Timing Cover Set	1982-1984			JV982	1
Timing Cover Seal	1982-1984			66960	1

MISCELLANEOUS GASKETS

Camshaft Seal	1982-1984		Front	66960	1
Cam. Semi-Circular Plug	1982-1984		Rear	B45453	1
Dist. Mounting Gasket	1982-1984			B25941	1
E.G.R. Gasket	1982			G20270	1
Exhaust Pipe Gasket	1982-1984		(Flange Type), Pipe To Manifold	F14603	1
			(Flange Type), Pipe To Converter	F14604	1
Fuel Pump Gasket	1982-1984			D24097	2
Intermediate Shaft Set	1982-1984			JV983	1
Water Outlet Gasket	1982-1984		<i>Victo-Tech</i>	C20119	1
Water Pump Hsg. O-Ring	1982-1984		Pump To Block <i>Victo-Tech</i>	C20119	1
Water Pump Mount Gasket	1982-1984			K20118	1

23	1715CC (1.7L) WT 4 Cyl, 3.130in./79.5mm (1982-1983)				23
-----------	--	--	--	--	-----------

<i>Part</i>	<i>Year</i>	<i>VIN</i>	<i>Model/Application</i>	<i>Part Number</i>	<i>Qty.</i>
-------------	-------------	------------	--------------------------	--------------------	-------------

ENGINE GASKETS

Head Set	1982-1983			HS3609	1
Full Set	1982-1983			FS3609	1
Engine Kit Gasket Set	1982-1983			95-3095VR	1
Cylinder Head Gasket	1982-1983		<i>VR2000</i>	3609	1
Cyl. Head Spacer Shim	1982-1983		<i>Steel</i>	3609S	1
Sealing Compound	1982-1983		(4 Ounce Brush Top Can)	JV66B	1
			(12 Ounce Spray Can)	JV66S	1
Valve Cover Set	1982-1983		(Contains Valve Cover End Plug) <i>Cork Rubber</i>	VS30024	1
			(Contains Valve Cover End Plug) <i>Tuff-Cork</i>	VS30024TC	1
Valve Stem Seal, Exh.	1982-1983		<i>Teflon</i>	B45423	4
			<i>Fluoroelastomer</i>	B45546	4
			<i>Teflon</i>	B45423	4
Valve Stem Seal, Int.	1982-1983		<i>Teflon</i>	B45423	4
			<i>Fluoroelastomer</i>	B45546	4
Manifold Set, Exhaust	1982-1983		To Be Replaced By MS12375	MS10030W	1
				MS12375	1
Manifold Set, Intake	1982-1983			MS12278	1
Oil Pan Set	1982-1983		<i>Victo-Tech</i>	OS20056	1
Rear Main Seal Set	1982-1983			JV644	1
Timing Cover Set	1982-1983			JV982	1
Timing Cover Seal	1982-1983			66960	1

MISCELLANEOUS GASKETS

Camshaft Seal	1982-1983		Front	66960	1
Cam. Semi-Circular Plug	1982-1983		Rear	B45453	1
Dist. Mounting Gasket	1982-1983			B25941	1
Exhaust Pipe Gasket	1982-1983		(Flange Type), Pipe To Manifold	F14603	1
			(Flange Type), Pipe To Converter	F14604	1
Fuel Pump Gasket	1982-1983			D24097	2
Intermediate Shaft Set	1982-1983			JV983	1
Water Outlet Gasket	1982-1983		<i>Victo-Tech</i>	C20119	1
Water Pump Hsg. O-Ring	1982-1983		Pump To Block <i>Victo-Tech</i>	C20119	1
Water Pump Mount Gasket	1982-1983			K20118	1

Part	Year	VIN	Model/Application	Part Number	Qty.
ENGINE GASKETS					
Head Set	1990-1993			HS3758	1
	1990-1992		Supercharged	HS3758	1
	1985-1992			HS3758	1
Full Set	1990-1993			FS3758	1
	1990-1992		Supercharged	FS3758	1
	1985-1992			FS3758	1
Engine Kit Gasket Set	1985-1993			95-3157VR	1
Cylinder Head Gasket	1990-1993		VR2000	3758	1
	1990-1992		Supercharged VR2000	3758	1
	1985-1992		VR2000	3758	1
Cyl. Head Spacer Shim	1990-1993		Requires Sealing Compound Steel	3758S	1
	1990-1992		Requires Sealing Compound, Supercharged Steel	3758S	1
	1985-1992		Requires Sealing Compound Steel	3758S	1
Valve Cover Set	1990-1993		(Contains Valve Cover End Plug) Cork Rubber	VS30024	1
			(Contains Valve Cover End Plug) Tuff-Cork	VS30024TC	1
	1990-1992		(Contains Valve Cover End Plug), Supercharged Cork Rubber	VS30024	1
			(Contains Valve Cover End Plug), Supercharged Tuff-Cork	VS30024TC	1
	1985-1992		(Contains Valve Cover End Plug) Cork Rubber	VS30024	1
			(Contains Valve Cover End Plug) Tuff-Cork	VS30024TC	1
Manifold Set, Exhaust	1990-1993		To Be Replaced By MS12375	MS10030W	1
	1985-1993			MS12375	1
	1990-1992		Supercharged, To Be Replaced By MS12375	MS10030W	1
			Supercharged	MS10075	1
	1985-1992		To Be Replaced By MS12375	MS10030W	1
Manifold Set, Intake	1990-1993			MS12278	1
	1990-1992		Supercharged	MS12278	1
	1985-1992			MS12278	1
Oil Pan Set	1990-1993		Victo-Tech	OS20056	1
	1990-1992		Supercharged Victo-Tech	OS20056	1
	1985-1992		Victo-Tech	OS20056	1
Rear Main Seal Set	1990-1993			JV567	1
	1990-1992		Supercharged	JV567	1
	1985-1992			JV567	1
Timing Cover Set	1990-1993			JV982	1
	1990-1992		Supercharged	JV982	1
	1985-1992			JV982	1
Timing Cover Seal	1990-1993			66960	1
	1990-1992		Supercharged	66960	1
	1985-1992			66960	1
MISCELLANEOUS GASKETS					
Dist. Mounting Gasket	1990-1993			B25941	1
	1990-1992		Supercharged	B25941	1
	1985-1992			B25941	1
E.G.R. Gasket	1989-1992			G20269	1
Exhaust Pipe Gasket	1990-1993		Cabriolet, (Flange Type), Pipe To Manifold	F14603	1
	1990-1992		Corrado, (Flange Type), Pipe To Manifold	F14603	1
	1988-1992		Jetta, (Flange Type), Pipe To Manifold	F14603	1
	1985-1992		Golf, (Flange Type), Pipe To Manifold	F14603	1
	1987		Fox, (Flange Type), Pipe To Manifold	F10093	1
	1985		Jetta, (Flange Type), Pipe To Manifold	F14603	1
Intermediate Shaft Set	1990-1993			JV983	1
	1990-1992		Supercharged	JV983	1
	1985-1992			JV983	1
Throttle Body Gasket	1985-1993			G31123	1
Water Outlet Gasket	1990-1993		Victo-Tech	C20119	1
	1990-1992		Supercharged Victo-Tech	C20119	1

Volkswagen

24 (cont.)	1780CC (1.8L) 2H/ABG/HT/PF/PG/RD/RV/UM 4 Cyl, 3.189in./81mm (1985-1993)					24 (cont.)
----------------------	--	--	--	--	--	----------------------

<i>Part</i>	<i>Year</i>	<i>VIN</i>	<i>Model/Application</i>	<i>Part Number</i>	<i>Qty.</i>
MISCELLANEOUS GASKETS (cont.)					
Water Outlet Gasket (cont.)	1985-1992			<i>Victo-Tech</i> C20119	1
Water Pump Mount Gasket	1990-1993			K20118	1
	1990-1992		Supercharged	K20118	1
	1985-1992			K20118	1

25	1780CC (1.8L) GX (SOHC) 4 Cyl, 3.189in./81mm (1985-1987)					25
-----------	---	--	--	--	--	-----------

<i>Part</i>	<i>Year</i>	<i>VIN</i>	<i>Model/Application</i>	<i>Part Number</i>	<i>Qty.</i>
ENGINE GASKETS					
Head Set	1985-1987			HS3758	1
Full Set	1985-1987			FS3758	1
Engine Kit Gasket Set	1985-1987			95-3157VR	1
Cylinder Head Gasket	1985-1987		<i>VR2000</i>	3758	1
Cyl. Head Spacer Shim	1985-1987		Requires Sealing Compound <i>Steel</i>	3758S	1
Valve Cover Set	1985-1987		(Contains Valve Cover End Plug) <i>Cork Rubber</i>	VS30024	1
			(Contains Valve Cover End Plug) <i>Tuff-Cork</i>	VS30024TC	1
Manifold Set, Intake	1985-1987			MS12278	1
Oil Pan Set	1985-1987		<i>Victo-Tech</i>	OS20056	1
Rear Main Seal Set	1985-1987			JV567	1
Timing Cover Set	1985-1987			JV982	1
Timing Cover Seal	1985-1987			66960	1

MISCELLANEOUS GASKETS					
Dist. Mounting Gasket	1985-1987			B25941	1
Exhaust Pipe Gasket	1985-1987		(Flange Type), Pipe To Manifold	F14603	1
Intermediate Shaft Set	1985-1987			JV983	1
Throttle Body Gasket	1985-1987			G31123	1
Water Outlet Gasket	1985-1987		<i>Victo-Tech</i>	C20119	1
Water Pump Mount Gasket	1985-1987			K20118	1

26	1780CC (1.8L) JH (SOHC) 4 Cyl, 3.189in./81mm (1983-1989)					26
-----------	---	--	--	--	--	-----------

<i>Part</i>	<i>Year</i>	<i>VIN</i>	<i>Model/Application</i>	<i>Part Number</i>	<i>Qty.</i>
ENGINE GASKETS					
Head Set	1983-1989			HS3758	1
Full Set	1983-1989			FS3758	1
Engine Kit Gasket Set	1983-1989			95-3157VR	1
Cylinder Head Gasket	1983-1989		<i>VR2000</i>	3758	1
Cyl. Head Spacer Shim	1983-1989		Requires Sealing Compound <i>Steel</i>	3758S	1
Valve Cover Set	1983-1989		(Contains Valve Cover End Plug) <i>Cork Rubber</i>	VS30024	1
			(Contains Valve Cover End Plug) <i>Tuff-Cork</i>	VS30024TC	1
Manifold Set, Exhaust	1983-1989		To Be Replaced By MS12375	MS10030W	1
				MS12375	1
Manifold Set, Intake	1983-1989		K Jetronic Fuel Injection	MS12367	1
Oil Pan Set	1983-1989		<i>Victo-Tech</i>	OS20056	1
Rear Main Seal Set	1983-1989			JV567	1
Timing Cover Set	1983-1989			JV982	1
Timing Cover Seal	1983-1989			66960	1

MISCELLANEOUS GASKETS					
Dist. Mounting Gasket	1983-1989			B25941	1
Exhaust Pipe Gasket	1983-1989		(Flange Type), Pipe To Manifold	F14603	1
Intermediate Shaft Set	1983-1989			JV983	1
Throttle Body Gasket	1983-1989			G31123	1

26 1780CC (1.8L) JH (SOHC) 4 Cyl, 3.189in./81mm (1983-1989) **26**
(cont.) (cont.)

Part Year VIN Model/Application Part Number Qty.

MISCELLANEOUS GASKETS (cont.)

Water Outlet Gasket	1983-1989			<i>Victo-Tech</i>	C20119	1
Water Pump Mount Gasket	1983-1989				K20118	1

27 1780CC (1.8L) JN 4 Cyl, 3.189in./81mm (1984-1990) **27**

Part Year VIN Model/Application Part Number Qty.

ENGINE GASKETS

Head Set	1984-1990				HS3758	1
Full Set	1984-1990				FS3758	1
Engine Kit Gasket Set	1984-1990				95-3157VR	1
Cylinder Head Gasket	1984-1990			<i>VR2000</i>	3758	1
Cyl. Head Spacer Shim	1984-1990		Requires Sealing Compound	<i>Steel</i>	3758S	1
Valve Cover Set	1984-1990		(Contains Valve Cover End Plug)	<i>Cork Rubber</i>	VS30024	1
			(Contains Valve Cover End Plug)	<i>Tuff-Cork</i>	VS30024TC	1
Manifold Set, Exhaust	1984-1990		To Be Replaced By MS12375		MS10030W	1
					MS12375	1
Manifold Set, Intake	1984-1990				MS12278	1
Oil Pan Set	1984-1990			<i>Victo-Tech</i>	OS20056	1
Rear Main Seal Set	1984-1990				JV567	1
Timing Cover Set	1984-1990				JV982	1
Timing Cover Seal	1984-1990				66960	1

MISCELLANEOUS GASKETS

Dist. Mounting Gasket	1984-1990				B25941	1
Exhaust Pipe Gasket	1986-1990		Fox, (Flange Type), Pipe To Manifold		F10093	1
	1984-1985		Quantum, (Flange Type), Pipe To Manifold		F14603	1
Intermediate Shaft Set	1984-1990				JV983	1
Throttle Body Gasket	1984-1990				G31123	1
Water Outlet Gasket	1984-1990			<i>Victo-Tech</i>	C20119	1
Water Pump Mount Gasket	1984-1990				K20118	1

28 1780CC (1.8L) PL DOHC - 16 Valve 4 Cyl, 3.189in./81mm (1986-1989) **28**

Part Year VIN Model/Application Part Number Qty.

ENGINE GASKETS

Head Set	1986-1989				HS3758W	1
Lower Set	1986-1989		(Requires Head Set To Make Full Set)		CS3758	1
Cylinder Head Gasket	1986-1989			<i>VR2000</i>	3758	1
Cyl. Head Spacer Shim	1986-1989		Requires Sealing Compound	<i>Steel</i>	3758S	1
Valve Cover Set	1986-1989		(Contains Spark Plug Tube Seals, Contains Valve Cover End Plugs)		VS50063	1
Valve Stem Seal, Exh.	1986-1989				B45618	8
Valve Stem Seal, Int.	1986-1989				B45618	8
Manifold Set, Exhaust	1986-1989				MS10075	1
Manifold Set, Intake	1986-1989				MS15469	1
Oil Pan Set	1986-1989			<i>Victo-Tech</i>	OS20056	1
Rear Main Seal Set	1986-1989				JV567	1
Timing Cover Set	1986-1989				JV982	1
Timing Cover Seal	1987-1989				66960	1

MISCELLANEOUS GASKETS

Dist. Mounting Gasket	1986-1989				B25941	1
Exhaust Pipe Gasket	1986-1989		(Flange Type), Pipe To Manifold		F7441	1
Intermediate Shaft Set	1986-1989				JV983	1
Throttle Body Gasket	1986-1989				G31123	1

Volkswagen

28	1780CC (1.8L) PL DOHC - 16 Valve 4 Cyl, 3.189in./81mm (1986-1989)	28
(cont.)		(cont.)

Part	Year	VIN	Model/Application	Part Number	Qty.
MISCELLANEOUS GASKETS (cont.)					
Water Outlet Gasket	1986-1989		<i>Victo-Tech</i>	C20119	1
Water Pump Mount Gasket	1986-1989			K20118	1

29	1795CC (1.8L) EC 4 Cyl, 3.661in./93mm (1974)	29
(cont.)		(cont.)

Part	Year	VIN	Model/Application	Part Number	Qty.
ENGINE GASKETS					
Full Set	1974		(Valve Stem Seals Not Included)	FS3575	1
Valve Cover Set	1974		<i>Cork Rubber</i>	VS30004	1
Valve Stem Seal, Exh.	1974			B45429	4
Valve Stem Seal, Int.	1974			B45429	4
Manifold Gasket, Exh.	1974		(Flange Type)	F14604	3
Rear Main Seal	1974		<i>Rubber</i>	66941	1
Timing Cover Set	1974			JV631	1

MISCELLANEOUS GASKETS					
Bearing Cover Oil Ring	1974		Rear Axle	B45426	1
Exhaust Pipe Gasket	1974		(Flange Type), Pipe To Manifold	F20331	1
Oil Cooler Mount Grommet	1974			B45793	4
Oil Cooler Sealing Kit	1974			OS30099	1
Oil Strainer Gasket Set	1974			OS20100	1
Push Rod Tube Seal	1974		<i>21.3mm</i>	B45430	16
			<i>25.1mm</i>	B45431	16

30	1984CC (2.0L) 9A DOHC 4 Cyl, 3.248in./82.5mm (1990-1994)	30
(cont.)		(cont.)

Part	Year	VIN	Model/Application	Part Number	Qty.
ENGINE GASKETS					
Head Set	1990-1994			HS5872W	1
Lower Set	1990-1994		(Requires Head Set To Make Full Set)	CS5872W	1
Cylinder Head Gasket	1990-1994			5872	1
Valve Cover Set	1990-1994		(Contains Spark Plug Tube Seals, Contains Valve Cover End Plugs)	VS50063	1
Valve Stem Seal, Exh.	1990-1994			B45618	8
Valve Stem Seal, Int.	1990-1994			B45618	8
Manifold Set, Exhaust	1990-1994			MS10075	1
Manifold Set, Intake	1990-1994		(Contains Plenum Chamber Gasket)	MS15469	1
Oil Pan Set	1990-1994			OS32113	1
Rear Main Seal Set	1990-1994			JV1608	1
Timing Cover Set	1990-1994			JV982	1

MISCELLANEOUS GASKETS					
Camshaft Seal	1990-1994			66960	2
Dist. Mounting Gasket	1990-1994			B25941	1
E.G.R. Gasket	1990-1994			G20269	1
Exhaust Pipe Gasket	1990-1994		(Flange Type), Pipe To Manifold	F7441	1
Intermediate Shaft Set	1990-1994			JV983	1
Throttle Body Gasket	1990-1994			G31123	1
Water Outlet Gasket	1990-1994		<i>Victo-Tech</i>	C20119	1
Water Pump Hsg. O-Ring	1990-1994		Pump To Block style="text-align:right;"> <i>Victo-Tech</i>	C20119	1
Water Pump Mount Gasket	1990-1994			K20118	1

31 1984CC (2.0L) ABA SOHC 4 Cyl, 3.248in./82.5mm (1993-2002) 31

Part	Year	VIN	Model/Application	Part Number	Qty.
ENGINE GASKETS					
Head Set	1993-2002			HS54330	1
Lower Set	1993-2002		(Requires Head Set To Make Full Set)	CS54330	1
Cylinder Head Gasket	1993-2002			54330	1
Valve Cover Set	1993-2002			VS18393	1
Valve Stem Seal, Exh.	1993-2002			B45618	4
Valve Stem Seal, Int.	1993-2002			B45618	4
Manifold Set, Exhaust	1993-2002			MS18396	1
Manifold Set, Intake	1993-2002		(Contains Plenum Chamber Gasket)	MS18395	1
Oil Pan Set	1993-2002			OS32229	1

MISCELLANEOUS GASKETS					
Camshaft Seal	1993-2002			67642	1
E.G.R. Gasket	1993-2002			G31494	1
Exhaust Pipe Gasket	1993-2002		Manifold To Exhaust Pipe	F7441	1
Throttle Body Gasket	1993-2002			G31613	1
Water Pump Gasket	1993-2002			GS33378	1

32 1984CC (2.0L) AVH 4 Cyl, 3.248in./82.5mm (2001-2003) 32

Part	Year	VIN	Model/Application	Part Number	Qty.
ENGINE GASKETS					
Valve Stem Seal, Exh.	2001-2003			B45618	4
Valve Stem Seal, Int.	2001-2003			B45618	4

33 1984CC (2.0L) AZG 4 Cyl, 3.248in./82.5mm (2001-2003) 33

Part	Year	VIN	Model/Application	Part Number	Qty.
ENGINE GASKETS					
Valve Stem Seal, Exh.	2001-2003			B45618	4
Valve Stem Seal, Int.	2001-2003			B45618	4

34 1984CC (2.0L) AEG 4 Cyl, 3.252in./82.6mm (1998-2001) 34

Part	Year	VIN	Model/Application	Part Number	Qty.
ENGINE GASKETS					
Valve Cover Gasket	1998-2001			VS18393	1
Valve Stem Seal, Exh.	1998-2001			B45618	4
Valve Stem Seal, Int.	1998-2001			B45618	4

MISCELLANEOUS GASKETS					
Camshaft Seal	1998-2001			66960	1
Exhaust Pipe Gasket	1998-2001		(Flange Type), Pipe To Manifold	F7441	1
Thermostat Seal	1998-2001		<i>Victo-Tech</i>	C20119	1

35 2144CC (2.2L) KM 5 Cyl, 3.130in./79.5mm (1984) 35

Part	Year	VIN	Model/Application	Part Number	Qty.
ENGINE GASKETS					
Head Set	1984			HS3657X	1
Lower Set	1984		(Requires Head Set To Make Full Set)	CS3657	1
Valve Cover Set	1984		(Contains Valve Cover End Plug) <i>Cork Rubber</i>	VS50010	1
Valve Stem Seal, Exh.	1984		<i>Teflon</i>	B20174	5
Valve Stem Seal, Int.	1984		<i>Teflon</i>	B20174	5
Manifold Set, Exhaust	1984			MS10030	1
Manifold Set, Intake	1984			MS15283	1
Oil Pan Set	1984		<i>Tuff-Cork</i>	OS30171TC	1
Rear Main Seal Set	1984			JV567	1
Timing Cover Seal	1984		(Oil Pan Gasket Must Be Replaced)	66806	1

Volkswagen

35 (cont.)	2144CC (2.2L) KM 5 Cyl, 3.130in./79.5mm (1984)					35 (cont.)
----------------------	---	--	--	--	--	----------------------

Part	Year	VIN	Model/Application	Part Number	Qty.
MISCELLANEOUS GASKETS					
Exhaust Pipe Gasket	1984		(Flange Type), Pipe To Manifold	F20173	1
Water Outlet Gasket	1984			<i>Victo-Tech</i> C20172	1
Water Pump Mount Gasket	1984			K27407	1

36	2144CC (2.2L) WE 5 Cyl, 3.130in./79.5mm (1983)					36
-----------	---	--	--	--	--	-----------

Part	Year	VIN	Model/Application	Part Number	Qty.
ENGINE GASKETS					
Head Set	1983			HS3657X	1
Lower Set	1983		(Requires Head Set To Make Full Set)	CS3657	1
Valve Cover Set	1983		(Contains Valve Cover End Plug)	<i>Cork Rubber</i> VS50010	1
Valve Stem Seal, Exh.	1983			<i>Teflon</i> B20174	5
Valve Stem Seal, Int.	1983			<i>Teflon</i> B20174	5
Manifold Set, Exhaust	1983			MS10030	1
Manifold Set, Intake	1983			MS15283	1
Oil Pan Set	1983			<i>Tuff-Cork</i> OS30171TC	1
Rear Main Seal Set	1983			JV567	1
Timing Cover Seal	1983		(Oil Pan Gasket Must Be Replaced)	66806	1

MISCELLANEOUS GASKETS					
Exhaust Pipe Gasket	1983		(Flange Type), Pipe To Manifold	F20173	1
Water Outlet Gasket	1983			<i>Victo-Tech</i> C20172	1
Water Pump Mount Gasket	1983			K27407	1

37	2226CC (2.2L) JT/KX 5 Cyl, 3.189in./81mm (1985-1988)					37
-----------	---	--	--	--	--	-----------

Part	Year	VIN	Model/Application	Part Number	Qty.
ENGINE GASKETS					
Head Set	1985-1987			HS5711	1
Lower Set	1985-1988		(Requires Head Set To Make Full Set)	CS3657	1
Cylinder Head Gasket	1985-1988			5711	1
Valve Cover Set	1985-1988		(Contains Valve Cover End Plug)	<i>Cork Rubber</i> VS50010	1
Valve Stem Seal, Exh.	1985-1988			<i>Teflon</i> B20174	5
Valve Stem Seal, Int.	1985-1988			<i>Teflon</i> B20174	5
Manifold Set, Exhaust	1985-1988			MS10030	1
Manifold Set, Intake	1985-1988			MS15283	1
Oil Pan Set	1985-1988			<i>Tuff-Cork</i> OS30171TC	1
Rear Main Seal Set	1985-1988			JV567	1
Timing Cover Seal	1985-1988		(Oil Pan Gasket Must Be Replaced)	66806	1

MISCELLANEOUS GASKETS					
Exhaust Pipe Gasket	1985-1987		(Flange Type), Pipe To Manifold	F20173	1
Water Outlet Gasket	1985-1988			<i>Victo-Tech</i> C20172	1
Water Pump Mount Gasket	1985-1987			K27407	1

38	2792CC (2.8L) AAA V6 Cyl, 3.189in./81mm (1992-1999)					38
-----------	--	--	--	--	--	-----------

Part	Year	VIN	Model/Application	Part Number	Qty.
ENGINE GASKETS					
Head Set	1995-1999			HS54343A	1
	1992-1994			HS54343	1
Lower Set	1992-1999			CS54343	1
Cylinder Head Gasket	1992-1998			54343	1
Valve Cover Set	1995-1999			<i>Victo-Tech</i> VS50327	1
	1992-1994			<i>Victo-Tech</i> VS50326	1
Valve Stem Seal, Exh.	1992-1999			B45498	6

Part Year VIN Model/Application Part Number Qty.

ENGINE GASKETS (cont.)

Valve Stem Seal, Int.	1992-1999			B45498	6
Manifold Set, Exhaust	1992-1999		Steel	MS16352	1
Manifold Set, Intake	1992-1999			MS16351	1
Oil Pan Set	1992-1999		Victo-Tech	OS32242	1
Rear Main Seal	1992-1999			67253	1
Timing Cover Seal	1992-1999			66806	1

MISCELLANEOUS GASKETS

E.G.R. Gasket	1992-1999			G31494	1
Exhaust Pipe Gasket	1992-1999		Pipe To Manifold	F31631	1
Therm. Mount Gasket	1992-1999		Victo-Tech	C31633	1
Water Outlet Gasket	1992-1999		Victo-Tech	C31634	1
Water Pump Gasket	1992-1999		Victo-Tech	K31635	1

Volvo

Engine Index

Engine	Year	Block
97 CID/1580CC (1.6L) B16B	1962	1
109 CID/1780CC (1.8L) B18	1962-1965	2
109 CID/1780CC (1.8L) B18B	1962-1968	3
109 CID/1780CC (1.8L) B18D	1962-1968	4
121 CID/1990CC (2.0L) B20A	1969-1972	5
121 CID/1990CC (2.0L) B20B	1969-1971	6
121 CID/1990CC (2.0L) B20E	1971-1973	7
121 CID/1990CC (2.0L) B20F	1971-1975	8
130 CID/2127CC (2.1L) B21F	1976-1982	9
130 CID/2127CC (2.1L) B21FT	1981-1985	10
141 CID/2316CC (2.3L) B230F SOHC 8 Valve	1985-1993	11
141 CID/2316CC (2.3L) B230FT SOHC	1985-1993	12

Engine	Year	Block
141 CID/2316CC (2.3L) B234F DOHC 16 Valve	1989-1992	13
141 CID/2316CC (2.3L) B23F	1983-1984	14
141 CID/2316CC (2.3L) B23FTi	1984	15
145 CID/2383CC (2.4L) D24 Volkswagen Diesel	1982-1985	16
145 CID/2383CC (2.4L) D24T Volkswagen Diesel	1983-1986	17
163 CID/2664CC (2.7L) B27F	1976-1979	18
174 CID/2849CC (2.8L) B280F	1986	19
174 CID/2849CC (2.8L) B28F	1980-1986	20
182 CID/2978CC (3.0L) B30A	1969-1971	21
182 CID/2978CC (3.0L) B30F	1972-1975	22

Model Index

Model	Engine	Year	Block
122S	109 CID/1780CC (1.8L) B18D	1962-1968	4
122S	109 CID/1780CC (1.8L) B18B	1961-1968	3
142S	109 CID/1780CC (1.8L) B18B	1967-1968	3
142S	121 CID/1990CC (2.0L) B20F	1970-1974	8
142S	121 CID/1990CC (2.0L) B20A	1969-1973	5
142S	121 CID/1990CC (2.0L) B20B	1969-1970	6
142S	121 CID/1990CC (2.0L) B20E	1971	7
144S	109 CID/1780CC (1.8L) B18B	1967-1968	3
144S	121 CID/1990CC (2.0L) B20F	1970-1974	8
144S	121 CID/1990CC (2.0L) B20B	1969-1971	6
144S	121 CID/1990CC (2.0L) B20E	1968-1974	7
145S	109 CID/1780CC (1.8L) B18B	1968	3
145S	121 CID/1990CC (2.0L) B20F	1970-1974	8
145S	121 CID/1990CC (2.0L) B20B	1969-1971	6
164S	182 CID/2978CC (3.0L) B30F	1972-1975	22
164S	182 CID/2978CC (3.0L) B30A	1969-1971	21
242	121 CID/1990CC (2.0L) B20F	1975	8
242	130 CID/2127CC (2.1L) B21F	1976-1979	9
244	121 CID/1990CC (2.0L) B20F	1975	8
244	130 CID/2127CC (2.1L) B21F	1976-1979	9
244	141 CID/2316CC (2.3L) B230F SOHC 8 Valve	1986-1993	11
245	121 CID/1990CC (2.0L) B20F	1975	8
245	130 CID/2127CC (2.1L) B21F	1976-1979	9
245	141 CID/2316CC (2.3L) B230F SOHC 8 Valve	1986-1993	11
262	163 CID/2664CC (2.7L) B27F	1976-1979	18
262	174 CID/2849CC (2.8L) B28F	1980-1981	20
264	163 CID/2664CC (2.7L) B27F	1976-1979	18
265	163 CID/2664CC (2.7L) B27F	1976-1979	18

Model	Engine	Year	Block
740	141 CID/2316CC (2.3L) B234F DOHC 16 Valve	1989-1990	13
740	141 CID/2316CC (2.3L) B230FT SOHC	1985-1992	12
740	141 CID/2316CC (2.3L) B230F SOHC 8 Valve	1985-1992	11
740	145 CID/2383CC (2.4L) D24T Volkswagen Diesel	1985-1986	17
760	141 CID/2316CC (2.3L) B230FT SOHC	1985-1990	12
760	141 CID/2316CC (2.3L) B230F SOHC 8 Valve	1985-1986	11
760	141 CID/2316CC (2.3L) B23FTi	1984	15
760	145 CID/2383CC (2.4L) D24T Volkswagen Diesel	1983-1985	17
760	174 CID/2849CC (2.8L) B28F	1983-1986	20
780	141 CID/2316CC (2.3L) B230FT SOHC	1986-1991	12
780	174 CID/2849CC (2.8L) B280F	1986-1991	19
940	141 CID/2316CC (2.3L) B234F DOHC 16 Valve	1991-1992	13
940	141 CID/2316CC (2.3L) B230FT SOHC	1991-1995	12
940	141 CID/2316CC (2.3L) B230F SOHC 8 Valve	1991-1995	11
1800E	121 CID/1990CC (2.0L) B20F	1970-1972	8
1800E	121 CID/1990CC (2.0L) B20B	1969-1970	6
1800S	109 CID/1780CC (1.8L) B18B	1964-1968	3
DL	130 CID/2127CC (2.1L) B21F	1980-1982	9

Volvo

Model Index (cont.)

Model	Engine	Year	Block	Model	Engine	Year	Block
DL	141 CID/2316CC (2.3L) SOHC 8 Valve	B230F 1985	11	GL	174 CID/2849CC (2.8L) B28F	1980-1981	20
DL	141 CID/2316CC (2.3L) B23F	1983	14	GLE	174 CID/2849CC (2.8L) B28F	1980-1982	20
DL	145 CID/2383CC (2.4L) D24 Volkswagen Diesel	1984-1985	16	GLT	130 CID/2127CC (2.1L) B21FT	1981-1985	10
GL	130 CID/2127CC (2.1L) B21F	1980-1982	9	P1800	109 CID/1780CC (1.8L) B18B	1961-1963	3
GL	141 CID/2316CC (2.3L) B230F SOHC 8 Valve	1985	11	PV544	97 CID/1580CC (1.6L) B16B	1957-1962	1
GL	141 CID/2316CC (2.3L) B23F	1983-1984	14	PV544	109 CID/1780CC (1.8L) B18D	1962-1966	4
GL	145 CID/2383CC (2.4L) D24 Volkswagen Diesel	1980-1985	16	PV544	109 CID/1780CC (1.8L) B18	1957-1967	2

1 97 CID/1580CC (1.6L) B16B 4 Cyl, 3.125in./79.4mm (1962) 1

Part	Year	VIN	Model/Application	Part Number	Qty.
------	------	-----	-------------------	-------------	------

ENGINE GASKETS

Timing Cover Set	1962			JV959	1
------------------	------	--	--	-------	---

2 109 CID/1780CC (1.8L) B18 4 Cyl, 3.313in./84.1mm (1962-1965) 2

Part	Year	VIN	Model/Application	Part Number	Qty.
------	------	-----	-------------------	-------------	------

ENGINE GASKETS

Timing Cover Set	1962-1965			JV959	1
------------------	-----------	--	--	-------	---

3 109 CID/1780CC (1.8L) B18B 4 Cyl, 3.313in./84.1mm (1962-1968) 3

Part	Year	VIN	Model/Application	Part Number	Qty.
------	------	-----	-------------------	-------------	------

ENGINE GASKETS

Head Set	1962-1968		(Valve Stem Seals Not Included)	HS3624	1
Cylinder Head Gasket	1962-1968			3624	1
Valve Cover Set	1962-1968		Cork Rubber	VS30033	1
Manifold Set, Int. & Exh.	1962-1968			MS15237	1
Oil Pan Set	1962-1968			OS30067	1
Timing Cover Set	1962-1968			JV959	1

MISCELLANEOUS GASKETS

Exhaust Pipe Gasket	1962-1968		Dual Pipe, (Flange Type), Pipe To Manifold	F14611	1
---------------------	-----------	--	--	--------	---

4 109 CID/1780CC (1.8L) B18D 4 Cyl, 3.313in./84.1mm (1962-1968) 4

Part	Year	VIN	Model/Application	Part Number	Qty.
------	------	-----	-------------------	-------------	------

ENGINE GASKETS

Head Set	1962-1968		(Valve Stem Seals Not Included)	HS3624	1
Cylinder Head Gasket	1962-1968			3624	1
Valve Cover Set	1962-1968		Cork Rubber	VS30033	1
Manifold Set, Int. & Exh.	1962-1968			MS15237	1
Oil Pan Set	1962-1968			OS30067	1
Timing Cover Set	1962-1968			JV959	1

MISCELLANEOUS GASKETS

Exhaust Pipe Gasket	1962-1968		Dual Pipe, (Flange Type), Pipe To Manifold	F14611	1
---------------------	-----------	--	--	--------	---

5 121 CID/1990CC (2.0L) B20A 4 Cyl, 3.500in./88.9mm (1969-1972) 5

Part	Year	VIN	Model/Application	Part Number	Qty.
------	------	-----	-------------------	-------------	------

ENGINE GASKETS

Timing Cover Set	1969-1972			JV959	1
------------------	-----------	--	--	-------	---

6 121 CID/1990CC (2.0L) B20B 4 Cyl, 3.500in./88.9mm (1969-1971) 6

<i>Part</i>	<i>Year</i>	<i>VIN</i>	<i>Model/Application</i>	<i>Part Number</i>	<i>Qty.</i>
ENGINE GASKETS					
Head Set	1971			HS3626	1
Full Set	1969-1971			FS3626	1
Cylinder Head Gasket	1969-1971			3626	1
Valve Cover Set	1971		<i>Cork Rubber</i>	VS30033	1
Valve Stem Seal, Exh.	1971			B45613	4
Valve Stem Seal, Int.	1971			B45613	4
Oil Pan Set	1971			OS30067	1
Rear Main Seal Set	1971			JV649	1
Timing Cover Set	1969-1971			JV959	1

MISCELLANEOUS GASKETS

Exhaust Pipe Gasket	1971		(Flange Type), Pipe To Manifold	F14611	1
Water Outlet Gasket	1971		<i>Victo-Tech</i>	C20283	1

7 121 CID/1990CC (2.0L) B20E 4 Cyl, 3.500in./88.9mm (1971-1973) 7

<i>Part</i>	<i>Year</i>	<i>VIN</i>	<i>Model/Application</i>	<i>Part Number</i>	<i>Qty.</i>
ENGINE GASKETS					
Head Set	1971			HS3627	1
Full Set	1971			FS3627	1
Cylinder Head Gasket	1971			3627	1
Valve Cover Set	1971		<i>Cork Rubber</i>	VS30033	1
Valve Stem Seal, Exh.	1971			B45613	4
Valve Stem Seal, Int.	1971			B45613	4
Oil Pan Set	1971			OS30067	1
Rear Main Seal Set	1971			JV649	1
Timing Cover Set	1973			JV959	1
	1971			JV959	1

MISCELLANEOUS GASKETS

Exhaust Pipe Gasket	1971		(Flange Type), Pipe To Manifold	F14611	1
Water Outlet Gasket	1971		<i>Victo-Tech</i>	C20283	1

8 121 CID/1990CC (2.0L) B20F 4 Cyl, 3.500in./88.9mm (1971-1975) 8

<i>Part</i>	<i>Year</i>	<i>VIN</i>	<i>Model/Application</i>	<i>Part Number</i>	<i>Qty.</i>
ENGINE GASKETS					
Head Set	1971-1975			HS3627	1
Full Set	1971-1975			FS3627	1
Cylinder Head Gasket	1971-1975			3627	1
Valve Cover Set	1971-1975		<i>Cork Rubber</i>	VS30033	1
Valve Stem Seal, Exh.	1971-1975			B45613	4
Valve Stem Seal, Int.	1971-1975			B45613	4
Oil Pan Set	1971-1975			OS30067	1
Rear Main Seal Set	1971-1975			JV649	1
Timing Cover Set	1971-1975			JV959	1

MISCELLANEOUS GASKETS

Exhaust Pipe Gasket	1971-1975		(Flange Type), Pipe To Manifold	F14611	1
Water Outlet Gasket	1971-1975		<i>Victo-Tech</i>	C20283	1

9 130 CID/2127CC (2.1L) B21F 4 Cyl, 3.622in./92mm (1976-1982) 9

<i>Part</i>	<i>Year</i>	<i>VIN</i>	<i>Model/Application</i>	<i>Part Number</i>	<i>Qty.</i>
ENGINE GASKETS					
Head Set	1976-1982			HS3970	1
Lower Set	1976-1982		(Requires Head Set To Make Full Set)	CS5727	1
Valve Cover Set	1976-1982		(Contains Valve Cover End Plug)	VS30299	1
Valve Stem Seal, Exh.	1976-1982			B45613	4
Valve Stem Seal, Int.	1976-1982			B45613	4

Volvo

9 (cont.)	130 CID/2127CC (2.1L) B21F 4 Cyl, 3.622in./92mm (1976-1982)				9 (cont.)
---------------------	--	--	--	--	---------------------

<i>Part</i>	<i>Year</i>	<i>VIN</i>	<i>Model/Application</i>	<i>Part Number</i>	<i>Qty.</i>
ENGINE GASKETS (cont.)					
Manifold Set, Exhaust	1976-1982			MS15278	1
Manifold Set, Intake	1976-1982			MS15227	1
Oil Pan Set	1976-1982			OS30067	1
Rear Main Seal Set	1976-1982			JV511	1
Timing Cover Set	1976-1982		(Contains Front Main and Idler Seal)	JV958	1

MISCELLANEOUS GASKETS					
Camshaft Seal	1976-1982			66818	2
Exhaust Pipe Gasket	1976-1982		(Flange Type), Pipe To Manifold	F14611	1
Valve Cover End Plug	1976-1982		(Half Round)	B45489	1
Water Outlet Gasket	1976-1982		<i>Victo-Tech</i>	C20283	1

10	130 CID/2127CC (2.1L) B21FT 4 Cyl, 3.622in./92mm (1981-1985)				10
<i>Part</i>	<i>Year</i>	<i>VIN</i>	<i>Model/Application</i>	<i>Part Number</i>	<i>Qty.</i>

ENGINE GASKETS					
Head Set	1981-1985		(Turbocharger Gasket Not Included)	HS3970	1
Lower Set	1981-1985		(Requires Head Set To Make Full Set)	CS5727	1
Valve Cover Set	1981-1985		(Contains Valve Cover End Plug)	VS30299	1
Valve Stem Seal, Exh.	1981-1985			B45613	4
Valve Stem Seal, Int.	1981-1985			B45613	4
Manifold Set, Exhaust	1981-1985			MS15278	1
Manifold Set, Intake	1981-1985			MS15227	1
Oil Pan Set	1981-1985			OS30067	1
Rear Main Seal Set	1981-1985			JV511	1
Timing Cover Set	1981-1985		(Contains Front Main and Idler Seal)	JV958	1

MISCELLANEOUS GASKETS					
Camshaft Seal	1981-1985			66818	2
Exhaust Pipe Gasket	1981-1985		(Flange Type), Pipe To Manifold	F14611	1
Water Outlet Gasket	1981-1985		<i>Victo-Tech</i>	C20283	1

11	141 CID/2316CC (2.3L) B230F SOHC 8 Valve 4 Cyl, 3.780in./96mm (1985-1993)				11
<i>Part</i>	<i>Year</i>	<i>VIN</i>	<i>Model/Application</i>	<i>Part Number</i>	<i>Qty.</i>

ENGINE GASKETS					
Head Set	1985-1993			HS5727W	1
Lower Set	1985-1993		(Requires Head Set To Make Full Set)	CS5727	1
Cylinder Head Gasket	1985-1993			5727	1
Valve Cover Set	1985-1993			VS50020	1
Valve Stem Seal, Int.	1985-1992			B45567	4
Manifold Set, Exhaust	1985-1993			MS15278	1
Manifold Set, Intake	1985-1993			MS15227	1
Oil Pan Set	1985-1993			OS30067	1
Rear Main Seal Set	1985-1993			JV511	1
Timing Cover Set	1985-1993		(Contains Front Main and Idler Seal)	JV958	1

MISCELLANEOUS GASKETS					
Camshaft Seal	1985-1992			66818	2
Exhaust Pipe Gasket	1985-1993		(Flange Type), Catalytic Converter	F10113	1
			(Flange Type), Pipe To Manifold	F14611	1
Water Outlet Gasket	1985-1993		<i>Victo-Tech</i>	C30680	1
Water Pump Mount Gasket	1985-1993			K30682	1

12 141 CID/2316CC (2.3L) B230FT SOHC 4 Cyl, 3.780in./96mm (1985-1993)**12**

<i>Part</i>	<i>Year</i>	<i>VIN</i>	<i>Model/Application</i>	<i>Part Number</i>	<i>Qty.</i>
ENGINE GASKETS					
Head Set	1985-1993		(Turbocharger Gasket Not Included)	HS5727W	1
Lower Set	1985-1993		(Requires Head Set To Make Full Set)	CS5727	1
Cylinder Head Gasket	1985-1993			5727	1
Valve Cover Set	1985-1993			VS50020	1
Manifold Set, Exhaust	1985-1993			MS15278	1
Manifold Set, Intake	1985-1993			MS15227	1
Oil Pan Set	1985-1993			OS30067	1
Rear Main Seal Set	1985-1993			JV511	1
Timing Cover Set	1985-1993		(Contains Front Main and Idler Seal)	JV958	1

MISCELLANEOUS GASKETS

Camshaft Seal	1985-1992			66818	2
Exhaust Pipe Gasket	1985-1993		(Flange Type), Pipe To Manifold	F14611	1
Water Outlet Gasket	1985-1993		<i>Victo-Tech</i>	C30680	1
Water Pump Mount Gasket	1985-1993			K30682	1

13 141 CID/2316CC (2.3L) B234F DOHC 16 Valve 4 Cyl, 3.780in./96mm (1989-1992)**13**

<i>Part</i>	<i>Year</i>	<i>VIN</i>	<i>Model/Application</i>	<i>Part Number</i>	<i>Qty.</i>
ENGINE GASKETS					
Head Set	1989-1992			HS5727X	1
Lower Set	1989-1992		(Requires Head Set To Make Full Set)	CS5727X	1
Cylinder Head Gasket	1989-1992			5727	1
Valve Cover Set	1989-1992			VS50159	1
Valve Stem Seal, Exh.	1989-1992			B45776	8
Valve Stem Seal, Int.	1989-1992			B45776	8
Manifold Set, Exhaust	1989-1992			MS16076	1
Manifold Set, Intake	1989-1992			MS16077	1
Oil Pan Set	1989-1992			OS30067	1
Rear Main Seal Set	1989-1992			JV511	1
Timing Cover Set	1989-1992		(Contains Front Main and Idler Seal)	JV958	1

MISCELLANEOUS GASKETS

Camshaft Seal	1989-1992			66818	2
Exhaust Pipe Gasket	1989-1992		(Flange Type), Pipe To Manifold	F14611	1
Throttle Body Gasket	1989-1992			G31353	1
Water Outlet Gasket	1989-1992		<i>Victo-Tech</i>	C20283	1
Water Pump Mount Gasket	1989-1992			K30682	1

14 141 CID/2316CC (2.3L) B23F 4 Cyl, 3.780in./96mm (1983-1984)**14**

<i>Part</i>	<i>Year</i>	<i>VIN</i>	<i>Model/Application</i>	<i>Part Number</i>	<i>Qty.</i>
ENGINE GASKETS					
Head Set	1983-1984			HS5727	1
Lower Set	1983-1984		(Requires Head Set To Make Full Set)	CS5727	1
Cylinder Head Gasket	1983-1984			5727	1
Valve Cover Set	1983-1984			VS30299	1
Valve Stem Seal, Int.	1983-1984			B45567	4
Manifold Set, Exhaust	1983-1984			MS15278	1
Manifold Set, Intake	1983-1984			MS15227	1
Oil Pan Set	1983-1984			OS30067	1
Rear Main Seal Set	1983-1984			JV511	1
Timing Cover Set	1983-1984		(Contains Front Main and Idler Seal)	JV958	1

MISCELLANEOUS GASKETS

Camshaft Seal	1983-1984			66818	2
Exhaust Pipe Gasket	1983-1984		(Flange Type), Pipe To Manifold	F14611	1
Water Outlet Gasket	1983-1984		<i>Victo-Tech</i>	C30680	1

Volvo

14 (cont.)	141 CID/2316CC (2.3L) B23F 4 Cyl, 3.780in./96mm (1983-1984)				14 (cont.)
----------------------	--	--	--	--	----------------------

Part	Year	VIN	Model/Application	Part Number	Qty.
------	------	-----	-------------------	-------------	------

MISCELLANEOUS GASKETS (cont.)

Water Pump Mount Gasket	1983-1984			K30681	1
-------------------------	-----------	--	--	--------	---

15	141 CID/2316CC (2.3L) B23FTi 4 Cyl, 3.780in./96mm (1984)				15
-----------	---	--	--	--	-----------

Part	Year	VIN	Model/Application	Part Number	Qty.
------	------	-----	-------------------	-------------	------

ENGINE GASKETS

Head Set	1984			HS5727	1
Lower Set	1984		(Requires Head Set To Make Full Set)	CS5727	1
Cylinder Head Gasket	1984			5727	1
Valve Cover Set	1984			VS30299	1
Manifold Set, Exhaust	1984			MS15278	1
Manifold Set, Intake	1984			MS15227	1
Oil Pan Set	1984			OS30067	1
Rear Main Seal Set	1984			JV511	1
Timing Cover Set	1984		(Contains Front Main and Idler Seal)	JV958	1

MISCELLANEOUS GASKETS

Camshaft Seal	1984			66818	2
Exhaust Pipe Gasket	1984		(Flange Type), Pipe To Manifold	F14611	1
Water Outlet Gasket	1984		<i>Victo-Tech</i>	C30680	1
Water Pump Mount Gasket	1984			K30681	1

16	145 CID/2383CC (2.4L) D24 Volkswagen Diesel 6 Cyl, 3.012in./76.5mm (1982-1985)				16
-----------	---	--	--	--	-----------

Part	Year	VIN	Model/Application	Part Number	Qty.
------	------	-----	-------------------	-------------	------

ENGINE GASKETS

Head Set	1982-1985		From Engine Serial Number 41876, (Head Gasket Not Included, Turbocharger Gasket Not Included, Thickness Is Identified By Groove In Edge Of Gasket, Replacement Gasket Must Be Of Same Thickness As One Removed)	HS5799	1
Lower Set	1982-1985		From Engine Serial Number 41876, (Requires Head Set And Cylinder Head Gasket To Make Full Set)	CS5799	1
Cylinder Head Gasket	1982-1985		From Engine Serial Number 41876 <i>1.4mm 1 Groove</i>	5799	1
			From Engine Serial Number 41876 <i>2 Groove, 1.5mm Thickness</i>	5800	1
			From Engine Serial Number 41876 <i>1.6mm 3 Grooves</i>	5801	1
Valve Cover Set	1982-1985		From Engine Serial Number 41876	VS50106	1
Valve Stem Seal, Exh.	1982-1985		From Engine Serial Number 41876 <i>Fluoroelastomer</i>	B45546	6
Valve Stem Seal, Int.	1982-1985		From Engine Serial Number 41876 <i>Fluoroelastomer</i>	B45546	6
Manifold Set, Exhaust	1982-1985		From Engine Serial Number 41876	MS10073	1
Manifold Set, Intake	1982-1985		From Engine Serial Number 41876	MS15630	1
Oil Pan Set	1982-1985		From Engine Serial Number 41876	OS32082	1
Rear Main Seal Set	1982-1985		From Engine Serial Number 41876	JV567	1
Timing Cover Seal	1982-1985		From Engine Serial Number 41876	66806	1

MISCELLANEOUS GASKETS

Camshaft Seal	1982-1985		From Engine Serial Number 41876	66960	2
Water Outlet Gasket	1982-1985		From Engine Serial Number 41876 <i>Victo-Tech</i>	C20172	1
Water Pump Mount Gasket	1982-1985		From Engine Serial Number 41876	K27407	1

17 145 CID/2383CC (2.4L) D24T Volkswagen Diesel 6 Cyl, 3.012in./76.5mm (1983-1986) 17

Part	Year	VIN	Model/Application	Part Number	Qty.
ENGINE GASKETS					
Head Set	1983-1986		From Engine Serial Number 41876, (Head Gasket Not Included, Turbocharger Gasket Not Included, Thickness Is Identified By Groove In Edge Of Gasket, Replacement Gasket Must Be Of Same Thickness As One Removed)	HS5799	1
Lower Set	1983-1986		From Engine Serial Number 41876, (Requires Head Set And Cylinder Head Gasket To Make Full Set)	CS5799	1
Cylinder Head Gasket	1983-1986		1.6mm 3 Grooves	5803	1
	1983-1985		2 Groove, 1.5mm Thickness	5802	1
Valve Cover Set	1983-1986		From Engine Serial Number 41876	VS50106	1
Valve Stem Seal, Exh.	1983-1986		From Engine Serial Number 41876 Fluoroelastomer	B45546	6
Valve Stem Seal, Int.	1983-1986		From Engine Serial Number 41876 Fluoroelastomer	B45546	6
Manifold Set, Exhaust	1983-1986		From Engine Serial Number 41876	MS10073	1
Manifold Set, Intake	1983-1986		From Engine Serial Number 41876	MS15630	1
Oil Pan Set	1983-1986		From Engine Serial Number 41876	OS32082	1
Rear Main Seal Set	1983-1986		From Engine Serial Number 41876	JV567	1
Timing Cover Seal	1983-1986		From Engine Serial Number 41876	66806	1

MISCELLANEOUS GASKETS

Camshaft Seal	1983-1986		From Engine Serial Number 41876	66960	2
Water Outlet Gasket	1983-1986		From Engine Serial Number 41876 Victo-Tech	C20172	1
Water Pump Mount Gasket	1983-1986		From Engine Serial Number 41876	K27407	1

18 163 CID/2664CC (2.7L) B27F V6 Cyl, 3.465in./88mm (1976-1979) 18

Part	Year	VIN	Model/Application	Part Number	Qty.
ENGINE GASKETS					
Valve Cover Set	1976-1979			VS30276	1
Valve Stem Seal, Exh.	1976-1979		Teflon	B45423	6
			Fluoroelastomer	B45546	6
Valve Stem Seal, Int.	1976-1979		Teflon	B45423	6
			Fluoroelastomer	B45546	6
Manifold Set, Exhaust	1976-1979		(Contains Intake Manifold Gaskets)	MS16715	1
Manifold Set, Intake	1976-1979			MS10037	1
Rear Main Seal Set	1976-1979			JV512	1
Timing Cover Set	1976-1979			JV960	1

MISCELLANEOUS GASKETS

Exhaust Pipe Gasket	1976-1979		(Flange Type), Pipe To Manifold	F5360C	2
Water Outlet Gasket	1976-1979			C20280	1

19 174 CID/2849CC (2.8L) B280F V6 Cyl, 3.583in./91mm (1986) 19

Part	Year	VIN	Model/Application	Part Number	Qty.
ENGINE GASKETS					
Cylinder Head Gasket	1986		Right	5715	1
			Left	5716	1

20 174 CID/2849CC (2.8L) B28F V6 Cyl, 3.583in./91mm (1980-1986) 20

Part	Year	VIN	Model/Application	Part Number	Qty.
ENGINE GASKETS					
Head Set	1980-1986			HS5715	1
Cylinder Head Gasket	1980-1986		Right	5715	1
			Left	5716	1
Valve Cover Set	1980-1986			VS30276	1
Valve Stem Seal, Exh.	1980-1986		Fluoroelastomer	B45546	6
	1980-1982		Teflon	B45423	6
Valve Stem Seal, Int.	1980-1986		Fluoroelastomer	B45546	6
	1980-1982		Teflon	B45423	6

Volvo

20 (cont.)	174 CID/2849CC (2.8L) B28F V6 Cyl, 3.583in./91mm (1980-1986)				20 (cont.)
----------------------	---	--	--	--	----------------------

<i>Part</i>	<i>Year</i>	<i>VIN</i>	<i>Model/Application</i>	<i>Part Number</i>	<i>Qty.</i>
-------------	-------------	------------	--------------------------	--------------------	-------------

ENGINE GASKETS (cont.)

Manifold Set, Exhaust	1980-1986		(Contains Intake Manifold Gaskets)	MS16715	1
Manifold Set, Intake	1980-1986			MS10037	1
Rear Main Seal Set	1980-1986			JV512	1
Timing Cover Set	1980-1986			JV960	1

MISCELLANEOUS GASKETS

Exhaust Pipe Gasket	1980-1986		(Flange Type), Pipe To Manifold	F5360C	1
Water Outlet Gasket	1980-1986			C20280	1

21	182 CID/2978CC (3.0L) B30A 6 Cyl, 3.504in./89mm (1969-1971)				21
-----------	--	--	--	--	-----------

<i>Part</i>	<i>Year</i>	<i>VIN</i>	<i>Model/Application</i>	<i>Part Number</i>	<i>Qty.</i>
-------------	-------------	------------	--------------------------	--------------------	-------------

ENGINE GASKETS

Cylinder Head Gasket	1969-1971			3628	1
Valve Cover Set	1969-1971			VS30034	1
Valve Stem Seal, Exh.	1969-1971			B45613	6
Valve Stem Seal, Int.	1969-1971			B45613	6
Manifold Set, Int. & Exh.	1969-1971			MS16713	1

MISCELLANEOUS GASKETS

Exhaust Pipe Gasket	1969-1971		(Flange Type), Pipe To Manifold	F14611	1
Water Outlet Gasket	1969-1971		<i>Victo-Tech</i>	C20283	1

22	182 CID/2978CC (3.0L) B30F 6 Cyl, 3.504in./89mm (1972-1975)				22
-----------	--	--	--	--	-----------

<i>Part</i>	<i>Year</i>	<i>VIN</i>	<i>Model/Application</i>	<i>Part Number</i>	<i>Qty.</i>
-------------	-------------	------------	--------------------------	--------------------	-------------

ENGINE GASKETS

Head Set	1972-1975			HS3950	1
Lower Set	1972-1975		(Requires Head Set To Make Full Set)	CS3950	1
Valve Cover Set	1972-1975			VS30034	1
Valve Stem Seal, Exh.	1972-1975			B45613	6
Valve Stem Seal, Int.	1972-1975			B45613	6
Manifold Set, Int. & Exh.	1972-1975			MS16713	1
Rear Main Seal Set	1972-1975			JV649	1
Timing Cover Set	1972-1975			JV961	1

MISCELLANEOUS GASKETS

Exhaust Pipe Gasket	1972-1975		(Flange Type), Pipe To Manifold	F5360C	2
Water Outlet Gasket	1972-1975		<i>Victo-Tech</i>	C20283	1

Yugo

Engine Index

<i>Engine</i>	<i>Year</i>	<i>Block</i>
1116CC (1.1L) SOHC	1986-1988	1

Model Index

<i>Model</i>	<i>Engine</i>	<i>Year</i>	<i>Block</i>
	1116CC (1.1L) SOHC	1986-1990	1

1	1116CC (1.1L) SOHC 4 Cyl, 3.150in./80mm (1986-1988)				1
----------	--	--	--	--	----------

<i>Part</i>	<i>Year</i>	<i>VIN</i>	<i>Model/Application</i>	<i>Part Number</i>	<i>Qty.</i>
-------------	-------------	------------	--------------------------	--------------------	-------------

ENGINE GASKETS

Head Set	1986-1988		Thru Engine Serial Number 926758	HS3633	1
Cylinder Head Gasket	1986-1988		Thru Engine Serial Number 926758	<i>VR2000</i> 3633	1
Valve Cover Set	1986-1988			VS30038	1
Valve Stem Seal, Exh.	1986-1988			B20192	4

1 (cont.)	1116CC (1.1L) SOHC 4 Cyl, 3.150in./80mm (1986-1988)				1 (cont.)
---------------------	--	--	--	--	---------------------

<i>Part</i>	<i>Year</i>	<i>VIN</i>	<i>Model/Application</i>	<i>Part Number</i>	<i>Qty.</i>
-------------	-------------	------------	--------------------------	--------------------	-------------

ENGINE GASKETS (cont.)

Valve Stem Seal, Int.	1986-1988			B20192	4
Timing Cover Set	1986-1988			JV964	1
Timing Cover Seal	1986-1988			47927	1

MISCELLANEOUS GASKETS

Cam & Idler Seal	1986-1988			66632	3
E.G.R. Gasket	1986-1988			G20193	1
Fuel Pump Gasket	1986-1988			D20187	2
Therm. Housing Gasket	1986-1988			C24136	1
Water Outlet Gasket	1986-1988			C20191	1

American Motors

Differential Housing Cover Gaskets

<i>Model & Application</i>	<i>Part No.</i>	<i>Qty.</i>	<i>Model & Application</i>	<i>Part No.</i>	<i>Qty.</i>
AMX			JAVELIN		
Diff. Hsg. Cover Gasket			Diff. Hsg. Cover Gasket		
1978-1979, 10 Bolt Holes, 9-3/16" X 10-5/8"	P27801	1	1968-1974, 10 Bolt Holes, 9-3/16" X 10-5/8"	P27801	1
AMBASSADOR			1968-1974, No Bolt Holes, 10" X 10-3/4" P37830 1		
Diff. Hsg. Cover Gasket			MARLIN		
1969-1971, 10 Bolt Holes, 9-3/16" X 10-5/8"	P27801	1	Diff. Hsg. Cover Gasket		
1965-1974, No Bolt Holes, 10" X 10-3/4"	P37830	1	1965-1967, No Bolt Holes, 10" X 10-3/4" P37830 1		
AMERICAN			MATADOR		
Diff. Hsg. Cover Gasket			Diff. Hsg. Cover Gasket		
1965-1968, 10 Bolt Holes, 9-3/16" X 10-5/8"	P27801	1	1971-1978, 10 Bolt Holes, 9-3/16" X 10-5/8"		
1965-1968, No Bolt Holes, 10" X 10-3/4"	P37830	1	1971-1978, No Bolt Holes, 10" X 10-3/4" P37830 1		
CONCORD			RAMBLER		
Diff. Hsg. Cover Gasket			Diff. Hsg. Cover Gasket		
1978-1979, No Bolt Holes, 10" X 10-3/4"	P37830	1	1969, 10 Bolt Holes, 9-3/16" X 10-5/8" P27801 1		
1977-1983, 10 Bolt Holes, 9-3/16" X 10-5/8"	P27801	1	1969, No Bolt Holes, 10" X 10-3/4" P37830 1		
EAGLE			REBEL		
Diff. Hsg. Cover Gasket			Diff. Hsg. Cover Gasket		
1980-1988, Front Axle	P27603	1	1969-1970, 10 Bolt Holes, 9-3/16" X 10-5/8"		
1980-1988, 10 Bolt Holes, Rear Axle, 9-3/16" X 10-5/8"	P27801	1	1967-1970, No Bolt Holes, 10" X 10-3/4" P37830 1		
EAGLE KAMMBACK			SPIRIT		
Diff. Hsg. Cover Gasket			Diff. Hsg. Cover Gasket		
1981-1982	P27801	1	1979-1982, 10 Bolt Holes, 9-3/16" X 10-5/8"		
GREMLIN			1979, No Bolt Holes, 10" X 10-3/4" P37830 1		
Diff. Hsg. Cover Gasket					
1970-1975, No Bolt Holes, 10" X 10-3/4"	P37830	1			

Transmission Gaskets

<i>Model & Application</i>	<i>Part No.</i>	<i>Qty.</i>	<i>Model & Application</i>	<i>Part No.</i>	<i>Qty.</i>
AMBASSADOR			EAGLE		
Transmission Pan Gasket			Transmission Pan Gasket		
1972-1974, A727 Automatic Transmission	W39003	1	1980-1988, A727 Automatic Transmission W39003 1		
1972-1974, A727 Automatic Transmission, Tuff-Cork	W39003TC	1	1980-1988, A727 Automatic Transmission, Tuff-Cork W39003TC 1		
1972-1974, A904; A94-1 Automatic Transmission	W38031	1	1980-1988, A904 Automatic Transmission W38031 1		
1958-1971, Aluminum Case, Flash-O-Matic Transmission	W39004	1	EAGLE KAMMBACK		
1958-1971, Cast Iron Case, Flash-O-Matic Transmission	W38987	1	Transmission Pan Gasket		
AMERICAN			1981-1982, A727 Automatic Transmission W39003 1		
Transmission Pan Gasket			1981-1982, A727 Automatic Transmission, Tuff-Cork W39003TC 1		
1957-1968, Aluminum Case, Flash-O-Matic Transmission	W39004	1	1981-1982, A904 Automatic Transmission W38031 1		
1957-1968, Cast Iron Case, Flash-O-Matic Transmission	W38987	1	EAGLE SX/4		
CONCORD			Transmission Pan Gasket		
Transmission Pan Gasket			1981-1983, A727 Automatic Transmission W39003 1		
1978-1983, A727 Automatic Transmission	W39003	1	1981-1983, A727 Automatic Transmission, Tuff-Cork W39003TC 1		
1978-1983, A727 Automatic Transmission, Tuff-Cork	W39003TC	1	1981-1983, A904 Automatic Transmission W38031 1		
1977-1983, A904 Automatic Transmission	W38031	1	GREMLIN		
Diff. Hsg. Cover Gasket			Transmission Pan Gasket		
			1971, Aluminum Case, Flash-O-Matic Transmission		
			1971, Cast Iron Case, Flash-O-Matic Transmission		
			W39004 1		
			W38987 1		

Transmission Gaskets (cont.)					
Model & Application		Part No.	Qty.	Model & Application	
HORNET			RAMBLER		
Transmission Pan Gasket				Transmission Pan Gasket	
1971, Aluminum Case, Flash-O-Matic Transmission		W39004	1	1969, Aluminum Case, Flash-O-Matic Transmission	
1970-1971, Cast Iron Case, Flash-O-Matic Transmission		W38987	1	1969, Cast Iron Case, Flash-O-Matic Transmission	
JAVELIN			RAMBLER CLASSIC		
Transmission Pan Gasket				Transmission Pan Gasket	
1972-1974, A727 Automatic Transmission		W39003	1	1961-1966, Aluminum Case, Flash-O-Matic Transmission	
1972-1974, A727 Automatic Transmission, Tuff-Cork		W39003TC	1	1961-1966, Cast Iron Case, Flash-O-Matic Transmission	
1972-1974, A904; A94-1 Automatic Transmission		W38031	1		
1968-1971, Aluminum Case, Flash-O-Matic Transmission		W39004	1		
1968-1971, Cast Iron Case, Flash-O-Matic Transmission		W38987	1		
MARLIN			REBEL		
Transmission Pan Gasket				Transmission Pan Gasket	
1965-1967, Aluminum Case, Flash-O-Matic Transmission		W39004	1	1967-1970, Aluminum Case, Flash-O-Matic Transmission	
1965-1967, Cast Iron Case, Flash-O-Matic Transmission		W38987	1	1967-1970, Cast Iron Case, Flash-O-Matic Transmission	
MATADOR			SPIRIT		
Transmission Pan Gasket				Transmission Pan Gasket	
1972-1978, A727 Automatic Transmission		W39003	1	1979-1983, A727 Automatic Transmission	
1972-1978, A727 Automatic Transmission, Tuff-Cork		W39003TC	1	1979-1983, A727 Automatic Transmission, Tuff-Cork	
1972-1978, A904; A94-1 Automatic Transmission		W38031	1	1979-1983, A904 Automatic Transmission	
1971, Aluminum Case, Flash-O-Matic Transmission		W39004	1		
1971, Cast Iron Case, Flash-O-Matic Transmission		W38987	1		

Audi

Transmission Gaskets					
Model & Application		Part No.	Qty.	Model & Application	
4000			FOX		
Transmission Pan Gasket				Transmission Pan Gasket	
1979-1984, Automatic Transmission		W29080	1	1975-1979, Automatic Transmission	
				1973-1974, Automatic Transmission	
5000					
Transmission Pan Gasket					
1979-1983, Automatic Transmission		W29080	1		

Chrysler

Axle Shaft Gaskets					
Model & Application		Part No.	Qty.	Model & Application	
300			5TH AVENUE		
Axle Flange Gasket				Axle Flange Gasket	
1966-1971, Inner, Rear Axle		J27961	1	1983-1987, Inner, Rear Axle	
1966-1971, Outer, Rear Axle		J27962	1	1983-1987, Outer, Rear Axle	

Chrysler (cont.)

Axle Shaft Gaskets (cont.)

<i>Model & Application</i>	<i>Part No.</i>	<i>Qty.</i>	<i>Model & Application</i>	<i>Part No.</i>	<i>Qty.</i>
ARROW			FURY		
Wheel Brg. Ret. Gasket			Axle Flange Gasket		
1976-1980, Rear Wheel	J24083	2	1975-1978, Inner, Rear Axle	J27961	1
ASPEN			1975-1978, Outer, Rear Axle	J27962	1
Axle Flange Gasket			FURY CUSTOM		
1976-1980, Inner, Rear Axle	J27961	1	Axle Flange Gasket		
1976-1980, Outer, Rear Axle	J27962	1	1971, Inner, Rear Axle	J27961	1
BARRACUDA			1971, Outer, Rear Axle	J27962	1
Axle Flange Gasket			FURY GRAND COUPE		
1970-1974, Inner, Rear Axle	J27961	1	Axle Flange Gasket		
1970-1974, Outer, Rear Axle	J27962	1	1972, Inner, Rear Axle	J27961	1
BROUGHAM			1972, Outer, Rear Axle	J27962	1
Axle Flange Gasket			1970, Inner, Rear Axle	J27961	1
1977, Inner, Rear Axle	J27961	1	1970, Outer, Rear Axle	J27962	1
1977, Outer, Rear Axle	J27962	1	FURY GRAND SEDAN		
CHALLENGER			Axle Flange Gasket		
Wheel Brg. Ret. Gasket			1972, Inner, Rear Axle	J27961	1
1978-1979, Rear Wheel	J24083	2	1972, Outer, Rear Axle	J27962	1
COLT			FURY I		
Wheel Brg. Ret. Gasket			Axle Flange Gasket		
1971-1980, Rear Wheel	J24083	2	1966-1974, Inner, Rear Axle	J27961	1
CORDOBA			1966-1974, Outer, Rear Axle	J27962	1
Axle Flange Gasket			FURY II		
1980-1983, Inner, Rear Axle	J27961	1	Axle Flange Gasket		
1980-1983, Outer, Rear Axle	J27962	1	1966-1974, Inner, Rear Axle	J27961	1
CORONET			1966-1974, Outer, Rear Axle	J27962	1
Axle Flange Gasket			FURY III		
1966-1976, Inner, Rear Axle	J27961	1	Axle Flange Gasket		
1966-1976, Outer, Rear Axle	J27962	1	1966-1974, Inner, Rear Axle	J27961	1
CROWN			1966-1974, Outer, Rear Axle	J27962	1
Axle Flange Gasket			GRAN FURY		
1966-1970, Inner, Rear Axle	J27961	1	Axle Flange Gasket		
1966-1970, Outer, Rear Axle	J27962	1	1980-1987, Inner, Rear Axle	J27961	1
DART			1980-1987, Outer, Rear Axle	J27962	1
Axle Flange Gasket			1973-1977, Inner, Rear Axle	J27961	1
1969-1976, Inner, Rear Axle	J27961	1	1973-1977, Outer, Rear Axle	J27962	1
1969-1976, Outer, Rear Axle	J27962	1	IMPERIAL		
DIPLOMAT			Axle Flange Gasket		
Axle Flange Gasket			1981-1983, Inner, Rear Axle	J27961	1
1977-1987, Inner, Rear Axle	J27961	1	1981-1983, Outer, Rear Axle	J27962	1
1977-1987, Outer, Rear Axle	J27962	1	1967, Inner, Rear Axle	J27961	1
DUSTER			1967, Outer, Rear Axle	J27962	1
Axle Flange Gasket			LEBARON		
1970-1976, Inner, Rear Axle	J27961	2	Axle Flange Gasket		
1970-1976, Outer, Rear Axle	J27962	2	1977-1981, Inner, Rear Axle	J27961	1
E-CLASS			1977-1981, Outer, Rear Axle	J27962	1
Axle Flange Gasket			MIRADA		
1983-1984, Inner, Rear Axle	J27961	1	Axle Flange Gasket		
1983-1984, Outer, Rear Axle	J27962	1	1980-1983, Inner, Rear Axle	J27961	1
EXECUTIVE LIMOUSINE			1980-1983, Outer, Rear Axle	J27962	1
Axle Flange Gasket			MONACO		
1986, Inner, Rear Axle	J27961	1	Axle Flange Gasket		
1986, Outer, Rear Axle	J27962	1	1966-1978, Inner, Rear Axle	J27961	1
			1966-1978, Outer, Rear Axle	J27962	1

Axle Shaft Gaskets (cont.)

<i>Model & Application</i>	<i>Part No.</i>	<i>Qty.</i>	<i>Model & Application</i>	<i>Part No.</i>	<i>Qty.</i>
NEW YORKER			SPORT FURY (cont.)		
Axle Flange Gasket			Axle Flange Gasket (cont.)		
1966-1982, Inner, Rear Axle	J27961	1	1976, Outer, Rear Axle	J27962	1
1966-1982, Outer, Rear Axle	J27962	1	1966-1971, Inner, Rear Axle	J27961	1
NEWPORT			1966-1971, Outer, Rear Axle		
Axle Flange Gasket			SPORT FURY GT		
1966-1981, Inner, Rear Axle	J27961	1	Axle Flange Gasket		
1966-1981, Outer, Rear Axle	J27962	1	1970-1971, Inner, Rear Axle	J27961	1
POLARA			1970-1971, Outer, Rear Axle		
Axle Flange Gasket			ST. REGIS		
1966-1973, Inner, Rear Axle	J27961	1	Axle Flange Gasket		
1966-1973, Outer, Rear Axle	J27962	1	1979-1981, Inner, Rear Axle	J27961	1
ROAD RUNNER			1979-1981, Outer, Rear Axle		
Axle Flange Gasket			SUBURBANS		
1975, Inner, Rear Axle	J27961	1	Axle Flange Gasket		
1975, Outer, Rear Axle	J27962	1	1972-1974, Inner, Rear Axle	J27961	1
ROYAL MONACO			1972-1974, Outer, Rear Axle		
Axle Flange Gasket			VIP		
1975-1977, Inner, Rear Axle	J27961	1	Axle Flange Gasket		
1975-1977, Outer, Rear Axle	J27962	1	1966-1969, Inner, Rear Axle	J27961	1
SAPPORO			1966-1969, Outer, Rear Axle		
Wheel Brg. Ret. Gasket			VALIANT		
1978-1979, Rear Wheel	J24083	2	Axle Flange Gasket		
SCAMP			1969-1976, Inner, Rear Axle		
Axle Flange Gasket			1969-1976, Outer, Rear Axle		
1971-1976, Inner, Rear Axle	J27961	2	VOLARE		
1971-1976, Outer, Rear Axle	J27962	2	Axle Flange Gasket		
SPORT FURY			1976-1980, Inner, Rear Axle		
Axle Flange Gasket			1976-1980, Outer, Rear Axle		
1976, Inner, Rear Axle	J27961	1			

Differential Housing Cover Gaskets

<i>Model & Application</i>	<i>Part No.</i>	<i>Qty.</i>	<i>Model & Application</i>	<i>Part No.</i>	<i>Qty.</i>
300			5TH AVENUE (cont.)		
Axle Hsg Cover Gasket			Axle Hsg Cover Gasket (cont.)		
1965-1971, 7.25" Ring Gear, 9 Bolt Holes, 8" X 9".	P27794	1	1983-1989, 8.25" Ring Gear, 10 Bolt Holes, 10-1/4" X 11-1/4".	P18564	1
1965-1971, 8.25" Ring Gear, 10 Bolt Holes, 10-1/4" X 11-1/4".	P18564	1	1983-1989, 8.25" Ring Gear, 10 Bolt Holes, Tuff-Cork, 10-1/4" X 11-1/4".	P18564TC	1
1965-1971, 8.25" Ring Gear, 10 Bolt Holes, Tuff-Cork, 10-1/4" X 11-1/4".	P18564TC	1	ARROW		
1965-1971, 9.25" Gear, 10 Bolt Holes, 10-1/4" X 10-3/4".	P27934	1	Axle Hsg Cover Gasket		
1965-1971, 9.75" Gear, 10 Bolt Holes, 11" X 12".	P18562	1	1979-1980, 10 Bolt Holes		
1965-1971, 9.75" Gear, 10 Bolt Holes, Tuff-Cork, 11" X 12".	P18562TC	1	Diff. Carrier Gasket		
Diff. Carrier Gasket			1976-1980, 8 Bolt Holes		
1965-1971, 8.75" Ring Gear, 10 Bolt Holes, 10-5/16" X 10-5/16".	P27930	1	ASPEN		
1965-1971, 8.75" Ring Gear, 10 Bolt Holes, Tuff-Cork, 10-5/16" X 10-5/16".	P27930TC	1	Axle Hsg Cover Gasket		
5TH AVENUE			1976-1980, 7.25" Ring Gear, 9 Bolt Holes, 8" X 9".		
Axle Hsg Cover Gasket			1976-1980, 7.25" Ring Gear, 10 Bolt Holes, 9-1/2" X 9-5/8".		
1983-1989, 7.25" Ring Gear, 9 Bolt Holes, 8" X 9".	P27794	1	1976-1980, 8.25" Ring Gear, 10 Bolt Holes, 10-1/4" X 11-1/4".		
1983-1989, 7.25" Ring Gear, 10 Bolt Holes, 9-1/2" X 9-5/8".	P38156	1	1976-1980, 8.25" Ring Gear, 10 Bolt Holes, Tuff-Cork, 10-1/4" X 11-1/4".		
			1976-1980, 8.25" Ring Gear, 10 Bolt Holes, Tuff-Cork, 10-1/4" X 11-1/4".		
			1976-1980, 8.25" Ring Gear, 10 Bolt Holes, Tuff-Cork, 10-1/4" X 11-1/4".		

Chrysler (cont.)

Differential Housing Cover Gaskets (cont.)

<i>Model & Application</i>	<i>Part No.</i>	<i>Qty.</i>	<i>Model & Application</i>	<i>Part No.</i>	<i>Qty.</i>
BROUGHAM			CORONET (cont.)		
Axle Hsg Cover Gasket			Axle Hsg Cover Gasket (cont.)		
1977, 7.25" Ring Gear, 9 Bolt Holes, 8" X 9"	P27794	1	1965-1974, 9.75" Gear, 10 Bolt Holes, 11" X 12"	P18562	1
1977, 7.25" Ring Gear, 10 Bolt Holes, 9-1/2" X 9-5/8"	P38156	1	1965-1974, 9.75" Gear, 10 Bolt Holes, Tuff-Cork, 11" X 12"	P18562TC	1
1977, 8.25" Ring Gear, 10 Bolt Holes, 10-1/4" X 11-1/4"	P18564	1	Diff. Carrier Gasket		
1977, 8.25" Ring Gear, 10 Bolt Holes, Tuff-Cork, 10-1/4" X 11-1/4"	P18564TC	1	1965-1976, 8.75" Ring Gear, 10 Bolt Holes, 10-5/16" X 10-5/16"	P27930	1
1977, 9.25" Gear, 12 Bolt Holes, 11-1/8" X 11-1/2"	P29352	1	1965-1976, 8.75" Ring Gear, 10 Bolt Holes, Tuff-Cork, 10-5/16" X 10-5/16"	P27930TC	1
1977, 9.25" Gear, 12 Bolt Holes, Tuff-Cork, 11-1/8" X 11-1/2"	P29352TC	1	CROWN IMPERIAL		
Diff. Carrier Gasket			Diff. Carrier Gasket		
1977, 8.75" Ring Gear, 10 Bolt Holes, 10-5/16" X 10-5/16"	P27930	1	1965	P27930	1
1977, 8.75" Ring Gear, 10 Bolt Holes, Tuff-Cork, 10-5/16" X 10-5/16"	P27930TC	1	1965, Tuff-Cork	P27930TC	1
CHALLENGER			DART		
Axle Hsg Cover Gasket			Axle Hsg Cover Gasket		
1978-1983, 10 Bolt Holes	P29082	1	1973-1976, 8.25" Ring Gear, 10 Bolt Holes, 10-1/4" X 11-1/4"	P18564	1
1978-1979, 8 Bolt Holes	P27629	1	1973-1976, 8.25" Ring Gear, 10 Bolt Holes, Tuff-Cork, 10-1/4" X 11-1/4"	P18564TC	1
COLT			1963-1976, 7.25" Ring Gear, 9 Bolt Holes, 8" X 9"	P27794	1
Axle Hsg Cover Gasket			Diff. Carrier Gasket		
1978-1980, 10 Bolt Holes	P29082	1	1967-1972, 8.75" Ring Gear, 10 Bolt Holes, 10-5/16" X 10-5/16"	P27930	1
1971-1980, 8 Bolt Holes	P27629	1	1967-1972, 8.75" Ring Gear, 10 Bolt Holes, Tuff-Cork, 10-5/16" X 10-5/16"	P27930TC	1
COLT VISTA			DIPLOMAT		
Axle Hsg Cover Gasket			Axle Hsg Cover Gasket		
1985-1987, 4 Wheel Drive	P38150	1	1977-1988, 7.25" Ring Gear, 9 Bolt Holes, 8" X 9"	P27794	1
CONQUEST			1977-1988, 7.25" Ring Gear, 10 Bolt Holes, 9-1/2" X 9-5/8"	P38156	1
Axle Hsg Cover Gasket			Diff. Carrier Gasket		
1985-1987, Turbocharged/Intercooled	P38149	1	1977-1988, 8.25" Ring Gear, 10 Bolt Holes, 10-1/4" X 11-1/4"	P18564	1
1984-1987, Turbocharged	P38147	1	1977-1988, 8.25" Ring Gear, 10 Bolt Holes, Tuff-Cork, 10-1/4" X 11-1/4"	P18564TC	1
CORDOBA			DUSTER		
Axle Hsg Cover Gasket			Axle Hsg Cover Gasket		
1975-1983, 7.25" Ring Gear, 9 Bolt Holes, 8" X 9"	P27794	1	1973-1976, 7.25" Ring Gear, 10 Bolt Holes, 9-1/2" X 9-5/8"	P38156	1
1975-1983, 7.25" Ring Gear, 10 Bolt Holes, 9-1/2" X 9-5/8"	P38156	1	1973-1976, 8.25" Ring Gear, 10 Bolt Holes, 10-1/4" X 11-1/4"	P18564	1
1975-1983, 8.25" Ring Gear, 10 Bolt Holes, 10-1/4" X 11-1/4"	P18564	1	1973-1976, 8.25" Ring Gear, 10 Bolt Holes, Tuff-Cork, 10-1/4" X 11-1/4"	P18564TC	1
1975-1983, 8.25" Ring Gear, 10 Bolt Holes, Tuff-Cork, 10-1/4" X 11-1/4"	P18564TC	1	1970-1976, 7.25" Ring Gear, 9 Bolt Holes, 8" X 9"	P27794	1
1975-1983, 9.25" Gear, 12 Bolt Holes, 11-1/8" X 11-1/2"	P29352	1	Diff. Carrier Gasket		
CORONET			1970-1972, 8.75" Ring Gear, 10 Bolt Holes, 10-5/16" X 10-5/16"	P27930	1
Axle Hsg Cover Gasket			Diff. Carrier Gasket		
1975-1976, 7.25" Ring Gear, 10 Bolt Holes, 9-1/2" X 9-5/8"	P38156	1	1970-1972, 8.75" Ring Gear, 10 Bolt Holes, Tuff-Cork, 10-5/16" X 10-5/16"	P27930TC	1
1975-1976, 9.25" Gear, 12 Bolt Holes, 11-1/8" X 11-1/2"	P29352	1	E-CLASS		
1975-1976, 9.25" Gear, 12 Bolt Holes, Tuff-Cork, 11-1/8" X 11-1/2"	P29352TC	1	Axle Hsg Cover Gasket		
1965-1976, 7.25" Ring Gear, 9 Bolt Holes, 8" X 9"	P27794	1	1983-1984, 7.25" Ring Gear, 9 Bolt Holes, 8" X 9"	P27794	1
1965-1976, 8.25" Ring Gear, 10 Bolt Holes, 10-1/4" X 11-1/4"	P18564	1	1983-1984, 7.25" Ring Gear, 10 Bolt Holes, 9-1/2" X 9-5/8"	P38156	1
1965-1976, 8.25" Ring Gear, 10 Bolt Holes, Tuff-Cork, 10-1/4" X 11-1/4"	P18564TC	1	1983-1984, 8.25" Ring Gear, 10 Bolt Holes, 10-1/4" X 11-1/4"	P18564	1
1965-1974, 9.25" Gear, 10 Bolt Holes, 10-1/4" X 10-3/4"	P27934	1	1983-1984, 8.25" Ring Gear, 10 Bolt Holes, Tuff-Cork, 10-1/4" X 11-1/4"	P18564TC	1

Differential Housing Cover Gaskets (cont.)

<i>Model & Application</i>	<i>Part No.</i>	<i>Qty.</i>	<i>Model & Application</i>	<i>Part No.</i>	<i>Qty.</i>
EXECUTIVE LIMOUSINE			FURY GRAND COUPE (cont.)		
Axle Hsg Cover Gasket			Axle Hsg Cover Gasket (cont.)		
1986, 7.25" Ring Gear, 9 Bolt Holes, 8" X 9".	P27794	1	1970, 8.25" Ring Gear, 10 Bolt Holes, Tuff-Cork, 10-1/4" X 11-1/4".	P18564TC	1
1986, 7.25" Ring Gear, 10 Bolt Holes, 9-1/2" X 9-5/8".	P38156	1	1970, 9.25" Gear, 10 Bolt Holes, 10-1/4" X 10-3/4".	P27934	1
1986, 8.25" Ring Gear, 10 Bolt Holes, 10-1/4" X 11-1/4".	P18564	1	1970, 9.75" Gear, 10 Bolt Holes, 11" X 12".	P18562	1
1986, 8.25" Ring Gear, 10 Bolt Holes, Tuff-Cork, 10-1/4" X 11-1/4".	P18564TC	1	1970, 9.75" Gear, 10 Bolt Holes, Tuff-Cork, 11" X 12".	P18562TC	1
FURY			Diff. Carrier Gasket		
Axle Hsg Cover Gasket			1972, 8.75" Ring Gear, 10 Bolt Holes, 10-5/16" X 10-5/16".		
1975-1978, 7.25" Ring Gear, 9 Bolt Holes, 8" X 9".	P27794	1	1972, 8.75" Ring Gear, 10 Bolt Holes, Tuff-Cork, 10-5/16" X 10-5/16".	P27930TC	1
1975-1978, 7.25" Ring Gear, 10 Bolt Holes, 9-1/2" X 9-5/8".	P38156	1	1970, 8.75" Ring Gear, 10 Bolt Holes, 10-5/16" X 10-5/16".	P27930	1
1975-1978, 8.25" Ring Gear, 10 Bolt Holes, 10-1/4" X 11-1/4".	P18564	1	1970, 8.75" Ring Gear, 10 Bolt Holes, Tuff-Cork, 10-5/16" X 10-5/16".	P27930TC	1
1975-1978, 8.25" Ring Gear, 10 Bolt Holes, Tuff-Cork, 10-1/4" X 11-1/4".	P18564TC	1	FURY GRAND SEDAN		
1975-1978, 9.25" Gear, 12 Bolt Holes, 11-1/8" X 11-1/2".	P29352	1	Axle Hsg Cover Gasket		
1975-1978, 9.25" Gear, 12 Bolt Holes, Tuff-Cork, 11-1/8" X 11-1/2".	P29352TC	1	1972, 7.25" Ring Gear, 9 Bolt Holes, 8" X 9".		
Diff. Carrier Gasket			1972, 8.25" Ring Gear, 10 Bolt Holes, 10-1/4" X 11-1/4".		
1975-1977, 8.75" Ring Gear, 10 Bolt Holes, 10-5/16" X 10-5/16".	P27930	1	1972, 8.25" Ring Gear, 10 Bolt Holes, Tuff-Cork, 10-1/4" X 11-1/4".	P18564TC	1
1975-1977, 8.75" Ring Gear, 10 Bolt Holes, Tuff-Cork, 10-5/16" X 10-5/16".	P27930TC	1	1972, 9.25" Gear, 10 Bolt Holes, 10-1/4" X 10-3/4".	P27934	1
FURY CUSTOM			1972, 9.75" Gear, 10 Bolt Holes, 11" X 12".		
Axle Hsg Cover Gasket			1972, 9.75" Gear, 10 Bolt Holes, Tuff-Cork, 11" X 12".		
1971, 7.25" Ring Gear, 9 Bolt Holes, 8" X 9".	P27794	1	1972, 8.75" Ring Gear, 10 Bolt Holes, 10-5/16" X 10-5/16".		
1971, 8.25" Ring Gear, 10 Bolt Holes, 10-1/4" X 11-1/4".	P18564	1	1972, 8.75" Ring Gear, 10 Bolt Holes, Tuff-Cork, 10-5/16" X 10-5/16".		
1971, 8.25" Ring Gear, 10 Bolt Holes, Tuff-Cork, 10-1/4" X 11-1/4".	P18564TC	1	FURY I		
1971, 9.25" Gear, 10 Bolt Holes, 10-1/4" X 10-3/4".	P27934	1	Axle Hsg Cover Gasket		
1971, 9.75" Gear, 10 Bolt Holes, 11" X 12".	P18562	1	1965-1974, 7.25" Ring Gear, 9 Bolt Holes, 8" X 9".		
1971, 9.75" Gear, 10 Bolt Holes, Tuff-Cork, 11" X 12".	P18562TC	1	1965-1974, 8.25" Ring Gear, 10 Bolt Holes, 10-1/4" X 11-1/4".		
Diff. Carrier Gasket			1965-1974, 8.25" Ring Gear, 10 Bolt Holes, Tuff-Cork, 10-1/4" X 11-1/4".		
1971, 8.75" Ring Gear, 10 Bolt Holes, 10-5/16" X 10-5/16".	P27930	1	1965-1974, 9.25" Gear, 10 Bolt Holes, 10-1/4" X 10-3/4".		
1971, 8.75" Ring Gear, 10 Bolt Holes, Tuff-Cork, 10-5/16" X 10-5/16".	P27930TC	1	1965-1974, 9.75" Gear, 10 Bolt Holes, 11" X 12".		
FURY GRAND COUPE			1965-1974, 9.75" Gear, 10 Bolt Holes, Tuff-Cork, 11" X 12".		
Axle Hsg Cover Gasket			1965-1974, 9.75" Gear, 10 Bolt Holes, Tuff-Cork, 11" X 12".		
1972, 7.25" Ring Gear, 9 Bolt Holes, 8" X 9".	P27794	1	Diff. Carrier Gasket		
1972, 8.25" Ring Gear, 10 Bolt Holes, 10-1/4" X 11-1/4".	P18564	1	1965-1974, 8.75" Ring Gear, 10 Bolt Holes, 10-5/16" X 10-5/16".		
1972, 8.25" Ring Gear, 10 Bolt Holes, Tuff-Cork, 10-1/4" X 11-1/4".	P18564TC	1	1965-1974, 8.75" Ring Gear, 10 Bolt Holes, Tuff-Cork, 10-5/16" X 10-5/16".		
1972, 9.25" Gear, 10 Bolt Holes, 10-1/4" X 10-3/4".	P27934	1	FURY II		
1972, 9.75" Gear, 10 Bolt Holes, 11" X 12".	P18562	1	Axle Hsg Cover Gasket		
1972, 9.75" Gear, 10 Bolt Holes, Tuff-Cork, 11" X 12".	P18562TC	1	1965-1974, 7.25" Ring Gear, 9 Bolt Holes, 8" X 9".		
1970, 7.25" Ring Gear, 9 Bolt Holes, 8" X 9".	P27794	1	1965-1974, 8.25" Ring Gear, 10 Bolt Holes, 10-1/4" X 11-1/4".		
1970, 8.25" Ring Gear, 10 Bolt Holes, 10-1/4" X 11-1/4".	P18564	1	1965-1974, 8.25" Ring Gear, 10 Bolt Holes, Tuff-Cork, 10-1/4" X 11-1/4".		
Diff. Carrier Gasket			1965-1974, 9.25" Gear, 10 Bolt Holes, 10-1/4" X 10-3/4".		
1970, 8.25" Ring Gear, 10 Bolt Holes, 10-5/16" X 10-5/16".	P27930	1	1965-1974, 9.75" Gear, 10 Bolt Holes, 11" X 12".		
1970, 8.25" Ring Gear, 10 Bolt Holes, Tuff-Cork, 10-5/16" X 10-5/16".	P27930TC	1	1965-1974, 9.75" Gear, 10 Bolt Holes, Tuff-Cork, 11" X 12".		

Chrysler (cont.)

Differential Housing Cover Gaskets (cont.)

<i>Model & Application</i>	<i>Part No.</i>	<i>Qty.</i>	<i>Model & Application</i>	<i>Part No.</i>	<i>Qty.</i>
FURY II (cont.)			GRAN FURY (cont.)		
Axle Hsg Cover Gasket (cont.)			Diff. Carrier Gasket (cont.)		
1965-1974, 9.75" Gear, 10 Bolt Holes, 11" X 12"	P18562	1	1973-1977, 8.75" Ring Gear, 10 Bolt Holes, Tuff-Cork, 10-5/16" X 10-5/16"	P27930TC	1
1965-1974, 9.75" Gear, 10 Bolt Holes, Tuff-Cork, 11" X 12"	P18562TC	1	IMPERIAL		
Diff. Carrier Gasket			Axle Hsg Cover Gasket		
1965-1974, 8.75" Ring Gear, 10 Bolt Holes, 10-5/16" X 10-5/16"	P27930	1	1981-1983, 7.25" Ring Gear, 9 Bolt Holes, 8" X 9"	P27794	1
1965-1974, 8.75" Ring Gear, 10 Bolt Holes, Tuff-Cork, 10-5/16" X 10-5/16"	P27930TC	1	1981-1983, 7.25" Ring Gear, 10 Bolt Holes, 9-1/2" X 9-5/8"	P38156	1
FURY III			1981-1983, 8.25" Ring Gear, 10 Bolt Holes, 10-1/4" X 11-1/4"	P18564	1
Axle Hsg Cover Gasket			1981-1983, 8.25" Ring Gear, 10 Bolt Holes, Tuff-Cork, 10-1/4" X 11-1/4"	P18564TC	1
1965-1974, 7.25" Ring Gear, 9 Bolt Holes, 8" X 9"	P27794	1	Diff. Carrier Gasket		
1965-1974, 8.25" Ring Gear, 10 Bolt Holes, 10-1/4" X 11-1/4"	P18564	1	1967	P27930	1
1965-1974, 8.25" Ring Gear, 10 Bolt Holes, Tuff-Cork, 10-1/4" X 11-1/4"	P18564TC	1	1967, Tuff-Cork	P27930TC	1
1965-1974, 9.25" Gear, 10 Bolt Holes, 10-1/4" X 10-3/4"	P27934	1	LEBARON		
1965-1974, 9.75" Gear, 10 Bolt Holes, 11" X 12"	P18562	1	Axle Hsg Cover Gasket		
1965-1974, 9.75" Gear, 10 Bolt Holes, Tuff-Cork, 11" X 12"	P18562TC	1	1977-1981, 7.25" Ring Gear, 9 Bolt Holes, 8" X 9"	P27794	1
Diff. Carrier Gasket			1977-1981, 7.25" Ring Gear, 10 Bolt Holes, 9-1/2" X 9-5/8"	P38156	1
1965-1974, 8.75" Ring Gear, 10 Bolt Holes, 10-5/16" X 10-5/16"	P27930	1	1977-1981, 8.25" Ring Gear, 10 Bolt Holes, 10-1/4" X 11-1/4"	P18564	1
1965-1974, 8.75" Ring Gear, 10 Bolt Holes, Tuff-Cork, 10-5/16" X 10-5/16"	P27930TC	1	1977-1981, 8.25" Ring Gear, 10 Bolt Holes, Tuff-Cork, 10-1/4" X 11-1/4"	P18564TC	1
GRAN FURY			MIRADA		
Axle Hsg Cover Gasket			Axle Hsg Cover Gasket		
1980-1989, 7.25" Ring Gear, 9 Bolt Holes, 8" X 9"	P27794	1	1980-1983, 7.25" Ring Gear, 9 Bolt Holes, 8" X 9"	P27794	1
1980-1989, 7.25" Ring Gear, 10 Bolt Holes, 9-1/2" X 9-5/8"	P38156	1	1980-1983, 7.25" Ring Gear, 10 Bolt Holes, 9-1/2" X 9-5/8"	P38156	1
1980-1989, 8.25" Ring Gear, 10 Bolt Holes, 10-1/4" X 11-1/4"	P18564	1	1980-1983, 8.25" Ring Gear, 10 Bolt Holes, 10-1/4" X 11-1/4"	P18564	1
1980-1989, 8.25" Ring Gear, 10 Bolt Holes, Tuff-Cork, 10-1/4" X 11-1/4"	P18564TC	1	1980-1983, 8.25" Ring Gear, 10 Bolt Holes, Tuff-Cork, 10-1/4" X 11-1/4"	P18564TC	1
1980-1981, 9.25" Gear, 12 Bolt Holes, 11-1/8" X 11-1/2"	P29352	1	1980-1983, 9.25" Gear, 12 Bolt Holes, 11-1/8" X 11-1/2"	P29352	1
1980-1981, 9.25" Gear, 12 Bolt Holes, Tuff-Cork, 11-1/8" X 11-1/2"	P29352TC	1	1980-1983, 9.25" Gear, 12 Bolt Holes, Tuff-Cork, 11-1/8" X 11-1/2"	P29352TC	1
1975-1977, 7.25" Ring Gear, 10 Bolt Holes, 9-1/2" X 9-5/8"	P38156	1	MONACO		
1975-1977, 9.25" Gear, 12 Bolt Holes, 11-1/8" X 11-1/2"	P29352	1	Axle Hsg Cover Gasket		
1975-1977, 9.25" Gear, 12 Bolt Holes, Tuff-Cork, 11-1/8" X 11-1/2"	P29352TC	1	1975-1978, 7.25" Ring Gear, 10 Bolt Holes, 9-1/2" X 9-5/8"	P38156	1
1973-1977, 7.25" Ring Gear, 9 Bolt Holes, 8" X 9"	P27794	1	1975-1978, 9.25" Gear, 12 Bolt Holes, 11-1/8" X 11-1/2"	P29352	1
1973-1977, 8.25" Ring Gear, 10 Bolt Holes, 10-1/4" X 11-1/4"	P18564	1	1975-1978, 9.25" Gear, 12 Bolt Holes, Tuff-Cork, 11-1/8" X 11-1/2"	P29352TC	1
1973-1977, 8.25" Ring Gear, 10 Bolt Holes, Tuff-Cork, 10-1/4" X 11-1/4"	P18564TC	1	1965-1978, 7.25" Ring Gear, 9 Bolt Holes, 8" X 9"	P27794	1
1973-1974, 9.25" Gear, 10 Bolt Holes, 10-1/4" X 10-3/4"	P27934	1	1965-1978, 8.25" Ring Gear, 10 Bolt Holes, 10-1/4" X 11-1/4"	P18564	1
1973-1974, 9.75" Gear, 10 Bolt Holes, 11" X 12"	P18562	1	1965-1978, 8.25" Ring Gear, 10 Bolt Holes, Tuff-Cork, 10-1/4" X 11-1/4"	P18564TC	1
1973-1974, 9.75" Gear, 10 Bolt Holes, Tuff-Cork, 11" X 12"	P18562TC	1	1965-1974, 9.25" Gear, 10 Bolt Holes, 10-1/4" X 10-3/4"	P27934	1
Diff. Carrier Gasket			1965-1974, 9.75" Gear, 10 Bolt Holes, 11" X 12"	P18562	1
1973-1977, 8.75" Ring Gear, 10 Bolt Holes, 10-5/16" X 10-5/16"	P27930	1	1965-1974, 9.75" Gear, 10 Bolt Holes, Tuff-Cork, 11" X 12"	P18562TC	1
			Diff. Carrier Gasket		
			1965-1978, 8.75" Ring Gear, 10 Bolt Holes, 10-5/16" X 10-5/16"	P27930	1

Differential Housing Cover Gaskets (cont.)

<i>Model & Application</i>	<i>Part No.</i>	<i>Qty.</i>	<i>Model & Application</i>	<i>Part No.</i>	<i>Qty.</i>
MONACO (cont.)			POLARA (cont.)		
Diff. Carrier Gasket (cont.)			Axle Hsg Cover Gasket (cont.)		
1965-1978, 9.75" Gear, 10 Bolt Holes, Tuff-Cork, 11" X 12"	P27930TC	1	1965-1973, 9.75" Gear, 10 Bolt Holes, 11" X 12"	P18562	1
NEW YORKER			1965-1973, 9.75" Gear, 10 Bolt Holes, Tuff-Cork, 11" X 12"	P18562TC	1
Axle Hsg Cover Gasket			Diff. Carrier Gasket		
1975-1982, 7.25" Ring Gear, 10 Bolt Holes, 9-1/2" X 9-5/8"	P38156	1	1965-1973, 8.75" Ring Gear, 10 Bolt Holes, 10-5/16" X 10-5/16"	P27930	1
1975-1982, 9.25" Gear, 12 Bolt Holes, 11-1/8" X 11-1/2"	P29352	1	1965-1973, 8.75" Ring Gear, 10 Bolt Holes, Tuff-Cork, 10-5/16" X 10-5/16"	P27930TC	1
1975-1982, 9.25" Gear, 12 Bolt Holes, Tuff-Cork, 11-1/8" X 11-1/2"	P29352TC	1	ROAD RUNNER		
1965-1982, 7.25" Ring Gear, 9 Bolt Holes, 8" X 9"	P27794	1	Axle Hsg Cover Gasket		
1965-1982, 8.25" Ring Gear, 10 Bolt Holes, 10-1/4" X 11-1/4"	P18564	1	1975, 7.25" Ring Gear, 9 Bolt Holes, 8" X 9"	P27794	1
1965-1982, 8.25" Ring Gear, 10 Bolt Holes, Tuff-Cork, 10-1/4" X 11-1/4"	P18564TC	1	1975, 7.25" Ring Gear, 10 Bolt Holes, 9-1/2" X 9-5/8"	P38156	1
1965-1974, 9.25" Gear, 10 Bolt Holes, 10-1/4" X 10-3/4"	P27934	1	1975, 8.25" Ring Gear, 10 Bolt Holes, 10-1/4" X 11-1/4"	P18564	1
1965-1974, 9.75" Gear, 10 Bolt Holes, 11" X 12"	P18562	1	1975, 8.25" Ring Gear, 10 Bolt Holes, Tuff-Cork, 10-1/4" X 11-1/4"	P18564TC	1
1965-1974, 9.75" Gear, 10 Bolt Holes, Tuff-Cork, 11" X 12"	P18562TC	1	1975, 9.25" Gear, 12 Bolt Holes, 11-1/8" X 11-1/2"	P29352	1
Diff. Carrier Gasket			1975, 9.25" Gear, 12 Bolt Holes, Tuff-Cork, 11-1/8" X 11-1/2"	P29352TC	1
1965-1977, 8.75" Ring Gear, 10 Bolt Holes, 10-5/16" X 10-5/16"	P27930	1	Diff. Carrier Gasket		
1965-1977, 8.75" Ring Gear, 10 Bolt Holes, Tuff-Cork, 10-5/16" X 10-5/16"	P27930TC	1	1975, 8.75" Ring Gear, 10 Bolt Holes, 10-5/16" X 10-5/16"	P27930	1
NEWPORT			1975, 8.75" Ring Gear, 10 Bolt Holes, Tuff-Cork, 10-5/16" X 10-5/16"	P27930TC	1
Axle Hsg Cover Gasket			ROYAL MONACO		
1975-1981, 7.25" Ring Gear, 10 Bolt Holes, 9-1/2" X 9-5/8"	P38156	1	Axle Hsg Cover Gasket		
1975-1981, 9.25" Gear, 12 Bolt Holes, 11-1/8" X 11-1/2"	P29352	1	1975-1977, 7.25" Ring Gear, 9 Bolt Holes, 8" X 9"	P27794	1
1975-1981, 9.25" Gear, 12 Bolt Holes, Tuff-Cork, 11-1/8" X 11-1/2"	P29352TC	1	1975-1977, 7.25" Ring Gear, 10 Bolt Holes, 9-1/2" X 9-5/8"	P38156	1
1965-1981, 7.25" Ring Gear, 9 Bolt Holes, 8" X 9"	P27794	1	1975-1977, 8.25" Ring Gear, 10 Bolt Holes, 10-1/4" X 11-1/4"	P18564	1
1965-1981, 8.25" Ring Gear, 10 Bolt Holes, 10-1/4" X 11-1/4"	P18564	1	1975-1977, 8.25" Ring Gear, 10 Bolt Holes, Tuff-Cork, 10-1/4" X 11-1/4"	P18564TC	1
1965-1981, 8.25" Ring Gear, 10 Bolt Holes, Tuff-Cork, 10-1/4" X 11-1/4"	P18564TC	1	1975-1977, 9.25" Gear, 12 Bolt Holes, 11-1/8" X 11-1/2"	P29352	1
1965-1974, 9.25" Gear, 10 Bolt Holes, 10-1/4" X 10-3/4"	P27934	1	1975-1977, 9.25" Gear, 12 Bolt Holes, Tuff-Cork, 11-1/8" X 11-1/2"	P29352TC	1
1965-1974, 9.75" Gear, 10 Bolt Holes, 11" X 12"	P18562	1	Diff. Carrier Gasket		
1965-1974, 9.75" Gear, 10 Bolt Holes, Tuff-Cork, 11" X 12"	P18562TC	1	1975-1977, 8.75" Ring Gear, 10 Bolt Holes, 10-5/16" X 10-5/16"	P27930	1
Diff. Carrier Gasket			1975-1977, 9.75" Gear, 10 Bolt Holes, Tuff-Cork, 11" X 12"	P27930TC	1
1965-1977, 8.75" Ring Gear, 10 Bolt Holes, 10-5/16" X 10-5/16"	P27930	1	SAPPORO		
1965-1977, 8.75" Ring Gear, 10 Bolt Holes, Tuff-Cork, 10-5/16" X 10-5/16"	P27930TC	1	Axle Hsg Cover Gasket		
POLARA			1978-1983, 10 Bolt Holes	P29082	1
Axle Hsg Cover Gasket			1978-1979, 8 Bolt Holes	P27629	1
1965-1973, 7.25" Ring Gear, 9 Bolt Holes, 8" X 9"	P27794	1	SCAMP		
1965-1973, 8.25" Ring Gear, 10 Bolt Holes, 10-1/4" X 11-1/4"	P18564	1	Axle Hsg Cover Gasket		
1965-1973, 8.25" Ring Gear, 10 Bolt Holes, Tuff-Cork, 10-1/4" X 11-1/4"	P18564TC	1	1973-1976, 7.25" Ring Gear, 10 Bolt Holes, 9-1/2" X 9-5/8"	P38156	1
1965-1973, 9.25" Gear, 10 Bolt Holes, 10-1/4" X 10-3/4"	P27934	1	1973-1976, 8.25" Ring Gear, 10 Bolt Holes, 10-1/4" X 11-1/4"	P18564	1
			1973-1976, 8.25" Ring Gear, 10 Bolt Holes, Tuff-Cork, 10-1/4" X 11-1/4"	P18564TC	1
			1971-1976, 7.25" Ring Gear, 9 Bolt Holes, 8" X 9"	P27794	1

Chrysler (cont.)

Differential Housing Cover Gaskets (cont.)

<i>Model & Application</i>	<i>Part No.</i>	<i>Qty.</i>	<i>Model & Application</i>	<i>Part No.</i>	<i>Qty.</i>
SCAMP (cont.)			ST. REGIS (cont.)		
Diff. Carrier Gasket			Axle Hsg Cover Gasket (cont.)		
1971-1972, 8.75" Ring Gear, 10 Bolt Holes, 10-5/16" X 10-5/16"	P27930	1	1979-1981, 7.25" Ring Gear, 10 Bolt Holes, 9-1/2" X 9-5/8"	P38156	1
1971-1972, 8.75" Ring Gear, 10 Bolt Holes, Tuff-Cork, 10-5/16" X 10-5/16"	P27930TC	1	1979-1981, 8.25" Ring Gear, 10 Bolt Holes, 10-1/4" X 11-1/4"	P18564	1
SPORT FURY			1979-1981, 8.25" Ring Gear, 10 Bolt Holes, Tuff-Cork, 10-1/4" X 11-1/4"	P18564TC	1
Axle Hsg Cover Gasket			1979-1981, 9.25" Gear, 12 Bolt Holes, 11-1/8" X 11-1/2"	P29352	1
1976, 7.25" Ring Gear, 9 Bolt Holes, 8" X 9"	P27794	1	1979-1981, 9.25" Gear, 12 Bolt Holes, Tuff-Cork, 11-1/8" X 11-1/2"	P29352TC	1
1976, 7.25" Ring Gear, 10 Bolt Holes, 9-1/2" X 9-5/8"	P38156	1	SUBURBANS		
1976, 8.25" Ring Gear, 10 Bolt Holes, 10-1/4" X 11-1/4"	P18564	1	Axle Hsg Cover Gasket		
1976, 8.25" Ring Gear, 10 Bolt Holes, Tuff-Cork, 10-1/4" X 11-1/4"	P18564TC	1	1972-1974, 7.25" Ring Gear, 9 Bolt Holes, 8" X 9"	P27794	1
1976, 9.25" Gear, 12 Bolt Holes, 11-1/8" X 11-1/2"	P29352	1	1972-1974, 8.25" Ring Gear, 10 Bolt Holes, 10-1/4" X 11-1/4"	P18564	1
1976, 9.25" Gear, 12 Bolt Holes, Tuff-Cork, 11-1/8" X 11-1/2"	P29352TC	1	1972-1974, 8.25" Ring Gear, 10 Bolt Holes, Tuff-Cork, 10-1/4" X 11-1/4"	P18564TC	1
1965-1971, 7.25" Ring Gear, 9 Bolt Holes, 8" X 9"	P27794	1	1972-1974, 9.25" Gear, 10 Bolt Holes, 10-1/4" X 10-3/4"	P27934	1
1965-1971, 8.25" Ring Gear, 10 Bolt Holes, 10-1/4" X 11-1/4"	P18564	1	1972-1974, 9.75" Gear, 10 Bolt Holes, 11" X 12"	P18562	1
1965-1971, 8.25" Ring Gear, 10 Bolt Holes, Tuff-Cork, 10-1/4" X 11-1/4"	P18564TC	1	1972-1974, 9.75" Gear, 10 Bolt Holes, Tuff-Cork, 11" X 12"	P18562TC	1
1965-1971, 9.25" Gear, 10 Bolt Holes, 10-1/4" X 10-3/4"	P27934	1	Diff. Carrier Gasket		
1965-1971, 9.75" Gear, 10 Bolt Holes, 11" X 12"	P18562	1	1972-1974, 8.75" Ring Gear, 10 Bolt Holes, 10-5/16" X 10-5/16"	P27930	1
1965-1971, 9.75" Gear, 10 Bolt Holes, Tuff-Cork, 11" X 12"	P18562TC	1	1972-1974, 8.75" Ring Gear, 10 Bolt Holes, Tuff-Cork, 10-5/16" X 10-5/16"	P27930TC	1
Diff. Carrier Gasket			VIP		
1976, 8.75" Ring Gear, 10 Bolt Holes, 10-5/16" X 10-5/16"	P27930	1	Axle Hsg Cover Gasket		
1976, 8.75" Ring Gear, 10 Bolt Holes, Tuff-Cork, 10-5/16" X 10-5/16"	P27930TC	1	1966-1969, 7.25" Ring Gear, 9 Bolt Holes, 8" X 9"	P27794	1
1965-1971, 8.75" Ring Gear, 10 Bolt Holes, 10-5/16" X 10-5/16"	P27930	1	1966-1969, 8.25" Ring Gear, 10 Bolt Holes, 10-1/4" X 11-1/4"	P18564	1
1965-1971, 8.75" Ring Gear, 10 Bolt Holes, Tuff-Cork, 10-5/16" X 10-5/16"	P27930TC	1	1966-1969, 8.25" Ring Gear, 10 Bolt Holes, Tuff-Cork, 10-1/4" X 11-1/4"	P18564TC	1
SPORT FURY GT			1966-1969, 9.25" Gear, 10 Bolt Holes, 10-1/4" X 10-3/4"	P27934	1
Axle Hsg Cover Gasket			1966-1969, 9.75" Gear, 10 Bolt Holes, 11" X 12"	P18562	1
1970-1971, 7.25" Ring Gear, 9 Bolt Holes, 8" X 9"	P27794	1	1966-1969, 9.75" Gear, 10 Bolt Holes, Tuff-Cork, 11" X 12"	P18562TC	1
1970-1971, 8.25" Ring Gear, 10 Bolt Holes, 10-1/4" X 11-1/4"	P18564	1	Diff. Carrier Gasket		
1970-1971, 8.25" Ring Gear, 10 Bolt Holes, Tuff-Cork, 10-1/4" X 11-1/4"	P18564TC	1	1966-1969, 8.75" Ring Gear, 10 Bolt Holes, 10-5/16" X 10-5/16"	P27930	1
1970-1971, 9.25" Gear, 10 Bolt Holes, 10-1/4" X 10-3/4"	P27934	1	1966-1969, 8.75" Ring Gear, 10 Bolt Holes, Tuff-Cork, 10-5/16" X 10-5/16"	P27930TC	1
1970-1971, 9.75" Gear, 10 Bolt Holes, 11" X 12"	P18562	1	VALIANT		
1970-1971, 9.75" Gear, 10 Bolt Holes, Tuff-Cork, 11" X 12"	P18562TC	1	Axle Hsg Cover Gasket		
Diff. Carrier Gasket			1973-1976, 7.25" Ring Gear, 10 Bolt Holes, 9-1/2" X 9-5/8"	P38156	1
1970-1971, 8.75" Ring Gear, 10 Bolt Holes, 10-5/16" X 10-5/16"	P27930	1	1973-1976, 8.25" Ring Gear, 10 Bolt Holes, 10-1/4" X 11-1/4"	P18564	1
1970-1971, 8.75" Ring Gear, 10 Bolt Holes, Tuff-Cork, 10-5/16" X 10-5/16"	P27930TC	1	1973-1976, 8.25" Ring Gear, 10 Bolt Holes, Tuff-Cork, 10-1/4" X 11-1/4"	P18564TC	1
ST. REGIS			1965-1976, 7.25" Ring Gear, 9 Bolt Holes, 8" X 9"	P27794	1
Axle Hsg Cover Gasket			Diff. Carrier Gasket		
1979-1981, 7.25" Ring Gear, 9 Bolt Holes, 8" X 9"	P27794	1	1967-1972, 8.75" Ring Gear, 10 Bolt Holes, 10-5/16" X 10-5/16"	P27930	1
			1967-1972, 8.75" Ring Gear, 10 Bolt Holes, Tuff-Cork, 10-5/16" X 10-5/16"	P27930TC	1

Differential Housing Cover Gaskets (cont.)

<i>Model & Application</i>	<i>Part No.</i>	<i>Qty.</i>	<i>Model & Application</i>	<i>Part No.</i>	<i>Qty.</i>
VOLARE			VOLARE (cont.)		
Axle Hsg Cover Gasket			Axle Hsg Cover Gasket (cont.)		
1976-1980, 7.25" Ring Gear, 9 Bolt Holes, 8" X 9"	P27794	1	1976-1980, 8.25" Ring Gear, 10 Bolt Holes, 10-1/4" X 11-1/4"	P18564	1
1976-1980, 7.25" Ring Gear, 10 Bolt Holes, 9-1/2" X 9-5/8"	P38156	1	1976-1980, 8.25" Ring Gear, 10 Bolt Holes, Tuff-Cork, 10-1/4" X 11-1/4"	P18564TC	1

Transmission Gaskets

<i>Model & Application</i>	<i>Part No.</i>	<i>Qty.</i>	<i>Model & Application</i>	<i>Part No.</i>	<i>Qty.</i>
024			400		
Transaxle Diff. Cvr Gasket			Transaxle Diff. Cvr Gasket		
1981, A404 Transaxle, A413 Transaxle, A470 Transaxle, A670 Transaxle, Tuff-Cork	W37731TC	1	1982-1983, A404 Transaxle, A413 Transaxle, A470 Transaxle, A670 Transaxle, Tuff-Cork.	W37731TC	1
Transaxle End Cvr. Gasket			Transaxle End Cvr. Gasket		
1981, A404 Transaxle, A413 Transaxle, A470 Transaxle, Rear, Tuff-Cork.	W37347TC	1	1982-1983, A404 Transaxle, A413 Transaxle, A470 Transaxle, Rear, Tuff-Cork	W37347TC	1
Transaxle Pan Gasket			Transaxle Pan Gasket		
1981, A404 Transaxle, A413 Transaxle, A470 Transaxle, A670 Transaxle, Tuff-Cork	W38795TC	1	1982-1983, A404 Transaxle, A413 Transaxle, A470 Transaxle, A670 Transaxle, Tuff-Cork.	W38795TC	1
300			440		
Transmission Pan Gasket			Transmission Pan Gasket		
1962-1971, A727 Automatic Transmission	W39003	1	1963-1964, A727 Automatic Transmission	W39003	1
1962-1971, A727 Automatic Transmission, Tuff-Cork	W39003TC	1	1963-1964, A727 Automatic Transmission, Tuff-Cork	W39003TC	1
1962-1971, A904; A94-1 Automatic Transmission.	W38031	1	1963-1964, A904; A94-1 Automatic Transmission.	W38031	1
300H			5TH AVENUE		
Transmission Pan Gasket			Transmission Pan Gasket		
1962, A727 Automatic Transmission	W39003	1	1986-1989, A904 Automatic Transmission, A999 Automatic Transmission	W38031	1
1962, A727 Automatic Transmission, Tuff-Cork	W39003TC	1	1983-1989, A727 Automatic Transmission	W39003	1
1962, A904; A94-1 Automatic Transmission	W38031	1	1983-1989, A727 Automatic Transmission, Tuff-Cork	W39003TC	1
300J			1983-1985, A904 Automatic Transmission		
Transmission Pan Gasket			Transmission Pan Gasket		
1963, A727 Automatic Transmission	W39003	1	1983-1985, A904 Automatic Transmission	W38031	1
1963, A727 Automatic Transmission, Tuff-Cork	W39003TC	1	600		
1963, A904; A94-1 Automatic Transmission	W38031	1	Transaxle Diff. Cvr Gasket		
300K			1983-1988, A404 Transaxle, A413 Transaxle, A470 Transaxle, A670 Transaxle, Tuff-Cork.		
Transmission Pan Gasket		 W37731TC		
1964, A727 Automatic Transmission	W39003	1	Transaxle End Cvr. Gasket		
1964, A727 Automatic Transmission, Tuff-Cork	W39003TC	1	1983-1986, A404 Transaxle, A413 Transaxle, A470 Transaxle, Rear, Tuff-Cork		
1964, A904; A94-1 Automatic Transmission	W38031	1 W37347TC		
300L			Transaxle Pan Gasket		
Transmission Pan Gasket			1983-1988, A404 Transaxle, A413 Transaxle, A470 Transaxle, A670 Transaxle, Tuff-Cork.		
1965, A727 Automatic Transmission	W39003	1 W38795TC		
1965, A727 Automatic Transmission, Tuff-Cork	W39003TC	1	800		
1965, A904; A94-1 Automatic Transmission	W38031	1	Transmission Pan Gasket		
330			1964, A727 Automatic Transmission		
Transmission Pan Gasket		 W39003		
1963-1964, A727 Automatic Transmission	W39003	1	1964, A727 Automatic Transmission, Tuff-Cork		
1963-1964, A727 Automatic Transmission, Tuff-Cork	W39003TC	1 W39003TC		
1963-1964, A904; A94-1 Automatic Transmission.	W38031	1	1964, A904; A94-1 Automatic Transmission		
880		 W38031		
Transmission Pan Gasket			Transmission Pan Gasket		
1962-1965, A727 Automatic Transmission	W39003	1	1962-1965, A727 Automatic Transmission		
		 W39003		

Chrysler (cont.)

Transmission Gaskets (cont.)

<i>Model & Application</i>	<i>Part No.</i>	<i>Qty.</i>	<i>Model & Application</i>	<i>Part No.</i>	<i>Qty.</i>
880 (cont.)			BELVEDERE (cont.)		
Transmission Pan Gasket (cont.)			Transmission Pan Gasket (cont.)		
1962-1965, A727 Automatic Transmission, Tuff-Cork	W39003TC	1	1967-1970, A727 Automatic Transmission, Tuff-Cork	W39003TC	1
1962-1965, A904; A94-1 Automatic Transmission	W38031	1	1967-1970, A904; A94-1 Automatic Transmission	W38031	1
ACCLAIM			1962-1964, A727 Automatic Transmission		
Transaxle Diff. Cvr Gasket			1962-1964, A727 Automatic Transmission, Tuff-Cork		
1989-1991, A404 Transaxle, A413 Transaxle, A470 Transaxle, A670 Transaxle, Tuff-Cork	W37731TC	1	1962-1964, A904; A94-1 Automatic Transmission	W38031	1
1989-1991, A604 Transaxle, Tuff-Cork	W39376TC	1	BELVEDERE I		
Transaxle End Cvr. Gasket			Transmission Pan Gasket		
1989-1991, A604 Transaxle, Rear, Tuff-Cork	W39377TC	1	1965-1967, A727 Automatic Transmission	W39003	1
Transaxle Pan Gasket			1965-1967, A727 Automatic Transmission, Tuff-Cork		
1989-1991, A404 Transaxle, A413 Transaxle, A470 Transaxle, A670 Transaxle, Tuff-Cork	W38795TC	1	1965-1967, A904; A94-1 Automatic Transmission	W38031	1
1989-1991, A604 Transaxle, Tuff-Cork	W39375TC	1	BELVEDERE II		
ARIES			Transmission Pan Gasket		
Transaxle Diff. Cvr Gasket			1965-1967, A727 Automatic Transmission		
1989, A604 Transaxle, Tuff-Cork	W39376TC	1	1965-1967, A727 Automatic Transmission, Tuff-Cork	W39003TC	1
1981-1988, A404 Transaxle, A413 Transaxle, A470 Transaxle, A670 Transaxle, Tuff-Cork	W37731TC	1	1965-1967, A904; A94-1 Automatic Transmission	W38031	1
Transaxle End Cvr. Gasket			BELVEDERE SATELLITE		
1989, A604 Transaxle, Rear, Tuff-Cork	W39377TC	1	Transmission Pan Gasket		
1981-1986, A404 Transaxle, A413 Transaxle, A470 Transaxle, Rear, Tuff-Cork	W37347TC	1	1965-1966, A727 Automatic Transmission		
Transaxle Pan Gasket			1965-1966, A727 Automatic Transmission, Tuff-Cork		
1989, A604 Transaxle, Tuff-Cork	W39375TC	1	1965-1966, A904; A94-1 Automatic Transmission	W38031	1
1981-1988, A404 Transaxle, A413 Transaxle, A470 Transaxle, A670 Transaxle, Tuff-Cork	W38795TC	1	BROUGHAM		
ARROW			Transmission Pan Gasket		
Transmission Pan Gasket			1977, A727 Automatic Transmission		
1976-1980, A904 Automatic Transmission	W39081	1	1977, A727 Automatic Transmission, Tuff-Cork	W39003TC	1
ASPEN			1977, A904; A94-1 Automatic Transmission	W38031	1
Transmission Gasket Set			CARAVELLE		
1979-1980, A230 Transmission	TS29044Y	1	Transaxle Diff. Cvr Gasket		
1977-1980, A833 Overdrive Transmission	TS27904	1	1985-1988, A404 Transaxle, A413 Transaxle, A470 Transaxle, A670 Transaxle, Tuff-Cork		
1977-1978, A230 Transmission, Short Extension	TS29044Y	1	1985-1986, A404 Transaxle, A413 Transaxle, A470 Transaxle, Rear, Tuff-Cork		
1976, A230 Transmission	TS29044Y	1	1985-1988, A404 Transaxle, A413 Transaxle, A470 Transaxle, A670 Transaxle, Tuff-Cork		
1976, A390 Transmission	TS29046	1	1985-1988, A404 Transaxle, A413 Transaxle, A470 Transaxle, A670 Transaxle, Tuff-Cork		
Transmission Pan Gasket			1985-1988, A404 Transaxle, A413 Transaxle, A470 Transaxle, A670 Transaxle, Tuff-Cork		
1976-1980, A727 Automatic Transmission	W39003	1	1985-1988, A404 Transaxle, A413 Transaxle, A470 Transaxle, A670 Transaxle, Tuff-Cork		
1976-1980, A727 Automatic Transmission, Tuff-Cork	W39003TC	1	1985-1988, A404 Transaxle, A413 Transaxle, A470 Transaxle, A670 Transaxle, Tuff-Cork		
1976-1980, A904 Automatic Transmission	W38031	1	1985-1988, A404 Transaxle, A413 Transaxle, A470 Transaxle, A670 Transaxle, Tuff-Cork		
BARRACUDA			CHALLENGER		
Transmission Pan Gasket			Transmission Pan Gasket		
1967-1974, A727 Automatic Transmission	W39003	1	1978-1983, A904 Automatic Transmission		
1967-1974, A727 Automatic Transmission, Tuff-Cork	W39003TC	1	1970-1974, A727 Automatic Transmission		
1967-1974, A904; A94-1 Automatic Transmission	W38031	1	1970-1974, A727 Automatic Transmission, Tuff-Cork		
BELVEDERE			1970-1974, A904; A94-1 Automatic Transmission		
Transmission Pan Gasket			1970-1974, A904; A94-1 Automatic Transmission		
1967-1970, A727 Automatic Transmission	W39003	1	1970-1974, A904; A94-1 Automatic Transmission		

Transmission Gaskets (cont.)					
Model & Application		Part No.	Qty.	Model & Application	
CHAMP			CONQUEST		
Transaxle Diff. Cvr Gasket				Transmission Pan Gasket	
1979, A404 Transaxle, A413 Transaxle, A470 Transaxle, A670 Transaxle, Tuff-Cork		W37731TC	1	1984-1989, Automatic Transmission	
				W39108 1	
Transaxle End Cvr. Gasket				CORDOBA	
1979, A404 Transaxle, Rear, Tuff-Cork		W37347TC	1	Transmission Pan Gasket	
				1975-1983, A727 Automatic Transmission	
				1975-1983, A727 Automatic Transmission, Tuff-Cork	
				W39003 1	
				1975-1983, A904; A94-1 Automatic Transmission	
				W38031 1	
Transaxle Pan Gasket				CORONET	
1981-1982, Automatic Transmission, From 11/81		W28798	1	Transmission Gasket Set	
				1975-1976, A230 Transmission	
				1975-1976, A390 Transmission	
				TS29044Y 1	
				TS29046 1	
				Transmission Pan Gasket	
1979, A404 Transaxle, A413 Transaxle, A470 Transaxle, A670 Transaxle, Tuff-Cork		W38795TC	1	1965-1976, A727 Automatic Transmission	
				1965-1976, A727 Automatic Transmission, Tuff-Cork	
				W39003 1	
				1965-1976, A904; A94-1 Automatic Transmission	
				W38031 1	
CHARGER			DART		
Transaxle Diff. Cvr Gasket				Transmission Gasket Set	
1983-1987, A404 Transaxle, A413 Transaxle, A470 Transaxle, A670 Transaxle, Tuff-Cork		W37731TC	1	1975-1976, A390 Transmission	
				1973-1974, 3 Speed Transmission	
				TS29046 1	
				TS29044Y 1	
Transaxle End Cvr. Gasket				Transmission Pan Gasket	
1983-1986, A404 Transaxle, A413 Transaxle, A470 Transaxle, Rear, Tuff-Cork		W37347TC	1	1962-1974, A727 Automatic Transmission	
				1962-1974, A727 Automatic Transmission, Tuff-Cork	
				W39003 1	
				1962-1974, A904 Automatic Transmission, A904; A94-1 Automatic Transmission	
				W38031 1	
Transaxle Pan Gasket				DAYTONA	
1983-1987, A404 Transaxle, A413 Transaxle, A470 Transaxle, A670 Transaxle, Tuff-Cork		W38795TC	1	Transaxle Diff. Cvr Gasket	
				1989-1991, A604 Transaxle, Tuff-Cork	
				1984-1988, A404 Transaxle, A413 Transaxle, A470 Transaxle, A670 Transaxle, Tuff-Cork	
				W39376TC 1	
				W37731TC 1	
Transmission Gasket Set				Transaxle End Cvr. Gasket	
1976, A230 Transmission		TS29044Y	1	1989-1991, A604 Transaxle, Rear, Tuff-Cork	
1976, A390 Transmission		TS29046	1	1984-1986, A404 Transaxle, A413 Transaxle, A470 Transaxle, Rear, Tuff-Cork	
				W39377TC 1	
				1984-1986, A404 Transaxle, A413 Transaxle, A470 Transaxle, Rear, Tuff-Cork	
				W37347TC 1	
Transmission Pan Gasket				Transaxle Pan Gasket	
1966-1974, A727 Automatic Transmission		W39003	1	1989-1991, A604 Transaxle, Tuff-Cork	
1966-1974, A727 Automatic Transmission, Tuff-Cork		W39003TC	1	1984-1988, A404 Transaxle, A413 Transaxle, A470 Transaxle, A670 Transaxle, Tuff-Cork	
1966-1974, A904 Automatic Transmission, A904; A94-1 Automatic Transmission		W38031	1	W39375TC 1	
				1984-1988, A404 Transaxle, A413 Transaxle, A470 Transaxle, A670 Transaxle, Tuff-Cork	
				W38795TC 1	
COLT			DIPLOMAT		
Transaxle Diff. Cvr Gasket				Transmission Gasket Set	
1978-1979, A404 Transaxle, A413 Transaxle, A470 Transaxle, A670 Transaxle, Tuff-Cork		W37731TC	1	1977-1981, A833 Overdrive Transmission	
				TS27904 1	
Transaxle End Cvr. Gasket				Transmission Pan Gasket	
1978-1979, A404 Transaxle, Rear, Tuff-Cork		W37347TC	1	1977-1989, A727 Automatic Transmission	
				1977-1989, A727 Automatic Transmission, Tuff-Cork	
				W39003 1	
				1977-1989, A904 Automatic Transmission, A999 Automatic Transmission	
				W38031 1	
Transaxle Pan Gasket				DUSTER	
1983-1993, Automatic Transmission		W28798	1	Transmission Gasket Set	
1981, Automatic Transmission		W28798	1	1975-1976, A390 Transmission	
1978-1979, A404 Transaxle, A413 Transaxle, A470 Transaxle, A670 Transaxle, Tuff-Cork		W38795TC	1	1973-1975, A230 Transmission	
				1973-1974, 3 Speed Transmission	
				TS29046 1	
				TS29044Y 1	
				TS29044Y 1	
COLT 100			COLT 200		
Transaxle Pan Gasket				Transaxle Pan Gasket	
1989-1992, Automatic Transmission		W28798	1	1989-1992, Automatic Transmission	
				W28798 1	
COLT PREMIER			COLT PREMIER		
Transaxle Pan Gasket				Transaxle Pan Gasket	
1985-1988, Automatic Transmission		W28798	1	1985-1988, Automatic Transmission	
				W28798 1	

Chrysler (cont.)

Transmission Gaskets (cont.)

<i>Model & Application</i>	<i>Part No.</i>	<i>Qty.</i>	<i>Model & Application</i>	<i>Part No.</i>	<i>Qty.</i>
DUSTER (cont.)			FURY		
Transmission Pan Gasket			Transmission Gasket Set		
1970-1975, A727 Automatic Transmission	W39003	1	1977-1978, A230 Transmission, Short Extension	TS29044Y	1
1970-1975, A727 Automatic Transmission, Tuff-Cork	W39003TC	1	1975-1976, A230 Transmission	TS29044Y	1
1970-1975, A904; A94-1 Automatic Transmission	W38031	1	1975-1976, A390 Transmission	TS29046	1
DYNASTY			Transmission Pan Gasket		
Transaxle Diff. Cvr Gasket			1975-1978, A727 Automatic Transmission		
1989-1991, A604 Transaxle, Tuff-Cork	W39376TC	1	1975-1978, A727 Automatic Transmission, Tuff-Cork	W39003TC	1
1988, A404 Transaxle, A413 Transaxle, A470 Transaxle, A670 Transaxle, Tuff-Cork	W37731TC	1	1975-1978, A904 Automatic Transmission	W38031	1
Transaxle End Cvr. Gasket			1962-1964, A727 Automatic Transmission		
1989-1991, A604 Transaxle, Rear, Tuff-Cork .	W39377TC	1	1962-1964, A727 Automatic Transmission, Tuff-Cork	W39003TC	1
Transaxle Pan Gasket			1962-1964, A904 Automatic Transmission, A904; A94-1 Automatic Transmission.		
1989-1991, A604 Transaxle, Tuff-Cork	W39375TC	1	FURY CUSTOM		
1988, A404 Transaxle, A413 Transaxle, A470 Transaxle, A670 Transaxle, Tuff-Cork	W38795TC	1	Transmission Pan Gasket		
E-CLASS			1971, A727 Automatic Transmission		
Transaxle Diff. Cvr Gasket			1971, A727 Automatic Transmission, Tuff-Cork		
1983-1984, A404 Transaxle, A413 Transaxle, A470 Transaxle, A670 Transaxle, Tuff-Cork	W37731TC	1	1971, A904; A94-1 Automatic Transmission . . .		
Transaxle End Cvr. Gasket			FURY GRAND COUPE		
1983-1984, A404 Transaxle, A413 Transaxle, A470 Transaxle, Rear, Tuff-Cork	W37347TC	1	Transmission Pan Gasket		
Transaxle Pan Gasket			1972, A727 Automatic Transmission		
1983-1984, A404 Transaxle, A413 Transaxle, A470 Transaxle, A670 Transaxle, Tuff-Cork	W38795TC	1	1972, A727 Automatic Transmission, Tuff-Cork		
EXECUTIVE LIMOUSINE			1972, A904; A94-1 Automatic Transmission . . .		
Transaxle Diff. Cvr Gasket			1970, A727 Automatic Transmission		
1983-1986, A404 Transaxle, A413 Transaxle, A470 Transaxle, A670 Transaxle, Tuff-Cork	W37731TC	1	1970, A727 Automatic Transmission, Tuff-Cork		
Transaxle End Cvr. Gasket			1970, A904; A94-1 Automatic Transmission . . .		
1983-1986, A404 Transaxle, A413 Transaxle, A470 Transaxle, Rear, Tuff-Cork	W37347TC	1	FURY GRAND SEDAN		
Transaxle Pan Gasket			Transmission Pan Gasket		
1983-1986, A404 Transaxle, A413 Transaxle, A470 Transaxle, A670 Transaxle, Tuff-Cork	W38795TC	1	1972, A727 Automatic Transmission		
EXECUTIVE SEDAN			1972, A727 Automatic Transmission, Tuff-Cork		
Transaxle Diff. Cvr Gasket			1972, A904; A94-1 Automatic Transmission . . .		
1983-1984, A404 Transaxle, A413 Transaxle, A470 Transaxle, A670 Transaxle, Tuff-Cork	W37731TC	1	FURY I		
Transaxle End Cvr. Gasket			Transmission Pan Gasket		
1983-1984, A404 Transaxle, A413 Transaxle, A470 Transaxle, Rear, Tuff-Cork	W37347TC	1	1965-1974, A727 Automatic Transmission		
Transaxle Pan Gasket			1965-1974, A727 Automatic Transmission, Tuff-Cork		
1983-1986, A404 Transaxle, A413 Transaxle, A470 Transaxle, A670 Transaxle, Tuff-Cork	W38795TC	1	1965-1974, A904; A94-1 Automatic Transmission.		
EXECUTIVE SEDAN			FURY II		
Transaxle Diff. Cvr Gasket			Transmission Pan Gasket		
1983-1984, A404 Transaxle, A413 Transaxle, A470 Transaxle, A670 Transaxle, Tuff-Cork	W37731TC	1	1965-1974, A727 Automatic Transmission		
Transaxle End Cvr. Gasket			1965-1974, A727 Automatic Transmission, Tuff-Cork		
1983-1984, A404 Transaxle, A413 Transaxle, A470 Transaxle, Rear, Tuff-Cork	W37347TC	1	1965-1974, A904; A94-1 Automatic Transmission.		
Transaxle Pan Gasket			FURY III		
1983-1984, A404 Transaxle, A413 Transaxle, A470 Transaxle, A670 Transaxle, Tuff-Cork	W38795TC	1	Transmission Pan Gasket		
			1965-1974, A727 Automatic Transmission		
			1965-1974, A727 Automatic Transmission, Tuff-Cork		
			1965-1974, A904; A94-1 Automatic Transmission.		

Transmission Gaskets (cont.)

<i>Model & Application</i>	<i>Part No.</i>	<i>Qty.</i>	<i>Model & Application</i>	<i>Part No.</i>	<i>Qty.</i>
GTX			LANCER (cont.)		
Transmission Pan Gasket			Transaxle End Cvr. Gasket (cont.)		
1971, A727 Automatic Transmission	W39003	1	1985-1986, A404 Transaxle, A413 Transaxle, A470 Transaxle, Rear, Tuff-Cork	W37347TC	1
1971, A727 Automatic Transmission, Tuff-Cork	W39003TC	1	Transaxle Pan Gasket		
1971, A904; A94-1 Automatic Transmission	W38031	1	1989, A604 Transaxle, Tuff-Cork	W39375TC	1
1967-1969, A727 Automatic Transmission	W39003	1	1985-1988, A404 Transaxle, A413 Transaxle, A470 Transaxle, A670 Transaxle, Tuff-Cork	W38795TC	1
1967-1969, A727 Automatic Transmission, Tuff-Cork	W39003TC	1	Transmission Pan Gasket		
1967-1969, A904; A94-1 Automatic Transmission	W38031	1	1962, A727 Automatic Transmission	W39003	1
GRAN FURY			LANCER (cont.)		
Transmission Pan Gasket			Transaxle End Cvr. Gasket (cont.)		
1986-1989, A904 Automatic Transmission, A999 Automatic Transmission	W38031	1	1985-1988, A404 Transaxle, A413 Transaxle, A470 Transaxle, Rear, Tuff-Cork	W37347TC	1
1980-1989, A727 Automatic Transmission	W39003	1	Transaxle Pan Gasket		
1980-1989, A727 Automatic Transmission, Tuff-Cork	W39003TC	1	1989, A604 Transaxle, Tuff-Cork	W39375TC	1
1980-1985, A904 Automatic Transmission	W38031	1	1985-1988, A404 Transaxle, A413 Transaxle, A470 Transaxle, A670 Transaxle, Tuff-Cork	W38795TC	1
1975-1978, A904 Automatic Transmission	W38031	1	Transmission Pan Gasket		
1973-1978, A727 Automatic Transmission	W39003	1	1962, A727 Automatic Transmission, Tuff-Cork	W39003TC	1
1973-1978, A727 Automatic Transmission, Tuff-Cork	W39003TC	1	1962, A904 Automatic Transmission, A904; A94-1 Automatic Transmission.	W38031	1
1973-1974, A904; A94-1 Automatic Transmission	W38031	1	LASER		
1973, A904 Automatic Transmission, A904; A94-1 Automatic Transmission.	W38031	1	Transaxle Diff. Cvr Gasket		
HORIZON			1984-1986, A404 Transaxle, A413 Transaxle, A470 Transaxle, A670 Transaxle, Tuff-Cork		
Transaxle Diff. Cvr Gasket			1984-1986, A404 Transaxle, A413 Transaxle, A470 Transaxle, A670 Transaxle, Tuff-Cork		
1978-1988, A404 Transaxle, A413 Transaxle, A470 Transaxle, A670 Transaxle, Tuff-Cork	W37731TC	1	Transaxle End Cvr. Gasket		
Transaxle End Cvr. Gasket			1984-1986, A404 Transaxle, A413 Transaxle, A470 Transaxle, Rear, Tuff-Cork		
1980-1986, A404 Transaxle, A413 Transaxle, A470 Transaxle, Rear, Tuff-Cork	W37347TC	1	Transaxle Pan Gasket		
1978-1979, A404 Transaxle, Rear, Tuff-Cork .	W37347TC	1	1984-1986, A404 Transaxle, A413 Transaxle, A470 Transaxle, A670 Transaxle, Tuff-Cork	W38795TC	1
Transaxle Gasket Set			LEBARON		
1978-1981, A412 Transaxle	TS27917	1	Transaxle Diff. Cvr Gasket		
Transaxle Pan Gasket			1989-1991, A604 Transaxle, Tuff-Cork		
1978-1988, A404 Transaxle, A413 Transaxle, A470 Transaxle, A670 Transaxle, Tuff-Cork	W38795TC	1	1982-1988, A404 Transaxle, A413 Transaxle, A470 Transaxle, A670 Transaxle, Tuff-Cork	W39376TC	1
IMPERIAL			Transaxle End Cvr. Gasket		
Transaxle Diff. Cvr Gasket			1989-1991, A604 Transaxle, Rear, Tuff-Cork .		
1990-1991, A604 Transaxle, Tuff-Cork	W39376TC	1	1982-1988, A404 Transaxle, A413 Transaxle, A470 Transaxle, Rear, Tuff-Cork	W39377TC	1
Transaxle End Cvr. Gasket			Transaxle Pan Gasket		
1990-1991, A604 Transaxle, Rear, Tuff-Cork .	W39377TC	1	1990-1991, A604 Transaxle, Tuff-Cork	W39375TC	1
Transaxle Pan Gasket			Transmission Pan Gasket		
1990-1991, A604 Transaxle, Tuff-Cork	W39375TC	1	1977-1983, A904; A94-1 Automatic Transmission	W38031	1
Transmission Pan Gasket			1977-1981, A727 Automatic Transmission		
1981-1983, A727 Automatic Transmission	W39003	1	1977-1981, A727 Automatic Transmission, Tuff-Cork	W39003TC	1
1981-1983, A727 Automatic Transmission, Tuff-Cork	W39003TC	1	1975, A727 Automatic Transmission	W39003	1
1981-1983, A904 Automatic Transmission	W38031	1	MAGNUM		
LANCER			Transmission Pan Gasket		
Transaxle Diff. Cvr Gasket			1978-1979, A727 Automatic Transmission		
1989, A604 Transaxle, Tuff-Cork	W39376TC	1	1978-1979, A727 Automatic Transmission, Tuff-Cork	W39003TC	1
1985-1988, A404 Transaxle, A413 Transaxle, A470 Transaxle, A670 Transaxle, Tuff-Cork	W37731TC	1	1978-1979, A904; A94-1 Automatic Transmission	W38031	1
Transaxle End Cvr. Gasket					
1989, A604 Transaxle, Rear, Tuff-Cork	W39377TC	1			

Chrysler (cont.)

Transmission Gaskets (cont.)

<i>Model & Application</i>	<i>Part No.</i>	<i>Qty.</i>	<i>Model & Application</i>	<i>Part No.</i>	<i>Qty.</i>
MIRADA			POLARA		
Transmission Pan Gasket			Transmission Pan Gasket		
1980-1983, A727 Automatic Transmission	W39003	1	1962-1973, A727 Automatic Transmission	W39003	1
1980-1983, A727 Automatic Transmission, Tuff-Cork	W39003TC	1	1962-1973, A727 Automatic Transmission, Tuff-Cork	W39003TC	1
1980-1983, A904 Automatic Transmission	W38031	1	1962-1973, A904 Automatic Transmission, A904; A94-1 Automatic Transmission.	W38031	1
MONACO			RELIANT		
Transmission Gasket Set			Transaxle Diff. Cvr Gasket		
1977-1978, A230 Transmission, Short Extension	TS29044Y	1	1989, A604 Transaxle, Tuff-Cork	W39376TC	1
Transmission Pan Gasket			1981-1988, A404 Transaxle, A413 Transaxle, A470 Transaxle, A670 Transaxle, Tuff-Cork.		
1965-1978, A727 Automatic Transmission	W39003	1		W37731TC	1
1965-1978, A727 Automatic Transmission, Tuff-Cork	W39003TC	1	Transaxle End Cvr. Gasket		
1965-1978, A904; A94-1 Automatic Transmission.	W38031	1	1989, A604 Transaxle, Rear, Tuff-Cork		
NEW YORKER					
Transaxle Diff. Cvr Gasket			1981-1986, A404 Transaxle, A413 Transaxle, A470 Transaxle, Rear, Tuff-Cork		
1989-1991, A604 Transaxle, Tuff-Cork	W39376TC	1		W37347TC	1
1983-1988, A404 Transaxle, A413 Transaxle, A470 Transaxle, A670 Transaxle, Tuff-Cork.	W37731TC	1	Transaxle Pan Gasket		
Transaxle End Cvr. Gasket			1989, A604 Transaxle, Tuff-Cork		
1989-1991, A604 Transaxle, Rear, Tuff-Cork .	W39377TC	1	1981-1988, A404 Transaxle, A413 Transaxle, A470 Transaxle, A670 Transaxle, Tuff-Cork.		
1983-1986, A404 Transaxle, A413 Transaxle, A470 Transaxle, Rear, Tuff-Cork	W37347TC	1		W39375TC	1
Transaxle Pan Gasket			1981-1988, A404 Transaxle, A413 Transaxle, A470 Transaxle, A670 Transaxle, Tuff-Cork.		
1989-1991, A604 Transaxle, Tuff-Cork	W39375TC	1		W38795TC	1
1983-1988, A404 Transaxle, A413 Transaxle, A470 Transaxle, A670 Transaxle, Tuff-Cork.	W38795TC	1	ROAD RUNNER		
Transmission Pan Gasket			Transmission Pan Gasket		
1975-1985, A904 Automatic Transmission	W38031	1	1968-1975, A727 Automatic Transmission	W39003	1
1962-1982, A727 Automatic Transmission	W39003	1	1968-1975, A727 Automatic Transmission, Tuff-Cork	W39003TC	1
1962-1982, A727 Automatic Transmission, Tuff-Cork	W39003TC	1	1968-1975, A904; A94-1 Automatic Transmission.	W38031	1
1962-1974, A904; A94-1 Automatic Transmission.	W38031	1	ROYAL MONACO		
NEWPORT			Transmission Gasket Set		
Transmission Pan Gasket			1977, A230 Transmission, Short Extension . .		
1962-1974, A727 Automatic Transmission	W39003	1		TS29044Y	1
1962-1974, A727 Automatic Transmission, Tuff-Cork	W39003TC	1	Transmission Pan Gasket		
1962-1974, A904; A94-1 Automatic Transmission.	W38031	1	1975-1977, A727 Automatic Transmission		
OMNI			1975-1977, A727 Automatic Transmission, Tuff-Cork		
Transaxle Diff. Cvr Gasket			1975-1977, A904 Automatic Transmission		
1978-1987, A404 Transaxle, A413 Transaxle, A470 Transaxle, A670 Transaxle, Tuff-Cork.	W37731TC	1		W39003	1
Transaxle End Cvr. Gasket			1975-1977, A904 Automatic Transmission		
1980-1986, A404 Transaxle, A413 Transaxle, A470 Transaxle, Rear, Tuff-Cork	W37347TC	1		W39003TC	1
1978-1979, A404 Transaxle, Rear, Tuff-Cork .	W37347TC	1	1975-1977, A904 Automatic Transmission		
Transaxle Gasket Set			1975-1977, A904 Automatic Transmission		
1978-1981, A412 Transaxle	TS27917	1		W38031	1
Transaxle Pan Gasket			SAPPORO		
1978-1987, A404 Transaxle, A413 Transaxle, A470 Transaxle, A670 Transaxle, Tuff-Cork.	W38795TC	1	Transmission Pan Gasket		
SATELLITE			1978-1983, A904 Automatic Transmission		
Transmission Pan Gasket			1978-1983, A904 Automatic Transmission		
1967-1974, A727 Automatic Transmission	W39003	1		W39081	1
1967-1974, A727 Automatic Transmission, Tuff-Cork	W39003TC	1	SATELLITE GTX		
1967-1974, A904; A94-1 Automatic Transmission.	W38031	1	Transmission Pan Gasket		
SATELLITE GTX			1970, A727 Automatic Transmission		
Transmission Pan Gasket			1970, A727 Automatic Transmission, Tuff-Cork		
1970, A727 Automatic Transmission	W39003	1		W39003TC	1
1970, A727 Automatic Transmission, Tuff-Cork	W39003TC	1	1970, A904; A94-1 Automatic Transmission		
1970, A904; A94-1 Automatic Transmission	W38031	1	SATELLITE SPORT WAGON		
SATELLITE SPORT WAGON			Transmission Pan Gasket		
Transmission Pan Gasket			1968, A727 Automatic Transmission		
1968, A727 Automatic Transmission	W39003	1	1968, A727 Automatic Transmission, Tuff-Cork		
1968, A727 Automatic Transmission, Tuff-Cork	W39003TC	1	1968, A904; A94-1 Automatic Transmission		
1968, A904; A94-1 Automatic Transmission	W38031	1			

Transmission Gaskets (cont.)

<i>Model & Application</i>	<i>Part No.</i>	<i>Qty.</i>	<i>Model & Application</i>	<i>Part No.</i>	<i>Qty.</i>
SAVOY			SPORT SATELLITE		
Transmission Pan Gasket			Transmission Pan Gasket		
1962-1964, A727 Automatic Transmission	W39003	1	1968-1970, A727 Automatic Transmission	W39003	1
1962-1964, A727 Automatic Transmission, Tuff-Cork	W39003TC	1	1968-1970, A727 Automatic Transmission, Tuff-Cork	W39003TC	1
1962-1964, A904 Automatic Transmission, A904; A94-1 Automatic Transmission.	W38031	1	1968-1970, A904; A94-1 Automatic Transmission.	W38031	1
SCAMP			ST. REGIS		
Transmission Gasket Set			Transmission Pan Gasket		
1975-1976, A390 Transmission	TS29046	1	1979-1981, A727 Automatic Transmission	W39003	1
1975, A230 Transmission	TS29044Y	1	1979-1981, A727 Automatic Transmission, Tuff-Cork	W39003TC	1
1973-1974, 3 Speed Transmission	TS29044Y	1	1979-1981, A904 Automatic Transmission	W38031	1
Transmission Pan Gasket			SUBURBANS		
1971-1975, A727 Automatic Transmission	W39003	1	Transmission Pan Gasket		
1971-1975, A727 Automatic Transmission, Tuff-Cork	W39003TC	1	1972-1974, A727 Automatic Transmission	W39003	1
1971-1975, A904; A94-1 Automatic Transmission.	W38031	1	1972-1974, A727 Automatic Transmission, Tuff-Cork	W39003TC	1
SHADOW			1972-1974, A904 Automatic Transmission, A904; A94-1 Automatic Transmission.		
Transaxle Diff. Cvr Gasket			1972-1974, A904 Automatic Transmission, A904; A94-1 Automatic Transmission.		
1989-1991, A604 Transaxle, Tuff-Cork	W39376TC	1	1972-1974, A904 Automatic Transmission, A904; A94-1 Automatic Transmission.		
1987-1988, A404 Transaxle, A413 Transaxle, A470 Transaxle, A670 Transaxle, Tuff-Cork.	W37731TC	1	1972-1974, A904 Automatic Transmission, A904; A94-1 Automatic Transmission.		
Transaxle End Cvr. Gasket			SUNDANCE		
1989-1991, A604 Transaxle, Rear, Tuff-Cork .	W39377TC	1	Transaxle Diff. Cvr Gasket		
Transaxle Pan Gasket			1989-1991, A604 Transaxle, Tuff-Cork		
1989-1991, A604 Transaxle, Tuff-Cork	W39375TC	1	1987-1988, A404 Transaxle, A413 Transaxle, A470 Transaxle, A670 Transaxle, Tuff-Cork.	W37731TC	1
1987-1988, A404 Transaxle, A413 Transaxle, A470 Transaxle, A670 Transaxle, Tuff-Cork.	W38795TC	1	Transaxle End Cvr. Gasket		
SPIRIT			1989-1991, A604 Transaxle, Rear, Tuff-Cork .		
Transaxle Diff. Cvr Gasket			Transaxle Pan Gasket		
1989-1991, A404 Transaxle, A413 Transaxle, A470 Transaxle, A670 Transaxle, Tuff-Cork.	W37731TC	1	1989-1991, A604 Transaxle, Tuff-Cork		
1989-1991, A604 Transaxle, Tuff-Cork	W39376TC	1	1987-1988, A404 Transaxle, A413 Transaxle, A470 Transaxle, A670 Transaxle, Tuff-Cork.		
Transaxle End Cvr. Gasket			TC		
1990, A604 Transaxle, Rear, Tuff-Cork	W39377TC	1	Transaxle Diff. Cvr Gasket		
Transaxle Pan Gasket			1990-1991, A604 Transaxle, Tuff-Cork		
1989-1991, A404 Transaxle, A413 Transaxle, A470 Transaxle, A670 Transaxle, Tuff-Cork.	W38795TC	1	Transaxle End Cvr. Gasket		
1989-1991, A604 Transaxle, Tuff-Cork	W39375TC	1	1990-1991, A604 Transaxle, Rear, Tuff-Cork .		
SPORT FURY			Transaxle Pan Gasket		
Transmission Gasket Set			1990-1991, A604 Transaxle, Tuff-Cork		
1976, A230 Transmission	TS29044Y	1	1990-1991, A604 Transaxle, Tuff-Cork		
1976, A390 Transmission	TS29046	1	TC3		
Transmission Pan Gasket			Transaxle Diff. Cvr Gasket		
1962-1971, A727 Automatic Transmission	W39003	1	1981-1982, A404 Transaxle, A413 Transaxle, A470 Transaxle, A670 Transaxle, Tuff-Cork.		
1962-1971, A727 Automatic Transmission, Tuff-Cork	W39003TC	1	1981-1982, A404 Transaxle, A413 Transaxle, A470 Transaxle, A670 Transaxle, Tuff-Cork.		
1962-1971, A904 Automatic Transmission, A904; A94-1 Automatic Transmission.	W38031	1	Transaxle End Cvr. Gasket		
SPORT FURY GT			1981-1982, A404 Transaxle, A413 Transaxle, A470 Transaxle, A670 Transaxle, Tuff-Cork.		
Transmission Pan Gasket			Transaxle Gasket Set		
1970-1971, A727 Automatic Transmission	W39003	1	1981, A412 Transaxle		
1970-1971, A727 Automatic Transmission, Tuff-Cork	W39003TC	1	Transaxle Pan Gasket		
1970-1971, A904; A94-1 Automatic Transmission.	W38031	1	1981-1982, A404 Transaxle, A413 Transaxle, A470 Transaxle, A670 Transaxle, Tuff-Cork.		
TURISMO			Transaxle Diff. Cvr Gasket		
Transaxle Diff. Cvr Gasket			1983-1987, A404 Transaxle, A413 Transaxle, A470 Transaxle, A670 Transaxle, Tuff-Cork.		
1983-1987, A404 Transaxle, A413 Transaxle, A470 Transaxle, A670 Transaxle, Tuff-Cork.	W37731TC	1	1983-1987, A404 Transaxle, A413 Transaxle, A470 Transaxle, A670 Transaxle, Tuff-Cork.		

Chrysler (cont.)

Transmission Gaskets (cont.)

<i>Model & Application</i>	<i>Part No.</i>	<i>Qty.</i>	<i>Model & Application</i>	<i>Part No.</i>	<i>Qty.</i>
TURISMO (cont.)			VALIANT (cont.)		
Transaxle End Cvr. Gasket			Transmission Pan Gasket		
1983-1986, A404 Transaxle, A413 Transaxle, A470 Transaxle, Rear, Tuff-Cork	W37347TC	1	1962-1974, A727 Automatic Transmission	W39003	1
Transaxle Pan Gasket			1962-1974, A727 Automatic Transmission, Tuff-Cork	W39003TC	1
1983-1987, A404 Transaxle, A413 Transaxle, A470 Transaxle, A670 Transaxle, Tuff-Cork.	W38795TC	1	1962-1974, A904 Automatic Transmission, A904; A94-1 Automatic Transmission.	W38031	1
VIP			VOLARE		
Transmission Pan Gasket			Transmission Gasket Set		
1966-1969, A727 Automatic Transmission	W39003	1	1979-1980, A230 Transmission	TS29044Y	1
1966-1969, A727 Automatic Transmission, Tuff-Cork	W39003TC	1	1977-1980, A833 Overdrive Transmission	TS27904	1
1966-1969, A904; A94-1 Automatic Transmission.	W38031	1	1977-1978, A230 Transmission, Short Extension	TS29044Y	1
VALIANT			1976, A230 Transmission	TS29044Y	1
Transmission Gasket Set			1976, A390 Transmission	TS29046	1
1975-1976, A390 Transmission	TS29046	1	Transmission Pan Gasket		
1973-1974, 3 Speed Transmission	TS29044Y	1	1976-1980, A727 Automatic Transmission	W39003	1
			1976-1980, A727 Automatic Transmission, Tuff-Cork	W39003TC	1
			1976-1980, A904 Automatic Transmission	W38031	1

Eagle Chrysler

Transmission Gaskets

<i>Model & Application</i>	<i>Part No.</i>	<i>Qty.</i>	<i>Model & Application</i>	<i>Part No.</i>	<i>Qty.</i>
SUMMIT			VISTA		
Transaxle Pan Gasket			Transaxle Pan Gasket		
1989-1993, Automatic Transmission	W28798	1	1989-1992, Automatic Transmission	W28798	1

Ford

Axle Shaft Gaskets

<i>Model & Application</i>	<i>Part No.</i>	<i>Qty.</i>	<i>Model & Application</i>	<i>Part No.</i>	<i>Qty.</i>
BOBCAT			COMET		
Brake Backing Plate			Wheel Brg. Ret. Gasket		
1980, 6-3/4" Ring Gear, Rear Axle	J26079	2	1973-1974, Rear Wheel	J26095	2
1980, 8" Ring Gear, Rear Axle	J26108	2	1971-1972, 10" Brakes, Rear Wheel	J26095	2
1975-1979, Rear Axle	J26079	2	1968-1969, Inner, Rear Wheel	J26568	2
CAPRI			1968-1969, 4 Bolt Holes, Outer, Rear Wheel	J26374	2
Wheel Brg. Ret. Gasket			1967, Outer, Rear Wheel	J26542	2
1980-1981, Rear Wheel	J26079	2	1967, Inner, Rear Wheel	J26569	2
COLONY PARK			1964-1965, Rear Wheel, 2-11/16" Inside Diameter.	J26569	2
Wheel Brg. Ret. Gasket			1963-1966, Inner, Rear Wheel, 2-7/8" Inside Diameter.	J26568	2
1968, Rear Wheel	J26638	2	1963-1966, 4 Bolt Holes, Outer, Rear Wheel, 2-7/8" Inside Diameter	J26374	2
1966-1967, Inner, Rear Wheel	J26638	2	1960-1963, Outer, Rear Wheel, 2-11/16" Inside Diameter.	J26542	2
1961-1963, 4 Bolt Holes, 4 Bolt Holes, Outer, Rear Wheel	J26374	2	1960-1963, Inner, Rear Wheel, 2-11/16" Inside Diameter.	J26569	2
1961-1963, Standard Duty, 4 Bolt Holes, Inner, Rear Wheel	J26568	2	CONTINENTAL		
1961-1962, 5 Bolt Holes, 5 Bolt Holes, Inner, Rear Wheel	J26640	4	Wheel Brg. Ret. Gasket		
1957-1960, 5 Bolt Holes, Rear Wheel	J26640	4	1971-1973, Rear Wheel	J26115	2

Axle Shaft Gaskets (cont.)

<i>Model & Application</i>	<i>Part No.</i>	<i>Qty.</i>	<i>Model & Application</i>	<i>Part No.</i>	<i>Qty.</i>
CONTINENTAL (cont.)			DELUXE		
Wheel Brg. Ret. Gasket (cont.)			Wheel Brg. Ret. Gasket		
1970, From 9/69, Rear Wheel	J26115	2	1949-1951, 4 Bolt Holes, Rear Wheel	J26374	2
1970, Thru 9/69, Rear Wheel	J26638	2	1946-1948, Rear Wheel	J26758	2
1966-1969, Rear Wheel	J26638	2	1938-1942, Rear Wheel	J26758	2
1965, Rear Wheel	J26640	4			
COUGAR			FAIRLANE		
Brake Backing Plate			Brake Carrier Gasket		
1974-1979, Rear Axle	J26102	2	1962-1969, Rear Axle	J26568	2
1971-1973, Rear Axle	J26095	2	Wheel Brg. Ret. Gasket		
1970, From 9/69, Rear Axle	J26095	2	1962-1968, 4 Bolt Holes, Rear Wheel	J26374	2
1970, Thru 9/69, Rear Axle	J26568	2	1962, 5 Bolt Holes, Rear Wheel	J26640	4
1967-1969, Rear Axle	J26568	2	1955-1960, 4 Bolt Holes, Rear Wheel	J26374	2
			1955-1960, 5 Bolt Holes, Rear Wheel	J26640	4
Wheel Brg. Ret. Gasket			FAIRLANE 500		
1978, Rear Wheel	J26108	2	Brake Carrier Gasket		
1967-1968, Rear Wheel	J26374	2	1970, Thru 9/69, Rear Axle	J26568	2
			1962-1969, Rear Axle	J26568	2
COUNTRY SEDAN			Wheel Brg. Ret. Gasket		
Wheel Brg. Ret. Gasket			1970, Thru 9/69, Rear Wheel	J26568	2
1963-1968, Rear Wheel	J26638	2	1957-1968, 4 Bolt Holes, Rear Wheel	J26374	2
1955-1968, 4 Bolt Holes, Rear Wheel	J26374	2	1957-1962, 5 Bolt Holes, Rear Wheel	J26640	4
1955-1968, 5 Bolt Holes, Rear Wheel	J26640	4			
COUNTRY SQUIRE			FAIRMONT		
Wheel Brg. Ret. Gasket			Wheel Brg. Ret. Gasket		
1955-1958, 4 Bolt Holes, Rear Wheel	J26374	2	1982, Rear Wheel	J26245	2
1955-1958, 5 Bolt Holes, Rear Wheel	J26640	4	1980-1981, Rear Wheel	J26079	2
			1978-1979, Rear Wheel	J26095	2
CRESTLINE			FALCON		
Wheel Brg. Ret. Gasket			Wheel Brg. Ret. Gasket		
1952-1954, 5 Bolt Holes, Rear Wheel	J26640	4	1970, Except WDV Axle, Rear Wheel	J26568	2
1950-1954, 4 Bolt Holes, Rear Wheel	J26374	2	1970, WDV Axle, Rear Wheel	J26569	2
			1964-1968, Rear Wheel, 2-7/8" Inside Diameter	J26374	2
CUSTOM			1963-1968, Rear Wheel, 2-11/16" Inside Diameter	J26542	2
Wheel Brg. Ret. Gasket			GALAXIE 500		
1952-1956, 5 Bolt Holes, Rear Wheel	J26640	4	Wheel Brg. Ret. Gasket		
1952-1954, 4 Bolt Holes, Rear Wheel	J26374	2	1971-1974, Rear Wheel	J26115	2
1970, From 9/69, Rear Wheel	J26115	2	1970, From 9/69, Rear Wheel	J26115	2
1970, Thru 9/69, Rear Wheel	J26638	2	1970, Thru 9/69, Rear Wheel	J26638	2
1968-1969, Rear Wheel	J26638	2	1968-1969, Rear Wheel	J26638	2
1964-1967, 4 Bolt Holes, Rear Wheel	J26374	2	1962-1967, 4 Bolt Holes, Rear Wheel	J26374	2
1964-1967, 5 Bolt Holes, Rear Wheel	J26640	4	1962-1967, 5 Bolt Holes, Rear Wheel	J26640	4
1957, 4 Bolt Holes, Rear Wheel	J26374	2			
1957, 5 Bolt Holes, Rear Wheel	J26640	4	GRAN TORINO		
1949-1951, 4 Bolt Holes, Rear Wheel	J26374	2	Brake Backing Plate		
1949-1951, 5 Bolt Holes, Rear Wheel	J26640	4	1973-1976, Rear Axle	J26102	2
			1972, Rear Axle	J26095	2
CUSTOM 300			GRANADA		
Wheel Brg. Ret. Gasket			Wheel Brg. Ret. Gasket		
1957-1959, 4 Bolt Holes, Rear Wheel	J26374	2	1980, Rear Wheel	J26108	2
1957-1959, 5 Bolt Holes, Rear Wheel	J26640	4	1975-1979, 8" Ring Gear, Rear Wheel	J26095	2
			1975-1979, 9" Ring Gear, Rear Wheel	J26115	2
CUSTOM 500			GRAND MARQUIS		
Wheel Brg. Ret. Gasket			Wheel Brg. Ret. Gasket		
1970, From 9/69, Rear Wheel	J26115	2	1978, Rear Wheel	J26108	2
1970, Thru 9/69, Rear Wheel	J26638	2	1975-1977, Rear Wheel	J26115	2
1968-1969, Rear Wheel	J26638	2			
1964-1967, 4 Bolt Holes, Rear Wheel	J26374	2	LTD		
1964-1967, 5 Bolt Holes, Rear Wheel	J26640	4	Wheel Brg. Ret. Gasket		
			1978-1979, Rear Wheel	J26108	2
CUSTOMLINE			1971-1978, Rear Wheel	J26115	2
Wheel Brg. Ret. Gasket					
1952-1956, 4 Bolt Holes, Rear Wheel	J26374	2			
1952-1956, 5 Bolt Holes, Rear Wheel	J26640	4			

Ford (cont.)

Axle Shaft Gaskets (cont.)

<i>Model & Application</i>	<i>Part No.</i>	<i>Qty.</i>	<i>Model & Application</i>	<i>Part No.</i>	<i>Qty.</i>
LTD (cont.)			MODEL 18		
Wheel Brg. Ret. Gasket (cont.)			Wheel Brg. Ret. Gasket		
1970, From 9/69, Rear Wheel	J26115	2	1932, Rear Wheel	J26758	2
1970, Thru 9/69, Rear Wheel	J26638	2	MODEL 40		
1968-1969, Rear Wheel	J26638	2	Wheel Brg. Ret. Gasket		
1967, 4 Bolt Holes, Rear Wheel	J26374	2	1933-1934, Rear Wheel	J26758	2
1967, 5 Bolt Holes, Rear Wheel	J26640	4	MODEL 48		
LTD II			Wheel Brg. Ret. Gasket		
Wheel Brg. Ret. Gasket			1935, Rear Wheel	J26758	2
1977-1979, Rear Wheel	J26102	2	MODEL 68		
MAINLINE			Wheel Brg. Ret. Gasket		
Wheel Brg. Ret. Gasket			1936, Rear Wheel	J26758	2
1952-1956, 4 Bolt Holes, Rear Wheel	J26374	2	MODEL 78		
1952-1956, 5 Bolt Holes, Rear Wheel	J26640	4	Wheel Brg. Ret. Gasket		
MARK IV			1937, Rear Wheel	J26758	2
Wheel Brg. Ret. Gasket			MODEL 81A		
1973, Rear Wheel	J26102	2	Wheel Brg. Ret. Gasket		
1972, Rear Wheel	J26095	2	1938, Rear Wheel	J26758	2
MARQUIS			MODEL 82A		
Wheel Brg. Ret. Gasket			Wheel Brg. Ret. Gasket		
1978, Rear Wheel	J26108	2	1938, Rear Wheel	J26758	2
1971-1977, Rear Wheel	J26115	2	MODEL 91A		
1970, From 9/69, Rear Wheel	J26115	2	Wheel Brg. Ret. Gasket		
1970, Thru 9/69, Rear Wheel	J26638	2	1939, Rear Wheel	J26758	2
1968-1969, Rear Wheel	J26638	2	MODEL 922A		
1967, Inner, Rear Wheel	J26638	2	Wheel Brg. Ret. Gasket		
1967, Outer, Rear Wheel	J26640	4	1939, Rear Wheel	J26758	2
MAVERICK			MONARCH		
Wheel Brg. Ret. Gasket			Brake Backing Plate		
1973-1977, Rear Wheel	J26095	2	1980, Rear Axle	J26108	2
1971-1972, 10" Brakes, Rear Wheel	J26095	2	1975-1979, Disc Brakes, Rear Axle	J26115	2
1971-1972, 9" Brakes, Rear Wheel	J26569	2	1975-1979, Drum Brakes, Rear Axle	J26095	2
1970, 7-1/4" Ring Gear, 8" Ring Gear, Rear Wheel	J26569	2	Wheel Brg. Ret. Gasket		
1970, Except 7-1/4" Ring Gear, Except 8" Ring Gear, Rear Wheel	J26568	2	1980, Rear Wheel	J26108	2
1969, Rear Wheel	J26569	2	MONTCLAIR		
MEDALIST			Wheel Brg. Ret. Gasket		
Wheel Brg. Ret. Gasket			1955-1960, Rear Wheel	J26640	4
1958, Rear Wheel	J26640	4	MONTEGO		
1956, Rear Wheel	J26640	4	Brake Backing Plate		
METEOR			1973-1974, Rear Axle	J26102	2
Wheel Brg. Ret. Gasket			1971-1972, Rear Axle	J26095	2
1962-1963, Outer, Rear Wheel	J26374	2	1970, From 9/69, Rear Axle	J26095	2
1962-1963, Inner, Rear Wheel	J26568	2	1970, Thru 9/69, Rear Axle	J26568	2
1962-1963, 5 Bolt Holes, Rear Wheel	J26640	4	1968-1969, Rear Axle	J26568	2
1961, Canadian, Light Duty Axle, Rear Wheel	J26374	2	MONTEGO MX		
MODEL 01A			Brake Backing Plate		
Wheel Brg. Ret. Gasket			1973-1974, Rear Axle	J26102	2
1940, Rear Wheel	J26758	2	1971-1972, Rear Axle	J26095	2
MODEL 022A			1970, From 9/69, Rear Axle	J26095	2
Wheel Brg. Ret. Gasket			1970, Thru 9/69, Rear Axle	J26568	2
1940, Rear Wheel	J26758	2	1968-1969, Rear Axle	J26568	2
MODEL 11A			MONTEGO MX BROUGHAM		
Wheel Brg. Ret. Gasket			Brake Backing Plate		
1941, Rear Wheel	J26758	2	1973-1974, Rear Axle	J26102	2
			1971-1972, Rear Axle	J26095	2

Axle Shaft Gaskets (cont.)

<i>Model & Application</i>	<i>Part No.</i>	<i>Qty.</i>	<i>Model & Application</i>	<i>Part No.</i>	<i>Qty.</i>
MONTEGO MX BROUGHAM (cont.)			RANCH WAGON		
Brake Backing Plate (cont.)			Wheel Brg. Ret. Gasket		
1970, From 9/69, Rear Axle	J26095	2	1955-1959, 4 Bolt Holes, Rear Wheel	J26374	2
1970, Thru 9/69, Rear Axle	J26568	2	1955-1959, 5 Bolt Holes, Rear Wheel	J26640	4
MONTEREY			SUPER DELUXE		
Wheel Brg. Ret. Gasket			Wheel Brg. Ret. Gasket		
1971-1974, Rear Wheel	J26115	2	1946-1948, Rear Wheel	J26758	2
1970, From 9/69, Rear Wheel	J26115	2	1941-1942, Rear Wheel	J26758	2
1970, Thru 9/69, Rear Wheel	J26638	2	THUNDERBIRD		
1966-1969, Rear Wheel	J26638	2	Brake Backing Plate		
1966-1967, Inner, Rear Wheel	J26638	2	1977-1979, Rear Axle	J26102	2
1961-1963, 4 Bolt Holes, 4 Bolt Holes, Outer, Rear Wheel	J26374	2	1973, Rear Axle	J26102	2
1961-1963, 5 Bolt Holes, 5 Bolt Holes, Inner, Rear Wheel	J26640	4	1972, Rear Axle	J26095	2
1961-1963, Standard Duty, 4 Bolt Holes, Inner, Rear Wheel	J26568	2	1971, Rear Axle	J26115	2
1952-1960, 5 Bolt Holes, Rear Wheel	J26640	4	1970, From 9/69, Rear Axle	J26115	2
1952-1954, 4 Bolt Holes, Rear Wheel	J26374	2	1970, Thru 9/69, Rear Axle	J26638	2
MUSTANG			1966-1969, Rear Axle		
Brake Backing Plate			1961-1962, Rear Axle		
1974-1981, Rear Axle	J26079	2	Wheel Brg. Ret. Gasket		
1971-1973, Rear Axle	J26095	2	1968, Rear Wheel	J26638	2
1970, Except 7-1/4" Ring Gear, From 9/69, Rear Axle	J26095	2	1962-1967, 5 Bolt Holes, Rear Wheel	J26640	4
1970, Except 7-1/4" Ring Gear, Thru 9/69, Rear Axle	J26568	2	1961, 4 Bolt Holes, Rear Wheel	J26374	2
1965-1970, Except 7-1/4" Ring Gear, Rear Axle	J26568	2	1958-1960, 5 Bolt Holes, Rear Wheel	J26640	4
1965-1969, 7-1/4" Ring Gear, Rear Axle	J26569	2	TORINO		
Wheel Brg. Ret. Gasket			Brake Backing Plate		
1965-1968, Rear Wheel	J26374	2	1973-1976, Rear Axle	J26102	2
1965-1968, Rear Wheel	J26542	2	1971-1972, Rear Axle	J26095	2
PARKLANE			1970, From 9/69, Rear Axle		
Wheel Brg. Ret. Gasket			1970, Thru 9/69, Rear Axle		
1968, Rear Wheel	J26638	2	1968-1969, Rear Axle		
1966-1967, Inner, Rear Wheel	J26638	2	Wheel Brg. Ret. Gasket		
1958-1960, Rear Wheel	J26640	4	1968, Rear Wheel		
PINTO			TURNPIKE CRUISER		
Wheel Brg. Ret. Gasket			Wheel Brg. Ret. Gasket		
1980, 8" Ring Gear, 9" Ring Gear, Rear Wheel	J26108	2	1957-1958, Rear Wheel		
1974-1979, Rear Wheel	J26079	2	ZEPHYR		
1971-1973, Rear Wheel	J26569	2	Wheel Brg. Ret. Gasket		
			1982, Rear Wheel		
			1980-1981, Rear Wheel		

Differential Housing Cover Gaskets

<i>Model & Application</i>	<i>Part No.</i>	<i>Qty.</i>	<i>Model & Application</i>	<i>Part No.</i>	<i>Qty.</i>
BOBCAT			CAPRI (cont.)		
Axle Hsg Cover Gasket			Axle Hsg Cover Gasket		
1979-1980, 6.75" Ring Gear, 8 Bolt Holes, Tuff-Cork, 8-1/4" X 8-7/8"	P27609TC	1	1983-1986, 6.75" Ring Gear, 7.5" Ring Gear, 10 Bolt Holes, Tuff-Cork, 9-1/2" X 10-3/4"	P27139TC	1
1975-1978, 6.75" Ring Gear, 8 Bolt Holes, 8-1/2" X 9-5/8"	P27592	1	1983-1986, 7.5" Ring Gear, 8 Bolt Holes, Tuff-Cork, 8-1/4" X 8-7/8"	P27609TC	1
Diff. Carrier Gasket			1979-1982, 6.75" Ring Gear, 8 Bolt Holes, Tuff-Cork, 8-1/4" X 8-7/8"		
1980, 8" Gear, 10 Bolt Holes, 9-3/4" X 10-15/16"	P27807	1	1979-1982, 7.5" Ring Gear, 10 Bolt Holes, Tuff-Cork, 9-7/8" X 10-7/8"		
1975-1978, 8" Gear, 10 Bolt Holes, 9-3/4" X 10-15/16"	P27807	1	1971-1978		
CAPRI					
Diff. Carrier Gasket					
1955-1959	P27934	1			

Ford (cont.)

Differential Housing Cover Gaskets (cont.)

<i>Model & Application</i>	<i>Part No.</i>	<i>Qty.</i>	<i>Model & Application</i>	<i>Part No.</i>	<i>Qty.</i>
COLONY PARK			COUGAR (cont.)		
Diff. Carrier Gasket			Diff. Carrier Gasket (cont.)		
1957-1968, 9" Gear, 10 Bolt Holes, 10-3/4" X 11-5/8"	P27929	1	1972, 8" Gear, 10 Bolt Holes, 9-3/4" X 10-15/16"	P27807	1
1957-1968, 9" Gear, 10 Bolt Holes, Tuff-Cork, 10-3/4" X 11-5/8"	P27929TC	1	1972, 9" Gear, 10 Bolt Holes, 10-3/4" X 11-5/8"	P27929	1
COMET			1972, 9" Gear, 10 Bolt Holes, Tuff-Cork, 10-3/4" X 11-5/8"		
Axle Hsg Cover Gasket			1969-1974		
1967-1968, 7.25" Ring Gear, 8 Bolt Holes, 8-1/2" X 9-5/8"	P27799	1	1969-1974, Tuff-Cork	P27929TC	1
1964-1965, 7.25" Ring Gear, 8 Bolt Holes, 8-1/2" X 9-5/8"	P27799	1	1967-1968, 8" Gear, 10 Bolt Holes, 9-3/4" X 10-15/16"	P27807	1
1960-1963	P27799	1	1967-1968, 9" Gear, 10 Bolt Holes, X 11-5/8"	P27929	1
Diff. Carrier Gasket			1967-1968, 9" Gear, 10 Bolt Holes, Tuff-Cork, 10-3/4" X 11-5/8"		
1971-1977	P27807	1	COUNTRY SEDAN		
1966-1969, 9" Gear, 10 Bolt Holes, 10-3/4" X 11-5/8"	P27929	1	Axle Hsg Cover Gasket		
1966-1967, 9" Gear, 10 Bolt Holes, Tuff-Cork, 10-3/4" X 11-5/8"	P27929TC	1	1966-1968, 8.5" Ring Gear, 10 Bolt Holes, 10-15/16" X 11-1/2"		
1964-1969, 8" Gear, 10 Bolt Holes, 9-3/4" X 10-15/16"	P27807	1	Diff. Carrier Gasket		
COMMUTER			1967-1968, 9" Gear, 10 Bolt Holes, X 11-5/8"		
Diff. Carrier Gasket			1967-1968, 9" Gear, 10 Bolt Holes, Tuff-Cork, 10-3/4" X 11-5/8"		
1964-1968, 9" Gear, 10 Bolt Holes, 10-3/4" X 11-5/8"	P27929	1	1962-1968		
1964-1968, 9" Gear, 10 Bolt Holes, Tuff-Cork, 10-3/4" X 11-5/8"	P27929TC	1	1962-1968, Tuff-Cork		
CONTINENTAL			1957-1959		
Axle Hsg Cover Gasket			1957-1959, Tuff-Cork		
1993-1995, 7.5" Ring Gear, 10 Bolt Holes, Tuff-Cork, 9-1/2" X 10-3/4"	P27139TC	1	CROWN VICTORIA		
1993-1995, 8.5" Ring Gear, 8.8" Ring Gear, 10 Bolt Holes, Tuff-Cork, 10-1/2" X 11"	P27608TC	1	Axle Hsg Cover Gasket		
1985-1991, 7.5" Ring Gear, 10 Bolt Holes, Tuff-Cork, 9-1/2" X 10-3/4"	P27139TC	1	1988-1995, 8.8" Ring Gear, 10 Bolt Holes, Tuff-Cork, 10-1/2" X 11"		
1984, 7.5" Ring Gear, From 5/84, 10 Bolt Holes, Tuff-Cork, 9-1/2" X 10-3/4"	P27139TC	1	1983-1991, 8.5" Ring Gear, 8.8" Ring Gear, 10 Bolt Holes, Tuff-Cork, 10-1/2" X 11"		
1984, 7.5" Ring Gear, Thru 5/84, 10 Bolt Holes, Tuff-Cork, 9-3/4" X 10-3/4"	P38151TC	1	1983-1985, 7.5" Ring Gear, 10 Bolt Holes, Tuff-Cork, 9-1/2" X 10-3/4"		
1980-1991, 8.5" Ring Gear, 8.8" Ring Gear, 10 Bolt Holes, Tuff-Cork, 10-1/2" X 11"	P27608TC	1	1983-1985, 7.5" Ring Gear, 8 Bolt Holes, Tuff-Cork, 8-1/4" X 8-7/8"		
1980-1983, 7.5" Ring Gear, 10 Bolt Holes, Tuff-Cork, 9-3/4" X 10-3/4"	P38151TC	1	CUSTOM		
Diff. Carrier Gasket			Axle Hsg Cover Gasket		
1975-1979	P27994	1	1955-1956		
1975-1979, Tuff-Cork	P27994TC	1	1955-1956, 10 Bolt Holes, Tuff-Cork		
1966-1974	P27929	1	1970-1972, 8.7" Ring Gear, 10 Bolt Holes, 10-15/16" X 11-1/2"		
1966-1974, Tuff-Cork	P27929TC	1	1969-1972, 8.5" Ring Gear, 8.7" Ring Gear, 10 Bolt Holes, 10-15/16" X 11-1/2"		
1961-1965	P27934	1	1967-1969, 8.5" Ring Gear, 10 Bolt Holes, 10-15/16" X 11-1/2"		
COUGAR			1967-1972, 9" Gear, 10 Bolt Holes, 10-3/4" X 11-5/8"		
Axle Hsg Cover Gasket			1967-1972, 9" Gear, 10 Bolt Holes, Tuff-Cork, 10-3/4" X 11-5/8"		
1989-1995, 7.5" Ring Gear, Tuff-Cork	P38164TC	1	1964-1966		
1989-1995, 8.8" Ring Gear, Tuff-Cork	P38165TC	1	1964-1966, Tuff-Cork		
1986-1988, 8.8" Ring Gear, 10 Bolt Holes, Tuff-Cork, 10-1/2" X 11"	P27608TC	1	1957		
1980-1988, 7.5" Ring Gear, 10 Bolt Holes, Tuff-Cork, 9-1/2" X 10-3/4"	P27139TC	1	1957, Tuff-Cork		
1980-1985, 7.5" Ring Gear, 8 Bolt Holes, Tuff-Cork, 8-1/4" X 8-7/8"	P27609TC	1	1955		
Diff. Carrier Gasket			CUSTOM 300		
1975-1979	P27994	1	Diff. Carrier Gasket		
1975-1979, Tuff-Cork	P27994TC	1	1957-1959		
1973-1974	P27929	1	1957-1959, Tuff-Cork		
1973-1974, Tuff-Cork	P27929TC	1			

Differential Housing Cover Gaskets (cont.)

Model & Application	Part No.	Qty.	Model & Application	Part No.	Qty.
CUSTOM 500			FAIRMONT (cont.)		
Axle Hsg Cover Gasket			Axle Hsg Cover Gasket (cont.)		
1970-1977, 8.7" Ring Gear, 10 Bolt Holes, 10-15/16" X 11-1/2"	P18561	1	1980-1983, 6.75" Ring Gear, 7.5" Ring Gear, 10 Bolt Holes, Tuff-Cork, 9-1/2" X 10-3/4"	P27139TC	1
1969-1972, 8.5" Ring Gear, 8.7" Ring Gear, 10 Bolt Holes, 10-15/16" X 11-1/2"	P18561	1	1980-1983, 6.75" Ring Gear, 7.5" Ring Gear, 8 Bolt Holes, Tuff-Cork, 8-1/4" X 8-7/8"	P27609TC	1
1967-1969, 8.5" Ring Gear, 10 Bolt Holes, 10-15/16" X 11-1/2"	P18561	1	1978-1979, 7.5" Ring Gear, 10 Bolt Holes, Tuff-Cork, 9-1/2" X 10-3/4"	P27139TC	1
Diff. Carrier Gasket			FALCON		
1975-1977, 9" Gear, 10 Bolt Holes, 10-3/4" X 11-5/8"	P27994	1	Axle Hsg Cover Gasket		
1975-1977, 9" Gear, 10 Bolt Holes, Tuff-Cork, 10-3/4" X 11-5/8"	P27994TC	1	1960-1970, 7.25" Ring Gear, 8 Bolt Holes, 8-1/2" X 9-5/8"	P27799	1
1967-1974, 9" Gear, 10 Bolt Holes, 10-3/4" X 11-5/8"	P27929	1	Diff. Carrier Gasket		
1967-1974, 9" Gear, 10 Bolt Holes, Tuff-Cork, 10-3/4" X 11-5/8"	P27929TC	1	1963-1970, 8" Gear, 10 Bolt Holes, 9-3/4" X 10-15/16"	P27807	1
1964-1966	P27929	1	GALAXIE 500		
1964-1966, Tuff-Cork	P27929TC	1	Axle Hsg Cover Gasket		
FAIRLANE			1970-1974, 8.7" Ring Gear, 10 Bolt Holes, 10-15/16" X 11-1/2"	P18561	1
Axle Hsg Cover Gasket			1969-1972, 8.5" Ring Gear, 8.7" Ring Gear, 10 Bolt Holes, 10-15/16" X 11-1/2"	P18561	1
1968, WEZ Axle	P27799	1	1967-1969, 8.5" Ring Gear, 10 Bolt Holes, 10-15/16" X 11-1/2"	P18561	1
Diff. Carrier Gasket			Diff. Carrier Gasket		
1969, 8" Gear, 10 Bolt Holes, 9-3/4" X 10-15/16"	P27807	1	1967-1974, 9" Gear, 10 Bolt Holes, 10-3/4" X 11-5/8"	P27929	1
1969, 9" Gear, 10 Bolt Holes, 10-3/4" X 11-5/8"	P27929	1	1967-1974, 9" Gear, 10 Bolt Holes, Tuff-Cork, 10-3/4" X 11-5/8"	P27929TC	1
1969, 9" Gear, 10 Bolt Holes, Tuff-Cork, 10-3/4" X 11-5/8"	P27929TC	1	1962-1966	P27929	1
1968-1969, 8" Gear, Except WEZ Axle, 10 Bolt Holes, 9-3/4" X 10-15/16"	P27807	1	1962-1966, Tuff-Cork	P27929TC	1
1968-1969, 9" Gear, Except WEZ Axle, 10 Bolt Holes, 10-3/4" X 11-5/8"	P27929	1	GRAN TORINO		
1968-1969, 9" Gear, Except WEZ Axle, 10 Bolt Holes, Tuff-Cork, 10-3/4" X 11-5/8"	P27929TC	1	Diff. Carrier Gasket		
1964-1967	P27807	1	1975-1976	P27994	1
1964-1967, Special Engine	P27929	1	1975-1976, Tuff-Cork	P27994TC	1
1964-1967, Special Engine, Tuff-Cork	P27929TC	1	1972-1974, 8" Gear, 10 Bolt Holes, 9-3/4" X 10-15/16"	P27807	1
1964, Except Special Engine	P27807	1	1972-1974, 9" Gear, 10 Bolt Holes, 10-3/4" X 11-5/8"	P27929	1
1962-1967	P27807	1	1972-1974, 9" Gear, 10 Bolt Holes, Tuff-Cork, 10-3/4" X 11-5/8"	P27929TC	1
FAIRLANE 500			GRANADA		
Axle Hsg Cover Gasket			Axle Hsg Cover Gasket		
1968, WEZ Axle	P27799	1	1981-1982, 7.5" Ring Gear, 8 Bolt Holes, Tuff-Cork, 8-1/4" X 8-7/8"	P27609TC	1
Diff. Carrier Gasket			1980-1982, 7.5" Ring Gear, 10 Bolt Holes, Tuff-Cork, 9-1/2" X 10-3/4"	P27139TC	1
1969-1970, 8" Gear, 10 Bolt Holes, 9-3/4" X 10-15/16"	P27807	1	1975-1978, 8.7" Ring Gear, 10 Bolt Holes, 10-15/16" X 11-1/2"	P18561	1
1969-1970, 9" Gear, 10 Bolt Holes, 10-3/4" X 11-5/8"	P27929	1	Diff. Carrier Gasket		
1969-1970, 9" Gear, 10 Bolt Holes, Tuff-Cork, 10-3/4" X 11-5/8"	P27929TC	1	1980, 9" Gear, 10 Bolt Holes, 10-3/4" X 11-5/8"	P27994	1
1968-1970, 9" Gear, Except WEZ Axle, 10 Bolt Holes, 10-3/4" X 11-5/8"	P27929	1	1980, 9" Gear, 10 Bolt Holes, Tuff-Cork, 10-3/4" X 11-5/8"	P27994TC	1
1968-1970, 9" Gear, Except WEZ Axle, 10 Bolt Holes, Tuff-Cork, 10-3/4" X 11-5/8"	P27929TC	1	1975-1980, 8" Gear, 10 Bolt Holes, 9-3/4" X 10-15/16"	P27807	1
1968, 8" Gear, Except WEZ Axle, 10 Bolt Holes, 9-3/4" X 10-15/16"	P27807	1	1975-1978, 9" Gear, 10 Bolt Holes, 10-3/4" X 11-5/8"	P27994	1
1965-1967	P27807	1	1975-1978, 9" Gear, 10 Bolt Holes, Tuff-Cork, 10-3/4" X 11-5/8"	P27994TC	1
1964-1967, Except Special Engine	P27807	1	FAIRMONT		
1964-1967, Special Engine	P27929	1	Axle Hsg Cover Gasket		
1964-1967, Special Engine, Tuff-Cork	P27929TC	1	1983, 7.5" Ring Gear, 10 Bolt Holes, Tuff-Cork, 9-1/2" X 10-3/4"	P27139TC	1
1962-1967	P27807	1			

PASSENGER CAR

Differential Housing Cover Gaskets (cont.)

<i>Model & Application</i>	<i>Part No.</i>	<i>Qty.</i>	<i>Model & Application</i>	<i>Part No.</i>	<i>Qty.</i>
MAVERICK			MONTEGO MX BROUGHAM		
Axle Hsg Cover Gasket			Diff. Carrier Gasket		
1970, 7.25" Ring Gear, 8 Bolt Holes, 8-1/2" X 9-5/8"	P27799	1	1975-1976, 9" Gear, 10 Bolt Holes, 10-3/4" X 11-5/8"	P27994	1
Diff. Carrier Gasket			1975-1976, 9" Gear, 10 Bolt Holes, Tuff-Cork, 10-3/4" X 11-5/8"	P27994TC	1
1971-1976	P27807	1	1970-1974, 8" Gear, 10 Bolt Holes, 9-3/4" X 10-15/16"	P27807	1
1970-1977, 8" Gear, 10 Bolt Holes, 9-3/4" X 10-15/16"	P27807	1	1970-1974, 9" Gear, 10 Bolt Holes, 10-3/4" X 11-5/8"	P27929	1
MEDALIST			1970-1974, 9" Gear, 10 Bolt Holes, Tuff-Cork, 10-3/4" X 11-5/8"	P27929TC	1
Axle Hsg Cover Gasket			MONTEREY		
1956	P27768T	1	Axle Hsg Cover Gasket		
1956, 10 Bolt Holes, Tuff-Cork	P27768TC	1	1970-1974, 8.7" Ring Gear, 10 Bolt Holes, 10-15/16" X 11-1/2"	P18561	1
MONARCH			1955-1956	P27768T	1
Axle Hsg Cover Gasket			1955-1956, 10 Bolt Holes, Tuff-Cork	P27768TC	1
1975-1980, 8.7" Ring Gear, 10 Bolt Holes, 10-15/16" X 11-1/2"	P18561	1	Diff. Carrier Gasket		
Diff. Carrier Gasket			1957-1974, 9" Gear, 10 Bolt Holes, 10-3/4" X 11-5/8"	P27929	1
1975-1980, 8" Gear, 10 Bolt Holes, 9-3/4" X 10-15/16"	P27807	1	1957-1974, 9" Gear, 10 Bolt Holes, Tuff-Cork, 10-3/4" X 11-5/8"	P27929TC	1
1975-1980, 9" Gear, 10 Bolt Holes, 10-3/4" X 11-5/8"	P27994	1	MUSTANG		
1975-1980, 9" Gear, 10 Bolt Holes, Tuff-Cork, 10-3/4" X 11-5/8"	P27994TC	1	Axle Hsg Cover Gasket		
MONTCLAIR			1986-1995, 7.5" Ring Gear, 10 Bolt Holes, Tuff-Cork, 9-1/2" X 10-3/4"	P27139TC	1
Axle Hsg Cover Gasket			1986-1995, 8.8" Ring Gear, 10 Bolt Holes, Tuff-Cork, 10-1/2" X 11"	P27608TC	1
1955-1956	P27768T	1	1979-1986, 6.75" Ring Gear, 7.5" Ring Gear, 10 Bolt Holes, Tuff-Cork, 9-1/2" X 10-3/4"	P27139TC	1
1955-1956, 10 Bolt Holes, Tuff-Cork	P27768TC	1	1979-1985, 6.75" Ring Gear, 7.5" Ring Gear, 8 Bolt Holes, Tuff-Cork, 8-1/4" X 8-7/8"	P27609TC	1
Diff. Carrier Gasket			1974-1978, 6.75" Ring Gear, 8 Bolt Holes, 8-1/2" X 9-5/8"	P27592	1
1957-1960, 9" Gear, 10 Bolt Holes, 10-3/4" X 11-5/8"	P27929	1	1965-1971, 7.25" Ring Gear, 8 Bolt Holes, 8-1/2" X 9-5/8"	P27799	1
1957-1960, 9" Gear, 10 Bolt Holes, Tuff-Cork, 10-3/4" X 11-5/8"	P27929TC	1	Diff. Carrier Gasket		
MONTEGO			1965-1978, 8" Gear, 10 Bolt Holes, 9-3/4" X 10-15/16"	P27807	1
Axle Hsg Cover Gasket			1965-1973, 9" Gear, 10 Bolt Holes, 10-3/4" X 11-5/8"	P27929	1
1968, 7.25" Ring Gear, 8 Bolt Holes, 8-1/2" X 9-5/8"	P27799	1	1965-1973, 9" Gear, 10 Bolt Holes, Tuff-Cork, 10-3/4" X 11-5/8"	P27929TC	1
Diff. Carrier Gasket			PARKLANE		
1975-1976, 9" Gear, 10 Bolt Holes, 10-3/4" X 11-5/8"	P27994	1	Diff. Carrier Gasket		
1975-1976, 9" Gear, 10 Bolt Holes, Tuff-Cork, 10-3/4" X 11-5/8"	P27994TC	1	1966-1968, 9" Gear, 10 Bolt Holes, 10-3/4" X 11-5/8"	P27929	1
1968-1974, 8" Gear, 10 Bolt Holes, 9-3/4" X 10-15/16"	P27807	1	1966-1968, 9" Gear, 10 Bolt Holes, Tuff-Cork, 10-3/4" X 11-5/8"	P27929TC	1
1968-1974, 9" Gear, 10 Bolt Holes, 10-3/4" X 11-5/8"	P27929	1	1958-1960, 9" Gear, 10 Bolt Holes, 10-3/4" X 11-5/8"	P27929	1
1968-1974, 9" Gear, 10 Bolt Holes, Tuff-Cork, 10-3/4" X 11-5/8"	P27929TC	1	1958-1960, 9" Gear, 10 Bolt Holes, Tuff-Cork, 10-3/4" X 11-5/8"	P27929TC	1
MONTEGO MX			PINTO		
Axle Hsg Cover Gasket			Axle Hsg Cover Gasket		
1968, 7.25" Ring Gear, 8 Bolt Holes, 8-1/2" X 9-5/8"	P27799	1	1979-1980, 6.75" Ring Gear, 10 Bolt Holes, Tuff-Cork, 9-1/2" X 10-3/4"	P27139TC	1
Diff. Carrier Gasket			1979-1980, 6.75" Ring Gear, 8 Bolt Holes, Tuff-Cork, 8-1/4" X 8-7/8"	P27609TC	1
1975-1976, 9" Gear, 10 Bolt Holes, 10-3/4" X 11-5/8"	P27994	1	1975-1978, 6.75" Ring Gear, 8 Bolt Holes, 8-1/2" X 9-5/8"	P27592	1
1975-1976, 9" Gear, 10 Bolt Holes, Tuff-Cork, 10-3/4" X 11-5/8"	P27994TC	1			
1968-1974, 8" Gear, 10 Bolt Holes, 9-3/4" X 10-15/16"	P27807	1			
1968-1974, 9" Gear, 10 Bolt Holes, 10-3/4" X 11-5/8"	P27929	1			
1968-1974, 9" Gear, 10 Bolt Holes, Tuff-Cork, 10-3/4" X 11-5/8"	P27929TC	1			

Ford (cont.)

Differential Housing Cover Gaskets (cont.)

<i>Model & Application</i>	<i>Part No.</i>	<i>Qty.</i>	<i>Model & Application</i>	<i>Part No.</i>	<i>Qty.</i>
PINTO (cont.)			TORINO		
Axle Hsg Cover Gasket (cont.)			Axle Hsg Cover Gasket		
1971-1974	P27592	1	1968-1970, 7.25" Ring Gear, 8 Bolt Holes, 8-1/2" X 9-5/8"	P27799	1
Diff. Carrier Gasket			Diff. Carrier Gasket		
1975-1980, 8" Gear, 10 Bolt Holes, 9-3/4" X 10-15/16"	P27807	1	1975-1976	P27994	1
PREMIER			1975-1976, Tuff-Cork	P27994TC	1
Diff. Carrier Gasket			1968-1974, 8" Gear, 10 Bolt Holes, 9-3/4" X 10-15/16"	P27807	1
1956-1960	P27934	1	1968-1974, 9" Gear, 10 Bolt Holes, 10-3/4" X 11-5/8"	P27929	1
RANCH WAGON			1968-1974, 9" Gear, 10 Bolt Holes, Tuff-Cork, 10-3/4" X 11-5/8"	P27929TC	1
Diff. Carrier Gasket			TOWN CAR		
1957-1959	P27929	1	Axle Hsg Cover Gasket		
1957-1959, Tuff-Cork	P27929TC	1	1985-1995, 7.5" Ring Gear, 10 Bolt Holes, Tuff-Cork, 9-1/2" X 10-3/4"	P27139TC	1
SCORPIO			1984, 7.5" Ring Gear, From 5/84, 10 Bolt Holes, Tuff-Cork, 9-1/2" X 10-3/4"	P27139TC	1
Axle Hsg Cover Gasket			1984, 7.5" Ring Gear, Thru 5/84, 10 Bolt Holes, Tuff-Cork, 9-3/4" X 10-3/4"	P38151TC	1
1988-1989, 9 Bolt Holes, Tuff-Cork, 9-9/16" X 8-3/8"	P38148TC	1	1981-1995, 8.5" Ring Gear, 8.8" Ring Gear, 10 Bolt Holes, Tuff-Cork, 10-1/2" X 11"	P27608TC	1
TEMPO			1981-1983, 7.5" Ring Gear, 10 Bolt Holes, Tuff-Cork, 9-3/4" X 10-3/4"	P38151TC	1
Axle Hsg Cover Gasket			VERSAILLES		
1987-1991, 8 Bolt Holes, 5-1/4" X 7"	P38153	1	Diff. Carrier Gasket		
THUNDERBIRD			1977-1980	P27994	1
Axle Hsg Cover Gasket			1977-1980, Tuff-Cork	P27994TC	1
1989-1995, 7.5" Ring Gear, Tuff-Cork	P38164TC	1	ZEPHYR		
1989-1995, 8.8" Ring Gear, Tuff-Cork	P38165TC	1	Axle Hsg Cover Gasket		
1988, 8.8" Ring Gear, 10 Bolt Holes, Tuff-Cork, 10-1/2" X 11"	P27608TC	1	1978-1983, 6.75" Ring Gear, 7.5" Ring Gear, 8 Bolt Holes, Tuff-Cork, 8-1/4" X 8-7/8"	P27609TC	1
1980-1987, 7.5" Ring Gear, 10 Bolt Holes, Tuff-Cork, 9-1/2" X 10-3/4"	P27139TC	1	1978-1983, 7.5" Ring Gear, 10 Bolt Holes, Tuff-Cork, 9-1/2" X 10-3/4"	P27139TC	1
1980-1987, 7.5" Ring Gear, 8 Bolt Holes, Tuff-Cork, 8-1/4" X 8-7/8"	P27609TC	1	1978-1983, 8.5" Ring Gear, 10 Bolt Holes, Tuff-Cork, 10-1/2" X 11"	P27608TC	1
Diff. Carrier Gasket			TOPAZ		
1977-1979	P27994	1	Axle Hsg Cover Gasket		
1977-1979, Tuff-Cork	P27994TC	1	1987-1991, 8 Bolt Holes, 5-1/4" X 7"	P38153	1
1958-1976	P27929	1			
1958-1976, Tuff-Cork	P27929TC	1			

Transmission Gaskets

<i>Model & Application</i>	<i>Part No.</i>	<i>Qty.</i>	<i>Model & Application</i>	<i>Part No.</i>	<i>Qty.</i>
ASPIRE			CALIENTA		
Transaxle Pan Gasket			Transmission Gasket Set		
1994-1995, ATX Transaxle, Tuff-Cork	W38429TC	1	1964-1967, 3 Speed Transmission	TS27817X	1
Valve Body Cover Gasket			1964-1966, 3 Speed Transmission	TS26399	1
1994-1995, ATX Transaxle, Tuff-Cork	W38139TC	1	1964-1966, 4 Speed Transmission	TS27831	1
BOBCAT			Transmission Pan Gasket		
Transmission Gasket Set			1966-1967, Cruise-O-Matic FX, FMX Transmission	W38987	1
1980, Ford RAP Transmission	TS27229	1	1966-1967, Cruise-O-Matic MX Transmission	W38986	1
1980, Ford RUG Transmission	TS27831	1	1964-1966, Cruise-O-Matic FX, FMX Transmission, Cruise-O-Matic Transmission, Light Duty, Medium Duty	W38987	1
1975-1979, 4 Speed Transmission	TS27831	1	1964-1966, Cruise-O-Matic MX Transmission, Cruise-O-Matic Transmission, Heavy Duty	W38986	1
1975-1979, 4 Speed Transmission	TS27831Z	1			
1975-1978, 3 Speed Transmission	TS27817X	1			
Transmission Pan Gasket					
1975-1980, C3 Automatic Transmission, Dual Range	W37978	1			

Transmission Gaskets (cont.)

<i>Model & Application</i>	<i>Part No.</i>	<i>Qty.</i>	<i>Model & Application</i>	<i>Part No.</i>	<i>Qty.</i>
CAPRI			COMET (cont.)		
Transmission Pan Gasket			Transmission Gasket Set (cont.)		
1955-1957, Turbo Drive Transmission	W38986	1	1960-1966, 3 Speed Transmission	TS26399	1
Transaxle Pan Gasket			1960-1961, 4 Speed Transmission	TS27075Z	1
1991-1992, Automatic Transmission, Tuff-Cork	W31127TC	1	Transmission Pan Gasket		
Transmission Gasket Set			1971-1977, C4 Automatic Transmission, Dual Range	W39349	1
1980-1986, Ford RAD Transmission	TS27831Z	1	1971-1977, C4 Automatic Transmission, Dual Range, Tuff-Cork	W39349TC	1
1980-1983, Ford RAP Transmission	TS27229	1	1968-1969, C4 Automatic Transmission, Dual Range	W39349	1
1976-1979, 4 Speed Transmission	TS27831Z	1	1968-1969, C4 Automatic Transmission, Dual Range, Tuff-Cork	W39349TC	1
1971-1979, 4 Speed Transmission	TS27831	1	1965-1967, Cruise-O-Matic MX Transmission	W38986	1
1966-1967, 3 Speed Transmission	TS27817X	1	1964-1967, Cruise-O-Matic MX Transmission, Cruise-O-Matic Transmission, Heavy Duty	W38986	1
1966, 3 Speed Transmission	TS26399	1	1960, Ford-O-Matic 3 Speed Transmission	W38987	1
1966, 4 Speed Transmission	TS27831	1	COMMUTER		
Transmission Pan Gasket			Transmission Gasket Set		
1984-1986, C5 Automatic Transmission, Dual Range	W39349	1	1964-1968, 3 Speed Transmission	TS27817X	1
1984-1986, C5 Automatic Transmission, Dual Range, Tuff-Cork	W39349TC	1	1964-1968, 4 Speed Transmission	TS27831	1
1982-1986, AOD Transmission	W38430	1	1964, Overdrive Transmission	TS27545Y	1
1982-1983, C4 Automatic Transmission, Dual Range	W39349	1	Transmission Pan Gasket		
1982-1983, C4 Automatic Transmission, Dual Range, Tuff-Cork	W39349TC	1	1965-1968, Cruise-O-Matic FX, FMX Transmission	W38987	1
1980-1984, C4 Automatic Transmission, C5 Automatic Transmission, Dual Range	W39349	1	1965-1968, Cruise-O-Matic MX Transmission	W38986	1
1980-1984, C4 Automatic Transmission, C5 Automatic Transmission, Dual Range, Tuff-Cork	W39349TC	1	1964-1968, Cruise-O-Matic FX, FMX Transmission, Cruise-O-Matic Transmission, Light Duty, Medium Duty	W38987	1
1979-1980, C4 Automatic Transmission, Dual Range	W39349	1	1964-1968, Cruise-O-Matic MX Transmission, Cruise-O-Matic Transmission, Heavy Duty	W38986	1
1979-1980, C4 Automatic Transmission, Dual Range, Tuff-Cork	W39349TC	1	COUGAR		
1979, Cruise-O-Matic Transmission	W38987	1	Transmission Gasket Set		
1974-1986, C3 Automatic Transmission, Dual Range	W37978	1	1967-1978, 3 Speed Transmission	TS27817X	1
1966-1967, Cruise-O-Matic FX, FMX Transmission	W38987	1	1967-1971, 4 Speed Transmission	TS27831	1
1966-1967, Cruise-O-Matic MX Transmission	W38986	1	Transmission Pan Gasket		
Valve Body Cover Gasket			1991-1995, AODE Transmission, AODEW Transmission	W39141	1
1991-1992, Automatic Transmission, Tuff-Cork	W31129TC	1	1984-1986, C3 Automatic Transmission, Dual Range	W37978	1
COLONY PARK			1984-1986, C5 Automatic Transmission, Dual Range	W39349	1
Transmission Gasket Set			1984-1986, C5 Automatic Transmission, Dual Range, Tuff-Cork	W39349TC	1
1964-1967, 3 Speed Transmission	TS27817X	1	1981-1983, C4 Automatic Transmission, C5 Automatic Transmission, Dual Range	W39349	1
1964-1967, 4 Speed Transmission	TS27831	1	1981-1983, C4 Automatic Transmission, C5 Automatic Transmission, Dual Range, Tuff-Cork	W39349TC	1
1961-1962, Overdrive Transmission	TS27545Y	1	1981-1982, C3 Automatic Transmission, Dual Range	W37978	1
1960-1962, 3 Speed Transmission	TS27051W	1	1980-1993, AOD Transmission	W38430	1
1960-1961, 4 Speed Transmission	TS27075Z	1	1974-1978, Cruise-O-Matic Transmission	W38987	1
1958, Overdrive Transmission	TS27545Y	1	1973-1974, Borg Warner Transmission	W38987	1
1957-1958, 3 Speed Transmission	TS27051W	1	1970-1983, C4 Automatic Transmission, Dual Range	W39349	1
Transmission Pan Gasket			1970-1983, C4 Automatic Transmission, Dual Range, Tuff-Cork	W39349TC	1
1966-1968, C6 Automatic Transmission, Dual Range	W39346	1	1969-1980, Cruise-O-Matic Transmission	W38987	1
1966-1968, C6 Automatic Transmission, Dual Range, Tuff-Cork	W39346TC	1	1969-1979, C6 Automatic Transmission, Dual Range	W39346	1
1957-1959, Ford-O-Matic Transmission, Heavy Duty	W38986	1			
1957-1959, Ford-O-Matic Transmission, Light Duty	W38987	1			
COMET					
Transmission Gasket Set					
1964-1967, 3 Speed Transmission	TS27817X	1			
1964-1966, 4 Speed Transmission	TS27831	1			

Ford (cont.)

Transmission Gaskets (cont.)

<i>Model & Application</i>	<i>Part No.</i>	<i>Qty.</i>	<i>Model & Application</i>	<i>Part No.</i>	<i>Qty.</i>
COUGAR (cont.)			CROWN VICTORIA		
Transmission Pan Gasket (cont.)			Transmission Pan Gasket		
1969-1979, C6 Automatic Transmission, Dual Range, Tuff-Cork.	W39346TC	1	1992-1995, AODE Transmission, AODEW Transmission.	W39141	1
1969, Automatic 3 Speed Transmission, Dual Range.	W37953	1	1983-1993, AOD Transmission.	W38430	1
1968, Cruise-O-Matic FX, FMX Transmission.	W38987	1	1983, C4 Automatic Transmission, Dual Range.	W39349	1
1967-1969, Automatic 3 Speed Transmission, Dual Range.	W37954	1	1983, C4 Automatic Transmission, Dual Range, Tuff-Cork.	W39349TC	1
1967-1969, Cruise-O-Matic FX, FMX Transmission, Cruise-O-Matic Transmission.	W38987	1	CUSTOM		
1967-1968, Cruise-O-Matic FX, FMX Transmission.	W38987	1	Transmission Gasket Set		
1967-1968, Cruise-O-Matic MX Transmission.	W38986	1	1952-1956, 3 Speed Transmission.	TS27051W	1
COUNTRY SEDAN			1965-1967, 3 Speed Transmission, 4 Bolt Top Cover.	TS26399	1
Transmission Gasket Set			1965-1967, 3 Speed Transmission, Except 4 Bolt Top Cover.	TS27817X	1
1963-1968, 3 Speed Transmission, 4 Bolt Top Cover.	TS26399	1	1964-1970, 4 Speed Transmission.	TS27831	1
1963-1968, 3 Speed Transmission, Except 4 Bolt Top Cover.	TS27817X	1	1957, 3 Speed Transmission.	TS27051W	1
1963-1968, 4 Speed Transmission.	TS27831	1	1957, Overdrive Transmission.	TS27545Y	1
1961, 3 Speed Transmission.	TS26399	1	1949-1951, 3 Speed Transmission.	TS27051W	1
1960-1962, 4 Speed Transmission.	TS27075Z	1	Transmission Pan Gasket		
1959-1962, 3 Speed Transmission.	TS27051W	1	1970-1972, C4 Automatic Transmission, Dual Range.	W39349	1
1959-1961, Overdrive Transmission.	TS27545Y	1	1970-1972, C4 Automatic Transmission, Dual Range, Tuff-Cork.	W39349TC	1
1957, Overdrive Transmission.	TS27545Y	1	1967-1972, C6 Automatic Transmission, Dual Range.	W39346	1
1955-1957, 3 Speed Transmission.	TS27051W	1	1967-1972, C6 Automatic Transmission, Dual Range, Tuff-Cork.	W39346TC	1
Transmission Pan Gasket			1957, Ford-O-Matic Transmission, Heavy Duty.	W38986	1
1966-1968, C6 Automatic Transmission, Dual Range.	W39346	1	1957, Ford-O-Matic Transmission, Light Duty.	W38987	1
1966-1968, C6 Automatic Transmission, Dual Range, Tuff-Cork.	W39346TC	1	1955, Turbo Drive Transmission.	W38986	1
1962-1968, Cruise-O-Matic FX, FMX Transmission, Cruise-O-Matic Transmission, Light Duty, Medium Duty.	W38987	1	1949-1951, Ford-O-Matic Transmission.	W38987	1
1962-1968, Cruise-O-Matic MX Transmission, Cruise-O-Matic Transmission, Heavy Duty.	W38986	1	CUSTOM 300		
1956-1959, Ford-O-Matic Transmission, Heavy Duty.	W38986	1	Transmission Gasket Set		
1956-1959, Ford-O-Matic Transmission, Light Duty.	W38987	1	1957-1959, 3 Speed Transmission.	TS27051W	1
1955, Ford-O-Matic Transmission.	W38987	1	1957-1959, Overdrive Transmission.	TS27545Y	1
COUNTRY SQUIRE			Transmission Pan Gasket		
Transmission Gasket Set			1957-1959, Ford-O-Matic Transmission, Heavy Duty.	W38986	1
1956-1958, Overdrive Transmission.	TS27545Y	1	1957-1959, Ford-O-Matic Transmission, Light Duty.	W38987	1
1955-1958, 3 Speed Transmission.	TS27051W	1	CUSTOM 500		
Transmission Pan Gasket			Transmission Gasket Set		
1956-1958, Ford-O-Matic Transmission, Heavy Duty.	W38986	1	1965-1967, 3 Speed Transmission, 4 Bolt Top Cover.	TS26399	1
1956-1958, Ford-O-Matic Transmission, Light Duty.	W38987	1	1965-1967, 3 Speed Transmission, Except 4 Bolt Top Cover.	TS27817X	1
1955, Ford-O-Matic Transmission.	W38987	1	1964-1970, 4 Speed Transmission.	TS27831	1
CRESTLINE			1964, Overdrive Transmission.	TS27545Y	1
Transmission Gasket Set			Transmission Pan Gasket		
1950-1954, 3 Speed Transmission.	TS27051W	1	1970-1977, C4 Automatic Transmission, Dual Range.	W39349	1
Transmission Pan Gasket			1970-1977, C4 Automatic Transmission, Dual Range, Tuff-Cork.	W39349TC	1
1950-1954, Ford-O-Matic Transmission.	W38987	1	1969-1977, Cruise-O-Matic Transmission.	W38987	1
			1966-1977, C6 Automatic Transmission, Dual Range.	W39346	1
			1966-1977, C6 Automatic Transmission, Dual Range, Tuff-Cork.	W39346TC	1
			1965-1968, Cruise-O-Matic FX, FMX Transmission.	W38987	1

Transmission Gaskets (cont.)

<i>Model & Application</i>	<i>Part No.</i>	<i>Qty.</i>	<i>Model & Application</i>	<i>Part No.</i>	<i>Qty.</i>
CUSTOM 500 (cont.)			FAIRLANE (cont.)		
Transmission Pan Gasket (cont.)			Transmission Gasket Set (cont.)		
1965-1968, Cruise-O-Matic MX Transmission	W38986	1	1963, 3 Speed Transmission	TS26399	1
1964-1968, Cruise-O-Matic FX, FMX Transmission, Cruise-O-Matic Transmission, Light Duty, Medium Duty	W38987	1	1960-1961, 4 Speed Transmission	TS27075Z	1
1964-1968, Cruise-O-Matic MX Transmission, Cruise-O-Matic Transmission, Heavy Duty	W38986	1	1956-1964, Overdrive Transmission	TS27545Y	1
CUSTOMLINE			1955-1962, 3 Speed Transmission	TS27051W	1
Transmission Gasket Set			Transmission Pan Gasket		
1952-1956, 3 Speed Transmission	TS27051W	1	1969, Automatic 3 Speed Transmission, Dual Range	W37953	1
Transmission Pan Gasket			1966-1969, C6 Automatic Transmission, Dual Range	W39346	1
1956, Ford-O-Matic Transmission, Heavy Duty	W38986	1	1966-1969, C6 Automatic Transmission, Dual Range, Tuff-Cork	W39346TC	1
1956, Ford-O-Matic Transmission, Light Duty	W38987	1	1965-1969, Automatic 3 Speed Transmission, Dual Range	W37954	1
1952-1955, Ford-O-Matic Transmission	W38987	1	1956-1959, Ford-O-Matic Transmission, Heavy Duty	W38986	1
CYCLONE			1956-1957, Ford-O-Matic Transmission, Light Duty	W38987	1
Transmission Gasket Set			1955, Ford-O-Matic Transmission	W38987	1
1967, 3 Speed Transmission	TS27817X	1	FAIRLANE 500		
1965, 3 Speed Transmission	TS27817X	1	Transmission Gasket Set		
1964-1971, 4 Speed Transmission	TS27831	1	1965-1967, 3 Speed Transmission, 4 Bolt Top Cover	TS26399	1
Transmission Pan Gasket			1965-1967, 3 Speed Transmission, Except 4 Bolt Top Cover	TS27817X	1
1970-1971, C4 Automatic Transmission, Dual Range	W39349	1	1964-1970, 4 Speed Transmission	TS27831	1
1970-1971, C4 Automatic Transmission, Dual Range, Tuff-Cork	W39349TC	1	1964-1965, 3 Speed Transmission, 4 Bolt Top Cover, Except Heavy Duty	TS26399	1
1969-1971, Cruise-O-Matic Transmission	W38987	1	1964, 3 Speed Transmission, Except Heavy Duty	TS26399	1
1969, Cruise-O-Matic FX, FMX Transmission, Cruise-O-Matic Transmission	W38987	1	1964, 3 Speed Transmission, Heavy Duty	TS27075W	1
1965-1968, C4 Automatic Transmission	W37954	1	1961-1963, 3 Speed Transmission	TS26399	1
DELUXE			1960-1961, 4 Speed Transmission	TS27075Z	1
Transmission Gasket Set			1957-1964, Overdrive Transmission	TS27545Y	1
1949-1951, 3 Speed Transmission	TS27051W	1	1957-1962, 3 Speed Transmission	TS27051W	1
Transmission Pan Gasket			Transmission Pan Gasket		
1949-1951, Ford-O-Matic Transmission	W38987	1	1970, C4 Automatic Transmission, Dual Range	W39349	1
EXP			1970, C4 Automatic Transmission, Dual Range, Tuff-Cork	W39349TC	1
Valve Body Cover Gasket			1966-1970, C6 Automatic Transmission, Dual Range	W39346	1
1986-1988, ATX Transaxle, Tuff-Cork	W38139TC	1	1966-1970, C6 Automatic Transmission, Dual Range, Tuff-Cork	W39346TC	1
ESCORT			1965-1969, Automatic 3 Speed Transmission, Dual Range	W37954	1
Transaxle Gasket			1957-1959, Ford-O-Matic Transmission, Heavy Duty	W38986	1
1989-1992, Automatic Transmission, Tuff-Cork	W31131TC	1	1957-1959, Ford-O-Matic Transmission, Light Duty	W38987	1
Transaxle Pan Gasket			FAIRMONT		
1998-2003, Tuff-Cork	W31131TC	1	Transmission Gasket Set		
1986-1995, ATX Transaxle, Tuff-Cork	W38429TC	1	1980-1983, Ford RAD Transmission	TS27831Z	1
Valve Body Cover Gasket			1980-1983, Ford RUG Transmission	TS27831	1
1986-1995, ATX Transaxle, Tuff-Cork	W38139TC	1	1978-1979, 4 Speed Transmission	TS27831Z	1
FAIRLANE			1978, 3 Speed Transmission	TS27817X	1
Transmission Gasket Set			Transmission Pan Gasket		
1965-1967, 3 Speed Transmission, 4 Bolt Top Cover	TS26399	1	1980-1983, C4 Automatic Transmission, C5 Automatic Transmission, Dual Range	W39349	1
1965-1967, 3 Speed Transmission, Except 4 Bolt Top Cover	TS27817X	1	1980-1983, C4 Automatic Transmission, C5 Automatic Transmission, Dual Range, Tuff-Cork	W39349TC	1
1964-1969, 4 Speed Transmission	TS27831	1	1978-1983, C3 Automatic Transmission, Dual Range	W37978	1
1964, 3 Speed Transmission, Except Heavy Duty	TS26399	1			
1964, 3 Speed Transmission, Heavy Duty	TS27075W	1			

Ford (cont.)

Transmission Gaskets (cont.)

<i>Model & Application</i>	<i>Part No.</i>	<i>Qty.</i>	<i>Model & Application</i>	<i>Part No.</i>	<i>Qty.</i>
FAIRMONT (cont.)			GRAN TORINO (cont.)		
Transmission Pan Gasket (cont.)			Transmission Pan Gasket (cont.)		
1978-1981, C4 Automatic Transmission, Dual Range	W39349	1	1972-1976, C4 Automatic Transmission, Dual Range, Tuff-Cork	W39349TC	1
1978-1981, C4 Automatic Transmission, Dual Range, Tuff-Cork	W39349TC	1	1972-1976, C6 Automatic Transmission, Dual Range	W39346	1
1978-1979, Cruise-O-Matic Transmission	W38987	1	1972-1976, C6 Automatic Transmission, Dual Range, Tuff-Cork	W39346TC	1
FALCON			1972-1976, Cruise-O-Matic Transmission		
Transmission Gasket Set			1972-1974, Borg Warner Transmission, Cruise-O-Matic Transmission		
1965-1967, 3 Speed Transmission, 4 Bolt Top Cover	TS26399	1	W38987	1	
1965-1967, 3 Speed Transmission, Except 4 Bolt Top Cover	TS27817X	1	GRANADA		
1964-1970, 4 Speed Transmission	TS27831	1	Transmission Gasket Set		
1964, 3 Speed Transmission, Except Heavy Duty	TS26399	1	1981-1982, Ford RUG Transmission	TS27831	1
1964, 3 Speed Transmission, Heavy Duty	TS27075W	1	1980-1982, Ford RAD Transmission	TS27831Z	1
1960-1963, 3 Speed Transmission	TS26399	1	1977-1979, 4 Speed Transmission	TS27831	1
1960-1961, 4 Speed Transmission	TS27075Z	1	1975-1978, 3 Speed Transmission	TS27817X	1
Transmission Pan Gasket			Transmission Pan Gasket		
1965-1970, Automatic 3 Speed Transmission, Dual Range	W37954	1	1981-1982, C3 Automatic Transmission, Dual Range	W37978	1
1965-1968, Cruise-O-Matic MX Transmission	W38986	1	1981-1982, C4 Automatic Transmission, C5 Automatic Transmission, Dual Range	W39349	1
1960, Ford-O-Matic 3 Speed Transmission	W38987	1	1981-1982, C4 Automatic Transmission, C5 Automatic Transmission, Dual Range, Tuff-Cork	W39349TC	1
FESTIVA			1977-1980, Jatco Transmission		
Transaxle Pan Gasket			1975-1981, C4 Automatic Transmission, Dual Range		
1988-1993, ATX Transaxle	W29097	1	1975-1981, C4 Automatic Transmission, Dual Range, Tuff-Cork	W39349TC	1
FOCUS			1975-1980, Cruise-O-Matic Transmission		
Transaxle Pan Gasket			1975-1977, C3 Automatic Transmission, Dual Range		
2003, Tuff-Cork	W31131TC	1	W37978	1	
GALAXIE 500			GRAND MARQUIS		
Transmission Gasket Set			Transmission Pan Gasket		
1965-1967, 3 Speed Transmission, 4 Bolt Top Cover	TS26399	1	1992-1995, AODE Transmission, AODEW Transmission	W39141	1
1965-1966, 3 Speed Transmission, Except 4 Bolt Top Cover	TS27817X	1	1980-1993, AOD Transmission	W38430	1
1964-1970, 4 Speed Transmission	TS27831	1	1979-1983, C4 Automatic Transmission, Dual Range	W39349	1
1963-1964, Overdrive Transmission	TS27545Y	1	1979-1983, C4 Automatic Transmission, Dual Range, Tuff-Cork	W39349TC	1
1962, 3 Speed Transmission	TS27051W	1	1975-1980, C6 Automatic Transmission, Dual Range	W39346	1
Transmission Pan Gasket			1975-1980, C6 Automatic Transmission, Dual Range, Tuff-Cork		
1970-1974, C4 Automatic Transmission, Dual Range	W39349	1	1975-1980, Cruise-O-Matic Transmission	W38987	1
1970-1974, C4 Automatic Transmission, Dual Range, Tuff-Cork	W39349TC	1	LTD		
1966-1974, C6 Automatic Transmission, Dual Range	W39346	1	Transmission Gasket Set		
1966-1974, C6 Automatic Transmission, Dual Range, Tuff-Cork	W39346TC	1	1985, Ford RAD Transmission	TS27831Z	1
1962-1974, Cruise-O-Matic FX, FMX Transmission, Cruise-O-Matic Transmission, Light Duty, Medium Duty	W38987	1	1967-1971, 4 Speed Transmission	TS27831	1
1962-1968, Cruise-O-Matic MX Transmission, Cruise-O-Matic Transmission, Heavy Duty	W38986	1	Transmission Pan Gasket		
GRAN TORINO			1983-1986, C3 Automatic Transmission, Dual Range		
Transmission Gasket Set			1980-1986, AOD Transmission		
1972-1976, 3 Speed Transmission	TS27817X	1	1973-1974, Borg Warner Transmission	W38987	1
1972-1973, 4 Speed Transmission	TS27831	1	1970-1986, C4 Automatic Transmission, C5 Automatic Transmission, Dual Range	W39349	1
Transmission Pan Gasket			1970-1986, C4 Automatic Transmission, C5 Automatic Transmission, Dual Range, Tuff-Cork		
1972-1976, C4 Automatic Transmission, Dual Range	W39349	1	1969-1980, Cruise-O-Matic Transmission	W38987	1
			1967-1980, C6 Automatic Transmission, Dual Range	W39346	1

Transmission Gaskets (cont.)

<i>Model & Application</i>	<i>Part No.</i>	<i>Qty.</i>	<i>Model & Application</i>	<i>Part No.</i>	<i>Qty.</i>
LTD (cont.)			MARK II		
Transmission Pan Gasket (cont.)			Transmission Pan Gasket		
1967-1980, C6 Automatic Transmission, Dual Range, Tuff-Cork	W39346TC	1	1956-1957, Turbo Drive Transmission	W38986	1
1967-1968, Cruise-O-Matic FX, FMX Transmission	W38987	1	MARQUIS		
1967-1968, Cruise-O-Matic MX Transmission	W38986	1	Transmission Gasket Set		
LTD COUNTRY SQUIRE			1967, 3 Speed Transmission TS27817X 1		
Transmission Pan Gasket			1967, 4 Speed Transmission TS27831 1		
1983-1991, AOD Transmission	W38430	1	Transmission Pan Gasket		
1983, C4 Automatic Transmission, C5 Automatic Transmission, Dual Range	W39349	1	1983-1986, C3 Automatic Transmission, Dual Range W37978 1		
1983, C4 Automatic Transmission, C5 Automatic Transmission, Dual Range, Tuff-Cork	W39349TC	1	1980-1982, AOD Transmission W38430 1		
LTD II			1975-1986, C4 Automatic Transmission, C5 Automatic Transmission, Dual Range W39349 1		
Transmission Pan Gasket			1975-1986, C4 Automatic Transmission, C5 Automatic Transmission, Dual Range, Tuff-Cork W39349TC 1		
1977-1979, C4 Automatic Transmission, C5 Automatic Transmission, Dual Range	W39349	1	1971-1980, Cruise-O-Matic Transmission W38987 1		
1977-1979, C4 Automatic Transmission, C5 Automatic Transmission, Dual Range, Tuff-Cork	W39349TC	1	1969, Cruise-O-Matic Transmission W38987 1		
1977-1979, C6 Automatic Transmission, Dual Range	W39346	1	1968-1969, Cruise-O-Matic FX, FMX Transmission, Cruise-O-Matic Transmission W38987 1		
1977-1979, C6 Automatic Transmission, Dual Range, Tuff-Cork	W39346TC	1	1968, Cruise-O-Matic MX Transmission W38986 1		
1977-1979, Cruise-O-Matic Transmission	W38987	1	1967-1980, C6 Automatic Transmission, Dual Range, Tuff-Cork W39346TC 1		
LYNX			MAVERICK		
Transaxle Pan Gasket			Transmission Gasket Set		
1986-1987, ATX Transaxle, Tuff-Cork	W38429TC	1	1969-1977, 3 Speed Transmission TS27817X 1		
Valve Body Cover Gasket			Transmission Pan Gasket		
1986-1987, ATX Transaxle, Tuff-Cork	W38139TC	1	1973-1974, Borg Warner Transmission W38987 1		
MAINLINE			1971-1976, C4 Automatic Transmission, Dual Range W39349 1		
Transmission Gasket Set			1971-1976, C4 Automatic Transmission, Dual Range, Tuff-Cork W39349TC 1		
1956, Overdrive Transmission	TS27545Y	1	1971-1974, Borg Warner Transmission, Cruise-O-Matic Transmission W38987 1		
1952-1956, 3 Speed Transmission	TS27051W	1	1970-1977, C4 Automatic Transmission, Dual Range, PEB-D1 Transmission W39349 1		
Transmission Pan Gasket			1970-1977, C4 Automatic Transmission, Dual Range, PEB-D1 Transmission, Tuff-Cork W39349TC 1		
1956, Ford-O-Matic Transmission, Heavy Duty	W38986	1	1970, PEB-D Transmission W37954 1		
1956, Ford-O-Matic Transmission, Light Duty	W38987	1	1970, PEB-D1 Transmission W39349 1		
1952-1955, Ford-O-Matic Transmission	W38987	1	1970, PEB-D1 Transmission, Tuff-Cork W39349TC 1		
MARAUDER			1969-1977, Cruise-O-Matic Transmission W38987 1		
Transmission Gasket Set			MEDALIST		
1969-1970, 4 Speed Transmission	TS27831	1	Transmission Gasket Set		
1964-1965, 3 Speed Transmission	TS27817X	1	1958, 3 Speed Transmission TS27051W 1		
1964-1965, 4 Speed Transmission	TS27831	1	1956, 3 Speed Transmission TS27051W 1		
1963-1964, Overdrive Transmission	TS27545Y	1	1956, Overdrive Transmission TS27545Y 1		
Transmission Pan Gasket			Transmission Pan Gasket		
1969, Cruise-O-Matic Transmission	W38987	1	1958, Ford-O-Matic Transmission, Heavy Duty W38986 1		
1965, Cruise-O-Matic FX, FMX Transmission	W38987	1	1958, Ford-O-Matic Transmission, Light Duty W38987 1		
1963-1965, Cruise-O-Matic MX Transmission, Cruise-O-Matic Transmission, Heavy Duty	W38986	1	1956, Ford-O-Matic Transmission, Heavy Duty W38986 1		
1963-1964, Cruise-O-Matic Transmission, Light Duty, Medium Duty	W38987	1	1956, Ford-O-Matic Transmission, Light Duty W38987 1		
MARAUDER X-100			MERCURY		
Transmission Gasket Set			Transmission Gasket Set		
1969-1970, 3 Speed Transmission	TS27817X	1	1949-1951, 3 Speed Transmission TS27051W 1		
1969-1970, 4 Speed Transmission	TS27831	1			

PASSENGER CAR

Ford (cont.)

Transmission Gaskets (cont.)

<i>Model & Application</i>	<i>Part No.</i>	<i>Qty.</i>	<i>Model & Application</i>	<i>Part No.</i>	<i>Qty.</i>
MERCURY (cont.)			MONTEGO MX		
Transmission Pan Gasket			Transmission Gasket Set		
1949-1951, Ford-O-Matic Transmission	W38987	1	1968-1976, 3 Speed Transmission	TS27817X	1
METEOR			1968-1973, 4 Speed Transmission	TS27831	1
Transmission Gasket Set			Transmission Pan Gasket		
1962, 3 Speed Transmission	TS26399	1	1973-1974, Borg Warner Transmission	W38987	1
1962, Overdrive Transmission	TS27545Y	1	1970-1976, C4 Automatic Transmission, Dual Range.	W39349	1
1961, 3 Speed Transmission	TS27051W	1	1970-1976, C4 Automatic Transmission, Dual Range, Tuff-Cork.	W39349TC	1
1961, 4 Speed Transmission	TS27075Z	1	1969-1976, Cruise-O-Matic Transmission	W38987	1
Transmission Pan Gasket			1969, Automatic 3 Speed Transmission, Dual Range.	W37953	1
1961, Cruise-O-Matic Transmission, Heavy Duty.	W38986	1	1968-1976, C6 Automatic Transmission, Dual Range.	W39346	1
1961, Cruise-O-Matic Transmission, Light Duty, Medium Duty	W38987	1	1968-1976, C6 Automatic Transmission, Dual Range, Tuff-Cork.	W39346TC	1
MONARCH			1968-1969, Automatic 3 Speed Transmission, Dual Range.	W37954	1
Transmission Gasket Set			1968-1969, Cruise-O-Matic FX, FMX Transmission, Cruise-O-Matic Transmission.	W38987	1
1977-1979, 4 Speed Transmission	TS27831	1	1968, Cruise-O-Matic FX, FMX Transmission.	W38987	1
1975-1978, 3 Speed Transmission	TS27817X	1	1968, Cruise-O-Matic MX Transmission	W38986	1
Transmission Pan Gasket			MONTEGO MX BROUGHAM		
1977-1980, Jatco Transmission	W37979	1	Transmission Gasket Set		
1975-1980, C4 Automatic Transmission, Dual Range.	W39349	1	1972-1973, 4 Speed Transmission	TS27831	1
1975-1980, C4 Automatic Transmission, Dual Range, Tuff-Cork.	W39349TC	1	1970-1976, 3 Speed Transmission	TS27817X	1
1975-1980, Cruise-O-Matic Transmission	W38987	1	1970, 4 Speed Transmission	TS27831	1
MONTCLAIR			Transmission Pan Gasket		
Transmission Gasket Set			1971-1974, Borg Warner Transmission, Cruise-O-Matic Transmission	W38987	1
1960, 4 Speed Transmission	TS27075Z	1	1970-1976, C4 Automatic Transmission, Dual Range.	W39349	1
1956-1959, Overdrive Transmission	TS27545Y	1	1970-1976, C4 Automatic Transmission, Dual Range, Tuff-Cork.	W39349TC	1
1955-1960, 3 Speed Transmission	TS27051W	1	1970-1976, C6 Automatic Transmission, Dual Range.	W39346	1
Transmission Pan Gasket			1970-1976, C6 Automatic Transmission, Dual Range, Tuff-Cork.	W39346TC	1
1956-1959, Ford-O-Matic Transmission, Heavy Duty.	W38986	1	1970-1976, Cruise-O-Matic Transmission	W38987	1
1955-1957, Ford-O-Matic Transmission, Light Duty.	W38987	1	MONTEREY		
MONTEGO			Transmission Gasket Set		
Transmission Gasket Set			1964-1967, 3 Speed Transmission	TS27817X	1
1968-1976, 3 Speed Transmission	TS27817X	1	1964-1967, 4 Speed Transmission	TS27831	1
1968-1973, 4 Speed Transmission	TS27831	1	1960-1961, 4 Speed Transmission	TS27075Z	1
Transmission Pan Gasket			1956-1965, Overdrive Transmission	TS27545Y	1
1973-1974, Borg Warner Transmission	W38987	1	1950-1962, 3 Speed Transmission	TS27051W	1
1972-1973, Borg Warner Transmission, Cruise-O-Matic Transmission	W38987	1	Transmission Pan Gasket		
1970-1976, C4 Automatic Transmission, Dual Range.	W39349	1	1971-1973, C4 Automatic Transmission, Dual Range.	W39349	1
1970-1976, C4 Automatic Transmission, Dual Range, Tuff-Cork.	W39349TC	1	1971-1973, C4 Automatic Transmission, Dual Range, Tuff-Cork.	W39349TC	1
1969-1976, Cruise-O-Matic Transmission	W38987	1	1966-1974, C6 Automatic Transmission, Dual Range.	W39346	1
1969, Automatic 3 Speed Transmission, Dual Range.	W37953	1	1966-1974, C6 Automatic Transmission, Dual Range, Tuff-Cork.	W39346TC	1
1968-1976, C6 Automatic Transmission, Dual Range.	W39346	1	1956-1959, Ford-O-Matic Transmission, Heavy Duty.	W38986	1
1968-1976, C6 Automatic Transmission, Dual Range, Tuff-Cork.	W39346TC	1	1956-1957, Ford-O-Matic Transmission, Light Duty.	W38987	1
1968-1969, Automatic 3 Speed Transmission, Dual Range.	W37954	1	1950-1955, Ford-O-Matic Transmission	W38987	1
1968-1969, Cruise-O-Matic FX, FMX Transmission, Cruise-O-Matic Transmission.	W38987	1			
1968, Cruise-O-Matic FX, FMX Transmission.	W38987	1			
1968, Cruise-O-Matic MX Transmission	W38986	1			

Transmission Gaskets (cont.)

<i>Model & Application</i>	<i>Part No.</i>	<i>Qty.</i>	<i>Model & Application</i>	<i>Part No.</i>	<i>Qty.</i>
MUSTANG			PINTO (cont.)		
Transaxle Pan Gasket			Transmission Pan Gasket		
1994-1995, AXOD Transaxle, AXODE Transaxle, Cork Rubber	W39110	1	1974-1980, C3 Automatic Transmission, Dual Range.	W37978	1
1994-1995, AXOD Transaxle, AXODE Transaxle, Tuff-Cork.	W39110TC	1	PREMIER		
Transmission Gasket Set			Transmission Pan Gasket		
1980-1986, Ford RAD Transmission	TS27831Z	1	1956-1957, Turbo Drive Transmission	W38986	1
1980-1983, Ford RAP Transmission	TS27229	1	PROBE		
1974-1979, 4 Speed Transmission	TS27831Z	1	Transaxle Pan Gasket		
1965-1979, 4 Speed Transmission	TS27831	1	1989-1995, ATX Transaxle, Tuff-Cork	W38429TC	1
1965-1967, 3 Speed Transmission, 4 Bolt Top Cover	TS26399	1	1989-1992, Automatic Transmission, Tuff-Cork	W31127TC	1
1965-1967, 3 Speed Transmission, Except 4 Bolt Top Cover	TS27817X	1	1989-1992, Automatic Transmission, Tuff-Cork	W31128TC	1
1965, 3 Speed Transmission, Except Heavy Duty	TS26399	1	Valve Body Cover Gasket		
1965, 3 Speed Transmission, Heavy Duty	TS27075W	1	1989-1995, ATX Transaxle, Tuff-Cork	W38139TC	1
Transmission Pan Gasket			1989-1992, Automatic Transmission, Tuff-Cork	W31129TC	1
1994-1995, AODE Transmission, AODEW Transmission.	W39141	1	1989-1992, Automatic Transmission, Tuff-Cork	W31130TC	1
1991-1992, AODE Transmission, AODEW Transmission.	W39141	1	RANCH WAGON		
1987-1995, A4LD Automatic Transmission, Tuff-Cork	W38144TC	1	Transmission Gasket Set		
1980-1993, AOD Transmission	W38430	1	1958-1959, Overdrive Transmission	TS27545Y	1
1974-1986, C3 Automatic Transmission, Dual Range.	W37978	1	1956, Overdrive Transmission	TS27545Y	1
1973-1974, Borg Warner Transmission	W38987	1	1955-1959, 3 Speed Transmission	TS27051W	1
1969-1986, C4 Automatic Transmission, C5 Automatic Transmission, Dual Range.	W39349	1	Transmission Pan Gasket		
1969-1986, C4 Automatic Transmission, C5 Automatic Transmission, Dual Range, Tuff-Cork	W39349TC	1	1956-1959, Ford-O-Matic Transmission, Heavy Duty.	W38986	1
1969, Automatic 3 Speed Transmission, Dual Range.	W37953	1	1956-1959, Ford-O-Matic Transmission, Light Duty.	W38987	1
1965-1980, Cruise-O-Matic FX, FMX Transmission, Cruise-O-Matic Transmission, Light Duty, Medium Duty	W38987	1	1955, Ford-O-Matic Transmission	W38987	1
1965-1969, Automatic 3 Speed Transmission, Dual Range.	W37954	1	S-55		
1965-1968, Cruise-O-Matic MX Transmission, Cruise-O-Matic Transmission, Heavy Duty	W38986	1	Transmission Gasket Set		
PARKLANE			1966, 4 Speed Transmission		
Transmission Gasket Set			TS27831		
1966-1967, 4 Speed Transmission	TS27831	1	SABLE		
1966, 3 Speed Transmission	TS27817X	1	Transaxle Pan Gasket		
1960, 3 Speed Transmission	TS27051W	1	1986-1995, ATX Transaxle, Tuff-Cork	W38429TC	1
1960, 4 Speed Transmission	TS27075Z	1	1986-1995, AXOD Transaxle, AXODE Transaxle, Cork Rubber	W39110	1
1958, 3 Speed Transmission	TS27051W	1	1986-1995, AXOD Transaxle, AXODE Transaxle, Tuff-Cork.	W39110TC	1
Transmission Pan Gasket			Valve Body Cover Gasket		
1966-1968, C6 Automatic Transmission, Dual Range.	W39346	1	1986-1995, ATX Transaxle, Tuff-Cork	W38139TC	1
1966-1968, C6 Automatic Transmission, Dual Range, Tuff-Cork.	W39346TC	1	1986-1995, AXOD Transaxle, AXODE Transaxle, Cork Rubber.	W39111	1
1958-1959, Ford-O-Matic Transmission, Heavy Duty.	W38986	1	1986-1995, AXOD Transaxle, AXODE Transaxle, Tuff-Cork.	W39111TC	1
1958-1959, Ford-O-Matic Transmission, Light Duty.	W38987	1	TAURUS		
PINTO			Transaxle Pan Gasket		
Transmission Gasket Set			1986-1995, ATX Transaxle, Tuff-Cork		
1980, Ford RAP Transmission	TS27229	1	W38429TC		
1974-1979, 4 Speed Transmission	TS27831Z	1	1986-1995, AXOD Transaxle, AXODE Transaxle, Cork Rubber		
1971-1979, 4 Speed Transmission	TS27831	1	W39110		
1971-1978, 3 Speed Transmission	TS27817X	1	1986-1995, AXOD Transaxle, AXODE Transaxle, Tuff-Cork.		
			W39110TC		
			Valve Body Cover Gasket		
			1986-1995, ATX Transaxle, Tuff-Cork		
			W38139TC		
			1986-1995, AXOD Transaxle, AXODE Transaxle, Cork Rubber.		
			W39111		
			1986-1995, AXOD Transaxle, AXODE Transaxle, Tuff-Cork.		
			W39111TC		

PASSENGER CAR

Ford (cont.)

Transmission Gaskets (cont.)

<i>Model & Application</i>	<i>Part No.</i>	<i>Qty.</i>	<i>Model & Application</i>	<i>Part No.</i>	<i>Qty.</i>
TEMPO			TORINO (cont.)		
Transaxle Pan Gasket 1986-1994, ATX Transaxle, Tuff-Cork	W38429TC	1	Transmission Pan Gasket (cont.) 1968, Cruise-O-Matic MX Transmission	W38986	1
Valve Body Cover Gasket 1986-1994, ATX Transaxle, Tuff-Cork	W38139TC	1	TRACER		
THUNDERBIRD			Transaxle Gasket 1991-1992, Automatic Transmission, Tuff-Cork		
Transaxle Pan Gasket 1994-1995, AXOD Transaxle, AXODE Transaxle, Cork Rubber	W39110	1	1989, Automatic Transmission, Tuff-Cork	W31131TC	1
1994-1995, AXOD Transaxle, AXODE Transaxle, Tuff-Cork	W39110TC	1	Transaxle Pan Gasket 1991-1994, ATX Transaxle		
Transmission Gasket Set 1965-1967, 3 Speed Transmission, 4 Bolt Top Cover			1987-1989, ATX Transaxle	W29097	1
1965-1967, 3 Speed Transmission, Except 4 Bolt Top Cover	TS26399	1		W29097	1
1965-1967, 3 Speed Transmission, Except 4 Bolt Top Cover	TS27817X	1	TURNPIKE CRUISER		
1958-1965, Overdrive Transmission	TS27545Y	1	Transmission Gasket Set 1957-1958, 3 Speed Transmission		
1958-1962, 3 Speed Transmission	TS27051W	1	Transmission Pan Gasket 1957-1958, Ford-O-Matic Transmission, Heavy Duty		
Transmission Pan Gasket 1990-1995, AODE Transmission, AODEW Transmission			1957-1958, Ford-O-Matic Transmission, Light Duty	W38986	1
1987-1988, A4LD Automatic Transmission, Tuff-Cork	W38144TC	1		W38987	1
1981-1986, C3 Automatic Transmission, Dual Range	W37978	1	VILLAGER		
1980-1993, AOD Transmission	W38430	1	Transmission Gasket Set 1967		
1977-1986, C4 Automatic Transmission, C5 Automatic Transmission, Dual Range	W39349	1	1966-1967, 4 Speed Transmission	TS27817X	1
1977-1986, C4 Automatic Transmission, C5 Automatic Transmission, Dual Range, Tuff-Cork	W39349TC	1		TS27831	1
1966-1980, C6 Automatic Transmission, Dual Range	W39346	1	Transmission Pan Gasket 1966-1967, Cruise-O-Matic FX, FMX Transmission		
1966-1980, C6 Automatic Transmission, Dual Range, Tuff-Cork	W39346TC	1	1966-1967, Cruise-O-Matic MX Transmission	W38987	1
1958-1959, Ford-O-Matic Transmission, Heavy Duty	W38986	1		W38986	1
1958-1959, Ford-O-Matic Transmission, Light Duty	W38987	1	VOYAGER		
TOPAZ			Transmission Gasket Set 1967, 4 Speed Transmission		
Transaxle Pan Gasket 1986-1994, ATX Transaxle, Tuff-Cork	W38429TC	1	1966, 3 Speed Transmission	TS27817X	1
Valve Body Cover Gasket 1986-1994, ATX Transaxle, Tuff-Cork	W38139TC	1	1966, 4 Speed Transmission	TS26399	1
TORINO				TS27831	1
Transmission Gasket Set 1968-1976, 3 Speed Transmission			Transmission Pan Gasket 1966-1967, Cruise-O-Matic FX, FMX Transmission		
1968-1973, 4 Speed Transmission	TS27817X	1	1966-1967, Cruise-O-Matic MX Transmission	W38987	1
	TS27831	1		W38986	1
Transmission Pan Gasket 1973-1974, Borg Warner Transmission			ZEPHYR		
1970-1976, C4 Automatic Transmission, Dual Range	W38987	1	Transmission Gasket Set 1980-1983, Ford RAD Transmission		
1970-1976, C4 Automatic Transmission, Dual Range, Tuff-Cork	W39349	1	1980-1983, Ford RUG Transmission	TS27831Z	1
1969-1976, C6 Automatic Transmission, Dual Range	W39349TC	1	1978-1979, 4 Speed Transmission	TS27831	1
1969-1976, C6 Automatic Transmission, Dual Range, Tuff-Cork	W39346	1	1978, 3 Speed Transmission	TS27831Z	1
1969-1976, C6 Automatic Transmission, Dual Range, Tuff-Cork	W39346TC	1		TS27817X	1
1969-1976, Cruise-O-Matic Transmission	W38987	1	Transmission Pan Gasket 1980-1982, C4 Automatic Transmission, C5 Automatic Transmission, Dual Range		
1968, Cruise-O-Matic FX, FMX Transmission	W38987	1	1980-1982, C4 Automatic Transmission, C5 Automatic Transmission, Dual Range, Tuff-Cork	W39349	1
			1978-1983, C3 Automatic Transmission, Dual Range	W39349TC	1
			1978-1983, C4 Automatic Transmission, Dual Range	W37978	1
			1978-1983, C4 Automatic Transmission, Dual Range	W39349	1
			1978-1983, C4 Automatic Transmission, Dual Range, Tuff-Cork	W39349TC	1
			1978-1979, Cruise-O-Matic Transmission	W38987	1

Axle Shaft Gaskets					
Model & Application			Model & Application		
	Part No.	Qty.		Part No.	Qty.
BEAUVILLE			ESTATE WAGON		
Wheel Brg. Ret. Gasket			Wheel Brg. Ret. Gasket		
1955-1957, Rear Wheel	J26424	2	1970, Rear Wheel	J27070	2
BEL AIR			FLEETWOOD		
Wheel Brg. Ret. Gasket			Wheel Brg. Ret. Gasket		
1955-1964, Rear Wheel	J26424	2	1976-1978, Rear Wheel	J26123	1
BISCAYNE			1965-1966, Except Commercial Chassis, Rear Wheel		
Wheel Brg. Ret. Gasket				J26123	1
1958-1964, Rear Wheel	J26424	2	FLEETWOOD 75		
BROOKWOOD			Wheel Brg. Ret. Gasket		
Wheel Brg. Ret. Gasket			1967-1978, Rear Wheel	J26123	1
1958-1961, Rear Wheel	J26424	2	1953-1966, Except Commercial Chassis, Rear Wheel		
CALAIS					
Wheel Brg. Ret. Gasket				J26123	1
1967-1976, Rear Wheel	J26123	1	FLEETWOOD SPECIAL		
1965-1966, Except Commercial Chassis, Rear Wheel			Wheel Brg. Ret. Gasket		
	J26123	1	1967-1975, Rear Wheel	J26123	1
CENTURY			1953-1966, Except Commercial Chassis, Rear Wheel		
Wheel Brg. Ret. Gasket				J26123	1
1956-1958, Rear Wheel	J27070	2	GTO		
1954-1955, Rear Wheel	J26253	2	Wheel Brg. Ret. Gasket		
CHEVY II			1967-1969, Rear Wheel		
Wheel Brg. Ret. Gasket				J31393	2
1962-1963, Rear Wheel	J26623	4	IMPALA		
COMMERCIAL CHASSIS			Wheel Brg. Ret. Gasket		
Wheel Brg. Ret. Gasket			1958-1964, Rear Wheel	J26424	2
1976-1978, Rear Wheel	J26123	1	INVICTA		
COUPE DEVILLE			Wheel Brg. Ret. Gasket		
Wheel Brg. Ret. Gasket			1959-1963, Rear Wheel	J27070	2
1978, Rear Wheel	J26123	1	LE SABRE		
DEVILLE			Wheel Brg. Ret. Gasket		
Wheel Brg. Ret. Gasket			1959-1964, Rear Wheel	J27070	2
1976-1977, Rear Wheel	J26123	1	LIMITED		
DEL RAY			Wheel Brg. Ret. Gasket		
Wheel Brg. Ret. Gasket			1958, Rear Wheel	J27070	2
1958, Rear Wheel	J26424	2	NOMAD		
DELUXE 210			Wheel Brg. Ret. Gasket		
Wheel Brg. Ret. Gasket			1955-1961, Rear Wheel	J26424	2
1955-1957, Rear Wheel	J26424	2	RIVIERA		
ELDORADO			Wheel Brg. Ret. Gasket		
Wheel Brg. Ret. Gasket			1963-1964, Rear Wheel	J27070	2
1968-1975, Rear Wheel	J26123	1	ROADMASTER		
ELDORADO SPECIAL			Wheel Brg. Ret. Gasket		
Wheel Brg. Ret. Gasket			1956-1958, Rear Wheel	J27070	2
1953-1964, Except Commercial Chassis, Rear Wheel	J26123	1	1953-1955, Rear Wheel	J26253	2
ELECTRA 225			SEDAN DEVILLE		
Wheel Brg. Ret. Gasket			Wheel Brg. Ret. Gasket		
1959-1964, Rear Wheel	J27070	2	1978, Rear Wheel	J26123	1
			SERIES 62		
			Wheel Brg. Ret. Gasket		
			1953-1958, Except Commercial Chassis, Rear Wheel		
				J26123	1

General Motors Corp. (cont.)

Axle Shaft Gaskets (cont.)

<i>Model & Application</i>	<i>Part No.</i>	<i>Qty.</i>	<i>Model & Application</i>	<i>Part No.</i>	<i>Qty.</i>
SERIES 6200			TEMPEST		
Wheel Brg. Ret. Gasket			Wheel Brg. Ret. Gasket		
1967-1975, Rear Wheel	J26123	1	1964-1969, Rear Wheel	J31393	2
1953-1966, Except Commercial Chassis, Rear Wheel	J26123	1	TEMPEST LEMANS		
SKYLARK			Wheel Brg. Ret. Gasket		
Wheel Brg. Ret. Gasket			1964-1966, Rear Wheel	J31393	2
1964-1969, Rear Wheel	J31393	2	TOWNSMAN		
1954, Rear Wheel	J26253	2	Wheel Brg. Ret. Gasket		
SPECIAL			1955-1957, Rear Wheel		
Wheel Brg. Ret. Gasket			J26424	2	
1956-1958, Rear Wheel	J27070	2	WILD CAT		
SPECIAL 150			Wheel Brg. Ret. Gasket		
Wheel Brg. Ret. Gasket			1964, Rear Wheel	J27070	2
1955-1957, Rear Wheel	J26424	2	YEOMAN		
SUPER			Wheel Brg. Ret. Gasket		
Wheel Brg. Ret. Gasket			1958, Rear Wheel	J26424	2
1956-1958, Rear Wheel	J27070	2			
1953-1955, Rear Wheel	J26253	2			

Differential Housing Cover Gaskets

<i>Model & Application</i>	<i>Part No.</i>	<i>Qty.</i>	<i>Model & Application</i>	<i>Part No.</i>	<i>Qty.</i>
APOLLO			BEL AIR (cont.)		
Diff. Hsg. Cover Gasket			Diff. Hsg. Cover Gasket (cont.)		
1973-1975, 10 Bolt Holes	P27857	1	1965-1970, 12 Bolt Holes, Tuff-Cork, 10-5/8" X 10-7/8"	P27944TC	1
1973-1975, 10 Bolt Holes, Tuff-Cork	P27857TC	1	BISCAYNE		
ASTRE			Diff. Carrier Gasket		
Diff. Hsg. Cover Gasket			1958-1964	P27782T	1
1975-1977, 10 Bolt Holes, 9-5/8" X 10-1/4"	P27870	1	Diff. Hsg. Cover Gasket		
1975-1977, 10 Bolt Holes, 8-5/8" X 10-1/4"	P28784	1	1971-1972, B Or O Type, 10 Bolt Holes, 10" X 10-7/16"	P27820	1
BEAUVILLE			1971-1972, C, G, K Type, 10 Bolt Holes, 10-3/16" X 10-7/8"	P27857	1
Diff. Carrier Gasket			1971-1972, C, G, K Type, 10 Bolt Holes, Tuff-Cork, 10-3/16" X 10-7/8"	P27857TC	1
1955-1957	P27782T	1	1971-1972, M Or P Type, 10 Bolt Holes, 10-3/4" X 10-5/8"	P27943	1
BEL AIR			1965-1970, 10 Bolt Holes, 10-3/16" X 10-3/4"	P27939	1
Axle Hsg Cover Gasket			1965-1970, 12 Bolt Holes, 10-5/8" X 10-7/8"	P27944	1
1953-1954	P37659	1	1965-1970, 12 Bolt Holes, Tuff-Cork, 10-5/8" X 10-7/8"	P27944TC	1
Diff. Carrier Gasket			BONNEVILLE		
1955-1964	P27782T	1	Diff. Carrier Gasket		
1953-1954	P27659	1	1961-1964	P29325	1
Diff. Hsg. Cover Gasket			Diff. Hsg. Cover Gasket		
1973-1975, 7-1/2" Ring Gear	P27872	1	1984-1986, 7-1/2" Ring Gear	P27872	1
1973-1975, B, C, G, K, O Type, 10 Bolt Holes, 10-3/16" X 10-7/8"	P27857	1	1984-1986, 8-1/2" Ring Gear, 10 Bolt Holes	P27857	1
1973-1975, B, C, G, K, O Type, 10 Bolt Holes, Tuff-Cork, 10-3/16" X 10-7/8"	P27857TC	1	1984-1986, 8-1/2" Ring Gear, 10 Bolt Holes, Tuff-Cork	P27857TC	1
1971-1975, M Or P Type, 10 Bolt Holes, 10-3/4" X 10-5/8"	P27943	1	1982-1983	P27872	1
1971-1972, B Or O Type, 10 Bolt Holes, 10" X 10-7/16"	P27820	1	1973-1981, 7-1/2" Ring Gear, K Or P Type, 10 Bolt Holes	P27872	1
1971-1972, C, G, K Type, 10 Bolt Holes, 10-3/16" X 10-7/8"	P27857	1	1973-1981, B, G, K, O Type, 10 Bolt Holes, 10-3/16" X 10-7/8"	P27857	1
1971-1972, C, G, K Type, 10 Bolt Holes, Tuff-Cork, 10-3/16" X 10-7/8"	P27857TC	1	1973-1981, B, G, K, O Type, 10 Bolt Holes, Tuff-Cork, 10-3/16" X 10-7/8"	P27857TC	1
1965-1970, 10 Bolt Holes, 10-3/16" X 10-3/4"	P27939	1			
1965-1970, 12 Bolt Holes, 10-5/8" X 10-7/8"	P27944	1			

Differential Housing Cover Gaskets (cont.)

Model & Application	Part No.	Qty.	Model & Application	Part No.	Qty.
BONNEVILLE (cont.)			CATALINA		
Diff. Hsg. Cover Gasket (cont.)			Diff. Carrier Gasket		
1973-1981, M Or P Type, 10 Bolt Holes, 10-3/4" X 10-5/8"	P27943	1	1961-1964	P29325	1
1965-1972, 10 Bolt Holes, 10-3/4" X 10-5/8"	P27943	1	Diff. Hsg. Cover Gasket		
BONNEVILLE CUSTOM			1973-1981, 7-1/2" Ring Gear, K Or P Type, 10 Bolt Holes		
Diff. Carrier Gasket			1973-1981, B, G, K, O Type, 10 Bolt Holes, 10-3/16" X 10-7/8"		
1961-1962	P29325	1	1973-1981, B, G, K, O Type, 10 Bolt Holes, Tuff-Cork, 10-3/16" X 10-7/8"		
BROOKWOOD			1973-1981, M Or P Type, 10 Bolt Holes, 10-3/4" X 10-5/8"		
Diff. Carrier Gasket			1970-1972, 10 Bolt Holes, 10-3/16" X 10-7/8"		
1958-1961	P27782T	1	1970-1972, 10 Bolt Holes, Tuff-Cork, 10-3/16" X 10-7/8"		
BROUGHAM			1965-1972, 10 Bolt Holes, 10-3/4" X 10-5/8"		
Diff. Hsg. Cover Gasket			1973-1981, 8-7/8" Ring Gear, 10 Bolt Holes		
1994-1996, 8-1/2" Ring Gear, 10 Bolt Holes, Tuff-Cork.	P27857TC	1	1971-1973, 12 Bolt Holes, 11-1/2" X 11-3/4"		
1992-1996, 8-1/2" Ring Gear, 10 Bolt Holes	P27857	1	1971-1973, 10 Bolt Holes, Tuff-Cork, 10-3/16" X 10-7/8"		
CALAIS			1971-1972, 10 Bolt Holes, 10-3/16" X 10-7/8"		
Diff. Carrier Gasket			1971-1972, 10 Bolt Holes, 10-3/16" X 10-7/8"		
1965-1967	P27933	1	CENTURION		
Diff. Hsg. Cover Gasket			Diff. Hsg. Cover Gasket		
1968-1976	P28909	1	1973, 8-7/8" Ring Gear, 10 Bolt Holes		
CAMARO			1971-1973, 12 Bolt Holes, 11-1/2" X 11-3/4"		
Diff. Hsg. Cover Gasket			1971-1973, 10 Bolt Holes, Tuff-Cork, 10-3/16" X 10-7/8"		
1998-2002	P27872	1	1971-1972, 10 Bolt Holes, 10-3/16" X 10-7/8"		
1987-1991, 7-3/4" Ring Gear	P31395	1	CENTURY		
1982-1997, 7-5/8" Ring Gear	P27872	1	Diff. Hsg. Cover Gasket		
1971-1981, 10 Bolt Holes	P27857	1	1975-1982, 10 Bolt Holes, 10-3/16" X 10-7/8"		
1971-1981, 10 Bolt Holes, Tuff-Cork	P27857TC	1	1975-1982, 10 Bolt Holes, Tuff-Cork, 10-3/16" X 10-7/8"		
1967-1970, 10 Bolt Holes, 10-3/16" X 10-3/4"	P27939	1	1975-1982, 10 Bolt Holes, 10-3/4" X 10-5/8"		
1967-1970, 12 Bolt Holes, 10-5/8" X 10-7/8"	P27944	1	1975-1982, 7-1/2" Ring Gear, K Or P Type		
1967-1970, 12 Bolt Holes, Tuff-Cork, 10-5/8" X 10-7/8"	P27944TC	1	CHEVELLE		
CAPRICE			Diff. Hsg. Cover Gasket		
Diff. Hsg. Cover Gasket			1976-1977		
1984-1996, 7-1/2" Ring Gear, 7-5/8" Ring Gear	P27872	1	1973-1975, Except Station Wagon, 10 Bolt Holes.		
1984-1996, 8-1/2" Ring Gear, 10 Bolt Holes	P27857	1	1973-1975, Except Station Wagon, 10 Bolt Holes, Tuff-Cork.		
1984-1996, 8-1/2" Ring Gear, 10 Bolt Holes, Tuff-Cork.	P27857TC	1	1973-1975, Station Wagon, 10 Bolt Holes		
1973-1983, B, C, G, K, O Type, 10 Bolt Holes, 10-3/16" X 10-7/8"	P27857	1	1965-1972, 10 Bolt Holes, 10-5/16" X 10-3/4"		
1973-1983, B, C, G, K, O Type, 10 Bolt Holes, Tuff-Cork, 10-3/16" X 10-7/8"	P27857TC	1	1964-1972, 12 Bolt Holes, 10-5/8" X 10-7/8"		
1971-1983, M Or P Type, 10 Bolt Holes, 10-3/4" X 10-5/8"	P27943	1	1964-1972, 12 Bolt Holes, Tuff-Cork, 10-5/8" X 10-7/8"		
1971-1972, B Or O Type, 10 Bolt Holes, 10" X 10-7/16"	P27820	1	CHEVETTE		
1971-1972, C, G, K Type, 10 Bolt Holes, 10-3/16" X 10-7/8"	P27857	1	Diff. Hsg. Cover Gasket		
1971-1972, C, G, K Type, 10 Bolt Holes, Tuff-Cork, 10-3/16" X 10-7/8"	P27857TC	1	1976-1987		
1966-1970, 10 Bolt Holes, 10-3/16" X 10-3/4"	P27939	1	CHEVY II		
1966-1970, 12 Bolt Holes, 10-5/8" X 10-7/8"	P27944	1	Diff. Carrier Gasket		
1966-1970, 12 Bolt Holes, Tuff-Cork, 10-5/8" X 10-7/8"	P27944TC	1	1962-1963		
			Diff. Hsg. Cover Gasket		
			1965-1968, 12 Bolt Holes, 10-5/8" X 10-7/8"		
			1965-1968, 12 Bolt Holes, Tuff-Cork, 10-5/8" X 10-7/8"		
			1964-1968, 10 Bolt Holes, 10-3/16" X 10-3/4"		

PASSENGER CAR

General Motors Corp. (cont.)

Differential Housing Cover Gaskets (cont.)

<i>Model & Application</i>	<i>Part No.</i>	<i>Qty.</i>	<i>Model & Application</i>	<i>Part No.</i>	<i>Qty.</i>
CHIEFTAIN			CUTLASS 'S' (cont.)		
Diff. Carrier Gasket			Diff. Hsg. Cover Gasket (cont.)		
1958	P29325	1	1970	P18563	1
COMMERCIAL CHASSIS			1969-1970, O Type, 12 Bolt Holes, 10-5/8"		
Diff. Hsg. Cover Gasket			X 11-1/8"	P18563	1
1983-1984, 7-1/2" Ring Gear	P27872	1	1968-1969, C Type, 12 Bolt Holes, 10-5/8"		
1983-1984, 8-7/8" Ring Gear, 10 Bolt Holes	P27943	1	X 10-7/8"	P27944	1
1977-1982, 10 Bolt Holes	P27943	1	1968-1969, C Type, 12 Bolt Holes,		
1976	P28909	1	Tuff-Cork, 10-5/8" X 10-7/8"	P27944TC	1
CORVAIR			1968, O Type, 12 Bolt Holes, 10-3/4" X 11"	P27850	1
Diff. Carrier Gasket			CUTLASS SALON		
1960-1969	P37572	1	Diff. Hsg. Cover Gasket		
CORVETTE			1979-1980	P27872	1
Diff. Hsg. Cover Gasket			1975-1978, 10 Bolt Holes	P27857	1
1990-1996	P31370	1	1975-1978, 10 Bolt Holes, Tuff-Cork	P27857TC	1
1984-1989	P31371	1	CUTLASS SUPREME		
1979-1982	P27643	1	Diff. Hsg. Cover Gasket		
1963-1978	P27938	1	1982-1988, Except Station Wagon	P27872	1
COUPE DEVILLE			1971-1978, 10 Bolt Holes	P27857	1
Diff. Hsg. Cover Gasket			1971-1978, 10 Bolt Holes, Tuff-Cork	P27857TC	1
1978-1979, 10 Bolt Holes	P27943	1	1970	P18563	1
CUSTOM CRUISER			1969-1970, O Type, 12 Bolt Holes, 10-5/8"		
Diff. Hsg. Cover Gasket			X 11-1/8"	P18563	1
1984-1991, 8-1/2" Ring Gear, 10 Bolt Holes	P27857	1	1968-1969, C Type, 12 Bolt Holes, 10-5/8"		
1984-1991, 8-1/2" Ring Gear, 10 Bolt			X 10-7/8"	P27944	1
Holes, Tuff-Cork	P27857TC	1	1968-1969, C Type, 12 Bolt Holes,		
1984-1987, 7-1/2" Ring Gear, 7-5/8" Ring			Tuff-Cork, 10-5/8" X 10-7/8"	P27944TC	1
Gear	P27872	1	1967, B Or P Type, 10 Bolt Holes, 10" X		
1980-1983, Except 7-1/2" Ring Gear, 10			10-7/16"	P27820	1
Bolt Holes, 10-3/4" X 10-5/8"	P27943	1	1967, O Type, 12 Bolt Holes, 10-3/4" X 11"	P27850	1
1973-1981, 10 Bolt Holes, 10-3/4" X			DEVILLE		
10-5/8"	P27943	1	Diff. Hsg. Cover Gasket		
1971-1981, 10 Bolt Holes, 10-3/16" X			1983-1984, 7-1/2" Ring Gear	P27872	1
10-7/8"	P27857	1	1983-1984, 8-7/8" Ring Gear, 10 Bolt Holes	P27943	1
1971-1981, 10 Bolt Holes, Tuff-Cork,			1980-1982, 10 Bolt Holes	P27943	1
10-3/16" X 10-7/8"	P27857TC	1	1977, 10 Bolt Holes	P27943	1
1971-1973, 12 Bolt Holes, 11-1/2" X 11-3/4"	P27853	1	1976	P28909	1
1971-1972, 12 Bolt Holes, 10-5/8" X 11-1/8"	P18563	1	DEL RAY		
1971-1972, 12 Bolt Holes, 10-3/4" X 11"	P27850	1	Diff. Carrier Gasket		
CUTLASS			1958	P27782T	1
Diff. Hsg. Cover Gasket			DELMONT EIGHTY-EIGHT		
1982-1984, Except Station Wagon	P27872	1	Diff. Hsg. Cover Gasket		
1982-1983, Station Wagon, 10 Bolt Holes	P27857	1	1968, 12 Bolt Holes, 10-5/8" X 11-1/8"	P18563	1
1982-1983, Station Wagon, 10 Bolt Holes,			1968, 12 Bolt Holes, 10-3/4" X 11"	P27850	1
Tuff-Cork	P27857TC	1	1968, 12 Bolt Holes, 11-1/2" X 11-3/4"	P27853	1
1979-1981	P27872	1	1968, 10 Bolt Holes, 10-3/16" X 10-7/8"	P27857	1
1971-1978, 10 Bolt Holes	P27857	1	1968, 10 Bolt Holes, Tuff-Cork, 10-3/16" X		
1971-1978, 10 Bolt Holes, Tuff-Cork	P27857TC	1	10-7/8"	P27857TC	1
1970	P18563	1	DELMONT EIGHTY-EIGHT '330'		
1969-1970, O Type, 12 Bolt Holes, 10-5/8"			Diff. Hsg. Cover Gasket		
X 11-1/8"	P18563	1	1967, O Type, 10 Bolt Holes, 10" X		
1968-1969, C Type, 12 Bolt Holes, 10-5/8"			10-7/16"	P27820	1
X 10-7/8"	P27944	1	1967, P Type Axle, 10 Bolt Holes, 10-3/4" X		
1968-1969, C Type, 12 Bolt Holes,			10-5/8"	P27943	1
Tuff-Cork, 10-5/8" X 10-7/8"	P27944TC	1	DELMONT EIGHTY-EIGHT '425'		
1967, B Or P Type, 10 Bolt Holes, 10" X			Diff. Hsg. Cover Gasket		
10-7/16"	P27820	1	1967, O Type, 10 Bolt Holes, 10" X		
1967, O Type, 12 Bolt Holes, 10-3/4" X 11"	P27850	1	10-7/16"	P27820	1
CUTLASS 'S'			1967, P Type Axle, 10 Bolt Holes, 10-3/4" X		
Diff. Hsg. Cover Gasket			10-5/8"	P27943	1
1971-1977, 10 Bolt Holes	P27857	1			
1971-1977, 10 Bolt Holes, Tuff-Cork	P27857TC	1			

Differential Housing Cover Gaskets (cont.)

<i>Model & Application</i>	<i>Part No.</i>	<i>Qty.</i>	<i>Model & Application</i>	<i>Part No.</i>	<i>Qty.</i>
DELTA 88			ELECTRA (cont.)		
Diff. Hsg. Cover Gasket			Diff. Hsg. Cover Gasket (cont.)		
1974-1981, 7-1/2" Ring Gear, K Or P Type . . .	P27872	1	1976-1981, 12 Bolt Holes, 11-1/2" X 11-3/4" . . .	P27853	1
1968-1981, 10 Bolt Holes, 10-3/16" X 10-7/8" . . .	P27857	1	1976-1981, 10 Bolt Holes, 10-3/16" X 10-7/8" . . .	P27857	1
1968-1981, 10 Bolt Holes, Tuff-Cork, 10-3/16" X 10-7/8" . . .	P27857TC	1	1976-1981, 10 Bolt Holes, Tuff-Cork, 10-3/16" X 10-7/8" . . .	P27857TC	1
1968-1972, 12 Bolt Holes, 10-5/8" X 11-1/8" . . .	P18563	1	1976-1981, 7-1/2" Ring Gear, K Or P Type . . .	P27872	1
1968-1972, 12 Bolt Holes, 10-3/4" X 11" . . .	P27850	1	1976-1981, 8-7/8" Ring Gear, 10 Bolt Holes . . .	P27943	1
1967, O Type, 12 Bolt Holes, 11-1/2" X 11-3/4" . . .	P27853	1	ELECTRA 225		
1967, P Type Axle, 10 Bolt Holes, 10-3/4" X 10-5/8" . . .	P27943	1	Diff. Hsg. Cover Gasket		
1965-1966, 10 Bolt Holes . . .	P27943	1	1973-1976, 7-1/2" Ring Gear, K Or P Type . . .	P27872	1
DELTA 88 ROYALE			1973-1976, 8-7/8" Ring Gear, 10 Bolt Holes . . .	P27943	1
Diff. Hsg. Cover Gasket			1971-1976, 12 Bolt Holes, 11-1/2" X 11-3/4" . . .	P27853	1
1984-1985, 7-1/2" Ring Gear, 7-5/8" Ring Gear . . .	P27872	1	1971-1976, 10 Bolt Holes, 10-3/16" X 10-7/8" . . .	P27857	1
1984-1985, 8-1/2" Ring Gear, 10 Bolt Holes . . .	P27857	1	1971-1976, 10 Bolt Holes, Tuff-Cork, 10-3/16" X 10-7/8" . . .	P27857TC	1
1984-1985, 8-1/2" Ring Gear, 10 Bolt Holes, Tuff-Cork . . .	P27857TC	1	1964-1970, 10 Bolt Holes, 11" X 11-1/4" . . .	P18560	1
1982, Except 7-1/2" Ring Gear, 10 Bolt Holes . . .	P27943	1	1964-1970, 10 Bolt Holes, 10" X 10-7/16" . . .	P27820	1
1981, 10 Bolt Holes, 10-3/4" X 10-5/8" . . .	P27943	1	1964-1970, 12 Bolt Holes, 10-5/8" X 10-7/8" . . .	P27944	1
1980-1983, Except 7-1/2" Ring Gear, 10 Bolt Holes, 10-3/4" X 10-5/8" . . .	P27943	1	1964-1970, 12 Bolt Holes, Tuff-Cork, 10-5/8" X 10-7/8" . . .	P27944TC	1
1973-1981, 10 Bolt Holes, 10-3/4" X 10-5/8" . . .	P27943	1	ELECTRA ESTATE WAGON		
1969-1981, 10 Bolt Holes, 10-3/16" X 10-7/8" . . .	P27857	1	Diff. Hsg. Cover Gasket		
1969-1981, 10 Bolt Holes, Tuff-Cork, 10-3/16" X 10-7/8" . . .	P27857TC	1	1986, 7-1/2" Ring Gear . . .	P27872	1
1969-1973, 12 Bolt Holes, 11-1/2" X 11-3/4" . . .	P27853	1	1986, 8-1/2" Ring Gear, 10 Bolt Holes . . .	P27857	1
1969-1972, 12 Bolt Holes, 10-5/8" X 11-1/8" . . .	P18563	1	1986, 8-1/2" Ring Gear, 10 Bolt Holes, Tuff-Cork . . .	P27857TC	1
1969-1972, 12 Bolt Holes, 10-3/4" X 11" . . .	P27850	1	1980-1981, 12 Bolt Holes, 11-1/2" X 11-3/4" . . .	P27853	1
DELUXE			1980-1981, 10 Bolt Holes, 10-3/16" X 10-7/8" . . .	P27857	1
Axle Hsg Cover Gasket			1980-1981, 10 Bolt Holes, Tuff-Cork, 10-3/16" X 10-7/8" . . .	P27857TC	1
1949-1952 . . .	P37659	1	1980-1981, 7-1/2" Ring Gear, K Or P Type . . .	P27872	1
Diff. Carrier Gasket			1980-1981, 8-7/8" Ring Gear, 10 Bolt Holes . . .	P27943	1
1949-1952 . . .	P27659	1	ESTATE WAGON		
DELUXE 210			Diff. Hsg. Cover Gasket		
Axle Hsg Cover Gasket			1976-1980, 12 Bolt Holes, 11-1/2" X 11-3/4" . . .	P27853	1
1953-1954 . . .	P37659	1	1976-1980, 10 Bolt Holes, 10-3/16" X 10-7/8" . . .	P27857	1
Diff. Carrier Gasket			1976-1980, 10 Bolt Holes, Tuff-Cork, 10-3/16" X 10-7/8" . . .	P27857TC	1
1955-1957 . . .	P27782T	1	1976-1980, 7-1/2" Ring Gear, K Or P Type . . .	P27872	1
1953-1954 . . .	P27659	1	1976-1980, 8-7/8" Ring Gear, 10 Bolt Holes . . .	P27943	1
DYNAMIC 88			1971-1972, 12 Bolt Holes, 11-1/2" X 11-3/4" . . .	P27853	1
Diff. Hsg. Cover Gasket			1971-1972, 10 Bolt Holes, 10-3/16" X 10-7/8" . . .	P27857	1
1965-1966, 10 Bolt Holes . . .	P27943	1	1971-1972, 10 Bolt Holes, Tuff-Cork, 10-3/16" X 10-7/8" . . .	P27857TC	1
ELDORADO			1970, 10 Bolt Holes, 11" X 11-1/4" . . .	P18560	1
Diff. Hsg. Cover Gasket			1970, 10 Bolt Holes, 10" X 10-7/16" . . .	P27820	1
1979-1985 . . .	P27637	1	1970, 12 Bolt Holes, 10-5/8" X 10-7/8" . . .	P27944	1
1968-1978 . . .	P28883	1	1970, 12 Bolt Holes, Tuff-Cork, 10-5/8" X 10-7/8" . . .	P27944TC	1
ELDORADO SPECIAL			EXECUTIVE		
Diff. Carrier Gasket			Diff. Hsg. Cover Gasket		
1957-1964 . . .	P27933	1	1970, 10 Bolt Holes, 10-3/16" X 10-7/8" . . .	P27857	1
ELECTRA			1970, 10 Bolt Holes, Tuff-Cork, 10-3/16" X 10-7/8" . . .	P27857TC	1
Diff. Hsg. Cover Gasket			1967-1970, 10 Bolt Holes, 10-3/4" X 10-5/8" . . .	P27943	1
1982-1984, 7-1/2" Ring Gear . . .	P27872	1			
1982-1984, Except 7-1/2" Ring Gear, 10 Bolt Holes . . .	P27943	1			

PASSENGER CAR

General Motors Corp. (cont.)

Differential Housing Cover Gaskets (cont.)

<i>Model & Application</i>	<i>Part No.</i>	<i>Qty.</i>	<i>Model & Application</i>	<i>Part No.</i>	<i>Qty.</i>
F-85			FLEETWOOD 75		
Diff. Hsg. Cover Gasket			Diff. Carrier Gasket		
1971-1972, 10 Bolt Holes	P27857	1	1957-1967	P27933	1
1971-1972, 10 Bolt Holes, Tuff-Cork	P27857TC	1	Diff. Hsg. Cover Gasket		
1970	P18563	1	1983, 7-1/2" Ring Gear	P27872	1
1969-1970, O Type, 12 Bolt Holes, 10-5/8" X 11-1/8"	P18563	1	1983, 8-7/8" Ring Gear, 10 Bolt Holes	P27943	1
1968-1969, C Type, 12 Bolt Holes, 10-5/8" X 10-7/8"	P27944	1	1977-1982, 10 Bolt Holes	P27943	1
1968-1969, C Type, 12 Bolt Holes, Tuff-Cork, 10-5/8" X 10-7/8"	P27944TC	1	1968-1976	P28909	1
1966-1967, B Or P Type, 10 Bolt Holes, 10" X 10-7/16"	P27820	1	FLEETWOOD SPECIAL		
1966-1967, O Type, 12 Bolt Holes, 10-3/4" X 11"	P27850	1	Diff. Carrier Gasket		
1964-1965	P27820	1	1957-1967	P27933	1
FIREBIRD			Diff. Hsg. Cover Gasket		
Diff. Hsg. Cover Gasket			1968-1975	P28909	1
1998-2002	P27872	1	GTO		
1985-1991, 7-3/4" Ring Gear	P31395	1	Diff. Hsg. Cover Gasket		
1982-1997, 7-5/8" Ring Gear	P27872	1	1970, Except Ram Air, 10 Bolt Holes, 10" X 10-7/16"	P27820	1
1971-1981, 10 Bolt Holes	P27857	1	1970, Except Ram Air, 12 Bolt Holes, 10-5/8" X 10-7/8"	P27944	1
1971-1981, 10 Bolt Holes, Tuff-Cork	P27857TC	1	1970, Except Ram Air, 12 Bolt Holes, Tuff-Cork, 10-5/8" X 10-7/8"	P27944TC	1
1970, Except Ram Air, 10 Bolt Holes, 10-3/16" X 10-3/4"	P27939	1	1970, Ram Air, 10 Bolt Holes	P27943	1
1970, Except Ram Air, 12 Bolt Holes, 10-5/8" X 10-7/8"	P27944	1	1967-1969	P27820	1
1970, Except Ram Air, 12 Bolt Holes, Tuff-Cork	P27944TC	1	GRAND AM		
1970, Ram Air, 10 Bolt Holes	P27943	1	Diff. Hsg. Cover Gasket		
1967-1969	P27820	1	1980	P27872	1
FLEETLINE			1978-1979, 10 Bolt Holes, 10-3/16" X 10-7/8"	P27857	1
Axle Hsg Cover Gasket			1978-1979, 10 Bolt Holes, Tuff-Cork, 10-3/16" X 10-7/8"	P27857TC	1
1946-1947	P37659	1	1978-1979, 10 Bolt Holes, 10-3/4" X 10-5/8"	P27943	1
1941-1942	P37659	1	1978-1979, 7-1/2" Ring Gear	P27872	1
Diff. Carrier Gasket			1973-1975, 10 Bolt Holes, 10-3/16" X 10-7/8"	P27857	1
1946-1947	P27659	1	1973-1975, 10 Bolt Holes, Tuff-Cork, 10-3/16" X 10-7/8"	P27857TC	1
1941-1942	P27659	1	1973-1975, 10 Bolt Holes, 10-3/4" X 10-5/8"	P27943	1
FLEETMASTER			1973-1975, 7-1/2" Ring Gear	P27872	1
Axle Hsg Cover Gasket			GRAND PRIX		
1946-1947	P37659	1	Diff. Carrier Gasket		
1942	P37659	1	1962-1964	P29325	1
Diff. Carrier Gasket			Diff. Hsg. Cover Gasket		
1946-1947	P27659	1	1976-1977, B, G, K, O Type, 10 Bolt Holes, 10-3/16" X 10-7/8"	P27857	1
1942	P27659	1	1976-1977, B, G, K, O Type, 10 Bolt Holes, Tuff-Cork, 10-3/16" X 10-7/8"	P27857TC	1
FLEETWOOD			1976-1977, M Or P Type, 10 Bolt Holes, 10-3/4" X 10-5/8"	P27943	1
Diff. Carrier Gasket			1973-1987, 7-1/2" Ring Gear, K Or P Type	P27872	1
1965-1966	P27933	1	1970-1972, 12 Bolt Holes, 10-5/8" X 10-7/8"	P27944	1
Diff. Hsg. Cover Gasket			1970-1972, 12 Bolt Holes, Tuff-Cork, 10-5/8" X 10-7/8"	P27944TC	1
1994-1996, 8-1/2" Ring Gear, 10 Bolt Holes, Tuff-Cork	P27857TC	1	1965-1972, 10 Bolt Holes, 10" X 10-7/16"	P27820	1
1986-1996, 8-1/2" Ring Gear, 10 Bolt Holes	P27857	1	GRANDVILLE		
1986-1990, 7-1/2" Ring Gear, 7-5/8" Ring Gear	P27872	1	Diff. Hsg. Cover Gasket		
1986-1990, 8-1/2" Ring Gear, 10 Bolt Holes, Tuff-Cork	P27857TC	1	1973-1975, 7-1/2" Ring Gear, K Or P Type, 10 Bolt Holes	P27872	1
1985	P27872	1	1973-1975, B, G, K, O Type, 10 Bolt Holes, 10-3/16" X 10-7/8"	P27857	1
1983-1984, 7-1/2" Ring Gear	P27872	1	FLEETWOOD 75		
1983-1984, 8-7/8" Ring Gear, 10 Bolt Holes	P27943	1	Diff. Carrier Gasket		
1977-1982, 10 Bolt Holes	P27943	1	1957-1967	P27933	1
1976	P28909	1	Diff. Hsg. Cover Gasket		

Differential Housing Cover Gaskets (cont.)

Model & Application	Part No.	Qty.	Model & Application	Part No.	Qty.
GRANDVILLE (cont.)			LE SABRE (cont.)		
Diff. Hsg. Cover Gasket (cont.)			Diff. Hsg. Cover Gasket (cont.)		
1973-1975, B, G, K, O Type, 10 Bolt Holes, Tuff-Cork, 10-3/16" X 10-7/8"	P27857TC	1	1980-1981, 10 Bolt Holes, 10-3/16" X 10-7/8"	P27857	1
1973-1975, M Or P Type, 10 Bolt Holes, 10-3/4" X 10-5/8"	P27943	1	1980-1981, 7-1/2" Ring Gear, K Or P Type	P27872	1
1971-1972, 10 Bolt Holes, 10-3/16" X 10-7/8"	P27857	1	1973-1981, 8-7/8" Ring Gear, 10 Bolt Holes	P27943	1
1971-1972, 10 Bolt Holes, Tuff-Cork, 10-3/16" X 10-7/8"	P27857TC	1	1971-1981, 12 Bolt Holes, 11-1/2" X 11-3/4"	P27853	1
1971-1972, 10 Bolt Holes, 10-3/4" X 10-5/8"	P27943	1	1971-1981, 10 Bolt Holes, Tuff-Cork, 10-3/16" X 10-7/8"	P27857TC	1
IMPALA			1964-1970, 10 Bolt Holes, 11" X 11-1/4"		
Diff. Carrier Gasket			1964-1970, 10 Bolt Holes, 10" X 10-7/16"		
1958-1964	P27782T	1	1964-1970, 12 Bolt Holes, 10-5/8" X 10-7/8"		
Diff. Hsg. Cover Gasket			1964-1970, 12 Bolt Holes, Tuff-Cork, 10-5/8" X 10-7/8"		
1994-1996, 7-1/2" Ring Gear, 7-5/8" Ring Gear	P27872	1	LEMANS		
1994-1996, 8-1/2" Ring Gear, 10 Bolt Holes	P27857	1	Diff. Hsg. Cover Gasket		
1994-1996, 8-1/2" Ring Gear, 10 Bolt Holes, Tuff-Cork.	P27857TC	1	1980-1981		
1984-1985, 8-1/2" Ring Gear, 10 Bolt Holes	P27857	1	1973-1981, 7-1/2" Ring Gear		
1984-1985, 8-1/2" Ring Gear, 10 Bolt Holes, Tuff-Cork.	P27857TC	1	1973-1979, 10 Bolt Holes, 10-3/16" X 10-7/8"		
1983-1984, 8-1/2" Ring Gear, B, C, G, K, O Type, 10 Bolt Holes, 10-3/16" X 10-7/8"	P27857	1	1973-1979, 10 Bolt Holes, Tuff-Cork, 10-3/16" X 10-7/8"		
1983-1984, 8-1/2" Ring Gear, B, C, G, K, O Type, 10 Bolt Holes, Tuff-Cork, 10-3/16" X 10-7/8"	P27857TC	1	1973-1979, 10 Bolt Holes, 10-3/4" X 10-5/8"		
1978-1985, 7-1/2" Ring Gear, 7-5/8" Ring Gear	P27872	1	1972, 10 Bolt Holes, 10" X 10-7/16"		
1973-1983, 7-1/2" Ring Gear	P27872	1	1972, 12 Bolt Holes, 10-5/8" X 10-7/8"		
1973-1983, B, C, G, K, O Type, 10 Bolt Holes, 10-3/16" X 10-7/8"	P27857	1	1972, 12 Bolt Holes, Tuff-Cork, 10-5/8" X 10-7/8"		
1973-1983, B, C, G, K, O Type, 10 Bolt Holes, Tuff-Cork, 10-3/16" X 10-7/8"	P27857TC	1	1970-1976, Ram Air, 10 Bolt Holes, 10-3/4" X 10-5/8"		
1971-1983, M Or P Type, 10 Bolt Holes, 10-3/4" X 10-5/8"	P27943	1	1970-1972, Except Ram Air, 10 Bolt Holes, 10" X 10-7/16"		
1971-1972, B Or O Type, 10 Bolt Holes, 10" X 10-7/16"	P27820	1	1970-1972, Except Ram Air, 12 Bolt Holes, 10-5/8" X 10-7/8"		
1971-1972, C, G, K Type, 10 Bolt Holes, 10-3/16" X 10-7/8"	P27857	1	1970-1972, Except Ram Air, 12 Bolt Holes, Tuff-Cork, 10-5/8" X 10-7/8"		
1971-1972, C, G, K Type, 10 Bolt Holes, Tuff-Cork, 10-3/16" X 10-7/8"	P27857TC	1	MALIBU		
1965-1970, 10 Bolt Holes, 10-3/16" X 10-3/4"	P27939	1	Diff. Hsg. Cover Gasket		
1965-1970, 12 Bolt Holes, 10-5/8" X 10-7/8"	P27944	1	1982-1983, 7-1/2" Ring Gear, 7-5/8" Ring Gear		
1965-1970, 12 Bolt Holes, Tuff-Cork, 10-5/8" X 10-7/8"	P27944TC	1	1982-1983, 8-1/2" Ring Gear, 10 Bolt Holes		
JETSTAR 1			1982-1983, 8-1/2" Ring Gear, 10 Bolt Holes, Tuff-Cork.		
Diff. Hsg. Cover Gasket			1978-1981		
1965-1966, 10 Bolt Holes	P27943	1	MASTER		
JETSTAR 88			Axle Hsg Cover Gasket		
Diff. Hsg. Cover Gasket			1937-1938		
1964-1966	P27820	1	1937-1938		
LE SABRE			Diff. Carrier Gasket		
Diff. Hsg. Cover Gasket			1937-1938		
1985-1990, 8-1/2" Ring Gear, 10 Bolt Holes	P27857	1	MASTER 85		
1985-1990, 8-1/2" Ring Gear, 10 Bolt Holes, Tuff-Cork.	P27857TC	1	Axle Hsg Cover Gasket		
1982-1990, 7-1/2" Ring Gear	P27872	1	1939-1940		
1982-1984, Except 7-1/2" Ring Gear, 10 Bolt Holes.	P27943	1	Diff. Carrier Gasket		
			1939-1940		
			MASTER DELUXE		
			Axle Hsg Cover Gasket		
			1937-1942		
			Diff. Carrier Gasket		
			1937-1942		

PASSENGER CAR

General Motors Corp. (cont.)

Differential Housing Cover Gaskets (cont.)

<i>Model & Application</i>	<i>Part No.</i>	<i>Qty.</i>	<i>Model & Application</i>	<i>Part No.</i>	<i>Qty.</i>
MONTE CARLO			PARISIENNE (cont.)		
Diff. Hsg. Cover Gasket			Diff. Hsg. Cover Gasket (cont.)		
1982-1988, 7-1/2" Ring Gear, 7-5/8" Ring Gear	P27872	1	1983-1986, 7-1/2" Ring Gear	P27872	1
1982-1988, 8-1/2" Ring Gear, 10 Bolt Holes	P27857	1	PHOENIX		
1982-1988, 8-1/2" Ring Gear, 10 Bolt Holes, Tuff-Cork.	P27857TC	1	Diff. Hsg. Cover Gasket		
1976-1981	P27872	1	1977-1979, 7-1/2" Ring Gear	P27872	1
1973-1975, 10 Bolt Holes	P27857	1	1977-1979, 8-1/2" Ring Gear, 10 Bolt Holes	P27857	1
1973-1975, 10 Bolt Holes, Tuff-Cork	P27857TC	1	1977-1979, 8-1/2" Ring Gear, 10 Bolt Holes, Tuff-Cork.	P27857TC	1
1970-1972, 10 Bolt Holes, 10-5/16" X 10-3/4"	P27939	1	REGAL		
1970-1972, 12 Bolt Holes, 10-5/8" X 10-7/8"	P27944	1	Diff. Hsg. Cover Gasket		
1970-1972, 12 Bolt Holes, Tuff-Cork, 10-5/8" X 10-7/8"	P27944TC	1	1982-1983, 7-1/2" Ring Gear	P27872	1
MONZA			1982-1983, Except 7-1/2" Ring Gear, 10 Bolt Holes.	P27943	1
Diff. Hsg. Cover Gasket			1978-1987, 10 Bolt Holes, 10-3/4" X 10-5/8"	P27943	1
1979-1980	P27872	1	1978-1981, 12 Bolt Holes, 11-1/2" X 11-3/4"	P27853	1
1975-1978	P28784	1	1978-1981, 8-7/8" Ring Gear, 10 Bolt Holes	P27943	1
NINETY EIGHT			1976-1987, 10 Bolt Holes, 10-3/16" X 10-7/8"	P27857	1
Diff. Hsg. Cover Gasket			1976-1987, 10 Bolt Holes, Tuff-Cork, 10-3/16" X 10-7/8"	P27857TC	1
1984, 7-1/2" Ring Gear, 7-5/8" Ring Gear	P27872	1	1976-1987, 10 Bolt Holes, 10-3/4" X 10-5/8"	P27943	1
1984, 8-1/2" Ring Gear, 10 Bolt Holes	P27857	1	1976-1987, 7-1/2" Ring Gear, K Or P Type	P27872	1
1984, 8-1/2" Ring Gear, 10 Bolt Holes, Tuff-Cork.	P27857TC	1	REGENCY		
1968-1981, 10 Bolt Holes, 10-3/16" X 10-7/8"	P27857	1	Diff. Hsg. Cover Gasket		
1968-1981, 10 Bolt Holes, Tuff-Cork, 10-3/16" X 10-7/8"	P27857TC	1	1984, 7-1/2" Ring Gear, 7-5/8" Ring Gear	P27872	1
1968-1972, 12 Bolt Holes, 10-5/8" X 11-1/8"	P18563	1	1984, 8-1/2" Ring Gear, 10 Bolt Holes	P27857	1
1968-1972, 12 Bolt Holes, 10-3/4" X 11"	P27850	1	1984, 8-1/2" Ring Gear, 10 Bolt Holes, Tuff-Cork.	P27857TC	1
1967, O Type, 12 Bolt Holes, 11-1/2" X 11-3/4"	P27853	1	RIVIERA		
1967, P Type Axle, 10 Bolt Holes, 10-3/4" X 10-5/8"	P27943	1	Diff. Hsg. Cover Gasket		
1965-1966, 10 Bolt Holes	P27943	1	1979-1985	P27637	1
NOMAD			1973-1978, 7-1/2" Ring Gear, K Or P Type	P27872	1
Diff. Carrier Gasket			1973-1978, 8-7/8" Ring Gear, 10 Bolt Holes	P27943	1
1955-1961	P27782T	1	1971-1978, 12 Bolt Holes, 11-1/2" X 11-3/4"	P27853	1
NOVA			1971-1978, 10 Bolt Holes, 10-3/16" X 10-7/8"	P27857	1
Diff. Hsg. Cover Gasket			1971-1978, 10 Bolt Holes, Tuff-Cork, 10-3/16" X 10-7/8"	P27857TC	1
1972-1978, 7-1/2" Ring Gear	P27872	1	1964-1970, 10 Bolt Holes, 11" X 11-1/4"	P18560	1
1972-1978, 8-1/2" Ring Gear, 10 Bolt Holes	P27857	1	1964-1970, 10 Bolt Holes, 10" X 10-7/16"	P27820	1
1972-1978, 8-1/2" Ring Gear, 10 Bolt Holes, Tuff-Cork.	P27857TC	1	1964-1970, 12 Bolt Holes, 10-5/8" X 10-7/8"	P27944	1
1969-1971, 10 Bolt Holes, 10-3/16" X 10-3/4"	P27939	1	1964-1970, 12 Bolt Holes, Tuff-Cork, 10-5/8" X 10-7/8"	P27944TC	1
1969-1971, 12 Bolt Holes, 10-5/8" X 10-7/8"	P27944	1	ROADMASTER		
1969-1971, 12 Bolt Holes, Tuff-Cork, 10-5/8" X 10-7/8"	P27944TC	1	Diff. Hsg. Cover Gasket		
OMEGA			1991-1996, 8-1/2" Ring Gear, 10 Bolt Holes	P27857	1
Diff. Hsg. Cover Gasket			1991-1996, 8-1/2" Ring Gear, 10 Bolt Holes, Tuff-Cork.	P27857TC	1
1976-1979, 7-1/2" Ring Gear	P27872	1	SAFARI		
1976-1979, 8-1/2" Ring Gear, 10 Bolt Holes	P27857	1	Diff. Hsg. Cover Gasket		
1976-1979, 8-1/2" Ring Gear, 10 Bolt Holes, Tuff-Cork.	P27857TC	1	1987-1989, 8-1/2" Ring Gear, 10 Bolt Holes	P27857	1
PARISIENNE			1987-1989, 8-1/2" Ring Gear, 10 Bolt Holes, Tuff-Cork.	P27857TC	1
Diff. Hsg. Cover Gasket			1987, 7-1/2" Ring Gear	P27872	1
1984-1986, 8-1/2" Ring Gear, 10 Bolt Holes	P27857	1	SEDAN DEVILLE		
1984-1986, 8-1/2" Ring Gear, 10 Bolt Holes, Tuff-Cork.	P27857TC	1	Diff. Hsg. Cover Gasket		
			1978-1979, 10 Bolt Holes	P27943	1

Differential Housing Cover Gaskets (cont.)

<i>Model & Application</i>	<i>Part No.</i>	<i>Qty.</i>	<i>Model & Application</i>	<i>Part No.</i>	<i>Qty.</i>
SERIES 62			STAR CHIEF (cont.)		
Diff. Carrier Gasket			Diff. Carrier Gasket (cont.)		
1957-1958	P27933	1	1957-1958	P29325	1
SERIES 6200			Diff. Hsg. Cover Gasket		
Diff. Carrier Gasket			1965, 10 Bolt Holes	P27943	1
1957-1967	P27933	1	STAR CHIEF EXECUTIVE		
Diff. Hsg. Cover Gasket			Diff. Hsg. Cover Gasket		
1968-1975	P28909	1	1966, 10 Bolt Holes	P27943	1
SEVILLE			STARFIRE		
Diff. Hsg. Cover Gasket			Diff. Hsg. Cover Gasket		
1980-1985	P27637	1	1976-1980	P27872	1
1976-1979, 10 Bolt Holes	P27857	1	1965-1966, 10 Bolt Holes	P27943	1
1976-1979, 10 Bolt Holes, Tuff-Cork	P27857TC	1	STYLEMASTER		
SKYHAWK			Axle Hsg Cover Gasket		
Diff. Hsg. Cover Gasket			1946-1948	P37659	1
1977-1980	P27872	1	Diff. Carrier Gasket		
1975-1976	P27870	1	1946-1948	P27659	1
SKYLARK			SUNBIRD		
Diff. Hsg. Cover Gasket			Diff. Hsg. Cover Gasket		
1976-1979, 10 Bolt Holes, 10-3/16" X			1976-1980, 6-1/2" Ring Gear	P28784	1
10-7/8"	P27857	1	1976-1980, 7-1/2" Ring Gear	P27872	1
1976-1979, 10 Bolt Holes, Tuff-Cork,			SUPER CHIEF		
10-3/16" X 10-7/8"	P27857TC	1	Diff. Carrier Gasket		
1976-1979, 10 Bolt Holes, 10-3/4" X			1958	P29325	1
10-5/8"	P27943	1	TEMPEST		
1976-1979, 7-1/2" Ring Gear, K Or P Type	P27872	1	Diff. Hsg. Cover Gasket		
1975-1976, 7-1/2" Ring Gear	P27872	1	1970-1971, Except Ram Air, 10 Bolt Holes,		
1975-1976, 8-1/2" Ring Gear, 10 Bolt Holes	P27857	1	10" X 10-7/16"	P27820	1
1975-1976, 8-1/2" Ring Gear, 10 Bolt			1970-1971, Except Ram Air, 12 Bolt Holes,		
Holes, Tuff-Cork.	P27857TC	1	10-5/8" X 10-7/8"	P27944	1
1971-1972, 10 Bolt Holes, 10-3/16" X			1970-1971, Except Ram Air, 12 Bolt Holes,		
10-7/8"	P27857	1	Tuff-Cork, 10-5/8" X 10-7/8"	P27944TC	1
1971-1972, 10 Bolt Holes, Tuff-Cork,			1970-1971, Ram Air, 10 Bolt Holes	P27943	1
10-3/16" X 10-7/8"	P27857TC	1	1964-1969	P27820	1
1970, 12 Bolt Holes, 10-5/8" X 10-7/8"	P27944	1	TEMPEST LEMANS		
1970, 12 Bolt Holes, Tuff-Cork, 10-5/8" X			Diff. Hsg. Cover Gasket		
10-7/8"	P27944TC	1	1964-1966	P27820	1
1964-1970, 10 Bolt Holes, 10" X 10-7/16"	P27820	1	TORONADO		
SPECIAL			Diff. Hsg. Cover Gasket		
Diff. Hsg. Cover Gasket			1979-1985	P27637	1
1964-1969	P27820	1	1970-1978	P28883	1
Axle Hsg Cover Gasket			TOWNSMAN		
1949-1952	P37659	1	Axle Hsg Cover Gasket		
Diff. Carrier Gasket			1954	P37659	1
1949-1952	P27659	1	Diff. Carrier Gasket		
SPECIAL 150			1955-1957	P27782T	1
Axle Hsg Cover Gasket			1954	P27659	1
1953-1954	P37659	1	VEGA		
Diff. Carrier Gasket			Diff. Hsg. Cover Gasket		
1955-1957	P27782T	1	1971-1977	P28784	1
1953-1954	P27659	1	VENTURA		
SPECIAL DELUXE			Diff. Carrier Gasket		
Axle Hsg Cover Gasket			1961	P29325	1
1940-1941	P37659	1	Diff. Hsg. Cover Gasket		
Diff. Carrier Gasket			1973-1974	P27857	1
1940-1941	P27659	1	1973-1974, Tuff-Cork	P27857TC	1
STAR CHIEF					
Diff. Carrier Gasket					
1960-1964	P29325	1			

PASSENGER CAR

General Motors Corp. (cont.)

Differential Housing Cover Gaskets (cont.)

<i>Model & Application</i>	<i>Part No.</i>	<i>Qty.</i>	<i>Model & Application</i>	<i>Part No.</i>	<i>Qty.</i>
VENTURA II			WILD CAT (cont.)		
Diff. Hsg. Cover Gasket			Diff. Hsg. Cover Gasket (cont.)		
1972, 10 Bolt Holes	P27857	1	1964-1970, 12 Bolt Holes, 10-5/8" X 10-7/8"	P27944	1
1972, 10 Bolt Holes, Tuff-Cork	P27857TC	1	1964-1970, 12 Bolt Holes, Tuff-Cork, 10-5/8" X 10-7/8"	P27944TC	1
1971	P27939	1	1964-1967, 10 Bolt Holes, 11" X 11-1/4"	P18560	1
VISTA CRUISER			YEOMAN		
Diff. Hsg. Cover Gasket			Diff. Carrier Gasket		
1973-1975, 7-1/2" Ring Gear	P27872	1	1958	P27782T	1
1964-1965, 10 Bolt Holes	P27943	1			
WILD CAT					
Diff. Hsg. Cover Gasket					
1964-1970, 10 Bolt Holes, 10" X 10-7/16"	P27820	1			

Transmission Gaskets

<i>Model & Application</i>	<i>Part No.</i>	<i>Qty.</i>	<i>Model & Application</i>	<i>Part No.</i>	<i>Qty.</i>
2000 SUNBIRD			88 ROYALE		
Transaxle Pan Gasket			Transaxle Pan Gasket		
1984-1985, Turbo Hydra-Matic 125 M34, MD9 Transaxle, Tuff-Cork.	W39356TC	1	1991-1996, Turbo Hydra-Matic 4T60E M13 Transaxle, Tuff-Cork.	W31180TC	1
Valve Body Cover Gasket			1989-1993, Turbo Hydra-Matic 440 T4 ME9 Transaxle, Tuff-Cork.	W39369TC	1
1984-1985, Turbo Hydra-Matic 125 M34, MD9 Transaxle, Tuff-Cork.	W39368TC	1	Valve Body Cover Gasket		
442			1995-1996, Turbo Hydra-Matic 4T60E M13 Transaxle, Tuff-Cork.	W39373TC	1
Transmission Gasket Set			1989-1993, Turbo Hydra-Matic 440 T4 ME9 Transaxle, Turbo Hydra-Matic 4T60E M13 Transaxle, Tuff-Cork.	W39373TC	1
1971, 3 Speed Transmission, Except Heavy Duty Transmission.	TS14737W	1	ACHIEVA		
1971, 3 Speed Transmission, Heavy Duty 3 Speed Transmission	TS27594	1	Transaxle Pan Gasket		
1968-1971, 4 Speed Transmission	TS27824	1	1992-1996, Turbo Hydra-Matic 125 M34, MD9 Transaxle, Tuff-Cork.	W39356TC	1
1968-1970, 3 Speed Transmission, Heavy Duty 3 Speed Transmission.	TS27817X	1	1992-1996, Turbo Hydra-Matic 4T60E M13 Transaxle, Tuff-Cork.	W31180TC	1
Transmission Pan Gasket			Valve Body Cover Gasket		
1969-1971, Turbo Hydra-Matic 250, 350 M31, M33, M38, MV4, MX2 Transmission.	W39348	1	1994-1996, Turbo Hydra-Matic 4T60E M13 Transaxle, Tuff-Cork.	W39373TC	1
1969-1971, Turbo Hydra-Matic 250, 350 M31, M33, M38, MV4, MX2 Transmission, Tuff-Cork	W39348TC	1	1992-1996, Turbo Hydra-Matic 125 M34, MD9 Transaxle, Tuff-Cork.	W39368TC	1
1968-1971, Turbo Hydra-Matic 375, 400 M40 Transmission.	W39341	1	1992-1993, Turbo Hydra-Matic 440 T4 ME9 Transaxle, Turbo Hydra-Matic 4T60E M13 Transaxle, Tuff-Cork.	W39373TC	1
1968-1971, Turbo Hydra-Matic 375, 400 M40 Transmission, Tuff-Cork.	W39341TC	1			
6000			ALLANTE		
Transaxle Pan Gasket			Transaxle Pan Gasket		
1991, Turbo Hydra-Matic 4T60E M13 Transaxle, Tuff-Cork.	W31180TC	1	1991-1992, Turbo Hydra-Matic 4T60E M13 Transaxle, Tuff-Cork.	W31180TC	1
1988-1991, Turbo Hydra-Matic 440 T4 ME9 Transaxle, Tuff-Cork.	W39369TC	1	1987-1992, Turbo Hydra-Matic 440 T4 ME9 Transaxle, Tuff-Cork.	W39369TC	1
1988-1989, All Wheel Drive, Turbo Hydra-Matic 125C MD9 Transaxle, Tuff-Cork	W31372TC	1	Valve Body Cover Gasket		
1982-1991, Turbo Hydra-Matic 125 M34, MD9 Transaxle, Tuff-Cork.	W39356TC	1	1989-1992, Turbo Hydra-Matic 440 T4 ME9 Transaxle, Turbo Hydra-Matic 4T60E M13 Transaxle, Tuff-Cork.	W39373TC	1
1982-1991, Turbo Hydra-Matic 125 M34, MD9 Transaxle, Tuff-Cork.	W39356TC	1	1987-1988, Turbo Hydra-Matic 440 T4 ME9 Transaxle, Tuff-Cork.	W39373TC	1
Valve Body Cover Gasket			APOLLO		
1988-1991, Turbo Hydra-Matic 440 T4 ME9 Transaxle, Turbo Hydra-Matic 4T60E M13 Transaxle, Tuff-Cork.	W39373TC	1	Transmission Gasket Set		
1988-1989, Turbo Hydra-Matic 440 T4 ME9 Transaxle, Tuff-Cork.	W39373TC	1	1973-1975, 3 Speed Transmission	TS14737W	1
1982-1991, Turbo Hydra-Matic 125 M34, MD9 Transaxle, Tuff-Cork.	W39368TC	1	Transmission Pan Gasket		
			1973-1975, Turbo Hydra-Matic 350, 375 M31, M33, MV4, MX2, MX5 Transmission.	W39348	1

Transmission Gaskets (cont.)

<i>Model & Application</i>	<i>Part No.</i>	<i>Qty.</i>	<i>Model & Application</i>	<i>Part No.</i>	<i>Qty.</i>
APOLLO (cont.)			BERETTA (cont.)		
Transmission Pan Gasket (cont.)			Valve Body Cover Gasket (cont.)		
1973-1975, Turbo Hydra-Matic 350, 375 M31, M33, MV4, MX2, MX5 Transmission, Tuff-Cork	W39348TC	1	1992-1996, Turbo Hydra-Matic 3T40 MD9 Transaxle, Tuff-Cork	W39368TC	1
ASTRE			1991, Turbo Hydra-Matic 4T60E M13 Transaxle, Tuff-Cork	W39373TC	1
Transmission Gasket Set			1990-1993, Turbo Hydra-Matic 440 T4 ME9 Transaxle, Turbo Hydra-Matic 4T60E M13 Transaxle, Tuff-Cork	W39373TC	1
1977, Saginaw 4 Speed Transmission	TS14737W	1	1987-1996, Turbo Hydra-Matic 125 M34, MD9 Transaxle, Tuff-Cork	W39368TC	1
1975-1977, Muncie 3 Speed Transmission	TS27594	1	BISCAYNE		
1975-1977, Muncie 4 Speed Transmission	TS27824W	1	Transmission Gasket Set		
1975-1976, Saginaw 3 Speed Transmission, Saginaw 4 Speed Transmission	TS14737W	1	1971-1972, Muncie 3 Speed Transmission	TS27594	1
1975, Saginaw 3 Speed Transmission	TS14737W	1	1971-1972, Muncie 4 Speed Transmission	TS27824W	1
BEAUVILLE			1966-1970, Muncie 4 Speed Transmission	TS27824	1
Transmission Gasket Set			1966-1970, Saginaw 4 Speed Transmission	TS14737W	1
1956-1957, 3 Speed Transmission, Seals Not Included.	TS27061	1	1963-1965, Muncie 4 Speed Transmission	TS27824W	1
1956-1957, 4 Speed Transmission	TS27075W	1	1958-1965, 3 Speed Transmission, Contains Seals	TS27011W	1
1955-1957, 3 Speed Transmission, Contains Seals	TS27011W	1	1958-1965, 3 Speed Transmission, Seals Not Included.	TS27061	1
BEL AIR			1958-1965, 4 Speed Transmission	TS27075W	1
Transmission Gasket Set			Transmission Pan Gasket		
1971-1974, Muncie 3 Speed Transmission	TS27594	1	1969-1972, Turbo Hydra-Matic 250, 250C, 350, 350C, 375 M31, M33, M38, MV4, MX2, MY3 Transmission	W39348	1
1971-1972, Muncie 4 Speed Transmission	TS27824W	1	1969-1972, Turbo Hydra-Matic 250, 250C, 350, 350C, 375 M31, M33, M38, MV4, MX2, MY3 Transmission, Tuff-Cork	W39348TC	1
1966-1970, Muncie 4 Speed Transmission	TS27824	1	1965-1972, Powerglide Transmission, Torque Drive	W39007	1
1966-1970, Saginaw 4 Speed Transmission	TS14737W	1	1965-1972, Turbo Hydra-Matic 375, 400 M40 Transmission	W39341	1
1963-1965, Muncie 4 Speed Transmission	TS27824W	1	1965-1972, Turbo Hydra-Matic 375, 400 M40 Transmission, Tuff-Cork	W39341TC	1
1957-1965, 4 Speed Transmission	TS27075W	1	1963-1965, Powerglide Transmission	W39007	1
1956-1965, 3 Speed Transmission, Seals Not Included.	TS27061	1	1962-1969, Powerglide Transmission, Torque Drive	W39007	1
1955-1965, 3 Speed Transmission, Contains Seals	TS27011W	1	1962-1967, Powerglide Transmission	W39007	1
1953-1954, 3 Speed Transmission	TS26250X	1	1958-1959, Powerglide Transmission	W38765	1
Transmission Pan Gasket			BONNEVILLE		
1969-1975, Turbo Hydra-Matic 250, 250C, 350, 350C, 375 M31, M33, M38, MV4, MX2, MY3 Transmission	W39348	1	Transaxle Pan Gasket		
1969-1975, Turbo Hydra-Matic 250, 250C, 350, 350C, 375 M31, M33, M38, MV4, MX2, MY3 Transmission, Tuff-Cork	W39348TC	1	1991-1996, Turbo Hydra-Matic 4T60E M13 Transaxle, Tuff-Cork	W31180TC	1
1965-1975, Turbo Hydra-Matic 375, 400 M40 Transmission	W39341	1	1986-1993, Turbo Hydra-Matic 440 T4 ME9 Transaxle, Tuff-Cork	W39369TC	1
1965-1975, Turbo Hydra-Matic 375, 400 M40 Transmission, Tuff-Cork	W39341TC	1	Transmission Gasket Set		
1965-1973, Powerglide Transmission, Torque Drive	W39007	1	1976, Muncie 4 Speed Transmission	TS27824W	1
1963-1966, Powerglide Transmission	W39007	1	1969, 3 Speed Transmission, Except Saginaw 3 Speed Transmission	TS27817X	1
1962-1969, Powerglide Transmission, Torque Drive	W39007	1	1968, 3 Speed Transmission, Heavy Duty 3 Speed Transmission	TS27817X	1
1962-1967, Powerglide Transmission	W39007	1	1967, 3 Speed Transmission, Except Heavy Duty Transmission, Except Saginaw 3 Speed Transmission	TS27817X	1
1958-1959, Powerglide Transmission	W38765	1	1966, 3 Speed Transmission, Except Saginaw 3 Speed Transmission	TS27817X	1
BERETTA			1965, 3 Speed Transmission, Heavy Duty 3 Speed Transmission	TS27817X	1
Transaxle Pan Gasket			1964-1968, Muncie 4 Speed Transmission	TS27824	1
1992-1996, Turbo Hydra-Matic 3T40 MD9 Transaxle, Tuff-Cork	W39356TC	1	1964-1965, 3 Speed Transmission, Heavy Duty 3 Speed Transmission, Second Type	TS27817X	1
1991-1996, Turbo Hydra-Matic 4T60E M13 Transaxle, Tuff-Cork	W31180TC	1	1961-1964, 3 Speed Transmission, Except Heavy Duty Transmission	TS27061	1
1990-1993, Turbo Hydra-Matic 440 T4 ME9 Transaxle, Tuff-Cork	W39369TC	1	1961-1963, 4 Speed Transmission	TS27075W	1
1987-1996, Turbo Hydra-Matic 125 M34, MD9 Transaxle, Tuff-Cork	W39356TC	1	Valve Body Cover Gasket		
Valve Body Cover Gasket			1994-1996, Turbo Hydra-Matic 4T60E M13 Transaxle, Tuff-Cork		
1994-1996, Turbo Hydra-Matic 4T60E M13 Transaxle, Tuff-Cork			W39373TC		

PASSENGER CAR

General Motors Corp. (cont.)

Transmission Gaskets (cont.)

<i>Model & Application</i>	<i>Part No.</i>	<i>Qty.</i>	<i>Model & Application</i>	<i>Part No.</i>	<i>Qty.</i>
BONNEVILLE (cont.)			BROUGHAM (cont.)		
Transmission Pan Gasket			Transmission Pan Gasket (cont.)		
1983-1987, Turbo Hydra-Matic 700-R4 MD8 Transmission	W39365	1	1992-1996, 8-1/2" Ring Gear, 10 Bolt Holes, Tuff-Cork	P27857TC	1
1983-1987, Turbo Hydra-Matic 700-R4 MD8 Transmission, Tuff-Cork	W39365TC	1	1992-1993, Turbo Hydra-Matic 700-R4 MD8 Transmission	W39365	1
1981-1987, Turbo Hydra-Matic 200 4R MW9 Transmission	W39361	1	1992-1993, Turbo Hydra-Matic 700-R4 MD8 Transmission, Tuff-Cork	W39365TC	1
1981-1987, Turbo Hydra-Matic 200 4R MW9 Transmission, Tuff-Cork	W39361TC	1	CALAIS		
1976-1987, Turbo Hydra-Matic 200 M29, MV9 Transmission	W39045	1	Transmission Pan Gasket		
1976-1987, Turbo Hydra-Matic 200 M29, MV9 Transmission, Tuff-Cork	W39045TC	1	1975-1976, Turbo Hydra-Matic 325 M32, M57 Transaxle	W39355	1
1971-1983, Turbo Hydra-Matic 250, 350, 375 M31, M33, M38, VMV4, MX2, MX3 Transmission	W39348	1	1975-1976, Turbo Hydra-Matic 325 M32, M57 Transaxle, Tuff-Cork	W39355TC	1
1971-1983, Turbo Hydra-Matic 250, 350, 375 M31, M33, M38, VMV4, MX2, MX3 Transmission, Tuff-Cork	W39348TC	1	1965-1976, Turbo Hydra-Matic 400 M40 Transmission	W39341	1
1971-1973, Automatic M35 Transmission	W39007	1	1965-1976, Turbo Hydra-Matic 400 M40 Transmission, Tuff-Cork	W39341TC	1
1969-1977, Turbo Hydra-Matic 375, 400 M40 Transmission	W39341	1	Transaxle Pan Gasket		
1969-1977, Turbo Hydra-Matic 375, 400 M40 Transmission, Tuff-Cork	W39341TC	1	1985-1991, Turbo Hydra-Matic 125 M34, MD9 Transaxle, Tuff-Cork	W39356TC	1
1969, Turbo Hydra-Matic 250, 350, 375 M31, M33, M38, VMV4, MX2, MX3 Transmission	W39348	1	Valve Body Cover Gasket		
1969, Turbo Hydra-Matic 250, 350, 375 M31, M33, M38, VMV4, MX2, MX3 Transmission, Tuff-Cork	W39348TC	1	1989-1991, Turbo Hydra-Matic 440 T4 ME9 Transaxle, Turbo Hydra-Matic 4T60E M13 Transaxle, Tuff-Cork	W39373TC	1
1964-1969, Automatic M35 Transmission	W39007	1	1985-1991, Turbo Hydra-Matic 125 M34, MD9 Transaxle, Tuff-Cork	W39368TC	1
Valve Body Cover Gasket			1985-1988, Turbo Hydra-Matic 440 T4 ME9 Transaxle, Tuff-Cork	W39373TC	1
1995-1996, Turbo Hydra-Matic 4T60E M13 Transaxle, Tuff-Cork	W39373TC	1	CAMARO		
1988-1993, Turbo Hydra-Matic 440 T4 ME9 Transaxle, Turbo Hydra-Matic 4T60E M13 Transaxle, Tuff-Cork	W39373TC	1	Transmission Gasket Set		
1986-1988, Turbo Hydra-Matic 440 T4 ME9 Transaxle, Tuff-Cork	W39373TC	1	1971-1974, Muncie 3 Speed Transmission	TS27594	1
1982, Turbo Hydra-Matic 125 M34, MD9 Transaxle, Tuff-Cork	W39368TC	1	1971-1972, Muncie 4 Speed Transmission	TS27824W	1
BONNEVILLE CUSTOM			1967-1970, Muncie 4 Speed Transmission	TS27824	1
Transmission Gasket Set			1967-1970, Saginaw 4 Speed Transmission	TS14737W	1
1961-1962, 3 Speed Transmission, Except Heavy Duty Transmission	TS27061	1	Transmission Pan Gasket		
1961-1962, 4 Speed Transmission	TS27075W	1	1994-2002, Turbo Hydra-Matic 4L60E M30 Transmission	W39365	1
BROOKWOOD			1994-2002, Turbo Hydra-Matic 4L60E M30 Transmission, Tuff-Cork	W39365TC	1
Transmission Gasket Set			1993-1995, Turbo Hydra-Matic 4L60E M30 Transmission, Turbo Hydra-Matic 700-R4 MD8 Transmission	W39365	1
1958-1961, 3 Speed Transmission, Contains Seals	TS27011W	1	1993-1995, Turbo Hydra-Matic 4L60E M30 Transmission, Turbo Hydra-Matic 700-R4 MD8 Transmission, Tuff-Cork	W39365TC	1
1958-1961, 3 Speed Transmission, Seals Not Included	TS27061	1	1983-1995, Turbo Hydra-Matic 700-R4 MD8 Transmission, Tuff-Cork	W39365TC	1
1958-1961, 4 Speed Transmission	TS27075W	1	1976-1984, Turbo Hydra-Matic 200 M29, MV9 Transmission	W39045	1
Transmission Pan Gasket			1976-1984, Turbo Hydra-Matic 200 M29, MV9 Transmission, Tuff-Cork	W39045TC	1
1958-1959, Powerglide Transmission	W38765	1	1969-1984, Turbo Hydra-Matic 250, 250C, 350, 350C, 375 M31, M33, M38, MV4, MX2, MY3 Transmission	W39348	1
BROUGHAM			1969-1984, Turbo Hydra-Matic 250, 250C, 350, 350C, 375 M31, M33, M38, MV4, MX2, MY3 Transmission, Tuff-Cork	W39348TC	1
Transmission Pan Gasket			1967-1977, Turbo Hydra-Matic 375, 400 M40 Transmission	W39341	1
1994-1996, Turbo Hydra-Matic 4L60E M30 Transmission, Turbo Hydra-Matic 700-R4 MD8 Transmission	W39365	1	1967-1977, Turbo Hydra-Matic 375, 400 M40 Transmission, Tuff-Cork	W39341TC	1
1994-1996, Turbo Hydra-Matic 4L60E M30 Transmission, Turbo Hydra-Matic 700-R4 MD8 Transmission, Tuff-Cork	W39365TC	1	1967-1973, Powerglide Transmission, Torque Drive	W39007	1

Transmission Gaskets (cont.)

<i>Model & Application</i>	<i>Part No.</i>	<i>Qty.</i>	<i>Model & Application</i>	<i>Part No.</i>	<i>Qty.</i>
CAMARO (cont.)			CATALINA (cont.)		
Transmission Pan Gasket (cont.)			Transmission Pan Gasket		
1967, Powerglide Transmission	W39007	1	1981, Turbo Hydra-Matic 200 4R MW9 Transmission	W39361	1
CAPRICE			1981, Turbo Hydra-Matic 200 4R MW9 Transmission, Tuff-Cork	W39361TC	1
Transmission Pan Gasket			1976-1981, Turbo Hydra-Matic 200 M29, MV9 Transmission	W39045	1
1994-1996, Turbo Hydra-Matic 4L60E M30 Transmission	W39365	1	1976-1981, Turbo Hydra-Matic 200 M29, MV9 Transmission, Tuff-Cork	W39045TC	1
1994-1996, Turbo Hydra-Matic 4L60E M30 Transmission, Tuff-Cork	W39365TC	1	1969-1981, Turbo Hydra-Matic 250, 350, 375 M31, M33, M38, VMV4, MX2, MX3 Transmission	W39348	1
1994-1995, Turbo Hydra-Matic 4L60E M30 Transmission, Turbo Hydra-Matic 700-R4 MD8 Transmission, Tuff-Cork	W39365TC	1	1969-1981, Turbo Hydra-Matic 250, 350, 375 M31, M33, M38, VMV4, MX2, MX3 Transmission, Tuff-Cork	W39348TC	1
1986-1993, Turbo Hydra-Matic 700-R4 MD8 Transmission, Tuff-Cork	W39365TC	1	1969-1977, Turbo Hydra-Matic 375, 400 M40 Transmission	W39341	1
1985-1993, Turbo Hydra-Matic 4L60E M30 Transmission, Turbo Hydra-Matic 700-R4 MD8 Transmission, Tuff-Cork	W39365TC	1	1969-1977, Turbo Hydra-Matic 375, 400 M40 Transmission, Tuff-Cork	W39341TC	1
1982-1993, Turbo Hydra-Matic 700-R4 MD8 Transmission	W39365	1	1967-1973, Automatic M35 Transmission	W39007	1
1982-1993, Turbo Hydra-Matic 700-R4 MD8 Transmission, Tuff-Cork	W39365TC	1	1964-1965, Automatic M35 Transmission	W39007	1
1981-1990, Turbo Hydra-Matic 200 4R MW9 Transmission	W39361	1	CAVALIER		
1981-1990, Turbo Hydra-Matic 200 4R MW9 Transmission, Tuff-Cork	W39361TC	1	Transaxle Pan Gasket		
1976-1988, Turbo Hydra-Matic 200 M29, MV9 Transmission	W39045	1	1992-2001, Turbo Hydra-Matic 3T40 MD9 Transaxle, Tuff-Cork	W39356TC	1
1976-1988, Turbo Hydra-Matic 200 M29, MV9 Transmission, Tuff-Cork	W39045TC	1	1991-1994, Turbo Hydra-Matic 4T60E M13 Transaxle, Tuff-Cork	W31180TC	1
1969-1984, Turbo Hydra-Matic 250, 250C, 350, 350C, 375 M31, M33, M38, MV4, MX2, MY3 Transmission	W39348	1	1990-1993, Turbo Hydra-Matic 440 T4 ME9 Transaxle, Tuff-Cork	W39369TC	1
1969-1984, Turbo Hydra-Matic 250, 250C, 350, 350C, 375 M31, M33, M38, MV4, MX2, MY3 Transmission, Tuff-Cork	W39348TC	1	1983-1995, Turbo Hydra-Matic 125 M34, MD9 Transaxle, Tuff-Cork	W39356TC	1
1966-1977, Turbo Hydra-Matic 375, 400 M40 Transmission	W39341	1	Valve Body Cover Gasket		
1966-1977, Turbo Hydra-Matic 375, 400 M40 Transmission, Tuff-Cork	W39341TC	1	1992-2001, Turbo Hydra-Matic 3T40 MD9 Transaxle, Tuff-Cork	W39368TC	1
1966-1973, Powerglide Transmission, Torque Drive	W39007	1	1991, Turbo Hydra-Matic 4T60E M13 Transaxle, Tuff-Cork	W39373TC	1
1966-1967, Powerglide Transmission	W39007	1	1990-1993, Turbo Hydra-Matic 440 T4 ME9 Transaxle, Turbo Hydra-Matic 4T60E M13 Transaxle, Tuff-Cork	W39373TC	1
CATALINA			1982-1995, Turbo Hydra-Matic 125 M34, MD9 Transaxle, Tuff-Cork	W39368TC	1
Transmission Gasket Set			CELEBRITY		
1973, Muncie 3 Speed Transmission	TS27594	1	Transaxle Pan Gasket		
1973, Muncie 4 Speed Transmission	TS27824W	1	1990, Turbo Hydra-Matic 440 T4 ME9 Transaxle, Tuff-Cork	W39369TC	1
1973, Saginaw 3 Speed Transmission, Saginaw 4 Speed Transmission	TS14737W	1	1984-1985, Turbo Hydra-Matic 440 T4 ME9 Transaxle, Tuff-Cork	W39369TC	1
1969, 3 Speed Transmission, Except Saginaw 3 Speed Transmission	TS27817X	1	1982-1990, Turbo Hydra-Matic 125 M34, MD9 Transaxle, Tuff-Cork	W39356TC	1
1968, 3 Speed Transmission, Heavy Duty 3 Speed Transmission	TS27817X	1	Valve Body Cover Gasket		
1967, 3 Speed Transmission, Except Heavy Duty Transmission, Except Saginaw 3 Speed Transmission	TS27817X	1	1990, Turbo Hydra-Matic 440 T4 ME9 Transaxle, Tuff-Cork	W39373TC	1
1966, 3 Speed Transmission, Except Saginaw 3 Speed Transmission	TS27817X	1	1984-1985, Turbo Hydra-Matic 440 T4 ME9 Transaxle, Tuff-Cork	W39373TC	1
1965, 3 Speed Transmission, Heavy Duty 3 Speed Transmission	TS27817X	1	1982-1990, Turbo Hydra-Matic 125 M34, MD9 Transaxle, Tuff-Cork	W39368TC	1
1964-1968, Muncie 4 Speed Transmission	TS27824	1	CENTURION		
1964-1965, 3 Speed Transmission, Heavy Duty 3 Speed Transmission, Second Type	TS27817X	1	Transmission Gasket Set		
1961-1964, 3 Speed Transmission, Except Heavy Duty Transmission	TS27061	1	1971-1972, 3 Speed Transmission	TS14737W	1
1961-1963, 4 Speed Transmission	TS27075W	1	Transmission Pan Gasket		
			1971-1973, Turbo Hydra-Matic 350, 375 M31, M33, MV4, MX2, MX5 Transmission	W39348	1

PASSENGER CAR

General Motors Corp. (cont.)

Transmission Gaskets (cont.)

<i>Model & Application</i>	<i>Part No.</i>	<i>Qty.</i>	<i>Model & Application</i>	<i>Part No.</i>	<i>Qty.</i>
CENTURION (cont.)			CENTURY (cont.)		
Transmission Pan Gasket (cont.)			Valve Body Cover Gasket		
1971-1973, Turbo Hydra-Matic 350, 375 M31, M33, MV4, MX2, MX5 Transmission, Tuff-Cork	W39348TC	1	1994-1996, Turbo Hydra-Matic 125C MD9 Transaxle, Tuff-Cork	W39368TC	1
1971-1973, Turbo Hydra-Matic 400 M40 Transmission	W39341	1	1994-1996, Turbo Hydra-Matic 4T60E M13 Transaxle, Tuff-Cork	W39373TC	1
1971-1973, Turbo Hydra-Matic 400 M40 Transmission, Tuff-Cork	W39341TC	1	1993-1996, Turbo Hydra-Matic 3T40 MD9 Transaxle, Tuff-Cork	W39368TC	1
CENTURY			1989-1993, Turbo Hydra-Matic 440 ME9 Transaxle, Turbo Hydra-Matic 4T60E M13 Transaxle, Tuff-Cork		
Transaxle Pan Gasket			1983-1988, Turbo Hydra-Matic 440 ME9 Transaxle, Tuff-Cork		
1994-1996, Turbo Hydra-Matic 125C MD9 Transaxle, Tuff-Cork	W39356TC	1	1982-1992, Turbo Hydra-Matic 125 M34, MD9 Transaxle, Turbo Hydra-Matic 125C MD9 Transaxle, Tuff-Cork	W39373TC	1
1994-1996, Turbo Hydra-Matic 4T60E M13 Transaxle, Tuff-Cork	W31180TC	1	CHEVELLE		
1993-1996, Turbo Hydra-Matic 3T40 MD9 Transaxle, Tuff-Cork	W39356TC	1	Transmission Gasket Set		
1989-1992, Turbo Hydra-Matic 125 M34, MD9 Transaxle, Turbo Hydra-Matic 125C MD9 Transaxle, Tuff-Cork	W39356TC	1	1971-1974, Muncie 3 Speed Transmission	TS27594	1
1984-1988, Turbo Hydra-Matic 125 M34, MD9 Transaxle, Tuff-Cork	W39356TC	1	1971-1972, Muncie 4 Speed Transmission	TS27824W	1
1983-1988, Turbo Hydra-Matic 440 ME9 Transaxle, Tuff-Cork	W39369TC	1	1966-1970, Muncie 4 Speed Transmission	TS27824	1
1982-1992, Turbo Hydra-Matic 125 M34, MD9 Transaxle, Turbo Hydra-Matic 125C MD9 Transaxle, Tuff-Cork	W39356TC	1	1966-1970, Saginaw 4 Speed Transmission	TS14737W	1
Transmission Gasket Set			1964-1965, 3 Speed Transmission, Contains Seals	TS27011W	1
1973-1981, 3 Speed Transmission	TS14737W	1	1964-1965, 3 Speed Transmission, Seals Not Included	TS27061	1
Transmission Pan Gasket			1964-1965, 4 Speed Transmission	TS27075W	1
1984-1986, Turbo Hydra-Matic 325 M32, M57 Transaxle, Tuff-Cork	W39355TC	1	1964-1965, Muncie 4 Speed Transmission	TS27824W	1
1982, Turbo Hydra-Matic 250C M38 Transmission	W39348	1	Transmission Pan Gasket		
1982, Turbo Hydra-Matic 250C M38 Transmission, Tuff-Cork	W39348TC	1	1976-1977, Turbo Hydra-Matic 200 M29, MV9 Transmission	W39045	1
1981-1985, Turbo Hydra-Matic 200 4R MW9 Transmission	W39361	1	1976-1977, Turbo Hydra-Matic 200 M29, MV9 Transmission, Tuff-Cork	W39045TC	1
1981-1985, Turbo Hydra-Matic 200 4R MW9 Transmission, Tuff-Cork	W39361TC	1	1969-1977, Turbo Hydra-Matic 250, 250C, 350, 350C, 375 M31, M33, M38, MV4, MX2, MY3 Transmission	W39348	1
1979-1982, Turbo Hydra-Matic 325 M32, M57 Transaxle	W39355	1	1969-1977, Turbo Hydra-Matic 250, 250C, 350, 350C, 375 M31, M33, M38, MV4, MX2, MY3 Transmission, Tuff-Cork	W39348TC	1
1979-1982, Turbo Hydra-Matic 325 M32, M57 Transaxle, Tuff-Cork	W39355TC	1	1967-1973, Powerglide Transmission, Torque Drive	W39007	1
1978-1981, Turbo Hydra-Matic 250C M38 Transmission, Turbo Hydra-Matic 350, 375 M31, M33, MV4, MX2, MX5 Transmission.	W39348	1	1966, Powerglide Transmission	W39007	1
1978-1981, Turbo Hydra-Matic 250C M38 Transmission, Turbo Hydra-Matic 350, 375 M31, M33, MV4, MX2, MX5 Transmission, Tuff-Cork	W39348TC	1	1965-1977, Turbo Hydra-Matic 375, 400 M40 Transmission	W39341	1
1977-1981, Turbo Hydra-Matic 400 M40 Transmission	W39341	1	1965-1977, Turbo Hydra-Matic 375, 400 M40 Transmission, Tuff-Cork	W39341TC	1
1977-1981, Turbo Hydra-Matic 400 M40 Transmission, Tuff-Cork	W39341TC	1	1964-1973, Powerglide Transmission, Torque Drive	W39007	1
1976-1985, Turbo Hydra-Matic 200 M29, MV9 Transmission	W39045	1	1964-1967, Powerglide Transmission	W39007	1
1976-1985, Turbo Hydra-Matic 200 M29, MV9 Transmission, Tuff-Cork	W39045TC	1	CHEVETTE		
1973-1979, Turbo Hydra-Matic 350, 375 M31, M33, MV4, MX2, MX5 Transmission.	W39348	1	Transmission Pan Gasket		
1973-1979, Turbo Hydra-Matic 350, 375 M31, M33, MV4, MX2, MX5 Transmission, Tuff-Cork	W39348TC	1	1981-1986, Turbo Hydra-Matic 200 M29, MV9 Transmission	W39045	1
1973-1974, Turbo Hydra-Matic 400 M40 Transmission	W39341	1	1981-1986, Turbo Hydra-Matic 200 M29, MV9 Transmission, Tuff-Cork	W39045TC	1
1973-1974, Turbo Hydra-Matic 400 M40 Transmission, Tuff-Cork	W39341TC	1	CHEVY II		
			Transmission Gasket Set		
			1966-1968, Muncie 4 Speed Transmission	TS27824	1
			1966-1968, Saginaw 4 Speed Transmission	TS14737W	1
			1963-1965, Muncie 4 Speed Transmission	TS27824W	1
			1962-1965, 3 Speed Transmission, Contains Seals	TS27011W	1
			1962-1965, 3 Speed Transmission, Seals Not Included	TS27061	1
			1962-1965, 4 Speed Transmission	TS27075W	1

Transmission Gaskets (cont.)

<i>Model & Application</i>	<i>Part No.</i>	<i>Qty.</i>	<i>Model & Application</i>	<i>Part No.</i>	<i>Qty.</i>
CHEVY II (cont.)			CORSICA		
Transmission Pan Gasket			Transaxle Pan Gasket		
1965-1968, Turbo Hydra-Matic 375, 400 M40 Transmission.	W39341	1	1992-1996, Turbo Hydra-Matic 3T40 MD9 Transaxle, Tuff-Cork.	W39356TC	1
1965-1968, Turbo Hydra-Matic 375, 400 M40 Transmission, Tuff-Cork.	W39341TC	1	1991-1996, Turbo Hydra-Matic 4T60E M13 Transaxle, Tuff-Cork.	W31180TC	1
1962-1968, Powerglide Transmission, Torque Drive.	W39007	1	1990-1993, Turbo Hydra-Matic 440 T4 ME9 Transaxle, Tuff-Cork.	W39369TC	1
1962-1966, Powerglide Transmission	W39007	1	1987-1996, Turbo Hydra-Matic 125 M34, MD9 Transaxle, Tuff-Cork.	W39356TC	1
CHIEFTAIN			Valve Body Cover Gasket		
Transmission Gasket Set			1994-1996, Turbo Hydra-Matic 4T60E M13 Transaxle, Tuff-Cork.		
1958, 3 Speed Transmission, Except Heavy Duty Transmission.	TS27061	1	1992-1996, Turbo Hydra-Matic 3T40 MD9 Transaxle, Tuff-Cork.	W39368TC	1
CIMARRON			1991-1993, Turbo Hydra-Matic 440 T4 ME9 Transaxle, Turbo Hydra-Matic 4T60E M13 Transaxle, Tuff-Cork.		
Transaxle Pan Gasket			1991, Turbo Hydra-Matic 4T60E M13 Transaxle, Tuff-Cork.		
1983-1988, Turbo Hydra-Matic 125C MD9 Transaxle, Tuff-Cork.	W39356TC	1	1990, Turbo Hydra-Matic 440 T4 ME9 Transaxle, Tuff-Cork.	W39373TC	1
1982, Turbo Hydra-Matic 125 M34, MD9 Transaxle, Tuff-Cork.	W39356TC	1	1987-1996, Turbo Hydra-Matic 125 M34, MD9 Transaxle, Tuff-Cork.	W39368TC	1
Valve Body Cover Gasket			CORVAIR		
1982-1988, Turbo Hydra-Matic 125C MD9 Transaxle, Tuff-Cork.	W39368TC	1	Transmission Pan Gasket		
CITATION			1960-1968		
Transaxle Pan Gasket			W38765		
1980-1983, Turbo Hydra-Matic 125 M34, MD9 Transaxle, Tuff-Cork.	W39356TC	1	CORVETTE		
Valve Body Cover Gasket			Transmission Gasket Set		
1980-1983, Turbo Hydra-Matic 125 M34, MD9 Transaxle, Tuff-Cork.	W39368TC	1	1971-1972, Muncie 4 Speed Transmission		
CITATION 2			1966-1970, Muncie 4 Speed Transmission		
Transaxle Pan Gasket			1966-1970, Saginaw 4 Speed Transmission		
1984-1985, Turbo Hydra-Matic 125 M34, MD9 Transaxle, Tuff-Cork.	W39356TC	1	1963-1965, Muncie 4 Speed Transmission		
Valve Body Cover Gasket			1956-1965, 3 Speed Transmission, Seals Not Included.		
1984-1985, Turbo Hydra-Matic 125 M34, MD9 Transaxle, Tuff-Cork.	W39368TC	1	1956-1965, 4 Speed Transmission		
COMMERCIAL CHASSIS			1955-1965, 3 Speed Transmission, Contains Seals.		
Transaxle Pan Gasket			1953-1954, 3 Speed Transmission		
1991-1993, Turbo Hydra-Matic 4T60E M13 Transaxle, Tuff-Cork.	W31180TC	1	Transmission Pan Gasket		
1985-1990, Turbo Hydra-Matic 440 T4 ME9 Transaxle, Tuff-Cork.	W39369TC	1	1996-2003, Turbo Hydra-Matic 4L60E M30 Transmission.		
Valve Body Cover Gasket			1996-2003, Turbo Hydra-Matic 4L60E M30 Transmission, Tuff-Cork.		
1991-1993, Turbo Hydra-Matic 4T60E M13 Transaxle, Tuff-Cork.	W39373TC	1	1984-1995, Turbo Hydra-Matic 700-R4 MD8 Transmission.		
1985-1990, Turbo Hydra-Matic 440 T4 ME9 Transaxle, Tuff-Cork.	W39373TC	1	1984-1995, Turbo Hydra-Matic 700-R4 MD8 Transmission, Tuff-Cork.		
Transmission Pan Gasket			1984, Turbo Hydra-Matic 250, 250C, 350, 350C, 375 M31, M33, M38, MV4, MX2, MY3 Transmission.		
1980-1984, Turbo Hydra-Matic 350 M33, MV4 Transmission.	W39348	1	1984, Turbo Hydra-Matic 250, 250C, 350, 350C, 375 M31, M33, M38, MV4, MX2, MY3 Transmission, Tuff-Cork.		
1980-1984, Turbo Hydra-Matic 350 M33, MV4 Transmission, Tuff-Cork.	W39348TC	1	1982, Turbo Hydra-Matic 700-R4 MD8 Transmission.		
1976-1984, Turbo Hydra-Matic 400 M40 Transmission.	W39341	1	1982, Turbo Hydra-Matic 700-R4 MD8 Transmission, Tuff-Cork.		
1976-1984, Turbo Hydra-Matic 400 M40 Transmission, Tuff-Cork.	W39341TC	1	1976-1981, Turbo Hydra-Matic 250, 250C, 350, 350C, 375 M31, M33, M38, MV4, MX2, MY3 Transmission.		
1976, Turbo Hydra-Matic 325 M32, M57 Transaxle.	W39355	1	1976-1981, Turbo Hydra-Matic 250, 250C, 350, 350C, 375 M31, M33, M38, MV4, MX2, MY3 Transmission, Tuff-Cork.		
1976, Turbo Hydra-Matic 325 M32, M57 Transaxle, Tuff-Cork.	W39355TC	1	1966-1969, Powerglide Transmission, Torque Drive.		
			W39007		

PASSENGER CAR

General Motors Corp. (cont.)

Transmission Gaskets (cont.)

<i>Model & Application</i>	<i>Part No.</i>	<i>Qty.</i>	<i>Model & Application</i>	<i>Part No.</i>	<i>Qty.</i>
CORVETTE (cont.)			CUTLASS (cont.)		
Transmission Pan Gasket (cont.)			Transaxle Pan Gasket (cont.)		
1966, Powerglide Transmission	W39007	1	1987-1988, Turbo Hydra-Matic 440 T4 ME9 Transaxle, Tuff-Cork	W39369TC	1
1965-1977, Turbo Hydra-Matic 375, 400 M40 Transmission	W39341	1	1982-1984, Turbo Hydra-Matic 125 M34, MD9 Transaxle, Tuff-Cork	W39356TC	1
1965-1977, Turbo Hydra-Matic 375, 400 M40 Transmission, Tuff-Cork	W39341TC	1	Transmission Gasket Set		
1963-1968, Powerglide Transmission, Torque Drive	W39007	1	1980, 3 Speed Transmission	TS14737W	1
1962-1965, Powerglide Transmission	W39007	1	1974-1981, 3 Speed Transmission, 4 Speed Transmission	TS14737W	1
1958-1959, Powerglide Transmission	W38765	1	1974-1975, 4 Speed Transmission	TS14737W	1
COUPE DEVILLE			1972-1975, 3 Speed Transmission	TS14737W	1
Transmission Pan Gasket			1971-1973, 3 Speed Transmission, Except Heavy Duty Transmission	TS14737W	1
1978-1979, Turbo Hydra-Matic 200 M29, MV9 Transmission	W39045	1	1971, 3 Speed Transmission, Heavy Duty 3 Speed Transmission	TS27594	1
1978-1979, Turbo Hydra-Matic 200 M29, MV9 Transmission, Tuff-Cork	W39045TC	1	1967-1973, 4 Speed Transmission	TS27824	1
1978-1979, Turbo Hydra-Matic 400 M40 Transmission	W39341	1	1967-1970, 3 Speed Transmission, Heavy Duty 3 Speed Transmission	TS27817X	1
1978-1979, Turbo Hydra-Matic 400 M40 Transmission, Tuff-Cork	W39341TC	1	Transmission Pan Gasket		
CUSTOM CRUISER			1987-1988, Turbo Hydra-Matic 200 4R MW9 Transmission	W39361	1
Transmission Gasket Set			1987-1988, Turbo Hydra-Matic 200 4R MW9 Transmission, Tuff-Cork	W39361TC	1
1978-1981, 3 Speed Transmission, 4 Speed Transmission	TS14737W	1	1987, Turbo Hydra-Matic 200 M29, MV9 Transmission	W39045	1
1971-1973, 4 Speed Transmission	TS27824	1	1987, Turbo Hydra-Matic 200 M29, MV9 Transmission, Tuff-Cork	W39045TC	1
1971, 3 Speed Transmission, Heavy Duty 3 Speed Transmission	TS27594	1	1982-1984, Turbo Hydra-Matic 700-R4 MD8 Transmission	W39365	1
Transmission Pan Gasket			1982-1984, Turbo Hydra-Matic 700-R4 MD8 Transmission, Tuff-Cork	W39365TC	1
1988-1992, Turbo Hydra-Matic 700-R4 MD8 Transmission	W39365	1	1981-1984, Turbo Hydra-Matic 200 4R MW9 Transmission	W39361	1
1988-1992, Turbo Hydra-Matic 700-R4 MD8 Transmission, Tuff-Cork	W39365TC	1	1981-1984, Turbo Hydra-Matic 200 4R MW9 Transmission, Tuff-Cork	W39361TC	1
1982-1986, Turbo Hydra-Matic 700-R4 MD8 Transmission	W39365	1	1979-1984, Turbo Hydra-Matic 325 M32, M57 Transaxle	W39355	1
1982-1986, Turbo Hydra-Matic 700-R4 MD8 Transmission, Tuff-Cork	W39365TC	1	1979-1984, Turbo Hydra-Matic 325 M32, M57 Transaxle, Tuff-Cork	W39355TC	1
1981-1990, Turbo Hydra-Matic 200 4R MW9 Transmission	W39361	1	1976-1984, Turbo Hydra-Matic 200 M29, MV9 Transmission	W39045	1
1981-1990, Turbo Hydra-Matic 200 4R MW9 Transmission, Tuff-Cork	W39361TC	1	1976-1984, Turbo Hydra-Matic 200 M29, MV9 Transmission, Tuff-Cork	W39045TC	1
1977-1987, Turbo Hydra-Matic 200 M29, MV9 Transmission	W39045	1	1969-1984, Turbo Hydra-Matic 250, 350 M31, M33, M38, MV4, MX2 Transmission	W39348	1
1977-1987, Turbo Hydra-Matic 200 M29, MV9 Transmission, Tuff-Cork	W39045TC	1	1969-1984, Turbo Hydra-Matic 250, 350 M31, M33, M38, MV4, MX2 Transmission, Tuff-Cork	W39348TC	1
1971-1984, Turbo Hydra-Matic 250, 350 M31, M33, M38, MV4, MX2 Transmission, Tuff-Cork	W39348TC	1	1968-1980, Turbo Hydra-Matic 375, 400 M40 Transmission	W39341	1
1971-1980, Turbo Hydra-Matic 375, 400 M40 Transmission	W39341	1	1968-1980, Turbo Hydra-Matic 375, 400 M40 Transmission, Tuff-Cork	W39341TC	1
1971-1980, Turbo Hydra-Matic 375, 400 M40 Transmission, Tuff-Cork	W39341TC	1	Valve Body Cover Gasket		
CUSTOM STAR CHIEF			1994-1996, Turbo Hydra-Matic 4T60E M13 Transaxle, Tuff-Cork	W39373TC	1
Transmission Gasket Set			1993, Turbo Hydra-Matic 3T40 MD9 Transaxle, Tuff-Cork	W39368TC	1
1961, 4 Speed Transmission	TS27075W	1	1989-1993, Turbo Hydra-Matic 440 T4 ME9 Transaxle, Turbo Hydra-Matic 4T60E M13 Transaxle, Tuff-Cork	W39373TC	1
CUTLASS			1987-1996, Turbo Hydra-Matic 125 M34, MD9 Transaxle, Tuff-Cork	W39368TC	1
Transaxle Pan Gasket			1987-1988, Turbo Hydra-Matic 440 T4 ME9 Transaxle, Tuff-Cork	W39373TC	1
1994-1996, Turbo Hydra-Matic 4T60E M13 Transaxle, Tuff-Cork	W31180TC	1	1983-1984, Turbo Hydra-Matic 440 T4 ME9 Transaxle, Tuff-Cork	W39373TC	1
1993, Turbo Hydra-Matic 3T40 MD9 Transaxle, Tuff-Cork	W39356TC	1			
1987-1996, Turbo Hydra-Matic 125 M34, MD9 Transaxle, Tuff-Cork	W39356TC	1			

Transmission Gaskets (cont.)

<i>Model & Application</i>	<i>Part No.</i>	<i>Qty.</i>	<i>Model & Application</i>	<i>Part No.</i>	<i>Qty.</i>
CUTLASS (cont.)			CUTLASS SALON (cont.)		
Valve Body Cover Gasket (cont.)			Transmission Pan Gasket (cont.)		
1982-1984, Turbo Hydra-Matic 125 M34, MD9 Transaxle, Tuff-Cork.	W39368TC	1	1976-1980, Turbo Hydra-Matic 200 M29, MV9 Transmission.	W39045	1
CUTLASS 'S'			1976-1980, Turbo Hydra-Matic 200 M29, MV9 Transmission, Tuff-Cork.	W39045TC	1
Transmission Gasket Set			1975-1980, Turbo Hydra-Matic 250, 350 M31, M33, M38, MV4, MX2 Transmission.	W39348	1
1976-1977, 3 Speed Transmission	TS14737W	1	1975-1980, Turbo Hydra-Matic 250, 350 M31, M33, M38, MV4, MX2 Transmission, Tuff-Cork	W39348TC	1
1975-1977, 3 Speed Transmission, 4 Speed Transmission	TS14737W	1	1975-1980, Turbo Hydra-Matic 375, 400 M40 Transmission.	W39341	1
1974, 3 Speed Transmission	TS14737W	1	1975-1980, Turbo Hydra-Matic 375, 400 M40 Transmission, Tuff-Cork.	W39341TC	1
1972-1977, 3 Speed Transmission, 4 Speed Transmission	TS14737W	1	CUTLASS SUPREME		
1972, 3 Speed Transmission	TS14737W	1	Transaxle Pan Gasket		
1971-1972, 3 Speed Transmission, Except Heavy Duty Transmission.	TS14737W	1	1991-1995, Turbo Hydra-Matic 4T60E M13 Transaxle, Tuff-Cork.	W31180TC	1
1971, 3 Speed Transmission, Heavy Duty 3 Speed Transmission	TS27594	1	1989-1993, Turbo Hydra-Matic 440 T4 ME9 Transaxle, Tuff-Cork.	W39369TC	1
1968-1973, 4 Speed Transmission	TS27824	1	1988-1995, Turbo Hydra-Matic 125 M34, MD9 Transaxle, Tuff-Cork.	W39356TC	1
1968-1970, 3 Speed Transmission, Heavy Duty 3 Speed Transmission.	TS27817X	1	1982-1984, Turbo Hydra-Matic 125 M34, MD9 Transaxle, Tuff-Cork.	W39356TC	1
Transmission Pan Gasket			Transmission Gasket Set		
1976-1977, Turbo Hydra-Matic 200 M29, MV9 Transmission.	W39045	1	1974-1981, 3 Speed Transmission, 4 Speed Transmission	TS14737W	1
1976-1977, Turbo Hydra-Matic 200 M29, MV9 Transmission, Tuff-Cork.	W39045TC	1	1974-1975, 4 Speed Transmission	TS14737W	1
1969-1977, Turbo Hydra-Matic 250, 350 M31, M33, M38, MV4, MX2 Transmission.	W39348	1	1974, 3 Speed Transmission, 4 Speed Transmission	TS14737W	1
1969-1977, Turbo Hydra-Matic 250, 350 M31, M33, M38, MV4, MX2 Transmission, Tuff-Cork	W39348TC	1	1972-1975, 3 Speed Transmission	TS14737W	1
1968-1977, Turbo Hydra-Matic 375, 400 M40 Transmission.	W39341	1	1971-1972, 3 Speed Transmission, Except Heavy Duty Transmission.	TS14737W	1
1968-1977, Turbo Hydra-Matic 375, 400 M40 Transmission, Tuff-Cork.	W39341TC	1	1971, 3 Speed Transmission, Heavy Duty 3 Speed Transmission	TS27594	1
CUTLASS CIERA			1967-1973, 4 Speed Transmission	TS27824	1
Transaxle Pan Gasket			1967-1970, 3 Speed Transmission, Heavy Duty 3 Speed Transmission.	TS27817X	1
1994-1996, Turbo Hydra-Matic 4T60E M13 Transaxle, Tuff-Cork.	W31180TC	1	Transmission Pan Gasket		
1993-1996, Turbo Hydra-Matic 3T40 MD9 Transaxle, Tuff-Cork.	W39356TC	1	1988, Turbo Hydra-Matic 700-R4 MD8 Transmission.	W39365	1
1983-1988, Turbo Hydra-Matic 440 T4 ME9 Transaxle, Tuff-Cork.	W39369TC	1	1988, Turbo Hydra-Matic 700-R4 MD8 Transmission, Tuff-Cork.	W39365TC	1
1982-1996, Turbo Hydra-Matic 125 M34, MD9 Transaxle, Tuff-Cork.	W39356TC	1	1982-1986, Turbo Hydra-Matic 700-R4 MD8 Transmission.	W39365	1
Valve Body Cover Gasket			1982-1986, Turbo Hydra-Matic 700-R4 MD8 Transmission, Tuff-Cork.	W39365TC	1
1994-1996, Turbo Hydra-Matic 4T60E M13 Transaxle, Tuff-Cork.	W39373TC	1	1982-1985, Turbo Hydra-Matic 325 M32, M57 Transaxle.	W39355	1
1993-1996, Turbo Hydra-Matic 3T40 MD9 Transaxle, Tuff-Cork.	W39368TC	1	1981-1988, Turbo Hydra-Matic 200 4R MW9 Transmission	W39361	1
1989-1993, Turbo Hydra-Matic 440 T4 ME9 Transaxle, Turbo Hydra-Matic 4T60E M13 Transaxle, Tuff-Cork.	W39373TC	1	1981-1988, Turbo Hydra-Matic 200 4R MW9 Transmission, Tuff-Cork	W39361TC	1
1983-1990, Turbo Hydra-Matic 440 T4 ME9 Transaxle, Tuff-Cork.	W39373TC	1	1979-1985, Turbo Hydra-Matic 325 M32, M57 Transaxle, Tuff-Cork.	W39355TC	1
1982-1996, Turbo Hydra-Matic 125 M34, MD9 Transaxle, Tuff-Cork.	W39368TC	1	1979-1980, Turbo Hydra-Matic 325 M32, M57 Transaxle.	W39355	1
CUTLASS SALON			1976-1987, Turbo Hydra-Matic 200 M29, MV9 Transmission.	W39045	1
Transmission Gasket Set			1976-1987, Turbo Hydra-Matic 200 M29, MV9 Transmission, Tuff-Cork.	W39045TC	1
1975-1980, 3 Speed Transmission, 4 Speed Transmission.	TS14737W	1	1969-1984, Turbo Hydra-Matic 250, 350 M31, M33, M38, MV4, MX2 Transmission.	W39348	1
Transmission Pan Gasket			1969-1984, Turbo Hydra-Matic 250, 350 M31, M33, M38, MV4, MX2 Transmission, Tuff-Cork	W39348TC	1
1979-1980, Turbo Hydra-Matic 325 M32, M57 Transaxle.	W39355	1			
1979-1980, Turbo Hydra-Matic 325 M32, M57 Transaxle, Tuff-Cork.	W39355TC	1			

PASSENGER CAR

General Motors Corp. (cont.)

Transmission Gaskets (cont.)

<i>Model & Application</i>	<i>Part No.</i>	<i>Qty.</i>	<i>Model & Application</i>	<i>Part No.</i>	<i>Qty.</i>
CUTLASS SUPREME (cont.)			DEL RAY		
Transmission Pan Gasket (cont.)			Transmission Gasket Set		
1967-1980, Turbo Hydra-Matic 375, 400 M40 Transmission.	W39341	1	1958, 3 Speed Transmission, Contains Seals.	TS27011W	1
1967-1980, Turbo Hydra-Matic 375, 400 M40 Transmission, Tuff-Cork.	W39341TC	1	1958, 3 Speed Transmission, Seals Not Included.	TS27061	1
Valve Body Cover Gasket			1958, 4 Speed Transmission	TS27075W	1
1991-1995, Turbo Hydra-Matic 4T60E M13 Transaxle, Tuff-Cork.	W39373TC	1	Transmission Pan Gasket		
1989-1993, Turbo Hydra-Matic 440 T4 ME9 Transaxle, Turbo Hydra-Matic 4T60E M13 Transaxle, Tuff-Cork.	W39373TC	1	1958, Powerglide Transmission	W38765	1
1988-1995, Turbo Hydra-Matic 125 M34, MD9 Transaxle, Tuff-Cork.	W39368TC	1	DELMONT EIGHTY-EIGHT		
1983-1987, Turbo Hydra-Matic 440 T4 ME9 Transaxle, Tuff-Cork.	W39373TC	1	Transmission Gasket Set		
1982-1984, Turbo Hydra-Matic 125 M34, MD9 Transaxle, Tuff-Cork.	W39368TC	1	1968, 3 Speed Transmission, Heavy Duty 3 Speed Transmission	TS27817X	1
DEVILLE			1968, 4 Speed Transmission	TS27824	1
Transaxle Pan Gasket			Transmission Pan Gasket		
1991-1995, Turbo Hydra-Matic 4T60E M13 Transaxle, Tuff-Cork.	W31180TC	1	1968, Turbo Hydra-Matic 375, 400 M40 Transmission.	W39341	1
1985, Turbo Hydra-Matic 125C MD9 Transaxle, Tuff-Cork.	W39356TC	1	1968, Turbo Hydra-Matic 375, 400 M40 Transmission, Tuff-Cork.	W39341TC	1
1983-1990, Turbo Hydra-Matic 440 T4 ME9 Transaxle, Tuff-Cork.	W39369TC	1	DELMONT EIGHTY-EIGHT '330'		
Transmission Pan Gasket			Transmission Gasket Set		
1994-1995, Turbo Hydra-Matic 4L60E M30 Transmission.	W39365	1	1967, 3 Speed Transmission, Heavy Duty 3 Speed Transmission	TS27817X	1
1994-1995, Turbo Hydra-Matic 4L60E M30 Transmission, Tuff-Cork.	W39365TC	1	1967, 4 Speed Transmission	TS27824	1
1982-1985, Turbo Hydra-Matic 325 M32, M57 Transaxle.	W39355	1	DELMONT EIGHTY-EIGHT '425'		
1982-1985, Turbo Hydra-Matic 325 M32, M57 Transaxle, Tuff-Cork.	W39355TC	1	Transmission Gasket Set		
1981-1985, Turbo Hydra-Matic 200 4R MW9 Transmission	W39361	1	1967, 3 Speed Transmission, Heavy Duty 3 Speed Transmission	TS27817X	1
1981-1985, Turbo Hydra-Matic 200 4R MW9 Transmission, Tuff-Cork.	W39361TC	1	1967, 4 Speed Transmission	TS27824	1
1980-1985, Turbo Hydra-Matic 400 M40 Transmission.	W39341	1	Transmission Pan Gasket		
1980-1985, Turbo Hydra-Matic 400 M40 Transmission, Tuff-Cork.	W39341TC	1	1967, Turbo Hydra-Matic 375, 400 M40 Transmission.	W39341	1
1980-1984, Turbo Hydra-Matic 350 M33, MV4 Transmission.	W39348	1	1967, Turbo Hydra-Matic 375, 400 M40 Transmission, Tuff-Cork.	W39341TC	1
1980-1984, Turbo Hydra-Matic 350 M33, MV4 Transmission, Tuff-Cork.	W39348TC	1	DELTA 88		
1980-1981, Turbo Hydra-Matic 200 M29, MV9 Transmission.	W39045	1	Transmission Gasket Set		
1980-1981, Turbo Hydra-Matic 200 M29, MV9 Transmission, Tuff-Cork.	W39045TC	1	1981, 3 Speed Transmission, 4 Speed Transmission	TS14737W	1
1976-1977, Turbo Hydra-Matic 325 M32, M57 Transaxle.	W39355	1	1972-1979, 3 Speed Transmission, 4 Speed Transmission	TS14737W	1
1976-1977, Turbo Hydra-Matic 325 M32, M57 Transaxle, Tuff-Cork.	W39355TC	1	1971, 3 Speed Transmission, Except Heavy Duty Transmission.	TS14737W	1
1976-1977, Turbo Hydra-Matic 400 M40 Transmission.	W39341	1	1971, 3 Speed Transmission, Heavy Duty 3 Speed Transmission	TS27594	1
1976-1977, Turbo Hydra-Matic 400 M40 Transmission, Tuff-Cork.	W39341TC	1	1966-1970, 3 Speed Transmission, Heavy Duty 3 Speed Transmission.	TS27817X	1
Valve Body Cover Gasket			1965-1973, 4 Speed Transmission	TS27824	1
1991-1995, Turbo Hydra-Matic 4T60E M13 Transaxle, Tuff-Cork.	W39373TC	1	1965, 3 Speed Transmission	TS27011W	1
1985, Turbo Hydra-Matic 125C MD9 Transaxle, Tuff-Cork.	W39368TC	1	Transmission Pan Gasket		
1983-1990, Turbo Hydra-Matic 440 T4 ME9 Transaxle, Tuff-Cork.	W39373TC	1	1981-1983, Turbo Hydra-Matic 200 4R MW9 Transmission, Tuff-Cork.	W39361TC	1
			1981, Turbo Hydra-Matic 200 4R MW9 Transmission.	W39361	1
			1979-1981, Turbo Hydra-Matic 325 M32, M57 Transaxle, Tuff-Cork.	W39355TC	1
			1976-1981, Turbo Hydra-Matic 200 M29, MV9 Transmission.	W39045	1
			1976-1981, Turbo Hydra-Matic 200 M29, MV9 Transmission, Tuff-Cork.	W39045TC	1
			1969-1981, Turbo Hydra-Matic 250, 350 M31, M33, M38, MV4, MX2 Transmission.	W39348	1
			1969-1981, Turbo Hydra-Matic 250, 350 M31, M33, M38, MV4, MX2 Transmission, Tuff-Cork	W39348TC	1

Transmission Gaskets (cont.)

<i>Model & Application</i>	<i>Part No.</i>	<i>Qty.</i>	<i>Model & Application</i>	<i>Part No.</i>	<i>Qty.</i>
DELTA 88 (cont.)			DYNAMIC 88		
Transmission Pan Gasket (cont.)			Transmission Gasket Set		
1965-1980, Turbo Hydra-Matic 375, 400 M40 Transmission.	W39341	1	1966, 3 Speed Transmission, Heavy Duty 3 Speed Transmission	TS27817X	1
1965-1980, Turbo Hydra-Matic 375, 400 M40 Transmission, Tuff-Cork.	W39341TC	1	1965-1966, 4 Speed Transmission	TS27824	1
DELTA 88 ROYALE			1965, 3 Speed Transmission		
Transaxle Pan Gasket			TS27011W		
1986-1988, Turbo Hydra-Matic 440 T4 ME9 Transaxle, Tuff-Cork.	W39369TC	1	Transmission Pan Gasket		
1986, Turbo Hydra-Matic 125 M34, MD9 Transaxle, Tuff-Cork.	W39356TC	1	1965-1966, Turbo Hydra-Matic 375, 400 M40 Transmission.		
Transmission Gasket Set			W39341		
1981, 3 Speed Transmission	TS14737W	1	1965-1966, Turbo Hydra-Matic 375, 400 M40 Transmission, Tuff-Cork.		
1972-1979, 3 Speed Transmission, 4 Speed Transmission	TS14737W	1	W39341TC		
1972, 3 Speed Transmission	TS14737W	1	ELDORADO		
1971, 3 Speed Transmission, Except Heavy Duty Transmission.	TS14737W	1	Transaxle Pan Gasket		
1971, 3 Speed Transmission, Heavy Duty 3 Speed Transmission	TS27594	1	1991-1993, Turbo Hydra-Matic 4T60E M13 Transaxle, Tuff-Cork.		
1969-1973, 4 Speed Transmission	TS27824	1	W31180TC		
1969-1970, 3 Speed Transmission, Heavy Duty 3 Speed Transmission.	TS27817X	1	1986-1990, Turbo Hydra-Matic 440 T4 ME9 Transaxle, Tuff-Cork.		
Transmission Pan Gasket			W39369TC		
1982-1985, Turbo Hydra-Matic 700-R4 MD8 Transmission.	W39365	1	Transmission Pan Gasket		
1982-1985, Turbo Hydra-Matic 700-R4 MD8 Transmission, Tuff-Cork.	W39365TC	1	1979-1985, Turbo Hydra-Matic 325 M32, M57 Transaxle.		
1981-1985, Turbo Hydra-Matic 200 4R MW9 Transmission	W39361	1	W39355		
1981-1985, Turbo Hydra-Matic 200 4R MW9 Transmission, Tuff-Cork.	W39361TC	1	1979-1985, Turbo Hydra-Matic 325 M32, M57 Transaxle, Tuff-Cork.		
1979-1985, Turbo Hydra-Matic 325 M32, M57 Transaxle, Tuff-Cork.	W39355TC	1	W39355TC		
1976-1985, Turbo Hydra-Matic 200 M29, MV9 Transmission.	W39045	1	1967-1978, Turbo Hydra-Matic 400 M40 Transmission.		
1976-1985, Turbo Hydra-Matic 200 M29, MV9 Transmission, Tuff-Cork.	W39045TC	1	W39347		
1969-1984, Turbo Hydra-Matic 250, 350 M31, M33, M38, MV4, MX2 Transmission.	W39348	1	Valve Body Cover Gasket		
1969-1984, Turbo Hydra-Matic 250, 350 M31, M33, M38, MV4, MX2 Transmission, Tuff-Cork	W39348TC	1	1991-1993, Turbo Hydra-Matic 4T60E M13 Transaxle, Tuff-Cork.		
1969-1980, Turbo Hydra-Matic 375, 400 M40 Transmission.	W39341	1	W39373TC		
1969-1980, Turbo Hydra-Matic 375, 400 M40 Transmission, Tuff-Cork.	W39341TC	1	1986-1990, Turbo Hydra-Matic 440 T4 ME9 Transaxle, Tuff-Cork.		
Valve Body Cover Gasket			W39373TC		
1986, Turbo Hydra-Matic 125 M34, MD9 Transaxle, Tuff-Cork.	W39368TC	1	ELDORADO SPECIAL		
1983-1988, Turbo Hydra-Matic 440 T4 ME9 Transaxle, Tuff-Cork.	W39373TC	1	Transmission Pan Gasket		
DELUXE			1964, Turbo Hydra-Matic 400 M40 Transmission.		
Transmission Gasket Set			W39341		
1949-1952, 3 Speed Transmission	TS26250X	1	1964, Turbo Hydra-Matic 400 M40 Transmission, Tuff-Cork.		
DELUXE 210			W39341TC		
Transmission Gasket Set			ELECTRA		
1957, 4 Speed Transmission	TS27075W	1	Transaxle Pan Gasket		
1956-1957, 3 Speed Transmission, Seals Not Included.	TS27061	1	1983-1990, Turbo Hydra-Matic 440 ME9 Transaxle, Tuff-Cork.		
1955-1957, 3 Speed Transmission, Contains Seals.	TS27011W	1	W39369TC		
1953-1954, 3 Speed Transmission	TS26250X	1	Transmission Pan Gasket		
			1987, Turbo Hydra-Matic 200 4R MW9 Transmission.		
			W39361		
			1987, Turbo Hydra-Matic 200 4R MW9 Transmission, Tuff-Cork.		
			W39361TC		
			1987, Turbo Hydra-Matic 200 M29, MV9 Transmission.		
			W39045		
			1987, Turbo Hydra-Matic 200 M29, MV9 Transmission, Tuff-Cork.		
			W39045TC		
			1984, Turbo Hydra-Matic 700-R4 MD8 Transmission.		
			W39365		
			1984, Turbo Hydra-Matic 700-R4 MD8 Transmission, Tuff-Cork.		
			W39365TC		
			1981-1984, Turbo Hydra-Matic 200 4R MW9 Transmission		
			W39361		
			1981-1984, Turbo Hydra-Matic 200 4R MW9 Transmission, Tuff-Cork.		
			W39361TC		
			1979-1986, Turbo Hydra-Matic 325 M32, M57 Transaxle.		
			W39355		
			1979-1986, Turbo Hydra-Matic 325 M32, M57 Transaxle, Tuff-Cork.		
			W39355TC		
			1978-1984, Turbo Hydra-Matic 250C M38 Transmission, Turbo Hydra-Matic 350, 375 M31, M33, MV4, MX2, MX5 Transmission.		
			W39348		

PASSENGER CAR

General Motors Corp. (cont.)

Transmission Gaskets (cont.)

<i>Model & Application</i>	<i>Part No.</i>	<i>Qty.</i>	<i>Model & Application</i>	<i>Part No.</i>	<i>Qty.</i>
ELECTRA (cont.)			ELECTRA ESTATE WAGON (cont.)		
Transmission Pan Gasket (cont.)			Transmission Pan Gasket (cont.)		
1978-1984, Turbo Hydra-Matic 250C M38 Transmission, Turbo Hydra-Matic 350, 375 M31, M33, MV4, MX2, MX5 Transmission, Tuff-Cork	W39348TC	1	1986, Turbo Hydra-Matic 200 4R MW9 Transmission, Tuff-Cork.	W39361TC	1
1978-1979, Turbo Hydra-Matic 350, 375 M31, M33, MV4, MX2, MX5 Transmission.	W39348	1	1986, Turbo Hydra-Matic 200 M29, MV9 Transmission.	W39045	1
1978-1979, Turbo Hydra-Matic 350, 375 M31, M33, MV4, MX2, MX5 Transmission, Tuff-Cork	W39348TC	1	1986, Turbo Hydra-Matic 200 M29, MV9 Transmission, Tuff-Cork.	W39045TC	1
1977-1985, Turbo Hydra-Matic 200 M29, MV9 Transmission.	W39045	1	1986, Turbo Hydra-Matic 325 M32, M57 Transaxle.	W39355	1
1977-1985, Turbo Hydra-Matic 200 M29, MV9 Transmission, Tuff-Cork.	W39045TC	1	1986, Turbo Hydra-Matic 325 M32, M57 Transaxle, Tuff-Cork.	W39355TC	1
1977-1980, Turbo Hydra-Matic 250C M38 Transmission, Turbo Hydra-Matic 350, 375 M31, M33, MV4, MX2, MX5 Transmission.	W39348	1	1981, Turbo Hydra-Matic 200 4R MW9 Transmission.	W39361	1
1977-1980, Turbo Hydra-Matic 250C M38 Transmission, Turbo Hydra-Matic 350, 375 M31, M33, MV4, MX2, MX5 Transmission, Tuff-Cork	W39348TC	1	1981, Turbo Hydra-Matic 200 4R MW9 Transmission, Tuff-Cork.	W39361TC	1
1976-1981, Turbo Hydra-Matic 400 M40 Transmission.	W39341	1	1981, Turbo Hydra-Matic 325 M32, M57 Transaxle.	W39355	1
1976-1981, Turbo Hydra-Matic 400 M40 Transmission, Tuff-Cork.	W39341TC	1	1980-1981, Turbo Hydra-Matic 200 M29, MV9 Transmission.	W39045	1
1976-1979, Turbo Hydra-Matic 350, 375 M31, M33, MV4, MX2, MX5 Transmission.	W39348	1	1980-1981, Turbo Hydra-Matic 200 M29, MV9 Transmission, Tuff-Cork.	W39045TC	1
1976-1979, Turbo Hydra-Matic 350, 375 M31, M33, MV4, MX2, MX5 Transmission, Tuff-Cork	W39348TC	1	1980-1981, Turbo Hydra-Matic 250C M38 Transmission, Turbo Hydra-Matic 350, 375 M31, M33, MV4, MX2, MX5 Transmission.	W39348	1
Valve Body Cover Gasket			1980-1981, Turbo Hydra-Matic 250C M38 Transmission, Turbo Hydra-Matic 350, 375 M31, M33, MV4, MX2, MX5 Transmission, Tuff-Cork	W39348TC	1
1983-1990, Turbo Hydra-Matic 440 ME9 Transaxle, Tuff-Cork.	W39373TC	1	1980-1981, Turbo Hydra-Matic 325 M32, M57 Transaxle, Tuff-Cork.	W39355TC	1
1982-1985, Turbo Hydra-Matic 125 M34, MD9 Transaxle, Turbo Hydra-Matic 125C MD9 Transaxle, Tuff-Cork.	W39368TC	1	1980-1981, Turbo Hydra-Matic 400 M40 Transmission.	W39341	1
ELECTRA 225			1980-1981, Turbo Hydra-Matic 400 M40 Transmission, Tuff-Cork.	W39341TC	1
Transmission Gasket Set			ESTATE WAGON		
1971-1976, 3 Speed Transmission	TS14737W	1	Transmission Gasket Set		
1970, 3 Speed Transmission, Floor Shift	TS27594	1	1970, 3 Speed Transmission, Floor Shift	TS27594	1
1966, 3 Speed Transmission, Column Shift	TS27817X	1	Transmission Pan Gasket		
1966, 4 Speed Transmission	TS27075W	1	1980, Turbo Hydra-Matic 250C M38 Transmission.	W39348	1
1965, 3 Speed Transmission, 4 Speed Transmission, Floor Shift.	TS27075W	1	1978-1980, Turbo Hydra-Matic 250C M38 Transmission, Turbo Hydra-Matic 350, 375 M31, M33, MV4, MX2, MX5 Transmission.	W39348	1
1964-1965, 3 Speed Transmission, Column Shift	TS27011W	1	1977-1980, Turbo Hydra-Matic 200 M29, MV9 Transmission.	W39045	1
1964, 3 Speed Transmission, Floor Shift	TS27075W	1	1977-1980, Turbo Hydra-Matic 200 M29, MV9 Transmission, Tuff-Cork.	W39045TC	1
1961-1963, 3 Speed Transmission	TS27817X	1	1977-1980, Turbo Hydra-Matic 250C M38 Transmission, Turbo Hydra-Matic 350, 375 M31, M33, MV4, MX2, MX5 Transmission, Tuff-Cork	W39348TC	1
1961-1963, 4 Speed Transmission	TS27075Z	1	1976-1980, Turbo Hydra-Matic 350, 375 M31, M33, MV4, MX2, MX5 Transmission.	W39348	1
Transmission Pan Gasket			1976-1980, Turbo Hydra-Matic 400 M40 Transmission.	W39341	1
1970-1976, Turbo Hydra-Matic 350, 375 M31, M33, MV4, MX2, MX5 Transmission.	W39348	1	1976-1980, Turbo Hydra-Matic 400 M40 Transmission, Tuff-Cork.	W39341TC	1
1970-1976, Turbo Hydra-Matic 350, 375 M31, M33, MV4, MX2, MX5 Transmission, Tuff-Cork	W39348TC	1	1976-1979, Turbo Hydra-Matic 350, 375 M31, M33, MV4, MX2, MX5 Transmission, Tuff-Cork	W39348TC	1
1964-1976, Turbo Hydra-Matic 400 M40 Transmission.	W39341	1	1970-1972, Turbo Hydra-Matic 350, 375 M31, M33, MV4, MX2, MX5 Transmission.	W39348	1
1964-1976, Turbo Hydra-Matic 400 M40 Transmission, Tuff-Cork.	W39341TC	1	1970-1972, Turbo Hydra-Matic 350, 375 M31, M33, MV4, MX2, MX5 Transmission, Tuff-Cork	W39348TC	1
1961-1963, Dual Path Automatic Transmission.	W39108	1	1970-1972, Turbo Hydra-Matic 400 M40 Transmission.	W39341	1
ELECTRA ESTATE WAGON					
Transmission Pan Gasket					
1986, Turbo Hydra-Matic 200 4R MW9 Transmission.	W39361	1			

Transmission Gaskets (cont.)				
Model & Application	Part No.	Qty.	Model & Application	Part No. Qty.
ESTATE WAGON (cont.)			FIREBIRD	
Transmission Pan Gasket (cont.)			Transmission Gasket Set	
1970-1972, Turbo Hydra-Matic 400 M40 Transmission, Tuff-Cork.	W39341TC	1	1979-1981, Saginaw 3 Speed Transmission, Saginaw 4 Speed Transmission	TS14737W 1
EXECUTIVE			1979, Saginaw 3 Speed Transmission	TS14737W 1
Transmission Gasket Set			1977-1981, Saginaw 3 Speed Transmission, Saginaw 4 Speed Transmission	TS14737W 1
1970, Heavy Duty 3 Speed Transmission, Saginaw 3 Speed Transmission, Saginaw 4 Speed Transmission.	TS14737W	1	1977, Saginaw 4 Speed Transmission	TS14737W 1
1970, Muncie 3 Speed Transmission	TS27594	1	1971-1981, Saginaw 3 Speed Transmission, Saginaw 4 Speed Transmission	TS14737W 1
1970, Muncie 4 Speed Transmission	TS27824W	1	1970-1981, Muncie 3 Speed Transmission	TS27594 1
1969-1970, Muncie 3 Speed Transmission, Muncie 4 Speed Transmission	TS27594	1	1970-1981, Muncie 4 Speed Transmission	TS27824W 1
1969, 3 Speed Transmission, Except Saginaw 3 Speed Transmission	TS27817X	1	1970, Heavy Duty 3 Speed Transmission, Saginaw 3 Speed Transmission, Saginaw 4 Speed Transmission.	TS14737W 1
1969, Muncie 4 Speed Transmission	TS27594	1	1969-1970, Muncie 3 Speed Transmission, Muncie 4 Speed Transmission	TS27594 1
1968, 3 Speed Transmission, Heavy Duty 3 Speed Transmission	TS27817X	1	1969, 3 Speed Transmission, Except Saginaw 3 Speed Transmission	TS27817X 1
1967-1970, Saginaw 4 Speed Transmission	TS14737W	1	1969, Muncie 4 Speed Transmission	TS27594 1
1967-1969, Except Heavy Duty Transmission, Saginaw 3 Speed Transmission	TS14737W	1	1968-1969, 3 Speed Transmission, Except Saginaw 3 Speed Transmission, Heavy Duty 3 Speed Transmission.	TS27817X 1
1967-1968, Muncie 4 Speed Transmission	TS27824	1	1968-1969, Except Heavy Duty Transmission, Saginaw 3 Speed Transmission, Saginaw 4 Speed Transmission	TS14737W 1
1967, 3 Speed Transmission, Except Heavy Duty Transmission, Except Saginaw 3 Speed Transmission	TS27817X	1	1968, 3 Speed Transmission, Heavy Duty 3 Speed Transmission	TS27817X 1
Transmission Pan Gasket			1967-1970, Saginaw 4 Speed Transmission	TS14737W 1
1969-1970, Turbo Hydra-Matic 250, 350, 375 M31, M33, M38, VMV4, MX2, MX3 Transmission.	W39348	1	1967-1969, Except Heavy Duty Transmission, Saginaw 3 Speed Transmission	TS14737W 1
1969-1970, Turbo Hydra-Matic 250, 350, 375 M31, M33, M38, VMV4, MX2, MX3 Transmission, Tuff-Cork.	W39348TC	1	1967-1968, Muncie 4 Speed Transmission	TS27824 1
1969-1970, Turbo Hydra-Matic 375, 400 M40 Transmission.	W39341	1	1967, 3 Speed Transmission, Except Heavy Duty Transmission, Except Saginaw 3 Speed Transmission	TS27817X 1
1969-1970, Turbo Hydra-Matic 375, 400 M40 Transmission, Tuff-Cork.	W39341TC	1	1967-1969, Except Heavy Duty Transmission, Saginaw 3 Speed Transmission, Saginaw 4 Speed Transmission.	TS14737W 1
1967-1970, Automatic M35 Transmission	W39007	1	1967-1968, Muncie 4 Speed Transmission	TS27824 1
F-85			1967, 3 Speed Transmission, Except Heavy Duty Transmission, Except Saginaw 3 Speed Transmission	TS27817X 1
Transmission Gasket Set			1967, Except Heavy Duty Transmission, Saginaw 3 Speed Transmission, Saginaw 4 Speed Transmission.	TS14737W 1
1972, 3 Speed Transmission	TS14737W	1	Transmission Pan Gasket	
1971-1972, 3 Speed Transmission, Except Heavy Duty Transmission.	TS14737W	1	1997-2002, Turbo Hydra-Matic 4L60E M30 Transmission.	W39365 1
1971, 3 Speed Transmission, Heavy Duty 3 Speed Transmission	TS27594	1	1997-2002, Turbo Hydra-Matic 4L60E M30 Transmission, Tuff-Cork.	W39365TC 1
1966-1970, Except Heavy Duty Transmission.	TS14737W	1	1983-1995, Turbo Hydra-Matic 700-R4 MD8 Transmission.	W39365 1
1965	TS27817X	1	1983-1995, Turbo Hydra-Matic 700-R4 MD8 Transmission, Tuff-Cork.	W39365TC 1
1965, 3 Speed Transmission	TS27061	1	1981, Turbo Hydra-Matic 200 4R MW9 Transmission.	W39361 1
1964-1972, 4 Speed Transmission	TS27824	1	1981, Turbo Hydra-Matic 200 4R MW9 Transmission, Tuff-Cork.	W39361TC 1
1964	TS27011W	1	1977-1984, Turbo Hydra-Matic 200 M29, MV9 Transmission.	W39045 1
Transmission Pan Gasket			1977-1984, Turbo Hydra-Matic 200 M29, MV9 Transmission, Tuff-Cork.	W39045TC 1
1969-1972, Turbo Hydra-Matic 250, 350 M31, M33, M38, MV4, MX2 Transmission.	W39348	1	1969-1983, Turbo Hydra-Matic 250, 350, 375 M31, M33, M38, VMV4, MX2, MX3 Transmission.	W39348 1
1969-1972, Turbo Hydra-Matic 250, 350 M31, M33, M38, MV4, MX2 Transmission, Tuff-Cork	W39348TC	1	1969-1983, Turbo Hydra-Matic 250, 350, 375 M31, M33, M38, VMV4, MX2, MX3 Transmission, Tuff-Cork.	W39348TC 1
1968-1972, Turbo Hydra-Matic 375, 400 M40 Transmission.	W39341	1	1969-1977, Turbo Hydra-Matic 375, 400 M40 Transmission.	W39341 1
1968-1972, Turbo Hydra-Matic 375, 400 M40 Transmission, Tuff-Cork.	W39341TC	1	1969-1977, Turbo Hydra-Matic 375, 400 M40 Transmission, Tuff-Cork.	W39341TC 1
1965-1966, Turbo Hydra-Matic 375, 400 M40 Transmission.	W39341	1	1967-1973, Automatic M35 Transmission	W39007 1
1965-1966, Turbo Hydra-Matic 375, 400 M40 Transmission, Tuff-Cork.	W39341TC	1		

PASSENGER CAR

General Motors Corp. (cont.)

Transmission Gaskets (cont.)

<i>Model & Application</i>	<i>Part No.</i>	<i>Qty.</i>	<i>Model & Application</i>	<i>Part No.</i>	<i>Qty.</i>
FIREFLY			FLEETWOOD (cont.)		
Transmission Pan Gasket			Valve Body Cover Gasket		
1994, Automatic Transmission	W38031	1	1991-1993, Turbo Hydra-Matic 4T60E M13 Transaxle, Tuff-Cork	W39373TC	1
1985-1991, Automatic Transmission	W38031	1	1985, Turbo Hydra-Matic 125C MD9 Transaxle, Tuff-Cork	W39368TC	1
FIRENZA			1983-1990, Turbo Hydra-Matic 440 T4 ME9 Transaxle, Tuff-Cork		
Transaxle Pan Gasket			1983-1990, Turbo Hydra-Matic 440 T4 ME9 Transaxle, Tuff-Cork		
1983-1987, Turbo Hydra-Matic 125 M34, MD9 Transaxle, Tuff-Cork	W39356TC	1	FLEETWOOD 75		
Valve Body Cover Gasket			Transmission Pan Gasket		
1982-1987, Turbo Hydra-Matic 125 M34, MD9 Transaxle, Tuff-Cork	W39368TC	1	1981-1983, Turbo Hydra-Matic 200 4R MW9 Transmission		
FLEETLINE			1981-1983, Turbo Hydra-Matic 200 4R MW9 Transmission, Tuff-Cork		
Transmission Gasket Set			1980-1983, Turbo Hydra-Matic 350 M33, MV4 Transmission		
1946-1947, 3 Speed Transmission	TS26250X	1	1980-1983, Turbo Hydra-Matic 350 M33, MV4 Transmission, Tuff-Cork		
1941-1942, 3 Speed Transmission	TS26250X	1	1978-1981, Turbo Hydra-Matic 200 M29, MV9 Transmission		
FLEETMASTER			1978-1981, Turbo Hydra-Matic 200 M29, MV9 Transmission, Tuff-Cork		
Transmission Gasket Set			1975-1976, Turbo Hydra-Matic 325 M32, M57 Transaxle		
1946-1947, 3 Speed Transmission	TS26250X	1	1975-1976, Turbo Hydra-Matic 325 M32, M57 Transaxle, Tuff-Cork		
1942, 3 Speed Transmission	TS26250X	1	1964-1983, Turbo Hydra-Matic 400 M40 Transmission		
FLEETWOOD			1964-1983, Turbo Hydra-Matic 400 M40 Transmission, Tuff-Cork		
Transaxle Pan Gasket			FLEETWOOD SPECIAL		
1991-1992, Turbo Hydra-Matic 4T60E M13 Transaxle, Tuff-Cork	W31180TC	1	Transmission Pan Gasket		
1983-1990, Turbo Hydra-Matic 440 T4 ME9 Transaxle, Tuff-Cork	W39369TC	1	1975, Turbo Hydra-Matic 325 M32, M57 Transaxle		
Transmission Pan Gasket			1975, Turbo Hydra-Matic 325 M32, M57 Transaxle, Tuff-Cork		
1994-1996, Turbo Hydra-Matic 4L60E M30 Transmission, Turbo Hydra-Matic 700-R4 MD8 Transmission	W39365	1	1964-1975, Turbo Hydra-Matic 400 M40 Transmission		
1994-1995, Turbo Hydra-Matic 4L60E M30 Transmission, Turbo Hydra-Matic 700-R4 MD8 Transmission, Tuff-Cork	W39365TC	1	1964-1975, Turbo Hydra-Matic 400 M40 Transmission, Tuff-Cork		
1991-1993, 8-1/2" Ring Gear, 10 Bolt Holes, Tuff-Cork	P27857TC	1	GTO		
1990-1993, Turbo Hydra-Matic 700-R4 MD8 Transmission	W39365	1	Transmission Gasket Set		
1990-1993, Turbo Hydra-Matic 700-R4 MD8 Transmission, Tuff-Cork	W39365TC	1	1970, Heavy Duty 3 Speed Transmission, Saginaw 3 Speed Transmission		
1981-1990, Turbo Hydra-Matic 200 4R MW9 Transmission	W39361	1	1970, Muncie 4 Speed Transmission		
1981-1990, Turbo Hydra-Matic 200 4R MW9 Transmission, Tuff-Cork	W39361TC	1	1969-1970, Muncie 3 Speed Transmission, Muncie 4 Speed Transmission		
1980-1985, Turbo Hydra-Matic 350 M33, MV4 Transmission	W39348	1	1969, 3 Speed Transmission, Except Saginaw 3 Speed Transmission		
1980-1985, Turbo Hydra-Matic 350 M33, MV4 Transmission, Tuff-Cork	W39348TC	1	1968, 3 Speed Transmission, Heavy Duty 3 Speed Transmission		
1979-1981, Turbo Hydra-Matic 200 M29, MV9 Transmission	W39045	1	1967-1970, Saginaw 4 Speed Transmission		
1979-1981, Turbo Hydra-Matic 200 M29, MV9 Transmission, Tuff-Cork	W39045TC	1	1967-1969, Except Heavy Duty Transmission, Saginaw 3 Speed Transmission		
1976-1990, Turbo Hydra-Matic 400 M40 Transmission	W39341	1	1967-1968, 3 Speed Transmission, Except Heavy Duty Transmission, Except Saginaw 3 Speed Transmission, Heavy Duty 3 Speed Transmission		
1976-1990, Turbo Hydra-Matic 400 M40 Transmission, Tuff-Cork	W39341TC	1	1967-1968, Except Heavy Duty Transmission, Saginaw 3 Speed Transmission, Saginaw 4 Speed Transmission		
1976, Turbo Hydra-Matic 325 M32, M57 Transaxle	W39355	1	1967-1968, Muncie 4 Speed Transmission		
1976, Turbo Hydra-Matic 325 M32, M57 Transaxle, Tuff-Cork	W39355TC	1			
1965-1966, Turbo Hydra-Matic 400 M40 Transmission	W39341	1			
1965-1966, Turbo Hydra-Matic 400 M40 Transmission, Tuff-Cork	W39341TC	1			

Transmission Gaskets (cont.)				
Model & Application	Part No.	Qty.	Model & Application	Part No. Qty.
GTO (cont.)			GRAND AM (cont.)	
Transmission Gasket Set (cont.)			Transmission Pan Gasket (cont.)	
1967, 3 Speed Transmission, Except Heavy Duty Transmission, Except Saginaw 3 Speed Transmission	TS27817X	1	1978-1980, Turbo Hydra-Matic 200 M29, MV9 Transmission, Tuff-Cork	W39045TC 1
Transmission Pan Gasket			1978-1980, Turbo Hydra-Matic 250, 350, 375 M31, M33, M38, VMV4, MX2, MX3 Transmission	W39348 1
1969-1970, Turbo Hydra-Matic 250, 350, 375 M31, M33, M38, VMV4, MX2, MX3 Transmission	W39348	1	1978-1980, Turbo Hydra-Matic 250, 350, 375 M31, M33, M38, VMV4, MX2, MX3 Transmission, Tuff-Cork	W39348TC 1
1969-1970, Turbo Hydra-Matic 250, 350, 375 M31, M33, M38, VMV4, MX2, MX3 Transmission, Tuff-Cork	W39348TC	1	1973-1975, Turbo Hydra-Matic 250, 350, 375 M31, M33, M38, VMV4, MX2, MX3 Transmission	W39348 1
1969-1970, Turbo Hydra-Matic 375, 400 M40 Transmission	W39341	1	1973-1975, Turbo Hydra-Matic 250, 350, 375 M31, M33, M38, VMV4, MX2, MX3 Transmission, Tuff-Cork	W39348TC 1
1969-1970, Turbo Hydra-Matic 375, 400 M40 Transmission, Tuff-Cork	W39341TC	1	1973-1975, Turbo Hydra-Matic 375, 400 M40 Transmission	W39341 1
1967-1970, Automatic M35 Transmission	W39007	1	1973-1975, Turbo Hydra-Matic 375, 400 M40 Transmission, Tuff-Cork	W39341TC 1
GRAN SPORT			1973, Automatic M35 Transmission	W39007 1
Transmission Gasket Set			Valve Body Cover Gasket	
1971, 3 Speed Transmission	TS14737W	1	1994-1996, Turbo Hydra-Matic 4T60E M13 Transaxle, Tuff-Cork	W39373TC 1
1970, 3 Speed Transmission, Floor Shift	TS27594	1	1992-1993, Turbo Hydra-Matic 440 T4 ME9 Transaxle, Turbo Hydra-Matic 4T60E M13 Transaxle, Tuff-Cork	W39373TC 1
Transmission Pan Gasket			1986-1987, Turbo Hydra-Matic 440 T4 ME9 Transaxle, Tuff-Cork	W39373TC 1
1970-1971, Turbo Hydra-Matic 350, 375 M31, M33, MV4, MX2, MX5 Transmission	W39348	1	1985-1995, Turbo Hydra-Matic 125 M34, MD9 Transaxle, Tuff-Cork	W39368TC 1
1970-1971, Turbo Hydra-Matic 350, 375 M31, M33, MV4, MX2, MX5 Transmission, Tuff-Cork	W39348TC	1	GRAND PRIX	
1970-1971, Turbo Hydra-Matic 400 M40 Transmission	W39341	1	Transaxle Pan Gasket	
1970-1971, Turbo Hydra-Matic 400 M40 Transmission, Tuff-Cork	W39341TC	1	1991-1996, Turbo Hydra-Matic 4T60E M13 Transaxle, Tuff-Cork	W31180TC 1
GRAN SPORT 455			1989-1993, Turbo Hydra-Matic 440 T4 ME9 Transaxle, Tuff-Cork	W39369TC 1
Transmission Gasket Set			1988-1995, Turbo Hydra-Matic 125 M34, MD9 Transaxle, Tuff-Cork	W39356TC 1
1971-1972, 3 Speed Transmission	TS14737W	1	Transmission Gasket Set	
1970, 3 Speed Transmission, Floor Shift	TS27594	1	1976-1981, Muncie 4 Speed Transmission	TS27824W 1
Transmission Pan Gasket			1976-1981, Saginaw 3 Speed Transmission, Saginaw 4 Speed Transmission	TS14737W 1
1970-1972, Turbo Hydra-Matic 350, 375 M31, M33, MV4, MX2, MX5 Transmission	W39348	1	1975-1976, Saginaw 3 Speed Transmission	TS14737W 1
1970-1972, Turbo Hydra-Matic 350, 375 M31, M33, MV4, MX2, MX5 Transmission, Tuff-Cork	W39348TC	1	1975, Saginaw 3 Speed Transmission, Saginaw 4 Speed Transmission	TS14737W 1
1970-1972, Turbo Hydra-Matic 400 M40 Transmission	W39341	1	1972, Saginaw 4 Speed Transmission	TS14737W 1
1970-1972, Turbo Hydra-Matic 400 M40 Transmission, Tuff-Cork	W39341TC	1	1971-1976, Saginaw 3 Speed Transmission, Saginaw 4 Speed Transmission	TS14737W 1
GRAND AM			1971, Saginaw 3 Speed Transmission	TS14737W 1
Transaxle Pan Gasket			1970-1981, Muncie 3 Speed Transmission	TS27594 1
1992-1996, Turbo Hydra-Matic 4T60E M13 Transaxle, Tuff-Cork	W31180TC	1	1970-1974, Muncie 4 Speed Transmission	TS27824W 1
1985-1995, Turbo Hydra-Matic 125 M34, MD9 Transaxle, Tuff-Cork	W39356TC	1	1970, Heavy Duty 3 Speed Transmission, Saginaw 3 Speed Transmission	TS14737W 1
Transmission Gasket Set			1969, 3 Speed Transmission, Except Saginaw 3 Speed Transmission	TS27817X 1
1978-1980, Muncie 3 Speed Transmission	TS27594	1	1969, Muncie 4 Speed Transmission	TS27594 1
1978-1980, Muncie 4 Speed Transmission	TS27824W	1	1968, 3 Speed Transmission, Heavy Duty 3 Speed Transmission	TS27817X 1
1978-1980, Saginaw 3 Speed Transmission, Saginaw 4 Speed Transmission	TS14737W	1	1967-1971, Saginaw 4 Speed Transmission	TS14737W 1
1973-1975, Muncie 3 Speed Transmission	TS27594	1	1967-1969, Except Heavy Duty Transmission, Saginaw 3 Speed Transmission	TS14737W 1
1973-1975, Saginaw 3 Speed Transmission, Saginaw 4 Speed Transmission	TS14737W	1	1967, 3 Speed Transmission, Except Heavy Duty Transmission, Except Saginaw 3 Speed Transmission	TS27817X 1
1973-1974, Muncie 4 Speed Transmission	TS27824W	1	1966, 3 Speed Transmission, Except Saginaw 3 Speed Transmission	TS27817X 1
Transmission Pan Gasket				
1978-1980, Turbo Hydra-Matic 200 M29, MV9 Transmission	W39045	1		

PASSENGER CAR

General Motors Corp. (cont.)

Transmission Gaskets (cont.)

Model & Application	Part No.	Qty.	Model & Application	Part No.	Qty.
GRAND PRIX (cont.)			GRANDVILLE (cont.)		
Transmission Gasket Set (cont.)			Transmission Pan Gasket (cont.)		
1966, Except Heavy Duty Transmission, Saginaw 3 Speed Transmission, Saginaw 4 Speed Transmission.	TS14737W	1	1971-1975, Turbo Hydra-Matic 375, 400 M40 Transmission, Tuff-Cork.	W39341TC	1
1965, 3 Speed Transmission, Heavy Duty 3 Speed Transmission.	TS27817X	1	IMPALA		
1964-1968, Muncie 4 Speed Transmission . . .	TS27824	1	Transmission Gasket Set		
1964-1965, 3 Speed Transmission, Heavy Duty 3 Speed Transmission, Second Type . .	TS27817X	1	1971-1974, Muncie 3 Speed Transmission . . .	TS27594	1
1962-1964, 3 Speed Transmission, Except Heavy Duty Transmission.	TS27061	1	1971-1972, Muncie 4 Speed Transmission . .	TS27824W	1
1962-1963, 4 Speed Transmission	TS27075W	1	1966-1970, Muncie 4 Speed Transmission . .	TS27824	1
Transmission Pan Gasket			1966-1970, Saginaw 4 Speed Transmission .	TS14737W	1
1983-1987, Turbo Hydra-Matic 700-R4 MD8 Transmission.	W39365	1	1963-1965, Muncie 4 Speed Transmission . .	TS27824W	1
1983-1987, Turbo Hydra-Matic 700-R4 MD8 Transmission, Tuff-Cork.	W39365TC	1	1958-1965, 3 Speed Transmission, Contains Seals.	TS27011W	1
1981-1987, Turbo Hydra-Matic 200 4R MW9 Transmission.	W39361	1	1958-1965, 3 Speed Transmission, Seals Not Included.	TS27061	1
1981-1987, Turbo Hydra-Matic 200 4R MW9 Transmission, Tuff-Cork.	W39361TC	1	1958-1965, 4 Speed Transmission	TS27075W	1
1977-1987, Turbo Hydra-Matic 200 M29, MV9 Transmission.	W39045	1	Transmission Pan Gasket		
1977-1987, Turbo Hydra-Matic 200 M29, MV9 Transmission, Tuff-Cork.	W39045TC	1	1994-1996, Turbo Hydra-Matic 4L60E M30 Transmission, Turbo Hydra-Matic 700-R4 MD8 Transmission.	W39365	1
1969-1983, Turbo Hydra-Matic 250, 350, 375 M31, M33, M38, VMV4, MX2, MX3 Transmission.	W39348	1	1994-1996, Turbo Hydra-Matic 4L60E M30 Transmission, Turbo Hydra-Matic 700-R4 MD8 Transmission, Tuff-Cork.	W39365TC	1
1969-1983, Turbo Hydra-Matic 250, 350, 375 M31, M33, M38, VMV4, MX2, MX3 Transmission, Tuff-Cork.	W39348TC	1	1982-1985, Turbo Hydra-Matic 700-R4 MD8 Transmission.	W39365	1
1969-1977, Turbo Hydra-Matic 375, 400 M40 Transmission.	W39341	1	1982-1985, Turbo Hydra-Matic 700-R4 MD8 Transmission, Tuff-Cork.	W39365TC	1
1969-1977, Turbo Hydra-Matic 375, 400 M40 Transmission, Tuff-Cork.	W39341TC	1	1981-1985, Turbo Hydra-Matic 200 4R MW9 Transmission.	W39361	1
1964-1973, Automatic M35 Transmission . . .	W39007	1	1981-1985, Turbo Hydra-Matic 200 4R MW9 Transmission, Tuff-Cork.	W39361TC	1
Valve Body Cover Gasket			1976-1985, Turbo Hydra-Matic 200 M29, MV9 Transmission.	W39045	1
1991-1996, Turbo Hydra-Matic 4T60E M13 Transaxle, Tuff-Cork.	W39373TC	1	1976-1985, Turbo Hydra-Matic 200 M29, MV9 Transmission, Tuff-Cork.	W39045TC	1
1990-1993, Turbo Hydra-Matic 440 ME9 Transaxle, Turbo Hydra-Matic 4T60E M13 Transaxle, Tuff-Cork.	W39373TC	1	1969-1984, Turbo Hydra-Matic 250, 250C, 350, 350C, 375 M31, M33, M38, MV4, MX2, MY3 Transmission.	W39348	1
1989-1990, Turbo Hydra-Matic 440 T4 ME9 Transaxle, Tuff-Cork.	W39373TC	1	1969-1984, Turbo Hydra-Matic 250, 250C, 350, 350C, 375 M31, M33, M38, MV4, MX2, MY3 Transmission, Tuff-Cork.	W39348TC	1
1989, Turbo Hydra-Matic 440 T4 ME9 Transaxle, Turbo Hydra-Matic 4T60E M13 Transaxle, Tuff-Cork.	W39373TC	1	1965-1977, Turbo Hydra-Matic 375, 400 M40 Transmission.	W39341	1
1988-1995, Turbo Hydra-Matic 125 M34, MD9 Transaxle, Tuff-Cork.	W39368TC	1	1965-1977, Turbo Hydra-Matic 375, 400 M40 Transmission, Tuff-Cork.	W39341TC	1
1986-1987, Turbo Hydra-Matic 440 T4 ME9 Transaxle, Tuff-Cork.	W39373TC	1	1965-1973, Powerglide Transmission, Torque Drive.	W39007	1
GRANDVILLE			1963-1966, Powerglide Transmission	W39007	1
Transmission Gasket Set			1962-1969, Powerglide Transmission, Torque Drive.	W39007	1
1971-1975, Muncie 3 Speed Transmission . . .	TS27594	1	1962-1967, Powerglide Transmission	W39007	1
1971-1975, Muncie 4 Speed Transmission . .	TS27824W	1	1958-1959, Powerglide Transmission	W38765	1
1971-1975, Saginaw 3 Speed Transmission, Saginaw 4 Speed Transmission.	TS14737W	1	INVICTA		
Transmission Pan Gasket			Transmission Gasket Set		
1975, Turbo Hydra-Matic 250, 350, 375 M31, M33, M38, VMV4, MX2, MX3 Transmission.	W39348	1	1961-1963, 3 Speed Transmission	TS27817X	1
1975, Turbo Hydra-Matic 250, 350, 375 M31, M33, M38, VMV4, MX2, MX3 Transmission, Tuff-Cork.	W39348TC	1	1961-1963, 4 Speed Transmission	TS27075Z	1
1971-1975, Turbo Hydra-Matic 375, 400 M40 Transmission.	W39341	1	Transmission Pan Gasket		
			1961-1963, Dual Path Automatic Transmission.		
			W39108 1		
			J2000		
			Transaxle Pan Gasket		
			1982-1983, Turbo Hydra-Matic 125 M34, MD9 Transaxle, Tuff-Cork.		
			W39356TC 1		

Transmission Gaskets (cont.)				
Model & Application	Part No.	Qty.	Model & Application	Part No. Qty.
J2000 (cont.)			LAURENTIAN (cont.)	
Valve Body Cover Gasket			Transmission Pan Gasket (cont.)	
1982-1983, Turbo Hydra-Matic 125 M34, MD9 Transaxle, Tuff-Cork.	W39368TC	1	1971-1972, Turbo Hydra-Matic 250, 350, 375 M31, M33, M38, VMV4, MX2, MX3 Transmission, Tuff-Cork.	W39348TC 1
JETSTAR 1			LE SABRE	
Transmission Gasket Set			Transaxle Pan Gasket	
1966, 3 Speed Transmission, Heavy Duty 3 Speed Transmission	TS27817X	1	1991-1996, Turbo Hydra-Matic 4T60E M13 Transaxle, Tuff-Cork.	W31180TC 1
1965-1966, 4 Speed Transmission	TS27824	1	1986-1993, Turbo Hydra-Matic 440 ME9 Transaxle, Tuff-Cork.	W39369TC 1
1965, 3 Speed Transmission	TS27011W	1	1986, Turbo Hydra-Matic 125 M34, MD9 Transaxle, Turbo Hydra-Matic 125C MD9 Transaxle, Tuff-Cork.	W39356TC 1
Transmission Pan Gasket			Transmission Gasket Set	
1965-1966, Turbo Hydra-Matic 375, 400 M40 Transmission.	W39341	1	1970, 3 Speed Transmission, Floor Shift	TS27594 1
1965-1966, Turbo Hydra-Matic 375, 400 M40 Transmission, Tuff-Cork.	W39341TC	1	1967, 4 Speed Transmission	TS27824 1
JETSTAR 88			1966-1969, 3 Speed Transmission, Floor Shift.	
Transmission Gasket Set			
1966, 3 Speed Transmission, Heavy Duty 3 Speed Transmission	TS27817X	1	1966, 4 Speed Transmission	TS27075W 1
1965, 3 Speed Transmission	TS27011W	1	1964-1965, 3 Speed Transmission, 4 Speed Transmission, Floor Shift	TS27075W 1
1964-1966, 4 Speed Transmission	TS27824	1	1964-1965, 3 Speed Transmission, Column Shift	TS27011W 1
1964	TS27011W	1	1962-1963, 4 Speed Transmission	TS27075Z 1
LSS			1961-1963, 3 Speed Transmission	
Transaxle Pan Gasket			
1996, Turbo Hydra-Matic 4T60E M13 Transaxle, Tuff-Cork.	W31180TC	1	Transmission Pan Gasket	
Valve Body Cover Gasket			1988, Turbo Hydra-Matic 700-R4 MD8 Transmission.	
1996, Turbo Hydra-Matic 4T60E M13 Transaxle, Tuff-Cork.	W39373TC	1	
LAURENTIAN			1988, Turbo Hydra-Matic 700-R4 MD8 Transmission, Tuff-Cork.	
Transmission Gasket Set			
1978-1979, Saginaw 3 Speed Transmission	TS14737W	1	1984-1985, Turbo Hydra-Matic 700-R4 MD8 Transmission.	
1977-1981, Saginaw 3 Speed Transmission, Saginaw 4 Speed Transmission	TS14737W	1	
1976-1981, Muncie 3 Speed Transmission	TS27594	1	1984-1985, Turbo Hydra-Matic 700-R4 MD8 Transmission, Tuff-Cork.	
1976-1981, Muncie 4 Speed Transmission	TS27824W	1	
1976, Saginaw 4 Speed Transmission	TS14737W	1	1982-1984, Turbo Hydra-Matic 250C M38 Transmission.	
1971-1972, Muncie 3 Speed Transmission	TS27594	1	
1971-1972, Muncie 4 Speed Transmission	TS27824W	1	1982-1984, Turbo Hydra-Matic 250C M38 Transmission, Tuff-Cork.	
1971-1972, Saginaw 3 Speed Transmission, Saginaw 4 Speed Transmission	TS14737W	1	
Transmission Pan Gasket			1981-1990, Turbo Hydra-Matic 200 4R MW9 Transmission	
1981, Turbo Hydra-Matic 200 4R MW9 Transmission.	W39361	1	
1981, Turbo Hydra-Matic 200 4R MW9 Transmission, Tuff-Cork.	W39361TC	1	1981-1990, Turbo Hydra-Matic 200 4R MW9 Transmission, Tuff-Cork.	
1976-1981, Turbo Hydra-Matic 200 M29, MV9 Transmission.	W39045	1	
1976-1981, Turbo Hydra-Matic 200 M29, MV9 Transmission, Tuff-Cork.	W39045TC	1	1979-1986, Turbo Hydra-Matic 325 M32, M57 Transaxle.	
1976-1981, Turbo Hydra-Matic 250, 350, 375 M31, M33, M38, VMV4, MX2, MX3 Transmission.	W39348	1	
1976-1981, Turbo Hydra-Matic 250, 350, 375 M31, M33, M38, VMV4, MX2, MX3 Transmission, Tuff-Cork.	W39348TC	1	1979-1986, Turbo Hydra-Matic 325 M32, M57 Transaxle, Tuff-Cork.	
1976-1977, Turbo Hydra-Matic 375, 400 M40 Transmission.	W39341	1	
1976-1977, Turbo Hydra-Matic 375, 400 M40 Transmission, Tuff-Cork.	W39341TC	1	1978-1984, Turbo Hydra-Matic 250C M38 Transmission, Turbo Hydra-Matic 350, 375 M31, M33, MV4, MX2, MX5 Transmission.	
1971-1972, Automatic M35 Transmission	W39007	1	
1971-1972, Turbo Hydra-Matic 250, 350, 375 M31, M33, M38, VMV4, MX2, MX3 Transmission.	W39348	1	1978-1984, Turbo Hydra-Matic 250C M38 Transmission, Turbo Hydra-Matic 350, 375 M31, M33, MV4, MX2, MX5 Transmission, Tuff-Cork	
			
			1977-1984, Turbo Hydra-Matic 250C M38 Transmission, Turbo Hydra-Matic 350, 375 M31, M33, MV4, MX2, MX5 Transmission.	
			
			1976-1987, Turbo Hydra-Matic 200 M29, MV9 Transmission.	
			

General Motors Corp. (cont.)

Transmission Gaskets (cont.)

<i>Model & Application</i>	<i>Part No.</i>	<i>Qty.</i>	<i>Model & Application</i>	<i>Part No.</i>	<i>Qty.</i>
LE SABRE (cont.)			LEMANS (cont.)		
Transmission Pan Gasket (cont.)			Valve Body Cover Gasket		
1976-1987, Turbo Hydra-Matic 200 M29, MV9 Transmission, Tuff-Cork.	W39045TC	1	1989-1990, Turbo Hydra-Matic 125 M34, MD9 Transaxle, Tuff-Cork.	W39368TC	1
1968-1981, Turbo Hydra-Matic 400 M40 Transmission.	W39341	1	LUMINA		
1968-1981, Turbo Hydra-Matic 400 M40 Transmission, Tuff-Cork.	W39341TC	1	Transaxle Pan Gasket		
1964-1979, Turbo Hydra-Matic 350, 375 M31, M33, MV4, MX2, MX5 Transmission.	W39348	1	1991-1996, Turbo Hydra-Matic 4T60E M13 Transaxle, Tuff-Cork.	W31180TC	1
1964-1979, Turbo Hydra-Matic 350, 375 M31, M33, MV4, MX2, MX5 Transmission, Tuff-Cork.	W39348TC	1	1990-1996, Turbo Hydra-Matic 125 M34, MD9 Transaxle, Tuff-Cork.	W39356TC	1
1964, Turbo Hydra-Matic 400 M40 Transmission.	W39341	1	1990-1993, Turbo Hydra-Matic 440 T4 ME9 Transaxle, Tuff-Cork.	W39369TC	1
1964, Turbo Hydra-Matic 400 M40 Transmission, Tuff-Cork.	W39341TC	1	Valve Body Cover Gasket		
1961-1963, Dual Path Automatic Transmission.	W39108	1	1991-1996, Turbo Hydra-Matic 4T60E M13 Transaxle, Tuff-Cork.	W39373TC	1
Valve Body Cover Gasket			1990-1996, Turbo Hydra-Matic 125 M34, MD9 Transaxle, Tuff-Cork.	W39368TC	1
1996, Turbo Hydra-Matic 4T60E M13 Transaxle, Tuff-Cork.	W39373TC	1	1990-1993, Turbo Hydra-Matic 440 T4 ME9 Transaxle, Turbo Hydra-Matic 4T60E M13 Transaxle, Tuff-Cork.	W39373TC	1
1988-1993, Turbo Hydra-Matic 440 ME9 Transaxle, Turbo Hydra-Matic 4T60E M13 Transaxle, Tuff-Cork.	W39373TC	1	MALIBU		
1986, Turbo Hydra-Matic 125 M34, MD9 Transaxle, Turbo Hydra-Matic 125C MD9 Transaxle, Tuff-Cork.	W39368TC	1	Transmission Gasket Set		
1983-1988, Turbo Hydra-Matic 440 ME9 Transaxle, Tuff-Cork.	W39373TC	1	1978-1981, 3 Speed Transmission, 4 Speed Transmission.	TS14737W	1
LEMANS			Transmission Pan Gasket		
Transaxle Pan Gasket			1982-1983, Turbo Hydra-Matic 700-R4 MD8 Transmission.	W39365	1
1989-1990, Turbo Hydra-Matic 125 M34, MD9 Transaxle, Tuff-Cork.	W39356TC	1	1982-1983, Turbo Hydra-Matic 700-R4 MD8 Transmission, Tuff-Cork.	W39365TC	1
Transmission Gasket Set			1981-1983, Turbo Hydra-Matic 200 4R MW9 Transmission.	W39361	1
1974-1975, Saginaw 4 Speed Transmission.	TS14737W	1	1981-1983, Turbo Hydra-Matic 200 4R MW9 Transmission, Tuff-Cork.	W39361TC	1
1972-1976, Saginaw 3 Speed Transmission.	TS14737W	1	1978-1983, Turbo Hydra-Matic 200 M29, MV9 Transmission.	W39045	1
1971-1981, Saginaw 3 Speed Transmission, Saginaw 4 Speed Transmission.	TS14737W	1	1978-1983, Turbo Hydra-Matic 200 M29, MV9 Transmission, Tuff-Cork.	W39045TC	1
1971-1974, Saginaw 3 Speed Transmission.	TS14737W	1	1978-1983, Turbo Hydra-Matic 250, 250C, 350, 350C, 375 M31, M33, M38, MV4, MX2, MY3 Transmission.	W39348	1
1971, Saginaw 3 Speed Transmission, Saginaw 4 Speed Transmission.	TS14737W	1	1978-1983, Turbo Hydra-Matic 250, 250C, 350, 350C, 375 M31, M33, M38, MV4, MX2, MY3 Transmission, Tuff-Cork.	W39348TC	1
1970-1981, Muncie 3 Speed Transmission.	TS27594	1	Valve Body Cover Gasket		
1970-1981, Muncie 4 Speed Transmission.	TS27824W	1	1982-1983, Turbo Hydra-Matic 125 M34, MD9 Transaxle, Tuff-Cork.	W39368TC	1
1970-1971, Saginaw 4 Speed Transmission.	TS14737W	1	MASTER		
1970, Heavy Duty 3 Speed Transmission, Saginaw 3 Speed Transmission.	TS14737W	1	Transmission Gasket Set		
Transmission Pan Gasket			1937-1938, 3 Speed Transmission.	TS26250X	1
1981, Turbo Hydra-Matic 200 4R MW9 Transmission.	W39361	1	MASTER 85		
1981, Turbo Hydra-Matic 200 4R MW9 Transmission, Tuff-Cork.	W39361TC	1	Transmission Gasket Set		
1976-1981, Turbo Hydra-Matic 200 M29, MV9 Transmission.	W39045	1	1939-1940, 3 Speed Transmission.	TS26250X	1
1976-1981, Turbo Hydra-Matic 200 M29, MV9 Transmission, Tuff-Cork.	W39045TC	1	MASTER DELUXE		
1971-1973, Automatic M35 Transmission.	W39007	1	Transmission Gasket Set		
1970-1981, Turbo Hydra-Matic 250, 350, 375 M31, M33, M38, VMV4, MX2, MX3 Transmission.	W39348	1	1937-1942, 3 Speed Transmission.	TS26250X	1
1970-1981, Turbo Hydra-Matic 250, 350, 375 M31, M33, M38, VMV4, MX2, MX3 Transmission, Tuff-Cork.	W39348TC	1	METRO		
1970-1977, Turbo Hydra-Matic 375, 400 M40 Transmission.	W39341	1	Transmission Pan Gasket		
1970-1977, Turbo Hydra-Matic 375, 400 M40 Transmission, Tuff-Cork.	W39341TC	1	1989-1994, Automatic Transmission.	W38031	1

Transmission Gaskets (cont.)

<i>Model & Application</i>	<i>Part No.</i>	<i>Qty.</i>	<i>Model & Application</i>	<i>Part No.</i>	<i>Qty.</i>
MONTE CARLO			MONZA (cont.)		
Transaxle Pan Gasket			Transmission Pan Gasket (cont.)		
1995-1996, Turbo Hydra-Matic 125 M34, MD9 Transaxle, Tuff-Cork	W39356TC	1	1975-1980, Turbo Hydra-Matic 250, 250C, 350, 350C, 375 M31, M33, M38, MV4, MX2, MY3 Transmission	W39348	1
1995-1996, Turbo Hydra-Matic 4T60E M13 Transaxle, Tuff-Cork	W31180TC	1	1975-1980, Turbo Hydra-Matic 250, 250C, 350, 350C, 375 M31, M33, M38, MV4, MX2, MY3 Transmission, Tuff-Cork	W39348TC	1
Transmission Gasket Set			NINETY EIGHT		
1971-1974, Muncie 3 Speed Transmission	TS27594	1	Transaxle Pan Gasket		
1971-1972, Muncie 4 Speed Transmission	TS27824W	1	1991-1996, Turbo Hydra-Matic 4T60E M13 Transaxle, Tuff-Cork		
1970, Muncie 4 Speed Transmission	TS27824	1	1983-1993, Turbo Hydra-Matic 440 T4 ME9 Transaxle, Tuff-Cork		
1970, Saginaw 4 Speed Transmission	TS14737W	1	Transmission Gasket Set		
Transmission Pan Gasket			1978-1981, 3 Speed Transmission, 4 Speed Transmission		
1982-1988, Turbo Hydra-Matic 700-R4 MD8 Transmission	W39365	1	1968-1973, 4 Speed Transmission		
1982-1988, Turbo Hydra-Matic 700-R4 MD8 Transmission, Tuff-Cork	W39365TC	1	1966-1967, 3 Speed Transmission, Heavy Duty 3 Speed Transmission		
1981-1988, Turbo Hydra-Matic 200 4R MW9 Transmission	W39361	1	Transmission Pan Gasket		
1981-1988, Turbo Hydra-Matic 200 4R MW9 Transmission, Tuff-Cork	W39361TC	1	1988-1990, Turbo Hydra-Matic 700-R4 MD8 Transmission, Tuff-Cork		
1976-1988, Turbo Hydra-Matic 200 M29, MV9 Transmission	W39045	1	1985, Turbo Hydra-Matic 325 M32, M57 Transaxle, Tuff-Cork		
1976-1988, Turbo Hydra-Matic 200 M29, MV9 Transmission, Tuff-Cork	W39045TC	1	1982-1986, Turbo Hydra-Matic 700-R4 MD8 Transmission		
1970-1984, Turbo Hydra-Matic 250, 250C, 350, 350C, 375 M31, M33, M38, MV4, MX2, MY3 Transmission	W39348	1	1982-1986, Turbo Hydra-Matic 700-R4 MD8 Transmission, Tuff-Cork		
1970-1984, Turbo Hydra-Matic 250, 250C, 350, 350C, 375 M31, M33, M38, MV4, MX2, MY3 Transmission, Tuff-Cork	W39348TC	1	1981-1990, Turbo Hydra-Matic 200 4R MW9 Transmission		
1970-1977, Turbo Hydra-Matic 375, 400 M40 Transmission	W39341	1	1981-1990, Turbo Hydra-Matic 200 4R MW9 Transmission, Tuff-Cork		
1970-1977, Turbo Hydra-Matic 375, 400 M40 Transmission, Tuff-Cork	W39341TC	1	1976-1987, Turbo Hydra-Matic 200 M29, MV9 Transmission		
1970-1973, Powerglide Transmission, Torque Drive	W39007	1	1976-1987, Turbo Hydra-Matic 200 M29, MV9 Transmission, Tuff-Cork		
Valve Body Cover Gasket			1969-1984, Turbo Hydra-Matic 250, 350 M31, M33, M38, MV4, MX2 Transmission		
1995-1996, Turbo Hydra-Matic 125 M34, MD9 Transaxle, Tuff-Cork	W39368TC	1	1969-1984, Turbo Hydra-Matic 250, 350 M31, M33, M38, MV4, MX2 Transmission, Tuff-Cork		
1995-1996, Turbo Hydra-Matic 4T60E M13 Transaxle, Tuff-Cork	W39373TC	1	1965-1980, Turbo Hydra-Matic 375, 400 M40 Transmission		
1984-1987, Turbo Hydra-Matic 440 T4 ME9 Transaxle, Tuff-Cork	W39373TC	1	1965-1980, Turbo Hydra-Matic 375, 400 M40 Transmission, Tuff-Cork		
1982-1985, Turbo Hydra-Matic 125 M34, MD9 Transaxle, Tuff-Cork	W39368TC	1	Valve Body Cover Gasket		
MONZA			1992-1996, Turbo Hydra-Matic 4T60E M13 Transaxle, Tuff-Cork		
Transmission Gasket Set			1992-1993, Turbo Hydra-Matic 440 T4 ME9 Transaxle, Tuff-Cork		
1979-1980, 3 Speed Transmission	TS14737W	1	1990-1993, Turbo Hydra-Matic 440 T4 ME9 Transaxle, Turbo Hydra-Matic 4T60E M13 Transaxle, Tuff-Cork		
1978-1980, 3 Speed Transmission, 4 Speed Transmission	TS14737W	1	1983-1990, Turbo Hydra-Matic 440 T4 ME9 Transaxle, Tuff-Cork		
1976-1980, 4 Speed Transmission	TS14737W	1	1982-1985, Turbo Hydra-Matic 125 M34, MD9 Transaxle, Tuff-Cork		
1976-1979, 3 Speed Transmission, 4 Speed Transmission	TS14737W	1	NOMAD		
1976-1977, 4 Speed Transmission	TS14737W	1	Transmission Gasket Set		
1976, 3 Speed Transmission, 4 Speed Transmission	TS14737W	1	1956-1961, 3 Speed Transmission, Seals Not Included		
1975-1980, 3 Speed Transmission	TS14737W	1	1956-1961, 4 Speed Transmission		
1975-1977, Saginaw 3 Speed Transmission	TS14737W	1			
1975-1976, 3 Speed Transmission	TS14737W	1			
1975, Saginaw 4 Speed Transmission	TS14737W	1			
Transmission Pan Gasket					
1976-1980, Turbo Hydra-Matic 200 M29, MV9 Transmission	W39045	1			
1976-1980, Turbo Hydra-Matic 200 M29, MV9 Transmission, Tuff-Cork	W39045TC	1			

PASSENGER CAR

General Motors Corp. (cont.)

Transmission Gaskets (cont.)

<i>Model & Application</i>	<i>Part No.</i>	<i>Qty.</i>	<i>Model & Application</i>	<i>Part No.</i>	<i>Qty.</i>
NOMAD (cont.)			OMEGA (cont.)		
Transmission Gasket Set (cont.)			Transmission Pan Gasket (cont.)		
1955-1961, 3 Speed Transmission, Contains Seals	TS27011W	1	1976-1984, Turbo Hydra-Matic 250, 350 M31, M33, M38, MV4, MX2 Transmission, Tuff-Cork	W39348TC	1
Transmission Pan Gasket			Valve Body Cover Gasket		
1958-1959, Powerglide Transmission	W38765	1	1983-1984, Turbo Hydra-Matic 440 T4 ME9 Transaxle, Tuff-Cork	W39373TC	1
NOVA			1982-1984, Turbo Hydra-Matic 125 M34, MD9 Transaxle, Tuff-Cork		
Transaxle Pan Gasket			1983-1986, Turbo Hydra-Matic 200 4R MW9 Transmission		
1985-1988, Automatic Transmission, MX1 3 Speed Transmission, Tuff-Cork	W29099TC	1	1983-1986, Turbo Hydra-Matic 200 4R MW9 Transmission, Tuff-Cork	W39361TC	1
Transmission Gasket Set			1983-1986, Turbo Hydra-Matic 200 M29, MV9 Transmission		
1971-1974, Muncie 3 Speed Transmission . . .	TS27594	1	1983-1986, Turbo Hydra-Matic 200 M29, MV9 Transmission, Tuff-Cork	W39045TC	1
1971-1972, Muncie 4 Speed Transmission . .	TS27824W	1	1983-1986, Turbo Hydra-Matic 700-R4 MD8 Transmission	W39365	1
1969-1970, Muncie 4 Speed Transmission . .	TS27824	1	1983-1986, Turbo Hydra-Matic 700-R4 MD8 Transmission, Tuff-Cork	W39365TC	1
1969-1970, Saginaw 4 Speed Transmission .	TS14737W	1	1983, Turbo Hydra-Matic 250, 350, 375 M31, M33, M38, VMV4, MX2, MX3 Transmission	W39348	1
Transmission Pan Gasket			1983, Turbo Hydra-Matic 250, 350, 375 M31, M33, M38, VMV4, MX2, MX3 Transmission, Tuff-Cork		
1976-1979, Turbo Hydra-Matic 200 M29, MV9 Transmission	W39045	1	1983, Turbo Hydra-Matic 250, 350, 375 M31, M33, M38, VMV4, MX2, MX3 Transmission, Tuff-Cork	W39348TC	1
1976-1979, Turbo Hydra-Matic 200 M29, MV9 Transmission, Tuff-Cork	W39045TC	1	PARK AVENUE		
1969-1979, Turbo Hydra-Matic 250, 250C, 350, 350C, 375 M31, M33, M38, MV4, MX2, MY3 Transmission	W39348	1	Transaxle Pan Gasket		
1969-1979, Turbo Hydra-Matic 250, 250C, 350, 350C, 375 M31, M33, M38, MV4, MX2, MY3 Transmission, Tuff-Cork	W39348TC	1	1991-1996, Turbo Hydra-Matic 4T60E M13 Transaxle, Tuff-Cork	W31180TC	1
1969-1977, Turbo Hydra-Matic 375, 400 M40 Transmission	W39341	1	1991-1993, Turbo Hydra-Matic 440 ME9 Transaxle, Tuff-Cork	W39369TC	1
1969-1977, Turbo Hydra-Matic 375, 400 M40 Transmission, Tuff-Cork	W39341TC	1	Valve Body Cover Gasket		
1969-1973, Powerglide Transmission, Torque Drive	W39007	1	1995-1996, Turbo Hydra-Matic 4T60E M13 Transaxle, Tuff-Cork	W39373TC	1
OMEGA			1991-1993, Turbo Hydra-Matic 440 ME9 Transaxle, Turbo Hydra-Matic 4T60E M13 Transaxle, Tuff-Cork		
Transaxle Pan Gasket			1991-1993, Turbo Hydra-Matic 440 ME9 Transaxle, Tuff-Cork		
1983-1984, Turbo Hydra-Matic 440 T4 ME9 Transaxle, Tuff-Cork	W39369TC	1	PHOENIX		
1982-1984, Turbo Hydra-Matic 125 M34, MD9 Transaxle, Tuff-Cork	W39356TC	1	Transaxle Pan Gasket		
Transmission Gasket Set			1980-1984, Turbo Hydra-Matic 125 M34, MD9 Transaxle, Tuff-Cork		
1980, 3 Speed Transmission	TS14737W	1	Transmission Gasket Set		
1976-1981, 3 Speed Transmission, 4 Speed Transmission	TS14737W	1	1977-1979, Muncie 3 Speed Transmission . . .	TS27594	1
1976-1978, 4 Speed Transmission	TS14737W	1	1977-1979, Muncie 4 Speed Transmission . .	TS27824W	1
1976-1977, 3 Speed Transmission, 4 Speed Transmission	TS14737W	1	1977-1979, Saginaw 3 Speed Transmission, Saginaw 4 Speed Transmission	TS14737W	1
Transmission Pan Gasket			Transmission Pan Gasket		
1981-1984, Turbo Hydra-Matic 200 4R MW9 Transmission	W39361	1	1977-1979, Turbo Hydra-Matic 200 M29, MV9 Transmission	W39045	1
1981-1984, Turbo Hydra-Matic 200 4R MW9 Transmission, Tuff-Cork	W39361TC	1	1977-1979, Turbo Hydra-Matic 200 M29, MV9 Transmission, Tuff-Cork	W39045TC	1
1979-1984, Turbo Hydra-Matic 325 M32, M57 Transaxle, Tuff-Cork	W39355TC	1	1977-1979, Turbo Hydra-Matic 250, 350, 375 M31, M33, M38, VMV4, MX2, MX3 Transmission	W39348	1
1979, Turbo Hydra-Matic 325 M32, M57 Transaxle	W39355	1	1977-1979, Turbo Hydra-Matic 250, 350, 375 M31, M33, M38, VMV4, MX2, MX3 Transmission, Tuff-Cork	W39348TC	1
1977-1979, Turbo Hydra-Matic 375, 400 M40 Transmission	W39341	1	1977, Turbo Hydra-Matic 375, 400 M40 Transmission	W39341	1
1977-1979, Turbo Hydra-Matic 375, 400 M40 Transmission, Tuff-Cork	W39341TC	1			
1976-1984, Turbo Hydra-Matic 200 M29, MV9 Transmission	W39045	1			
1976-1984, Turbo Hydra-Matic 200 M29, MV9 Transmission, Tuff-Cork	W39045TC	1			
1976-1984, Turbo Hydra-Matic 250, 350 M31, M33, M38, MV4, MX2 Transmission . . .	W39348	1			

Transmission Gaskets (cont.)				
Model & Application	Part No.	Qty.	Model & Application	Part No. Qty.
PHOENIX (cont.)			REGAL (cont.)	
Transmission Pan Gasket (cont.)			Transmission Pan Gasket (cont.)	
1977, Turbo Hydra-Matic 375, 400 M40 Transmission, Tuff-Cork	W39341TC	1	1978-1984, Turbo Hydra-Matic 250C M38 Transmission, Turbo Hydra-Matic 350, 375 M31, M33, MV4, MX2, MX5 Transmission	W39348 1
Valve Body Cover Gasket			1978-1984, Turbo Hydra-Matic 250C M38 Transmission, Turbo Hydra-Matic 350, 375 M31, M33, MV4, MX2, MX5 Transmission, Tuff-Cork	
1980-1984, Turbo Hydra-Matic 125 M34, MD9 Transaxle, Tuff-Cork	W39368TC	1	1976-1987, Turbo Hydra-Matic 200 M29, MV9 Transmission	W39348TC 1
PRIZM			1976-1987, Turbo Hydra-Matic 200 M29, MV9 Transmission, Tuff-Cork	
Transaxle Pan Gasket			1976-1981, Turbo Hydra-Matic 400 M40 Transmission	
1990-1992, 4 Speed Automatic Transaxle, Tuff-Cork	W39370TC	1	1976-1981, Turbo Hydra-Matic 400 M40 Transmission, Tuff-Cork	W39341TC 1
1989-1992, 3 Speed Automatic Transaxle, Tuff-Cork	W29099TC	1	1976-1979, Turbo Hydra-Matic 350, 375 M31, M33, MV4, MX2, MX5 Transmission	W39348 1
REATTA			1976-1979, Turbo Hydra-Matic 350, 375 M31, M33, MV4, MX2, MX5 Transmission, Tuff-Cork	
Transaxle Pan Gasket			Valve Body Cover Gasket	
1991-1993, Turbo Hydra-Matic 4T60E M13 Transaxle, Tuff-Cork	W31180TC	1	1994-1996, Turbo Hydra-Matic 125C MD9 Transaxle, Tuff-Cork	W39368TC 1
1988-1993, Turbo Hydra-Matic 440 ME9 Transaxle, Tuff-Cork	W39369TC	1	1994-1996, Turbo Hydra-Matic 4T60E M13 Transaxle, Tuff-Cork	W39373TC 1
Valve Body Cover Gasket			1989-1993, Turbo Hydra-Matic 440 ME9 Transaxle, Turbo Hydra-Matic 4T60E M13 Transaxle, Tuff-Cork	
1991-1993, Turbo Hydra-Matic 440 ME9 Transaxle, Turbo Hydra-Matic 4T60E M13 Transaxle, Tuff-Cork	W39373TC	1	1988-1993, Turbo Hydra-Matic 125 M34, MD9 Transaxle, Turbo Hydra-Matic 125C MD9 Transaxle, Tuff-Cork	W39373TC 1
1988-1990, Turbo Hydra-Matic 440 ME9 Transaxle, Tuff-Cork	W39373TC	1	1983-1987, Turbo Hydra-Matic 440 ME9 Transaxle, Tuff-Cork	W39373TC 1
REGAL			1982-1985, Turbo Hydra-Matic 125 M34, MD9 Transaxle, Turbo Hydra-Matic 125C MD9 Transaxle, Tuff-Cork	
Transaxle Pan Gasket			REGENCY	
1994-1996, Turbo Hydra-Matic 125C MD9 Transaxle, Tuff-Cork	W39356TC	1	Transmission Pan Gasket	
1991-1996, Turbo Hydra-Matic 4T60E M13 Transaxle, Tuff-Cork	W31180TC	1	1984, Turbo Hydra-Matic 200 4R MW9 Transmission	
1989-1993, Turbo Hydra-Matic 440 ME9 Transaxle, Tuff-Cork	W39369TC	1	1984, Turbo Hydra-Matic 200 4R MW9 Transmission, Tuff-Cork	
1988-1993, Turbo Hydra-Matic 125 M34, MD9 Transaxle, Turbo Hydra-Matic 125C MD9 Transaxle, Tuff-Cork	W39356TC	1	1984, Turbo Hydra-Matic 200 M29, MV9 Transmission	
Transmission Gasket Set			1984, Turbo Hydra-Matic 200 M29, MV9 Transmission, Tuff-Cork	
1976-1981, 3 Speed Transmission	TS14737W	1	1984, Turbo Hydra-Matic 250, 350 M31, M33, M38, MV4, MX2 Transmission	
Transmission Pan Gasket			1984, Turbo Hydra-Matic 250, 350 M31, M33, M38, MV4, MX2 Transmission, Tuff-Cork	
1984-1985, Turbo Hydra-Matic 700-R4 MD8 Transmission	W39365	1	1984, Turbo Hydra-Matic 700-R4 MD8 Transmission	
1984-1985, Turbo Hydra-Matic 700-R4 MD8 Transmission, Tuff-Cork	W39365TC	1	1984, Turbo Hydra-Matic 700-R4 MD8 Transmission, Tuff-Cork	
1981-1987, Turbo Hydra-Matic 200 4R MW9 Transmission	W39361	1	RIVIERA	
1981-1987, Turbo Hydra-Matic 200 4R MW9 Transmission, Tuff-Cork	W39361TC	1	Transaxle Pan Gasket	
1979-1986, Turbo Hydra-Matic 325 M32, M57 Transaxle	W39355	1	1995-1996, Turbo Hydra-Matic 4T60E M13 Transaxle, Tuff-Cork	
1979-1986, Turbo Hydra-Matic 325 M32, M57 Transaxle, Tuff-Cork	W39355TC	1	1991-1993, Turbo Hydra-Matic 4T60E M13 Transaxle, Tuff-Cork	
1979-1984, Turbo Hydra-Matic 250C M38 Transmission, Turbo Hydra-Matic 350, 375 M31, M33, MV4, MX2, MX5 Transmission	W39348	1	1986-1993, Turbo Hydra-Matic 440 ME9 Transaxle, Tuff-Cork	
1979-1984, Turbo Hydra-Matic 250C M38 Transmission, Turbo Hydra-Matic 350, 375 M31, M33, MV4, MX2, MX5 Transmission, Tuff-Cork	W39348TC	1	Transmission Gasket Set	
1979, Turbo Hydra-Matic 350, 375 M31, M33, MV4, MX2, MX5 Transmission	W39348	1	1970, 3 Speed Transmission, Floor Shift	
1979, Turbo Hydra-Matic 350, 375 M31, M33, MV4, MX2, MX5 Transmission, Tuff-Cork	W39348TC	1	TS27594 1	

General Motors Corp. (cont.)

Transmission Gaskets (cont.)

<i>Model & Application</i>	<i>Part No.</i>	<i>Qty.</i>	<i>Model & Application</i>	<i>Part No.</i>	<i>Qty.</i>
RIVIERA (cont.)			RIVIERA (cont.)		
Transmission Gasket Set (cont.)			Valve Body Cover Gasket (cont.)		
1966, 4 Speed Transmission	TS27075W	1	1983-1987, Turbo Hydra-Matic 440 ME9 Transaxle, Tuff-Cork.	W39373TC	1
1964-1966, 3 Speed Transmission, 4 Speed Transmission, Floor Shift	TS27075W	1	ROADMASTER		
1964-1965, 3 Speed Transmission, Column Shift	TS27011W	1	Transmission Pan Gasket		
1963, 3 Speed Transmission	TS27817X	1	1994-1996, Turbo Hydra-Matic 4L60E M30 Transmission.	W39365	1
1963, 4 Speed Transmission	TS27075Z	1	1994-1996, Turbo Hydra-Matic 4L60E M30 Transmission, Turbo Hydra-Matic 700-R4 MD8 Transmission, Tuff-Cork.	W39365TC	1
Transmission Pan Gasket			1991-1993, Turbo Hydra-Matic 700-R4 MD8 Transmission, Tuff-Cork.	W39365TC	1
1984-1985, Turbo Hydra-Matic 700-R4 MD8 Transmission.	W39365	1	1991-1992, Turbo Hydra-Matic 250C M38 Transmission.	W39348	1
1984-1985, Turbo Hydra-Matic 700-R4 MD8 Transmission, Tuff-Cork.	W39365TC	1	1991-1992, Turbo Hydra-Matic 250C M38 Transmission, Tuff-Cork.	W39348TC	1
1981-1985, Turbo Hydra-Matic 200 4R MW9 Transmission	W39361	1	SAFARI		
1981-1985, Turbo Hydra-Matic 200 4R MW9 Transmission, Tuff-Cork	W39361TC	1	Transmission Pan Gasket		
1979-1986, Turbo Hydra-Matic 325 M32, M57 Transaxle.	W39355	1	1987-1989, Turbo Hydra-Matic 200 4R MW9 Transmission	W39361	1
1979-1986, Turbo Hydra-Matic 325 M32, M57 Transaxle, Tuff-Cork.	W39355TC	1	1987-1989, Turbo Hydra-Matic 200 4R MW9 Transmission, Tuff-Cork	W39361TC	1
1978-1984, Turbo Hydra-Matic 250C M38 Transmission, Turbo Hydra-Matic 350, 375 M31, M33, MV4, MX2, MX5 Transmission.	W39348	1	1987-1989, Turbo Hydra-Matic 700-R4 MD8 Transmission.	W39365	1
1978-1984, Turbo Hydra-Matic 250C M38 Transmission, Turbo Hydra-Matic 350, 375 M31, M33, MV4, MX2, MX5 Transmission, Tuff-Cork	W39348TC	1	1987-1989, Turbo Hydra-Matic 700-R4 MD8 Transmission, Tuff-Cork.	W39365TC	1
1978, Turbo Hydra-Matic 350, 375 M31, M33, MV4, MX2, MX5 Transmission	W39348	1	1987, Turbo Hydra-Matic 200 M29, MV9 Transmission.	W39045	1
1978, Turbo Hydra-Matic 350, 375 M31, M33, MV4, MX2, MX5 Transmission, Tuff-Cork	W39348TC	1	1987, Turbo Hydra-Matic 200 M29, MV9 Transmission, Tuff-Cork.	W39045TC	1
1977-1980, Turbo Hydra-Matic 250C M38 Transmission, Turbo Hydra-Matic 350, 375 M31, M33, MV4, MX2, MX5 Transmission.	W39348	1	SEDAN DEVILLE		
1977-1980, Turbo Hydra-Matic 250C M38 Transmission, Turbo Hydra-Matic 350, 375 M31, M33, MV4, MX2, MX5 Transmission, Tuff-Cork	W39348TC	1	Transmission Pan Gasket		
1976-1985, Turbo Hydra-Matic 200 M29, MV9 Transmission.	W39045	1	1978-1979, Turbo Hydra-Matic 200 M29, MV9 Transmission.	W39045	1
1976-1985, Turbo Hydra-Matic 200 M29, MV9 Transmission, Tuff-Cork.	W39045TC	1	1978-1979, Turbo Hydra-Matic 200 M29, MV9 Transmission, Tuff-Cork.	W39045TC	1
1970-1979, Turbo Hydra-Matic 350, 375 M31, M33, MV4, MX2, MX5 Transmission.	W39348	1	1978-1979, Turbo Hydra-Matic 400 M40 Transmission.	W39341	1
1970-1979, Turbo Hydra-Matic 350, 375 M31, M33, MV4, MX2, MX5 Transmission, Tuff-Cork	W39348TC	1	1978-1979, Turbo Hydra-Matic 400 M40 Transmission, Tuff-Cork.	W39341TC	1
1965, Turbo Hydra-Matic 350, 375 M31, M33, MV4, MX2, MX5 Transmission	W39348	1	SERIES 6200		
1965, Turbo Hydra-Matic 350, 375 M31, M33, MV4, MX2, MX5 Transmission, Tuff-Cork	W39348TC	1	Transmission Pan Gasket		
1964-1981, Turbo Hydra-Matic 400 M40 Transmission.	W39341	1	1975, Turbo Hydra-Matic 325 M32, M57 Transaxle.	W39355	1
1964-1981, Turbo Hydra-Matic 400 M40 Transmission, Tuff-Cork.	W39341TC	1	1975, Turbo Hydra-Matic 325 M32, M57 Transaxle, Tuff-Cork.	W39355TC	1
1963, Dual Path Automatic Transmission	W39108	1	1964-1975, Turbo Hydra-Matic 400 M40 Transmission.	W39341	1
Valve Body Cover Gasket			1964-1975, Turbo Hydra-Matic 400 M40 Transmission, Tuff-Cork.	W39341TC	1
1995-1996, Turbo Hydra-Matic 4T60E M13 Transaxle, Tuff-Cork.	W39373TC	1	SEVILLE		
1988-1993, Turbo Hydra-Matic 440 ME9 Transaxle, Turbo Hydra-Matic 4T60E M13 Transaxle, Tuff-Cork.	W39373TC	1	Transaxle Pan Gasket		
1984, Turbo Hydra-Matic 125 M34, MD9 Transaxle, Turbo Hydra-Matic 125C MD9 Transaxle, Tuff-Cork.	W39368TC	1	1991-1995, Turbo Hydra-Matic 4T60E M13 Transaxle, Tuff-Cork.	W31180TC	1
			1983-1990, Turbo Hydra-Matic 440 T4 ME9 Transaxle, Tuff-Cork.	W39369TC	1
			Transmission Pan Gasket		
			1994-1995, Turbo Hydra-Matic 4L60E M30 Transmission.	W39365	1
			1994-1995, Turbo Hydra-Matic 4L60E M30 Transmission, Tuff-Cork.	W39365TC	1
			1978-1985, Turbo Hydra-Matic 325 M32, M57 Transaxle.	W39355	1

Transmission Gaskets (cont.)

<i>Model & Application</i>	<i>Part No.</i>	<i>Qty.</i>	<i>Model & Application</i>	<i>Part No.</i>	<i>Qty.</i>
SEVILLE (cont.)			SKYHAWK (cont.)		
Transmission Pan Gasket (cont.)			Valve Body Cover Gasket (cont.)		
1978-1985, Turbo Hydra-Matic 325 M32, M57 Transaxle, Tuff-Cork.	W39355TC	1	1982-1983, Turbo Hydra-Matic 125C MD9 Transaxle, Tuff-Cork.	W39368TC	1
1978-1981, Turbo Hydra-Matic 200 M29, MV9 Transmission.	W39045	1	1982, Turbo Hydra-Matic 125 M34, MD9 Transaxle, Tuff-Cork.	W39368TC	1
1978-1981, Turbo Hydra-Matic 200 M29, MV9 Transmission, Tuff-Cork.	W39045TC	1	SKYLARK		
1976, Turbo Hydra-Matic 325 M32, M57 Transaxle.	W39355	1	Transaxle Pan Gasket		
1976, Turbo Hydra-Matic 325 M32, M57 Transaxle, Tuff-Cork.	W39355TC	1	1994-1996, Turbo Hydra-Matic 125C MD9 Transaxle, Tuff-Cork.	W39356TC	1
1975-1985, Turbo Hydra-Matic 400 M40 Transmission.	W39341	1	1994-1996, Turbo Hydra-Matic 4T60E M13 Transaxle, Tuff-Cork.	W31180TC	1
1975-1985, Turbo Hydra-Matic 400 M40 Transmission, Tuff-Cork.	W39341TC	1	1992-1993, Turbo Hydra-Matic 125 M34, MD9 Transaxle, Turbo Hydra-Matic 125C MD9 Transaxle, Tuff-Cork.	W39356TC	1
Valve Body Cover Gasket			1990-1993, Turbo Hydra-Matic 125 M34, MD9 Transaxle, Tuff-Cork.	W39356TC	1
1991-1995, Turbo Hydra-Matic 4T60E M13 Transaxle, Tuff-Cork.	W39373TC	1	1989-1991, Turbo Hydra-Matic 125 M34, MD9 Transaxle, Turbo Hydra-Matic 125C MD9 Transaxle, Tuff-Cork.	W39356TC	1
1983-1990, Turbo Hydra-Matic 440 T4 ME9 Transaxle, Tuff-Cork.	W39373TC	1	1988-1991, Turbo Hydra-Matic 125 M34, MD9 Transaxle, Tuff-Cork.	W39356TC	1
SKYHAWK			1988-1989, Turbo Hydra-Matic 125 M34, MD9 Transaxle, Turbo Hydra-Matic 125C MD9 Transaxle, Tuff-Cork.	W39356TC	1
Transaxle Pan Gasket			1986-1992, Turbo Hydra-Matic 125 M34, MD9 Transaxle, Tuff-Cork.	W39356TC	1
1986, Turbo Hydra-Matic 125 M34, MD9 Transaxle, Tuff-Cork.	W39356TC	1	1982-1991, Turbo Hydra-Matic 125 M34, MD9 Transaxle, Turbo Hydra-Matic 125C MD9 Transaxle, Tuff-Cork.	W39356TC	1
1983-1989, Turbo Hydra-Matic 125 M34, MD9 Transaxle, Turbo Hydra-Matic 125C MD9 Transaxle, Tuff-Cork.	W39356TC	1	1982-1983, Turbo Hydra-Matic 125C MD9 Transaxle, Tuff-Cork.	W39356TC	1
1982-1983, Turbo Hydra-Matic 125C MD9 Transaxle, Tuff-Cork.	W39356TC	1	1981-1985, Turbo Hydra-Matic 125 M34, MD9 Transaxle, Turbo Hydra-Matic 125C MD9 Transaxle, Tuff-Cork.	W39356TC	1
1980, Turbo Hydra-Matic 125 M34, MD9 Transaxle, Tuff-Cork.	W39356TC	1	1981-1983, Turbo Hydra-Matic 125C MD9 Transaxle, Tuff-Cork.	W39356TC	1
Transmission Gasket Set			1980-1987, Turbo Hydra-Matic 125 M34, MD9 Transaxle, Tuff-Cork.	W39356TC	1
1978-1980, 3 Speed Transmission	TS14737W	1	1980-1983, Turbo Hydra-Matic 125 M34, MD9 Transaxle, Turbo Hydra-Matic 125C MD9 Transaxle, Tuff-Cork.	W39356TC	1
Transmission Pan Gasket			Transmission Gasket Set		
1982-1983, Turbo Hydra-Matic 200 M29, MV9 Transmission.	W39045	1	1976-1981, 3 Speed Transmission	TS14737W	1
1982-1983, Turbo Hydra-Matic 200 M29, MV9 Transmission, Tuff-Cork.	W39045TC	1	1975-1976, 3 Speed Transmission, 4 Speed Transmission.	TS14737W	1
1982-1983, Turbo Hydra-Matic 325 M32, M57 Transaxle, Tuff-Cork.	W39355TC	1	1975-1976, Muncie 3 Speed Transmission	TS27594	1
1979-1980, Turbo Hydra-Matic 325 M32, M57 Transaxle, Tuff-Cork.	W39355TC	1	1975-1976, Muncie 4 Speed Transmission	TS27824W	1
1978-1980, Turbo Hydra-Matic 250C M38 Transmission, Turbo Hydra-Matic 350, 375 M31, M33, MV4, MX2, MX5 Transmission.	W39348	1	1971-1972, 3 Speed Transmission	TS14737W	1
1978-1980, Turbo Hydra-Matic 250C M38 Transmission, Turbo Hydra-Matic 350, 375 M31, M33, MV4, MX2, MX5 Transmission, Tuff-Cork.	W39348TC	1	1970, 3 Speed Transmission, Floor Shift	TS27594	1
1976-1980, Turbo Hydra-Matic 200 M29, MV9 Transmission.	W39045	1	1967-1969, 3 Speed Transmission, Column Shift	TS14737W	1
1976-1980, Turbo Hydra-Matic 200 M29, MV9 Transmission, Tuff-Cork.	W39045TC	1	1967-1969, 3 Speed Transmission, Floor Shift.	TS27817X	1
1975-1979, Turbo Hydra-Matic 350, 375 M31, M33, MV4, MX2, MX5 Transmission.	W39348	1	1967-1969, 4 Speed Transmission	TS27824	1
1975-1979, Turbo Hydra-Matic 350, 375 M31, M33, MV4, MX2, MX5 Transmission, Tuff-Cork.	W39348TC	1	1966, 4 Speed Transmission	TS27075W	1
Valve Body Cover Gasket			1965-1966, 3 Speed Transmission, Column Shift.	TS27817X	1
1986, Turbo Hydra-Matic 125 M34, MD9 Transaxle, Tuff-Cork.	W39368TC	1	1965-1966, 4 Speed Transmission, Floor Shift.	TS27075W	1
1983-1989, Turbo Hydra-Matic 125 M34, MD9 Transaxle, Turbo Hydra-Matic 125C MD9 Transaxle, Tuff-Cork.	W39368TC	1	1964-1966, 3 Speed Transmission, 4 Speed Transmission, Floor Shift.	TS27075W	1
1983, Turbo Hydra-Matic 440 ME9 Transaxle, Tuff-Cork.	W39373TC	1	1964-1965, 3 Speed Transmission, Column Shift.	TS27011W	1
			1961-1963, 3 Speed Transmission	TS27817X	1
			1961-1963, 4 Speed Transmission	TS27075Z	1

PASSENGER CAR

General Motors Corp. (cont.)

Transmission Gaskets (cont.)

<i>Model & Application</i>	<i>Part No.</i>	<i>Qty.</i>	<i>Model & Application</i>	<i>Part No.</i>	<i>Qty.</i>
SKYLARK (cont.)			SKYLARK (cont.)		
Transmission Pan Gasket			Valve Body Cover Gasket (cont.)		
1981-1983, Turbo Hydra-Matic 200 4R MW9 Transmission	W39361	1	1988-1989, Turbo Hydra-Matic 125 M34, MD9 Transaxle, Turbo Hydra-Matic 125C MD9 Transaxle, Tuff-Cork	W39368TC	1
1981-1983, Turbo Hydra-Matic 200 4R MW9 Transmission, Tuff-Cork	W39361TC	1	1986-1992, Turbo Hydra-Matic 125 M34, MD9 Transaxle, Tuff-Cork	W39368TC	1
1980-1986, Turbo Hydra-Matic 325 M32, M57 Transaxle	W39355	1	1983-1989, Turbo Hydra-Matic 440 ME9 Transaxle, Tuff-Cork	W39373TC	1
1979-1986, Turbo Hydra-Matic 325 M32, M57 Transaxle, Tuff-Cork	W39355TC	1	1982-1991, Turbo Hydra-Matic 125 M34, MD9 Transaxle, Turbo Hydra-Matic 125C MD9 Transaxle, Tuff-Cork	W39368TC	1
1979-1980, Turbo Hydra-Matic 325 M32, M57 Transaxle	W39355	1	1982-1983, Turbo Hydra-Matic 125C MD9 Transaxle, Tuff-Cork	W39368TC	1
1977-1980, Turbo Hydra-Matic 250C M38 Transmission, Turbo Hydra-Matic 350, 375 M31, M33, MV4, MX2, MX5 Transmission. . .	W39348	1	1981-1985, Turbo Hydra-Matic 125 M34, MD9 Transaxle, Turbo Hydra-Matic 125C MD9 Transaxle, Tuff-Cork	W39368TC	1
1977-1980, Turbo Hydra-Matic 250C M38 Transmission, Turbo Hydra-Matic 350, 375 M31, M33, MV4, MX2, MX5 Transmission, Tuff-Cork	W39348TC	1	1981-1983, Turbo Hydra-Matic 125C MD9 Transaxle, Tuff-Cork	W39368TC	1
1977-1980, Turbo Hydra-Matic 400 M40 Transmission	W39341	1	1980-1983, Turbo Hydra-Matic 125 M34, MD9 Transaxle, Turbo Hydra-Matic 125C MD9 Transaxle, Tuff-Cork	W39368TC	1
1977-1980, Turbo Hydra-Matic 400 M40 Transmission, Tuff-Cork	W39341TC	1	SOMERSET		
1976-1980, Turbo Hydra-Matic 200 M29, MV9 Transmission.	W39045	1	Transaxle Pan Gasket		
1976-1980, Turbo Hydra-Matic 200 M29, MV9 Transmission, Tuff-Cork	W39045TC	1	1994-1995, Turbo Hydra-Matic 4T60E M13 Transaxle, Tuff-Cork	W31180TC	1
1976-1979, Turbo Hydra-Matic 350, 375 M31, M33, MV4, MX2, MX5 Transmission. . .	W39348	1	1993-1995, Turbo Hydra-Matic 125C MD9 Transaxle, Tuff-Cork	W39356TC	1
1976-1979, Turbo Hydra-Matic 350, 375 M31, M33, MV4, MX2, MX5 Transmission, Tuff-Cork	W39348TC	1	1988-1989, Turbo Hydra-Matic 125 M34, MD9 Transaxle, Tuff-Cork	W39356TC	1
1975-1976, Turbo Hydra-Matic 250, 350 M31, M33, M38, MV4, MX2 Transmission. . .	W39348	1	1985-1989, Turbo Hydra-Matic 125 M34, MD9 Transaxle, Turbo Hydra-Matic 125C MD9 Transaxle, Tuff-Cork	W39356TC	1
1975-1976, Turbo Hydra-Matic 250, 350 M31, M33, M38, MV4, MX2 Transmission, Tuff-Cork	W39348TC	1	Valve Body Cover Gasket		
1971, Turbo Hydra-Matic 400 M40 Transmission	W39341	1	1994-1995, Turbo Hydra-Matic 4T60E M13 Transaxle, Tuff-Cork	W39373TC	1
1971, Turbo Hydra-Matic 400 M40 Transmission, Tuff-Cork	W39341TC	1	1993-1995, Turbo Hydra-Matic 125C MD9 Transaxle, Tuff-Cork	W39368TC	1
1967-1969, Turbo Hydra-Matic 400 M40 Transmission	W39341	1	1993, Turbo Hydra-Matic 440 ME9 Transaxle, Tuff-Cork	W39373TC	1
1967-1969, Turbo Hydra-Matic 400 M40 Transmission, Tuff-Cork	W39341TC	1	1988-1989, Turbo Hydra-Matic 125 M34, MD9 Transaxle, Tuff-Cork	W39368TC	1
1964-1972, Turbo Hydra-Matic 350, 375 M31, M33, MV4, MX2, MX5 Transmission. . .	W39348	1	1985-1989, Turbo Hydra-Matic 125 M34, MD9 Transaxle, Turbo Hydra-Matic 125C MD9 Transaxle, Tuff-Cork	W39368TC	1
1964-1972, Turbo Hydra-Matic 350, 375 M31, M33, MV4, MX2, MX5 Transmission, Tuff-Cork	W39348TC	1	1985-1989, Turbo Hydra-Matic 440 ME9 Transaxle, Tuff-Cork	W39373TC	1
1961-1963, Dual Path Automatic Transmission	W39108	1	SPECIAL		
Valve Body Cover Gasket			Transmission Gasket Set		
1994-1996, Turbo Hydra-Matic 125C MD9 Transaxle, Tuff-Cork	W39368TC	1	1967-1969, 3 Speed Transmission, Column Shift	TS14737W	1
1994-1996, Turbo Hydra-Matic 4T60E M13 Transaxle, Tuff-Cork	W39373TC	1	1967-1969, 4 Speed Transmission	TS27824	1
1992-1993, Turbo Hydra-Matic 125 M34, MD9 Transaxle, Turbo Hydra-Matic 125C MD9 Transaxle, Tuff-Cork	W39368TC	1	1966-1969, 3 Speed Transmission, Floor Shift	TS27817X	1
1990-1993, Turbo Hydra-Matic 125 M34, MD9 Transaxle, Tuff-Cork	W39368TC	1	1964-1966, 4 Speed Transmission	TS27075W	1
1989-1991, Turbo Hydra-Matic 125 M34, MD9 Transaxle, Turbo Hydra-Matic 125C MD9 Transaxle, Tuff-Cork	W39368TC	1	1964-1965, 3 Speed Transmission, Column Shift	TS27011W	1
1988-1991, Turbo Hydra-Matic 125 M34, MD9 Transaxle, Tuff-Cork	W39368TC	1	1961-1963, 4 Speed Transmission	TS27075Z	1
Transmission Pan Gasket			Transmission Pan Gasket		
1964-1969, Turbo Hydra-Matic 350, 375 M31, M33, MV4, MX2, MX5 Transmission. . .	W39348	1	1964-1969, Turbo Hydra-Matic 350, 375 M31, M33, MV4, MX2, MX5 Transmission, Tuff-Cork	W39348TC	1
1964-1969, Turbo Hydra-Matic 350, 375 M31, M33, MV4, MX2, MX5 Transmission, Tuff-Cork	W39348TC	1	1961-1963, Dual Path Automatic Transmission	W39108	1

Transmission Gaskets (cont.)

<i>Model & Application</i>	<i>Part No.</i>	<i>Qty.</i>	<i>Model & Application</i>	<i>Part No.</i>	<i>Qty.</i>
SPECIAL (cont.)			STARFIRE (cont.)		
Transmission Gasket Set			Transmission Pan Gasket (cont.)		
1949-1952, 3 Speed Transmission	TS26250X	1	1976-1980, Turbo Hydra-Matic 250, 350 M31, M33, M38, MV4, MX2 Transmission	W39348	1
SPECIAL 150			1976-1980, Turbo Hydra-Matic 250, 350 M31, M33, M38, MV4, MX2 Transmission, Tuff-Cork	W39348TC	1
Transmission Gasket Set			1965-1966, Turbo Hydra-Matic 375, 400 M40 Transmission	W39341	1
1957, 4 Speed Transmission	TS27075W	1	1965-1966, Turbo Hydra-Matic 375, 400 M40 Transmission, Tuff-Cork	W39341TC	1
1956-1957, 3 Speed Transmission, Seals Not Included.	TS27061	1	STORM		
1955-1957, 3 Speed Transmission, Contains Seals	TS27011W	1	Transaxle Pan Gasket		
1953-1954, 3 Speed Transmission	TS26250X	1	1990-1993, 4 Speed Automatic Transaxle	W31373	1
SPECIAL DELUXE			1990-1992, 3 Speed Automatic Transaxle, Tuff-Cork	W29099TC	1
Transmission Gasket Set			STYLEMASTER		
1940-1941, 3 Speed Transmission	TS26250X	1	Transmission Gasket Set		
SPECTRUM			1946-1948, 3 Speed Transmission	TS26250X	1
Transaxle Pan Gasket			SUNBIRD		
1985-1989, Automatic Transmission, Tuff-Cork	W29099TC	1	Transaxle Pan Gasket		
SPRINT			1991-1994, Turbo Hydra-Matic 4T60E M13 Transaxle, Tuff-Cork	W31180TC	1
Transmission Pan Gasket			1991-1993, Turbo Hydra-Matic 440 T4 ME9 Transaxle, Tuff-Cork	W39369TC	1
1985-1991, Automatic Transmission	W38031	1	1986-1994, Turbo Hydra-Matic 125 M34, MD9 Transaxle, Tuff-Cork	W39356TC	1
STAR CHIEF			1980, Turbo Hydra-Matic 125 M34, MD9 Transaxle, Tuff-Cork	W39356TC	1
Transmission Gasket Set			Transmission Gasket Set		
1964-1965, 3 Speed Transmission, Heavy Duty 3 Speed Transmission, Second Type	TS27817X	1	1976-1980, Muncie 3 Speed Transmission	TS27594	1
1964-1965, Muncie 4 Speed Transmission	TS27824	1	1976-1980, Muncie 4 Speed Transmission	TS27824W	1
1961-1964, 3 Speed Transmission, Except Heavy Duty Transmission	TS27061	1	1976-1980, Saginaw 3 Speed Transmission, Saginaw 4 Speed Transmission	TS14737W	1
1961-1963, 4 Speed Transmission	TS27075W	1	Transmission Pan Gasket		
Transmission Pan Gasket			1976-1980, Turbo Hydra-Matic 200 M29, MV9 Transmission	W39045	1
1964-1965, Automatic M35 Transmission	W39007	1	1976-1980, Turbo Hydra-Matic 200 M29, MV9 Transmission, Tuff-Cork	W39045TC	1
STAR CHIEF EXECUTIVE			1976-1980, Turbo Hydra-Matic 250, 350, 375 M31, M33, M38, VMV4, MX2, MX3 Transmission	W39348	1
Transmission Gasket Set			1976-1980, Turbo Hydra-Matic 250, 350, 375 M31, M33, M38, VMV4, MX2, MX3 Transmission, Tuff-Cork	W39348TC	1
1966, 3 Speed Transmission, Except Saginaw 3 Speed Transmission	TS27817X	1	Valve Body Cover Gasket		
1966, Except Heavy Duty Transmission, Saginaw 3 Speed Transmission, Saginaw 4 Speed Transmission	TS14737W	1	1991-1994, Turbo Hydra-Matic 4T60E M13 Transaxle, Tuff-Cork	W39373TC	1
1966, Muncie 4 Speed Transmission	TS27824	1	1991-1993, Turbo Hydra-Matic 440 T4 ME9 Transaxle, Turbo Hydra-Matic 4T60E M13 Transaxle, Tuff-Cork	W39373TC	1
Transmission Pan Gasket			1986-1994, Turbo Hydra-Matic 125 M34, MD9 Transaxle, Tuff-Cork	W39368TC	1
1966, Automatic M35 Transmission	W39007	1	1980, Turbo Hydra-Matic 125 M34, MD9 Transaxle, Tuff-Cork	W39368TC	1
STARFIRE			SUNBURST		
Transmission Gasket Set			Transaxle Pan Gasket		
1977-1980, 3 Speed Transmission, 4 Speed Transmission	TS14737W	1	1985-1988, Automatic Transmission, Tuff-Cork	W29099TC	1
1966, 3 Speed Transmission, Heavy Duty 3 Speed Transmission	TS27817X	1	SUNFIRE		
1965-1966, 4 Speed Transmission	TS27824	1	Transaxle Pan Gasket		
Transmission Pan Gasket			1997-2001, Turbo Hydra-Matic 3T40 MD9 Transaxle, Tuff-Cork	W39356TC	1
1979-1980, Turbo Hydra-Matic 325 M32, M57 Transaxle	W39355	1			
1979-1980, Turbo Hydra-Matic 325 M32, M57 Transaxle, Tuff-Cork	W39355TC	1			
1977-1979, Turbo Hydra-Matic 375, 400 M40 Transmission	W39341	1			
1977-1979, Turbo Hydra-Matic 375, 400 M40 Transmission, Tuff-Cork	W39341TC	1			
1976-1980, Turbo Hydra-Matic 200 M29, MV9 Transmission	W39045	1			
1976-1980, Turbo Hydra-Matic 200 M29, MV9 Transmission, Tuff-Cork	W39045TC	1			

PASSENGER CAR

General Motors Corp. (cont.)

Transmission Gaskets (cont.)

<i>Model & Application</i>	<i>Part No.</i>	<i>Qty.</i>	<i>Model & Application</i>	<i>Part No.</i>	<i>Qty.</i>
SUNFIRE (cont.)			TEMPEST LEMANS		
Transaxle Pan Gasket (cont.)			Transmission Gasket Set		
1995, Turbo Hydra-Matic 3T40 MD9 Transaxle, Tuff-Cork	W39356TC	1	1966, 3 Speed Transmission, Except Saginaw 3 Speed Transmission	TS27817X	1
Valve Body Cover Gasket			1966, Except Heavy Duty Transmission, Saginaw 3 Speed Transmission, Saginaw 4 Speed Transmission.	TS14737W	1
1997-2001, Turbo Hydra-Matic 3T40 MD9 Transaxle, Tuff-Cork	W39368TC	1	1964-1966, Muncie 4 Speed Transmission . . .	TS27824	1
1995, Turbo Hydra-Matic 3T40 MD9 Transaxle, Tuff-Cork	W39368TC	1	1964, 3 Speed Transmission, Heavy Duty 3 Speed Transmission, Second Type.	TS27817X	1
SUPER CHIEF			Transmission Pan Gasket		
Transmission Gasket Set			1964-1966, Automatic M35 Transmission		
1958, 3 Speed Transmission, Except Heavy Duty Transmission	TS27061	1	TORONADO		
TEMPEST			Transaxle Pan Gasket		
Transaxle Pan Gasket			1991-1992, Turbo Hydra-Matic 4T60E M13 Transaxle, Tuff-Cork		
1987-1991, Turbo Hydra-Matic 125 M34, MD9 Transaxle, Tuff-Cork	W39356TC	1	1986-1992, Turbo Hydra-Matic 440 T4 ME9 Transaxle, Tuff-Cork	W39369TC	1
Transmission Gasket Set			Transmission Gasket Set		
1971, Muncie 3 Speed Transmission	TS27594	1	1979-1981, 3 Speed Transmission	TS14737W	1
1971, Saginaw 3 Speed Transmission, Saginaw 4 Speed Transmission	TS14737W	1	1966-1967, 3 Speed Transmission, Heavy Duty 3 Speed Transmission.	TS27817X	1
1970-1971, Muncie 4 Speed Transmission . .	TS27824W	1	Transmission Pan Gasket		
1970, Heavy Duty 3 Speed Transmission, Saginaw 3 Speed Transmission	TS14737W	1	1966-1976, Turbo Hydra-Matic 425 Transmission.		
1969-1970, Muncie 3 Speed Transmission, Muncie 4 Speed Transmission	TS27594	1	Valve Body Cover Gasket		
1969-1970, Saginaw 4 Speed Transmission .	TS14737W	1	1991-1992, Turbo Hydra-Matic 440 T4 ME9 Transaxle, Turbo Hydra-Matic 4T60E M13 Transaxle, Tuff-Cork		
1969, 3 Speed Transmission, Except Saginaw 3 Speed Transmission	TS27817X	1	1986-1990, Turbo Hydra-Matic 440 T4 ME9 Transaxle, Tuff-Cork		
1969, Muncie 4 Speed Transmission	TS27594	1	TOWNSMAN		
1968-1969, 3 Speed Transmission, Except Saginaw 3 Speed Transmission, Heavy Duty 3 Speed Transmission.	TS27817X	1	Transmission Gasket Set		
1968, 3 Speed Transmission, Heavy Duty 3 Speed Transmission	TS27817X	1	1956-1957, 3 Speed Transmission, Seals Not Included.		
1967, 3 Speed Transmission, Except Heavy Duty Transmission, Except Saginaw 3 Speed Transmission	TS27817X	1	1956-1957, 4 Speed Transmission		
1966-1969, Except Heavy Duty Transmission, Saginaw 3 Speed Transmission, Saginaw 4 Speed Transmission	TS14737W	1	1955-1957, 3 Speed Transmission, Contains Seals.		
1966, 3 Speed Transmission, Except Saginaw 3 Speed Transmission	TS27817X	1	1954, 3 Speed Transmission		
1965, 3 Speed Transmission, Except Heavy Duty Transmission	TS27061	1	VEGA		
1964-1968, Muncie 4 Speed Transmission . . .	TS27824	1	Transmission Gasket Set		
1964, 3 Speed Transmission, Heavy Duty 3 Speed Transmission, Second Type.	TS27817X	1	1976-1977, 4 Speed Transmission		
1961-1963, 4 Speed Transmission	TS27075W	1	1975-1977, Saginaw 3 Speed Transmission .		
Transmission Pan Gasket			1971-1974, Muncie 3 Speed Transmission . . .		
1969-1971, Turbo Hydra-Matic 250, 350, 375 M31, M33, M38, VMV4, MX2, MX3 Transmission	W39348	1	1971-1972, Muncie 4 Speed Transmission . .		
1969-1971, Turbo Hydra-Matic 250, 350, 375 M31, M33, M38, VMV4, MX2, MX3 Transmission, Tuff-Cork	W39348TC	1	1971, Saginaw 3 Speed Transmission		
1969-1971, Turbo Hydra-Matic 375, 400 M40 Transmission.	W39341	1	Transmission Pan Gasket		
1969-1971, Turbo Hydra-Matic 375, 400 M40 Transmission, Tuff-Cork	W39341TC	1	1971-1973, Powerglide Transmission, Torque Drive		
1964-1969, Automatic M35 Transmission	W39007	1	VENTURA		
1961-1962, Powerglide Transmission	W38765	1	Transmission Gasket Set		
Valve Body Cover Gasket			1977, Saginaw 3 Speed Transmission, Saginaw 4 Speed Transmission		
1987-1991, Turbo Hydra-Matic 125 M34, MD9 Transaxle.	W39368TC	1	1976, Saginaw 3 Speed Transmission		
			1975-1976, Saginaw 3 Speed Transmission, Saginaw 4 Speed Transmission		
			1974, Saginaw 4 Speed Transmission		
			1973-1977, Muncie 3 Speed Transmission . . .		
			1973-1977, Muncie 4 Speed Transmission . .		
			1973-1977, Saginaw 3 Speed Transmission, Saginaw 4 Speed Transmission		
			1973-1974, Saginaw 3 Speed Transmission .		

Transmission Gaskets (cont.)					
Model & Application		Part No.	Qty.	Model & Application	
VENTURA (cont.)			VISTA CRUISER (cont.)		
Transmission Gasket Set (cont.)			Transmission Gasket Set (cont.)		
1961, 3 Speed Transmission, Except Heavy Duty Transmission		TS27061	1	1966-1970, 3 Speed Transmission, Heavy Duty 3 Speed Transmission	
1961, 4 Speed Transmission		TS27075W	1	1965, 3 Speed Transmission	
				1964-1973, 4 Speed Transmission	
Transmission Pan Gasket			Transmission Pan Gasket		
1976-1977, Turbo Hydra-Matic 200 M29, MV9 Transmission.		W39045	1	1969-1975, Turbo Hydra-Matic 250, 350 M31, M33, M38, MV4, MX2 Transmission.	
1976-1977, Turbo Hydra-Matic 200 M29, MV9 Transmission, Tuff-Cork.		W39045TC	1	1969-1975, Turbo Hydra-Matic 250, 350 M31, M33, M38, MV4, MX2 Transmission, Tuff-Cork	
1973-1977, Turbo Hydra-Matic 250, 350, 375 M31, M33, M38, VMV4, MX2, MX3 Transmission.		W39348	1	1968-1975, Turbo Hydra-Matic 375, 400 M40 Transmission.	
1973-1977, Turbo Hydra-Matic 250, 350, 375 M31, M33, M38, VMV4, MX2, MX3 Transmission, Tuff-Cork.		W39348TC	1	1968-1975, Turbo Hydra-Matic 375, 400 M40 Transmission, Tuff-Cork.	
1973-1974, Turbo Hydra-Matic 375, 400 M40 Transmission.		W39341	1		
1973-1974, Turbo Hydra-Matic 375, 400 M40 Transmission, Tuff-Cork.		W39341TC	1		
1973, Automatic M35 Transmission		W39007	1		
VENTURA II			WILD CAT		
Transmission Gasket Set			Transmission Gasket Set		
1972, Saginaw 3 Speed Transmission		TS14737W	1	1970, 3 Speed Transmission, Floor Shift	
1971-1972, Muncie 3 Speed Transmission		TS27594	1	1967-1970, 3 Speed Transmission, Column Shift	
1971-1972, Muncie 4 Speed Transmission		TS27824W	1	1967-1969, 3 Speed Transmission, Floor Shift.	
1971-1972, Saginaw 3 Speed Transmission, Saginaw 4 Speed Transmission.		TS14737W	1	1967-1969, 4 Speed Transmission	
				1966, 3 Speed Transmission, Column Shift, Floor Shift	
Transmission Pan Gasket			Transmission Pan Gasket		
1972, Turbo Hydra-Matic 375, 400 M40 Transmission.		W39341	1	1964-1966, 3 Speed Transmission, 4 Speed Transmission, Floor Shift	
1972, Turbo Hydra-Matic 375, 400 M40 Transmission, Tuff-Cork.		W39341TC	1		
1971-1972, Automatic M35 Transmission		W39007	1		
1971-1972, Turbo Hydra-Matic 250, 350, 375 M31, M33, M38, VMV4, MX2, MX3 Transmission.		W39348	1		
1971-1972, Turbo Hydra-Matic 250, 350, 375 M31, M33, M38, VMV4, MX2, MX3 Transmission, Tuff-Cork.		W39348TC	1		
VISTA CRUISER			YEOMAN		
Transmission Gasket Set			Transmission Gasket Set		
1974-1975, 4 Speed Transmission		TS14737W	1	1958, 3 Speed Transmission, Contains Seals.	
1972-1975, 3 Speed Transmission		TS14737W	1	1958, 3 Speed Transmission, Seals Not Included.	
1971-1972, 3 Speed Transmission, Except Heavy Duty Transmission.		TS14737W	1	1958, 4 Speed Transmission	
1971, 3 Speed Transmission, Heavy Duty 3 Speed Transmission.		TS27594	1		
			Transmission Pan Gasket		
			1958, Powerglide Transmission		
			W38765		
			1		

Honda

Transmission Gaskets					
Model & Application		Part No.	Qty.	Model & Application	
ACCORD			CIVIC		
Transmission Gasket Set			Transmission Gasket Set		
1984-1985, 5 Speed Manual Transaxle		TS20614	1	1984-1985, 4 Speed Manual Transaxle, 5 Speed Manual Transaxle	
1976-1978, 5 Speed Manual Transaxle		TS29092	1	1975-1983, 4 Speed Manual Transaxle, 5 Speed Manual Transaxle, CVCC.	
				1975-1979, 4 Speed Manual Transaxle, 5 Speed Manual Transaxle, Except CVCC.	
				TS29091	
				1	

Honda (cont.)

Transmission Gaskets (cont.)

<i>Model & Application</i>	<i>Part No.</i>	<i>Qty.</i>	<i>Model & Application</i>	<i>Part No.</i>	<i>Qty.</i>
CIVIC (cont.)			PRELUDE		
Transmission Gasket Set (cont.)			Transmission Gasket Set		
1974, 4 Speed Manual Transaxle, 5 Speed Manual Transaxle	TS29091	1	1983-1985, 5 Speed Manual Transaxle	TS20614	1
1973, 4 Speed Manual Transaxle, 5 Speed Manual Transaxle, Except CVCC.	TS29091	1			

Mazda

Transmission Gaskets

<i>Model & Application</i>	<i>Part No.</i>	<i>Qty.</i>	<i>Model & Application</i>	<i>Part No.</i>	<i>Qty.</i>
323			GLC (cont.)		
Transmission Pan Gasket			Transmission Gasket Set		
1988-1992, 2 Wheel Drive, Automatic Transmission, Tuff-Cork	W31182TC	1	1981-1985, 4 Speed Transmission, 5 Speed Transmission	TS29104	1
1988-1989, 4 Wheel Drive, Automatic Transmission, Tuff-Cork	W31170TC	1			
626			MX6		
Transmission Pan Gasket			Transmission Pan Gasket		
1988-1991, Automatic Transmission, Tuff-Cork	W31170TC	1	1988-1991, Automatic Transmission, Tuff-Cork	W31170TC	1
1988-1991, Automatic Transmission, Tuff-Cork	W31174TC	1	1988-1991, Automatic Transmission, Tuff-Cork	W31174TC	1
1986-1987, 4 Speed Transmission, Tuff-Cork	W31175TC	1			
929			MIATA MX5		
Transmission Pan Gasket			Transmission Pan Gasket		
1988-1991, Automatic Transmission, Tuff-Cork	W31171TC	1	1990-1992, Automatic Transmission, Tuff-Cork	W31171TC	1
GLC			PROTEGE		
Transaxle Pan Gasket			Transaxle Pan Gasket		
1981-1985, Automatic Transmission	W29097	1	1990-1991, 4 Wheel Drive	W31170TC	1
			Transmission Pan Gasket		
			1990-1998, Automatic Transmission, Tuff-Cork	W31182TC	1

Mitsubishi

Transmission Gaskets

<i>Model & Application</i>	<i>Part No.</i>	<i>Qty.</i>	<i>Model & Application</i>	<i>Part No.</i>	<i>Qty.</i>
GALANT			TREDIA		
Transaxle Pan Gasket			Transaxle Pan Gasket		
1985-1990, Automatic Transmission	W28798	1	1983-1988, Automatic Transmission	W28798	1
MIRAGE					
Transaxle Pan Gasket					
1985-1993, Automatic Transmission	W28798	1			
PRECIS					
Transaxle Pan Gasket					
1987-1988, Automatic Transmission	W28798	1			
STARION					
Transmission Pan Gasket					
1983-1989, Automatic Transmission	W39108	1			

Differential Housing Cover Gaskets

<i>Model & Application</i>	<i>Part No.</i>	<i>Qty.</i>	<i>Model & Application</i>	<i>Part No.</i>	<i>Qty.</i>
1200 (B110)			300ZX		
Diff. Hsg. Cover Gasket			Diff. Hsg. Cover Gasket		
1973, H145A Differential, Thru 8/73	P29068	1	1984-1989, R200 Differential	P29075	1
1972, H145A Differential	P29068	1			
1971, From 4/71, H145A Differential	P29068	1			
200SX			510		
Diff. Hsg. Cover Gasket			Diff. Hsg. Cover Gasket		
1986-1988, R180 Differential	P29074	1	1979-1981, H165R Differential	P29073	1
1984-1985, R200 Differential	P29075	1	1979-1981, H190 Differential	P29105	1
1983, From 10/83, R200 Differential	P29075	1	1978, From 7/78, H165R Differential	P29073	1
1982-1985, H190 Differential	P29105	1	1978, From 7/78, H190 Differential	P29105	1
1981, From 7/81, H190 Differential	P29105	1	1968-1973, R160 Differential	P38146	1
1981, H165B Differential, Thru 6/81	P29073	1			
1977-1980, H165B Differential	P29073	1			
210			610		
Diff. Hsg. Cover Gasket			Diff. Hsg. Cover Gasket		
1982, H145 Differential, H150 Differential, Thru 1/82	P29068	1	1976, H190 Differential, Thru 9/76	P29105	1
1979-1981, H145 Differential, H150 Differential	P29068	1	1975, H190 Differential	P29105	1
			1973-1974, From 8/73, H190 Differential	P29105	1
			1973, From 1/73, H165B Differential, Thru 7/73	P29073	1
240SX			710		
Diff. Hsg. Cover Gasket			Diff. Hsg. Cover Gasket		
1989-1993, RC40 Differential	P29075	1	1977, H165B Differential, Thru 6/77	P29073	1
			1974-1976, H165B Differential	P29073	1
			1974, From 9/73, H165B Differential	P29073	1
240Z			810		
Diff. Hsg. Cover Gasket			Diff. Hsg. Cover Gasket		
1973, From 10/73, R200 Differential	P29075	1	1977-1981, H190 Differential	P29105	1
1970-1973, R180 Differential	P29074	1	1977-1981, R180 Differential	P29074	1
260Z			B210		
Diff. Hsg. Cover Gasket			Diff. Hsg. Cover Gasket		
1974, R180 Differential	P29074	1	1974-1978, H145 Differential, H150 Differential	P29068	1
1974, R200 Differential	P29075	1	1973, From 7/73, H145 Differential, H150 Differential	P29068	1
280Z			MAXIMA		
Diff. Hsg. Cover Gasket			Diff. Hsg. Cover Gasket		
1975-1978, R180 Differential	P29074	1	1984, H190 Differential, Thru 6/84	P29105	1
1975-1978, R200 Differential	P29075	1	1984, R180 Differential, Thru 6/84	P29074	1
280ZX			1982-1983, H190 Differential		
Diff. Hsg. Cover Gasket			1982-1983, R180 Differential		
1983, R180 Differential, Thru 6/83	P29074	1		P29074	1
1979-1983, R200 Differential	P29075	1			
1979-1982, R180 Differential	P29074	1			

Transmission Gaskets

<i>Model & Application</i>	<i>Part No.</i>	<i>Qty.</i>	<i>Model & Application</i>	<i>Part No.</i>	<i>Qty.</i>
1200 (B110)			240SX		
Transmission Pan Gasket			Transmission Pan Gasket		
1973, 3N71B Transmission, Thru 8/73	W29051	1	1991-1993, RE4R01A Transaxle, Tuff-Cork	W31183TC	1
1972, 3N71B Transmission	W29051	1			
1971, 3N71B Transmission, From 4/71	W29051	1			
200SX			240Z		
Transmission Pan Gasket			Transmission Gasket Set		
1984, L4N71B Transaxle, Thru 10/84	W29051	1	1970-1973, 4 Speed Transmission	TS29065	1
1983, From 2/83, L4N71B Transaxle	W29051	1	Transmission Pan Gasket		
			1970-1973, 3N71B Transmission	W29051	1
210			260Z		
Transmission Pan Gasket			Transmission Gasket Set		
1982, 3N71B Transmission, Thru 1/82	W29051	1	1974, 4 Speed Transmission	TS29065	1
1979-1981, 3N71B Transmission	W29051	1	Transmission Pan Gasket		
			1974, 3N71B Transmission	W29051	1

Nissan (cont.)

Transmission Gaskets (cont.)

<i>Model & Application</i>	<i>Part No.</i>	<i>Qty.</i>	<i>Model & Application</i>	<i>Part No.</i>	<i>Qty.</i>
280Z			710 (cont.)		
Transmission Gasket Set 1975-1978, 4 Speed Transmission	TS29065	1	Transmission Pan Gasket 1974-1976, 3N71B Transmission	W29051	1
Transmission Pan Gasket 1975-1978, 3N71B Transmission	W29051	1	810		
280ZX			Transmission Pan Gasket 1977-1981, 3N71B Transmission	W29051	1
Transmission Gasket Set 1979-1980, 4 Speed Transmission	TS29065	1	B210		
Transmission Pan Gasket 1983, 3N71B Transmission, Thru 6/83	W29051	1	Transmission Pan Gasket 1974-1978, 3N71B Transmission	W29051	1
1979-1982, 3N71B Transmission	W29051	1	1973, 3N71B Transmission, From 7/73	W29051	1
300ZX			MAXIMA		
Transmission Pan Gasket 1984, 4N71B Transmission, Thru 11/84	W29051	1	Transmission Pan Gasket 1982-1983, 3N71B Transmission, Thru 1/83	W29051	1
310			NX		
Transaxle Gasket 1982, RL3F01A Transaxle, RN3F01A Transaxle, Thru 6/82	W39107	1	Transaxle Gasket 1991-1993, RL3F Transaxle	W39107	1
1979-1981, RL3F01A Transaxle, RN3F01A Transaxle	W39107	1	PULSAR		
510			Transaxle Gasket 1983-1990, RL3F01A Transaxle, RN3F01A Transaxle	W39107	1
Transmission Gasket Set 1968-1973, 4 Speed Transmission	TS29064	1	PULSAR NX		
Transmission Pan Gasket 1968-1973, 3N71B Transmission	W29051	1	Transaxle Gasket 1983-1990, RL3F01A Transaxle, RN3F01A Transaxle	W39107	1
610			SENTRA		
Transmission Gasket Set 1973-1976, 4 Speed Transmission	TS29064	1	Transaxle Gasket 1982-1993, RL3F01A Transaxle, RN3F01A Transaxle	W39107	1
Transmission Pan Gasket 1973-1976, 3N71B Transmission	W29051	1	STANZA		
710			Transaxle Gasket 1982-1992, RL3F01A Transaxle, RN3F01A Transaxle	W39107	1
Transmission Gasket Set 1974-1977, 4 Speed Transmission	TS29064	1			

Opel

Differential Housing Cover Gaskets

<i>Model & Application</i>	<i>Part No.</i>	<i>Qty.</i>	<i>Model & Application</i>	<i>Part No.</i>	<i>Qty.</i>
1900			KADETT		
Diff. Hsg. Cover Gasket 1971-1975	P29076	1	Diff. Hsg. Cover Gasket 1968-1975	P29076	1
ISUZU			MANTA		
Diff. Hsg. Cover Gasket 1976-1979	P29076	1	Diff. Hsg. Cover Gasket 1973-1975	P29076	1

Transmission Gaskets

<i>Model & Application</i>	<i>Part No.</i>	<i>Qty.</i>	<i>Model & Application</i>	<i>Part No.</i>	<i>Qty.</i>
ISUZU					
Transmission Pan Gasket 1976-1979, Automatic Transmission	W39045	1			

Transmission Gaskets				
<i>Model & Application</i>	<i>Part No.</i>	<i>Qty.</i>	<i>Model & Application</i>	<i>Part No. Qty.</i>
181 Transaxle Gasket 1981-1983, Automatic Transmission, Silicone	JV6	1		

Transmission Gaskets				
<i>Model & Application</i>	<i>Part No.</i>	<i>Qty.</i>	<i>Model & Application</i>	<i>Part No. Qty.</i>
900 Transaxle Gasket 1979-1983, Automatic Transmission, Front	W29102	1	99 Transaxle Gasket 1972-1980, Automatic Transmission, Front	W29102 1
1979-1983, Automatic Transmission, Rear	W29103	1		

Transmission Gaskets				
<i>Model & Application</i>	<i>Part No.</i>	<i>Qty.</i>	<i>Model & Application</i>	<i>Part No. Qty.</i>
Transmission Gasket Set 1959-1964, 4 Speed Transmission	TS27075Z	1		
AVANTI Transmission Gasket Set 1964, 4 Speed Transmission	TS27075Z	1		

Transmission Gaskets				
<i>Model & Application</i>	<i>Part No.</i>	<i>Qty.</i>	<i>Model & Application</i>	<i>Part No. Qty.</i>
1400 Transaxle Gasket 1973-1976, Automatic Transmission	W29101	1	XT Transaxle Gasket 1985-1988, Automatic Transmission	W39109 1
1600 Transaxle Gasket 1985-1988, Automatic Transmission	W39109	1		
1976-1984, Automatic Transmission	W29101	1		
1800 Transaxle Gasket 1985-1988, Automatic Transmission	W39109	1		
1980-1984, Automatic Transmission	W29101	1		
Transaxle Pan Gasket 1985-1988, Automatic Transmission	W39109	1		
1980-1984, Automatic Transmission	W29101	1		
JUSTY Transaxle Gasket 1987-1988, Automatic Transmission	W39109	1		
LOYALE Transaxle Gasket 1985-1988, Automatic Transmission	W39109	1		

Toyota

Differential Housing Cover Gaskets

<i>Model & Application</i>	<i>Part No.</i>	<i>Qty.</i>	<i>Model & Application</i>	<i>Part No.</i>	<i>Qty.</i>
CARINA			CORONA MK II		
Diff. Hsg. Cover Gasket			Diff. Hsg. Cover Gasket		
1971-1979	P29072	1	1973-1976, Station Wagon	P29078	1
CELICA			1972	P29078	1
Diff. Hsg. Cover Gasket			1969-1974, Except Station Wagon	P29072	1
1969-1980	P29078	1	CRESSIDA		
CELICA SUPRA			Diff. Hsg. Cover Gasket		
Diff. Hsg. Cover Gasket			1978-1988	P29078	1
1979-1980	P29078	1	CROWN		
COROLLA			Diff. Hsg. Cover Gasket		
Diff. Hsg. Cover Gasket			1971, Thru 1/71	P29078	1
1981-1987	P29078	1	1968-1971, Station Wagon	P29078	1
1971-1979	P29072	1	STARLET		
1968-1979	P29071	1	Diff. Hsg. Cover Gasket		
CORONA			1981-1984	P29071	1
Diff. Hsg. Cover Gasket			TERCEL		
1972-1981	P29078	1	Diff. Hsg. Cover Gasket		
1971, Station Wagon	P29078	1	1980-1988	P29071	1
1970-1974, Except Station Wagon	P29072	1			

Transmission Gaskets

<i>Model & Application</i>	<i>Part No.</i>	<i>Qty.</i>	<i>Model & Application</i>	<i>Part No.</i>	<i>Qty.</i>
CAMRY			CORONA MK II		
Transaxle Gasket			Transaxle Pan Gasket		
1988-1991, Automatic Transmission, Tuff-Cork	W31172TC	1	1973-1976, A40 Transmission, A40D Transmission, A41 Transaxle, A42DL Transaxle, A43D Transmission, Tuff-Cork	W39370TC	1
1987-1991, Automatic Transmission, Tuff-Cork	W29099TC	1	SUPRA		
1983-1984, A140E Transaxle, Tuff-Cork	W29099TC	1	Transaxle Pan Gasket		
CELICA			1986-1988, A40 Transmission, A40D Transmission, A41 Transaxle, A42DL Transaxle, A43D Transmission, Tuff-Cork	W39370TC	1
Transaxle Pan Gasket			TERCEL		
1973-1988, A40 Transmission, A40D Transmission, A41 Transaxle, A42DL Transaxle, A43D Transmission, Tuff-Cork	W39370TC	1	Transaxle Gasket		
CELICA SUPRA			1980-1988, A55 Transaxle, Tuff-Cork	W29098TC	1
Transaxle Pan Gasket					
1979-1986, A40 Transmission, A40D Transmission, A41 Transaxle, A42DL Transaxle, A43D Transmission, Tuff-Cork	W39370TC	1	COROLLA		
COROLLA			Transaxle Gasket		
Transaxle Gasket			1988-1991, 4FC Transaxle, Tuff-Cork	W31173TC	1
1988-1991, 4FC Transaxle, Tuff-Cork	W31173TC	1	1987-1991, 3 Speed Transaxle, Tuff-Cork	W29099TC	1
1987-1991, 3 Speed Transaxle, Tuff-Cork	W29099TC	1	1984, A130L Transaxle, A131L Transaxle, Tuff-Cork	W29099TC	1
1984, A130L Transaxle, A131L Transaxle, Tuff-Cork	W29099TC	1	Transaxle Pan Gasket		
Transaxle Pan Gasket			1998-2001, A131L Transaxle, Tuff-Cork	W29099TC	1
1998-2001, A131L Transaxle, Tuff-Cork	W29099TC	1	1973-1988, A40 Transmission, A40D Transmission, A41 Transaxle, A42DL Transaxle, A43D Transmission, Tuff-Cork	W39370TC	1
1973-1988, A40 Transmission, A40D Transmission, A41 Transaxle, A42DL Transaxle, A43D Transmission, Tuff-Cork	W39370TC	1	CORONA		
Transaxle Pan Gasket			Transaxle Pan Gasket		
1972-1982, A40 Transmission, A40D Transmission, A41 Transaxle, A42DL Transaxle, A43D Transmission, Tuff-Cork	W39370TC	1	1972-1982, A40 Transmission, A40D Transmission, A41 Transaxle, A42DL Transaxle, A43D Transmission, Tuff-Cork	W39370TC	1

Transmission Gaskets

<i>Model & Application</i>	<i>Part No.</i>	<i>Qty.</i>	<i>Model & Application</i>	<i>Part No.</i>	<i>Qty.</i>
DASHER			SCIROCCO (cont.)		
Transmission Gasket Set 1979-1980, Manual Transaxle	TS27917	1	Transmission Pan Gasket 1974-1983, Automatic Transmission	W29080	1
Transmission Pan Gasket 1979-1980, Automatic Transmission	W29080	1	TYPE 3 (FASTBACK/SQUAREBACK)		
RABBIT			Transmission Pan Gasket 1968-1973, Automatic Transmission		
Transmission Gasket Set 1975-1984, Manual Transaxle	TS27917	1	W29106	1	
Transmission Pan Gasket 1975-1984, Automatic Transmission	W29080	1	TYPE 4		
SCIROCCO			Transmission Pan Gasket 1971-1974, Automatic Transmission		
Transmission Gasket Set 1974-1983, Manual Transaxle	TS27917	1	W29106	1	

PASSENGER CAR

Acura Truck

Engine Index

Engine	Year	Block
3471CC (3.5L) J35A3 V-TEC SOHC Honda	2001-2002	1

Engine	Year	Block
3471CC (3.5L) J35A5 V-TEC SOHC Honda	2003	2

Model Index

Model	Engine	Year	Block
MDX	3471CC (3.5L) J35A5 V-TEC SOHC Honda	2003-2004	2

Model	Engine	Year	Block
MDX	3471CC (3.5L) J35A3 V-TEC SOHC Honda	2001-2002	1

1	3471CC (3.5L) J35A3 V-TEC SOHC Honda V6 Cyl, 3.504in./89mm (2001-2002)	1			
Part	Year	VIN	Model/Application	Part Number	Qty.

ENGINE GASKETS

Valve Cover Set	2001-2002			<i>Victo-Tech</i>	VS17822	1
Manifold Set, Exhaust	2001-2002			<i>Stainless Steel</i>	MS17814	1

MISCELLANEOUS GASKETS

Camshaft Seal	2001-2002				67617	2
E.G.R. Gasket	2001-2002				G30797	1
Water Outlet Gasket	2001-2002				C31207	1
Water Pump Gasket	2001-2002				K17818	1

2	3471CC (3.5L) J35A5 V-TEC SOHC Honda V6 Cyl, 3.504in./89mm (2003)	2			
Part	Year	VIN	Model/Application	Part Number	Qty.

MISCELLANEOUS GASKETS

Camshaft Seal	2003				67617	2
E.G.R. Gasket	2003				G30797	1
Exhaust Pipe Gasket	2003		Exhaust Pipe To Converter		F7506	1
Water Outlet Gasket	2003				C31207	1
Water Pump Gasket	2003				K17818	1

Dodge Truck

Engine Index

Engine	Year	Block
105 CID (1.7L) SOHC Volkswagen	1982-1983	1
122 CID (2.0L) SOHC "A" Mitsubishi	1983-1989	2
122 CID/1997CC (2.0L) SOHC "U" Mitsubishi	1979-1982	3
135 CID (2.2L) SOHC Chrysler	1982-1988	4
143 CID (2.3L) SOHC Mitsubishi Diesel	1983-1986	5
144 CID (2.4L) 4G64 SOHC 8 Valve Mitsubishi	1990-1993	6
148 CID/2429CC (2.4L) DOHC Chrysler	1996-2003	7
150 CID (2.5L) Jeep	1996-2002	8
153 CID (2.5L) SOHC Chrysler	1987-1995	9
156 CID (2.6L) SOHC "F" Mitsubishi	1984-1987	10
156 CID (2.6L) SOHC "W" Mitsubishi	1979-1989	11
170 CID (2.8L) OHV Chrysler	1961-1969	12
181 CID (3.0L) SOHC Mitsubishi	1987-2000	13
198 CID (3.2L) OHV Chrysler	1970-1971	14
201 CID (3.3L) Chrysler	1990-2003	15
201 CID (3.3L) Chrysler CNG	1994-1996	16
201 CID (3.3L) EGM Chrysler Flex Fuel	1998-2003	17
218 CID (3.6L) L-Head Chrysler	1942-1954	18
225 CID (3.7L) OHV Chrysler	1961-1987	19
226 CID/3701CC (3.7L) EKG SOHC 12 Valve Chrysler	2002-2003	20
228 CID (3.7L) L-Head Dodge	1937-1941	21
230 CID (3.8L) Chrysler	1994-2003	22
230 CID (3.8L) L-Head Dodge	1942-1960	23
236 CID (3.9L) L-Head Dodge	1942-1952	24
237 CID (3.9L) L-Head Dodge	1948-1952	25

Engine	Year	Block
239 CID (3.9L) Dodge	1987-2003	26
251 CID (4.1L) L-Head Dodge	1961-1968	27
265 CID (4.3L) L-Head Dodge	1953-1960	28
270 CID (4.4L) OHV Dodge	1955-1956	29
273 CID (4.5L) OHV Chrysler	1964-1968	30
287 CID (4.7L) SOHC Chrysler	2000-2003	31
315 CID (5.2L) Dodge	1957-1958	32
315 CID (5.2L) Hemispherical Dodge	1957-1958	33
318 CID (5.2L) Chrysler	1959-2003	34
318 CID (5.2L) Chrysler CNG	1992-2003	35
354 CID (5.8L) 6-354 Perkins Diesel	1966-1970	36
359 CID (5.9L) ETA Cummins Diesel	1989-1993	37
359 CID (5.9L) ETB Cummins Diesel	1990-1998	38
359 CID (5.9L) ETC 24 Valves Cummins Diesel	1998-2003	39
359 CID (5.9L) ETH 24 Valves Cummins Diesel	2001-2002	40
360 CID (5.9L) Chrysler	1971-2003	41
360 CID (5.9L) Chrysler LPG	1971-1993	42
361 CID (5.9L) 361-1 Chrysler	1966-1967	43
361 CID (5.9L) OHV Chrysler	1960-1977	44
383 CID (6.3L) OHV Chrysler	1967-1971	45
400 CID (6.6L) OHV Chrysler	1972-1980	46
413 CID (6.8L) OHV Chrysler	1963-1977	47
440 CID (7.2L) OHV Chrysler	1973-1980	48
488 CID (8.0L) Iron Block Dodge	1994-2003	49

Model Index

Model	Engine	Year	Block
1 Ton	230 CID (3.8L) L-Head Dodge	1942-1956	23

Model	Engine	Year	Block
1 Ton	237 CID (3.9L) L-Head Dodge	1948-1954	25

Dodge Truck

Model Index (cont.)

Model	Engine	Year	Block	Model	Engine	Year	Block
1/2 Ton	230 CID (3.6L) L-Head Chrysler	1942-1943	18	Durango	239 CID (3.9L) Dodge	1998-1999	26
1/2 Ton	230 CID (3.8L) L-Head Dodge	1955-1956	23	Durango	287 CID (4.7L) SOHC Chrysler	2000-2004	31
3/4 Ton	218 CID (3.6L) L-Head Chrysler	1940-1954	18	Durango	318 CID (5.2L) Chrysler	1998-2000	34
3/4 Ton	230 CID (3.8L) L-Head Dodge	1948-1956	23	Durango	360 CID (5.9L) Chrysler	1998-2003	41
	153 CID (2.5L) SOHC Chrysler	1992-1995	9	Grand	135 CID (2.2L) SOHC Chrysler	1987	4
	360 CID (5.9L) Chrysler	1971-1993	42	Caravan			
A100	170 CID (2.8L) OHV Chrysler	1963-1969	12	Grand	148 CID/2429CC (2.4L) DOHC Chrysler	1996-1997	7
A100	198 CID (3.2L) OHV Chrysler	1970	14	Caravan			
A100	225 CID (3.7L) OHV Chrysler	1963-1969	19	Grand	153 CID (2.5L) SOHC Chrysler	1987-1990	9
A100	273 CID (4.5L) OHV Chrysler	1965-1968	30	Grand	156 CID (2.6L) SOHC "F"	1987	10
A100	318 CID (5.2L) Chrysler	1967-1969	34	Caravan	Mitsubishi		
Arrow	122 CID/1997CC (2.0L) SOHC	1979-1982	3	Grand	181 CID (3.0L) SOHC	1987-2000	13
Arrow	"U" Mitsubishi			Caravan	Mitsubishi		
Arrow	156 CID (2.6L) SOHC "W" Mitsubishi	1979-1982	11	Grand	201 CID (3.3L) EGM Chrysler	1998-2003	17
B1-F Series	236 CID (3.9L) L-Head Dodge	1948-1949	24	Caravan	201 CID (3.3L) Chrysler	1994-1996	16
B1-G Series	236 CID (3.9L) L-Head Dodge	1948-1949	24	Grand	201 CID (3.3L) Chrysler	1990-2003	15
B1-H Series	236 CID (3.9L) L-Head Dodge	1948-1949	24	Caravan			
B2-F Series	236 CID (3.9L) L-Head Dodge	1950	24	Grand	230 CID (3.8L) Chrysler	1994-2004	22
B2-G Series	236 CID (3.9L) L-Head Dodge	1950	24	Caravan			
B2-H Series	236 CID (3.9L) L-Head Dodge	1950	24	Grand	135 CID (2.2L) SOHC Chrysler	1987	4
B3-F Series	236 CID (3.9L) L-Head Dodge	1951-1952	24	Voyager			
B3-G Series	236 CID (3.9L) L-Head Dodge	1951-1952	24	Grand	148 CID/2429CC (2.4L) DOHC Chrysler	1996-1997	7
B3-H Series	236 CID (3.9L) L-Head Dodge	1951-1952	24	Voyager			
C1H-6	265 CID (4.3L) L-Head Dodge	1954	28	Grand	153 CID (2.5L) SOHC Chrysler	1987-1989	9
C1J-6 Series	265 CID (4.3L) L-Head Dodge	1954	28	Voyager			
C1K-6 Series	265 CID (4.3L) L-Head Dodge	1954	28	Grand	181 CID (3.0L) SOHC	1987-2000	13
C3G-8 Series	270 CID (4.4L) OHV Dodge	1955-1956	29	Voyager	Mitsubishi		
C3H-6 Series	265 CID (4.3L) L-Head Dodge	1955-1956	28	Grand	201 CID (3.3L) EGM Chrysler	1998-2000	17
C3H-8 Series	270 CID (4.4L) OHV Dodge	1955-1956	29	Voyager			
C3J-6 Series	265 CID (4.3L) L-Head Dodge	1955-1956	28	Grand	201 CID (3.3L) Chrysler	1994-1996	16
C3J-8 Series	270 CID (4.4L) OHV Dodge	1955-1956	29	Voyager			
C3K-6 Series	265 CID (4.3L) L-Head Dodge	1955-1956	28	Grand	201 CID (3.3L) Chrysler	1990-2000	15
C3K-8	270 CID (4.4L) OHV Dodge	1955-1956	29	Voyager			
SERIES				Grand	230 CID (3.8L) Chrysler	1994-1999	22
C500	318 CID (5.2L) Chrysler	1960-1971	34	Voyager			
C500	361 CID (5.9L) OHV Chrysler	1961-1971	44	L600	225 CID (3.7L) OHV Chrysler	1966-1970	19
C600	361 CID (5.9L) OHV Chrysler	1961-1973	44	L600	318 CID (5.2L) Chrysler	1966-1970	34
Caravan	135 CID (2.2L) SOHC Chrysler	1984-1987	4	L600	354 CID (5.8L) 6-354 Perkins Diesel	1966-1970	36
Caravan	148 CID/2429CC (2.4L) DOHC Chrysler	1996-2004	7	L600	361 CID (5.9L) OHV Chrysler	1966-1970	44
Caravan	153 CID (2.5L) SOHC Chrysler	1987-1995	9	L700	361 CID (5.9L) OHV Chrysler	1966-1970	44
Caravan	156 CID (2.6L) SOHC "F" Mitsubishi	1984-1987	10	M300	318 CID (5.2L) Chrysler	1963-1972	34
Caravan	181 CID (3.0L) SOHC Mitsubishi	1987-2000	13	M300	360 CID (5.9L) Chrysler	1976-1980	41
Caravan	201 CID (3.3L) EGM Chrysler	1998-2003	17	M300	440 CID (7.2L) OHV Chrysler	1975-1980	48
Caravan	201 CID (3.3L) Chrysler	1994-1996	16	MBH300	318 CID (5.2L) Chrysler	1974	34
Caravan	201 CID (3.3L) Chrysler	1990-2003	15	MBH300	360 CID (5.9L) Chrysler	1974	41
Caravan	230 CID (3.8L) Chrysler	1994-2001	22	MBH300	440 CID (7.2L) OHV Chrysler	1974	48
D400	251 CID (4.1L) L-Head Dodge	1957-1962	27	MBH400	360 CID (5.9L) Chrysler	1974-1978	41
D500	251 CID (4.1L) L-Head Dodge	1957-1962	27	MBH400	440 CID (7.2L) OHV Chrysler	1974-1978	48
D500	265 CID (4.3L) L-Head Dodge	1957-1960	28	MF Series	228 CID (3.7L) L-Head Dodge	1937	21
D500	318 CID (5.2L) Chrysler	1969-1971	34	Medium Duty	361 CID (5.9L) 361-1 Chrysler	1966-1967	43
D500	360 CID (5.9L) Chrysler	1969-1971	41	Mini Ram	135 CID (2.2L) SOHC Chrysler	1984-1987	4
D600	265 CID (4.3L) L-Head Dodge	1957-1959	28	Mini Ram	153 CID (2.5L) SOHC Chrysler	1987-1988	9
D600	318 CID (5.2L) Chrysler	1960-1971	34	Mini Ram	156 CID (2.6L) SOHC "F" Mitsubishi	1984-1987	10
D600	360 CID (5.9L) Chrysler	1971-1977	41	Mini Ram	181 CID (3.0L) SOHC Mitsubishi	1987-1988	13
D600	361 CID (5.9L) OHV Chrysler	1960-1971	44	P100	225 CID (3.7L) OHV Chrysler	1962-1965	19
D700	361 CID (5.9L) OHV Chrysler	1969-1971	44	P200	170 CID (2.8L) OHV Chrysler	1961	12
D700	413 CID (6.8L) OHV Chrysler	1963-1971	47	P200	225 CID (3.7L) OHV Chrysler	1961-1974	19
D800	413 CID (6.8L) OHV Chrysler	1972-1977	47	P300	170 CID (2.8L) OHV Chrysler	1961	12
Dakota	135 CID (2.2L) SOHC Chrysler	1987-1988	4	P300	225 CID (3.7L) OHV Chrysler	1961-1977	19
Dakota	150 CID (2.5L) Jeep	1996-2002	8	P300	230 CID (3.8L) L-Head Dodge	1957-1960	23
Dakota	153 CID (2.5L) SOHC Chrysler	1989-1995	9	P300	318 CID (5.2L) Chrysler	1959-1960	34
Dakota	239 CID (3.9L) Dodge	1987-2003	26	P400	170 CID (2.8L) OHV Chrysler	1961	12
Dakota	287 CID (4.7L) SOHC Chrysler	2000-2004	31	P400	225 CID (3.7L) OHV Chrysler	1961-1974	19
Dakota	318 CID (5.2L) Chrysler	1989-1999	34	P400	230 CID (3.8L) L-Head Dodge	1957-1960	23
Dakota	360 CID (5.9L) Chrysler	1998-2003	41	P400	251 CID (4.1L) L-Head Dodge	1961-1962	27

Dodge Truck

Model Index (cont.)

Model	Engine	Year	Block	Model	Engine	Year	Block
P400	315 CID (5.2L) Hemispherical Dodge	1958	33	Ram 2500HD	488 CID (8.0L) Iron Block Dodge	1994-2002	49
P400	318 CID (5.2L) Chrysler	1959-1960	34	Ram 3500	359 CID (5.9L) ETH 24 Valves Cummins Diesel	2001-2002	40
PT Cruiser	148 CID/2429CC (2.4L) DOHC Chrysler	2001-2004	7	Ram 3500	359 CID (5.9L) ETC 24 Valves Cummins Diesel	1998-2002	39
Power Ram 50	122 CID (2.0L) SOHC "A" Mitsubishi	1983	2	Ram 3500	359 CID (5.9L) ETB Cummins Diesel	1994-1998	38
Power Ram 50	143 CID (2.3L) SOHC Mitsubishi Diesel	1983	5	Ram 3500	360 CID (5.9L) Chrysler	1994-2002	41
Power Ram 50	144 CID (2.4L) 4G64 SOHC 8 Valve Mitsubishi	1993	6	Ram 3500	488 CID (8.0L) Iron Block Dodge	1994-2002	49
Power Ram 50	156 CID (2.6L) SOHC "W" Mitsubishi	1982-1989	11	Ram 3500 Heavy Duty	359 CID (5.9L) ETC 24 Valves Cummins Diesel	2003-2004	39
Power Ram 50	181 CID (3.0L) SOHC Mitsubishi	1990	13	Ram 3500 Heavy Duty	488 CID (8.0L) Iron Block Dodge	2003	49
Power Ram W250	318 CID (5.2L) Chrysler	1981-1987	34	Ram CB300	225 CID (3.7L) OHV Chrysler	1972-1978	19
Power Ram W250	360 CID (5.9L) Chrysler	1981-1988	41	Ram CB300	318 CID (5.2L) Chrysler	1972-1978	34
Power Ram W350	318 CID (5.2L) Chrysler	1982-1983	34	Ram CB300	360 CID (5.9L) Chrysler	1972-1980	41
Power Ram W350	360 CID (5.9L) Chrysler	1981-1988	41	Ram CB350	360 CID (5.9L) Chrysler	1981	41
Power Ram W450	360 CID (5.9L) Chrysler	1981	41	Ram CB400	360 CID (5.9L) Chrysler	1979	41
Power Wagon	230 CID (3.8L) L-Head Dodge	1947-1957	23	Ram CB450	360 CID (5.9L) Chrysler	1981	41
RF Series	228 CID (3.7L) L-Head Dodge	1938	21	Ram D50	122 CID/1997CC (2.0L) SOHC "U" Mitsubishi	1979-1980	3
RM300	318 CID (5.2L) Chrysler	1973-1974	34	Ram D50	156 CID (2.6L) SOHC "W" Mitsubishi	1979-1980	11
RM300	413 CID (6.8L) OHV Chrysler	1973-1974	47	Ram D100	198 CID (3.2L) OHV Chrysler	1970-1971	14
RM300	440 CID (7.2L) OHV Chrysler	1973-1974	48	Ram D100	225 CID (3.7L) OHV Chrysler	1961-1987	19
RM350	318 CID (5.2L) Chrysler	1973-1974	34	Ram D100	230 CID (3.8L) L-Head Dodge	1957-1960	23
RM350	400 CID (6.6L) OHV Chrysler	1973-1974	46	Ram D100	239 CID (3.9L) Dodge	1988-1989	26
RM350	413 CID (6.8L) OHV Chrysler	1973-1974	47	Ram D100	315 CID (5.2L) Dodge	1957-1958	32
RM400	413 CID (6.8L) OHV Chrysler	1973-1974	47	Ram D100	318 CID (5.2L) Chrysler	1959-1989	34
RM400	440 CID (7.2L) OHV Chrysler	1973-1974	48	Ram D100	360 CID (5.9L) Chrysler	1972-1988	41
Raider	156 CID (2.6L) SOHC "W" Mitsubishi	1987-1989	11	Ram D100	383 CID (6.3L) OHV Chrysler	1967-1971	45
Raider	181 CID (3.0L) SOHC Mitsubishi	1989	13	Ram D100	400 CID (6.6L) OHV Chrysler	1972-1980	46
Ram 50	122 CID (2.0L) SOHC "A" Mitsubishi	1983-1989	2	Ram D100	440 CID (7.2L) OHV Chrysler	1974-1978	48
Ram 50	122 CID/1997CC (2.0L) SOHC "U" Mitsubishi	1982	3	Ram D150	225 CID (3.7L) OHV Chrysler	1974-1987	19
Ram 50	143 CID (2.3L) SOHC Mitsubishi Diesel	1983-1985	5	Ram D150	239 CID (3.9L) Dodge	1988-1993	26
Ram 50	144 CID (2.4L) 4G64 SOHC 8 Valve Mitsubishi	1990-1992	6	Ram D150	318 CID (5.2L) Chrysler	1974-1993	34
Ram 50	156 CID (2.6L) SOHC "W" Mitsubishi	1982-1989	11	Ram D150	360 CID (5.9L) Chrysler	1974-1992	41
Ram 50	181 CID (3.0L) SOHC Mitsubishi	1990-1992	13	Ram D150	400 CID (6.6L) OHV Chrysler	1974-1978	46
Ram 1500	226 CID/3701CC (3.7L) EKG SOHC 12 Valve Chrysler	2002-2004	20	Ram D150	440 CID (7.2L) OHV Chrysler	1974-1978	48
Ram 1500	239 CID (3.9L) Dodge	1994-2001	26	Ram D200	225 CID (3.7L) OHV Chrysler	1961-1979	19
Ram 1500	287 CID (4.7L) SOHC Chrysler	2002-2004	31	Ram D200	230 CID (3.8L) L-Head Dodge	1957-1960	23
Ram 1500	318 CID (5.2L) Chrysler	1994-1996	35	Ram D200	315 CID (5.2L) Dodge	1957-1958	32
Ram 1500	318 CID (5.2L) Chrysler	1994-2001	34	Ram D200	318 CID (5.2L) Chrysler	1959-1980	34
Ram 1500	360 CID (5.9L) Chrysler	1994-2003	41	Ram D200	360 CID (5.9L) Chrysler	1972-1980	41
Ram 2500	318 CID (5.2L) Chrysler	1995-1996	35	Ram D200	383 CID (6.3L) OHV Chrysler	1967-1971	45
Ram 2500	318 CID (5.2L) Chrysler	1994-1996	34	Ram D200	400 CID (6.6L) OHV Chrysler	1972-1978	46
Ram 2500	360 CID (5.9L) Chrysler	1994-1996	41	Ram D200	440 CID (7.2L) OHV Chrysler	1974-1978	48
Ram 2500	359 CID (5.9L) ETC 24 Valves Cummins Diesel	2003-2004	39	Ram D250	225 CID (3.7L) OHV Chrysler	1981-1987	19
Ram 2500 Heavy Duty	488 CID (8.0L) Iron Block Dodge	2003	49	Ram D250	239 CID (3.9L) Dodge	1988-1993	26
Ram 2500HD	359 CID (5.9L) ETH 24 Valves Cummins Diesel	2001-2002	40	Ram D250	318 CID (5.2L) Chrysler	1981-1993	34
Ram 2500HD	359 CID (5.9L) ETC 24 Valves Cummins Diesel	1998-2002	39	Ram D250	359 CID (5.9L) ETB Cummins Diesel	1990-1993	38
Ram 2500HD	359 CID (5.9L) ETB Cummins Diesel	1994-1998	38	Ram D250	359 CID (5.9L) ETA Cummins Diesel	1989-1993	37
Ram 2500HD	360 CID (5.9L) Chrysler	1994-2002	41	Ram D250	360 CID (5.9L) Chrysler	1981-1992	41
				Ram D300	225 CID (3.7L) OHV Chrysler	1961-1978	19
				Ram D300	318 CID (5.2L) Chrysler	1961-1979	34
				Ram D300	360 CID (5.9L) Chrysler	1972-1980	41
				Ram D300	383 CID (6.3L) OHV Chrysler	1967-1971	45
				Ram D300	400 CID (6.6L) OHV Chrysler	1972-1978	46
				Ram D300	440 CID (7.2L) OHV Chrysler	1974-1978	48
				Ram D350	239 CID (3.9L) Dodge	1990-1993	26
				Ram D350	318 CID (5.2L) Chrysler	1981-1993	34
				Ram D350	359 CID (5.9L) ETB Cummins Diesel	1990-1993	38
				Ram D350	359 CID (5.9L) ETA Cummins Diesel	1989-1993	37
				Ram D350	360 CID (5.9L) Chrysler	1981-1992	41
				Ram D400	360 CID (5.9L) Chrysler	1979-1980	41
				Ram M400	318 CID (5.2L) Chrysler	1975	34

LIGHT TRUCK

Dodge Truck

Model Index (cont.)

Model	Engine	Year	Block	Model	Engine	Year	Block
Ram M400	360 CID (5.9L) Chrysler	1976-1980	41	Ram Van B250	360 CID (5.9L) Chrysler	1984-1992	41
Ram M400	440 CID (7.2L) OHV Chrysler	1975-1980	48	Ram Van B300	225 CID (3.7L) OHV Chrysler	1971-1978	19
Ram M500	440 CID (7.2L) OHV Chrysler	1973-1980	48	Ram Van B300	318 CID (5.2L) Chrysler	1971-1978	34
Ram M600	440 CID (7.2L) OHV Chrysler	1976-1980	48	Ram Van B300	360 CID (5.9L) Chrysler	1971-1979	41
Ram MB300	360 CID (5.9L) Chrysler	1979-1980	41	Ram Van B300	400 CID (6.6L) OHV Chrysler	1974-1978	46
Ram MB300	440 CID (7.2L) OHV Chrysler	1979	48	Ram Van B300	440 CID (7.2L) OHV Chrysler	1974-1978	48
Ram MB400	360 CID (5.9L) Chrysler	1979-1980	41	Ram Van B350	318 CID (5.2L) Chrysler	1992-1993	35
Ram MB400	440 CID (7.2L) OHV Chrysler	1979	48	Ram Van B350	318 CID (5.2L) Chrysler	1981-1993	34
Ram MBH350	360 CID (5.9L) Chrysler	1981	41	Ram Van B350	360 CID (5.9L) Chrysler	1983-1992	41
Ram MBH450	360 CID (5.9L) Chrysler	1981	41	Ram W100	225 CID (3.7L) OHV Chrysler	1961-1987	19
Ram MBL300	318 CID (5.2L) Chrysler	1974-1978	34	Ram W100	230 CID (3.8L) L-Head Dodge	1957-1960	23
Ram MBL300	360 CID (5.9L) Chrysler	1974-1978	41	Ram W100	239 CID (3.9L) Dodge	1989	26
Ram MBL300	440 CID (7.2L) OHV Chrysler	1974-1978	48	Ram W100	315 CID (5.2L) Dodge	1957-1958	32
Ram MBL350	360 CID (5.9L) Chrysler	1981	41	Ram W100	318 CID (5.2L) Chrysler	1959-1989	34
Ram RD200	318 CID (5.2L) Chrysler	1974-1978	34	Ram W100	360 CID (5.9L) Chrysler	1972-1988	41
Ram RD200	360 CID (5.9L) Chrysler	1974-1978	41	Ram W100	383 CID (6.3L) OHV Chrysler	1967-1971	45
Ram Van 1500	239 CID (3.9L) Dodge	1994-2003	26	Ram W100	400 CID (6.6L) OHV Chrysler	1972-1977	46
Ram Van 1500	318 CID (5.2L) Chrysler	1994-2003	34	Ram W100	440 CID (7.2L) OHV Chrysler	1974-1977	48
Ram Van 1500	360 CID (5.9L) Chrysler	1997-2003	41	Ram W150	225 CID (3.7L) OHV Chrysler	1978-1987	19
Ram Van 2500	239 CID (3.9L) Dodge	1994-1996	26	Ram W150	239 CID (3.9L) Dodge	1989-1993	26
Ram Van 2500	318 CID (5.2L) Chrysler	1994-2003	35	Ram W150	318 CID (5.2L) Chrysler	1978-1993	34
Ram Van 2500	318 CID (5.2L) Chrysler	1994-2003	34	Ram W150	360 CID (5.9L) Chrysler	1978-1992	41
Ram Van 2500	360 CID (5.9L) Chrysler	1994-2003	41	Ram W150	400 CID (6.6L) OHV Chrysler	1978	46
Ram Van 3500	318 CID (5.2L) Chrysler	1994-2003	35	Ram W150	440 CID (7.2L) OHV Chrysler	1978	48
Ram Van 3500	318 CID (5.2L) Chrysler	1994-2003	34	Ram W200	225 CID (3.7L) OHV Chrysler	1961-1978	19
Ram Van 3500	360 CID (5.9L) Chrysler	1994-2003	41	Ram W200	230 CID (3.8L) L-Head Dodge	1957-1960	23
Ram Van B100	225 CID (3.7L) OHV Chrysler	1972-1980	19	Ram W200	315 CID (5.2L) Dodge	1957-1958	32
Ram Van B100	318 CID (5.2L) Chrysler	1972-1980	34	Ram W200	318 CID (5.2L) Chrysler	1959-1980	34
Ram Van B100	360 CID (5.9L) Chrysler	1972-1978	41	Ram W200	360 CID (5.9L) Chrysler	1972-1980	41
Ram Van B150	225 CID (3.7L) OHV Chrysler	1981-1987	19	Ram W200	383 CID (6.3L) OHV Chrysler	1967-1971	45
Ram Van B150	239 CID (3.9L) Dodge	1988-1993	26	Ram W200	400 CID (6.6L) OHV Chrysler	1972-1978	46
Ram Van B150	318 CID (5.2L) Chrysler	1981-1993	34	Ram W200	440 CID (7.2L) OHV Chrysler	1974-1978	48
Ram Van B150	360 CID (5.9L) Chrysler	1988	41	Ram W250	318 CID (5.2L) Chrysler	1983-1993	34
Ram Van B200	198 CID (3.2L) OHV Chrysler	1971	14	Ram W250	359 CID (5.9L) ETB Cummins Diesel	1990-1993	38
Ram Van B200	225 CID (3.7L) OHV Chrysler	1971-1978	19	Ram W250	359 CID (5.9L) ETA Cummins Diesel	1989-1993	37
Ram Van B200	318 CID (5.2L) Chrysler	1971-1980	34	Ram W250	360 CID (5.9L) Chrysler	1984-1992	41
Ram Van B200	360 CID (5.9L) Chrysler	1971-1979	41	Ram W300	225 CID (3.7L) OHV Chrysler	1961-1978	19
Ram Van B200	400 CID (6.6L) OHV Chrysler	1974-1980	46	Ram W300	251 CID (4.1L) L-Head Dodge	1957-1968	27
Ram Van B200	440 CID (7.2L) OHV Chrysler	1974-1978	48	Ram W300	315 CID (5.2L) Dodge	1958	32
Ram Van B250	225 CID (3.7L) OHV Chrysler	1981-1987	19	Ram W300	318 CID (5.2L) Chrysler	1959-1978	34
Ram Van B250	239 CID (3.9L) Dodge	1988-1993	26	Ram W300	360 CID (5.9L) Chrysler	1972-1978	41
Ram Van B250	318 CID (5.2L) Chrysler	1992-1993	35	Ram W300	383 CID (6.3L) OHV Chrysler	1967-1969	45
Ram Van B250	318 CID (5.2L) Chrysler	1981-1993	34	Ram W300	400 CID (6.6L) OHV Chrysler	1972-1978	46
				Ram W300	440 CID (7.2L) OHV Chrysler	1974-1978	48
				Ram W350	318 CID (5.2L) Chrysler	1983-1993	34
				Ram W350	359 CID (5.9L) ETB Cummins Diesel	1990-1993	38
				Ram W350	359 CID (5.9L) ETA Cummins Diesel	1989-1993	37
				Ram W350	360 CID (5.9L) Chrysler	1983-1992	41
				Ram W400	360 CID (5.9L) Chrysler	1974-1977	41
				Ram W400	400 CID (6.6L) OHV Chrysler	1974-1977	46
				Ram W400	440 CID (7.2L) OHV Chrysler	1974-1977	48
				Ram Wagon 1500	239 CID (3.9L) Dodge	1994-2002	26
				Ram Wagon 1500	318 CID (5.2L) Chrysler	1994-2002	34
				Ram Wagon 2500	239 CID (3.9L) Dodge	1994-1996	26

Dodge Truck

Model Index (cont.)

Model	Engine	Year	Block	Model	Engine	Year	Block
Ram Wagon 2500	318 CID (5.2L) Chrysler	1994-2002	35	Ramcharger AD100	440 CID (7.2L) OHV Chrysler	1974-1978	48
Ram Wagon 2500	318 CID (5.2L) Chrysler	1994-2002	34	Ramcharger AD150	318 CID (5.2L) Chrysler	1982-1993	34
Ram Wagon 2500	360 CID (5.9L) Chrysler	1994-2002	41	Ramcharger AD150	360 CID (5.9L) Chrysler	1984-1992	41
Ram Wagon 3500	318 CID (5.2L) Chrysler	1994-2002	35	Ramcharger AW100	225 CID (3.7L) OHV Chrysler	1974-1979	19
Ram Wagon 3500	318 CID (5.2L) Chrysler	1994-2002	34	Ramcharger AW100	318 CID (5.2L) Chrysler	1974-1980	34
Ram Wagon 3500	360 CID (5.9L) Chrysler	1994-2002	41	Ramcharger AW100	360 CID (5.9L) Chrysler	1974-1979	41
Ram Wagon B100	198 CID (3.2L) OHV Chrysler	1971	14	Ramcharger AW100	400 CID (6.6L) OHV Chrysler	1974-1978	46
Ram Wagon B100	225 CID (3.7L) OHV Chrysler	1971-1979	19	Ramcharger AW100	440 CID (7.2L) OHV Chrysler	1974-1978	48
Ram Wagon B100	318 CID (5.2L) Chrysler	1971-1979	34	Ramcharger AW150	318 CID (5.2L) Chrysler	1982-1993	34
Ram Wagon B100	360 CID (5.9L) Chrysler	1971-1978	41	Ramcharger AW150	360 CID (5.9L) Chrysler	1984-1992	41
Ram Wagon B150	225 CID (3.7L) OHV Chrysler	1983-1987	19	Rampage Volkswagen	105 CID (1.7L) SOHC	1982-1983	1
Ram Wagon B150	239 CID (3.9L) Dodge	1988-1993	26	Rampage S400	135 CID (2.2L) SOHC Chrysler	1982-1984	4
Ram Wagon B150	318 CID (5.2L) Chrysler	1983-1993	34	S500	251 CID (4.1L) L-Head Dodge	1957-1962	27
Ram Wagon B200	198 CID (3.2L) OHV Chrysler	1971	14	S500	225 CID (3.7L) OHV Chrysler	1963-1968	19
Ram Wagon B200	225 CID (3.7L) OHV Chrysler	1971-1978	19	S500	251 CID (4.1L) L-Head Dodge	1957-1968	27
Ram Wagon B200	318 CID (5.2L) Chrysler	1971-1980	34	S500	265 CID (4.3L) L-Head Dodge	1957-1960	28
Ram Wagon B200	360 CID (5.9L) Chrysler	1971-1979	41	S600	318 CID (5.2L) Chrysler	1958-1971	34
Ram Wagon B200	400 CID (6.6L) OHV Chrysler	1974-1978	46	S600	265 CID (4.3L) L-Head Dodge	1957-1959	28
Ram Wagon B200	440 CID (7.2L) OHV Chrysler	1974-1978	48	S600	318 CID (5.2L) Chrysler	1960-1977	34
Ram Wagon B250	225 CID (3.7L) OHV Chrysler	1982-1987	19	S600	361 CID (5.9L) OHV Chrysler	1960-1977	44
Ram Wagon B250	239 CID (3.9L) Dodge	1988-1993	26	Scamp	135 CID (2.2L) SOHC Chrysler	1983	4
Ram Wagon B250	318 CID (5.2L) Chrysler	1992-1993	35	Sportsman Wagon B150	225 CID (3.7L) OHV Chrysler	1981	19
Ram Wagon B250	318 CID (5.2L) Chrysler	1982-1993	34	Sportsman Wagon B150	318 CID (5.2L) Chrysler	1981	34
Ram Wagon B250	360 CID (5.9L) Chrysler	1984-1992	41	Sportsman Wagon B250	225 CID (3.7L) OHV Chrysler	1981	19
Ram Wagon B300	225 CID (3.7L) OHV Chrysler	1971	19	Sportsman Wagon B250	318 CID (5.2L) Chrysler	1981	34
Ram Wagon B300	318 CID (5.2L) Chrysler	1971-1980	34	Sportsman Wagon B350	318 CID (5.2L) Chrysler	1981	34
Ram Wagon B300	360 CID (5.9L) Chrysler	1971-1979	41	Sportsman Wagon B350	360 CID (5.9L) Chrysler	1981	41
Ram Wagon B300	400 CID (6.6L) OHV Chrysler	1974-1978	46	TE Series	228 CID (3.7L) L-Head Dodge	1939	21
Ram Wagon B300	440 CID (7.2L) OHV Chrysler	1974-1978	48	TF Series	228 CID (3.7L) L-Head Dodge	1939	21
Ram Wagon B300	318 CID (5.2L) Chrysler	1992-1993	35	Town & Country	201 CID (3.3L) EGM Chrysler	2000-2003	17
Ram Wagon B300	318 CID (5.2L) Chrysler	1982-1993	34	Town & Country	201 CID (3.3L) Chrysler	1990-2000	15
Ram Wagon B300	360 CID (5.9L) Chrysler	1982-1992	41	Town & Country	230 CID (3.8L) Chrysler	1994-2004	22
Ram Wagon B300	225 CID (3.7L) OHV Chrysler	1974-1979	19	Trailduster	225 CID (3.7L) OHV Chrysler	1974-1980	19
Ram Wagon B300	400 CID (6.6L) OHV Chrysler	1974-1978	46	Trailduster	318 CID (5.2L) Chrysler	1974-1980	34
Ram Wagon B300	440 CID (7.2L) OHV Chrysler	1974-1978	48	Trailduster	360 CID (5.9L) Chrysler	1974-1980	41
Ram Wagon B350	318 CID (5.2L) Chrysler	1992-1993	35	Trailduster	400 CID (6.6L) OHV Chrysler	1974-1978	46
Ram Wagon B350	318 CID (5.2L) Chrysler	1982-1993	34	Trailduster	440 CID (7.2L) OHV Chrysler	1974-1978	48
Ram Wagon B350	360 CID (5.9L) Chrysler	1982-1992	41	VF Series	228 CID (3.7L) L-Head Dodge	1940	21
Ramcharger AD100	225 CID (3.7L) OHV Chrysler	1974-1979	19	VG Series	228 CID (3.7L) L-Head Dodge	1940	21
Ramcharger AD100	318 CID (5.2L) Chrysler	1974-1980	34	VH Series	228 CID (3.7L) L-Head Dodge	1940	21
Ramcharger AD100	360 CID (5.9L) Chrysler	1974-1979	41	Voyager	135 CID (2.2L) SOHC Chrysler	1984-1987	4
Ramcharger AD100	400 CID (6.6L) OHV Chrysler	1974-1978	46	Voyager	148 CID/2429CC (2.4L) DOHC Chrysler	1996-2002	7
				Voyager	153 CID (2.5L) SOHC Chrysler	1987-1995	9
				Voyager	156 CID (2.6L) SOHC "F" Mitsubishi	1984-1987	10
				Voyager	181 CID (3.0L) SOHC Mitsubishi	1987-2000	13
				Voyager	201 CID (3.3L) EGM Chrysler	1998-2003	17
				Voyager	201 CID (3.3L) Chrysler	1994-1996	16
				Voyager	201 CID (3.3L) Chrysler	1991-2000	15

Model Index (cont.)

Model	Engine	Year	Block	Model	Engine	Year	Block
Voyager	230 CID (3.8L) Chrysler	1996-1999	22	Voyager	360 CID (5.9L) Chrysler	1981-1982	41
Voyager PB100	225 CID (3.7L) OHV Chrysler	1974-1980	19	Voyager PB250			
Voyager PB100	318 CID (5.2L) Chrysler	1974-1980	34	Voyager PB300	225 CID (3.7L) OHV Chrysler	1974-1980	19
Voyager PB100	360 CID (5.9L) Chrysler	1974-1980	41	Voyager PB300	318 CID (5.2L) Chrysler	1974-1980	34
Voyager PB100	400 CID (6.6L) OHV Chrysler	1974	46	Voyager PB300	360 CID (5.9L) Chrysler	1974-1980	41
Voyager PB150	225 CID (3.7L) OHV Chrysler	1981-1982	19	Voyager PB300	400 CID (6.6L) OHV Chrysler	1974-1978	46
Voyager PB150	318 CID (5.2L) Chrysler	1981-1982	34	Voyager PB300	440 CID (7.2L) OHV Chrysler	1974-1978	48
Voyager PB200	225 CID (3.7L) OHV Chrysler	1974-1980	19	Voyager PB350	318 CID (5.2L) Chrysler	1981-1982	34
Voyager PB200	318 CID (5.2L) Chrysler	1974-1980	34	Voyager PB350	360 CID (5.9L) Chrysler	1981-1982	41
Voyager PB200	360 CID (5.9L) Chrysler	1974-1980	41	W300M	230 CID (3.8L) L-Head Dodge	1958-1959	23
Voyager PB200	400 CID (6.6L) OHV Chrysler	1974-1978	46	W500	225 CID (3.7L) OHV Chrysler	1963-1967	19
Voyager PB200	440 CID (7.2L) OHV Chrysler	1974-1978	48	W500	251 CID (4.1L) L-Head Dodge	1961-1963	27
Voyager PB250	225 CID (3.7L) OHV Chrysler	1981-1982	19	W500	265 CID (4.3L) L-Head Dodge	1957-1960	28
Voyager PB250	318 CID (5.2L) Chrysler	1981-1982	34	W500	318 CID (5.2L) Chrysler	1958-1971	34
				WF Series	228 CID (3.7L) L-Head Dodge	1941	21
				WF Series	236 CID (3.9L) L-Head Dodge	1942-1947	24
				WM300	230 CID (3.8L) L-Head Dodge	1960	23
				WM300	251 CID (4.1L) L-Head Dodge	1961-1968	27

1 105 CID (1.7L) SOHC Volkswagen 4 Cyl, 3.130in./79.5mm (1982-1983) 1

Part	Year	VIN	Model/Application	Part Number	Qty.
------	------	-----	-------------------	-------------	------

ENGINE GASKETS

Head Set	1982-1983		(Exhaust Pipe Gasket Not Included)	HS3609	1
Full Set	1982-1983		(Exhaust Pipe Gasket Not Included)	FS3609	1
Engine Kit Gasket Set	1982-1983			95-3076VR	1
Cylinder Head Gasket	1982-1983		VR2000	3609	1
Valve Cover Set	1982-1983		Cork Rubber	VS30024	1
			Tuff-Cork	VS30024TC	1
Valve Stem Seal, Exh.	1982-1983		Teflon	B45423	4
			(Premium) Fluoroelastomer	B45546	4
Valve Stem Seal, Int.	1982-1983		Teflon	B45423	4
			(Premium) Fluoroelastomer	B45546	4
Manifold Set, Int. & Exh.	1982-1983			MS15250	1
Oil Pan Set	1982-1983		Victo-Tech	OS20056	1
Rear Main Seal Set	1982-1983			JV644	1
Timing Cover Set	1982-1983			JV982	1
Timing Cover Seal	1982-1983			66960	1

MISCELLANEOUS GASKETS

Air Cleaner Mount Gasket	1982-1983			G26129	1
Camshaft Seal	1982-1983			66960	1
Carb. Mount Gasket	1982-1983		Carburetor To Spacer	G25769	1
			Spacer To Insulator	G25775	1
E.G.R. Gasket	1982-1983			G24079	1
Exhaust Pipe Gasket	1982-1983		(Ring Type 'F')	F7395	1
Fuel Pump Gasket	1982-1983			D24076	1
Inter Shaft Seal	1982-1983			66960	1
Intermediate Shaft Set	1982-1983			JV983	1
Thermostat O-Ring	1982-1983			C20119	1
Water Outlet Gasket	1982-1983			C25163	1
Water Pump Mount Gasket	1982-1983			K26192	1

Dodge Truck

2 122 CID (2.0L) SOHC "A" Mitsubishi 4 Cyl, 3.346in./85mm (1983-1989)

2

Part	Year	VIN	Model/Application	Part Number	Qty.
ENGINE GASKETS					
Head Set	1986-1989	D	(Exhaust Pipe Gasket Not Included)	HS5703Y	1
	1985	D	From 10/84, (Exhaust Pipe Gasket Not Included)	HS5703Y	1
	1984	D	Thru 9/84, (Exhaust Pipe Gasket Not Included)	HS5703	1
		D	(Exhaust Pipe Gasket Not Included)	HS5703Y	1
	1983	5	(Exhaust Pipe Gasket Not Included)	HS5703	1
Lower Set	1983-1989			CS5875	1
Full Set	1985-1989	D	(Exhaust Pipe Gasket Not Included)	FS5703Y	1
	1984	D	Thru 9/84, (Exhaust Pipe Gasket Not Included)	FS5703	1
		D	From 10/84, (Exhaust Pipe Gasket Not Included)	FS5703Y	1
	1983	5	(Exhaust Pipe Gasket Not Included)	FS5703	1
Engine Kit Gasket Set	1984-1989		(Contains Seals And O-rings For Jet Valves)	95-3133VR	1
Cylinder Head Gasket	1984-1989	D		VR2000 5703	1
	1983	5		VR2000 5703	1
Cyl. Head Spacer Shim	1984-1989	D	Requires Sealing Compound	Steel 5703S	1
	1983	5	Requires Sealing Compound	Steel 5703S	1
Sealing Compound	1983-1989		(4 Ounce Brush Top Can)	JV66B	1
			(12 Ounce Spray Can)	JV66S	1
Valve Cover Set	1984-1989	D	(Valve Cover Grommets Not Included, Camshaft Semi Circular Plug Not Included)	Victo-Tech VS40003	1
		D	(Contains Valve Cover Grommets, Contains Camshaft Semi Circular Plug)	Victo-Tech VS40003CP	1
	1983	5	(Valve Cover Grommets Not Included, Camshaft Semi Circular Plug Not Included)	Victo-Tech VS40003	1
		5	(Contains Valve Cover Grommets, Contains Camshaft Semi Circular Plug)	Victo-Tech VS40003CP	1
Valve Stem Seal, Exh.	1984-1989	D	(Original Equipment Type)	B45441	4
		D	(Premium)	B45806	4
	1983	5	(Original Equipment Type)	B45441	4
		5	(Premium)	B45806	4
Valve Stem Seal, Int.	1984-1989	D	(Original Equipment Type)	B45441	4
		D	(Premium)	B45806	4
	1983	5	(Original Equipment Type)	B45441	4
		5	(Premium)	B45806	4
Manifold Set, Exhaust	1985-1989	D		MS15389	1
	1984	D	From 10/84	MS15389	1
		D	Thru 9/84	MS15392	1
	1983	5		MS15392	1
Manifold Set, Intake	1984-1989	D		MS15387	1
	1983	5		MS15387	1
Oil Pan Set	1984-1989	D		Cork Rubber OS32008	1
	1983	5		Cork Rubber OS32008	1
Rear Main Seal Set	1984-1989	D		JV534	1
	1983	5		JV534	1
Timing Cover Set	1986-1989	D		JV1036	1
	1985	D	Thru 3/85	JV994	1
		D	From 4/85	JV1036	1
	1984	D		JV994	1
	1983	5		JV994	1
Timing Cover Seal	1984-1989	D		47730	1
	1983	5		47730	1
MISCELLANEOUS GASKETS					
Air Cleaner Mount Gasket	1984-1989	D	2 Barrel Carburetor	G24965	1
	1983	5	2 Barrel Carburetor	G24965	1
Camshaft Seal	1984-1989	D		47918	1
	1983	5		47918	1
Cam. Semi-Circular Plug	1984-1989	D		B24180	1

LIGHT TRUCK

2 122 CID (2.0L) SOHC "A" Mitsubishi 4 Cyl, 3.346in./85mm (1983-1989) **2**
 (cont.) (cont.)

Part	Year	VIN	Model/Application	Part Number	Qty.
MISCELLANEOUS GASKETS (cont.)					
Cam. Semi-Circular Plug (cont.)	1983	5		B24180	1
Carb. Mount Gasket	1987-1989	D	2 Barrel Carburetor	G30713	1
	1984-1986	D	Except Canadian Models, 2 Barrel Carburetor	G25771	1
		D	Canadian, 2 Barrel Carburetor	G30619	1
	1983	5	Except Canadian Models, 2 Barrel Carburetor	G25771	1
		5	Canadian, 2 Barrel Carburetor	G30619	1
E.G.R. Gasket	1987-1989	D	<i>Nitroseal</i>	G30714	1
	1984-1986	D		G24078	1
	1983	5		G24078	1
Exhaust Pipe Gasket	1987-1989	D	(Flange Type), Catalytic Converter To Center Pipe	F7422	1
		D	(Flange Type)	F12287	1
	1986	D	(Flange Type)	F7409	1
	1984-1986	D	(Ring Type 'F'), Catalytic Converter To Exhaust Pipe	F7424	1
	1984-1985	D	California, (Flange Type)	F7409	1
	1983	5	California, (Flange Type)	F7409	1
		5	California, (Ring Type 'F'), Catalytic Converter To Exhaust Pipe	F7424	1
	Fuel Pump Gasket	1984-1989	D		D24085
1983		5		D24085	2
Jet Valve Seal	1984-1989	D	(Jet Valve)	B45471	4
	1983	5	(Jet Valve)	B45471	4
Valve Cover Grommet	1984-1989	D		B45729	2
	1983	5		B45729	2
Water Outlet Gasket	1984-1989	D		C24082	1
	1983	5		C24082	1
Water Pump Mount Gasket	1984-1989	D		K30615	1
	1983	5		K30615	1

3 122 CID/1997CC (2.0L) SOHC "U" Mitsubishi 4 Cyl, 3.307in./84mm (1979-1982) **3**

Part	Year	VIN	Model/Application	Part Number	Qty.
ENGINE GASKETS					
Head Set	1981-1982		(Exhaust Manifold Gasket For Canada Not Included)	HS3725	1
	1979-1980			HS3672W	1
Full Set	1981-1982		(Exhaust Manifold Gasket For Canada Not Included)	FS3725	1
	1979-1980			FS3672W	1
Cylinder Head Gasket	1981-1982			3725	1
	1979-1980			3672	1
Valve Cover Set	1979-1982		<i>Victo-Tech</i>	VS39860	1
Valve Stem Seal, Exh.	1979-1982		(Original Equipment Type)	B45441	4
			(Premium)	B45806	4
Valve Stem Seal, Int.	1979-1982		(Original Equipment Type)	B45441	4
			(Premium)	B45806	4
Manifold Set, Exhaust	1981-1982		Canadian	MS15298	1
			Except Canadian Models	MS15299	1
	1979-1980			MS15299	1
Manifold Set, Intake	1979-1982			MS15295	1
Oil Pan Set	1979-1982		<i>Cork Rubber</i>	OS20776	1
Rear Main Seal Set	1981-1982			JV534	1
	1979-1980			JV507	1
Timing Cover Set	1979-1982			JV943	1
Timing Cover Gasket	1979-1982			T26234	1
Timing Cover Seal	1979-1982			47735	1

Dodge Truck

3 122 CID/1997CC (2.0L) SOHC "U" Mitsubishi 4 Cyl, 3.307in./84mm (1979-1982) **3**
 (cont.) (cont.)

Part	Year	VIN	Model/Application	Part Number	Qty.
MISCELLANEOUS GASKETS					
Air Cleaner Mount Gasket	1982		Canadian, 2 Barrel Carburetor	G24090	1
			Except Canadian Models, 2 Barrel Carburetor	G24965	1
	1981		2 Barrel Carburetor	G24965	1
	1979-1980		2 Barrel Carburetor	G24090	1
Cam. Semi-Circular Plug	1979-1982			B24180	1
Carb. Mount Gasket	1982		Canadian, 2 Barrel Carburetor	G24966	1
			Except Canadian Models, 2 Barrel Carburetor	G25771	1
	1981		2 Barrel Carburetor	G25771	1
	1979-1980		2 Barrel Carburetor	G25784	1
E.G.R. Gasket	1979-1982			G24078	1
Fuel Pump Gasket	1979-1982			D24076	2
Jet Valve Seal	1979-1980		(Jet Valve)	B45471	4
Valve Cover Grommet	1979-1982			B45729	2
Water Outlet Gasket	1979-1982			C24082	1
Water Pump Mount Gasket	1979-1982			K26487	1

4 135 CID (2.2L) SOHC Chrysler 4 Cyl, 3.445in./87.5mm (1982-1988) **4**

Part	Year	VIN	Model/Application	Part Number	Qty.
ENGINE GASKETS					
Head Set	1986-1988		(Contains Head Bolts, Rear Camshaft Plug Not Included, Exhaust Pipe Gasket Not Included, Camshaft Rear Seal With 2.061" Outer Diameter Not Included), Naturally Aspirated	HS3688WB1	1
	1982-1988		(Head Bolts Not Included, Exhaust Pipe Gasket Not Included, Camshaft Rear Seal Not Included, Camshaft Rear Seal With 2.061" Outer Diameter Not Included)	HS54097-2	1
	1982-1985		(Contains Head Bolts, Rear Camshaft Plug Not Included, Exhaust Pipe Gasket Not Included, Camshaft Rear Seal With 2.061" Outer Diameter Not Included)	HS3688WB	1
Lower Set	1982-1988		(Requires Head Set To Make Full Set)	CS54097	1
Full Set	1984-1988		(Head Bolts Not Included, Rear Camshaft Plug Not Included, Exhaust Pipe Gasket Not Included, Camshaft Rear Seal With 2.061" Outer Diameter Not Included), Naturally Aspirated	FS3688	1
	1982-1984		(Head Bolts Not Included, Rear Camshaft Plug Not Included, Exhaust Pipe Gasket Not Included, Camshaft Rear Seal With 2.061" Outer Diameter Not Included)	FS3688	1
Engine Kit Gasket Set	1987-1988		Except Turbocharged, (Camshaft Rear Seal Plug Not Included, Contains Camshaft Rear Seal With 2.112" Outside Diameter), Use With Part Number B45573	95-3438VR	1
	1982-1987		Except Turbocharged, (Camshaft Rear Seal Plug Not Included, Contains Camshaft Rear Seal With 2.112" Outside Diameter), Use With Part Number B45573	95-3438VR	1
Cylinder Head Gasket	1982-1988		Nitroseal	54097	1
			Nitroseal, .093" Thickness	54114G	1
Cyl. Head Bolt Set	1986-1988		11mm Bolts	GS33184	1
	1982-1985		10mm Bolt	GS33250	1
Cyl. Head Washer Set	1982-1988			GS33185	1
Sealing Compound	1982-1988		(4 Ounce Brush Top Can)	JV66B	1
			(12 Ounce Spray Can)	JV66S	1
Valve Cover Set	1982-1988		Cork Rubber	VS38039	1
			Victo-Foam	VS50309	1
Valve Stem Seal, Exh.	1982-1988			B45449	4
Valve Stem Seal, Int.	1982-1988			B45449	4
Manifold Set, Int. & Exh.	1982-1988		Nitroseal	MS15313	1
Oil Pan Set	1982-1988		Cork Rubber	OS38141	1

LIGHT TRUCK

4 135 CID (2.2L) SOHC Chrysler 4 Cyl, 3.445in./87.5mm (1982-1988) **4**
(cont.) (cont.)

Part Year VIN Model/Application Part Number Qty.

ENGINE GASKETS (cont.)

Rear Main Seal	1982-1988			47892	1
Rear Main Seal Set	1982-1988		Standard	JV524	1
			(Optional) <i>Teflon</i>	JV1637	1
Crank Repair Sleeve	1982-1988		Use With Part Number A505, Rear <i>Nickel Plated Formed Steel, .013" Thickness</i>	A342	1
Timing Cover Set	1982-1988			JV980	1
Timing Cover Seal	1982-1988			47929	1
Harmonic Balancer Repair Sleeve	1982-1988		Use With Part Number A508 <i>Nickel Plated Formed Steel, .013" Thickness</i>	A344	1

MISCELLANEOUS GASKETS

Air Cleaner Mount Gasket	1982-1987		2 Barrel Carburetor	G26129	1
Cam. Circular Plug	1986-1988		Rear	B45573	1
Camshaft Seal	1982-1988		Front	47929	1
	1982-1987		Rear <i>2.112" Outside Diameter</i>	47930	1
				Rear <i>2.061" Outside Diameter</i>	47931
Carb. Mount Gasket	1987-1988		Dakota, 2 Barrel Carburetor	G30717	1
	1986-1987		Grand Caravan, Grand Voyager, 2 Barrel Carburetor, Carburetor To Spacer	G25769	1
				Grand Caravan, Grand Voyager, 2 Barrel Carburetor, Spacer To Insulator	G25775
	1984-1987		Caravan, Mini Ram, Voyager, 2 Barrel Carburetor, Carburetor To Spacer	G25769	1
				Caravan, Mini Ram, Voyager, 2 Barrel Carburetor, Spacer To Insulator	G25775
	1982-1985		Rampage, 2 Barrel Carburetor, Carburetor To Spacer	G25769	1
			Rampage, 2 Barrel Carburetor, Spacer To Insulator	G25775	1
E.G.R. Gasket	1982-1988			G24091	1
Exhaust Pipe Gasket	1982-1988		(Ring Type 'F')	F7395	1
Fuel Pump Gasket	1982-1988			D24076	2
Intermediate Shaft Set	1982-1988			47929	1
Water Outlet Gasket	1982-1988			C25163	1
Water Pump Hsg. O-Ring	1982-1988			K30622	1
Water Pump Mount Gasket	1982-1988			K30621	1

5 143 CID (2.3L) SOHC Mitsubishi Diesel 4 Cyl, 3.587in./91.1mm (1983-1986) **5**

Part Year VIN Model/Application Part Number Qty.

ENGINE GASKETS

Head Set	1983-1986		Turbocharged	HS3786	1
Full Set	1983-1986		Turbocharged	FS3786	1
Cylinder Head Gasket	1983-1986		Turbocharged <i>VR2000</i>	3786	1
Valve Cover Set	1983-1986		(Camshaft Semi Circular Plug Not Included), Turbocharged <i>Victo-Tech</i>	VS39371	1
Valve Stem Seal, Exh.	1983-1986		(Original Equipment Type), Turbocharged	B45441	4
			(Premium), Turbocharged	B45806	4
Valve Stem Seal, Int.	1983-1986		(Original Equipment Type), Turbocharged	B45441	4
			(Premium), Turbocharged	B45806	4
Manifold Set, Int. & Exh.	1983-1986		Turbocharged	MS15378	1
Oil Pan Set	1983-1986		Turbocharged <i>Cork Rubber</i>	OS20776	1
Rear Main Seal Set	1983-1986		Turbocharged	JV534	1
Timing Cover Set	1983-1986		Turbocharged	JV995	1
Timing Cover Seal	1983-1986		Turbocharged	47730	1

MISCELLANEOUS GASKETS

Camshaft Seal	1983-1986		Turbocharged	47918	1
---------------	-----------	--	--------------	-------	---

LIGHT TRUCK

Dodge Truck

5 (cont.)	143 CID (2.3L) SOHC Mitsubishi Diesel 4 Cyl, 3.587in./91.1mm (1983-1986)				5 (cont.)
---------------------	---	--	--	--	---------------------

Part	Year	VIN	Model/Application	Part Number	Qty.
------	------	-----	-------------------	-------------	------

MISCELLANEOUS GASKETS (cont.)

Cam. Semi-Circular Plug	1983-1986		Turbocharged	B45621	1
E.G.R. Gasket	1984-1986		California, Turbocharged	G30710	1
Water Inlet Gasket	1983-1986		Turbocharged	C26842	1
Water Outlet Gasket	1983-1986		Turbocharged	C26846	1
Water Pump Mount Gasket	1983-1986		Turbocharged	K30620	1

6	144 CID (2.4L) 4G64 SOHC 8 Valve Mitsubishi 4 Cyl, 3.405in./86.5mm (1990-1993)				6
----------	---	--	--	--	----------

Part	Year	VIN	Model/Application	Part Number	Qty.
------	------	-----	-------------------	-------------	------

ENGINE GASKETS

Head Set	1993		(Exhaust Pipe Gasket Not Included, Throttle Body Gasket Not Included)	HS5747G	1
	1990-1992		(Exhaust Pipe Gasket Not Included)	HS5747X	1
Lower Set	1993		(Exhaust Pipe Gasket Not Included, Requires Head Set To Make Full Set), Use With Part Number HS5747G	CS5875B	1
	1990-1992		(Requires Head Set To Make Full Set), Use With Part Number HS5747X	CS5747W	1
Full Set	1990-1992		(Exhaust Pipe Gasket Not Included)	FS5747X	1
Cylinder Head Gasket	1990-1993		<i>Nitroseal</i>	5747	1
Valve Cover Set	1990-1993		(Valve Cover Grommets Not Included, Camshaft Semi Circular Plug Not Included) <i>Victo-Tech</i>	VS40003	1
			(Contains Valve Cover Grommets, Contains Camshaft Semi Circular Plug) <i>Victo-Tech</i>	VS40003CP	1
Valve Stem Seal, Exh.	1990-1993		(Premium)	B45806	4
	1990-1992		(Original Equipment Type)	B45441	4
Valve Stem Seal, Int.	1990-1993		(Premium)	B45806	4
	1990-1992		(Original Equipment Type)	B45441	4
Manifold Set, Exhaust	1993			MS15392	1
	1990-1992			MS15389	1
Manifold Set, Intake	1990-1993			MS15387	1
Plenum Chamber Gasket	1990-1993			MS14901	1
Oil Pan Set	1993		<i>Cork Rubber</i>	OS32137	1
	1990-1992		<i>Cork Rubber</i>	OS32008	1
Rear Main Seal Set	1990-1992			JV534	1
Timing Cover Set	1990-1992			JV1036	1
Timing Cover Seal	1990-1993			47730	1

MISCELLANEOUS GASKETS

Air Flow Sensor	1990			G30807	1
Camshaft Seal	1990-1993			47918	1
Cam. Semi-Circular Plug	1990-1993			B24180	1
E.G.R. Gasket	1990-1993		<i>Nitroseal</i>	G30714	1
Exhaust Pipe Gasket	1993		(Flange Type), Pipe To Manifold	F7409	1
	1990-1993		(Flange Type), Catalytic Converter To Center Pipe, Catalytic Converter To Front Exhaust Pipe	F7422	2
	1990-1992		(Flange Type), Pipe To Manifold	F12287	1
Injector Nozzle O-Ring	1990-1993			GS33277	1
Spark Plug Tube Seal	1993			B45881	1
Throttle Body Gasket	1993		Except California	G31115	1
	1990-1992			G31115	1
Valve Cover Grommet	1990-1993			B45729	2
Water Outlet Gasket	1990-1993			C24082	1
Water Pump Mount Gasket	1990-1992			K30615	1

7 148 CID/2429CC (2.4L) DOHC Chrysler 4 Cyl, 3.445in./87.5mm (1996-2003) **7**

Part	Year	VIN	Model/Application	Part Number	Qty.
ENGINE GASKETS					
Head Set	1996-2000			HS54044C	1
Lower Set	1996-2000			CS54044A	1
Engine Kit Gasket Set	1996-2000			95-3458VR	1
Cylinder Head Gasket	1996-2000		Multi-Layered Steel	54044A	1
Cyl. Head Bolt Set	1996-2003			GS33343	1
Valve Cover Set	1996-2000		(Contains Spark Plug Tube Seals) Victo-Tech	VS50271	1
Valve Stem Seal, Exh.	1996-2003			B45844	8
Valve Stem Seal, Int.	1996-2003			B45844	8
Manifold Set, Exhaust	1996-2000			MS12448	1
Manifold Set, Intake	1996-2000		(Contains Plenum Chamber Gasket) Nitroseal	MS16149A	1
			(Contains Plenum Chamber Gasket)	MS16149C	1
Plenum Chamber Gasket	1996-2000			MS16178	1
Oil Pan Set	2001-2003		Caravan, Voyager	Victo-Tech OS32155	1
	1996-2000			Victo-Tech OS32155	1
Rear Main Seal Set	1996-2001		(One Piece) Teflon	JV1629	1
			(One Piece) Rubber	JV1654	1

MISCELLANEOUS GASKETS					
Camshaft Seal	1996-2003		Front	48392	2
Cam Sensor O-Ring	1996-2003			GS33332	1
E.G.R. Gasket	1996-2001		Valve	G31321	1
	1996-2000		Exhaust Gas Recirculation Tube	G31474	1
Exhaust Pipe Gasket	2001-2002		PT Cruiser, (Flange Type), Pipe To Manifold	F7568	1
	1996-2000		(Flange Type), Pipe To Manifold	F7568	1
Injector Nozzle O-Ring	1997-2003			GS33276	2
Spark Plug Tube Seal	2001-2003		Caravan, Voyager	B45838	4
	1996-2000			B45838	4
Throttle Body Gasket	2001		Caravan, Voyager	G30817	1
	1996-2000			G30817	1
Water Outlet Gasket	1996-2001			C25163	1
Water Pump Mount Gasket	1996-2003			K31502	1

8 150 CID (2.5L) Jeep 4 Cyl, 3.875in./98.4mm (1996-2002) **8**

Part	Year	VIN	Model/Application	Part Number	Qty.
ENGINE GASKETS					
Head Set	1996-1998			HS3799B	1
Lower Set	1996-1998			CS3799A	1
Engine Kit Gasket Set	1996-1998			95-3479VR	1
Cylinder Head Gasket	1996-1998			3799	1
Valve Cover Set	1996-1998			VS50243	1
Valve Stem Seal, Exh.	1996-2002			B45799B	4
Valve Stem Seal, Int.	1996-2002			B45798B	4
Manifold Set, Int. & Exh.	1996-2002			MS15963X	1
Oil Pan Set	1996-2002			Victo-Tech OS32135	1
Rear Main Seal Set	1996-2002			JV553	1
Timing Cover Set	1996-2002			JV1166	1
Timing Cover Seal	1996-2002			46134	1

MISCELLANEOUS GASKETS					
Dist. Mounting Gasket	1996-2002			B26466	1
E.G.R. Gasket	1996		Exhaust Gas Recirculation Tube	G30824	2
Injector Nozzle O-Ring	1996-1998			GS33276	2
Throttle Body Gasket	1996-2002			G33268	1
Water Outlet Gasket	1996-2001			C31312	1
Water Pump Mount Gasket	1996-2001			K31313	1

LIGHT TRUCK

Dodge Truck

9

153 CID (2.5L) SOHC Chrysler 4 Cyl, 3.445in./87.5mm (1987-1995)

9

Part	Year	VIN	Model/Application	Part Number	Qty.	
ENGINE GASKETS						
Head Set	1993-1995		(Contains Head Bolts, Exhaust Pipe Gasket Not Included)	HS5764WB2	1	
			Stamped Steel Valve Cover, (Head Bolts Not Included, Exhaust Pipe Gasket Not Included, Camshaft Rear Seal Plug Not Included)	HS54097-2	1	
	1991-1995		Aluminum Valve Cover, (Head Bolts Not Included, Exhaust Pipe Gasket Not Included, Camshaft Rear Seal Plug Not Included)	HS54097-3	1	
	1991-1992		Stamped Steel Valve Cover, (Head Bolts Not Included, Rear Camshaft Plug Not Included, Exhaust Pipe Gasket Not Included), Naturally Aspirated	HS54097-2	1	
	1989-1992		(Contains Head Bolts, Exhaust Pipe Gasket Not Included), Naturally Aspirated	HS3688WB2	1	
	1989-1990		(Contains Head Bolts, Exhaust Pipe Gasket Not Included), Turbocharged	HS5764WB1	1	
			(Head Bolts Not Included, Exhaust Pipe Gasket Not Included), Turbocharged	HS54097-1	1	
	1987-1989		(Rear Camshaft Plug Not Included, Exhaust Pipe Gasket Not Included), Naturally Aspirated	HS54097-2	1	
	1987-1988		(Contains Head Bolts, Rear Camshaft Plug Not Included, Exhaust Pipe Gasket Not Included)	HS3688WB1	1	
Lower Set	1993-1995		Requires Head Set To Make Full Set	CS5764	1	
	1988-1995		(Requires Head Set To Make Full Set)	CS54097-2	1	
	1987		(Requires Head Set To Make Full Set)	CS54097-1	1	
Full Set	1989-1992		(Head Bolts Not Included, Exhaust Pipe Gasket Not Included), Naturally Aspirated	FS3688Z	1	
	1989-1990		(Head Bolts Not Included, Exhaust Pipe Gasket Not Included), Turbocharged	FS5764X	1	
	1988		(Head Bolts Not Included, Rear Camshaft Plug Not Included, Exhaust Pipe Gasket Not Included)	FS3688Y	1	
	1987		(Head Bolts Not Included, Rear Camshaft Plug Not Included, Exhaust Pipe Gasket Not Included)	FS3688X	1	
Engine Kit Gasket Set	1994-1995		(Valve Cover Set Not Included, Aluminum Cover Gasket Not Included, Camshaft Rear Seal Plug Not Included), Use With Part Numbers VS50067, B45573	95-3350VR	1	
	1989-1994		Stamped Steel Valve Cover, (Camshaft Rear Seal Plug Not Included), Use With Part Number B45573	95-3350VR	1	
	1989-1990		Except Intercooled Engine, Turbocharged	95-3351VR	1	
	1988		(Camshaft Rear Seal Plug Not Included), Use With Part Number B45573	95-3350VR	1	
	1987		(Oil Pan Gasket Not Included, Camshaft Rear Seal Plug Not Included), Use With Part Numbers OS32038, B45573	95-3350VR	1	
Cylinder Head Gasket	1987-1995		<i>Nitroseal</i>	54097	1	
			<i>Nitroseal, .093" Thickness</i>	54114G	1	
Cyl. Head Bolt Set	1987-1995		<i>11mm Bolts</i>	GS33184	1	
Cyl. Head Washer Set	1987-1995			GS33185	1	
Sealing Compound	1987-1992		(4 Ounce Brush Top Can)	JV66B	1	
			(12 Ounce Spray Can)	JV66S	1	
Valve Cover Set	1994-1995		Stamped Steel Cover	<i>Cork Rubber</i>	VS38039	1
			Aluminum Cover	<i>Victo-Tech</i>	VS50067	1
			Aluminum Valve Cover	<i>Victo-Tech</i>	VS50067	1
			Stamped Steel Cover	<i>Victo-Foam</i>	VS50309	1
	1987-1993		Naturally Aspirated	<i>Cork Rubber</i>	VS38039	1
			Naturally Aspirated	<i>Victo-Foam</i>	VS50309	1
	1989-1992		Turbocharged	<i>Victo-Tech</i>	VS50067	1
Valve Stem Seal, Exh.	1987-1995			B45449	4	
Valve Stem Seal, Int.	1987-1995			B45449	4	
Manifold Set, Int. & Exh.	1987-1995					
			<i>Nitroseal</i>	MS15313	1	
Oil Pan Set	1988-1995			<i>Victo-Tech</i>	OS32051	1
	1987			<i>Cork Rubber</i>	OS32038	1
Rear Main Seal	1987-1995			47892	1	
Rear Main Seal Set	1987-1995		Standard	JV524	1	

LIGHT TRUCK

9 153 CID (2.5L) SOHC Chrysler 4 Cyl, 3.445in./87.5mm (1987-1995) **9**
 (cont.) (cont.)

Part	Year	VIN	Model/Application	Part Number	Qty.
ENGINE GASKETS (cont.)					
Rear Main Seal Set (cont.)	1987-1995		(Optional) <i>Teflon</i>	JV1637	1
Crank Repair Sleeve	1987-1995		Use With Part Number A505, Rear <i>Nickel Plated Formed Steel, .013" Thickness</i>	A342	1
Timing Cover Set	1987-1995			JV1035	1
Timing Cover Seal	1987-1995			48061	1

MISCELLANEOUS GASKETS					
Air Cleaner Mount Gasket	1989-1995		Dakota	G30819	1
	1987			G30819	1
Cam. Circular Plug	1992-1995		Rear Plug	B45573	1
	1987-1995		Rear	B45573	1
Camshaft Seal	1987-1995		Front	47929	1
E.G.R. Gasket	1989-1994		Exhaust Gas Recirculation Tube	G30824	2
	1989-1992		Valve	G24079	1
	1987-1988			G24091	1
Exhaust Pipe Gasket	1987-1995		Caravan, Voyager, (Ring Type 'F'), Naturally Aspirated	F7395	1
	1989-1992		(Ring Type 'F')	F7466	1
	1987-1989		Grand Caravan, Grand Voyager, (Ring Type 'F'), Naturally Aspirated	F7395	1
	1987-1988		Mini Ram, (Ring Type 'F'), Naturally Aspirated	F7395	1
Fuel Pump Gasket	1989-1992		Dakota	D31042	1
	1987-1988			D24076	2
Intermediate Shaft Set	1987-1995			47929	1
Throttle Body Gasket	1987-1995		Naturally Aspirated	G30716	1
	1989-1990		Turbocharged	G31044	1
Water Outlet Gasket	1987-1995			C25163	1
Water Pump Hsg. O-Ring	1987-1995			K30622	1
Water Pump Mount Gasket	1989-1995			K31045	1
	1987-1988			K30621	1

10 156 CID (2.6L) SOHC "F" Mitsubishi 4 Cyl, 3.587in./91.1mm (1984-1987) **10**

Part	Year	VIN	Model/Application	Part Number	Qty.
ENGINE GASKETS					
Head Set	1984-1987	G	Caravan, Voyager, (Exhaust Pipe Gasket Not Included)	HS3697	1
Full Set	1987	G	Grand Caravan, (Exhaust Pipe Gasket Not Included)	FS3697	1
	1984-1987	G	Caravan, Mini Ram, Voyager, (Exhaust Pipe Gasket Not Included)	FS3697	1
Engine Kit Gasket Set	1984-1987		Except Turbocharged, Front Wheel Drive	95-3103VR	1
Cylinder Head Gasket	1984-1987	G	<i>VR2000</i>	3697	1
Cyl. Head Bolt Set	1984-1987			GS33325	1
Cyl. Head Spacer Shim	1984-1987	G	Requires Sealing Compound <i>Steel</i>	3697S	1
Sealing Compound	1984-1987		(4 Ounce Brush Top Can)	JV66B	1
			(12 Ounce Spray Can)	JV66S	1
Valve Cover Set	1984-1987	G	(Valve Cover Grommets Not Included, Camshaft Semi Circular Plug Not Included) <i>Victo-Tech</i>	VS39865	1
		G	(Contains Valve Cover Grommets, Contains Camshaft Semi Circular Plug) <i>Victo-Tech</i>	VS39865CP	1
Valve Stem Seal, Exh.	1984-1987	G	(Original Equipment Type)	B45441	4
		G	(Premium)	B45806	4
Valve Stem Seal, Int.	1984-1987	G	(Original Equipment Type)	B45441	4
		G	(Premium)	B45806	4
Manifold Set, Exhaust	1987	G	Grand Caravan	MS15299	1
		G	Grand Caravan, To Be Replaced By MS15299	MS15526	1

LIGHT TRUCK

Dodge Truck

10 156 CID (2.6L) SOHC "F" Mitsubishi 4 Cyl, 3.587in./91.1mm (1984-1987) **10**
 (cont.) (cont.)

Part Year VIN Model/Application Part Number Qty.

ENGINE GASKETS (cont.)

Manifold Set, Exhaust (cont.)	1984-1987	G	Caravan, Mini Ram, Voyager	MS15299	1
		G	Caravan, Mini Ram, Voyager, To Be Replaced By MS15299	MS15526	1
Manifold Set, Intake	1984-1987	G	<i>Performaseal</i>	MS15320	1
Oil Pan Set	1984-1987	G	<i>Cork Rubber</i>	OS20776	1
Rear Main Seal Set	1984-1987	G		JV534	1
Crank Repair Sleeve	1984-1987	G	Use With Part Number A512, Rear <i>Nickel Plated Formed Steel, .013" Thickness</i>	A346	1
Timing Cover Set	1984-1987	G		JV943	1
Timing Cover Seal	1984-1987	G		47735	1
Harmonic Balancer Repair Sleeve	1984-1987	G	Use With Part Number A500 <i>Nickel Plated Formed Steel, .013" Thickness</i>	A238	1

MISCELLANEOUS GASKETS

Air Cleaner Mount Gasket	1984-1987	G	2 Barrel Carburetor	G24965	1
Cam. Circular Plug	1984-1987	G		B45685	1
Camshaft Seal	1984-1987	G	Front Wheel Drive	47919	1
Cam. Semi-Circular Plug	1984-1987	G		B24180	1
Carb. Mount Gasket	1984-1987	G	California, High Altitude, 2 Barrel Carburetor	G25771	1
		G	Except California, Except High Altitude, 2 Barrel Carburetor	G30619	1
E.G.R. Gasket	1984-1987	G		G24078	1
Exhaust Pipe Gasket	1987	G	(Flange Type), Catalytic Converter To Center Pipe	F7422	1
	1984-1987	G	(Ring Type 'F')	F7395	1
	1984-1986	G	(Ring Type 'F'), Catalytic Converter To Exhaust Pipe	F7424	1
Fuel Pump Gasket	1984-1987	G		D24076	2
Jet Valve Seal	1984-1987	G	(Jet Valve)	B45471	4
Valve Cover Grommet	1984-1987	G		B45729	2
Water Outlet Gasket	1984-1987	G		C24082	1
Water Pipe O-Ring	1984-1987	G		B45797	1
Water Pump Mount Gasket	1984-1987	G		K26326	1

11 156 CID (2.6L) SOHC "W" Mitsubishi 4 Cyl, 3.590in./91.2mm (1979-1989) **11**

Part Year VIN Model/Application Part Number Qty.

ENGINE GASKETS

Head Set	1987-1989		Raider, (Exhaust Pipe And Exhaust Manifold Gasket for Canadian Models Not Included)	HS3697W	1
	1986-1989		Power Ram 50, (Exhaust Pipe And Exhaust Manifold Gasket for Canadian Models Not Included)	HS3697W	1
	1982-1989		Ram 50, (Exhaust Pipe And Exhaust Manifold Gasket for Canadian Models Not Included)	HS3697W	1
	1982-1983		Power Ram 50, (Exhaust Pipe And Exhaust Manifold Gasket for Canadian Models Not Included)	HS3697W	1
	1981-1982		Arrow, (Exhaust Pipe And Exhaust Manifold Gasket for Canadian Models Not Included)	HS3697W	1
	1981		Ram D50, (Exhaust Pipe And Exhaust Manifold Gasket for Canadian Models Not Included)	HS3697W	1
	1979-1980			HS3673	1
Full Set	1986-1989		Raider, (Exhaust Pipe And Exhaust Manifold Gasket for Canadian Models Not Included)	FS3697W	1
	1982-1985		Ram 50, (Exhaust Pipe And Exhaust Manifold Gasket for Canadian Models Not Included)	FS3697W	1
	1982-1983		Power Ram 50, (Exhaust Pipe And Exhaust Manifold Gasket for Canadian Models Not Included)	FS3697W	1
	1981-1982		Arrow, (Exhaust Pipe And Exhaust Manifold Gasket for Canadian Models Not Included)	FS3697W	1
	1981		Ram D50, (Exhaust Pipe And Exhaust Manifold Gasket for Canadian Models Not Included)	FS3697W	1

LIGHT TRUCK

11 (cont.)	156 CID (2.6L) SOHC "W" Mitsubishi 4 Cyl, 3.590in./91.2mm (1979-1989)				11 (cont.)
----------------------	--	--	--	--	----------------------

Part	Year	VIN	Model/Application	Part Number	Qty.
------	------	-----	-------------------	-------------	------

ENGINE GASKETS (cont.)

Full Set (cont.)	1979-1980			FS3673	1
Engine Kit Gasket Set	1980-1989			95-3104VR	1
Cylinder Head Gasket	1981-1989		<i>VR2000</i>	3697	1
	1979-1980			3673	1
Cyl. Head Bolt Set	1979-1989			GS33325	1
Cyl. Head Spacer Shim	1981-1989		Requires Sealing Compound	<i>Steel</i> 3697S	1
	1979-1980		Requires Sealing Compound	<i>Steel</i> 3673S	1
Sealing Compound	1979-1989		(4 Ounce Brush Top Can)	JV66B	1
			(12 Ounce Spray Can)	JV66S	1
Valve Cover Set	1981-1989		(Valve Cover Grommets Not Included, Camshaft Semi Circular Plug Not Included)	<i>Victo-Tech</i> VS39865	1
			(Contains Valve Cover Grommets, Contains Camshaft Semi Circular Plug)	<i>Victo-Tech</i> VS39865CP	1
	1979-1980			<i>Victo-Tech</i> VS39860	1
Valve Stem Seal, Exh.	1979-1989		(Original Equipment Type)	B45441	4
			(Premium)	B45806	4
Valve Stem Seal, Int.	1979-1989		(Original Equipment Type)	B45441	4
			(Premium)	B45806	4
Manifold Set, Exhaust	1987-1989		Raider	MS15299	1
			Raider, To Be Replaced By MS15299	MS15526	1
	1986-1989		Power Ram 50, Ram 50	MS15299	1
	1984-1985		Ram 50, Except Canadian Models	MS15299	1
	1981-1984		Canadian	MS15298	1
	1979-1983		Except Canadian Models	MS15299	1
	1979			MS15299	1
Manifold Set, Intake	1981-1989			<i>Performaseal</i> MS15320	1
	1979-1980			MS15295	1
Oil Pan Set	1979-1989			<i>Cork Rubber</i> OS20776	1
Rear Main Seal Set	1981-1989			JV534	1
	1979-1980			JV507	1
Crank Repair Sleeve	1979-1989		Use With Part Number A512, Rear	<i>Nickel Plated Formed Steel, .013" Thickness</i> A346	1
Timing Cover Set	1979-1989			JV943	1
Timing Cover Seal	1979-1989			47735	1
Harmonic Balancer Repair Sleeve	1982-1988		Use With Part Number A500	<i>Nickel Plated Formed Steel, .013" Thickness</i> A238	1
	1982		Use With Part Number A500	<i>Nickel Plated Formed Steel, .013" Thickness</i> A235	1

MISCELLANEOUS GASKETS

Air Cleaner Mount Gasket	1981-1989			G24965	1
	1979-1980			G24090	1
Cam. Circular Plug	1981-1989			B45685	1
Cam. Semi-Circular Plug	1982-1987			B24180	1
Carb. Mount Gasket	1987-1989		Multi-Port Fuel Injection	G30713	1
	1982-1986		Except Canadian Models, Multi-Port Fuel Injection	G25771	1
			Canadian, Multi-Port Fuel Injection	G30619	1
	1981		2 Barrel Carburetor	G25771	1
	1979-1980		2 Barrel Carburetor	G25784	1
E.G.R. Gasket	1987-1989			<i>Nitroseal</i> G30714	1
	1979-1986			G24078	1
Exhaust Pipe Gasket	1987-1989		(Flange Type), Catalytic Converter To Center Pipe	F7422	1
			(Flange Type)	F12287	1
	1985-1986		(Flange Type)	F7409	1
	1984-1986		(Ring Type 'F'), Catalytic Converter To Exhaust Pipe	F7424	1
	1981-1984		California, (Flange Type)	F7409	1

Dodge Truck

11 (cont.)	156 CID (2.6L) SOHC "W" Mitsubishi 4 Cyl, 3.590in./91.2mm (1979-1989)					11 (cont.)
----------------------	--	--	--	--	--	----------------------

<i>Part</i>	<i>Year</i>	<i>VIN</i>	<i>Model/Application</i>	<i>Part Number</i>	<i>Qty.</i>
-------------	-------------	------------	--------------------------	--------------------	-------------

MISCELLANEOUS GASKETS (cont.)

Exhaust Pipe Gasket (cont.)	1982-1983		California, (Ring Type 'F'), Catalytic Converter To Exhaust Pipe	F7424	1
Fuel Pump Gasket	1979-1989			D24076	2
Jet Valve Seal	1979-1989		(Jet Valve)	B45471	4
Valve Cover Grommet	1979-1989			B45729	2
Water Outlet Gasket	1979-1989			C24082	1
Water Pipe O-Ring	1981-1989			B45797	1
Water Pump Mount Gasket	1979-1989			K26487	1

12	170 CID (2.8L) OHV Chrysler 6 Cyl, 3.400in./86.4mm (1961-1969)					12
-----------	---	--	--	--	--	-----------

<i>Part</i>	<i>Year</i>	<i>VIN</i>	<i>Model/Application</i>	<i>Part Number</i>	<i>Qty.</i>
-------------	-------------	------------	--------------------------	--------------------	-------------

ENGINE GASKETS

Head Set	1961-1969			HS1162VE	1
Full Set	1961-1969			FS1162VE	1
Engine Kit Gasket Set	1963-1969		Except Aluminum Engine	95-3001VR	1
	1961		Except Aluminum Engine	95-3001VR	1
Cylinder Head Gasket	1961-1969		VR2000	1162VC	1
Valve Cover Set	1961-1969		Cork Rubber	VS39745	1
Valve Stem Seal, Int.	1961-1969			B45298	6
Manifold Set, Int. & Exh.	1961-1969			MS16030	1
Oil Pan Set	1961-1969		Cork Rubber	OS30920X	1
Rear Main Seal Set	1961-1969		Rubber	JV607	1
Timing Cover Set	1961-1969			JV814	1
			(Contains Repair Sleeve)	JV923	1
Timing Cover Gasket	1961-1969			T28762	1
Timing Cover Seal	1961-1969			64572	1
Harmonic Balancer Repair Sleeve	1961-1969		Ground Steel, .020" Thickness	66593RS	1
			Nickel Plated Formed Steel, .013" Thickness	A223-1	1

MISCELLANEOUS GASKETS

Air Cleaner Mount Gasket	1961-1969		1 Barrel Carburetor	G25936	2
Carb. Mount Gasket	1962-1969			G7173	1
	1961		Positive Vent	G7173	1
Exhaust Pipe Gasket	1964-1969		(Flange Type)	F5495C	2
	1961-1963		(Flange Type)	F5438AK	1
Fuel Pump Gasket	1961-1969			D27094	1
Spark Plug Tube Seal	1961-1969			B45384	6
Water Outlet Gasket	1961-1969			C24109	1
Water Pump Backing Plate	1961-1969			K27564	1
Water Pump Mount Gasket	1961-1969			K27564	1

13	181 CID (3.0L) SOHC Mitsubishi V6 Cyl, 3.587in./91.1mm (1987-2000)					13
-----------	---	--	--	--	--	-----------

<i>Part</i>	<i>Year</i>	<i>VIN</i>	<i>Model/Application</i>	<i>Part Number</i>	<i>Qty.</i>
-------------	-------------	------------	--------------------------	--------------------	-------------

ENGINE GASKETS

Head Set	1987-2000		(Exhaust Pipe Gasket Not Included)	HS5765-1	1
	1989-1992	3	(Exhaust Pipe Gasket Not Included)	HS5765-1	1
		S	(Exhaust Pipe Gasket Not Included)	HS5765-2	1
Lower Set	1987-2000		(Requires Head Set To Make Full Set)	CS5765-1	1
Engine Kit Gasket Set	1987-1998			95-3192VR	1
Cylinder Head Gasket	1987-2000		Nitroseal	5765	2
Cyl. Head Bolt Set	1987-2000			GS33327	1

13
(cont.)

181 CID (3.0L) SOHC Mitsubishi V6 Cyl, 3.587in./91.1mm (1987-2000)

13
(cont.)

Part	Year	VIN	Model/Application	Part Number	Qty.
ENGINE GASKETS (cont.)					
Cyl. Head Spacer Shim	1987-2000		Requires Sealing Compound <i>Steel</i>	5765S	2
Sealing Compound	1987-2000		(4 Ounce Brush Top Can)	JV66B	1
			(12 Ounce Spray Can)	JV66S	1
Valve Cover Set	1987-2000		(Contains Valve Cover Grommets) <i>Victo-Tech</i>	VS50054	1
			(Valve Cover Grommets Not Included, Camshaft Circular Plug Not Included) <i>Victo-Tech</i>	VS50256	1
			(Contains Valve Cover Grommets, Contains Camshaft Circular Plugs) <i>Victo-Tech</i>	VS50257	1
Valve Stem Seal, Exh.	1987-2000		<i>Fluoroelastomer</i>	B45790	6
Valve Stem Seal, Int.	1987-2000		<i>Fluoroelastomer</i>	B45790	6
Manifold Set, Exhaust	1987-2000			MS15543	1
Manifold Set, Intake	1993-2000		(Contains Plenum Chamber Gasket)	MS15444	1
	1989-1992	3	(Contains Plenum Chamber Gasket)	MS15444	1
		S	(Contains Plenum Chamber Gasket)	MS15444X	1
	1987-1988		(Contains Plenum Chamber Gasket)	MS15444	1
Plenum Chamber Gasket	1987-2000			MS12342	1
	1989-1992	3		MS12342	1
		S		MS15982	1
Oil Pan Set	1987-2000		<i>Cork Rubber</i>	OS32054	1
Rear Main Seal Set	1987-2000			JV1062	1
Crank Repair Sleeve	1987-1996		Use With Part Number A505, Rear <i>Nickel Plated Formed Steel, .013" Thickness</i>	A342	1
			Front <i>Nickel Plated Formed Steel, .013" Thickness</i>	A357	1
Timing Cover Set	1987-2000			JV565	1
	1989-1992	3		JV565	1
		S		JV1118	1
MISCELLANEOUS GASKETS					
Air Flow Sensor	1987-1990			G30807	1
Cam. Circular Plug	1987-2000			B45682	2
Camshaft Seal	1987-2000			47918	2
E.G.R. Gasket	1993-2000		Valve To Exhaust Manifold	G24079	1
			Tube To Plenum	G30824	1
			Tube To Exhaust Manifold	G31474	1
	1998			G30824	1
	1993-1994		Tube To Plenum, Valve To Exhaust Manifold	G30824	1
	1989-1992	S	<i>Nitroseal</i>	G30714	1
		3	Tube To Plenum, Valve To Exhaust Manifold	G30824	2
1987-1988		Tube To Plenum, Valve To Exhaust Manifold	G30824	2	
Exhaust Pipe Gasket	1990-1995		(Ring Type 'F'), Pipe To Manifold	F7466	1
	1987-1993		(Flange Type), Crossover Pipe To Manifold	F7278	2
	1990-1992	S	(Flange Type), Catalytic Converter, Pipe To Manifold	F7409	4
	1989-1992	3	(Flange Type), Crossover Pipe To Manifold	F7278	2
		3	(Ring Type 'F'), Pipe To Manifold	F7466	1
	1989	S	(Flange Type), Pipe To Manifold	F7409	2
	1987-1988		(Ring Type 'F'), Pipe To Manifold	F7275	1
Fuel Pump Gasket	1987-1996			D24076	1
	1989-1992	3		D24076	1
Injector Nozzle O-Ring	1987-2000			GS33275	1
Throttle Body Gasket	1993-2000			G31044	1
	1989-1992	3		G31044	1
	1987-1988			G30817	1
Valve Cover Grommet	1987-2000			B45729	4
Water Outlet Gasket	1987-2000			C24082	1
Water Pipe O-Ring	1987-2000			B45797	2

LIGHT TRUCK

Dodge Truck

13	181 CID (3.0L) SOHC Mitsubishi V6 Cyl, 3.587in./91.1mm (1987-2000)	13
(cont.)		(cont.)

Part	Year	VIN	Model/Application	Part Number	Qty.
------	------	-----	-------------------	-------------	------

MISCELLANEOUS GASKETS (cont.)

Water Pump Mount Gasket	1987-2000		Adapter To Block	K30816	1
	1987-1996		Pump To Adapter	K31160	1

14	198 CID (3.2L) OHV Chrysler 6 Cyl, 3.400in./86.4mm (1970-1971)	14
-----------	---	-----------

Part	Year	VIN	Model/Application	Part Number	Qty.
------	------	-----	-------------------	-------------	------

ENGINE GASKETS

Head Set	1970-1971			HS1162VE	1
Full Set	1970-1971			FS1162VE	1
Engine Kit Gasket Set	1970-1971		Except Aluminum Engine	95-3001VR	1
Cylinder Head Gasket	1970-1971		<i>VR2000</i>	1162VC	1
Valve Cover Set	1970-1971		<i>Cork Rubber</i>	VS39745	1
Valve Stem Seal, Int.	1970-1971			B45298	6
Manifold Set, Int. & Exh.	1970-1971			MS16030	1
Oil Pan Set	1970-1971		<i>Cork Rubber</i>	OS30920X	1
Rear Main Seal Set	1970-1971		<i>Rubber</i>	JV607	1
Timing Cover Set	1970-1971			JV814	1
			(Contains Repair Sleeve)	JV923	1
Timing Cover Gasket	1970-1971			T28762	1
Timing Cover Seal	1970-1971			64572	1
Harmonic Balancer Repair Sleeve	1970-1971		<i>Ground Steel, .020" Thickness</i>	66593RS	1
			<i>Nickel Plated Formed Steel, .013" Thickness</i>	A223-1	1

MISCELLANEOUS GASKETS

Air Cleaner Mount Gasket	1970-1971			G26540	1
Carb. Mount Gasket	1970-1971			G24105	1
Exhaust Pipe Gasket	1970-1971		(Flange Type)	F5495C	2
Fuel Pump Gasket	1970-1971			D27094	1
Oil Pump Body Gasket	1970-1971			B26477	1
Spark Plug Tube Seal	1970-1971			B45384	6
Water Outlet Gasket	1970-1971			C24109	1
Water Pump Backing Plate	1970-1971			K27564	1
Water Pump Mount Gasket	1970-1971			K27564	1

15	201 CID (3.3L) Chrysler V6 Cyl, 3.661in./93mm (1990-2003)	15
-----------	--	-----------

Part	Year	VIN	Model/Application	Part Number	Qty.
------	------	-----	-------------------	-------------	------

ENGINE GASKETS

Head Set	1998-2000		(Head Bolts Not Included, Exhaust Pipe Gasket Not Included, Intake Manifold Gasket Not Included)	HS54086A	1
	1990-1997		(Head Bolts Not Included, Exhaust Pipe Gasket Not Included, Intake Manifold Gasket Not Included)	HS5892	1
			(Contains Head Bolts, Exhaust Pipe Gasket Not Included, Intake Manifold Gasket Not Included)	HS5892WB	1
Lower Set	1990-2001		(Requires Head Set To Make Full Set)	CS5896	1
Full Set	1990-1997		(Head Bolts Not Included, Exhaust Pipe Gasket Not Included, Intake Manifold Gasket Not Included)	FS5892	1
Engine Kit Gasket Set	1990-1997		(Intake Manifold Gasket Not Included), Use With Part Number MS15984	95-3446VR	1
Cylinder Head Gasket	2001-2003	Right	<i>Multi-Layered Steel</i>	54322	1
		Left	<i>Multi-Layered Steel</i>	54323	1
	1998-2000	Right	<i>Nitroseal</i>	54086G	1
		Left	<i>Nitroseal</i>	54087G	1
	1990-1997	Left	<i>Nitroseal</i>	5985G	1

LIGHT TRUCK

15 201 CID (3.3L) Chrysler V6 Cyl, 3.661in./93mm (1990-2003) **15**
(cont.) (cont.)

Part	Year	VIN	Model/Application	Part Number	Qty.
ENGINE GASKETS (cont.)					
Cylinder Head Gasket (cont.)	1990-1997		Right	<i>Nitroseal</i> 5986G	1
Cyl. Head Bolt Set	1997-2002		(Contains Washers)	GS33360	2
	1990-1996			GS33251	2
Cyl. Head Washer Set	1990-1996			GS33256	16
Cyl. Head Spacer Shim	1990-1997		Requires Sealing Compound, Left	<i>Steel</i> 5892S	1
			Requires Sealing Compound, Right	<i>Steel</i> 5893S	1
Sealing Compound	1990-1997		(4 Ounce Brush Top Can)	JV66B	1
			(12 Ounce Spray Can)	JV66S	1
Valve Cover Set	1998-2000			<i>Victo-Tech</i> VS50324	1
	1990-1997			<i>Victo-Tech</i> VS50143R	1
					<i>Tuff-Cork</i> VS50143TC
Valve Stem Seal, Exh.	1990-2000			B45449	6
Valve Stem Seal, Int.	1990-2000			B45449	6
Manifold Set, Exhaust	1990-2000			MS12399	1
Manifold Set, Intake	1990-2000		(Contains Plenum Chamber Gasket)	MS15984	1
Plenum Chamber Gasket	1990-2000			MS16300	1
Oil Pan Set	1990-2002			<i>Tuff-Cork</i> OS32103TC	1
				<i>Victo-Tech</i> OS32111	1
Rear Main Seal	1990-2000			47892	1
Rear Main Seal Set	1990-2000			JV1600	1
Timing Cover Set	1990-2001		(Requires Oil Pan Set)	JV1124	1
Timing Cover Seal	1990-2003			48061	1

MISCELLANEOUS GASKETS

E.G.R. Gasket	2001-2002		Tube To Valve	G31458	1
			Tube To Plenum	G31495	1
	2001		Valve	G31321	1
	1996-2000		Exhaust Gas Recirculation Tube	G31554	2
	1990-2000		Valve	G24079	1
	1990-1995		Exhaust Gas Recirculation Tube	G30824	2
Exhaust Pipe Gasket	1996-2000		(Flange Type), Exhaust Manifold To Converter	F7568	1
	1990-2000		(Flange Type), Crossover Pipe To Manifold	F12380	2
	1990-1995		(Ring Type 'F')	F7466	1
Injector Nozzle O-Ring	1990-2003			GS33276	3
Throttle Body Gasket	1990-2000			G30817	1
Water Outlet Gasket	1990-2000			C25163	1
Water Pump Mount Gasket	1990-2000			K31177	1

16 201 CID (3.3L) Chrysler CNG V6 Cyl, 3.661in./93mm (1994-1996) **16**

Part	Year	VIN	Model/Application	Part Number	Qty.
ENGINE GASKETS					
Head Set	1994-1996		(Head Bolts Not Included, Exhaust Pipe Gasket Not Included, Intake Manifold Gasket Not Included)	HS5892	1
			(Contains Head Bolts, Exhaust Pipe Gasket Not Included, Intake Manifold Gasket Not Included)	HS5892WB	1
Lower Set	1994-1996		(Requires Head Set To Make Full Set)	CS5896	1
Full Set	1994-1996		(Head Bolts Not Included, Exhaust Pipe Gasket Not Included, Intake Manifold Gasket Not Included)	FS5892	1
Engine Kit Gasket Set	1994-1995		(Intake Manifold Gasket Not Included), Use With Part Number MS15984	95-3446VR	1
Cylinder Head Gasket	1994-1996		Left	<i>Nitroseal</i> 5985G	1
			Right	<i>Nitroseal</i> 5986G	1
Cyl. Head Bolt Set	1994-1996			GS33251	2
Cyl. Head Washer Set	1994-1996			GS33256	16

Dodge Truck

16 (cont.)	201 CID (3.3L) Chrysler CNG V6 Cyl, 3.661in./93mm (1994-1996)				16 (cont.)
----------------------	--	--	--	--	----------------------

Part	Year	VIN	Model/Application	Part Number	Qty.
ENGINE GASKETS (cont.)					
Cyl. Head Spacer Shim	1994-1996		Requires Sealing Compound, Left	<i>Steel</i> 5892S	1
			Requires Sealing Compound, Right	<i>Steel</i> 5893S	1
Sealing Compound	1994-1996		(4 Ounce Brush Top Can)	JV66B	1
			(12 Ounce Spray Can)	JV66S	1
Valve Cover Set	1994-1996			<i>Victo-Tech</i> VS50143R	1
				<i>Tuff-Cork</i> VS50143TC	1
Valve Stem Seal, Exh.	1994-1996			B45449	6
Valve Stem Seal, Int.	1994-1996			B45449	6
Manifold Set, Exhaust	1994-1996			MS12399	1
Manifold Set, Intake	1994-1996		(Contains Plenum Chamber Gasket)	MS15984	1
Plenum Chamber Gasket	1994-1996			MS16300	1
Oil Pan Set	1994-1996			<i>Tuff-Cork</i> OS32103TC	1
				<i>Victo-Tech</i> OS32111	1
Rear Main Seal	1994-1996			47892	1
Rear Main Seal Set	1994-1996			JV1600	1
Timing Cover Set	1994-1996		(Requires Oil Pan Set)	JV1124	1
Timing Cover Seal	1994-1996			48061	1

MISCELLANEOUS GASKETS

E.G.R. Gasket	1996		Exhaust Gas Recirculation Tube	G31554	2
	1994-1996		Valve	G24079	1
	1994-1995		Exhaust Gas Recirculation Tube	G30824	2
Exhaust Pipe Gasket	1996		(Flange Type), Exhaust Manifold To Converter	F7568	1
	1994-1996		(Flange Type), Crossover Pipe To Manifold	F12380	2
	1994-1995		(Ring Type 'F')	F7466	1
Injector Nozzle O-Ring	1994-1996			GS33276	3
Throttle Body Gasket	1994-1996			G30817	1
Water Outlet Gasket	1994-1996			C25163	1
Water Pump Mount Gasket	1994-1996			K31177	1

17	201 CID (3.3L) EGM Chrysler Flex Fuel V6 Cyl, 3.661in./93mm (1998-2003)				17
-----------	--	--	--	--	-----------

Part	Year	VIN	Model/Application	Part Number	Qty.
ENGINE GASKETS					
Head Set	1998-2000		(Head Bolts Not Included, Exhaust Pipe Gasket Not Included, Intake Manifold Gasket Not Included)	HS54086A	1
Lower Set	1998-2001		(Requires Head Set To Make Full Set)	CS5896	1
Cylinder Head Gasket	2001-2003		Right	<i>Multi-Layered Steel</i> 54322	1
			Left	<i>Multi-Layered Steel</i> 54323	1
	1998-2000		Right	<i>Nitroseal</i> 54086G	1
			Left	<i>Nitroseal</i> 54087G	1
Cyl. Head Bolt Set	1998-2002		(Contains Washers)	GS33360	2
Valve Cover Set	1998-2000			<i>Victo-Tech</i> VS50324	1
Valve Stem Seal, Exh.	1998-2000			B45449	6
Valve Stem Seal, Int.	1998-2000			B45449	6
Manifold Set, Exhaust	1998-2000			MS12399	1
Manifold Set, Intake	1998-2000		(Contains Plenum Chamber Gasket)	MS15984	1
Plenum Chamber Gasket	1998-2000			MS16300	1
Oil Pan Set	1998-2002			<i>Tuff-Cork</i> OS32103TC	1
				<i>Victo-Tech</i> OS32111	1
Rear Main Seal	1998-2000			47892	1
Rear Main Seal Set	1998-2000			JV1600	1
Timing Cover Set	1998-2001		(Requires Oil Pan Set)	JV1124	1
Timing Cover Seal	1998-2003			48061	1

17 201 CID (3.3L) EGM Chrysler Flex Fuel V6 Cyl, 3.661in./93mm (1998-2003) **17**
(cont.) (cont.)

Part	Year	VIN	Model/Application	Part Number	Qty.
MISCELLANEOUS GASKETS					
E.G.R. Gasket	2001-2002		Tube To Valve	G31458	1
			Tube To Plenum	G31495	1
	2001		Valve	G31321	1
	1998-2000		Valve	G24079	1
			Exhaust Gas Recirculation Tube	G31554	2
Exhaust Pipe Gasket	1998-2000		(Flange Type), Exhaust Manifold To Converter	F7568	1
			(Flange Type), Crossover Pipe To Manifold	F12380	2
Injector Nozzle O-Ring	1998-2003			GS33276	3
Throttle Body Gasket	1998-2000			G30817	1
Water Outlet Gasket	1998-2000			C25163	1
Water Pump Mount Gasket	1998-2000			K31177	1

18 218 CID (3.6L) L-Head Chrysler 6 Cyl, 3.250in./82.6mm (1942-1954) **18**

Part	Year	VIN	Model/Application	Part Number	Qty.
ENGINE GASKETS					
Head Set	1942-1954			HS1059C	1
Full Set	1942-1954		(Timing Cover And Rear Main Seal Sets Not Included)	FS1059C	1
Cylinder Head Gasket	1942-1954		VR2000	1059C	1
Manifold Gasket	1942-1954		Intake To Exhaust	B17186	1
Manifold Set, Int. & Exh.	1942-1954			MS18005	1
Oil Pan Set	1942-1954		Cork Rubber	OS30893	1
Rear Main Seal Set	1953-1954			JV134-9	1
Timing Cover Set	1953-1954			JV826	1
	1947-1952			JV757	1
	1942-1946			JV755	1

MISCELLANEOUS GASKETS					
Air Cleaner Mount Gasket	1942-1954		Except PW Series, 1 Barrel Carburetor	G26540	1
Air Cleaner Sleeve	1942-1954			G25936	1
Carb. Mount Gasket	1951-1954		1 Barrel Carburetor	G5349AD	1
Exhaust Pipe Gasket	1942-1954		(Flange Type)	F5438AK	1
Fuel Pump Bowl Gasket	1948-1950			D35288	1
Push Rod Cover Set	1942-1954		Cork Rubber	VS36054	1
Timing Cover Dust Seal	1953-1954			42379	1
Water Outlet Gasket	1942-1954			C24109	1
Water Pump Mount Gasket	1942-1954			K25845	1

19 225 CID (3.7L) OHV Chrysler 6 Cyl, 3.400in./86.4mm (1961-1987) **19**

Part	Year	VIN	Model/Application	Part Number	Qty.
ENGINE GASKETS					
Head Set	1981-1987			HS3955	1
	1961-1980			HS1162VE	1
Full Set	1981-1987			FS3955	1
	1961-1980			FS1162VE	1
Engine Kit Gasket Set	1981-1987			95-3068VR	1
	1961-1980		Except Aluminum Engine	95-3001VR	1
Cylinder Head Gasket	1961-1987		VR2000	1162VC	1
Valve Cover Set	1981-1987		Cork Rubber	VS39720	1
	1961-1980		Cork Rubber	VS39745	1
Valve Stem Seal, Exh.	1961-1987			B45327	6
Valve Stem Seal, Int.	1961-1987			B45298	6

LIGHT TRUCK

Dodge Truck

19 225 CID (3.7L) OHV Chrysler 6 Cyl, 3.400in./86.4mm (1961-1987) **19**
 (cont.) (cont.)

Part Year VIN Model/Application Part Number Qty.

ENGINE GASKETS (cont.)

Manifold Set, Int. & Exh.	1961-1987			MS16030	1
Oil Pan Set	1961-1987		Cork Rubber	OS30920X	1
Rear Main Seal Set	1961-1987		Rubber	JV607	1
Timing Cover Set	1961-1987		(Contains Repair Sleeve)	JV814	1
				JV923	1
Timing Cover Gasket	1961-1987			T28762	1
Timing Cover Seal	1961-1987			64572	1
Harmonic Balancer Repair Sleeve	1961-1987		Ground Steel, .020" Thickness	66593RS	1
			Nickel Plated Formed Steel, .013" Thickness	A223-1	1

MISCELLANEOUS GASKETS

Air Cleaner Mount Gasket	1979-1987		1 Barrel Carburetor	G26540	1
	1981-1983		2 Barrel Carburetor	G25936	2
	1961-1978		2 Barrel Carburetor	G25936	2
Air Pump Gasket	1975-1987		Air Injection Tube	B45559	1
Carb. Mount Gasket	1981-1987		1 Barrel Carburetor	G25456	1
	1981-1983		2 Barrel Carburetor	G14140	1
	1978-1980		2 Barrel Carburetor	G14140	1
	1974-1977		1 Barrel Carburetor	G25456	1
	1961-1974		Positive Vent, 1 Barrel Carburetor	G7173	1
	1973		1 Barrel Carburetor	G7173	1
E.G.R. Gasket	1973-1987			G24079	1
Exhaust Pipe Gasket	1964-1987		(Flange Type)	F5495C	2
	1961-1963		(Flange Type)	F5438AK	1
Fuel Pump Gasket	1961-1987			D27094	1
Oil Filler Pipe Gasket	1981-1987			B45574	1
Oil Pump Body Gasket	1979-1987			B26339	1
	1970-1978			B26477	1
Spark Plug Tube Seal	1961-1984			B45384	6
Water Outlet Gasket	1961-1987			C24109	1
Water Pump Backing Plate	1961-1987			K27564	1
Water Pump Mount Gasket	1961-1987			K27564	1

20 226 CID/3701CC (3.7L) EKG SOHC 12 Valve Chrysler V6 Cyl, 3.661in./93mm (2002-2003) **20**

Part Year VIN Model/Application Part Number Qty.

ENGINE GASKETS

Head Set	2002-2003			HS54250	1
Lower Set	2002-2003		(Requires Head Set To Make Full Set)	CS54250	1
Cylinder Head Gasket	2002-2003		Multi-Layered Steel	54250	2
Valve Cover Set	2002-2003			VS50325	1
Valve Stem Seal, Exh.	2002-2003			B45909A	6
Valve Stem Seal, Int.	2002-2003			B45909A	6
Manifold Set, Exhaust	2002-2003			MS16349	1
Manifold Set, Intake	2002-2003			MS16353	1
Oil Pan Set	2002-2003			OS32234	1
Rear Main Seal	2002-2003			67632	1
Timing Cover Seal	2002-2003			67629	1

MISCELLANEOUS GASKETS

Throttle Body Gasket	2002-2003			G31637	1
Water Pump Mount Gasket	2002-2003			K31598	1

LIGHT TRUCK

21 228 CID (3.7L) L-Head Dodge 6 Cyl, 3.375in./85.7mm (1937-1941) 21

Part	Year	VIN	Model/Application	Part Number	Qty.
ENGINE GASKETS					
Valve Cover Set	1937-1941			Cork Rubber VS38219	1
Oil Pan Set	1937-1941			Cork Rubber OS30899	1
Rear Main Seal Set	1941			Rubber JV134-6	1
	1940	Late		Rubber JV134-6	1
Timing Cover Set	1937-1941			JV755	1

22 230 CID (3.8L) Chrysler V6 Cyl, 3.780in./96mm (1994-2003) 22

Part	Year	VIN	Model/Application	Part Number	Qty.
ENGINE GASKETS					
Head Set	1994-1999		(Head Bolts Not Included, Exhaust Pipe Gasket Not Included, Intake Manifold Gasket Not Included)	HS5894	1
			(Contains Head Bolts, Exhaust Pipe Gasket Not Included, Intake Manifold Gasket Not Included)	HS5894WB	1
Lower Set	1994-2001		(Requires Head Set To Make Full Set)	CS5896	1
Full Set	1994-1998		(Head Bolts Not Included, Exhaust Pipe Gasket Not Included, Intake Manifold Gasket Not Included)	FS5894	1
Cylinder Head Gasket	2001-2003		Left	Multi-Layered Steel 54324	1
			Right	Multi-Layered Steel 54325	1
	1994-1999		Left	Nitroseal 5894	1
			Right	Nitroseal 5895	1
Cyl. Head Bolt Set	1997-2003		(Contains Washers)	GS33360	2
	1994-1996			GS33251	2
Cyl. Head Washer Set	1994-1996			GS33256	16
Valve Cover Set	2000			Victo-Tech VS50324	1
				Victo-Tech VS50143R	1
				Tuff-Cork VS50143TC	1
Valve Stem Seal, Exh.	1994-2000			B45449	6
Valve Stem Seal, Int.	1994-2000			B45449	6
Manifold Set, Exhaust	1994-1998			MS12399	1
Manifold Set, Intake	1994-2000		(Contains Plenum Chamber Gasket)	MS15984	1
Plenum Chamber Gasket	1994-2000			MS16300	1
Oil Pan Set	1994-2002			Tuff-Cork OS32103TC	1
				Victo-Tech OS32111	1
Rear Main Seal	1994-2000			47892	1
Rear Main Seal Set	1994-1998			JV1600	1
Timing Cover Set	1994-2001		(Requires Oil Pan Set)	JV1124	1
Timing Cover Seal	1994-2003			48061	1

MISCELLANEOUS GASKETS					
E.G.R. Gasket	1996-2000		Exhaust Gas Recirculation Tube	G31554	2
	1994-2000		Valve	G24079	1
	1994-1995		Exhaust Gas Recirculation Tube	G30824	2
Exhaust Pipe Gasket	1994-2000		(Flange Type), Crossover Pipe To Manifold	F12380	2
	1994-1995		(Ring Type 'F')	F7466	1
Injector Nozzle O-Ring	1994-2003			GS33276	3
Throttle Body Gasket	1994-2000			G30817	1
Water Outlet Gasket	1994-2000			C25163	1
Water Pump Mount Gasket	1994-2000			K31177	1

23 230 CID (3.8L) L-Head Dodge 6 Cyl, 3.250in./82.6mm (1942-1960) 23

Part	Year	VIN	Model/Application	Part Number	Qty.
ENGINE GASKETS					
Head Set	1942-1960			HS1059C	1
Full Set	1942-1960		(Timing Cover And Rear Main Seal Sets Not Included)	FS1059C	1
Cylinder Head Gasket	1942-1960			VR2000 1059C	1

LIGHT TRUCK

Dodge Truck

23 (cont.)	230 CID (3.8L) L-Head Dodge 6 Cyl, 3.250in./82.6mm (1942-1960)				23 (cont.)
----------------------	---	--	--	--	----------------------

Part	Year	VIN	Model/Application	Part Number	Qty.
ENGINE GASKETS (cont.)					
Manifold Gasket	1942-1960		Intake To Exhaust	B17186	1
Manifold Set, Int. & Exh.	1942-1960			MS18005	1
Oil Pan Set	1942-1960			Cork Rubber OS30893	1
Rear Main Seal Set	1954-1960			JV134-9	1
	1942-1953			Rubber JV134-6	1
Timing Cover Set	1954-1960			JV826	1
	1947-1953			JV757	1
	1942-1946			JV755	1

MISCELLANEOUS GASKETS

Air Cleaner Mount Gasket	1942-1960			G26540	1
Air Cleaner Sleeve	1942-1960			G25936	1
Carb. Mount Gasket	1951-1954		1 Barrel Carburetor	G5349AD	1
			1 Barrel Carburetor	G5349AD	1
Exhaust Pipe Gasket	1942-1960		(Flange Type)	F5438AK	1
Fuel Pump Bowl Gasket	1948-1950			D35288	1
Push Rod Cover Set	1942-1960			Cork Rubber VS36054	1
Timing Cover Dust Seal	1953-1960			42379	1
Water Outlet Gasket	1942-1960			C25487	1
Water Pump Mount Gasket	1942-1960			K25845	1

24	236 CID (3.9L) L-Head Dodge 6 Cyl, 3.438in./87.33mm (1942-1952)				24
-----------	--	--	--	--	-----------

Part	Year	VIN	Model/Application	Part Number	Qty.
ENGINE GASKETS					
Head Set	1948-1952			HS4922	1
Full Set	1948-1952		(Timing Cover And Rear Main Seal Sets Not Included)	FS4922	1
Cylinder Head Gasket	1942-1952		Except Canadian Models	VR2000 4922	1
Manifold Set, Int. & Exh.	1948-1952			MS15029	1
Oil Pan Set	1948-1952			Cork Rubber OS30899	1
Rear Main Seal Set	1948-1952			JV134-9	1
Timing Cover Set	1948-1952			JV757	1

MISCELLANEOUS GASKETS

Air Cleaner Mount Gasket	1948-1952			G26540	1
Carb. Mount Gasket	1948-1952		1 Barrel Carburetor	G5349AD	1
Exhaust Pipe Gasket	1948-1952		(Flange Type)	F7153	2
Push Rod Cover Set	1948-1952			Cork Rubber VS38219	1
Water Outlet Gasket	1948-1952			C25487	1
Water Pump Mount Gasket	1948-1952			K25845	1

25	237 CID (3.9L) L-Head Dodge 6 Cyl, 3.438in./87.33mm (1948-1952)				25
-----------	--	--	--	--	-----------

Part	Year	VIN	Model/Application	Part Number	Qty.
ENGINE GASKETS					
Head Set	1948-1952			HS4922	1
Full Set	1948-1952		(Timing Cover And Rear Main Seal Sets Not Included)	FS4922	1
Cylinder Head Gasket	1948-1952			VR2000 4922	1
Manifold Set, Int. & Exh.	1948-1952			MS15029	1
Oil Pan Set	1948-1952			Cork Rubber OS30899	1
Rear Main Seal Set	1948-1952			JV134-9	1

25 237 CID (3.9L) L-Head Dodge 6 Cyl, 3.438in./87.33mm (1948-1952) **25**
 (cont.) (cont.)

Part	Year	VIN	Model/Application	Part Number	Qty.
ENGINE GASKETS (cont.)					
Timing Cover Set	1948-1952			JV757	1
MISCELLANEOUS GASKETS					
Air Cleaner Mount Gasket	1948-1952			G26540	1
Carb. Mount Gasket	1948-1952		1 Barrel Carburetor	G5349AD	1
Exhaust Pipe Gasket	1948-1952		(Flange Type)	F7153	2
Push Rod Cover Set	1948-1952			Cork Rubber VS38219	1
Water Outlet Gasket	1948-1952			C25487	1
Water Pump Mount Gasket	1948-1952			K25845	1

26 239 CID (3.9L) Dodge V6 Cyl, 3.910in./99.3mm (1987-2003) **26**

Part	Year	VIN	Model/Application	Part Number	Qty.
ENGINE GASKETS					
Head Set	1997-2001		(Exhaust Pipe Gasket Not Included)	HS5941A	1
	1992-1996		(Exhaust Pipe Gasket Not Included)	HS5941	1
	1991			HS5741Y	1
	1990			HS5741X	1
	1987-1989			HS5741	1
Lower Set	1992-2001		(Requires Head Set To Make Full Set)	CS5941	1
	1991		(Requires Head Set To Make Full Set)	CS5741Y	1
Full Set	1990			FS5741X	1
	1987-1989			FS5741	1
Engine Kit Gasket Set	1992-2001			95-3469VR	1
	1987-1990			95-3288VR	1
Cylinder Head Gasket	1992-2003		Nitroseal	5941	2
	1987-1991		Nitroseal	5741	2
Cyl. Head Bolt Set	1994-2003			GS33374	2
Valve Cover Set	1992-2003		Victo-Tech	VS50171	1
			Cork Rubber	VS50030	1
			Tuff-Cork	VS50030TC	1
Valve Stem Seal, Exh.	1992-2003			B45799	6
			Fluoroelastomer	B45676	6
				B45327	6
Valve Stem Seal, Int.	1992-2003			B45798	6
			Fluoroelastomer	B45675	6
				B45583	6
Manifold Set, Exhaust	1992-2001			MS12453	1
	1987-1991			MS15418	1
Manifold Set, Intake	1997-2002		(Contains Steel Carrier End Seal)	MS16291	1
	1992-1996			MS16090	1
	1991			MS15416X	1
	1987-1990			MS15416	1
Oil Pan Set	1992-2003		Victo-Tech	OS32119	1
			Tuff-Cork	OS32037TC	1
Rear Main Seal Set	1992-2003			JV1607	1
			Rope Packing	JV556	1
				JV606	1
Timing Cover Set	1994-1998			JV1158	1
	1992-1993			JV1157	1
	1987-1991			JV806	1
			(Contains Repair Sleeve)	JV934	1
Timing Cover Gasket	1998			T27787	1
	1987-1996			T27787	1
Timing Cover Seal	1987-1991			64573	1

LIGHT TRUCK

Dodge Truck

26 (cont.)	239 CID (3.9L) Dodge V6 Cyl, 3.910in./99.3mm (1987-2003)				26 (cont.)
----------------------	---	--	--	--	----------------------

Part	Year	VIN	Model/Application	Part Number	Qty.
ENGINE GASKETS (cont.)					
Harmonic Balancer Repair Sleeve	1987-1990		<i>Ground Steel, .020" Thickness</i>	66592RS	1
			Use With Part Number A501 <i>Nickel Plated Formed Steel, .013" Thickness</i>	A224-1	1

MISCELLANEOUS GASKETS						
Air Cleaner Mount Gasket	1990-2001			G31043	1	
	1988-1989			G27098	1	
	1987			G25936	1	
Air Pump Gasket	1987-1993		Air Injection Tube	B45559	1	
Carb. Mount Gasket	1987		(Insulator), Intake To Manifold Spacer	G14140	1	
			Carburetor To Spacer	G31047	1	
Distributor Seal	1987-2003		Shaft	72133	1	
E.G.R. Gasket	1987-1996			G24079	1	
Fuel Pump Gasket	1988-1990			D31042	1	
	1987			D27094	1	
			<i>Tuff-Cork</i>	D27094TC	1	
Injector Nozzle O-Ring	1992-1996			GS33276	3	
Oil Filler Pipe Gasket	1988-1993			B45574	1	
Oil Filter Adapt Gasket	1991-2003			B31605	1	
	1987-1990			B31604	1	
Throttle Body Gasket	1992-2003		Throttle Body To Intake Manifold	G31527	1	
	1988-1991		Throttle Body To Intake Manifold	G30830	1	
Water Outlet Gasket	1997-2001			C24672	1	
	1994-1996		Dakota, Maximum Cooling	C24109	1	
				Ram Van 2500, Ram Wagon 2500	C24672	1
				Dakota, Ram 1500, Ram Van 1500, Ram Wagon 1500, Except Maximum Cooling	C24672	1
	1992-1993		Dakota	C24109	1	
				Ram D150, Ram D250, Ram D350, Ram Van B150, Ram Van B250, Ram W150, Ram Wagon B150, Ram Wagon B250	C24672	1
1990-1991			C24109	1		
1987-1989			C24672	1		
Water Pump Mount Gasket	1992-2002			K31140	1	
	1987-1991			K27556	1	

27	251 CID (4.1L) L-Head Dodge 6 Cyl, 3.438in./87.33mm (1961-1968)				27
-----------	--	--	--	--	-----------

Part	Year	VIN	Model/Application	Part Number	Qty.
ENGINE GASKETS					
Head Set	1961-1968			HS3029	1
Full Set	1961-1968		(Timing Cover And Rear Main Seal Sets Not Included)	FS3029X	1
Cylinder Head Gasket	1961-1968			3029	1
Manifold Set, Int. & Exh.	1961-1968			MS15029	1
Oil Pan Set	1961-1968		<i>Cork Rubber</i>	OS30899	1
Rear Main Seal Set	1961-1968			JV134-9	1
Timing Cover Set	1961-1968			JV826	1

MISCELLANEOUS GASKETS					
Air Cleaner Mount Gasket	1961-1962			G26540	1
Exhaust Pipe Gasket	1961-1968		(Flange Type)	F7153	2
Push Rod Cover Set	1961-1968		<i>Cork Rubber</i>	VS38219	1
Timing Cover Dust Seal	1961-1962			42379	1
Water Outlet Gasket	1961-1968			C25487	1

LIGHT TRUCK

28 265 CID (4.3L) L-Head Dodge 6 Cyl, 3.438in./87.33mm (1953-1960) 28

Part	Year	VIN	Model/Application	Part Number	Qty.
ENGINE GASKETS					
Head Set	1953-1960			HS4922	1
Full Set	1953-1960		(Rear Main Seal Not Included, Timing Cover Set Not Included)	FS4922	1
Cylinder Head Gasket	1953-1960		VR2000	4922	1
Manifold Set, Int. & Exh.	1953-1960			MS15029	1
Oil Pan Set	1953-1960		Cork Rubber	OS30899	1
Rear Main Seal Set	1953-1960			JV134-9	1
Timing Cover Set	1954-1960			JV826	1
	1953			JV757	1

MISCELLANEOUS GASKETS

Air Cleaner Mount Gasket	1953-1960		1 Barrel Carburetor	G26540	1
Carb. Mount Gasket	1953-1954		1 Barrel Carburetor	G5349AD	1
Exhaust Pipe Gasket	1953-1960		(Flange Type)	F7153	2
Push Rod Cover Set	1953-1960		Cork Rubber	VS38219	1
Water Outlet Gasket	1953-1960			C25487	1
Water Pump Gasket	1953-1960			K25845	1

29 270 CID (4.4L) OHV Dodge V8 Cyl, 3.625in./92.1mm (1955-1956) 29

Part	Year	VIN	Model/Application	Part Number	Qty.
ENGINE GASKETS					
Valve Cover Set	1956		Cork Rubber	VS38264	1
Valve Stem Seal, Int.	1956			B45298	8
Oil Pan Set	1956		Cork Rubber	OS30513	1
Rear Main Seal Set	1956			JV606	1

MISCELLANEOUS GASKETS

Air Cleaner Mount Gasket	1955-1956		2 Barrel Carburetor	G25936	1
Carb. Mount Gasket	1955-1956		4 Bolt Holes, 2 Barrel Carburetor	G12220	1
Dist. Mounting Gasket	1955-1956			B17926	1
Exhaust Pipe Gasket	1956		(Flange Type)	F5438AK	1
Fuel Pump Gasket	1956			D27094	1
Timing Cover Dust Seal	1955-1956			42379	1
Water Outlet Gasket	1956			C25487	1

30 273 CID (4.5L) OHV Chrysler V8 Cyl, 3.625in./92.1mm (1964-1968) 30

Part	Year	VIN	Model/Application	Part Number	Qty.
ENGINE GASKETS					
Head Set	1966-1967			HS3536A	1
Lower Set	1964-1967			CS3536B	1
Full Set	1966-1967			FS3536A	1
Engine Kit Gasket Set	1964-1968		(Intake Manifold Gasket Not Included), Use With Part Number MS15125	95-3338VR	1
Cylinder Head Gasket	1964-1967		Nitroseal	3536SG	2
			VR2000	3536VC	2
Valve Cover Set	1964-1967		Cork Rubber	VS39569	1
			High Temperature Cork Rubber	VS39569H	1
			Victo-Tech	VS39569R	1
			Tuff-Cork	VS39569TC	1
Manifold Set, Exhaust	1964-1967			MS15136	1
Manifold Set, Intake	1966-1967			MS15148	1
	1964-1965			MS15125	1
Oil Pan Set	1964-1967		Cork Rubber	OS30520X	1
Rear Main Seal Set	1964-1967			JV606	1

Dodge Truck

30 (cont.)	273 CID (4.5L) OHV Chrysler V8 Cyl, 3.625in./92.1mm (1964-1968)				30 (cont.)
----------------------	--	--	--	--	----------------------

Part	Year	VIN	Model/Application	Part Number	Qty.
------	------	-----	-------------------	-------------	------

ENGINE GASKETS (cont.)

Timing Cover Set	1964-1967			JV806X	1
Harmonic Balancer Repair Sleeve	1964-1967		Use With Part Number A501 <i>Nickel Plated Formed Steel, .013" Thickness</i>	A224-1	1

MISCELLANEOUS GASKETS

Carb. Mount Gasket	1964-1967		2 Barrel Carburetor	G12220	1
Dist. Mounting Gasket	1964-1967			B17926	1
Fuel Pump Gasket	1964-1967			D27094	1
				<i>Tuff-Cork</i> D27094TC	1
Water Outlet Gasket	1964-1967			C25487	1
Water Pump Mount Gasket	1964-1967			K26444	2
			Pump To Head	K26494	2

31	287 CID (4.7L) SOHC Chrysler V8 Cyl, 3.661in./93mm (2000-2003)				31
-----------	---	--	--	--	-----------

Part	Year	VIN	Model/Application	Part Number	Qty.
------	------	-----	-------------------	-------------	------

ENGINE GASKETS

Head Set	2000-2002			HS54237	1
Lower Set	2000-2002		(Requires Head Set To Make Full Set)	CS54237	1
Cylinder Head Gasket	2000-2003		<i>Multi-Layered Steel</i>	54237	2
Cyl. Head Bolt Set	2000-2003			GS33368	2
Valve Cover Set	2000-2003			VS50308	1
Valve Stem Seal, Exh.	2000-2003			B45909	8
Valve Stem Seal, Int.	2000-2003			B45909	8
Manifold Set, Exhaust	2000-2002			MS16336	1
Manifold Set, Intake	2000-2002			MS16323	1
Oil Pan Set	2000-2002			OS32233	1
Rear Main Seal	2000-2003			67632	1
Timing Cover Gasket	2003		Engines With Chamfered Timing Cover Surface	T31616	1
	2000-2002			T31616	1
Timing Cover Seal	2000-2003			67629	1

MISCELLANEOUS GASKETS

Throttle Body Gasket	2000-2003			G31597	1
Water Pump Mount Gasket	2000-2003			K31598	1

32	315 CID (5.2L) Dodge V8 Cyl, 3.625in./92.1mm (1957-1958)				32
-----------	---	--	--	--	-----------

Part	Year	VIN	Model/Application	Part Number	Qty.
------	------	-----	-------------------	-------------	------

ENGINE GASKETS

Valve Cover Set	1957-1958		<i>Cork Rubber</i>	VS38264	1
Valve Stem Seal, Exh.	1957-1958			B45298	8
Valve Stem Seal, Int.	1957-1958			B45298	8
Oil Pan Set	1957-1958		<i>Cork Rubber</i>	OS30513	1
Rear Main Seal Set	1957-1958			JV606	1
Timing Cover Seal	1957-1958			64573	1

MISCELLANEOUS GASKETS

Air Cleaner Mount Gasket	1957-1958		2 Barrel Carburetor	G25936	1
Carb. Mount Gasket	1957-1958		4 Bolt Holes, 2 Barrel Carburetor	G12220	1
Dist. Mounting Gasket	1957-1958			B17926	1
Exhaust Pipe Gasket	1957-1958		(Flange Type)	F5438AK	2
Fuel Pump Gasket	1957-1958			D27094	1
				<i>Tuff-Cork</i> D27094TC	1
Water Outlet Gasket	1957-1958			C25487	1

LIGHT TRUCK

33 315 CID (5.2L) Hemispherical Dodge V8 Cyl, 3.625in./92.1mm (1957-1958) 33

Part	Year	VIN	Model/Application	Part Number	Qty.
ENGINE GASKETS					
Valve Cover Set	1957-1958			<i>Cork Rubber</i> VS38264	1
Valve Stem Seal, Exh.	1957-1958			B45298	8
Valve Stem Seal, Int.	1957-1958			B45298	8
Oil Pan Set	1957-1958			<i>Cork Rubber</i> OS30513	1
Rear Main Seal Set	1957-1958			JV606	1
Timing Cover Seal	1957-1958			64573	1

MISCELLANEOUS GASKETS					
Air Cleaner Mount Gasket	1957-1958		2 Barrel Carburetor	G25936	1
Carb. Mount Gasket	1957-1958		(4 Bolt Holes), 2 Barrel Carburetor	G12220	1
Dist. Mounting Gasket	1957-1958			B17926	1
Exhaust Pipe Gasket	1957-1958		(Flange Type)	F5438AK	2
Fuel Pump Gasket	1957-1958			D27094	1
				<i>Tuff-Cork</i> D27094TC	1
Water Outlet Gasket	1957-1958			C25487	1

34 318 CID (5.2L) Chrysler V8 Cyl, 3.910in./99.3mm (1959-2003) 34

Part	Year	VIN	Model/Application	Part Number	Qty.	
ENGINE GASKETS						
Head Set	1997-2001			HS5940A	1	
	1992-1996			HS5940	1	
	1991			HS3536F	1	
	1990			HS3536X	1	
	1988-1989			HS3536W	1	
	1975-1987			2 Barrel Carburetor	HS3536	1
				4 Barrel Carburetor And Electronic Fuel Injection	HS3536B	1
	1975-1977			4 Barrel Carburetor	HS3536B	1
	1967-1977			5 Bolt Valve Cover, 2 Barrel Carburetor	HS3536A	1
				4 Barrel Carburetor, 5 Bolt Valve Cover	HS3536C	1
1967-1974			2 Barrel Carburetor, 5 Bolt Valve Cover	HS3536A	1	
1959-1967			3 Stud Valve Cover	HS1134TC	1	
Lower Set	1992-2001		(Requires Head Set To Make Full Set)	CS5928	1	
	1991		(Requires Head Set To Make Full Set)	CS3536	1	
	1967-1991		(Requires Head Set To Make Full Set)	CS3536B	1	
Full Set	1990			FS3536X	1	
	1988-1989			FS3536W	1	
	1988		(Performer, Contains Nitroseal Head Gasket)	FS3536SG	1	
	1975-1987			2 Barrel Carburetor	FS3536	1
				4 Barrel Carburetor And Electronic Fuel Injection	FS3536B	1
	1967-1977			5 Bolt Valve Cover, 2 Barrel Carburetor	FS3536A	1
				4 Barrel Carburetor, 5 Bolt Valve Cover	FS3536C	1
1959-1968			3 Stud Valve Cover	FS1134TC	1	
Engine Kit Gasket Set	1992-2001			95-3478VR	1	
	1988-1991		Throttle Body Injection, (Valve Stem Seals Not Included), Use With Part Numbers B45675 (8), B45676 (8)	95-3346VR	1	
	1982-1987			2 Barrel Carburetor	95-3346VR	1
				4 Barrel Carburetor	95-3346VR	1
	1981			4 Barrel Carburetor, (Intake Manifold Gasket Not Included), Use With Part Number MS15176W	95-3338VR	1
				4 Barrel Carburetor, (Intake Manifold Gasket Not Included)	95-3338VR	1
	1978-1981			4 Barrel Carburetor, (Intake Manifold Gasket Not Included), Use With Part Number MS15176W	95-3338VR	1
	1975-1981			2 Barrel Carburetor	95-3338VR	1
	1975-1980			2 Barrel Carburetor, 5 Bolt Valve Cover	95-3338VR	1
	1967-1974			5 Bolt Valve Cover	95-3338VR	1
1959-1967			2 Bolt Valve Cover	95-3012VR	1	
Cylinder Head Gasket	1992-2001			<i>Nitroseal</i> 5940	2	

LIGHT TRUCK

Dodge Truck

34 318 CID (5.2L) Chrysler V8 Cyl, 3.910in./99.3mm (1959-2003)

(cont.)

34

(cont.)

Part Year VIN Model/Application Part Number Qty.

ENGINE GASKETS (cont.)

Cylinder Head Gasket (cont.)	1968-1991		<i>Nitroseal</i>	3536SG	2
				<i>VR2000</i>	3536VC
	1967	5 Bolt Valve Cover	<i>Nitroseal</i>	3536SG	2
		5 Bolt Valve Cover	<i>VR2000</i>	3536VC	2
1959-1967	3 Stud Valve Cover	<i>VR2000</i>	1134TC	2	
Cyl. Head Bolt Set	1994-2003			GS33375	2
	1967-1991			GS33344	2
Valve Cover Set	1992-2003		<i>Victo-Tech</i>	VS50170	1
	1967-1991	5 Bolt Valve Cover	<i>Cork Rubber</i>	VS39569	1
		5 Bolt Valve Cover	<i>High Temperature Cork Rubber</i>	VS39569H	1
		5 Bolt Valve Cover	<i>Victo-Tech</i>	VS39569R	1
		5 Bolt Valve Cover	<i>Tuff-Cork</i>	VS39569TC	1
1959-1967	3 Stud Valve Cover	<i>Cork Rubber</i>	VS38282	1	
Valve Stem Seal, Exh.	1992-2003		<i>Fluoroelastomer</i>	B45799A	8
	1990-1991		<i>Fluoroelastomer</i>	B45676	8
	1979-1989	(Premium)	<i>Fluoroelastomer</i>	B45624	8
	1967-1989	(Shedder Type)		B45298	8
Valve Stem Seal, Int.	1992-2003		<i>Fluoroelastomer</i>	B45798A	8
	1990-1991		<i>Fluoroelastomer</i>	B45675	8
	1979-1989	(Premium)	<i>Fluoroelastomer</i>	B45623	8
	1967-1989		<i>Nitrile</i>	B45403	8
	1967-1978	(Shedder Type)		B45298	8
Manifold Set, Exhaust	1992-2002			MS16209	1
	1975-1991			MS12268	1
	1967-1977	5 Bolt Valve Cover		MS15136	1
	1966-1967	3 Stud Valve Cover		MS15059	1
	1959-1965			MS15058	1
Manifold Set, Intake	1997-2002	(Contains Steel Carrier End Seal)		MS16292	1
	1992-1996			MS16089	1
	1991			MS15148Y	1
	1988-1990			MS15148X	1
	1969-1987	2 Barrel Carburetor		MS15148	1
	1967-1987	4 Barrel Carburetor And Electronic Fuel Injection, 5 Bolt Valve Cover		MS15176W	1
	1969	2 Barrel Carburetor		MS15148W	1
	1967-1968	5 Bolt Valve Cover, 2 Barrel Carburetor		MS15148	1
	1959-1967	3 Stud Valve Cover		MS15063	1
Oil Pan Set	1992-2003		<i>Victo-Tech</i>	OS32114	1
	1969-1991		<i>Cork Rubber</i>	OS30520Y	1
				<i>Tuff-Cork</i>	OS30520YTC
1959-1969	2 Barrel Carburetor	<i>Cork Rubber</i>	OS30520X	1	
Rear Main Seal Set	1992-2003			JV1607	1
	1959-1991			JV606	1
Timing Cover Set	1992-2001			JV1158	1
	1970-1991			JV806	1
		(Contains Repair Sleeve)			JV934
	1959-1969			JV806X	1
Timing Cover Gasket	1959-1991			T27787	1
Timing Cover Seal	1959-1991			64573	1
Harmonic Balancer Repair Sleeve	1959-1991		<i>Ground Steel, .020" Thickness</i>	66592RS	1
		Use With Part Number A501 <i>Nickel Plated Formed Steel, .013" Thickness</i>		A224-1	1

MISCELLANEOUS GASKETS

Air Cleaner Mount Gasket	1989-2001			G31043	1
--------------------------	-----------	--	--	---------------	---

LIGHT TRUCK

Part	Year	VIN	Model/Application	Part Number	Qty.
MISCELLANEOUS GASKETS (cont.)					
Air Cleaner Mount Gasket (cont.)	1988			G27098	1
	1959-1987		2 Barrel Carburetor	G25936	1
	1981-1983		4 Barrel Carburetor	G27098	1
			4 Barrel Carburetor	G27098	1
			4 Barrel Carburetor, 4 Barrel Carburetor	G27098	1
	1980-1983		4 Barrel Carburetor	G27098	1
	1981-1982		4 Barrel Carburetor, 4 Barrel Carburetor	G27098	1
1967-1982		4 Barrel Carburetor	G27098	1	
Air Pump Gasket	1975-1993		Air Injection Tube	B45559	1
Carb. Mount Gasket	1982-1987		2 Barrel Carburetor	G14140	1
	1978-1983		Small Hole, 2 Barrel Carburetor	G14140	1
			4 Barrel Carburetor	G14589	1
	1982		2 Barrel Carburetor	G14140	1
	1978-1981		Large Hole, 2 Barrel Carburetor	G14141	1
	1972-1977		2 Barrel Carburetor	G14140	1
	1970-1971		Governor 5 Holes, 2 Barrel Carburetor	G14140	1
1969		2 Barrel Carburetor	G12220	1	
Dist. Mounting Gasket	1959-1979			B17926	1
Distributor Seal	1966-2003		(O-Ring Type), Shaft	72133	1
E.G.R. Gasket	1988-1997			G24079	1
	1973-1987			G24080	1
Exhaust Pipe Gasket	1969-1977		(Flange Type), 2 Barrel Carburetor	F5495C	2
	1959-1969		(Flange Type), 2 Barrel Carburetor	F5438AK	1
Fuel Pump Gasket	1988-1990			D31042	1
	1981-1987		<i>Performaseal</i>	D27094VC	1
	1959-1987			D27094	1
				<i>Tuff-Cork</i>	D27094TC
Injector Nozzle O-Ring	1992-1998			GS33276	4
Oil Filler Pipe Gasket	1984-1985			B45574	1
Oil Filter Adapt Gasket	1991-2003			B31605	1
	1967-1990			B31604	1
Oil Pump Cover Gasket	1963-1985			B45558	1
Throttle Body Gasket	1992-2003		Throttle Body To Intake Manifold	G31527	1
	1988-1991		Throttle Body To Intake Manifold	G30830	1
Timing Cover Dust Seal	1959-1991			42379	1
Water Outlet Gasket	1994-2001			C24672	1
	1994-1996		Dakota, Maximum Cooling	C24109	1
			Ram 1500, Ram 2500, Ram Wagon 2500	C24672	1
			Dakota, Except Maximum Cooling	C24672	1
	1992-1993		Dakota	C24109	1
			Ram D150, Ram D250, Ram D350, Ram Van B150, Ram Van B250, Ram Van B350, Ram W150, Ram W250, Ram W350, Ram Wagon B150, Ram Wagon B250, Ram Wagon B350, Ramcharger AD150, Ramcharger AW150	C24672	1
	1990-1991			C24109	1
	1979-1989			C24672	1
	1975-1978			C26690	1
	1959-1977			C25487	1
Water Pump Mount Gasket	1992-2001			K31140	1
	1990-1991		Ram D150, Ram D250, Ram D350, Ram Van B150, Ram Van B250, Ram Van B350, Ram W150, Ram W250, Ram W350, Ram Wagon B150, Ram Wagon B250, Ram Wagon B350, Ramcharger AD150, Ramcharger AW150	K27556	1
			Dakota	K31140	1
	1969-1989			K27556	1

Dodge Truck

34	318 CID (5.2L) Chrysler V8 Cyl, 3.910in./99.3mm (1959-2003)	34
(cont.)		(cont.)

Part	Year	VIN	Model/Application	Part Number	Qty.
MISCELLANEOUS GASKETS (cont.)					
Water Pump Mount Gasket (cont.)	1967-1968		Except 3 Stud Valve Cover	K31140	1
	1959-1968		3 Stud Valve Cover	K26444	2

35	318 CID (5.2L) Chrysler CNG V8 Cyl, 3.910in./99.3mm (1992-2003)	35
-----------	--	-----------

Part	Year	VIN	Model/Application	Part Number	Qty.
ENGINE GASKETS					
Head Set	1997-2001			HS5940A	1
	1992-1996			HS5940	1
Lower Set	1992-2001		(Requires Head Set To Make Full Set)	CS5928	1
Cylinder Head Gasket	1992-1998		<i>Nitroseal</i>	5940	2
Cyl. Head Bolt Set	1994-2003			GS33375	2
Valve Cover Set	1992-2003		<i>Victo-Tech</i>	VS50170	1
Valve Stem Seal, Exh.	1992-2003		<i>Fluoroelastomer</i>	B45799A	8
Valve Stem Seal, Int.	1992-2003		<i>Fluoroelastomer</i>	B45798A	8
Manifold Set, Exhaust	1992-2002			MS16209	1
Manifold Set, Intake	1997-2002		(Contains Steel Carrier End Seal)	MS16292	1
	1992-1996			MS16089	1
Oil Pan Set	1992-2003		<i>Victo-Tech</i>	OS32114	1
Rear Main Seal Set	1992-2003			JV1607	1
Timing Cover Set	1992-2001			JV1158	1

MISCELLANEOUS GASKETS

Distributor Seal	1992-2003		(O-Ring Type), Shaft	72133	1
E.G.R. Gasket	1994-1996			G24079	1
Injector Nozzle O-Ring	1992-1998			GS33276	4
Oil Filter Adapt Gasket	1992-2003			B31605	1
Throttle Body Gasket	1992-2003		Throttle Body To Intake Manifold	G31527	1
Water Outlet Gasket	1992-2001			C24672	1
Water Pump Mount Gasket	1992-2001			K31140	1

36	354 CID (5.8L) 6-354 Perkins Diesel 6 Cyl, 3.877in./98.5mm (1966-1970)	36
-----------	---	-----------

Part	Year	VIN	Model/Application	Part Number	Qty.
ENGINE GASKETS					
Head Set	1966-1970		1/2" Studs	HS85182	1
Lower Set	1966-1970		(Requires Head Set To Make Full Set)	CS85182	1
Cylinder Head Gasket	1966-1970		1/2" Studs <i>VR2000</i>	3837	1
Valve Cover Set	1966-1970			VS86125	1
Oil Pan Set	1966-1970		<i>Cork Rubber</i>	OS87083	1
Rear Main Seal	1966-1970			JV1641	1
Timing Cover Set	1966-1970			JV1214	1

37	359 CID (5.9L) ETA Cummins Diesel 6 Cyl, 4.016in./102mm (1989-1993)	37
-----------	--	-----------

Part	Year	VIN	Model/Application	Part Number	Qty.
ENGINE GASKETS					
Head Set	1989-1993		Except Intercooled Engine, (Contains Standard Thickness Head Gasket), Turbocharged	HS4068	1
Lower Set	1989-1993		Except Intercooled Engine, (Requires Head Set To Make Full Set), Turbocharged	CS4068	1
Engine Kit Gasket Set	1989-1993		Except Intercooled Engine, (Contains Standard Thickness Head Gasket)	95-3466VR	1
Cylinder Head Gasket	1989-1993		Except Intercooled Engine, (Standard Thickness), Turbocharged	4068	1
			Except Intercooled Engine <i>.25mm Oversize Thickness</i>	4068A	1
			Except Intercooled Engine <i>.50 mm Oversize Thickness</i>	4068B	1

37 359 CID (5.9L) ETA Cummins Diesel 6 Cyl, 4.016in./102mm (1989-1993) **37**
(cont.) (cont.)

Part Year VIN Model/Application Part Number Qty.

ENGINE GASKETS (cont.)

Cyl. Head Bolt Set	1990-1993			GS33349	1
Valve Cover Set	1989-1993		(Single Valve Cover), Turbocharged <i>Victo-Tech</i>	VS50215S	6
Valve Stem Seal, Exh.	1989-1993		Except Intercooled Engine, (Positive Type), Turbocharged	B45411A	6
Valve Stem Seal, Int.	1989-1993		Except Intercooled Engine, (Positive Type), Turbocharged	B45411A	6
Manifold Set, Exhaust	1989-1993		Except Intercooled Engine, Turbocharged	MS10141	1
Manifold Set, Intake	1989-1993		Except Intercooled Engine, Turbocharged	MS12435	1
Oil Pan Set	1989-1993		Except Intercooled Engine, Turbocharged	OS32139	1
Rear Main Seal Set	1989-1993		Except Intercooled Engine, Turbocharged	JV1622	1
Timing Cover Set	1989-1993		Except Intercooled Engine, Turbocharged	JV1186	1
Timing Cover Seal	1989-1993		Except Intercooled Engine, Turbocharged	48383	1

MISCELLANEOUS GASKETS

Exhaust Pipe Gasket	1989-1993		Except Intercooled Engine, Turbocharged <i>Steel</i>	F10142	1
Push Rod Cover Set	1989-1993		Except Intercooled Engine, Turbocharged <i>Cork Rubber</i>	PS38801	1
Thermostat Seal	1989-1993		Except Intercooled Engine, Turbocharged <i>Victo-Tech</i>	C31421	1
Water Pump Mount Gasket	1989-1993		Except Intercooled Engine, Turbocharged <i>Rubber</i>	K31420	1

38 359 CID (5.9L) ETB Cummins Diesel 6 Cyl, 4.016in./102mm (1990-1998) **38**

Part Year VIN Model/Application Part Number Qty.

ENGINE GASKETS

Head Set	1990-1998		(Contains .010" Thicker Head Gasket)	HS4068A	1
			(Contains .020" Thicker Head Gasket)	HS4068B	1
Valve Cover Set	1990-1998		(Single Valve Cover) <i>Victo-Tech</i>	VS50215S	6
Valve Stem Seal, Exh.	1990-1998			B45411A	6
Valve Stem Seal, Int.	1990-1998			B45411A	6
Manifold Set, Exhaust	1990-1996			MS10141	1
Manifold Set, Intake	1990-1998			MS12435	1
Oil Pan Gasket	1990-1997			OS32139	1
Rear Main Seal Set	1990-1998			JV1622	1
Timing Cover Seal	1990-1998			48383	1

MISCELLANEOUS GASKETS

Push Rod Cover Set	1990-1998			PS38801	1
Water Pump Gasket	1997-1998			K31420	1

39 359 CID (5.9L) ETC 24 Valves Cummins Diesel 6 Cyl, 4.016in./102mm (1998-2003) **39**

Part Year VIN Model/Application Part Number Qty.

ENGINE GASKETS

Rear Main Seal Set	1998-1999			JV1622	1
--------------------	-----------	--	--	--------	---

MISCELLANEOUS GASKETS

Water Pump Gasket	1998-2003			K31420	1
-------------------	-----------	--	--	--------	---

40 359 CID (5.9L) ETH 24 Valves Cummins Diesel 6 Cyl, 4.016in./102mm (2001-2002) **40**

Part Year VIN Model/Application Part Number Qty.

MISCELLANEOUS GASKETS

Water Pump Gasket	2001-2002			K31420	1
-------------------	-----------	--	--	--------	---

41 360 CID (5.9L) Chrysler V8 Cyl, 4.000in./101.6mm (1971-2003) **41**

Part Year VIN Model/Application Part Number Qty.

ENGINE GASKETS

Head Set	1997-2001			HS5940A	1
	1993-1996			HS5940	1
	1991-1992			HS3536G	1

Dodge Truck

41 360 CID (5.9L) Chrysler V8 Cyl, 4.000in./101.6mm (1971-2003)

(cont.)

41

(cont.)

Part	Year	VIN	Model/Application	Part Number	Qty.	
ENGINE GASKETS (cont.)						
Head Set (cont.)	1989-1990			HS3536E	1	
	1971-1988			HS3536D	1	
Lower Set	1992-2001		(Requires Head Set To Make Full Set)	CS5940	1	
	1991		(Requires Head Set To Make Full Set)	CS3536A	1	
Full Set	1989-1990			FS3536E	1	
	1971-1988			FS3536D	1	
Engine Kit Gasket Set	1993-2001			95-3481VR	1	
	1990		(Valve Stem Seals Not Included, Intake Manifold Gasket Not Included), Use With Part Numbers MS15641, B45675 (8), B45676 (8)	95-3345VR	1	
	1989		(Requires Intake Manifold Gasket), Use With Part Number MS15641	95-3345VR	1	
	1982-1988			95-3345VR	1	
	1971-1981			95-3343VR	1	
Cylinder Head Gasket	1993-2002		Nitroseal	5940	2	
	1971-1992		Nitroseal	3536SG	2	
				VR2000	3536VC	2
Cyl. Head Bolt Set	1994-2003			GS33375	2	
	1971-1992			GS33344	2	
Valve Cover Set	1993-2003		Victo-Tech	VS50170	1	
	1971-1992		Cork Rubber	VS39569	1	
				High Temperature Cork Rubber	VS39569H	1
				Victo-Tech	VS39569R	1
				Tuff-Cork	VS39569TC	1
Valve Stem Seal, Exh.	1993-2003		Fluoroelastomer	B45799A	8	
	1990-1992		Fluoroelastomer	B45676	8	
	1977-1989		(Premium, Shedder Type)	Fluoroelastomer	B45624	8
	1971-1989		(Shedder Type)	Fluoroelastomer	B45298	8
Valve Stem Seal, Int.	1993-2003		Fluoroelastomer	B45798A	8	
	1990-1992		Fluoroelastomer	B45675	8	
	1977-1989		(Premium, Positive Type)	Fluoroelastomer	B45623	8
	1971-1989			Nitrile	B45403	8
	1971-1977		(Shedder Type)		B45298	8
Manifold Set, Exhaust	1993-2002			MS16209	1	
	1971-1992			MS12268	1	
Manifold Set, Intake	1997-2002		(Contains Steel Carrier End Seal)	MS16292	1	
	1993-1996			MS16089	1	
	1991-1992			MS15641X	1	
	1989-1990			MS15641	1	
	1978-1988		2 Barrel Carburetor	MS15148	1	
	1971-1988		4 Barrel Carburetor	MS15176W	1	
Oil Pan Set	1992-2003		Victo-Tech	OS32115	1	
	1971-1991		Cork Rubber	OS30520Z	1	
				Tuff-Cork	OS30520ZTC	1
Rear Main Seal Set	1991-2001			JV1610	1	
	1971-1990			JV605	1	
Timing Cover Set	1992-2001			JV1158	1	
	1971-1991			JV806	1	
				(Contains Repair Sleeve)	JV934	1
Timing Cover Gasket	1971-1991			T27787	1	
Timing Cover Seal	1971-1991			64573	1	
Harmonic Balancer Repair Sleeve	1971-1990		Ground Steel, .020" Thickness	66592RS	1	
			Use With Part Number A501 Nickel Plated Formed Steel, .013" Thickness	A224-1	1	

LIGHT TRUCK

41 360 CID (5.9L) Chrysler V8 Cyl, 4.000in./101.6mm (1971-2003) **41**
(cont.) (cont.)

Part	Year	VIN	Model/Application	Part Number	Qty.
MISCELLANEOUS GASKETS					
Air Cleaner Mount Gasket	1994-2001	Z		G31043	1
	1989-1993			G31043	1
	1984-1988			G27098	1
	1978-1983		2 Barrel Carburetor	G26410	1
	1971-1977		2 Barrel Carburetor	G25936	1
			Light Duty, 2 Barrel Carburetor	G26410	1
Air Pump Gasket	1975-1993		Air Injection Tube	B45559	1
Carb. Mount Gasket	1985-1988		4 Barrel Carburetor	G30715	1
	1975-1984		4 Barrel Carburetor	G14589	1
	1971-1983		2 Barrel Carburetor	G14141	1
Dist. Mounting Gasket	1971-1978			B17926	1
Distributor Seal	1971-2003		(O-Ring Type), Shaft	72133	1
E.G.R. Gasket	1989-1996			G24079	1
	1974-1988			G24080	1
Fuel Pump Gasket	1988-1990			D31042	1
	1971-1987			D27094	1
				Tuff-Cork	D27094TC
Injector Nozzle O-Ring	1994-1998			GS33276	4
Oil Filler Pipe Gasket	1984-1985			B45574	1
Oil Filter Adapt Gasket	1991-2003			B31605	1
	1971-1990			B31604	1
Oil Pump Cover Gasket	1971-1985			B45558	1
Throttle Body Gasket	1992-2003		Throttle Body To Intake Manifold	G31527	1
	1989-1991		Throttle Body To Intake Manifold	G31046	1
Water Outlet Gasket	1992-2001			C24672	1
	1990-1991			C24109	1
	1979-1989			C24672	1
	1975-1978			C26690	1
	1971-1977			C25487	1
Water Pump Mount Gasket	1993-2001			K31140	1
	1971-1992			K27556	1

42 360 CID (5.9L) Chrysler LPG V8 Cyl, 4.000in./101.6mm (1971-1993) **42**

Part	Year	VIN	Model/Application	Part Number	Qty.
------	------	-----	-------------------	-------------	------

ENGINE GASKETS

Cyl. Head Bolt Set	1971-1992			GS33344	2
--------------------	-----------	--	--	---------	---

MISCELLANEOUS GASKETS

Distributor Seal	1971-1993		(O-Ring Type), Shaft	72133	1
Oil Filter Adapt Gasket	1991-1993			B31605	1
	1971-1990			B31604	1

43 361 CID (5.9L) 361-1 Chrysler V8 Cyl, 4.125in./104.8mm (1966-1967) **43**

Part	Year	VIN	Model/Application	Part Number	Qty.
------	------	-----	-------------------	-------------	------

ENGINE GASKETS

Head Set	1966-1967		(Intake Manifold Gasket Not Included)	HS3464VC	1
Full Set	1966-1967		(Intake Manifold Gasket Not Included)	FS3464VC	1
Engine Kit Gasket Set	1966-1967		(Intake Manifold Gasket Not Included), Use With Part Number MS15914	95-3344VR	1
Cylinder Head Gasket	1966-1967		Nitroseal	3464SG	2
			VR2000	3464VC	2
Valve Cover Set	1966-1967		Cork Rubber	VS38322	1
			High Temperature Cork Rubber	VS38322H	1

Dodge Truck

43 (cont.)	361 CID (5.9L) 361-1 Chrysler V8 Cyl, 4.125in./104.8mm (1966-1967)				43 (cont.)
----------------------	---	--	--	--	----------------------

Part	Year	VIN	Model/Application	Part Number	Qty.
------	------	-----	-------------------	-------------	------

ENGINE GASKETS (cont.)

Manifold Set, Exhaust	1966-1967			MS15139	1	
Manifold Set, Intake	1966-1967			MS15914	1	
Oil Pan Set	1966-1967			<i>Cork Rubber</i>	OS31416	1
				<i>Tuff-Cork</i>	OS31416TC	1
Rear Main Seal Set	1966-1967			<i>Rope Packing</i>	JV551	1
					JV604	1
Timing Cover Set	1966-1967				JV834	1
				(Contains Repair Sleeve)	JV924	1
Harmonic Balancer Repair Sleeve	1966-1967			<i>Ground Steel, .020" Thickness</i>	66592RS	1
				Use With Part Number A501 <i>Nickel Plated Formed Steel, .013" Thickness</i>	A224	1

MISCELLANEOUS GASKETS

Exhaust Pipe Gasket	1966-1967		(Flange Type)	F5495C	2
Fuel Pump Gasket	1966-1967			D27094	1
				<i>Tuff-Cork</i>	D27094TC
Water Outlet Gasket	1966-1967			C25487	1
Water Pump Mount Gasket	1966-1967			K27080	1

44	361 CID (5.9L) OHV Chrysler V8 Cyl, 4.125in./104.8mm (1960-1977)				44
-----------	---	--	--	--	-----------

Part	Year	VIN	Model/Application	Part Number	Qty.
------	------	-----	-------------------	-------------	------

ENGINE GASKETS

Head Set	1971-1977		(Intake Manifold Gasket Not Included)	HS3475	1		
	1968-1973		Late, (Intake Manifold Gasket Not Included)	HS3475	1		
	1969-1971		(Intake Manifold Gasket Not Included)	HS3475	1		
	1961-1968		Early, (Intake Manifold Gasket Not Included)	HS3252E	1		
	1960-1967		(Intake Manifold Gasket Not Included)	HS3252E	1		
Full Set	1971-1977		(Intake Manifold Gasket Not Included)	FS3475	1		
	1968-1973		Late, (Intake Manifold Gasket Not Included)	FS3475	1		
	1969-1971		(Intake Manifold Gasket Not Included)	FS3475	1		
	1961-1968		Early, (Intake Manifold Gasket Not Included)	FS3252E	1		
	1960-1967		(Intake Manifold Gasket Not Included)	FS3252E	1		
Cylinder Head Gasket	1971-1977			<i>Beaded Steel</i>	3475	2	
	1968-1973		Late	<i>Beaded Steel</i>	3475	2	
	1969-1971			<i>Beaded Steel</i>	3475	2	
	1960-1968			Early	<i>Nitroseal</i>	3464SG	2
				Early	<i>VR2000</i>	3464VC	2
	1960-1967				<i>Nitroseal</i>	3464SG	2
				<i>VR2000</i>	3464VC	2	
Valve Cover Set	1963-1977		6 Bolt Valve Cover	<i>Cork Rubber</i>	VS38322	1	
			6 Bolt Valve Cover	<i>High Temperature Cork Rubber</i>	VS38322H	1	
	1960-1962		4 Bolt Valve Cover	<i>Cork Rubber</i>	VS38281	1	
Valve Stem Seal, Exh.	1960-1977		(Shedder Type)	B45343	8		
Valve Stem Seal, Int.	1960-1977		(Shedder Type)	B45343	8		
			(Positive Type)	<i>Nitrile</i>	B45403	8	
Manifold Set, Exhaust	1960-1977			MS15092	1		
Manifold Set, Intake	1960-1977			MS15915	1		
Oil Pan Set	1960-1977			<i>Cork Rubber</i>	OS31416	1	
				<i>Tuff-Cork</i>	OS31416TC	1	
Rear Main Seal Set	1961-1977		Except Early 1961	<i>Rope Packing</i>	JV551	1	
			Except Early 1961		JV604	1	
Timing Cover Set	1960-1977				JV834	1	
				(Contains Repair Sleeve)	JV924	1	
Timing Cover Gasket	1960-1977			T18750	1		
Timing Cover Seal	1960-1977			64573	1		

44 361 CID (5.9L) OHV Chrysler V8 Cyl, 4.125in./104.8mm (1960-1977) **44**
(cont.) (cont.)

Part Year VIN Model/Application Part Number Qty.

ENGINE GASKETS (cont.)

Harmonic Balancer Repair Sleeve	1960-1977		Ground Steel, .020" Thickness	66592RS	1
			Use With Part Number A501 Nickel Plated Formed Steel, .013" Thickness	A224	1

MISCELLANEOUS GASKETS

Air Cleaner Mount Gasket	1960-1977		500 To 600 Series	G25936	1
	1966-1971		700 To 1000 Series	G26410	1
Dist. Mounting Gasket	1960-1977			B17926	1
Exhaust Pipe Gasket	1960-1977		(Flange Type), Pipe To Manifold	F7153	2
Fuel Pump Gasket	1960-1977			D27094	1
			Tuff-Cork	D27094TC	1
Oil Pump Cover Gasket	1963-1977		(O-Ring Type)	B45558	1
Water Outlet Gasket	1960-1977			C25487	1
Water Pump Gasket	1960-1977		Pump To Block	K26444	2
			Pump To Head	K26494	2
			Pump To Plate	K27561	2

45 383 CID (6.3L) OHV Chrysler V8 Cyl, 4.250in./108mm (1967-1971) **45**

Part Year VIN Model/Application Part Number Qty.

ENGINE GASKETS

Head Set	1967-1971		(Intake Manifold Gasket Not Included, Exhaust Manifold Gasket Not Included)	HS3464VC	1
			(High Temperature, Intake And Exhaust Manifold Gaskets Not Included)	HS3464VH	1
Full Set	1967-1971		(Intake Manifold Gasket Not Included, Exhaust Manifold Gasket Not Included)	FS3464VC	1
Engine Kit Gasket Set	1967-1971		(Intake Manifold Gasket Not Included), Use With Part Number MS15924	95-3344VR	1
Cylinder Head Gasket	1967-1971		Nitroseal	3464SG	2
			VR2000	3464VC	2
			(Stainless Steel Core, High Temperature Gasket With Additional Coolant Passages) VR2000, Stainless Steel	3464VM	2
Valve Cover Set	1967-1971		Cork Rubber	VS38322	1
			High Temperature Cork Rubber	VS38322H	1
Valve Stem Seal, Exh.	1967-1971		(Shedder Type)	B45343	8
Valve Stem Seal, Int.	1967-1971		(Shedder Type)	B45343	8
			(Positive Type)	Nitrile	B45403
Manifold Set, Exhaust	1967-1971			MS10018	1
Manifold Set, Intake	1967-1971			MS15924	1
Oil Pan Set	1967-1971		Cork Rubber	OS31416	1
			Tuff-Cork	OS31416TC	1
Rear Main Seal Set	1967-1971		Rope Packing	JV551	1
				JV604	1
Timing Cover Set	1967-1971			JV834	1
			(Contains Repair Sleeve)	JV924	1
Timing Cover Gasket	1967-1971			T18750	1
Timing Cover Seal	1967-1971			64573	1
Harmonic Balancer Repair Sleeve	1967-1971		Ground Steel, .020" Thickness	66592RS	1
			Use With Part Number A501 Nickel Plated Formed Steel, .013" Thickness	A224	1

MISCELLANEOUS GASKETS

Air Cleaner Mount Gasket	1967-1971			G26410	1
Carb. Mount Gasket	1967-1971		Ram D200, Ram D300, Ram W200, 2 Barrel Carburetor	G7328	1

LIGHT TRUCK

Dodge Truck

45 (cont.)	383 CID (6.3L) OHV Chrysler V8 Cyl, 4.250in./108mm (1967-1971)				45 (cont.)
----------------------	---	--	--	--	----------------------

Part	Year	VIN	Model/Application	Part Number	Qty.
MISCELLANEOUS GASKETS (cont.)					
Carb. Mount Gasket (cont.)	1967-1969		Ram D100, Ram W100, Ram W300, 2 Barrel Carburetor	G7328	1
Dist. Mounting Gasket	1967-1971			B17926	1
Exhaust Pipe Gasket	1967-1971		(Flange Type)	F5495C	2
Fuel Pump Gasket	1967-1971			D27094	1
				Tuff-Cork	D27094TC
Oil Pump Cover Gasket	1967-1971			B45558	1
Water Outlet Gasket	1967-1971			C25487	1
Water Pump Mount Gasket	1967-1971		Housing To Block	K26444	2
				K27080	1

46	400 CID (6.6L) OHV Chrysler V8 Cyl, 4.342in./110.3mm (1972-1980)				46
-----------	---	--	--	--	-----------

Part	Year	VIN	Model/Application	Part Number	Qty.
ENGINE GASKETS					
Head Set	1972-1980		(Intake Manifold Gasket Not Included)	HS3464VC	1
			(High Temperature, Intake Manifold Gasket Not Included)	HS3464VH	1
Full Set	1972-1980		(Intake Manifold Gasket Not Included)	FS3464VC	1
Engine Kit Gasket Set	1972-1980		(Intake Manifold Gasket Not Included), Use With Part Number MS15924	95-3344VR	1
Cylinder Head Gasket	1972-1980		Nitroseal	3464SG	2
			VR2000	3464VC	2
			(Stainless Steel Core, High Temperature Gasket With Additional Coolant Passages) VR2000, Stainless Steel	3464VM	2
Valve Cover Set	1972-1980		Cork Rubber	VS38322	1
			High Temperature Cork Rubber	VS38322H	1
Valve Stem Seal, Exh.	1972-1980		(Shedder Type)	B45343	8
			(Premium, Shedder Type) Fluoroelastomer	B45624	8
Valve Stem Seal, Int.	1972-1980		(Shedder Type)	B45343	8
			(Premium, Shedder Type) Fluoroelastomer	B45623	8
Manifold Set, Exhaust	1972-1980			MS15139	1
Manifold Set, Intake	1972-1980			MS15924	1
Oil Pan Set	1972-1980		Cork Rubber	OS31416	1
			Tuff-Cork	OS31416TC	1
Rear Main Seal Set	1972-1980		Rope Packing	JV551	1
				JV604	1
Timing Cover Set	1972-1980			JV834	1
			(Contains Repair Sleeve)	JV924	1
Timing Cover Gasket	1972-1980			T18750	1
Timing Cover Seal	1972-1980			64573	1
Harmonic Balancer Repair Sleeve	1972-1980		Ground Steel, .020" Thickness	66592RS	1
			Use With Part Number A501 Nickel Plated Formed Steel, .013" Thickness	A224	1

MISCELLANEOUS GASKETS					
Air Cleaner Mount Gasket	1974-1980		4 Barrel Carburetor	G27098	1
	1972-1980		2 Barrel Carburetor	G26410	1
Carb. Mount Gasket	1974-1980		4 Barrel Carburetor	G14589	1
	1972-1980		2 Barrel Carburetor	G14141	1
Dist. Mounting Gasket	1972-1980			B17926	1
E.G.R. Gasket	1974-1980		4 Barrel Carburetor	G24081	1
	1972-1977		2 Barrel Carburetor	G24075	1
Exhaust Pipe Gasket	1972-1980		(Flange Type)	F5495C	2
Fuel Pump Gasket	1972-1980			D27094	1
				Tuff-Cork	D27094TC

LIGHT TRUCK

46 400 CID (6.6L) OHV Chrysler V8 Cyl, 4.342in./110.3mm (1972-1980) **46**
(cont.) (cont.)

Part	Year	VIN	Model/Application	Part Number	Qty.
MISCELLANEOUS GASKETS (cont.)					
Oil Pump Cover Gasket	1972-1980			B45558	1
Water Outlet Gasket	1975-1980			C26690	1
	1972-1977			C25487	1
Water Pump Gasket	1973-1977		Housing To Block	K26444	2
Water Pump Mount Gasket	1972-1980		Housing To Block	K26444	2
				K27080	1

47 413 CID (6.8L) OHV Chrysler V8 Cyl, 4.188in./106.4mm (1963-1977) **47**

Part	Year	VIN	Model/Application	Part Number	Qty.
ENGINE GASKETS					
Head Set	1969-1977		(Intake Manifold Gasket Not Included)	HS3475	1
	1963-1967		(Intake Manifold Gasket Not Included)	HS3252E	1
Full Set	1969-1977		(Intake Manifold Gasket Not Included)	FS3475	1
	1963-1967		(Intake Manifold Gasket Not Included)	FS3252E	1
Cylinder Head Gasket	1969-1977			<i>Beaded Steel</i> 3475	2
				<i>Nitroseal</i> 3464SG	2
				<i>VR2000</i> 3464VC	2
Valve Cover Set	1963-1977		6 Bolt Valve Cover <i>Cork Rubber</i>	VS38322	1
			6 Bolt Valve Cover <i>High Temperature Cork Rubber</i>	VS38322H	1
Valve Stem Seal, Exh.	1963-1977		(Shedder Type)	B45343	8
Valve Stem Seal, Int.	1963-1977		(Shedder Type)	B45343	8
			(Positive Type) <i>Nitrile</i>	B45403	8
Manifold Set, Exhaust	1963-1977			MS15092	1
Manifold Set, Intake	1963-1977			MS15916	1
Oil Pan Set	1963-1977			<i>Cork Rubber</i> OS31416	1
				<i>Tuff-Cork</i> OS31416TC	1
Rear Main Seal Set	1963-1977			<i>Rope Packing</i> JV551	1
				JV604	1
Timing Cover Set	1963-1977			JV834	1
				(Contains Repair Sleeve)	JV924
Timing Cover Gasket	1963-1977			T18750	1
Timing Cover Seal	1963-1977			64573	1
Harmonic Balancer Repair Sleeve	1963-1977			<i>Ground Steel, .020" Thickness</i> 66592RS	1
				Use With Part Number A501 <i>Nickel Plated Formed Steel, .013" Thickness</i> A224	1

MISCELLANEOUS GASKETS

Air Cleaner Mount Gasket	1963-1977		500 To 600 Series	G25936	2
			700 To 1000 Series	G26410	1
Dist. Mounting Gasket	1963-1977			B17926	1
Exhaust Pipe Gasket	1963-1977		(Flange Type)	F7153	2
Fuel Pump Gasket	1963-1977			D27094	1
				<i>Tuff-Cork</i> D27094TC	1
Oil Pump Cover Gasket	1963-1977			B45558	1
Water Outlet Gasket	1963-1977			C25487	1
Water Pump Backing Plate	1973-1974			K27561	2
Water Pump Gasket	1963-1977		Pump To Block	K26444	2
			Pump To Head	K26494	2
			Pump To Plate	K27561	2
Water Pump Mount Gasket	1973-1974		Pump To Block	K26444	2
			Pump To Head	K26494	2

Dodge Truck

48 440 CID (7.2L) OHV Chrysler V8 Cyl, 4.320in./109.7mm (1973-1980)

48

Part	Year	VIN	Model/Application	Part Number	Qty.
ENGINE GASKETS					
Head Set	1973-1980		Except 440-3 And High Temperature, (Intake Manifold Gasket Not Included)	HS3464VC	1
			440-3 And High Temperature, (Intake Manifold Gasket Not Included)	HS3464VH	1
Full Set	1973-1980		Except 440-3 And High Temperature, (Intake Manifold Gasket Not Included)	FS3464VC	1
Engine Kit Gasket Set	1974-1980		Except 440-3 Engine, (Intake Manifold Gasket Not Included), Use With Part Number MS15914	95-3344VR	1
	1973-1980		Motor Home, (Intake Manifold Gasket Not Included), Use With Part Number MS15914	95-3141VR	1
Cylinder Head Gasket	1973-1980		Except 440-3 And High Temperature Nitroseal	3464SG	2
			Except 440-3 And High Temperature VR2000	3464VC	2
			440-3 And High Temperature, (Stainless Steel Core, High Temperature Gasket With Additional Coolant Passages) VR2000, Stainless Steel	3464VM	2
Valve Cover Set	1973-1980		Except 440-3 And High Temperature Cork Rubber	VS38322	1
			440-3 And High Temperature High Temperature Cork Rubber	VS38322H	1
Valve Stem Seal, Exh.	1973-1980		(Shedder Type)	B45343	8
			(Premium, Shedder Type) Fluoroelastomer	B45624	8
Valve Stem Seal, Int.	1973-1980		(Shedder Type)	B45343	8
			(Premium, Positive Type) Fluoroelastomer	B45623	8
Manifold Set, Exhaust	1973-1980			MS15139	1
Manifold Set, Intake	1973-1980			MS15914	1
Oil Pan Set	1973-1980		(Requires 2 Sets For Use With Windage Tray) Cork Rubber	OS31416	1
			(Requires 2 Sets For Use With Windage Tray) Tuff-Cork	OS31416TC	1
Rear Main Seal Set	1973-1980		Rope Packing	JV551	1
				JV604	1
Timing Cover Set	1973-1980			JV834	1
			(Contains Repair Sleeve)	JV924	1
Timing Cover Gasket	1973-1980			T18750	1
Timing Cover Seal	1973-1980			64573	1
Harmonic Balancer Repair Sleeve	1973-1980		Ground Steel, .020" Thickness	66592RS	1
			Use With Part Number A501 Nickel Plated Formed Steel, .013" Thickness	A224	1
MISCELLANEOUS GASKETS					
Air Cleaner Mount Gasket	1976-1980			G27098	1
	1975-1980		4 Barrel Carburetor	G27098	1
	1973-1980			G27098	1
	1979		4 Barrel Carburetor	G27098	1
	1976-1979			G27098	1
	1974-1978		4 Barrel Carburetor	G27098	1
				G27098	1
			4 Barrel Carburetor	G27098	1
	1974-1977			G27098	1
1973-1974		4 Barrel Carburetor	G27098	1	
			G27098	1	
Carb. Mount Gasket	1973-1980		4 Barrel Carburetor	G14589	1
Dist. Mounting Gasket	1973-1980			B17926	1
E.G.R. Gasket	1974-1980			G24081	1
	1973			G24084	1
Exhaust Pipe Gasket	1973-1980		(Flange Type)	F5495C	2
Fuel Pump Gasket	1973-1980			D27094	1
				Tuff-Cork D27094TC	1
Oil Pump Cover Gasket	1973-1980			B45558	1
Water Outlet Gasket	1975-1980			C26690	1

LIGHT TRUCK

48 <small>(cont.)</small>	440 CID (7.2L) OHV Chrysler V8 Cyl, 4.320in./109.7mm (1973-1980)	48 <small>(cont.)</small>
-------------------------------------	---	-------------------------------------

Part	Year	VIN	Model/Application	Part Number	Qty.
MISCELLANEOUS GASKETS (cont.)					
Water Outlet Gasket (cont.)	1973-1977			C25487	1
Water Pump Gasket	1973-1980		Housing To Block	K26444	2
Water Pump Mount Gasket	1973-1980		Housing To Block	K26444	2
				K27080	1

49	488 CID (8.0L) Iron Block Dodge V10 Cyl, 4.000in./101.6mm (1994-2003)	49
-----------	--	-----------

Part	Year	VIN	Model/Application	Part Number	Qty.
ENGINE GASKETS					
Head Set	1994-2000			HS54045	1
Lower Set	1994-2001		(Requires Head Set To Make Full Set)	CS54045	1
Cylinder Head Gasket	1994-2003			54045	2
Valve Cover Set	1994-2003		<i>Victo-Tech</i>	VS50224	1
Valve Stem Seal, Exh.	1994-2003			B45799C	10
Valve Stem Seal, Int.	1994-2003			B45798C	10
Manifold Set, Exhaust	1994-2003			MS16185	1
Manifold Set, Intake	1994-2000		(Contains Plenum Chamber Gasket)	MS16501	1
Plenum Chamber Gasket	1994-2003			MS16188	1
Oil Pan Set	1994-2001		<i>Victo-Tech</i>	OS32142	1
Rear Main Seal Set	1994-2003			JV1628	1
Timing Cover Set	1996-2003			JV1198	1
	1994-1995			JV1197	1
Timing Cover Gasket	1996-2003			T31477	1
	1994-1995			T31476	1

MISCELLANEOUS GASKETS					
Air Cleaner Mount Gasket	1994-2002			G31471	1
E.G.R. Gasket	1994-1996		Valve	G24079	1
Therm. Housing Gasket	1994-1996			C31478	1
Thermostat Seal	1994-2003			C31508	1
Throttle Body Gasket	1994-1996			G31472	1
Water Pump Mount Gasket	1994-1996			K31475	1

Ford Truck

Engine Index

Engine	Year	Block	Engine	Year	Block
110 CID (1.8L) SOHC Mazda	1972-1978	1	200 CID (3.3L) OHV Ford	1965-1974	18
120 CID (2.0L) L-Head Ford	1941-1942	2	215 CID (3.5L) Ford	1952-1953	19
121 CID (2.0L) Ford	1983-1988	3	221 CID (3.6L) Ford	1932-1942	20
122 CID (2.0L) SOHC Mazda	1979-1982	4	223 CID (3.7L) Ford	1954-1964	21
1989CC (2.0L) Zetec/DOHC/16 Valve Ford	2001-2003	5	232 CID (3.8L) Ford	1982-2003	22
134 CID (2.2L) SOHC 8 Valve Mazda Diesel	1983-1984	6	239 CID (3.9L) L-Head Ford	1939-1953	23
140 CID (2.3L) SOHC Ford	1977-1997	7	239 CID (3.9L) OHV Ford	1954-1955	24
140 CID (2.3L) SOHC Mitsubishi Diesel	1985-1987	8	240 CID (4.0L) OHV Ford	1965-1974	25
144 CID (2.4L) Ford	1960-1964	9	244 CID (4.0L) OHV Ford	1990-2000	26
153 CID (2.5L) SOHC Ford	1998-2001	10	244 CID (4.0L) SOHC Ford	1997-2003	27
170 CID (2.8L) Ford	1961-1972	11	244 CID (4.0L) SOHC Ford Flex Fuel	2002-2003	28
171 CID (2.8L) German Ford	1983-1986	12	250 CID (4.1L) Ford	1969-1974	29
177 CID (2.9L) OHV Ford	1986-1992	13	254 CID (4.2L) L-Head Ford	1950-1953	30
181 CID/2967CC (3.0L) Duratec/DOHC/24 Valve Ford	2001-2003	14	255 CID (4.2L) Ford	1981-1982	31
183 CID (3.0L) OHV Ford	1986-2003	15	256 CID (4.2L) Ford	1997-2003	32
2960CC (3.0L) VG30E SOHC Nissan	1993-1998	16	256 CID (4.2L) Ford	1954-1955	33
200 CID (3.3L) L-Head Ford	1933-1934	17	260 CID (4.3L) Ford	1964	34
			262 CID (4.3L) OHV Ford	1961-1964	35

Ford Truck

Engine Index (cont.)

Engine	Year	Block
272 CID (4.5L) Ford	1956-1958	36
281 CID (4.6L) SOHC Ford	1997-2003	37
281 CID (4.6L) SOHC Ford LPG	1997-1998	38
289 CID (4.7L) Ford	1965-1968	39
292 CID (4.8L) Ford	1958-1964	40
300 CID (4.9L) Ford	1965-1996	41
300 CID (4.9L) Ford LPG	1982-1996	42
302 CID (5.0L) Ford	1969-2001	43
302 CID (5.0L) Ford LPG	1969-1986	44
330 CID (5.4L) OHV Ford	1964-1978	45
330 CID (5.4L) Triton DOHC Ford Windsor	1999-2002	46
330 CID (5.4L) Triton SOHC Ford Windsor	1997-2003	47
330 CID (5.4L) Triton SOHC Ford Windsor	1998-2003	48
Bi-Fuel Gasoline/Compressed Natural Gas		
330 CID (5.4L) Triton SOHC Ford Windsor CNG	1997-2003	49
351 CID (5.8L) 351M Ford	1975-1982	50
351 CID (5.8L) 351M Ford LPG	1975-1982	51
351 CID (5.8L) 351C Ford Cleveland	1970-1974	52
351 CID (5.8L) Ford Windsor LPG	1970-1994	53
351 CID (5.8L) 351W Ford Windsor	1969-1997	54
351 CID (5.8L) High Performance Ford Windsor	1993-1996	55

Model Index

Model	Engine	Year	Block
1 Ton	120 CID (2.0L) L-Head Ford	1941-1944	2
1 Ton	221 CID (3.6L) Ford	1937-1942	20
1 Ton	239 CID (3.9L) L-Head Ford	1939-1947	23
1/2 Ton	120 CID (2.0L) L-Head Ford	1941-1944	2
1/2 Ton	221 CID (3.6L) Ford	1935-1942	20
1/2 Ton	239 CID (3.9L) L-Head Ford	1939-1947	23
3/4 Ton	120 CID (2.0L) L-Head Ford	1941-1944	2
3/4 Ton	221 CID (3.6L) Ford	1937-1942	20
3/4 Ton	239 CID (3.9L) L-Head Ford	1939-1947	23
	300 CID (4.9L) Ford	1965-1995	42
	302 CID (5.0L) Ford	1968-1986	44
	351 CID (5.8L) 351M Ford	1975-1982	51
	351 CID (5.8L) Ford Windsor	1969-1994	53
	400 CID (6.6L) OHV Ford	1972-1982	64
Aerostar	140 CID (2.3L) SOHC Ford	1986-1987	7
Aerostar	171 CID (2.8L) German Ford	1986	12
Aerostar	183 CID (3.0L) OHV Ford	1986-1997	15
Aerostar	244 CID (4.0L) OHV Ford	1990-1997	26
B500	215 CID (3.5L) Ford	1953	19
B500	223 CID (3.7L) Ford	1954-1964	21
B500	239 CID (3.9L) L-Head Ford	1953	23
B500	240 CID (4.0L) OHV Ford	1965-1971	25
B500	300 CID (4.9L) Ford	1965-1978	41
B500	330 CID (5.4L) OHV Ford	1964-1978	45
B600	223 CID (3.7L) Ford	1955-1964	21
B600	239 CID (3.9L) L-Head Ford	1953	23
B600	240 CID (4.0L) OHV Ford	1965-1967	25
B600	254 CID (4.2L) L-Head Ford	1953	30
B600	256 CID (4.2L) Ford	1954-1955	33
B600	262 CID (4.3L) OHV Ford	1961-1962	35
B600	272 CID (4.5L) Ford	1956-1958	36
B600	292 CID (4.8L) Ford	1959-1964	40
B600	300 CID (4.9L) Ford	1965-1979	41
B600	330 CID (5.4L) OHV Ford	1964-1978	45
B600	359 CID (5.9L) OHV Ford	1974-1975	57
B600	361 CID (5.9L) OHV Ford	1964-1978	59
B600	370 CID (6.1L) OHV Ford	1979-1989	60
B600	429 CID (7.0L) OHV Ford	1988-1989	69
B700	254 CID (4.2L) L-Head Ford	1953	30
B700	256 CID (4.2L) Ford	1954-1955	33
B700	272 CID (4.5L) Ford	1956-1958	36
B700	292 CID (4.8L) Ford	1959-1964	40
B700	330 CID (5.4L) OHV Ford	1964-1978	45
B700	359 CID (5.9L) OHV Ford	1974-1975	57

Engine	Year	Block
352 CID (5.8L) Ford	1965-1967	56
359 CID (5.9L) OHV Ford	1973-1978	57
360 CID (5.9L) Ford	1968-1976	58
361 CID (5.9L) OHV Ford	1964-1978	59
370 CID (6.1L) OHV Ford	1979-1994	60
389 CID (6.4L) OHV Ford	1975-1978	61
390 CID (6.4L) Ford	1968-1976	62
400 CID (6.6L) OHV Ford	1972-1982	63
400 CID (6.6L) OHV Ford LPG	1972-1979	64
415 CID (6.8L) SOHC Ford Windsor	1997-2003	65
420 CID (6.9L) Navistar Diesel	1983-1987	66
428 CID (7.0L) Cobra Jet Ford	1968-1969	67
429 CID (7.0L) Cobra Jet Ford	1970-1973	68
429 CID (7.0L) OHV Ford	1979-1997	69
429 CID (7.0L) OHV Ford LPG	1990-1997	70
429 CID (7.0L) Thunder Jet Ford	1970-1973	71
444 CID (7.3L) Indirect Injection Navistar Diesel	1988-1994	72
444 CID (7.3L) Indirect Injection Turbocharged Navistar Diesel	1994	73
444 CID (7.3L) T444E (Power Stroke) Navistar Diesel	1994-2002	74
460 CID (7.5L) Ford	1973-1998	75

Model	Engine	Year	Block
B700	361 CID (5.9L) OHV Ford	1964-1978	59
B700	370 CID (6.1L) OHV Ford	1979-1989	60
B700	429 CID (7.0L) OHV Ford	1982-1989	69
Blackwood	330 CID (5.4L) Triton DOHC Ford Windsor	2002-2003	46
Bronco	170 CID (2.8L) Ford	1966-1972	11
Bronco	200 CID (3.3L) OHV Ford	1973-1974	18
Bronco	289 CID (4.7L) Ford	1966-1968	39
Bronco	300 CID (4.9L) Ford	1980-1996	41
Bronco	302 CID (5.0L) Ford	1969-1996	43
Bronco	351 CID (5.8L) 351M Ford	1978-1981	50
Bronco	351 CID (5.8L) 351W Ford Windsor	1978-1996	54
Bronco	400 CID (6.6L) OHV Ford	1978-1979	63
Bronco II	140 CID (2.3L) SOHC Mitsubishi Diesel	1985-1986	8
Bronco II	171 CID (2.8L) German Ford	1984-1986	12
Bronco II	177 CID (2.9L) OHV Ford	1986-1990	13
C500	239 CID (3.9L) L-Head Ford	1953	23
C500	272 CID (4.5L) Ford	1956	36
C500	300 CID (4.9L) Ford	1970-1971	41
C550	262 CID (4.3L) OHV Ford	1961-1964	35
C550	292 CID (4.8L) Ford	1959-1964	40
C550	300 CID (4.9L) Ford	1965-1969	41
C550	330 CID (5.4L) OHV Ford	1964-1969	45
C600	239 CID (3.9L) L-Head Ford	1953	23
C600	262 CID (4.3L) OHV Ford	1961-1964	35
C600	272 CID (4.5L) Ford	1956-1958	36
C600	292 CID (4.8L) Ford	1959-1964	40
C600	300 CID (4.9L) Ford	1965-1977	41
C600	330 CID (5.4L) OHV Ford	1964-1978	45
C600	359 CID (5.9L) OHV Ford	1974-1975	57
C600	361 CID (5.9L) OHV Ford	1964-1978	59
C600	370 CID (6.1L) OHV Ford	1979-1986	60
C700	272 CID (4.5L) Ford	1956-1958	36
C700	292 CID (4.8L) Ford	1959-1963	40
C700	330 CID (5.4L) OHV Ford	1964-1972	45
C700	359 CID (5.9L) OHV Ford	1974-1975	57
C700	361 CID (5.9L) OHV Ford	1964-1978	59
C700	370 CID (6.1L) OHV Ford	1979-1986	60
C700	389 CID (6.4L) OHV Ford	1975-1978	61
C700	429 CID (7.0L) OHV Ford	1979-1986	69
Club Wagon E100	144 CID (2.4L) Ford	1962-1964	9

Ford Truck

Model Index (cont.)

<i>Model</i>	<i>Engine</i>	<i>Year</i>	<i>Block</i>	<i>Model</i>	<i>Engine</i>	<i>Year</i>	<i>Block</i>
Club Wagon E100	170 CID (2.8L) Ford	1962-1972	11	Club Wagon E350	420 CID (6.9L) Navistar Diesel	1984-1987	66
Club Wagon E100	240 CID (4.0L) OHV Ford	1965-1974	25	Club Wagon E350	444 CID (7.3L) Indirect Injection Turbocharged Navistar Diesel	1994	73
Club Wagon E100	300 CID (4.9L) Ford	1974-1982	41	Club Wagon E350	444 CID (7.3L) T444E (Power Stroke) Navistar Diesel	1994-1998	74
Club Wagon E100	302 CID (5.0L) Ford	1973-1983	43	Club Wagon E350	444 CID (7.3L) Indirect Injection Navistar Diesel	1988-1994	72
Club Wagon E100	351 CID (5.8L) 351M Ford	1977-1982	50	Club Wagon E350	460 CID (7.5L) Ford	1984-1996	75
Club Wagon E100	351 CID (5.8L) 351W Ford Windsor	1975-1983	54	Courier	110 CID (1.8L) SOHC Mazda	1972-1978	1
Club Wagon E150	256 CID (4.2L) Ford	1997-2003	32	Courier	122 CID (2.0L) SOHC Mazda	1979-1982	4
Club Wagon E150	281 CID (4.6L) SOHC Ford	1997-2004	37	Courier	140 CID (2.3L) SOHC Ford	1977-1982	7
Club Wagon E150	281 CID (4.6L) SOHC Ford	1997-1998	38	E100 Pickup	144 CID (2.4L) Ford	1961-1964	9
Club Wagon E150	300 CID (4.9L) Ford	1990-1996	42	E100 Pickup	170 CID (2.8L) Ford	1964-1967	11
Club Wagon E150	300 CID (4.9L) Ford	1975-1996	41	E100 Pickup	240 CID (4.0L) OHV Ford	1967	25
Club Wagon E150	302 CID (5.0L) Ford	1980-1996	43	E100 Station Bus	144 CID (2.4L) Ford	1961-1964	9
Club Wagon E150	330 CID (5.4L) Triton SOHC Ford Windsor	1997-1998	49	E100 Station Bus	170 CID (2.8L) Ford	1962-1965	11
Club Wagon E150	330 CID (5.4L) Triton SOHC Ford Windsor	1997-2004	47	Econoline E100	144 CID (2.4L) Ford	1961-1964	9
Club Wagon E150	351 CID (5.8L) 351M Ford	1977-1982	50	Econoline E100	170 CID (2.8L) Ford	1964-1967	11
Club Wagon E150	351 CID (5.8L) 351W Ford Windsor	1975-1996	54	Econoline E100	240 CID (4.0L) OHV Ford	1967	25
Club Wagon E200	240 CID (4.0L) OHV Ford	1969-1974	25	Econoline E100	300 CID (4.9L) Ford	1974-1982	41
Club Wagon E200	300 CID (4.9L) Ford	1974	41	Econoline E100	302 CID (5.0L) Ford	1973-1983	43
Club Wagon E200	302 CID (5.0L) Ford	1969-1974	43	Econoline E100	351 CID (5.8L) 351M Ford	1977-1982	50
Club Wagon E250	300 CID (4.9L) Ford	1982-1991	42	Econoline E100	351 CID (5.8L) 351W Ford Windsor	1975-1983	54
Club Wagon E250	300 CID (4.9L) Ford	1975-1991	41	Econoline E150	256 CID (4.2L) Ford	1997-2003	32
Club Wagon E250	302 CID (5.0L) Ford	1979-1991	43	Econoline E150	281 CID (4.6L) SOHC Ford	1997-2004	37
Club Wagon E250	351 CID (5.8L) 351M Ford	1977-1982	50	Econoline E150	281 CID (4.6L) SOHC Ford	1997-1998	38
Club Wagon E250	351 CID (5.8L) 351W Ford Windsor	1975-1991	54	Econoline E150	300 CID (4.9L) Ford	1990-1996	42
Club Wagon E250	400 CID (6.6L) OHV Ford	1980-1982	63	Econoline E150	300 CID (4.9L) Ford	1975-1996	41
Club Wagon E250	420 CID (6.9L) Navistar Diesel	1983-1987	66	Econoline E150	302 CID (5.0L) Ford	1979-1996	43
Club Wagon E250	444 CID (7.3L) Indirect Injection Navistar Diesel	1988-1991	72	Econoline E150	302 CID (5.0L) Ford	1979-1996	43
Club Wagon E250	460 CID (7.5L) Ford	1975-1991	75	Econoline E150	330 CID (5.4L) Triton SOHC Ford Windsor	1997-1998	49
Club Wagon E300	240 CID (4.0L) OHV Ford	1969-1974	25	Econoline E150	330 CID (5.4L) Triton SOHC Ford Windsor	1997-2004	47
Club Wagon E300	302 CID (5.0L) Ford	1969-1974	43	Econoline E150	351 CID (5.8L) 351M Ford	1977-1982	50
Club Wagon E350	300 CID (4.9L) Ford	1984	42	Econoline E150	351 CID (5.8L) 351W Ford Windsor	1975-1996	54
Club Wagon E350	300 CID (4.9L) Ford	1984-1996	41	Econoline E200	170 CID (2.8L) Ford	1969-1972	11
Club Wagon E350	330 CID (5.4L) Triton SOHC Ford Windsor	1997-1998	49	Econoline E200	240 CID (4.0L) OHV Ford	1969-1974	25
Club Wagon E350	330 CID (5.4L) Triton SOHC Ford Windsor	1997-1998	47	Econoline E200	302 CID (5.0L) Ford	1969-1974	43
Club Wagon E350	351 CID (5.8L) 351W Ford Windsor	1984-1996	54	Econoline E250	256 CID (4.2L) Ford	1997-2003	32
Club Wagon E350	415 CID (6.8L) SOHC Ford Windsor	1997-2000	65	Econoline E250	281 CID (4.6L) SOHC Ford	1997-2004	37
				Econoline E250	300 CID (4.9L) Ford	1990-1996	42
				Econoline E250	300 CID (4.9L) Ford	1975-1996	41
				Econoline E250	302 CID (5.0L) Ford	1979-1996	43

Ford Truck

Model Index (cont.)

Model	Engine	Year	Block	Model	Engine	Year	Block
Econoline E250	330 CID (5.4L) Triton SOHC Ford Windsor	1998-2001	48	Econoline E350 Super Duty	330 CID (5.4L) Triton SOHC Ford Windsor	1999-2004	47
Econoline E250	330 CID (5.4L) Triton SOHC Ford Windsor	1997-2004	49	Econoline E350 Super Duty	415 CID (6.8L) SOHC Ford Windsor	1998-2004	65
Econoline E250	330 CID (5.4L) Triton SOHC Ford Windsor	1997-2004	47	Econoline E350 Super Duty	444 CID (7.3L) T444E (Power Stroke) Navistar Diesel	1998-2003	74
Econoline E250	351 CID (5.8L) 351M Ford	1977-1982	50	Econoline E350 Super Duty	330 CID (5.4L) Triton SOHC Ford Windsor	1999-2001	48
Econoline E250	351 CID (5.8L) 351W Ford Windsor	1975-1996	54	Econoline E350 Super Duty Ext.	330 CID (5.4L) Triton SOHC Ford Windsor	1999-2004	49
Econoline E250	420 CID (6.9L) Navistar Diesel	1983-1987	66	Econoline E350 Super Duty Ext.	330 CID (5.4L) Triton SOHC Ford Windsor	1999-2004	47
Econoline E250	460 CID (7.5L) Ford	1975-1998	75	Econoline E350 Super Duty Ext.	415 CID (6.8L) SOHC Ford Windsor	1999-2004	65
Econoline E250 Ext.	256 CID (4.2L) Ford	1999-2003	32	Econoline E350 Super Duty Ext.	444 CID (7.3L) T444E (Power Stroke) Navistar Diesel	1999-2003	74
Econoline E250 Ext.	330 CID (5.4L) Triton SOHC Ford Windsor	1999-2001	48	Econoline E350 Super Duty Ext.	415 CID (6.8L) SOHC Ford Windsor	1999-2004	65
Econoline E250 Ext.	330 CID (5.4L) Triton SOHC Ford Windsor	1999-2004	49	Econoline E350 Super Duty Ext.	444 CID (7.3L) T444E (Power Stroke) Navistar Diesel	1999-2003	74
Econoline E250 Ext.	330 CID (5.4L) Triton SOHC Ford Windsor	1999-2004	47	Econoline E350 Super Duty Ext.	415 CID (6.8L) SOHC Ford Windsor	1999-2004	65
Econoline E250 Super Duty	256 CID (4.2L) Ford	1999-2003	32	Econoline E450 Super Duty	444 CID (7.3L) T444E (Power Stroke) Navistar Diesel	1999-2003	74
Econoline E250 Super Duty	330 CID (5.4L) Triton SOHC Ford Windsor	1999-2001	48	Econoline E450 Super Duty	415 CID (6.8L) SOHC Ford Windsor	1999-2004	65
Econoline E250 Super Duty	330 CID (5.4L) Triton SOHC Ford Windsor	1999-2004	49	Econoline E450 Super Duty	444 CID (7.3L) T444E (Power Stroke) Navistar Diesel	1999-2003	74
Econoline E250 Super Duty	330 CID (5.4L) Triton SOHC Ford Windsor	1999-2004	47	Escape	181 CID/2967CC (3.0L) Duratec/DOHC/24 Valve Ford 1989CC (2.0L)	2001-2004	14
Econoline E300	240 CID (4.0L) OHV Ford	1969-1974	25	Escape	Zetec/DOHC/16 Valve Ford	2001-2004	5
Econoline E300	302 CID (5.0L) Ford	1969-1974	43	Excursion	330 CID (5.4L) Triton SOHC Ford Windsor	2000-2004	47
Econoline E350	300 CID (4.9L) Ford	1983-1984	42	Excursion	415 CID (6.8L) SOHC Ford Windsor	2000-2004	65
Econoline E350	300 CID (4.9L) Ford	1975-1996	41	Excursion	444 CID (7.3L) T444E (Power Stroke) Navistar Diesel	2000-2003	74
Econoline E350	330 CID (5.4L) Triton SOHC Ford Windsor	1998	48	Expedition	281 CID (4.6L) SOHC Ford	1997-2004	37
Econoline E350	330 CID (5.4L) Triton SOHC Ford Windsor	1997-1998	49	Expedition	330 CID (5.4L) Triton SOHC Ford Windsor	1998	48
Econoline E350	330 CID (5.4L) Triton SOHC Ford Windsor	1997-1998	47	Expedition	330 CID (5.4L) Triton SOHC Ford Windsor	1997-2004	47
Econoline E350	351 CID (5.8L) 351M Ford	1977-1982	50	Explorer	244 CID (4.0L) SOHC Ford	2002-2004	28
Econoline E350	351 CID (5.8L) 351W Ford Windsor	1975-1996	54	Explorer	244 CID (4.0L) SOHC Ford	1997-2004	27
Econoline E350	400 CID (6.6L) OHV Ford	1980-1981	63	Explorer	244 CID (4.0L) OHV Ford	1991-2000	26
Econoline E350	415 CID (6.8L) SOHC Ford Windsor	1997-1998	65	Explorer	281 CID (4.6L) SOHC Ford	2002-2004	37
Econoline E350	420 CID (6.9L) Navistar Diesel	1983-1987	66	Explorer	302 CID (5.0L) Ford	1996-2001	43
Econoline E350	444 CID (7.3L) Indirect Injection Turbocharged Navistar Diesel	1994	73	Explorer Sport	244 CID (4.0L) SOHC Ford	2003	27
Econoline E350	444 CID (7.3L) T444E (Power Stroke) Navistar Diesel	1994-1998	74	Explorer Sport Trac	244 CID (4.0L) SOHC Ford	2003-2004	27
Econoline E350	444 CID (7.3L) Indirect Injection Navistar Diesel	1988-1994	72	F1	215 CID (3.5L) Ford	1952	19
Econoline E350	460 CID (7.5L) Ford	1975-1996	75	F1	239 CID (3.9L) L-Head Ford	1948-1952	23
Econoline E350 Super Duty	330 CID (5.4L) Triton SOHC Ford Windsor	1999-2003	48	F2	215 CID (3.5L) Ford	1952	19
Econoline E350 Super Duty	330 CID (5.4L) Triton SOHC Ford Windsor	1999-2004	49	F2	239 CID (3.9L) L-Head Ford	1948-1952	23
				F3	215 CID (3.5L) Ford	1952	19
				F3	239 CID (3.9L) L-Head Ford	1948-1952	23
				F53	460 CID (7.5L) Ford	1989-1995	75
				F100	215 CID (3.5L) Ford	1953	19
				F100	223 CID (3.7L) Ford	1954-1964	21
				F100	232 CID (3.8L) Ford	1982-1983	22
				F100	239 CID (3.9L) OHV Ford	1954-1955	24
				F100	239 CID (3.9L) L-Head Ford	1953	23
				F100	240 CID (4.0L) OHV Ford	1965-1974	25
				F100	255 CID (4.2L) Ford	1981-1982	31
				F100	272 CID (4.5L) Ford	1956-1958	36
				F100	292 CID (4.8L) Ford	1959-1964	40
				F100	300 CID (4.9L) Ford	1965-1982	41
				F100	302 CID (5.0L) Ford	1970-1983	43

Ford Truck

Model Index (cont.)

Model	Engine	Year	Block	Model	Engine	Year	Block
F100	351 CID (5.8L) 351M Ford	1977-1982	50	F350	240 CID (4.0L) OHV Ford	1965-1971	25
F100	351 CID (5.8L) 351W Ford Windsor	1977-1979	54	F350	272 CID (4.5L) Ford	1956-1958	36
F100	352 CID (5.8L) Ford	1965-1966	56	F350	292 CID (4.8L) Ford	1959-1964	40
F100	360 CID (5.9L) Ford	1968-1976	58	F350	300 CID (4.9L) Ford	1965-1996	41
F100	390 CID (6.4L) Ford	1968-1976	62	F350	351 CID (5.8L) 351M Ford	1977-1982	50
F100	400 CID (6.6L) OHV Ford	1977-1979	63	F350	351 CID (5.8L) 351W Ford Windsor	1977-1998	54
F100	460 CID (7.5L) Ford	1973-1977	75	F350	352 CID (5.8L) Ford	1965-1966	56
F150	256 CID (4.2L) Ford	1997-2003	32	F350	360 CID (5.9L) Ford	1968-1976	58
F150	281 CID (4.6L) SOHC Ford	1997-2004	37	F350	390 CID (6.4L) Ford	1968-1976	62
F150	300 CID (4.9L) Ford	1975-1996	41	F350	400 CID (6.6L) OHV Ford	1977-1982	63
F150	302 CID (5.0L) Ford	1975-1996	43	F350	420 CID (6.9L) Navistar Diesel	1983-1987	66
F150	330 CID (5.4L) Triton SOHC Ford Windsor	1998-2003	48	F350	444 CID (7.3L) T444E (Power Stroke) Navistar Diesel	1994-1998	74
F150	330 CID (5.4L) Triton SOHC Ford Windsor	1999-2003	49	F350	444 CID (7.3L) Indirect Injection Navistar Diesel	1988-1994	72
F150	330 CID (5.4L) Triton SOHC Ford Windsor	1997-2003	47	F350	460 CID (7.5L) Ford	1973-1998	75
F150	351 CID (5.8L) High Performance Ford Windsor	1993-1996	55	F350 Super Duty	330 CID (5.4L) Triton SOHC Ford Windsor	1999-2004	47
F150	351 CID (5.8L) 351M Ford	1977-1981	50	F350 Super Duty	415 CID (6.8L) SOHC Ford Windsor	1999-2004	65
F150	351 CID (5.8L) 351W Ford Windsor	1977-1996	54	F350 Super Duty	444 CID (7.3L) T444E (Power Stroke) Navistar Diesel	1999-2003	74
F150	360 CID (5.9L) Ford	1975-1976	58	F450 Super Duty	415 CID (6.8L) SOHC Ford Windsor	1999-2004	65
F150	390 CID (6.4L) Ford	1975-1976	62	F450 Super Duty	444 CID (7.3L) T444E (Power Stroke) Navistar Diesel	1999-2003	74
F150	400 CID (6.6L) OHV Ford	1977-1979	63	F500	215 CID (3.5L) Ford	1953	19
F150	460 CID (7.5L) Ford	1975-1979	75	F500	223 CID (3.7L) Ford	1954-1964	21
F150	281 CID (4.6L) SOHC Ford	2001-2004	37	F500	239 CID (3.9L) L-Head Ford	1953	23
SuperCrew F150	330 CID (5.4L) Triton SOHC Ford Windsor	2001-2003	47	F500	240 CID (4.0L) OHV Ford	1965-1974	25
SuperCrew F250	215 CID (3.5L) Ford	1953	19	F500	292 CID (4.8L) Ford	1959-1964	40
F250	223 CID (3.7L) Ford	1954-1964	21	F500	300 CID (4.9L) Ford	1965-1977	41
F250	239 CID (3.9L) OHV Ford	1954-1955	24	F500	330 CID (5.4L) OHV Ford	1964-1977	45
F250	239 CID (3.9L) L-Head Ford	1953	23	F550 Super Duty	415 CID (6.8L) SOHC Ford Windsor	1999-2004	65
F250	240 CID (4.0L) OHV Ford	1965-1971	25	F550 Super Duty	444 CID (7.3L) T444E (Power Stroke) Navistar Diesel	1999-2003	74
F250	272 CID (4.5L) Ford	1956-1958	36	F600	239 CID (3.9L) L-Head Ford	1953	23
F250	281 CID (4.6L) SOHC Ford	1997-1999	37	F600	254 CID (4.2L) L-Head Ford	1953	30
F250	292 CID (4.8L) Ford	1959-1964	40	F600	256 CID (4.2L) Ford	1954-1955	33
F250	300 CID (4.9L) Ford	1982-1996	42	F600	262 CID (4.3L) OHV Ford	1961-1962	35
F250	300 CID (4.9L) Ford	1965-1996	41	F600	272 CID (4.5L) Ford	1956-1958	36
F250	302 CID (5.0L) Ford	1970-1996	43	F600	292 CID (4.8L) Ford	1959-1964	40
F250	330 CID (5.4L) Triton SOHC Ford Windsor	1998-1999	48	F600	300 CID (4.9L) Ford	1968-1979	41
F250	330 CID (5.4L) Triton SOHC Ford Windsor	1997-1998	49	F600	330 CID (5.4L) OHV Ford	1965-1979	45
F250	330 CID (5.4L) Triton SOHC Ford Windsor	1997-1999	47	F600	359 CID (5.9L) OHV Ford	1974-1975	57
F250	351 CID (5.8L) 351M Ford	1977-1982	50	F600	361 CID (5.9L) OHV Ford	1964-1978	59
F250	351 CID (5.8L) 351W Ford Windsor	1977-1997	54	F600	370 CID (6.1L) OHV Ford	1979-1994	60
F250	352 CID (5.8L) Ford	1965-1966	56	F600	429 CID (7.0L) OHV Ford	1990-1994	70
F250	360 CID (5.9L) Ford	1968-1976	58	F600	429 CID (7.0L) OHV Ford	1989-1994	69
F250	390 CID (6.4L) Ford	1968-1976	62	F650 Super Duty	444 CID (7.3L) T444E (Power Stroke) Navistar Diesel	2000-2002	74
F250	400 CID (6.6L) OHV Ford	1977-1982	63	F700	254 CID (4.2L) L-Head Ford	1953	30
F250	420 CID (6.9L) Navistar Diesel	1983-1987	66	F700	256 CID (4.2L) Ford	1954-1955	33
F250	444 CID (7.3L) T444E (Power Stroke) Navistar Diesel	1994-1998	74	F700	272 CID (4.5L) Ford	1956-1958	36
F250	444 CID (7.3L) Indirect Injection Navistar Diesel	1988-1994	72	F700	292 CID (4.8L) Ford	1959-1964	40
F250	460 CID (7.5L) Ford	1973-1998	75	F700	330 CID (5.4L) OHV Ford	1964-1972	45
F250 Super Duty	330 CID (5.4L) Triton SOHC Ford Windsor	1999-2004	47	F700	359 CID (5.9L) OHV Ford	1974-1975	57
F250 Super Duty	415 CID (6.8L) SOHC Ford Windsor	1999-2004	65	F700	361 CID (5.9L) OHV Ford	1964-1978	59
F250 Super Duty	444 CID (7.3L) T444E (Power Stroke) Navistar Diesel	1999-2003	74	F700	370 CID (6.1L) OHV Ford	1979-1990	60
F350	215 CID (3.5L) Ford	1953	19	F700	389 CID (6.4L) OHV Ford	1975-1978	61
F350	223 CID (3.7L) Ford	1954-1964	21	F700	429 CID (7.0L) OHV Ford	1990-1997	70
F350	239 CID (3.9L) OHV Ford	1954-1955	24	F700	429 CID (7.0L) OHV Ford	1979-1997	69
F350	239 CID (3.9L) L-Head Ford	1953	23	F750 Super Duty	444 CID (7.3L) T444E (Power Stroke) Navistar Diesel	2000-2002	74
				F-Super Duty	444 CID (7.3L) Indirect Injection Turbocharged Navistar Diesel	1994	73

Ford Truck

Model Index (cont.)

Model	Engine	Year	Block	Model	Engine	Year	Block
F-Super Duty	444 CID (7.3L) T444E (Power Stroke) Navistar Diesel	1994-1997	74	P500	223 CID (3.7L) Ford	1954-1964	21
F-Super Duty	444 CID (7.3L) Indirect Injection Navistar Diesel	1988-1994	72	P500	240 CID (4.0L) OHV Ford	1965-1972	25
F-Super Duty	460 CID (7.5L) Ford	1988-1997	75	P500	272 CID (4.5L) Ford	1957-1958	36
Falcon	144 CID (2.4L) Ford	1960-1964	9	P500	292 CID (4.8L) Ford	1959-1964	40
Falcon	170 CID (2.8L) Ford	1961-1965	11	P500	300 CID (4.9L) Ford	1965-1977	41
Falcon	200 CID (3.3L) OHV Ford	1965	18	P550	390 CID (6.4L) Ford	1975-1976	62
Falcon	260 CID (4.3L) Ford	1964	34	P600	300 CID (4.9L) Ford	1975-1979	41
Falcon	289 CID (4.7L) Ford	1965	39	Ranchero	200 CID (3.3L) OHV Ford	1966-1968	18
LN500	300 CID (4.9L) Ford	1970-1971	41	Ranchero	250 CID (4.1L) Ford	1969-1974	29
LN500	330 CID (5.4L) OHV Ford	1970-1971	45	Ranchero	289 CID (4.7L) Ford	1966-1968	39
LN600	300 CID (4.9L) Ford	1970-1974	41	Ranchero	302 CID (5.0L) Ford	1969-1974	43
LN600	330 CID (5.4L) OHV Ford	1970-1978	45	Ranchero	351 CID (5.8L) 351M Ford	1975-1979	50
LN600	359 CID (5.9L) OHV Ford	1974-1975	57	Ranchero	351 CID (5.8L) 351C Ford	1970-1974	52
LN600	361 CID (5.9L) OHV Ford	1970-1978	59	Ranchero	Cleveland		
LN600	370 CID (6.1L) OHV Ford	1979-1985	60	Ranchero	351 CID (5.8L) 351W Ford	1969-1979	54
LN700	330 CID (5.4L) OHV Ford	1970-1974	45	Ranchero	Windsor		
LN700	359 CID (5.9L) OHV Ford	1974-1975	57	Ranchero	390 CID (6.4L) Ford	1967-1969	62
LN700	361 CID (5.9L) OHV Ford	1970-1978	59	Ranchero	400 CID (6.6L) OHV Ford	1972-1978	63
LN700	370 CID (6.1L) OHV Ford	1979-1985	60	Ranchero	428 CID (7.0L) Cobra Jet Ford	1968-1969	67
LN700	389 CID (6.4L) OHV Ford	1975-1978	61	Ranchero	429 CID (7.0L) Cobra Jet Ford	1970-1973	68
LN700	429 CID (7.0L) OHV Ford	1979-1985	69	Ranchero	429 CID (7.0L) Thunder Jet Ford	1970-1973	71
M400	360 CID (5.9L) Ford	1972-1976	58	Ranchero	460 CID (7.5L) Ford	1974-1976	75
M400	390 CID (6.4L) Ford	1972-1976	62	Ranger	121 CID (2.0L) Ford	1983-1988	3
M450	360 CID (5.9L) Ford	1973-1976	58	Ranger	134 CID (2.2L) SOHC 8 Valve Mazda Diesel	1983-1984	6
M450	390 CID (6.4L) Ford	1973-1976	62	Ranger	140 CID (2.3L) SOHC Mitsubishi Diesel	1985-1987	8
M450	460 CID (7.5L) Ford	1973-1976	75	Ranger	140 CID (2.3L) SOHC Ford	1983-1997	7
M500	390 CID (6.4L) Ford	1972-1976	62	Ranger	153 CID (2.5L) SOHC Ford	1998-2001	10
Model 46	221 CID (3.6L) Ford	1933	20	Ranger	171 CID (2.8L) German Ford	1983-1986	12
Model BB	200 CID (3.3L) L-Head Ford	1932-1934	17	Ranger	177 CID (2.9L) OHV Ford	1986-1992	13
Model BB	221 CID (3.6L) Ford	1932	20	Ranger	183 CID (3.0L) OHV Ford	1990-2004	15
Mountaineer	244 CID (4.0L) SOHC Ford	1998-2001	27	Ranger	244 CID (4.0L) SOHC Ford	2002-2004	27
Mountaineer	281 CID (4.6L) SOHC Ford	2002-2004	37	Ranger	244 CID (4.0L) OHV Ford	1990-2000	26
Mountaineer	302 CID (5.0L) Ford	1997-2001	43	Ranger	300 CID (4.9L) Ford	1978-1982	41
N500	223 CID (3.7L) Ford	1963-1964	21	Super Wagon	302 CID (5.0L) Ford	1980-1983	43
N500	240 CID (4.0L) OHV Ford	1965-1969	25	E150	Super Wagon 351 CID (5.8L) 351M Ford	1978-1982	50
N500	292 CID (4.8L) Ford	1963-1964	40	Super Wagon	E150		
N500	300 CID (4.9L) Ford	1965-1969	41	Super Wagon	351 CID (5.8L) 351W Ford	1978-1983	54
N500	330 CID (5.4L) OHV Ford	1965-1969	45	E150	Windsor		
N600	223 CID (3.7L) Ford	1963-1964	21	Super Wagon	300 CID (4.9L) Ford	1983	42
N600	240 CID (4.0L) OHV Ford	1965-1967	25	E250	Super Wagon 300 CID (4.9L) Ford	1978-1979	41
N600	292 CID (4.8L) Ford	1963	40	Super Wagon	E250		
N600	300 CID (4.9L) Ford	1965-1969	41	Super Wagon	302 CID (5.0L) Ford	1979	43
N600	330 CID (5.4L) OHV Ford	1964-1969	45	E250	Super Wagon 351 CID (5.8L) 351M Ford	1978-1980	50
N600	361 CID (5.9L) OHV Ford	1964-1969	59	E250	Super Wagon 351 CID (5.8L) 351W Ford	1978-1979	54
Navigator	330 CID (5.4L) Triton DOHC Ford Windsor	1999-2004	46	Super Wagon	400 CID (6.6L) OHV Ford	1980	63
Navigator	330 CID (5.4L) Triton SOHC Ford Windsor	1998-1999	48	E250	Super Wagon 420 CID (6.9L) Navistar Diesel	1983	66
Navigator	330 CID (5.4L) Triton SOHC Ford Windsor	1998-1999	47	Super Wagon	E250		
P100	144 CID (2.4L) Ford	1960-1964	9	Super Wagon	460 CID (7.5L) Ford	1978-1979	75
P100	170 CID (2.8L) Ford	1961-1967	11	E250	Super Wagon 300 CID (4.9L) Ford	1978-1982	41
P100	223 CID (3.7L) Ford	1957-1964	21	Super Wagon	351 CID (5.8L) 351M Ford	1978-1982	50
P100	240 CID (4.0L) OHV Ford	1965-1967	25	E350	Super Wagon 351 CID (5.8L) 351W Ford	1978-1983	54
P100	300 CID (4.9L) Ford	1965	41	Super Wagon	Windsor		
P350	215 CID (3.5L) Ford	1953	19	Super Wagon	420 CID (6.9L) Navistar Diesel	1983	66
P350	223 CID (3.7L) Ford	1954-1964	21	E350	Super Wagon 460 CID (7.5L) Ford	1978-1983	75
P350	239 CID (3.9L) L-Head Ford	1953-1955	23	Super Wagon	E350		
P350	240 CID (4.0L) OHV Ford	1965-1972	25	Super Wagon	300 CID (4.9L) Ford	1978-1982	41
P350	272 CID (4.5L) Ford	1956-1958	36	Super Wagon	351 CID (5.8L) 351M Ford	1978-1982	50
P350	292 CID (4.8L) Ford	1959-1964	40	E350	Super Wagon 351 CID (5.8L) 351W Ford	1978-1983	54
P350	300 CID (4.9L) Ford	1965-1977	41	Super Wagon	Windsor		
P400	223 CID (3.7L) Ford	1957-1964	21	Super Wagon	420 CID (6.9L) Navistar Diesel	1983	66
P400	240 CID (4.0L) OHV Ford	1965-1972	25	E350	Super Wagon 460 CID (7.5L) Ford	1978-1983	75
P400	272 CID (4.5L) Ford	1957-1958	36	T700	272 CID (4.5L) Ford	1957-1958	36
P400	292 CID (4.8L) Ford	1959-1964	40	T700	292 CID (4.8L) Ford	1958-1962	40
P400	300 CID (4.9L) Ford	1965-1976	41				
P450	360 CID (5.9L) Ford	1975-1976	58				
P500	215 CID (3.5L) Ford	1953	19				

LIGHT TRUCK

Model Index (cont.)

Model	Engine	Year	Block	Model	Engine	Year	Block
Villager	2960CC (3.0L) VG30E SOHC Nissan	1993-1998	16	Wagon E350 Super Duty	330 CID (5.4L) Triton SOHC Ford Windsor	1999-2004	49
Wagon E350 Super Duty	330 CID (5.4L) Triton SOHC Ford Windsor	1999-2001	48	Wagon E350 Super Duty	330 CID (5.4L) Triton SOHC Ford Windsor	1999-2004	47
Wagon E350 Super Duty	330 CID (5.4L) Triton SOHC Ford Windsor	1999-2004	49	Wagon E350 Super Duty	415 CID (6.8L) SOHC Ford Windsor	1999-2004	65
Wagon E350 Super Duty	330 CID (5.4L) Triton SOHC Ford Windsor	1999-2004	47	Wagon E350 Super Duty	444 CID (7.3L) T444E (Power Stroke) Navistar Diesel	1999-2003	74
Wagon E350 Super Duty	415 CID (6.8L) SOHC Ford Windsor	1999-2004	65	Wagon E350 Super Duty	330 CID (5.4L) Triton SOHC Ford Windsor	1999-2001	48
Wagon E350 Super Duty	444 CID (7.3L) T444E (Power Stroke) Navistar Diesel	1999-2003	74	Windstar	183 CID (3.0L) OHV Ford	1994-2000	15
Wagon E350 Super Duty	330 CID (5.4L) Triton SOHC Ford Windsor	1999-2001	48	Windstar	232 CID (3.8L) Ford	1995-2003	22

1 110 CID (1.8L) SOHC Mazda 4 Cyl, 3.071in./78mm (1972-1978) 1

Part	Year	VIN	Model/Application	Part Number	Qty.
------	------	-----	-------------------	-------------	------

ENGINE GASKETS

Head Set	1972-1978			HS3683	1
Full Set	1972-1978			FS3683	1
Engine Kit Gasket Set	1975-1978		(Exhaust Manifold Gasket Not Included), Use With Part Number MS12281	95-3366VR	1
	1972-1974		(Exhaust Manifold Gasket Not Included), Use With Part Number MS85718	95-3366VR	1
Cylinder Head Gasket	1972-1978		Nitroseal	3683	1
Cyl. Head Spacer Shim	1972-1978		Requires Sealing Compound Steel	3683S	1
Sealing Compound	1972-1978		(4 Ounce Brush Top Can)	JV66B	1
			(12 Ounce Spray Can)	JV66S	1
Valve Cover Set	1972-1978		(Camshaft Semi Circular Plug Not Included) Cork Rubber	VS39754	1
			(Camshaft Semi Circular Plug Not Included) Tuff-Cork	VS39754TC	1
			(Contains Camshaft Semi Circular Plug) Cork Rubber	VS39754W	1
			(Camshaft Semi Circular Plug Not Included) Victo-Tech	VS50144	1
Valve Stem Seal, Exh.	1972-1978			B45437	4
Valve Stem Seal, Int.	1972-1978			B45437	4
Manifold Set, Exhaust	1975-1978			MS12281	1
	1972-1974			MS85718	2
Manifold Set, Intake	1972-1978			MS85719	1
Oil Pan Set	1972-1978		Cork Rubber	OS30548	1
Rear Main Seal Set	1972-1978			JV627	1
Timing Cover Set	1972-1978			JV963	1

MISCELLANEOUS GASKETS

Cam. Semi-Circular Plug	1972-1978		(Half Round), Front, Rear	B45450	2
Carb. Mount Gasket	1972-1978		2 Barrel Carburetor, Carburetor To Spacer, Spacer To Manifold	G26825	2
E.G.R. Gasket	1977-1978		Valve Adapter	G24843	1
			Valve	G24844	1
Exhaust Pipe Gasket	1977-1978		(Flange Type), Pipe To Converter	F10027	1
	1975-1978		1-3/4" Inside Diameter, Muffler To Resonator	F10028	1
	1974-1978		(Flange Type), Pipe To Manifold	F7393	1
	1972-1978		1-15/16" Inside Diameter, Muffler To Resonator	F10027	1
	1976		California, (Flange Type), Pipe To Converter	F10027	1
			Except California, (Flange Type), Pipe To Converter	F10028	1
	1975		(Flange Type), Pipe To Converter	F10028	1
	1972-1974		1-3/4" Inside Diameter, (Flange Type), Muffler To Resonator, Pipe To Converter	F10028	1
1972-1973		(Flange Type), Pipe To Manifold	F20282	1	
Therm. Housing Gasket	1972-1978		Outer	C20136	1
			Inner	C20375	1

Ford Truck

1 (cont.)	110 CID (1.8L) SOHC Mazda 4 Cyl, 3.071in./78mm (1972-1978)					1 (cont.)
---------------------	---	--	--	--	--	---------------------

Part	Year	VIN	Model/Application	Part Number	Qty.
------	------	-----	-------------------	-------------	------

MISCELLANEOUS GASKETS (cont.)

Water Pump Mount Gasket	1972-1978			K27363	1
-------------------------	-----------	--	--	--------	---

2	120 CID (2.0L) L-Head Ford 4 Cyl, 3.187in./80.95mm (1941-1942)					2
----------	---	--	--	--	--	----------

Part	Year	VIN	Model/Application	Part Number	Qty.
------	------	-----	-------------------	-------------	------

ENGINE GASKETS

Head Set	1941-1942			HS1950	1
Full Set	1941-1942			FS1950	1
Cylinder Head Gasket	1941-1942		VR2000	1950	1
Valve Cover Set	1941-1942			VS25809X	1
Manifold Set, Int. & Exh.	1941-1942			MS12155	1
Oil Pan Set	1941-1942		Cork Rubber	OS20507A	1

MISCELLANEOUS GASKETS

Fuel Pump Cover Gasket	1941-1942			D34545	1
------------------------	-----------	--	--	--------	---

3	121 CID (2.0L) Ford 4 Cyl, 3.516in./89.3mm (1983-1988)					3
----------	---	--	--	--	--	----------

Part	Year	VIN	Model/Application	Part Number	Qty.
------	------	-----	-------------------	-------------	------

ENGINE GASKETS

Head Set	1983-1988			HS4032	1	
Lower Set	1987-1988		(Requires Head Set To Make Full Set)	CS4032A	1	
	1983-1986		(Requires Head Set To Make Full Set, Rear Main Seal For Early 1983 Engines Not Included)	CS4032	1	
Engine Kit Gasket Set	1987-1988			95-3292VR	1	
	1986		From 7/15/86, (Valve Stem Seals Not Included), Use With Part Numbers B45404 (4), B45418 (4)	95-3375VR	1	
				Thru 7/15/86	95-3375VR	1
	1983-1985			95-3375VR	1	
Cylinder Head Gasket	1983-1988		VR2000	4032	1	
Cyl. Head Spacer Shim	1983-1988		Requires Sealing Compound Steel	4032S	1	
Sealing Compound	1983-1988		(4 Ounce Brush Top Can)	JV66B	1	
			(12 Ounce Spray Can)	JV66S	1	
Valve Cover Set	1983-1988		Cork Rubber	VS39751	1	
			High Temperature Cork Rubber	VS39751H	1	
			Victo-Tech	VS50208	1	
Valve Stem Seal, Exh.	1983-1988			B45404	4	
Valve Stem Seal, Int.	1983-1988		Fluoroelastomer	B45418	4	
Manifold Set, Exhaust	1983-1988			MS16048	1	
Manifold Set, Intake	1983-1988			MS15334	1	
Oil Pan Set	1987-1988		Victo-Tech	OS32464	1	
		1983-1986		Cork Rubber	OS30546	1
				Tuff-Cork	OS30546TC	1
Rear Main Seal Set	1984-1988			JV523	1	
			Teflon	JV1635	1	
	1983		Late, (1 Piece)	JV523	1	
			Early, (2 Piece)	Molded Rubber	JV730R	1
			Late, (1 Piece)	Teflon	JV1635	1
Timing Cover Set	1987-1988		(Auxiliary Shaft Seal Not Included)	JV1033	1	
	1983-1986		(Auxiliary Shaft Seal Not Included)	JV879	1	

MISCELLANEOUS GASKETS

Air Cleaner Mount Gasket	1987-1988		2 Barrel Carburetor	G31430	1
	1983-1986		1 Barrel Carburetor	G25936	1
Carb. Mount Gasket	1983-1986		1 Barrel Carburetor, Carburetor To Spacer	G26163	1

LIGHT TRUCK

3 121 CID (2.0L) Ford 4 Cyl, 3.516in./89.3mm (1983-1988) **3**
 (cont.) (cont.)

Part	Year	VIN	Model/Application	Part Number	Qty.
MISCELLANEOUS GASKETS (cont.)					
Carb. Mount Gasket (cont.)	1983-1986		1 Barrel Carburetor, Spacer To Manifold	G26254	1
E.G.R. Gasket	1983-1988			G26703	1
Exhaust Pipe Gasket	1983-1988		(Flange Type), Pipe To Converter	F14627	1
Fuel Pump Gasket	1983-1986			D27094	1
				Tuff-Cork	D27094TC
Water Outlet Gasket	1983-1988			C26681	1
Water Pump Mount Gasket	1983-1988			K27612	1

4 122 CID (2.0L) SOHC Mazda 4 Cyl, 3.150in./80mm (1979-1982) **4**

Part	Year	VIN	Model/Application	Part Number	Qty.
ENGINE GASKETS					
Head Set	1979-1982			HS3683	1
Full Set	1979-1982			FS3683	1
Engine Kit Gasket Set	1979-1982		(Exhaust Manifold Gasket Not Included), Use With Part Number MS12281	95-3366VR	1
Cylinder Head Gasket	1979-1982		Nitroseal	3683	1
Cyl. Head Spacer Shim	1979-1982		Requires Sealing Compound	Steel 3683S	1
Sealing Compound	1979-1982		(4 Ounce Brush Top Can)	JV66B	1
				(12 Ounce Spray Can)	JV66S
Valve Cover Set	1979-1982		(Camshaft Semi Circular Plug Not Included) Cork Rubber	VS39754	1
			(Camshaft Semi Circular Plug Not Included) Tuff-Cork	VS39754TC	1
			(Contains Camshaft Semi Circular Plug) Cork Rubber	VS39754W	1
			(Camshaft Semi Circular Plug Not Included) Victo-Tech	VS50144	1
Valve Stem Seal, Exh.	1980-1982			B45490	4
	1979	Thru 11/78		B45437	4
		From 11/78		B45490	4
Valve Stem Seal, Int.	1980-1982			B45490	4
	1979	Thru 11/78		B45437	4
		From 11/78		B45490	4
Manifold Set, Exhaust	1979-1982			MS12281	1
Manifold Set, Intake	1979-1982			MS85719	1
Oil Pan Set	1979-1982		Cork Rubber	OS30548	1
Rear Main Seal Set	1979-1982			JV627	1
Timing Cover Set	1979-1982			JV963	1

MISCELLANEOUS GASKETS					
Cam. Semi-Circular Plug	1979-1982		(Half Round), Front, Rear	B45450	2
Carb. Mount Gasket	1979-1982		2 Barrel Carburetor, Carburetor To Spacer, Spacer To Manifold	G26825	2
E.G.R. Gasket	1979-1982		Valve Adapter	G24843	1
			Valve	G24844	1
Exhaust Pipe Gasket	1979-1982		California, Canadian, (Flange Type), Pipe To Manifold	F7393	1
			1-15/16" Inside Diameter, (Flange Type), Muffler To Resonator, Pipe To Converter	F10027	1
			1-3/4" Inside Diameter, Muffler To Resonator	F10028	1
			Except California, United States, (Flange Type), Pipe To Manifold	F20282	1
Therm. Housing Gasket	1981-1982		Inner	C20384	1
	1980	Thru 5/80, Outer		C20136	1
		Thru 5/80, Inner		C20375	1
		From 5/80, Inner		C20384	1
		Outer		C20136	1
	1979	Inner		C20375	1

LIGHT TRUCK

Ford Truck

4	122 CID (2.0L) SOHC Mazda 4 Cyl, 3.150in./80mm (1979-1982)	4
(cont.)		(cont.)

Part	Year	VIN	Model/Application	Part Number	Qty.
------	------	-----	-------------------	-------------	------

MISCELLANEOUS GASKETS (cont.)

Water Pump Mount Gasket	1979-1982			K27363	1
-------------------------	-----------	--	--	--------	---

5	1989CC (2.0L) Zetec/DOHC/16 Valve Ford 4 Cyl, 3.339in./84.8mm (2001-2003)	5
----------	--	----------

Part	Year	VIN	Model/Application	Part Number	Qty.
------	------	-----	-------------------	-------------	------

ENGINE GASKETS

Cylinder Head Gasket	2001-2003		<i>Multi-Layered Steel</i>	54197	1
Cyl. Head Bolt Set	2001-2003			GS33376	1
Valve Cover Set	2001-2003			VS50314	1
Valve Stem Seal, Exh.	2001-2003			B45915	8
Valve Stem Seal, Int.	2001-2003			B45915	8
Oil Pan Set	2001-2003			OS32228	1

MISCELLANEOUS GASKETS

Throttle Body Gasket	2001-2003		<i>Victo-Tech</i>	G31609	1
----------------------	-----------	--	-------------------	--------	---

6	134 CID (2.2L) SOHC 8 Valve Mazda Diesel 4 Cyl, 3.500in./88.9mm (1983-1984)	6
----------	--	----------

Part	Year	VIN	Model/Application	Part Number	Qty.
------	------	-----	-------------------	-------------	------

ENGINE GASKETS

Head Set	1983-1984			HS3743	1
Valve Cover Set	1983-1984		<i>Victo-Tech</i>	VS39798	1
Valve Stem Seal, Int.	1983-1984			B45483	4
Rear Main Seal Set	1983-1984			JV529	1
Timing Cover Set	1983-1984			JV990	1

MISCELLANEOUS GASKETS

E.G.R. Gasket	1983-1984			G26703	1
Exhaust Pipe Gasket	1983-1984		(Flange Type), Pipe To Converter	F14627	1
Fuel Pump Gasket	1983-1984			D27094	1
				<i>Tuff-Cork</i>	D27094TC
Valve Cover Grommet	1983-1984			B45482	4
Water Outlet Gasket	1983-1984			C24553	1
Water Pump Mount Gasket	1984			K27630	1
	1983		Thru 10/82	K27612	1
				From 10/82	K27630

7	140 CID (2.3L) SOHC Ford 4 Cyl, 3.780in./96mm (1977-1997)	7
----------	--	----------

Part	Year	VIN	Model/Application	Part Number	Qty.
------	------	-----	-------------------	-------------	------

ENGINE GASKETS

Head Set	1995-1997			HS4029	1	
	1993-1994			HS5938	1	
	1989-1992			HS3519K	1	
	1988			HS3519P	1	
	1983-1987			HS3519X	1	
	1977-1982			(Exhaust Pipe Gasket Not Included)	HS3519	1
Lower Set	1995-1997		(Requires Head Set To Make Full Set)	CS5938B	1	
	1993-1994		(Requires Head Set To Make Full Set)	CS5938A	1	
Full Set	1989-1992			FS3519K	1	
	1988			FS3519P	1	
	1986-1987			FS3519R	1	
	1985			From 4/85	FS3519R	1
				Thru 4/85	FS3519X	1
	1983-1984			FS3519X	1	
	1982			(Exhaust Pipe Gasket Not Included)	FS3519W	1
1977-1981			(Exhaust Pipe Gasket Not Included)	FS3519	1	

LIGHT TRUCK

Part	Year	VIN	Model/Application	Part Number	Qty.	
ENGINE GASKETS (cont.)						
Engine Kit Gasket Set	1993-1994		(Oil Pan Gasket Not Included), Use With Part Number OS32481	95-3384VR	1	
	1989-1992		(Oil Pan Gasket Not Included), Use With Part Number OS32463	95-3384VR	1	
	1987-1988			95-3450VR	1	
	1986		Thru 7/15/86	95-3439VR	1	
			From 7/15/86	95-3450VR	1	
	1985		Thru 4/8/85, (Rear Main Seal Not Included, Intake Manifold Gasket Not Included), Use With Part Numbers MS15334, JV523	95-3360VR	1	
			From 4/8/85	95-3439VR	1	
	1983-1984		(Rear Main Seal Not Included, Intake Manifold Gasket Not Included), Use With Part Numbers MS15334, JV523	95-3360VR	1	
	1982		(Rear Main Seal Not Included), Use With Part Number JV523	95-3360VR	1	
	1981		From 9/28/81, (Rear Main Seal Not Included), Use With Part Number JV523	95-3360VR	1	
		Thru 9/28/81	95-3360VR	1		
1977-1980			95-3360VR	1		
			95-3360VR	1		
Cylinder Head Gasket	1977-1997		<i>VR2000</i>	4029	1	
			<i>Nitroseal</i>	4029SG	1	
Cyl. Head Bolt Set	1977-1997			GS33328	1	
Cyl. Head Spacer Shim	1977-1997		Requires Sealing Compound	<i>Steel</i> 4029S	1	
Sealing Compound	1977-1997		(4 Ounce Brush Top Can)	JV66B	1	
			(12 Ounce Spray Can)	JV66S	1	
Valve Cover Set	1977-1997		<i>Victo-Tech</i>	VS50208	1	
	1989-1994		<i>Cork Rubber</i>	VS39878	1	
	1977-1988		<i>Cork Rubber</i>	VS39751	1	
			<i>High Temperature Cork Rubber</i>	VS39751H	1	
Valve Stem Seal, Exh.	1995-1997			B45823	4	
	1977-1994			B45404	4	
Valve Stem Seal, Int.	1995-1997			B45823	4	
	1984-1994		<i>Fluoroelastomer</i>	B45418	4	
	1977-1983			B45404	4	
Manifold Set, Exhaust	1993-1997		<i>Nitroseal</i>	MS16104	1	
	1977-1992			MS16048	1	
Manifold Set, Intake	1995-1997		(Contains Plenum Chamber Gasket)	MS16128	1	
	1988-1994		(Contains Plenum Chamber Gasket)	MS15480	1	
	1985-1987		(Contains Plenum Chamber Gasket)	MS15582W	1	
	1983-1984			MS15334	1	
	1977-1982			MS15207X	1	
Plenum Chamber Gasket	1995-1997			MS16129	1	
	1989-1994			MS15547	1	
	1985-1988			MS14631	1	
Oil Pan Set	1993-1997		<i>Victo-Tech</i>	OS32481	1	
	1986-1992		<i>Victo-Tech</i>	OS32463	1	
	1985		Thru 4/85	<i>Cork Rubber</i>	OS30546	1
			Thru 4/85	<i>Tuff-Cork</i>	OS30546TC	1
			From 4/85	<i>Victo-Tech</i>	OS32463	1
	1977-1984			<i>Cork Rubber</i>	OS30546	1
			<i>Tuff-Cork</i>	OS30546TC	1	
Rear Main Seal Set	1995-1997			JV1612	1	
	1982-1994			JV523	1	
				<i>Teflon</i>	JV1635	1
	1977-1981		<i>Molded Rubber</i>	JV730R	1	
Crank Repair Sleeve	1983-1996		Use With Part Number A509, Rear Nickel Plated Formed Steel, .013" Thickness	A335	1	

LIGHT TRUCK

Ford Truck

7 140 CID (2.3L) SOHC Ford 4 Cyl, 3.780in./96mm (1977-1997) **7**
 (cont.) (cont.)

Part Year VIN Model/Application Part Number Qty.

ENGINE GASKETS (cont.)

Crank Repair Sleeve (cont.)	1982-1993		Front <i>Nickel Plated Formed Steel, .013" Thickness</i>	A349	1
Timing Cover Set	1993-1997		(Auxiliary Shaft Seal Not Included)	JV1175	1
	1990-1992		(Auxiliary Shaft Seal Not Included)	JV1116	1
	1986-1989		(Auxiliary Shaft Seal Not Included)	JV1033	1
	1985		From 4/85, (Auxiliary Shaft Seal Not Included)	JV1033	1
	1983-1985		Thru 4/85, (Auxiliary Shaft Seal Not Included)	JV879	1
	1977-1982		(Auxiliary Shaft Seal Not Included)	JV879	1

MISCELLANEOUS GASKETS

Air Cleaner Mount Gasket	1983-1987		Electronic Fuel Injection	G25936	1
	1977-1982		2 Barrel Carburetor	G31431	1
Carb. Mount Gasket	1983-1986		Electronic Fuel Injection, Carburetor To Spacer	G26163	1
			Electronic Fuel Injection, Spacer To Manifold	G26254	1
	1977-1982		2 Barrel Carburetor, Carburetor To Spacer	G26825	2
			2 Barrel Carburetor, Spacer To Manifold	G27308	1
Dist. Mounting Gasket	1990-1997		Ranger, (O-Ring Type)	72122	1
E.G.R. Gasket	1995-1997			G30625	1
	1993-1994			G26703	1
	1977-1983			G24844	1
Exhaust Pipe Gasket	1990-1995		Ranger, (Ring Type 'F'), Pipe To Converter	F10085	1
	1988		Ranger, Super Cab, (Flange Type), Pipe To Converter	F10085	1
			Ranger, Except Super Cab, (Flange Type), Pipe To Converter	F14627	1
	1986-1987		Aerostar, (Flange Type), Pipe To Converter	F12306	1
	1983-1986		Ranger, (Flange Type), Pipe To Converter	F14627	1
	1979-1982		Courier, (Flange Type), Pipe To Manifold	F7393	1
	1977-1982		Courier, (Flange Type), Pipe To Converter	F10027	1
Fuel Pump Gasket	1977-1987			D27094	1
			<i>Tuff-Cork</i>	D27094TC	1
Injector Nozzle O-Ring	1985-1997			GS33276	2
Throttle Body Gasket	1985-1997			G30942	1
Water Outlet Gasket	1977-1997			C26681	1
Water Pump Mount Gasket	1995-1997			K31355	1
	1977-1994			K27612	1

8 140 CID (2.3L) SOHC Mitsubishi Diesel 4 Cyl, 3.587in./91.1mm (1985-1987) **8**

Part Year VIN Model/Application Part Number Qty.

ENGINE GASKETS

Head Set	1985-1987		Turbocharged	HS3786	1
Full Set	1985-1987		Turbocharged	FS3786	1
Cylinder Head Gasket	1985-1987		Turbocharged	3786	1
Valve Cover Set	1985-1987		Turbocharged	<i>VR2000</i> <i>Victo-Tech</i> VS39371	1
Valve Stem Seal, Exh.	1985-1987		(Original Equipment Type), Turbocharged	B45441	4
Valve Stem Seal, Int.	1985-1987		(Original Equipment Type), Turbocharged	B45441	4
Manifold Set, Int. & Exh.	1985-1987		Turbocharged	MS15378	1
Oil Pan Set	1985-1987		Turbocharged	<i>Cork Rubber</i> OS20776	1
Rear Main Seal Set	1985-1987		Turbocharged	JV534	1
Timing Cover Set	1985-1987		Turbocharged	JV995	1

MISCELLANEOUS GASKETS

Camshaft Seal	1985-1987		Turbocharged	47918	1
E.G.R. Gasket	1985-1986		California, Turbocharged	G30710	1
Exhaust Pipe Gasket	1985-1986		(Flange Type), Turbocharged, Pipe To Converter	F14627	1
Water Inlet Gasket	1985-1987		Turbocharged	C26842	1

LIGHT TRUCK

8 140 CID (2.3L) SOHC Mitsubishi Diesel 4 Cyl, 3.587in./91.1mm (1985-1987) **8**
(cont.) (cont.)

Part	Year	VIN	Model/Application	Part Number	Qty.
MISCELLANEOUS GASKETS (cont.)					
Water Outlet Gasket	1985-1987		Turbocharged	C26846	1
Water Pump Mount Gasket	1985-1987		Turbocharged	K30620	1

9 144 CID (2.4L) Ford 6 Cyl, 3.500in./88.9mm (1960-1964) **9**

Part	Year	VIN	Model/Application	Part Number	Qty.
ENGINE GASKETS					
Head Set	1960-1964		(Exhaust Pipe Gasket Not Included)	HS3910VJ	1
Full Set	1960-1964		(Exhaust Pipe Gasket Not Included)	FS3910VJ	1
Engine Kit Gasket Set	1960-1964			95-3005VR	1
Cylinder Head Gasket	1960-1964		VR2000	3910VC	1
Valve Cover Set	1960-1964		Cork Rubber	VS39564	1
Valve Stem Seal, Exh.	1960-1964			B45320	6
Valve Stem Seal, Int.	1960-1964			B45320	6
Manifold Set, Exhaust	1960-1964			MS16035W	1
Oil Pan Set	1960-1964		Cork Rubber	OS30921	1
Rear Main Seal Set	1960-1964		Rope Packing	JV730	1
			Molded Rubber	JV730P	1
Timing Cover Set	1960-1964			JV820	1
			(Contains Repair Sleeve)	JV930	1
Harmonic Balancer Repair Sleeve	1960-1964		Ground Steel, .020" Thickness	66594RS	1
			Use With Part Number A504 Nickel Plated Formed Steel, .013" Thickness	A225	1

MISCELLANEOUS GASKETS					
Carb. Mount Gasket	1960-1964		1 Barrel Carburetor	G5260EK	1
Exhaust Pipe Gasket	1960-1964		(Flange Type), Pipe To Manifold	F5360C	1
Fuel Pump Bowl Gasket	1960-1964			D36016	1
Fuel Pump Gasket	1960-1964			D27094	1
			Tuff-Cork	D27094TC	1
Water Outlet Gasket	1960-1964			C24005	1
Water Pump Mount Gasket	1960-1964			K14119	1

10 153 CID (2.5L) SOHC Ford 4 Cyl, 3.780in./96mm (1998-2001) **10**

Part	Year	VIN	Model/Application	Part Number	Qty.
ENGINE GASKETS					
Cylinder Head Gasket	1998-2001		VR2000	4029	1
			Nitroseal	4029SG	1
Cyl. Head Bolt Set	1998-2001			GS33328	1
Valve Cover Set	1998-2001		Victo-Tech	VS50208	1
Valve Stem Seal, Exh.	1998			B45823	4
Valve Stem Seal, Int.	1998			B45823	4
Manifold Set, Intake	1998-2001		(Contains Plenum Chamber Gasket)	MS16128	1
Plenum Chamber Gasket	1998-2001			MS16129	1
Timing Cover Seal	1998-2001			47524	1
MISCELLANEOUS GASKETS					
Aux. Shaft Seal	1998-2001			47524	1
Camshaft Seal	1998-2001			47524	1
E.G.R. Gasket	1998-2001			G30625	1
Injector Nozzle O-Ring	1998-2001			GS33276	2
Throttle Body Gasket	1998-2001			G30942	1

Ford Truck

11 170 CID (2.8L) Ford 6 Cyl, 3.500in./88.9mm (1961-1972)

11

Part	Year	VIN	Model/Application	Part Number	Qty.
ENGINE GASKETS					
Head Set	1961-1972		(Exhaust Pipe Gasket Not Included)	HS3910VJ	1
Full Set	1961-1972		(Exhaust Pipe Gasket Not Included)	FS3910VJ	1
Engine Kit Gasket Set	1961-1972			95-3005VR	1
Cylinder Head Gasket	1961-1972		VR2000	3910VC	1
Valve Cover Set	1961-1972		Cork Rubber	VS39564	1
Valve Stem Seal, Exh.	1961-1972			B45320	6
Valve Stem Seal, Int.	1961-1972			B45320	6
Manifold Set, Exhaust	1961-1972			MS16035W	1
Oil Pan Set	1961-1972		Cork Rubber	OS30921	1
Rear Main Seal Set	1961-1972		Rope Packing	JV730	1
			Molded Rubber	JV730P	1
Timing Cover Set	1961-1972			JV820	1
			(Contains Repair Sleeve)	JV930	1
Timing Cover Seal	1961-1972			46244	1
Harmonic Balancer Repair Sleeve	1961-1972		Ground Steel, .020" Thickness	66594RS	1
			Use With Part Number A504 Nickel Plated Formed Steel, .013" Thickness	A225	1

MISCELLANEOUS GASKETS

Air Cleaner Mount Gasket	1965-1970		1 Barrel Carburetor	G25936	1
Carb. Mount Gasket	1970-1972		1 Barrel Carburetor, Carburetor To Spacer, Spacer To Manifold	G25498	1
			1 Barrel Carburetor, Spacer To Manifold	G5260EK	1
	1965-1969		1 Barrel Carburetor, Carburetor To Spacer	G26581	1
			Improved Combustion Emission Control System Or Carter Carburetor, 1 Barrel Carburetor	G26186	1
			1 Barrel Carburetor	G5260EK	1
Exhaust Pipe Gasket	1969-1972		Econoline E100, Econoline E200, (Ring Type 'C'), Pipe To Manifold	F17250	1
			Econoline E100, Econoline E200, (Ring Type 'B'), Pipe To Manifold Sintered Metal	F17250S	1
	1966-1972		Bronco, (Ring Type 'C'), Pipe To Manifold	F17250	1
			Bronco, (Ring Type 'B'), Pipe To Manifold Sintered Metal	F17250S	1
	1965-1972		Club Wagon E100, (Ring Type 'C'), Pipe To Manifold	F17250	1
			Club Wagon E100, (Ring Type 'B'), Pipe To Manifold Sintered Metal	F17250S	1
	1965-1967		P100, (Ring Type 'C'), Pipe To Manifold	F7355	1
			E100 Pickup, Econoline E100, (Ring Type 'C'), Pipe To Manifold	F17250	1
			E100 Pickup, Econoline E100, (Ring Type 'B'), Pipe To Manifold Sintered Metal	F17250S	1
	1965		E100 Station Bus, Falcon, (Ring Type 'C'), Pipe To Manifold	F17250	1
			E100 Station Bus, Falcon, (Ring Type 'B'), Pipe To Manifold Sintered Metal	F17250S	1
	1961-1964		(Flange Type), Pipe To Manifold	F5360C	1
Fuel Pump Bowl Gasket	1961-1972			D36016	1
Fuel Pump Gasket	1961-1972			D27094	1
			Tuff-Cork	D27094TC	1
Water Outlet Gasket	1961-1972			C24005	1
Water Pump Mount Gasket	1961-1972			K14119	1

12 171 CID (2.8L) German Ford V6 Cyl, 3.661in./93mm (1983-1986)

12

Part	Year	VIN	Model/Application	Part Number	Qty.
ENGINE GASKETS					
Head Set	1986		Aerostar, (Exhaust Manifold Gasket Not Included)	HS3778	1
	1984-1986		Bronco II	HS3778	1

12 171 CID (2.8L) German Ford V6 Cyl, 3.661in./93mm (1983-1986) **12**
(cont.) (cont.)

Part	Year	VIN	Model/Application	Part Number	Qty.
ENGINE GASKETS (cont.)					
Head Set (cont.)	1983-1986		Ranger	HS3778	1
Full Set	1986		Aerostar, (Exhaust Manifold Gasket Not Included)	FS3778	1
	1984-1986		Bronco II	FS3778	1
	1983-1986		Ranger	FS3778	1
Engine Kit Gasket Set	1983-1986			95-3369VR	1
Cylinder Head Gasket	1983-1986		Left VR2000	3778	1
			Right VR2000	3779	1
Valve Cover Set	1983-1986		Cork Rubber	VS39761	1
Valve Stem Seal, Exh.	1983-1986			B45900	6
Valve Stem Seal, Int.	1983-1986			B45900	6
Manifold Set, Exhaust	1986		Aerostar	MS12369	1
	1984-1986		Bronco II	MS12304	1
	1983-1986		Ranger	MS12304	1
Manifold Set, Intake	1983-1986			MS15754	1
Oil Pan Set	1983-1986		Cork Rubber	OS30555	1
Rear Main Seal Set	1983-1986			JV617	1
Crank Repair Sleeve	1983-1986		Use With Part Number A511, Rear Nickel Plated Formed Steel, .013" Thickness	A341	1
Timing Cover Set	1983-1986			JV1011	1

MISCELLANEOUS GASKETS

Air Cleaner Mount Gasket	1983-1986		2 Barrel Carburetor	G27098	1
Carb. Mount Gasket	1986		2 Barrel Carburetor, Carburetor To Spacer	G30994	1
	1983-1986		2 Barrel Carburetor, Spacer To Manifold	G25701	1
Exhaust Air Supply Tube	1983-1986			B45570	1
E.G.R. Gasket	1983-1986			G26702	1
Exhaust Pipe Gasket	1986		Aerostar, (Flange Type), Pipe To Converter	F12306	1
	1984-1985		Bronco II, (Flange Type), Pipe To Converter	F14627	1
	1983-1985		Ranger, (Flange Type), Pipe To Converter	F14627	1
Fuel Pump Gasket	1983-1986			D27130	1
Thermostat Seal	1983-1986		Victo-Tech	C45407	1
Water Outlet Gasket	1983-1986		Lower Front	C26195	1
			Lower Rear	C26198	1
			Upper	C26677	1
Water Pump Mount Gasket	1983-1986			K27982	1

13 177 CID (2.9L) OHV Ford V6 Cyl, 3.661in./93mm (1986-1992) **13**

Part	Year	VIN	Model/Application	Part Number	Qty.
ENGINE GASKETS					
Head Set	1986-1992		(Head Bolts Not Included, Intake Manifold Gasket Not Included)	HS5721	1
			(Contains Head Bolts, Intake Manifold Gasket Not Included)	HS5721WB	1
Full Set	1986-1992		(Intake Manifold Gasket Not Included)	FS5721	1
Engine Kit Gasket Set	1986-1992			95-3294VR	1
Cylinder Head Gasket	1986-1992		Left VR2000	5721	1
			Right VR2000	5722	1
Cyl. Head Bolt Set	1986-1992			GS33221	2
Valve Cover Set	1986-1992		Cork Rubber	VS50014	1
			Victo-Tech	VS50014R	1
Valve Stem Seal, Exh.	1986-1992			B45900	6
Valve Stem Seal, Int.	1986-1992			B45900	6
Manifold Set, Exhaust	1986-1992			MS15429	1
Manifold Set, Intake	1986-1992		(Contains Plenum Chamber Gasket)	MS15702	1
Plenum Chamber Gasket	1986-1992			MS14629	1

Ford Truck

13 (cont.)	177 CID (2.9L) OHV Ford V6 Cyl, 3.661in./93mm (1986-1992)	13 (cont.)
----------------------	--	----------------------

Part	Year	VIN	Model/Application	Part Number	Qty.
ENGINE GASKETS (cont.)					
Oil Pan Set	1987-1992		<i>Victo-Tech</i>	OS32466	1
	1986		Thru 10/15/85 <i>Cork Rubber</i>	OS30555	1
			From 10/15/85 <i>Victo-Tech</i>	OS32466	1
Rear Main Seal Set	1986-1992			JV617	1
Crank Repair Sleeve	1986-1992		Use With Part Number A511, Rear <i>Nickel Plated Formed Steel, .013" Thickness</i>	A341	1
Timing Cover Set	1986-1992			JV1037	1

MISCELLANEOUS GASKETS

E.G.R. Gasket	1986-1992			G30625	1
Exhaust Pipe Gasket	1988-1992		(Flange Type), Inlet Pipe To Catalytic Converter	F14763	1
	1988-1989		(Ring Type 'F'), Catalytic Converter To Muffler Inlet Pipe	F10085	1
	1986-1989		(Flange Type), Catalytic Converter To Muffler	F14627	1
	1986-1987		(Flange Type), Inlet Pipe To Catalytic Converter	F14150	1
Injector Nozzle O-Ring	1991-1992			GS33276	3
Thermostat Seal	1986-1992		<i>Victo-Tech</i>	C31138	1
Throttle Body Gasket	1986-1992			G30943	1
Water Pump Mount Gasket	1986-1992			K30678	1

14	181 CID/2967CC (3.0L) Duratec/DOHC/24 Valve Ford V6 Cyl, 3.504in./89mm (2001-2003)	14
-----------	---	-----------

Part	Year	VIN	Model/Application	Part Number	Qty.
ENGINE GASKETS					
Head Set	2001-2002		(Head Bolts Not Included)	HS54363B	1
Lower Set	2001-2003		(Requires Head Set To Make Full Set)	CS5990A	1
Cylinder Head Gasket	2001-2002		Right <i>Multi-Layered Steel</i>	54363	1
			Left <i>Multi-Layered Steel</i>	54364	1
Cyl. Head Bolt Set	2001-2003			GS33388	2
Valve Cover Set	2001-2003		(Contains Valve Cover Grommets, Contains Spark Plug Tube Seals) <i>Victo-Tech</i>	VS50336	1
Valve Stem Seal, Exh.	2001-2003			B45837	12
Valve Stem Seal, Int.	2001-2003			B45837	12
Manifold Set, Exhaust	2001-2003			MS12415	2
Manifold Set, Intake	2001-2003		(Contains Plenum Chamber Gasket) <i>Victo-Tech</i>	MS16359	1
Plenum Chamber Gasket	2001-2003		<i>Victo-Tech</i>	MS16360	1
Oil Pan Set	2001-2003		Lower <i>Victo-Tech</i>	OS32244	1
Rear Main Seal Set	2001-2003			JV1612	1
Timing Cover Set	2001-2003		<i>Victo-Tech</i>	JV5026	1

MISCELLANEOUS GASKETS

E.G.R. Gasket	2001-2003			G30625	1
Water Outlet Gasket	2001-2003			C31302	1

15	183 CID (3.0L) OHV Ford V6 Cyl, 3.504in./89mm (1986-2003)	15
-----------	--	-----------

Part	Year	VIN	Model/Application	Part Number	Qty.
ENGINE GASKETS					
Head Set	1999		Windstar, Thru 7/27/99, (Head Bolts Not Included)	HS5891	1
	1998		Windstar, Thru 7/13/98, (Contains Head Bolts)	HS5891WB	1
	1995-1998		Windstar, (Head Bolts Not Included)	HS5891	1
	1995-1997		Windstar, (Contains Head Bolts)	HS5891WB	1
	1993-1995		(Contains Head Bolts)	HS5752WB1	1
			(Head Bolts Not Included)	HS5885	1
	1992		Aerostar, Ranger, Thru 10/21/91, (Head Bolts Not Included)	HS5752	1
			From 10/21/91, (Contains Head Bolts)	HS5752WB1	1
			From 3/27/90, (Contains Head Bolts)	HS5752WB1	1
		Aerostar, Thru 10/21/91, (Contains Head Bolts)	HS5752WB1	1	

Part	Year	VIN	Model/Application	Part Number	Qty.
ENGINE GASKETS (cont.)					
Head Set (cont.)	1992		From 10/21/91, (Head Bolts Not Included)	HS5885	1
			From 3/27/90, (Head Bolts Not Included)	HS5885	1
	1991-1992		Ranger, Thru 10/21/91, (Contains Head Bolts)	HS5752WB1	1
	1991		Aerostar, Engine Code IG576, 577BA, (Head Bolts Not Included)	HS5752	1
			Ranger, (Head Bolts Not Included)	HS5752A	1
			Aerostar, Engine Code IG576, 577AA, CA, (Head Bolts Not Included)	HS5752A	1
			Aerostar, Engine Code IG576, 577AA, CA, (Contains Head Bolts)	HS5752WB1	1
			Aerostar, Engine Code IG576, 577BA, (Contains Head Bolts)	HS5752WB	1
			Ranger, (Head Bolts Not Included)	HS5752	1
	1990		Ranger, (Contains Head Bolts)	HS5752WB	1
			Ranger, (Contains Head Bolts)	HS5752WB	1
	1986-1990		Aerostar, (Head Bolts Not Included)	HS5752	1
			Aerostar, (Contains Head Bolts)	HS5752WB	1
	Lower Set	1991-1999		(Requires Head Set To Make Full Set)	CS5891
1990			From 3/27/90, (Requires Head Set To Make Full Set)	CS5891	1
Full Set	1992		Aerostar, Ranger, Thru 10/21/91	FS5752B	1
			From 10/21/91	FS5885	1
			From 3/27/90	FS5885	1
	1991-1992		Aerostar, Engine Code IG576, 577AA, CA, Thru 10/21/91	FS5752B	1
	1991		Aerostar, Engine Code IG576, 577BA	FS5752A	1
			Ranger	FS5752B	1
	1990		Thru 3/27/90	FS5752	1
			Aerostar, Engine Code IG576, 577BA, From 3/27/90	FS5752A	1
			Ranger, From 3/27/90	FS5752A	1
	1986-1989			FS5752	1
	Engine Kit Gasket Set	1999		Windstar, Thru 7/27/99	95-3473VR
1995-1998			Windstar	95-3473VR	1
1990			From 3/27/90, (Oil Pan Gasket Not Included), Use With Part Number OS32486	95-3295VR	1
			Thru 3/27/90	95-3295VR	1
1986-1989				95-3295VR	1
Cylinder Head Gasket	1990-2001		Ranger, Right Nitroseal	5926	1
			Ranger, Left Nitroseal	5927	1
	1995-2000		Windstar Nitroseal	5891	2
	1986-1997		Aerostar, Right Nitroseal	5926	1
			Aerostar, Left Nitroseal	5927	1
Cyl. Head Bolt Set	1999-2001			GS33359	2
	1998		Thru 7/13/98	GS33220	2
			From 7/13/98	GS33359	2
	1986-1997			GS33220	2
Cyl. Head Spacer Shim	1999-2000		Windstar, Requires Sealing Compound Steel	5891S	2
	1995-1997		Windstar, Requires Sealing Compound Steel	5891S	2
Sealing Compound	1995-2000		(4 Ounce Brush Top Can)	JV66B	1
			(12 Ounce Spray Can)	JV66S	1
Valve Cover Set	1990-2001			Victo-Tech VS50145	1
	1991-1993		Ranger	Victo-Tech VS50145	1
	1991-1992		Aerostar, Engine Code IG576, 577AA, CA	Victo-Tech VS50145	1
	1991		Aerostar, Engine Code IG576, 577BA	Tuff-Cork VS50028TC	1
			Aerostar, Engine Code IG576, 577BA, (Single Valve Cover)	Tuff-Cork VS50130TC	2
			Aerostar, Engine Code IG576, 577BA	Victo-Tech VS50197	1
			Aerostar, Engine Code IG576, 577BA, (Single Valve Cover)	Victo-Tech VS50197S	2
	1990		Ranger	Tuff-Cork VS50028TC	1

LIGHT TRUCK

Ford Truck

15 183 CID (3.0L) OHV Ford V6 Cyl, 3.504in./89mm (1986-2003) **15**
 (cont.) (cont.)

Part	Year	VIN	Model/Application	Part Number	Qty.
ENGINE GASKETS (cont.)					
Valve Cover Set (cont.)	1990		Ranger, (Single Valve Cover) <i>Tuff-Cork</i>	VS50130TC	2
			Ranger <i>Victo-Tech</i>	VS50197	1
			Ranger, (Single Valve Cover) <i>Victo-Tech</i>	VS50197S	2
	1986-1990		Aerostar <i>Tuff-Cork</i>	VS50028TC	1
			Aerostar, (Single Valve Cover) <i>Tuff-Cork</i>	VS50130TC	2
			Aerostar <i>Victo-Tech</i>	VS50197	1
			Aerostar, (Single Valve Cover) <i>Victo-Tech</i>	VS50197S	2
Valve Stem Seal, Exh.	2000-2001		7mm Valve Stem Diameter	B45908	6
	1999		8mm Valve Stem Diameter, Thru 7/27/99	B45576	6
			7mm Valve Stem Diameter, From 7/27/99	B45908	6
	1986-1998			B45576	6
Valve Stem Seal, Int.	2000-2001		7mm Valve Stem Diameter	B45907	6
	1999		8mm Valve Stem Diameter, Thru 7/27/99	B45575	6
			7mm Valve Stem Diameter, From 7/27/99	B45907	6
	1986-1998			B45575	6
Manifold Set, Exhaust	1986-1999			MS15426	1
Manifold Set, Intake	1986-2003		(Contains Plenum Chamber Gasket)	MS16068	1
Plenum Chamber Gasket	1986-2003			MS15404	1
Oil Pan Set	1991-2000		<i>Victo-Tech</i>	OS32486	1
	1990		Thru 3/27/90 <i>Victo-Tech</i>	OS32465	1
			From 3/27/90 <i>Victo-Tech</i>	OS32486	1
	1986-1989		<i>Victo-Tech</i>	OS32465	1
Rear Main Seal	1986-2001			47753	1
Rear Main Seal Set	1986-2001			JV555	1
			(Optional) <i>Teflon</i>	JV1638	1
Crank Repair Sleeve	1986-1996		Use With Part Number A507, Rear <i>Nickel Plated Formed Steel, .013" Thickness</i>	A340	1
Timing Cover Set	1995-2000			JV1179	1
	1986-1994			JV1032	1
Timing Cover Seal	1986-2000			46293	1
Harmonic Balancer Repair Sleeve	1986-1996		Use With Part Number A502, Front <i>Nickel Plated Formed Steel, .013" Thickness</i>	A235	1
MISCELLANEOUS GASKETS					
Dist. Mounting Gasket	1991-1998		Ranger	72025	1
	1991-1997		Aerostar	72025	1
E.G.R. Gasket	1996-2000		Windstar	G30625	1
	1997		Ranger	G30625	1
	1993-1997			G26703	1
Exhaust Pipe Gasket	1999-2000		Windstar, (Flange Type), Catalytic Converter To Muffler	F12438	1
	1995-1997		Windstar, (Flange Type), Catalytic Converter To Muffler	F12438	1
	1991-1995		Aerostar, (Flange Type), Catalytic Converter To Muffler	F14627	1
	1993-1994		Ranger, (Ring Type 'F'), Catalytic Converter To Muffler	F10085	1
	1990		Ranger, (Flange Type), Catalytic Converter To Muffler	F14627	1
	1989		Thru 5/89, (Flange Type), Catalytic Converter To Muffler	F12306	1
			Aerostar, From 5/89, (Flange Type), Catalytic Converter To Muffler	F14627	1
1986-1988		(Flange Type), Catalytic Converter To Muffler	F12306	1	
Injector Nozzle O-Ring	1986-1999			GS33276	3
Therm. Housing Gasket	1995-1999		Windstar	C30649	1
	1990-1997		Ranger	C30719	1
	1987-1997		Aerostar	C30719	1
Throttle Body Gasket	1991-2001		Ranger <i>Paper</i>	G31437	1
	1994-2000		Windstar <i>Paper</i>	G31437	1
Water Pump Mount Gasket	1995-2000		Windstar	K39114	1

LIGHT TRUCK

15 183 CID (3.0L) OHV Ford V6 Cyl, 3.504in./89mm (1986-2003) **15**
(cont.) (cont.)

Part	Year	VIN	Model/Application	Part Number	Qty.
MISCELLANEOUS GASKETS (cont.)					
Water Pump Mount Gasket (cont.)	1990-1997		Ranger	K30629	1
	1986-1997		Aerostar	K30629	1

16 2960CC (3.0L) VG30E SOHC Nissan V6 Cyl, 3.425in./87mm (1993-1998) **16**

Part	Year	VIN	Model/Application	Part Number	Qty.
ENGINE GASKETS					
Cylinder Head Gasket	1993-1998		Nitroseal	5826	2
Valve Cover Set	1993-1998		(Valve Cover Grommets Not Included) Victo-Tech	VS38376	1
Manifold Set, Exhaust	1994-1998			MS12442	1
	1993			MS15364	1
Manifold Set, Intake	1993-1996			MS15362W	1
Oil Pan Set	1993-1998		(Requires RTV) Victo-Tech	OS32080	1
MISCELLANEOUS GASKETS					
E.G.R. Gasket	1993-1997			G31442	1
Exhaust Pipe Gasket	1993-1995		(Flange Type), Catalytic Converter	F7434	1
	1993		(Ring Type 'A'), Pipe To Manifold	F7479	2
Therm. Mount Gasket	1993-1998		Left, Outer	C39115	1
			Inner, Left	C39116	1
			Right	C39117	1

17 200 CID (3.3L) L-Head Ford 4 Cyl, 3.875in./98.4mm (1933-1934) **17**

Part	Year	VIN	Model/Application	Part Number	Qty.
ENGINE GASKETS					
Manifold Set, Int. & Exh.	1933-1934		Models A, AA, BB	MS9800	1

18 200 CID (3.3L) OHV Ford 6 Cyl, 3.680in./93.5mm (1965-1974) **18**

Part	Year	VIN	Model/Application	Part Number	Qty.
ENGINE GASKETS					
Head Set	1973-1974		(Exhaust Pipe Gasket Not Included)	HS3910VJ	1
	1965-1968		(Exhaust Pipe Gasket Not Included)	HS3910VJ	1
Full Set	1973-1974		(Exhaust Pipe Gasket Not Included)	FS3910VJ	1
	1965-1968		(Exhaust Pipe Gasket Not Included)	FS3910VJ	1
Engine Kit Gasket Set	1973-1974			95-3005VR	1
Cylinder Head Gasket	1973-1974		VR2000	3910VC	1
	1965-1968		VR2000	3910VC	1
Valve Cover Set	1973-1974		Cork Rubber	VS39564	1
	1965-1968		Cork Rubber	VS39564	1
Valve Stem Seal, Exh.	1973-1974			B45320	6
	1965-1968			B45320	6
Valve Stem Seal, Int.	1973-1974			B45320	6
	1965-1968			B45320	6
Manifold Set, Exhaust	1973-1974			MS16035W	1
	1965-1968			MS16035W	1
Oil Pan Set	1973-1974		Cork Rubber	OS30921	1
	1965-1968		Cork Rubber	OS30921	1
Rear Main Seal Set	1973-1974		Rope Packing	JV730	1
			Molded Rubber	JV730P	1
	1965-1968		Rope Packing	JV730	1
			Molded Rubber	JV730P	1
Timing Cover Set	1973-1974			JV820	1
			(Contains Repair Sleeve)	JV930	1
	1965-1968			JV820	1

LIGHT TRUCK

Ford Truck

18 200 CID (3.3L) OHV Ford 6 Cyl, 3.680in./93.5mm (1965-1974) **18**
 (cont.) (cont.)

Part Year VIN Model/Application Part Number Qty.

ENGINE GASKETS (cont.)

Timing Cover Set (cont.)	1965-1968		(Contains Repair Sleeve)	JV930	1
Harmonic Balancer Repair Sleeve	1973-1974		Front	66594RS	1
	1965-1968		Use With Part Number A504, Front	A225	1
		Front	66594RS	1	
					<i>Ground Steel, .020" Thickness</i>
			Use With Part Number A504, Front	A225	1
			<i>Nickel Plated Formed Steel, .013" Thickness</i>		

MISCELLANEOUS GASKETS

Air Cleaner Mount Gasket	1973-1974		1 Barrel Carburetor	G25936	1
	1965-1968		1 Barrel Carburetor	G25936	1
E.G.R. Gasket	1973-1974			G26701	1
Exhaust Pipe Gasket	1973-1974		(Ring Type 'C'), Pipe To Manifold	F17250	1
			(Ring Type 'B'), Pipe To Manifold	<i>Sintered Metal</i> F17250S	1
	1968		(Ring Type 'C'), Pipe To Manifold	F17250	1
			(Ring Type 'B'), Pipe To Manifold	<i>Sintered Metal</i> F17250S	1
	1965-1967		(Ring Type 'C'), Pipe To Manifold	F7355	1
Fuel Pump Bowl Gasket	1973-1974			D36016	1
	1965-1968			D36016	1
Fuel Pump Gasket	1973-1974			D27094	1
				<i>Tuff-Cork</i> D27094TC	1
	1965-1968			D27094	1
				<i>Tuff-Cork</i> D27094TC	1
Water Outlet Gasket	1973-1974			C24005	1
	1965-1968			C24005	1
Water Pump Mount Gasket	1973-1974			K14119	1
	1965-1968			K14119	1

19 215 CID (3.5L) Ford 6 Cyl, 3.563in./90.5mm (1952-1953) **19**

Part Year VIN Model/Application Part Number Qty.

ENGINE GASKETS

Head Set	1952-1953		(O-Ring Type Valve Seals Not Included)	HS3264VW	1
Full Set	1952-1953		(O-Ring Type Valve Seals Not Included)	FS3264VW	1
Cylinder Head Gasket	1952-1953			<i>VR2000</i> 3264VC	1
Valve Cover Set	1952-1953			<i>Cork Rubber</i> VS39683	1
Valve Stem Seal, Exh.	1952-1953		(O-Ring Type)	B45229	6
			(Umbrella Type)	B45283	6
Valve Stem Seal, Int.	1952-1953		(O-Ring Type)	B45229	6
			(Umbrella Type)	B45283	6
Manifold Set, Intake	1952-1953			MS9997	1
Manifold Set, Int. & Exh.	1952-1953		(One Piece)	MS16037X	1
Oil Pan Set	1952-1953			<i>Cork Rubber</i> OS31570	1
Rear Main Seal Set	1952-1953			<i>Rope Packing</i> JV683	1
				<i>Molded Rubber</i> JV683P	1
Timing Cover Set	1952-1953			JV842	1
Timing Cover Seal	1952-1953			46293	1

MISCELLANEOUS GASKETS

Carb. Mount Gasket	1952-1953		1 Barrel Carburetor	G5260EK	1
Exhaust Pipe Gasket	1952-1953		(Flange Type), Pipe To Manifold	F5451K	1
Fuel Pump Gasket	1952-1953			D27094	1
				<i>Tuff-Cork</i> D27094TC	1

LIGHT TRUCK

19 215 CID (3.5L) Ford 6 Cyl, 3.563in./90.5mm (1952-1953) **19**
(cont.) (cont.)

Part	Year	VIN	Model/Application	Part Number	Qty.
MISCELLANEOUS GASKETS (cont.)					
Push Rod Cover Grommet	1952-1953			B45317	4
Push Rod Cover Set	1952-1953			PS39563	1
Valve Cover Grommet	1952-1953			B45317	2
Water Outlet Gasket	1952-1953			C25435	1
Water Pump Mount Gasket	1952-1953			K25856	1

20 221 CID (3.6L) Ford V8 Cyl, 3.063in./77.8mm (1932-1942) **20**

Part	Year	VIN	Model/Application	Part Number	Qty.
ENGINE GASKETS					
Cylinder Head Gasket	1932-1938		21 Stud Head	VR2000 1002K	2
Valve Cover Set	1932-1942			Cork Rubber VS18765	1
Manifold Set, Exhaust	1932-1942			MS5278AK	1
Oil Pan Set	1932-1942			Cork Rubber OS31242	1
Rear Main Seal Set	1938-1942		24 Stud Head	JV674	1
Timing Cover Set	1932-1942			JV762	1

21 223 CID (3.7L) Ford 6 Cyl, 3.625in./92.1mm (1954-1964) **21**

Part	Year	VIN	Model/Application	Part Number	Qty.
ENGINE GASKETS					
Head Set	1954-1964		(Contains Multiple Piece Intake Manifold Gasket)	HS3264VW	1
Full Set	1954-1964		(Contains Multiple Piece Intake Manifold Gasket)	FS3264VW	1
Cylinder Head Gasket	1954-1964			VR2000 3264VC	1
Valve Cover Set	1960-1964			Cork Rubber VS39565	1
	1954-1959			Cork Rubber VS39683	1
Valve Stem Seal, Exh.	1954-1964			B45283	6
Valve Stem Seal, Int.	1954-1964			B45283	6
Manifold Set, Intake	1954-1964			MS9997	1
Manifold Set, Int. & Exh.	1954-1964		(One Piece)	MS16037X	1
Oil Pan Set	1954-1964			Cork Rubber OS31570	1
Rear Main Seal Set	1954-1964			Rope Packing JV683	1
				Molded Rubber JV683P	1
Timing Cover Set	1957-1964			JV818	1
	1954-1956			JV842	1
Timing Cover Seal	1954-1964			46293	1

MISCELLANEOUS GASKETS

Carb. Mount Gasket	1954-1964		1 Barrel Carburetor	G5260EK	1
Exhaust Pipe Gasket	1954-1964		(Flange Type), Pipe To Manifold	F5451K	1
Fuel Pump Bowl Gasket	1955-1964			D36016	1
	1954			D35288	1
Fuel Pump Gasket	1954-1964			D27094	1
				Tuff-Cork D27094TC	1
Oil Pan Drain Plug Gst.	1958-1963			2066A	1
Push Rod Cover Grommet	1954-1964			B45317	4
Push Rod Cover Set	1954-1964			PS39563	1
Valve Cover Grommet	1954-1964			B45317	4
Water Outlet Gasket	1954-1964			C25435	1
Water Pump Mount Gasket	1954-1964			K25856	1

Ford Truck

22 232 CID (3.8L) Ford V6 Cyl, 3.811in./96.8mm (1982-2003)

22

Part	Year	VIN	Model/Application	Part Number	Qty.
ENGINE GASKETS					
Head Set	1999		(Head Bolts Not Included)	HS54175D	1
	1998		From 1/15/98, (Head Bolts Not Included, Contains 4mm Thick Intake Manifold Gasket)	HS54175A	1
			Thru 1/15/98, (Head Bolts Not Included, Contains 3mm Thick Intake Manifold Gasket)	HS54175C	1
	1997		(Head Bolts Not Included)	HS54175C	1
	1996		(Head Bolts Not Included)	HS54171	1
	1995			HS5786A	1
	1982-1983		(Head Bolts Not Included)	HS3677	1
			(Contains Head Bolts)	HS3677WB	1
Lower Set	1995-1999		(Requires Head Set To Make Full Set)	CS5815	1
Full Set	1982-1983			FS3677W	1
Engine Kit Gasket Set	1995			95-3476VR	1
	1982-1983		(Intake Manifold Gasket Not Included), Use With Part Number MS15296	95-3363VR	1
Cylinder Head Gasket	1997-2001	Right	<i>Multi-Layered Steel</i>	54175	1
		Left	<i>Multi-Layered Steel</i>	54176	1
	1996		<i>Nitroseal</i>	54171	2
	1995		<i>Nitroseal</i>	5786	2
	1982-1983		<i>Nitroseal</i>	5816	2
Cyl. Head Bolt Set	1996-2001			GS33317	2
	1995			GS33219	2
	1982-1983			GS33194	2
Cyl. Head Spacer Shim	1995		Requires Sealing Compound	<i>Steel</i> 5786S	2
Sealing Compound	1995-1997		(4 Ounce Brush Top Can)	JV66B	1
			(12 Ounce Spray Can)	JV66S	1
	1982-1983		(4 Ounce Brush Top Can)	JV66B	1
			(12 Ounce Spray Can)	JV66S	1
Valve Cover Set	1995-2003		(Single Valve Cover)	<i>Victo-Tech</i> VS50202S	2
	1995-2001			<i>Victo-Tech</i> VS50202	1
			(Contains Valve Cover Grommets)	<i>Victo-Tech</i> VS50202A	1
	1982-1983			<i>Cork Rubber</i> VS39254	1
Valve Stem Seal, Exh.	1999-2001			B45906	6
	1996-1998			B45823	6
	1995			B45547	6
	1982-1983			B45399	6
Valve Stem Seal, Int.	1999-2001			B45906	6
	1996-1998			B45823	6
	1995			B45547	6
	1982-1983			B45399	6
Manifold Set, Exhaust	1996-1998		<i>Nitroseal</i>	MS16171	1
Manifold Set, Intake	2000-2002		(Contains Plenum Chamber Gasket)	<i>Victo-Tech</i> MS16230-1	1
	1999		(Contains Plenum Chamber Gasket)	<i>Victo-Tech</i> MS16294	1
	1998		From 1/15/98, (Contains Plenum Chamber Gasket)	<i>Victo-Tech</i> MS16233	1
			Thru 1/15/98, (Contains Plenum Chamber Gasket)	<i>Victo-Tech</i> MS16233-2	1
	1996-1997		(Contains Plenum Chamber Gasket)	<i>Victo-Tech</i> MS16233-2	1
	1995		(Contains Plenum Chamber Gasket)	MS15451	1
1982-1983			MS15296	1	
Plenum Chamber Gasket	1999-2002		<i>Victo-Tech</i>	MS16293	1
	1996-1998		<i>Victo-Tech</i>	MS16288	1
	1995			MS15975	1
Oil Pan Set	2001			OS32236	1
	2000		Engine Tags OK-542-CA, OD-546-CA	OS32236	1
			Except Engine Tags OK-542-CA, OD-546-CA	OS32524	1
	1995-1999			OS32524	1

LIGHT TRUCK

22 232 CID (3.8L) Ford V6 Cyl, 3.811in./96.8mm (1982-2003) **22**
(cont.) (cont.)

Part	Year	VIN	Model/Application	Part Number	Qty.	
ENGINE GASKETS (cont.)						
Oil Pan Set (cont.)	1982-1983		Cork Rubber	OS30592	1	
Rear Main Seal Set	1995-2001			JV523	1	
			Teflon	JV1635	1	
	1983		From 1/1/83	JV523	1	
			Thru 1/1/83	Rope Packing	JV730	1
			Thru 1/1/83	Molded Rubber	JV730R	1
	1982			Rope Packing	JV730	1
			Molded Rubber	JV730R	1	
Crank Repair Sleeve	1995-1996		Use With Part Number A505, Rear Nickel Plated Formed Steel, .013" Thickness	A331	1	
	1982-1983		Use With Part Number A505, Rear Nickel Plated Formed Steel, .013" Thickness	A331	1	
Timing Cover Set	1999-2001		Performaseal	JV5012	1	
	1995-1998			JV1073	1	
	1982-1983			JV979	1	
			(Contains Repair Sleeve)		JV1132	1
Timing Cover Gasket	1997-2001		Performaseal	T31565	1	
Timing Cover Seal	1995-2001			46293	1	
	1982-1983			46293	1	
Harmonic Balancer Repair Sleeve	1982-1983		Use With Part Number A502, Front Nickel Plated Formed Steel, .013" Thickness	A226-2	1	

MISCELLANEOUS GASKETS

Air Cleaner Mount Gasket	1982-1983		2 Barrel Carburetor	G27098	1
Carb. Mount Gasket	1982-1983		2 Barrel Carburetor, Carburetor To Spacer	G26864	1
			2 Barrel Carburetor, Spacer To Manifold	G26865	1
Dist. Mounting Gasket	1996-2001		(O-Ring Type)	72122	1
	1995		(O-Ring Type)	72025	1
E.G.R. Gasket	1995-2001			G30625	1
	1982-1983		Between Adapter And Spacer	G24669	1
			Valve Adapter	G26702	1
Exhaust Pipe Gasket	1995-2001		(Flange Type), Catalytic Converter To Muffler	F12438	1
Fuel Pump Gasket	1982-1983			D27094	1
				Tuff-Cork	D27094TC
Oil Cooler Seal	1996-2003		Victo-Tech	B31615	1
Oil Filter Gasket	1982-1983		Adapter To Pump	B45826	1
Throttle Body Gasket	1995-2001		Paper	G31437	1
Throttle Body O-ring	1996-2001			G31574	1
Water Outlet Gasket	1995-2001			C26961	1
	1982-1983			C26961	1
Water Pump Gasket	1996-2001			K31566	1
Water Pump Mount Gasket	1995			K31010	1
	1982-1983			K27665	1

23 239 CID (3.9L) L-Head Ford V8 Cyl, 3.188in./80.98mm (1939-1953) **23**

Part	Year	VIN	Model/Application	Part Number	Qty.	
ENGINE GASKETS						
Head Set	1948-1953			HS1084K	1	
Full Set	1948-1953			FS1084K	1	
	1939-1947			FS1026K	1	
Cylinder Head Gasket	1948-1953		Standard Bore, Right	VR2000	1084K	1
			Standard Bore, Left	VR2000	1085K	1
	1939-1947		Standard Bore	VR2000	1026K	2
			Maximum 3.438" Bore	Copper	3036	2
Valve Cover Set	1948-1953		Cork Rubber	VS18755	1	

Ford Truck

23 (cont.)	239 CID (3.9L) L-Head Ford V8 Cyl, 3.188in./80.98mm (1939-1953)				23 (cont.)
----------------------	--	--	--	--	----------------------

Part	Year	VIN	Model/Application	Part Number	Qty.
ENGINE GASKETS (cont.)					
Valve Cover Set (cont.)	1939-1947			<i>Cork Rubber</i> VS18765	1
Manifold Set, Exhaust	1939-1953			MS5278AK	1
Oil Pan Set	1948-1953			<i>Cork Rubber</i> OS21111	1
	1939-1947			<i>Cork Rubber</i> OS31242	1
Rear Main Seal Set	1939-1953			JV674	1
Timing Cover Set	1939-1953			JV762	1

MISCELLANEOUS GASKETS					
Carb. Mount Gasket	1948-1953		2 Barrel Carburetor	G7128	1
Exhaust Pipe Gasket	1948-1953		(Flange Type)	F5451K	1
Fuel Pump Bowl Gasket	1948-1953			D35288	1
Push Rod Cover Grommet	1940-1953			B45317	1
Water Outlet Gasket	1948-1953			C24005	1
Water Pump Mount Gasket	1948-1953			K26373	2

24	239 CID (3.9L) OHV Ford V8 Cyl, 3.500in./88.9mm (1954-1955)				24
-----------	--	--	--	--	-----------

Part	Year	VIN	Model/Application	Part Number	Qty.
ENGINE GASKETS					
Cylinder Head Gasket	1955			<i>VR2000</i> 1176TC	2
	1954		Late	<i>VR2000</i> 1176TC	2
Valve Cover Set	1954-1955			<i>Cork Rubber</i> VS38261	1
Valve Stem Seal, Exh.	1955			B45283	8
Valve Stem Seal, Int.	1955			B45283	8
Manifold Set, Exhaust	1954-1955			MS15083Y	1
Oil Pan Set	1954-1955			<i>Cork Rubber</i> OS31414	1
Rear Main Seal Set	1954-1955			<i>Rope Packing</i> JV707	1
				<i>Molded Rubber</i> JV748	1
Timing Cover Set	1954-1955			JV799	1
Timing Cover Seal	1954-1955			46293	1
Harmonic Balancer Repair Sleeve	1954-1955		Use With Part Number A502, Front <i>Nickel Plated Formed Steel, .013" Thickness</i>	A229-1	1

MISCELLANEOUS GASKETS					
Carb. Mount Gasket	1954-1955		2 Barrel Carburetor	G7128	1
Exhaust Pipe Gasket	1955		(Flange Type), Crossover Pipe	F5436AK	3
	1954-1955		(Flange Type), Pipe To Manifold	F5451K	1
	1954		(Flange Type), Crossover Pipe	F17802	1
Fuel Pump Bowl Gasket	1954-1955			D36016	1
Fuel Pump Gasket	1954-1955			D27094	1
				<i>Tuff-Cork</i> D27094TC	1
Oil Pump Mounting Gasket	1954			B25973	1
Push Rod Cover Grommet	1954-1955			B45317	1
Push Rod Cover Set	1954-1955			PS38524	1
Valve Cover Grommet	1954-1955			B45317	4
Water Outlet Gasket	1954-1955			C25907	1
Water Pump Mount Gasket	1955			K27542	1
	1954		Late	K27542	1

LIGHT TRUCK

Part	Year	VIN	Model/Application	Part Number	Qty.
ENGINE GASKETS					
Head Set	1968-1974		(Exhaust Pipe Gasket Not Included)	HS3824E	1
	1965-1967		Valve Cover Gasket Required, (Valve Cover Gasket Not Included, Exhaust Pipe Gasket Not Included)	HS3824E	1
Full Set	1968-1974		(Exhaust Pipe Gasket Not Included)	FS3824E	1
	1965-1967		Valve Cover Gasket Required, (Valve Cover Gasket Not Included, Exhaust Pipe Gasket Not Included)	FS3824E	1
Engine Kit Gasket Set	1968-1974			95-3013VR	1
	1965-1967		(Push Rod Cover Set Not Included), Use With Part Number PS39570	95-3013VR	1
Cylinder Head Gasket	1965-1974		VR2000	3824	1
			Nitroseal	5821SG	1
Valve Cover Set	1968-1974		Cork Rubber	VS39747	1
	1965-1967		Cork Rubber	VS38035	1
Valve Stem Seal, Exh.	1965-1974			B45373	6
Valve Stem Seal, Int.	1965-1974			B45373	6
Manifold Set, Int. & Exh.	1965-1974			MS16040X	1
Oil Pan Set	1965-1974		Cork Rubber	OS30930	1
Rear Main Seal Set	1965-1974			JV611	1
			Teflon	JV1636	1
Crank Repair Sleeve	1965-1974		Use With Part Number A506, Rear Nickel Plated Formed Steel, .013" Thickness	A332	1
Timing Cover Set	1965-1974			JV867	1
			(Contains Repair Sleeve)	JV931	1
Timing Cover Gasket	1965-1974			T27118	1
Timing Cover Seal	1965-1974			46293	1
Harmonic Balancer Repair Sleeve	1965-1974		Front Ground Steel, .020" Thickness	66595RS	1
			Use With Part Number A502, Front Nickel Plated Formed Steel, .013" Thickness	A226-1	1
MISCELLANEOUS GASKETS					
Air Cleaner Mount Gasket	1965-1974		1 Barrel Carburetor	G25936	1
Carb. Mount Gasket	1974		1 Barrel Carburetor, Spacer To Manifold	G26061	1
	1973-1974		1 Barrel Carburetor, Carburetor To Spacer	G26058	1
	1970-1972		1 Barrel Carburetor, Carburetor To Manifold With Governor	G26056	3
			1 Barrel Carburetor, Governor To Carburetor	G26056	3
			1 Barrel Carburetor, Spacer To Manifold	G26056	3
	1969		Holley Carburetor, 1 Barrel Carburetor, Carburetor To Manifold	G26639	1
	1968-1969		Governor, 1 Barrel Carburetor, Carburetor To Manifold	G26056	3
	1965-1969		1 Barrel Carburetor, Carburetor To Spacer	G26056	3
			1 Barrel Carburetor, Governor To Manifold	G26056	3
			1 Barrel Carburetor, Spacer To Governor	G26056	3
	1968		1 Barrel Carburetor, Governor To Carburetor	G26056	3
			1 Barrel Carburetor, Carburetor To Manifold	G26639	1
	1966-1968		Except Governor, Except Thermactor Emission, 1 Barrel Carburetor, Carburetor To Manifold	G26639	1
1965-1968		1 Barrel Carburetor, Carburetor To Manifold	G26639	1	
E.G.R. Gasket	1973-1974			G26701	1
Exhaust Pipe Gasket	1965-1974		(Ring Type 'C'), Pipe To Manifold	F17250	1
			(Ring Type 'B'), Pipe To Manifold Sintered Metal	F17250S	1
Fuel Pump Gasket	1965-1974			D27094	1
			Tuff-Cork	D27094TC	1
Oil Pan Drain Plug Gst.	1965-1974			2066A	1
Oil Pump Mounting Gasket	1965-1974			B25676	1
Push Rod Cover Grommet	1965-1974			B45317	1

Ford Truck

25 (cont.)	240 CID (4.0L) OHV Ford 6 Cyl, 4.000in./101.6mm (1965-1974)				25 (cont.)
----------------------	--	--	--	--	----------------------

Part	Year	VIN	Model/Application	Part Number	Qty.
MISCELLANEOUS GASKETS (cont.)					
Push Rod Cover Set	1965-1974			PS39570	1
Water Outlet Gasket	1965-1974			C24005	1
Water Pump Mount Gasket	1965-1974			K27113	1

26	244 CID (4.0L) OHV Ford V6 Cyl, 3.953in./100.4mm (1990-2000)				26
-----------	---	--	--	--	-----------

Part	Year	VIN	Model/Application	Part Number	Qty.
ENGINE GASKETS					
Head Set	1995-1996		(Head Bolts Not Included)	HS5887A	1
	1990-1994		(Head Bolts Not Included)	HS5887	1
				(Contains Head Bolts)	HS5887WB
Lower Set	1994-2000		(Requires Head Set To Make Full Set)	CS5887	1
	1990-1993		(Requires Head Set To Make Full Set)	CS5887A	1
Full Set	1990-1993		(Head Bolts Not Included)	FS5887	1
Engine Kit Gasket Set	1994-1996		(Head Bolts Not Included)	95-3455VR	1
	1990-1993		(Head Bolts Not Included)	95-3390VR	1
Cylinder Head Gasket	1990-2000		Left <i>VR2000</i>	5887	1
			Right <i>VR2000</i>	5888	1
Cyl. Head Bolt Set	1990-2000		(1 Set Per Head)	GS33221	2
Valve Cover Set	1990-2000		(Contains Fuel Rail Gaskets, Contains Plenum Chamber Gasket) <i>Tuff-Cork</i>	VS50153TC	1
			Original Equipment Design, (Contains Fuel Rail Gaskets, Contains Plenum Chamber Gasket) <i>Victo-Tech</i>	VS50209	1
Valve Stem Seal, Exh.	1990-2000		(Original Equipment Type)	B45900	6
Valve Stem Seal, Int.	1990-2000		(Original Equipment Type)	B45900	6
Manifold Set, Exhaust	1997-2000			MS16290	1
	1990-1996			MS12396	1
Manifold Set, Intake	1990-2000		(Requires Valve Cover Set, Plenum Chamber Gasket Not Included, 1 Piece Design With Attached Victo-Foam End Strips) <i>Nitroseal</i>	MS15985	1
Plenum Chamber Gasket	1995-2000		Explorer, Ranger, (Contains Three Piece), Fuel Rail To Plenum	MS15675A	1
	1996-1997		Aerostar, (Contains Three Piece), Fuel Rail To Plenum	MS15675A	1
	1990-1995		Fuel Rail To Plenum	MS15675	1
Oil Pan Set	1994-2000		<i>Victo-Tech</i>	OS32521	1
	1990-1993		<i>Victo-Tech</i>	OS32468	1
Rear Main Seal Set	1994-2000			JV1618	1
	1990-1993			JV617	1
Crank Repair Sleeve	1990-1996		Use With Part Number A511, Rear <i>Nickel Plated Formed Steel, .013" Thickness</i>	A341	1
Timing Cover Set	1994-2000		(Requires Oil Pan Set), Use With Part Number OS32521	JV1139	1
	1990-1993		(Requires Oil Pan Set), Use With Part Number OS32468	JV1139	1
Timing Cover Seal	1990-2000			47518	1

MISCELLANEOUS GASKETS					
Dist. Mounting Gasket	1994-2000		Ranger, (O-Ring Type)	72122	1
	1996-1997		Aerostar, (O-Ring Type)	72122	1
	1991-1996		Explorer	72025	1
E.G.R. Gasket	1993-2000			G30625	1
Exhaust Pipe Gasket	1990-1997		Aerostar, (Flange Type), Catalytic Converter To Muffler	F14627	1
			(Flange Type), Pipe To Converter	F14763	1
	1991-1994		Explorer, (Ring Type 'F'), Catalytic Converter To Muffler	F10085	1
	1990-1994		Ranger, (Ring Type 'F'), Catalytic Converter To Muffler	F10085	1
Oil Filter Mount Bolt Seal	1990-2000		<i>17mm Inside Diameter</i>	72115	1
Thermostat Seal	1990-1999		<i>Victo-Tech</i>	C31138	1
Throttle Body Gasket	1990-1997			G31110	1

26 244 CID (4.0L) OHV Ford V6 Cyl, 3.953in./100.4mm (1990-2000) **26**
(cont.) (cont.)

Part Year VIN Model/Application Part Number Qty.

MISCELLANEOUS GASKETS (cont.)

Water Pump Mount Gasket	1990-2000			K27985	1
-------------------------	-----------	--	--	--------	---

27 244 CID (4.0L) SOHC Ford V6 Cyl, 3.953in./100.4mm (1997-2003) **27**

Part Year VIN Model/Application Part Number Qty.

ENGINE GASKETS

Cylinder Head Gasket	2000		Thru 7/24/00, Right	Multi-Layered Steel	54195	1
			Thru 7/24/00, Left	Multi-Layered Steel	54196	1
	1997-1999		Right	Multi-Layered Steel	54195	1
			Left	Multi-Layered Steel	54196	1
Valve Cover Set	2001-2003		(Contains Valve Cover Grommets)	Victo-Tech	VS50323	1
	2000		From 7/24/00, (Contains Valve Cover Grommets)	Victo-Tech	VS50323	1
			Thru 7/24/00	Victo-Tech	VS50333	1
Oil Pan Set	1997-1999			Victo-Tech	VS50333	1
	2000		Thru 7/24/00, Upper Pan To Block	Victo-Tech	OS32521	1
	1997-1999		Upper Pan To Block	Victo-Tech	OS32521	1
Rear Main Seal Set	1997-2001				JV1618	1
Timing Cover Seal	1997-2001				47518	1

MISCELLANEOUS GASKETS

E.G.R. Gasket	1997-2001				G30625	1
Oil Filter Mount Bolt Seal	1997-2001			17mm Inside Diameter	72115	1

28 244 CID (4.0L) SOHC Ford Flex Fuel V6 Cyl, 3.953in./100.4mm (2002-2003) **28**

Part Year VIN Model/Application Part Number Qty.

ENGINE GASKETS

Valve Cover Set	2002-2003		(Contains Valve Cover Grommets)	Victo-Tech	VS50323	1
-----------------	-----------	--	---------------------------------	------------	---------	---

29 250 CID (4.1L) Ford 6 Cyl, 3.680in./93.5mm (1969-1974) **29**

Part Year VIN Model/Application Part Number Qty.

ENGINE GASKETS

Head Set	1969-1974		(Exhaust Pipe Gasket Not Included)		HS3910VJ	1
Full Set	1969-1974		(Exhaust Pipe Gasket Not Included)		FS3870E	1
Cylinder Head Gasket	1969-1974			VR2000	3910VC	1
Valve Cover Set	1969-1974			Cork Rubber	VS39564	1
Valve Stem Seal, Exh.	1969-1974				B45320	6
Valve Stem Seal, Int.	1969-1974				B45320	6
Manifold Set, Exhaust	1969-1974				MS16035W	1
Oil Pan Set	1969-1974			Cork Rubber	OS30991	1
Rear Main Seal Set	1969-1974			Rope Packing	JV730	1
				Molded Rubber	JV730R	1
Timing Cover Set	1969-1974				JV868	1

MISCELLANEOUS GASKETS

Air Cleaner Mount Gasket	1970-1974		1 Barrel Carburetor		G26540	1
Carb. Mount Gasket	1973-1974		1 Barrel Carburetor, Carburetor To Heat Shield		G24114	1
	1970-1974		1 Barrel Carburetor, Carburetor To Spacer		G26177	1
	1969-1974		1 Barrel Carburetor, Spacer To Manifold		G25498	1
	1969		Except Holley Carburetor, Improved Combustion Emission Control System, 1 Barrel Carburetor, Carburetor To Spacer		G26223	1
Exhaust Pipe Gasket	1969-1974		Holley Carburetor, 1 Barrel Carburetor, Carburetor To Spacer		G26639	1
			(Ring Type 'C'), Pipe To Manifold		F17250	1

Ford Truck

29 <small>(cont.)</small>	250 CID (4.1L) Ford 6 Cyl, 3.680in./93.5mm (1969-1974)	29 <small>(cont.)</small>
-------------------------------------	---	-------------------------------------

Part	Year	VIN	Model/Application	Part Number	Qty.
MISCELLANEOUS GASKETS (cont.)					
Exhaust Pipe Gasket (cont.)	1969-1974		(Ring Type 'B'), Pipe To Manifold <i>Sintered Metal</i>	F17250S	1
Fuel Pump Gasket	1969-1974			D27094	1
				<i>Tuff-Cork</i>	D27094TC
Water Outlet Gasket	1969-1974			C24005	1
Water Pump Mount Gasket	1969-1974			K27121	1

30	254 CID (4.2L) L-Head Ford 6 Cyl, 3.500in./88.9mm (1950-1953)	30
-----------	--	-----------

Part	Year	VIN	Model/Application	Part Number	Qty.
MISCELLANEOUS GASKETS					
Exhaust Pipe Gasket	1950-1953		(Flange Type), Pipe To Manifold	F5451K	1
Fuel Pump Bowl Gasket	1950-1953			D35288	1
Fuel Pump Gasket	1950-1953			D27094	1

31	255 CID (4.2L) Ford V8 Cyl, 3.680in./93.5mm (1981-1982)	31
-----------	--	-----------

Part	Year	VIN	Model/Application	Part Number	Qty.	
ENGINE GASKETS						
Head Set	1981-1982		(Intake Manifold Gasket Not Included)	HS3562	1	
Full Set	1981-1982		(Intake Manifold Gasket Not Included)	FS3562	1	
Engine Kit Gasket Set	1982			95-3057VR	1	
	1981		From 4/14/81	95-3057VR	1	
			Thru 4/14/81, (Intake Manifold Gasket Not Included), Use With Part Number MS15959	95-3057VR	1	
Cylinder Head Gasket	1981-1982		<i>VR2000</i>	3562	2	
Valve Cover Set	1981-1982		<i>Cork Rubber</i>	VS38300	1	
			<i>High Temperature Cork Rubber</i>	VS38300H	1	
			<i>High Temperature Tuff-Cork</i>	VS38300HTC	1	
			<i>Victo-Tech</i>	VS38300R	1	
Valve Stem Seal, Exh.	1981-1982			B45399	8	
Valve Stem Seal, Int.	1981-1982			B45399	8	
Manifold Set, Exhaust	1981-1982			MS15129X	1	
Manifold Set, Intake	1982			MS15333	1	
				MS15333	1	
				MS15959	1	
Oil Pan Set	1981-1982		<i>Cork Rubber</i>	OS30531	1	
			<i>Tuff-Cork</i>	OS30531TC	1	
Rear Main Seal Set	1981-1982		<i>Rope Packing</i>	JV730	1	
			<i>Molded Rubber</i>	JV730R	1	
Timing Cover Set	1981-1982			JV856	1	
			(Contains Repair Sleeve)	JV922	1	
Timing Cover Gasket	1981-1982			T27802	1	
Timing Cover Seal	1981-1982			46293	1	
Harmonic Balancer Repair Sleeve	1981-1982		Front	<i>Ground Steel, .020" Thickness</i>	66595RS	1
				Use With Part Number A502, Front <i>Nickel Plated Formed Steel, .013" Thickness</i>	A226-2	1

Part	Year	VIN	Model/Application	Part Number	Qty.
MISCELLANEOUS GASKETS					
Air Cleaner Mount Gasket	1981-1982		2 Barrel Carburetor <i>5" Inside Diameter</i>	G27098	1
			2 Barrel Carburetor <i>5-3/8" Inside Diameter</i>	G31432	1
Carb. Mount Gasket	1981-1982		(Spacer), 2 Barrel Carburetor	G30651	1
Dist. Mounting Gasket	1981-1982			72125	1
E.G.R. Gasket	1981-1982			G26702	1
Fuel Pump Gasket	1981-1982			D27094	1

LIGHT TRUCK

31 255 CID (4.2L) Ford V8 Cyl, 3.680in./93.5mm (1981-1982) **31**
 (cont.) (cont.)

Part	Year	VIN	Model/Application	Part Number	Qty.
MISCELLANEOUS GASKETS (cont.)					
Fuel Pump Gasket (cont.)	1981-1982		Tuff-Cork	D27094TC	1
Oil Pan Drain Plug Gst.	1981-1982			2066A	1
Oil Pump Inlet Tube	1981-1982			B26151	1
Water Outlet Gasket	1981-1982			C24005	1
Water Pump Mount Gasket	1981-1982			K27955	1

32 256 CID (4.2L) Ford V6 Cyl, 3.811in./96.8mm (1997-2003) **32**

Part	Year	VIN	Model/Application	Part Number	Qty.
ENGINE GASKETS					
Head Set	1999		(Head Bolts Not Included, Contains 4mm Thick Intake Manifold Gasket)	HS54175E	1
	1998		From 1/15/98, (Head Bolts Not Included, Plenum Chamber Gasket Not Included, Contains 4mm Thick Intake Manifold Gasket)	HS54175	1
			Thru 1/15/98, (Head Bolts Not Included, Plenum Chamber Gasket Not Included, Contains 3mm Thick Intake Manifold Gasket)	HS54175B	1
	1997		(Head Bolts Not Included, Plenum Chamber Gasket Not Included)	HS54175B	1
Lower Set	1997-2000		(Requires Head Set To Make Full Set)	CS54175	1
Cylinder Head Gasket	1997-2000		Right <i>Multi-Layered Steel</i>	54175	1
			Left <i>Multi-Layered Steel</i>	54176	1
Cyl. Head Bolt Set	1997-2001			GS33317	2
Valve Cover Set	1997-2001		<i>Victo-Tech</i>	VS50202	1
			(Single Valve Cover) <i>Victo-Tech</i>	VS50202S	2
Valve Stem Seal, Exh.	1999-2001			B45906	6
	1997-1998			B45823A	6
Valve Stem Seal, Int.	1999-2001			B45906	6
	1997-1998			B45823A	6
Manifold Set, Exhaust	1999-2001		<i>Nitroseal</i>	MS16318	1
	1997-1998		<i>Nitroseal</i>	MS16171	1
Manifold Set, Intake	2000-2002		(Plenum Chamber Gasket Not Included) <i>Victo-Tech</i>	MS16230	1
	1999		(Plenum Chamber Gasket Not Included) <i>Victo-Tech</i>	MS16233-1	1
	1998		From 1/15/98, (Plenum Chamber Gasket Not Included, Contains 4mm Thick Intake Manifold Gasket) <i>Victo-Tech</i>	MS16233-1	1
			Thru 1/15/98, (Plenum Chamber Gasket Not Included, Contains 3mm Thick Intake Manifold Gasket) <i>Victo-Tech</i>	MS16233-3	1
1997		(Plenum Chamber Gasket Not Included) <i>Victo-Tech</i>	MS16233-3	1	
Plenum Chamber Gasket	1998-2000		<i>Performaseal</i>	MS16284	1
			From 7/31/97 <i>Performaseal</i>	MS16284	1
	1997		Thru 7/31/97 <i>Victo-Tech</i>	MS16285	1
Oil Pan Set	2001-2003			OS32236	1
	2000		Engine Tags OK-702/703/704/706-CA, OD-710/711/716/717/718/719/721-CA, OC-720/722-BA	OS32236	1
			Except Engine Tags OK-702/703/704/706-CA, OD-710/711/716/717/718/719/721-CA, OC-720/722-BA	OS32524	1
1997-1999			OS32524	1	
Rear Main Seal Set	1997-2001			JV523	1
			(Optional) <i>Teflon</i>	JV1635	1
Crank Repair Sleeve	1997-2001		Use With Part Number A505, Rear <i>Nickel Plated Formed Steel, .013" Thickness</i>	A331	1
Timing Cover Set	1997-2001		<i>Performaseal</i>	JV5012	1
Timing Cover Gasket	1997-2001		<i>Performaseal</i>	T31565	1
Timing Cover Seal	1997-2001			46293	1

LIGHT TRUCK

Ford Truck

32 <small>(cont.)</small>	256 CID (4.2L) Ford V6 Cyl, 3.811in./96.8mm (1997-2003)	32 <small>(cont.)</small>
-------------------------------------	--	-------------------------------------

Part	Year	VIN	Model/Application	Part Number	Qty.
MISCELLANEOUS GASKETS					
E.G.R. Gasket	1997-2001		Adapter To Intake Manifold, Valve To Adapter	G30625	2
Oil Cooler Seal	1997-2003		<i>Victo-Tech</i>	B31615	1
Throttle Body Gasket	1997-2000			G31577	1
Water Outlet Gasket	1997-2001			C26961	1
Water Pump Gasket	1997-2001			K31566	1

33	256 CID (4.2L) Ford V8 Cyl, 3.625in./92.1mm (1954-1955)	33
-----------	--	-----------

Part	Year	VIN	Model/Application	Part Number	Qty.
ENGINE GASKETS					
Cylinder Head Gasket	1954-1955		<i>VR2000</i>	1176TC	2
Valve Cover Set	1954-1955		<i>Cork Rubber</i>	VS38261	1
Valve Stem Seal, Exh.	1954-1955			B45283	8
Valve Stem Seal, Int.	1954-1955			B45283	8
Manifold Set, Exhaust	1954-1955			MS15083Y	1
Oil Pan Set	1954-1955		<i>Cork Rubber</i>	OS31414	1
Rear Main Seal Set	1954-1955		<i>Rope Packing</i>	JV707	1
			<i>Molded Rubber</i>	JV748	1
Timing Cover Set	1954-1955			JV799	1
Timing Cover Seal	1954-1955			46293	1

MISCELLANEOUS GASKETS					
Exhaust Pipe Gasket	1955		(Flange Type), Crossover Pipe	F5436AK	3
	1954-1955		(Flange Type), Pipe To Manifold	F5451K	1
	1954		(Flange Type), Crossover Pipe	F17802	1
Fuel Pump Bowl Gasket	1954-1955			D36016	1
Fuel Pump Gasket	1954-1955			D27094	1
			<i>Tuff-Cork</i>	D27094TC	1
Oil Pump Mounting Gasket	1954-1955			B25973	1
Push Rod Cover Grommet	1954-1955			B45317	1
Push Rod Cover Set	1954-1955			PS38524	1
Valve Cover Grommet	1954-1955			B45317	4
Water Outlet Gasket	1954-1955			C25907	1
Water Pump Mount Gasket	1954-1955			K27542	2

34	260 CID (4.3L) Ford V8 Cyl, 3.800in./96.5mm (1964)	34
-----------	---	-----------

Part	Year	VIN	Model/Application	Part Number	Qty.
ENGINE GASKETS					
Head Set	1964		(Exhaust Pipe Gasket Not Included)	HS3530VJ	1
Lower Set	1964		(Requires Head Set To Make Full Set)	CS3530B	1
Full Set	1964		(Exhaust Pipe Gasket Not Included)	FS3530VJ	1
Cylinder Head Gasket	1964		<i>VR2000</i>	3428	2
			<i>Nitroseal</i>	3428SG	2
Valve Cover Set	1964		<i>Cork Rubber</i>	VS38300	1
			<i>High Temperature Cork Rubber</i>	VS38300H	1
			<i>High Temperature Tuff-Cork</i>	VS38300HTC	1
			<i>Victo-Tech</i>	VS38300R	1
Valve Stem Seal, Exh.	1964			B45399	8
Valve Stem Seal, Int.	1964			B45399	8
Manifold Set, Exhaust	1964			MS15129X	1
Manifold Set, Intake	1964			MS15172	1
Oil Pan Set	1964		<i>Cork Rubber</i>	OS30531	1
Rear Main Seal Set	1964		<i>Rope Packing</i>	JV730	1

LIGHT TRUCK

34 260 CID (4.3L) Ford V8 Cyl, 3.800in./96.5mm (1964) **34**
(cont.) (cont.)

Part	Year	VIN	Model/Application	Part Number	Qty.
ENGINE GASKETS (cont.)					
Rear Main Seal Set (cont.)	1964		Molded Rubber	JV730R	1
Timing Cover Set	1964			JV856	1
			(Contains Repair Sleeve)	JV922	1
Timing Cover Gasket	1964			T27802	1
Timing Cover Seal	1964			46293	1
Harmonic Balancer Repair Sleeve	1964		Ground Steel, .020" Thickness	66595RS	1

MISCELLANEOUS GASKETS

Air Cleaner Mount Gasket	1964		2 Barrel Carburetor	G27098	1
Carb. Mount Gasket	1964		2 Barrel Carburetor	G26052	2
Exhaust Pipe Gasket	1964		(Ring Type 'C'), Pipe To Manifold	F17250	2
			(Ring Type 'B'), Pipe To Manifold	Sintered Metal F17250S	2
Fuel Pump Gasket	1964			D27094	1
Oil Pan Drain Plug Gst.	1964			2066A	1
Oil Pump Inlet Tube	1964			B26151	1
Oil Pump Mounting Gasket	1964			B26553	1
Water Outlet Gasket	1964			C24005	1
Water Pump Mount Gasket	1964			K27579	1

35 262 CID (4.3L) OHV Ford 6 Cyl, 3.719in./94.5mm (1961-1964) **35**

Part	Year	VIN	Model/Application	Part Number	Qty.
ENGINE GASKETS					
Head Set	1961-1964			HS3264VW	1
Full Set	1961-1964			FS3264VW	1
Cylinder Head Gasket	1961-1964		VR2000	3264VC	1
Valve Cover Set	1961-1964		Cork Rubber	VS39565	1
Manifold Set, Intake	1961-1964			MS9997	1
Manifold Set, Int. & Exh.	1961-1964		(1 Piece)	MS16037X	1
Oil Pan Set	1961-1964		Cork Rubber	OS31570	1
Rear Main Seal Set	1961-1964			JV683	1
Timing Cover Set	1961-1964			JV827	1
Timing Cover Seal	1961-1964			46293	1

MISCELLANEOUS GASKETS

Carb. Mount Gasket	1961-1964		1 Barrel Carburetor	G5260EK	1
Exhaust Pipe Gasket	1961-1964		(Flange Type), Pipe To Manifold	F5451K	1
Fuel Pump Bowl Gasket	1961-1964			D36016	1
Fuel Pump Gasket	1961-1964			D36016	1
Oil Pan Drain Plug Gst.	1961-1964			2066A	1
Push Rod Cover Set	1961-1964			PS39563	1
Water Outlet Gasket	1961-1964			C25435	1
Water Pump Mount Gasket	1961-1964			K25856	1

36 272 CID (4.5L) Ford V8 Cyl, 3.625in./92.1mm (1956-1958) **36**

Part	Year	VIN	Model/Application	Part Number	Qty.
ENGINE GASKETS					
Head Set	1956-1958		(Exhaust Manifold Gasket Not Included)	HS1176VJ	1
Full Set	1956-1958		(Exhaust Manifold Gasket Not Included)	FS1176VJ	1

Ford Truck

36 272 CID (4.5L) Ford V8 Cyl, 3.625in./92.1mm (1956-1958) **36**
 (cont.) (cont.)

Part Year VIN Model/Application Part Number Qty.

ENGINE GASKETS (cont.)

Engine Kit Gasket Set	1956-1958			95-3319VR	1
Cylinder Head Gasket	1956-1958		VR2000	1176TC	2
Valve Cover Set	1956-1958		Cork Rubber	VS38261	1
Valve Stem Seal, Exh.	1956-1958			B45283	8
Valve Stem Seal, Int.	1956-1958			B45283	8
Manifold Set, Exhaust	1958			MS15095	1
	1956-1957			MS15083Y	1
Manifold Set, Intake	1956-1958		4 Barrel Carburetor	MS15116	1
			2 Barrel Carburetor	MS18690	1
Oil Pan Set	1956-1958		Cork Rubber	OS31414	1
Rear Main Seal Set	1956-1958		Rope Packing	JV707	1
			Molded Rubber	JV748	1
Timing Cover Set	1956-1958			JV799	1
Timing Cover Seal	1956-1958			46293	1
Harmonic Balancer Repair Sleeve	1956-1958		Use With Part Number A502, Front Nickel Plated Formed Steel, .013" Thickness	A229-1	1

MISCELLANEOUS GASKETS

Carb. Mount Gasket	1958		F100, F250, F350, 2 Barrel Carburetor	G7332	1
	1957-1958		B600, B700, C600, C700, F600, F700, P350, P400, P500, T700, 2 Barrel Carburetor	G7332	1
	1956		F100, F250, F350, P350, Except Heavy Duty, 2 Barrel Carburetor	G7128	1
Exhaust Pipe Gasket	1956-1958		(Flange Type), Crossover Pipe	F5436AK	3
			(Flange Type), Pipe To Manifold	F5451K	1
Fuel Pump Bowl Gasket	1956-1958			D36016	1
Fuel Pump Gasket	1956-1958			D27094	1
			Tuff-Cork	D27094TC	1
Oil Pan Drain Plug Gst.	1958			2066A	1
Oil Pump Mounting Gasket	1956-1958			B25973	1
Push Rod Cover Grommet	1956-1958			B45317	1
Push Rod Cover Set	1956-1958			PS38524	1
Valve Cover Grommet	1956-1958			B45317	4
Water Outlet Gasket	1956-1958			C25907	1
Water Pump Mount Gasket	1956-1958			K27542	2

37 281 CID (4.6L) SOHC Ford V8 Cyl, 3.551in./90.2mm (1997-2003) **37**

Part Year VIN Model/Application Part Number Qty.

ENGINE GASKETS

Head Set	1997-2001	6	(Head Bolts Not Included, Plenum Chamber Gasket Not Included, Intake Manifold Gasket Not Included)	HS5931C	1
		W	(Head Bolts Not Included, Plenum Chamber Gasket Not Included, Intake Manifold Gasket Not Included)	HS5931D	1
Lower Set	1999-2000		(Requires Head Set To Make Full Set)	CS5931B	1
	1997-1998		(Requires Head Set To Make Full Set)	CS5931A	1
Engine Kit Gasket Set	1997-2000	W	(Head Bolts Not Included, Plenum Chamber Gasket Not Included, Intake Manifold Gasket Not Included)	95-3490VR	1
Cylinder Head Gasket	1997-2001		Left Nitroseal	5931	1
			Right Nitroseal	5932	1
Cyl. Head Bolt Set	1997-2003			GS33269	2
Valve Cover Set	1997-2001	W	(Contains Grommets) Victo-Tech	VS50177	1
		6	Victo-Tech	VS50275	1
Valve Stem Seal, Exh.	1997-2003			B45892	8
Valve Stem Seal, Int.	1997-2003			B45892	8

LIGHT TRUCK

37 281 CID (4.6L) SOHC Ford V8 Cyl, 3.551in./90.2mm (1997-2003) **37**
(cont.) (cont.)

Part	Year	VIN	Model/Application	Part Number	Qty.
ENGINE GASKETS (cont.)					
Manifold Set, Exhaust	1997-2003		Nitroseal	MS16112	1
Manifold Set, Intake	2002		Expedition, Explorer, Mountaineer	Victo-Tech MS16296	1
	2001			Victo-Tech MS16296	1
	2000		(Contains Plenum Chamber Gasket)	Victo-Tech MS16260-1	1
	1999		Expedition, Power Improved	Victo-Tech MS16296	1
	1997-1999		Club Wagon E150, Econoline E150, Econoline E250, F150, F250, (Contains Plenum Chamber Gasket)	Victo-Tech MS16260-1	1
	1998	6	Expedition	Victo-Tech MS16297	1
	1997-1998	W	Expedition, (Contains Plenum Chamber Gasket)	Victo-Tech MS16260-1	1
		1997	6	Expedition, Thru 7/20/97, (Contains Plenum Chamber Gasket)	Victo-Tech MS16260-1
Plenum Chamber Gasket		6	Expedition, From 7/21/97	Victo-Tech MS16297	1
	2000			Victo-Tech MS16301	1
	1999		Expedition	Victo-Tech MS16295	1
			Club Wagon E150, Econoline E150, F150, F250	Victo-Tech MS16301	1
	1997-1998			Victo-Tech MS16301	1
Oil Pan Set	1997-2003			Victo-Tech OS32517	1
Rear Main Seal Set	1997-2003			JV1612	1
Timing Cover Set	1999-2001			Victo-Tech JV5013	1
	1997-1998			Victo-Tech JV5011	1
Timing Cover Seal	2002-2003		Explorer, Mountaineer	48322	1
			Club Wagon E150, Econoline E150, Econoline E250, Expedition, F150, F150 SuperCrew	67616	1
	1999-2001			67616	1
	1997-1998			48322	1

MISCELLANEOUS GASKETS

E.G.R. Gasket	1997-2003			G30625	1
Oil Filter Adapt Gasket	1997-2003			Victo-Tech B31584	1
Therm. Housing Gasket	1997-2003		(O-Ring Type)	C31302	1
Throttle Body Gasket	2002-2003		F150, Adapter To Manifold	G31570	1
			Explorer, Mountaineer, Adapter To Intake Manifold	Victo-Tech G31603	1
	1997-2003		Throttle Body To Adapter	G31569	1
			Adapter To Manifold	G31570	1
Water Pump Mount Gasket	1997-2003			K31309	1

38 281 CID (4.6L) SOHC Ford LPG V8 Cyl, 3.551in./90.2mm (1997-1998) **38**

Part	Year	VIN	Model/Application	Part Number	Qty.
------	------	-----	-------------------	-------------	------

MISCELLANEOUS GASKETS

E.G.R. Gasket	1997-1998			G30625	1
---------------	-----------	--	--	--------	---

39 289 CID (4.7L) Ford V8 Cyl, 4.000in./101.6mm (1965-1968) **39**

Part	Year	VIN	Model/Application	Part Number	Qty.
------	------	-----	-------------------	-------------	------

ENGINE GASKETS

Head Set	1965-1968		(Exhaust Pipe Gasket Not Included)	HS3530VJ	1
Full Set	1965-1968		(Exhaust Pipe Gasket Not Included)	FS3530VJ	1
Engine Kit Gasket Set	1965-1968			95-3367VR	1
Cylinder Head Gasket	1965-1968			VR2000 3428	2
				Nitroseal 3428SG	2
Valve Cover Set	1965-1968			Cork Rubber VS38300	1
				High Temperature Cork Rubber VS38300H	1

Ford Truck

39 289 CID (4.7L) Ford V8 Cyl, 4.000in./101.6mm (1965-1968)
(cont.)

39
(cont.)

Part	Year	VIN	Model/Application	Part Number	Qty.
ENGINE GASKETS (cont.)					
Valve Cover Set (cont.)	1965-1968		High Temperature Tuff-Cork	VS38300HTC	1
			Victo-Tech	VS38300R	1
Valve Stem Seal, Exh.	1965-1968			B45399	8
Valve Stem Seal, Int.	1965-1968			B45399	8
Manifold Set, Exhaust	1965-1968			MS15129X	1
Manifold Set, Intake	1965-1968			MS15172	1
Oil Pan Set	1965-1968		Cork Rubber	OS30531	1
			Tuff-Cork	OS30531TC	1
Rear Main Seal Set	1965-1968		Rope Packing	JV730	1
			Molded Rubber	JV730R	1
Timing Cover Set	1965-1968			JV856	1
			(Contains Repair Sleeve)	JV922	1
Timing Cover Gasket	1965-1968			T27802	1
Timing Cover Seal	1965-1968			46293	1
Harmonic Balancer Repair Sleeve	1965-1968		Front		
			Ground Steel, .020" Thickness	66595RS	1
			Use With Part Number A502, Front		
			Nickel Plated Formed Steel, .013" Thickness	A226-2	1

MISCELLANEOUS GASKETS

Carb. Mount Gasket	1965-1968		2 Barrel Carburetor	G26052	1
Exhaust Pipe Gasket	1965-1968		(Ring Type 'C'), Pipe To Manifold	F17250	1
			(Ring Type 'B'), Pipe To Manifold	Sintered Metal F17250S	1
Fuel Pump Bowl Gasket	1966-1968			D36016	1
Fuel Pump Gasket	1965-1968			D27094	1
			Tuff-Cork	D27094TC	1
Oil Pan Drain Plug Gst.	1965-1968			2066A	1
Oil Pump Mounting Gasket	1966-1968			B25973	1
Water Outlet Gasket	1965-1968			C24005	1
Water Pump Backing Plate	1965-1968			K27142	1
Water Pump Mount Gasket	1965-1968			K27955	1

40 292 CID (4.8L) Ford V8 Cyl, 3.750in./95.3mm (1958-1964)

40

Part	Year	VIN	Model/Application	Part Number	Qty.
ENGINE GASKETS					
Head Set	1958-1964		(Exhaust Manifold Gasket Not Included)	HS1176VJ	1
Full Set	1958-1964		(Exhaust Manifold Gasket Not Included)	FS1176VJ	1
Engine Kit Gasket Set	1958-1964			95-3319VR	1
Cylinder Head Gasket	1958-1964		VR2000	1176TC	2
Valve Cover Set	1960-1964		Cork Rubber	VS38307	1
	1958-1959		Cork Rubber	VS38261	1
Valve Stem Seal, Exh.	1958-1964			B45283	8
Valve Stem Seal, Int.	1958-1964			B45283	8
Manifold Set, Exhaust	1958-1964			MS15083Y	1
			(Heat Shield)	MS15095	1
Manifold Set, Intake	1959-1964		4 Barrel Carburetor	MS15116	1
	1958-1964		2 Barrel Carburetor	MS18690	1
Oil Pan Set	1958-1964		Cork Rubber	OS31414	1
Rear Main Seal Set	1958-1964		Rope Packing	JV707	1
			Molded Rubber	JV748	1
Timing Cover Set	1958-1964			JV799	1
Timing Cover Seal	1958-1964			46293	1

40 292 CID (4.8L) Ford V8 Cyl, 3.750in./95.3mm (1958-1964) **40**
(cont.) (cont.)

Part Year VIN Model/Application Part Number Qty.

ENGINE GASKETS (cont.)

Harmonic Balancer Repair Sleeve	1958-1964		Use With Part Number A502, Front <i>Nickel Plated Formed Steel, .013" Thickness</i>	A229-1	1
---------------------------------	-----------	--	--	--------	---

MISCELLANEOUS GASKETS

Carb. Mount Gasket	1964		2 Barrel Carburetor, Carburetor To Governor, Carburetor To Manifold, Carburetor To Spacer, Governor To Manifold	G26072	2
	1959-1963		4 Barrel Carburetor	G27104	1
	1958-1963		2 Barrel Carburetor	G7332	1
Exhaust Pipe Gasket	1958-1964		(Flange Type), Crossover Pipe	F5436AK	3
			(Flange Type), Pipe To Manifold	F5451K	2
Fuel Pump Bowl Gasket	1958-1964			D36016	1
Fuel Pump Gasket	1958-1964			D27094	1
			<i>Tuff-Cork</i>	D27094TC	1
Oil Pan Drain Plug Gst.	1958-1964			2066A	1
Oil Pump Mounting Gasket	1958-1964			B25973	1
Push Rod Cover Grommet	1958-1964			B45317	1
Push Rod Cover Set	1958-1964			PS38524	1
Valve Cover Grommet	1958-1964			B45317	4
Water Outlet Gasket	1958-1964			C25907	1
Water Pump Mount Gasket	1958-1964			K27542	2

41 300 CID (4.9L) Ford 6 Cyl, 4.000in./101.6mm (1965-1996) **41**

Part Year VIN Model/Application Part Number Qty.

ENGINE GASKETS

Head Set	1993-1996		(Push Rod Cover Set Not Included)	HS3824A	1
	1992		(Push Rod Cover Set Not Included)	HS3824P	1
	1991		From 2/3/91, (Push Rod Cover Set Not Included)	HS3824P	1
			Thru 2/3/91, (Push Rod Cover Set Not Included)	HS3824Y	1
	1987-1990		(Push Rod Cover Set Not Included)	HS3824Y	1
	1968-1986		(Push Rod Cover Set Not Included, Exhaust Pipe Gasket Not Included)	HS3824E	1
	1965-1967		Valve Cover Gasket Required, (Valve Cover Set Not Included, Push Rod Cover Set Not Included, Exhaust Pipe Gasket Not Included)	HS3824E	1
Lower Set	1993-1996		(Contains Push Rod Cover Set, Requires Head Set To Make Full Set)	CS3824	1
	1965-1986		(Contains Push Rod Cover Set, Requires Head Set To Make Full Set)	CS3824A	1
Full Set	1992			FS3824P	1
	1991		Thru 2/3/91	FS3824A	1
			From 2/3/91	FS3824P	1
	1988-1990			FS3824A	1
	1987			FS3824Y	1
	1968-1986		(Exhaust Pipe Gasket Not Included)	FS3824E	1
	1965-1967		Valve Cover Gasket Required, (Valve Cover Set Not Included, Exhaust Pipe Gasket Not Included)	FS3824E	1
Engine Kit Gasket Set	1992-1995		(Valve Stem Seals Not Included), Use With Part Numbers B45591 (6), B45418 (6)	95-3392VR	1
	1991		From 2/3/91, (Valve Stem Seals Not Included), Use With Part Numbers B45591 (6), B45418 (6)	95-3392VR	1
			Thru 2/3/91	95-3392VR	1
	1988-1990			95-3392VR	1
	1987		(Valve Cover Set Not Included), Use With Part Number VS39747	95-3392VR	1
1986			95-3391VR	1	

Ford Truck

41 300 CID (4.9L) Ford 6 Cyl, 4.000in./101.6mm (1965-1996) **41**
 (cont.) (cont.)

Part Year VIN Model/Application Part Number Qty.

ENGINE GASKETS (cont.)

Engine Kit Gasket Set (cont.)	1985		Thru 5/14/85	95-3013VR	1
			From 5/15/85	95-3391VR	1
	1968-1984			95-3013VR	1
	1965-1967		(Push Rod Cover Set Not Included), Use With Part Number PS39570	95-3013VR	1
Cylinder Head Gasket	1965-1996		VR2000	3824	1
			Nitroseal	5821SG	1
Cyl. Head Bolt Set	1994-1995			GS33351	1
Valve Cover Set	1988-1996		Victo-Tech	VS50181	1
			Cork Rubber	VS39747	1
	1968-1996		Tuff-Cork	VS39747TC	1
			Cork Rubber	VS38035	1
Valve Stem Seal, Exh.	1993-1996			B45591	6
	1992			B45404	6
	1991		Thru 2/3/91	B45373	6
			From 2/3/91	B45404	6
	1971-1990			B45373	6
	1965-1970			B45229	6
Valve Stem Seal, Int.	1992-1996		Fluoroelastomer	B45418	6
				B45373	6
	1991		Thru 2/3/91	B45373	6
			From 2/3/91	Fluoroelastomer	B45418
1965-1990			B45373	6	
Plenum Chamber Gasket	1987-1996			MS16054	1
Manifold Set, Int. & Exh.	1987-1996		(Contains Plenum Chamber Gasket)	MS16040Y	1
	1965-1986			MS16040X	1
Oil Pan Set	1988-1996		(1 Piece, One Piece) Victo-Tech	OS32489	1
	1965-1994		(Multi Piece) Cork Rubber	OS30930	1
Rear Main Seal Set	1965-1996			JV611	1
				Teflon	JV1636
Crank Repair Sleeve	1965-1996		Use With Part Number A506, Rear Nickel Plated Formed Steel, .013" Thickness	A332	1
Timing Cover Set	1965-1996			JV867	1
			(Contains Repair Sleeve)	JV931	1
Timing Cover Gasket	1965-1996			T27118	1
Timing Cover Seal	1986-1996		(Front Entry Type)	46293	1
			From 5/85, (Front Entry Type)	46293	1
	1985		Thru 5/85, (Rear Entry Type)	48023	1
			(Rear Entry Type)	48023	1
	1965-1979			46293	1
Harmonic Balancer Repair Sleeve	1965-1996		Ground Steel, .020" Thickness	66595RS	1
			Use With Part Number A502, Front Nickel Plated Formed Steel, .013" Thickness	A226-1	1

MISCELLANEOUS GASKETS

Air By-Pass Valve	1987-1996			G31324	1
Air Cleaner Mount Gasket	1965-1986		1 Barrel Carburetor	G25936	1
Carb. Mount Gasket	1979-1986		1 Barrel Carburetor, Carburetor To Spacer	G26163	1
			1 Barrel Carburetor, Spacer To Manifold	G27289	1
	1978		Canadian, 1 Barrel Carburetor, Spacer To Manifold	G26061	1
			1 Barrel Carburetor, Carburetor To Spacer	G27289	1
	1975-1977		Except Canadian Models, 1 Barrel Carburetor, Spacer To Manifold	G27289	1
		1 Barrel Carburetor, Carburetor To Manifold, Governor To Carburetor	G26056	3	

LIGHT TRUCK

41 300 CID (4.9L) Ford 6 Cyl, 4.000in./101.6mm (1965-1996) **41**
(cont.) (cont.)

Part	Year	VIN	Model/Application	Part Number	Qty.
MISCELLANEOUS GASKETS (cont.)					
Carb. Mount Gasket (cont.)	1976		Light Duty, 1 Barrel Carburetor, Carburetor To Spacer	G26058	1
	1974-1976		1 Barrel Carburetor, Spacer To Manifold	G26061	1
	1974		Standard, 1 Barrel Carburetor, Carburetor To Manifold	G26056	3
	1973-1974		Light Duty, 1 Barrel Carburetor, Carburetor To Spacer	G26058	1
	1971-1974		1 Barrel Carburetor, Governor To Carburetor	G26056	3
	1973		1 Barrel Carburetor, Carburetor To Spacer	G26058	1
	1971-1973		Governor, 1 Barrel Carburetor, Carburetor To Manifold	G26056	3
	1971		Governor, 1 Barrel Carburetor, Carburetor To Manifold, Governor To Carburetor	G26056	3
	1970		1 Barrel Carburetor, Carburetor To Manifold, Governor To Carburetor	G26056	3
	1969-1970		1 Barrel Carburetor, Carburetor To Manifold, Carburetor To Spacer, Governor To Carburetor, Governor To Manifold, Spacer To Governor	G26056	3
	1965-1969		1 Barrel Carburetor, Carburetor To Spacer, Governor To Manifold, Spacer To Governor	G26056	3
			Holley Carburetor, 1 Barrel Carburetor, Carburetor To Manifold	G26639	1
	1965-1968		Except Holley Carburetor, 1 Barrel Carburetor, Carburetor To Manifold	G26056	3
		Except Holley Carburetor, 1 Barrel Carburetor, Carburetor To Manifold, Carburetor To Spacer, Governor To Manifold, Spacer To Governor	G26056	3	
E.G.R. Gasket	1987-1995			G26703	1
	1980-1986			G26702	1
	1977-1979		Valve	G26701	1
			Valve Adapter	G26702	1
	1973-1976			G26701	1
Exhaust Pipe Gasket	1965-1983		(Ring Type 'C'), Pipe To Manifold	F17250	1
			(Ring Type 'B'), Pipe To Manifold <i>Sintered Metal</i>	F17250S	1
	1980-1982		(Flange Type), Pipe To Converter	F14627	1
Fuel Pump Gasket	1965-1986			D27094	1
				<i>Tuff-Cork</i> D27094TC	1
Injector Nozzle O-Ring	1991-1996			GS33276	3
Oil Pan Drain Plug Gst.	1965-1996			2066A	1
Oil Pump Mounting Gasket	1965-1995			B25676	1
Push Rod Cover Grommet	1965-1996			B45317	1
Push Rod Cover Set	1965-1996			PS39570	1
Throttle Body Gasket	1987-1996			G30944	1
Water Outlet Gasket	1987-1996			C30718	1
	1985-1986		Canadian	C24005	1
			Except Canadian Models	C30718	1
	1965-1984			C24005	1
	1965-1972		(2 Outer Holes)	C24109	1
Water Pump Mount Gasket	1965-1996			K27113	1

LIGHT TRUCK

42 300 CID (4.9L) Ford LPG 6 Cyl, 4.000in./101.6mm (1982-1996) **42**

Part	Year	VIN	Model/Application	Part Number	Qty.
ENGINE GASKETS					
Head Set	1993-1996		(Push Rod Cover Set Not Included)	HS3824A	1
	1992		(Push Rod Cover Set Not Included)	HS3824P	1
	1991		From 2/3/91, (Push Rod Cover Set Not Included)	HS3824P	1
			Thru 2/3/91, (Push Rod Cover Set Not Included)	HS3824Y	1
	1987-1990		(Push Rod Cover Set Not Included)	HS3824Y	1

Ford Truck

42 300 CID (4.9L) Ford LPG 6 Cyl, 4.000in./101.6mm (1982-1996) **42**
 (cont.) (cont.)

Part Year VIN Model/Application Part Number Qty.

ENGINE GASKETS (cont.)

Head Set (cont.)	1982-1986		(Push Rod Cover Set Not Included, Exhaust Pipe Gasket Not Included)	HS3824E	1
Lower Set	1993-1996		(Contains Push Rod Cover Set, Requires Head Set To Make Full Set)	CS3824	1
	1982-1986		(Contains Push Rod Cover Set, Requires Head Set To Make Full Set)	CS3824A	1
Full Set	1992			FS3824P	1
	1991		Thru 2/3/91	FS3824A	1
				From 2/3/91	FS3824P
	1988-1990			FS3824A	1
	1987			FS3824Y	1
	1982-1986		(Exhaust Pipe Gasket Not Included)	FS3824E	1
Cylinder Head Gasket	1982-1996		VR2000	3824	1
			Nitroseal	5821SG	1
Cyl. Head Bolt Set	1994-1995			GS33351	1
Valve Cover Set	1988-1996		Victo-Tech	VS50181	1
			Cork Rubber	VS39747	1
			Tuff-Cork	VS39747TC	1
Valve Stem Seal, Exh.	1993-1996			B45591	6
	1992			B45404	6
	1991		Thru 2/3/91	B45373	6
				From 2/3/91	B45404
1982-1990			B45373	6	
Valve Stem Seal, Int.	1991		Thru 2/3/91	B45373	6
				From 2/3/91	Fluoroelastomer B45418
	1982-1990			B45373	6
Plenum Chamber Gasket	1987-1996			MS16054	1
Manifold Set, Int. & Exh.	1987-1996		(Contains Plenum Chamber Gasket)	MS16040Y	1
	1982-1986			MS16040X	1
Oil Pan Set	1988-1996		(1 Piece, One Piece) Victo-Tech	OS32489	1
	1982-1987		(Multi Piece) Cork Rubber	OS30930	1
Rear Main Seal Set	1982-1996			JV611	1
				Teflon	JV1636
Crank Repair Sleeve	1982-1996		Use With Part Number A506, Rear Nickel Plated Formed Steel, .013" Thickness	A332	1
Timing Cover Set	1982-1996			JV867	1
			(Contains Repair Sleeve)	JV931	1
Timing Cover Gasket	1982-1996			T27118	1
Timing Cover Seal	1986-1996		(Front Entry Type)	46293	1
	1985		From 5/85, (Front Entry Type)	46293	1
				Thru 5/85, (Rear Entry Type)	48023
	1982-1984		(Rear Entry Type)	48023	1
Harmonic Balancer Repair Sleeve	1982-1996		Ground Steel, .020" Thickness	66595RS	1
			Use With Part Number A502, Front Nickel Plated Formed Steel, .013" Thickness	A226-1	1

MISCELLANEOUS GASKETS

Air By-Pass Valve	1987-1996			G31324	1
E.G.R. Gasket	1987-1995			G26703	1
	1982-1986			G26702	1
Exhaust Pipe Gasket	1982-1983		(Ring Type 'C'), Pipe To Manifold	F17250	1
			(Ring Type 'B'), Pipe To Manifold	Sintered Metal F17250S	1
	1982		(Flange Type), Pipe To Converter	F14627	1
Fuel Pump Gasket	1982-1986			D27094	1
				Tuff-Cork D27094TC	1
Injector Nozzle O-Ring	1991-1996			GS33276	3

42 300 CID (4.9L) Ford LPG 6 Cyl, 4.000in./101.6mm (1982-1996) **42**
(cont.) (cont.)

Part	Year	VIN	Model/Application	Part Number	Qty.
MISCELLANEOUS GASKETS (cont.)					
Oil Pan Drain Plug Gst.	1982-1996			2066A	1
Oil Pump Mounting Gasket	1982-1995			B25676	1
Push Rod Cover Grommet	1982-1996			B45317	1
Push Rod Cover Set	1982-1996			PS39570	1
Throttle Body Gasket	1987-1996			G30944	1
Water Outlet Gasket	1987-1996			C30718	1
	1985-1986		Canadian	C24005	1
			Except Canadian Models	C30718	1
	1982-1984			C24005	1
Water Pump Mount Gasket	1982-1996			K27113	1

43 302 CID (5.0L) Ford V8 Cyl, 4.000in./101.6mm (1969-2001) **43**

Part	Year	VIN	Model/Application	Part Number	Qty.
ENGINE GASKETS					
Head Set	1997-1999		(Head Bolts Not Included)	HS3530C	1
	1996		Explorer, (Head Bolts Not Included)	HS3530C	1
	1993-1996		(Head Bolts Not Included)	HS3530A	1
			Club Wagon E150, Econoline E150, Econoline E250, (Head Bolts Not Included)	HS3530A	1
	1991-1992			HS3530VY	1
	1986-1990			HS3530VR	1
	1977-1985			HS3530VK	1
	1969-1976		(Exhaust Pipe Gasket Not Included)	HS3530VJ	1
Lower Set	1988-2000		(Requires Head Set To Make Full Set, Contains 1 Piece Steel Backbone Molded Rubber Oil Pan Gasket)	CS3530	1
	1983-1987		(Requires Head Set To Make Full Set)	CS3530A	1
	1969-1982		(Requires Head Set To Make Full Set)	CS3530B	1
Full Set	1991-1992			FS3530VY	1
	1988-1990			FS3530VA	1
	1986-1987			FS3530VR	1
	1984-1985			FS3530VP	1
	1983		From 12/1/82	FS3530VP	1
	1982-1983		Thru 12/1/82	FS3530VK	1
	1977-1981			FS3530VK	1
	1969-1976		(Exhaust Pipe Gasket Not Included)	FS3530VJ	1
Engine Kit Gasket Set	1990-1995			95-3447VR	1
	1989		(Exhaust Valve Stem Seals Not Included), Use With Part Number B45399 (8)	95-3447VR	1
	1988			95-3451VR	1
	1987		Thru 4/14/87	95-3365VR	1
			From 4/15/87	95-3451VR	1
	1983-1986			95-3365VR	1
	1982		From 12/1/82	95-3365VR	1
			Thru 11/30/82	95-3367VR	1
1969-1981			95-3367VR	1	
Cylinder Head Gasket	1969-2000		VR2000	3428	2
			Nitroseal	3428SG	2
Cyl. Head Bolt Set	1969-1992			GS33316	2
Valve Cover Set	1988-2000		High Temperature Cork Rubber	VS38300H	1
			High Temperature Tuff-Cork	VS38300HTC	1
			Victo-Tech	VS38300R	1
			(Steel Reinforced, Original Equipment Type)	VS50203	1
			(Steel Reinforced, Single Valve Cover, Original Equipment Type)	VS50203S	2

LIGHT TRUCK

Ford Truck

43 302 CID (5.0L) Ford V8 Cyl, 4.000in./101.6mm (1969-2001)
(cont.)

43
(cont.)

Part	Year	VIN	Model/Application	Part Number	Qty.	
ENGINE GASKETS (cont.)						
Valve Cover Set (cont.)	1985-2000		Cork Rubber	VS38300	1	
	1987		From 4/15/87	Cork Rubber	VS38300	1
			Thru 4/14/87	Cork Rubber	VS38300	1
			From 4/15/87	High Temperature Cork Rubber	VS38300H	1
			Thru 4/14/87	High Temperature Cork Rubber	VS38300H	1
			From 4/15/87	High Temperature Tuff-Cork	VS38300HTC	1
			Thru 4/14/87	High Temperature Tuff-Cork	VS38300HTC	1
			From 4/15/87	Victo-Tech	VS38300R	1
			Thru 4/14/87	Victo-Tech	VS38300R	1
				From 4/15/87, (Steel Reinforced, Original Equipment Type)	VS50203	1
				From 4/15/87, (Steel Reinforced, Single Valve Cover, Original Equipment Type)	VS50203S	2
	1969-1986			Cork Rubber	VS38300	1
				High Temperature Cork Rubber	VS38300H	1
				High Temperature Tuff-Cork	VS38300HTC	1
				Victo-Tech	VS38300R	1
Valve Stem Seal, Exh.	1990-2000			B45904	8	
	1969-1989			B45399	8	
Valve Stem Seal, Int.	1990-2000			B45904	8	
	1986-1989		Fluoroelastomer	B45418	8	
	1969-1985			B45399	8	
Manifold Set, Exhaust	1997-2000		Nitroseal	MS16283	1	
	1996	Explorer	Nitroseal	MS16283	1	
	1981-1995			MS15129Y	1	
	1969-1980			MS15129X	1	
	Manifold Set, Intake	1997-2001		(Contains Plenum Chamber Gasket)	MS16127	1
1996			Bronco, Club Wagon E150, Econoline E150, Econoline E250, F150, F250, (Contains Plenum Chamber Gasket)	MS15202P	1	
			Explorer, (Contains Plenum Chamber Gasket)	MS16127	1	
			(Contains Plenum Chamber Gasket)	MS15202P	1	
				MS15202X	1	
				MS15172	1	
Plenum Chamber Gasket	1997-2001			MS16100	1	
	1996		Bronco, Club Wagon E150, Econoline E150, Econoline E250, F150, F250	MS15450	1	
			Explorer	MS16100	1	
	1985-1995			MS15450	1	
Oil Pan Set	1988-2001		(Steel Reinforced, Original Equipment Type) Victo-Tech	OS32491B	1	
	1988-2000		(One Piece) Victo-Tech	OS32491	1	
	1969-1995		(Multi Piece) Cork Rubber	OS30531	1	
			(Multi Piece) Tuff-Cork	OS30531TC	1	
	Rear Main Seal Set	1984-2000			JV523	1
				Teflon	JV1635	1
1983			From 12/1/82		JV523	1
			From 12/1/82	Teflon	JV1635	1
1982-1983			Thru 12/1/82	Rope Packing	JV730	1
			Thru 12/1/82	Molded Rubber	JV730R	1
1969-1981				Rope Packing	JV730	1
				Molded Rubber	JV730R	1
Crank Repair Sleeve		1983-1992		Use With Part Number A505, Rear Nickel Plated Formed Steel, .013" Thickness	A331	1
Timing Cover Set		1993-2000			JV1177	1
	1986-1992			JV1034	1	
	1969-1985			JV856	1	
			(Contains Repair Sleeve)	JV922	1	
Timing Cover Gasket	1969-2000			T27802	1	
Timing Cover Seal	1969-2001			46293	1	

LIGHT TRUCK

43 302 CID (5.0L) Ford V8 Cyl, 4.000in./101.6mm (1969-2001)

43

(cont.)

(cont.)

Part	Year	VIN	Model/Application	Part Number	Qty.	
ENGINE GASKETS (cont.)						
Harmonic Balancer Repair Sleeve	1969-1985		Front <i>Ground Steel, .020" Thickness</i>	66595RS	1	
			Use With Part Number A502, Front <i>Nickel Plated Formed Steel, .013" Thickness</i>	A226-2	1	
MISCELLANEOUS GASKETS						
Air By-Pass Valve	1987-1997			G31324	1	
Air Cleaner Mount Gasket	1982-1987		Electronic Fuel Injection <i>5-3/8" Inside Diameter</i>	G31432	1	
	1969-1987		Electronic Fuel Injection <i>5" Inside Diameter</i>	G27098	1	
Carb. Mount Gasket	1983-1985		Cast Iron Manifold, 2 Barrel Carburetor, Spacer To Manifold	G26252	1	
			Bronco, Club Wagon E150, Club Wagon E250, Econoline E150, Econoline E250, F150, F250, Aluminum Intake Manifold Spacer, Except California, Electronic Fuel Injection, Carburetor To Spacer	G30651	1	
	1980-1985		Cast Iron Manifold, Electronic Fuel Injection, Carburetor To Spacer	G26048	1	
	1983		Club Wagon E100, Econoline E100, F100, Super Wagon E150, Super Wagon E250, Aluminum Intake Manifold Spacer, Except California, 2 Barrel Carburetor, Carburetor To Spacer	G30651	1	
	1981-1982		Bronco, Club Wagon E100, Club Wagon E150, Club Wagon E250, Econoline E100, Econoline E150, Econoline E250, F100, F150, F250, Super Wagon E150, Aluminum Intake Manifold Spacer, 2 Barrel Carburetor, Carburetor To Spacer	G30651	1	
	1980-1982		Cast Iron Manifold, 2 Barrel Carburetor, Spacer To Manifold	G26740	1	
	1980		Bronco, Club Wagon E100, Club Wagon E150, Club Wagon E250, Econoline E100, Econoline E150, Econoline E250, F100, F150, F250, Super Wagon E150, Super Wagon E250, Aluminum Intake Manifold Spacer, 2 Barrel Carburetor	G30651	1	
	1975-1979		2 Barrel Carburetor, Carburetor To Spacer	G26048	1	
			2 Barrel Carburetor, Spacer To Manifold	G26740	1	
	1973-1974		2 Barrel Carburetor, Carburetor To Spacer	G26179	1	
			Club Wagon E100, Club Wagon E200, Econoline E100, Econoline E200, F100, 2 Barrel Carburetor, Spacer To Manifold	G26230	1	
	1969-1972		2 Barrel Carburetor	G26052	2	
	Dist. Mounting Gasket	1969-1997			72125	1
	E.G.R. Gasket	1997-2000			G30625	1
1996			Explorer	G26702	1	
			Bronco, Club Wagon E150, Econoline E150, Econoline E250, F150, F250	G26703	1	
1985-1995			Bronco, Club Wagon E150, Econoline E150, Econoline E250, F150, F250, Except Electronic Fuel Injection	G26702	1	
			Bronco, Club Wagon E150, Econoline E150, Econoline E250, F150, F250, Electronic Fuel Injection	G26703	1	
1985-1991			Club Wagon E250, Except Electronic Fuel Injection	G26702	1	
			Club Wagon E250, Electronic Fuel Injection	G26703	1	
1980-1984			Bronco, Club Wagon E150	G26702	1	
1979-1984			Club Wagon E250, Econoline E150, Econoline E250	G26702	1	
1977-1984			F150, F250	G26702	1	
1983			Super Wagon E250	G26702	1	
1980-1983			Super Wagon E150	G26702	1	
1979-1983			Club Wagon E100, Econoline E100	G26702	1	
1977-1983			F100	G26702	1	
1979-1980			Super Wagon E250	G26702	1	
1977-1979			Ranchero	G26702	1	
1977			Bronco	G26702	1	
1973-1976			G26701	1		
Exhaust Pipe Gasket	1980-1986		(Flange Type), Pipe To Converter	F14627	1	
	1969-1980		(Ring Type 'C'), Pipe To Manifold	F17250	1	

Ford Truck

43 302 CID (5.0L) Ford V8 Cyl, 4.000in./101.6mm (1969-2001) **43**
 (cont.) (cont.)

Part Year VIN Model/Application Part Number Qty.

MISCELLANEOUS GASKETS (cont.)

Exhaust Pipe Gasket (cont.)	1969-1980		(Ring Type 'B'), Pipe To Manifold <i>Sintered Metal</i>	F17250S	1
Fuel Pump Gasket	1969-1987			D27094	1
			<i>Tuff-Cork</i>	D27094TC	1
Injector Nozzle O-Ring	1985-1995			GS33276	4
Oil Pan Drain Plug Gst.	1993-1996		Club Wagon E150, Econoline E150, Econoline E250	2066A	1
	1969-1996			2066A	1
Oil Pump Inlet Tube	1969-1997			B26151	1
Throttle Body Gasket	1997-2001		Throttle Body To Adapter	G31579	1
	1996		Bronco, Club Wagon E150, Econoline E150, Econoline E250, F150, F250	G30941	1
			Explorer, Throttle Body To Adapter	G31579	1
	1985-1995			G30941	1
Water Outlet Gasket	1969-1998			C24005	1
Water Pump Backing Plate	1986-1997			K30707	1
	1983-1985			K27989	1
	1980-1982		Bronco, Club Wagon E150, Super Wagon E150	K27151	1
	1979-1982		Club Wagon E100, Club Wagon E250, Econoline E100, Econoline E150, Econoline E250, F150, F250	K27151	1
	1979-1980		Super Wagon E250	K27151	1
	1979		Ranchero	K27151	1
	1970-1978		F100	K27151	3
	1969-1977		Bronco	K27142	1
	1973-1974		Club Wagon E100, Econoline E100	K27142	1
	1969-1974		Club Wagon E200, Club Wagon E300, Econoline E200, Econoline E300	K27142	1
	Water Pump Mount Gasket	1997-2000			K27988
1996			Explorer	K27988	1
			Bronco, Club Wagon E150, Econoline E150, Econoline E250, F150, F250	K30708	1
1987-1995				K30708	1
1969-1986				K27955	1

44 302 CID (5.0L) Ford LPG V8 Cyl, 4.000in./101.6mm (1969-1986) **44**

Part Year VIN Model/Application Part Number Qty.

ENGINE GASKETS

Head Set	1981-1985			HS3530VK	1
Cyl. Head Bolt Set	1969-1986			GS33316	2

45 330 CID (5.4L) OHV Ford V8 Cyl, 3.875in./98.4mm (1964-1978) **45**

Part Year VIN Model/Application Part Number Qty.

ENGINE GASKETS

Head Set	1964-1978		(Exhaust Pipe Gasket Not Included)	HS3417Y	1
Full Set	1964-1972		Heavy Duty Engine, (Exhaust Pipe Gasket Not Included)	FS3417Y	1
			Standard Duty Engine, (Exhaust Pipe Gasket Not Included)	FS3417Z	1
Engine Kit Gasket Set	1964-1978		Heavy Duty Engine, (Exhaust Manifold Heat Shield Gasket Not Included), Use With Part Number MS15573	95-3431VR	1
			Medium Duty Engine, (Exhaust Manifold Heat Shield Gasket Not Included), Use With Part Number MS15573	95-3431VR	1
	1964-1972		Medium Duty Engine, (Exhaust Manifold Heat Shield Gasket Not Included), Use With Part Number MS15573	95-3430VR	1
Cylinder Head Gasket	1964-1978		<i>VR2000</i>	3417	2
Valve Cover Set	1964-1978		<i>Cork Rubber</i>	VS38308	1
			<i>Victo-Tech</i>	VS38308R	1

Part	Year	VIN	Model/Application	Part Number	Qty.
ENGINE GASKETS (cont.)					
Valve Stem Seal, Exh.	1964-1978		Heavy Duty Engine	B45229	8
			Standard Duty Engine	B45390	8
Valve Stem Seal, Int.	1964-1978			B45390	8
Manifold Set, Exhaust	1964-1978		Heat Shield Type	MS15573	1
				MS15969	1
Manifold Set, Intake	1964-1978			MS15133	1
Oil Pan Set	1964-1978		Cork Rubber	OS30764	1
Rear Main Seal Set	1964-1978		Rope Packing	JV707	1
			Molded Rubber	JV707P	1
				JV847	1
Timing Cover Set	1973-1978			JV847	1
	1964-1972		Standard Duty Engine	JV819	1
			Heavy Duty Engine	JV847	1
			Standard Duty Engine, (Contains Repair Sleeve)	JV921	1
Timing Cover Gasket	1964-1972		Standard Duty Engine	T27798	1
Timing Cover Seal	1973-1978			46442	1
	1964-1972		Standard Duty Engine	46293	1
			Heavy Duty Engine	46442	1
Harmonic Balancer Repair Sleeve	1964-1972		Standard Duty Engine		
			Standard Duty Engine, Use With Part Number A502 Nickel Plated Formed Steel, .013" Thickness	66595RS A226-2	1 1

MISCELLANEOUS GASKETS

Carb. Mount Gasket	1973-1977		Except California Emission, Medium Duty Engine, 1 Barrel Carburetor, Carburetor To Spacer	G26072	2
			Extra Heavy Duty, Heavy Duty Engine, 1 Barrel Carburetor, Carburetor To Spacer	G26073	2
			Extra Heavy Duty, Heavy Duty Engine, 2 Barrel Carburetor, Carburetor To Spacer	G26703	1
	1965-1977		1 Barrel Carburetor, Governor To Carburetor	G26072	2
			1 Barrel Carburetor, Governor To Manifold	G26072	2
			1 Barrel Carburetor, Spacer To Manifold	G26072	2
	1965-1972		Medium Duty Engine, 1 Barrel Carburetor, Carburetor To Spacer	G26072	2
			Heavy Duty Engine, 1 Barrel Carburetor, Carburetor To Spacer	G26073	2
	1964		2 Barrel Carburetor, Governor To Carburetor	G26052	2
			1 Barrel Carburetor, Governor To Carburetor, Governor To Manifold	G26052	2
		1 Barrel Carburetor, Carburetor To Manifold	G26072	2	
		1 Barrel Carburetor, Carburetor To Spacer	G26072	2	
Dist. Mounting Gasket	1964-1978			B25212	1
E.G.R. Gasket	1975-1978			G26701	1
Exhaust Pipe Gasket	1964-1978		(Ring Type 'C'), Pipe To Manifold	F7186	2
			(Ring Type 'B'), Pipe To Manifold Sintered Metal	F7199	2
Fuel Pump Bowl Gasket	1964-1968			D36016	1
Fuel Pump Gasket	1964-1978			D27094	1
				D27094TC	1
				Tuff-Cork	
Oil Filter Gasket	1964-1978		Adapter To Block	B25451	1
Oil Pan Drain Plug Gst.	1964-1978			2066A	1
Oil Pump Inlet Tube	1964-1978			B26151	1
Oil Pump Mounting Gasket	1964-1978			B25412	1
Water Outlet Gasket	1973-1978		Upper	C24109	1
			Lower	C25487	1
	1964-1972			C25487	1
Water Pump Backing Plate	1964-1978			K27079	1

Ford Truck

45	330 CID (5.4L) OHV Ford V8 Cyl, 3.875in./98.4mm (1964-1978)	45
(cont.)		(cont.)

Part	Year	VIN	Model/Application	Part Number	Qty.
MISCELLANEOUS GASKETS (cont.)					
Water Pump Mount Gasket	1973-1978			K27827	1
	1964-1972		Standard Duty Engine	K26442	2
				Heavy Duty Engine	K27827

46	330 CID (5.4L) Triton DOHC Ford Windsor V8 Cyl, 3.550in./90.1mm (1999-2002)	46
-----------	--	-----------

Part	Year	VIN	Model/Application	Part Number	Qty.
ENGINE GASKETS					
Plenum Chamber Gasket	1999-2002		<i>Victo-Tech</i>	MS16363	1
Oil Pan Set	1999-2002		<i>Victo-Tech</i>	OS32517	1
Rear Main Seal Set	1999-2002			JV1612	1

MISCELLANEOUS GASKETS					
Thermostat O-Ring	1999-2002			C31302	1
Throttle Body Gasket	1999-2002			G31575	1
Water Pump Mount Gasket	1999-2002			K31309	1

47	330 CID (5.4L) Triton SOHC Ford Windsor V8 Cyl, 3.551in./90.2mm (1997-2003)	47
-----------	--	-----------

Part	Year	VIN	Model/Application	Part Number	Qty.
ENGINE GASKETS					
Head Set	1997-1999		(Head Bolts Not Included, Plenum Chamber Gasket Not Included, Intake Manifold Gasket Not Included)	HS5931E	1
Lower Set	1999-2000		(Requires Head Set To Make Full Set)	CS5931B	1
	1997-1998		(Requires Head Set To Make Full Set)	CS5931A	1
Cylinder Head Gasket	1997-2001		Left <i>Nitroseal</i>	5931	1
			Right <i>Nitroseal</i>	5932	1
Cyl. Head Bolt Set	1997-2003			GS33269	2
Valve Cover Set	1997-2001		<i>Victo-Tech</i>	VS50275	1
Valve Stem Seal, Exh.	1997-2001			B45892	8
Valve Stem Seal, Int.	1997-2001			B45892	8
Manifold Set, Exhaust	1997-2003		<i>Nitroseal</i>	MS16112	1
Manifold Set, Intake	2000		<i>Victo-Tech</i>	MS16296	1
	1999		Expedition, F150, F250, Navigator <i>Victo-Tech</i>	MS16296	1
			Econoline E250 Ext., Econoline E250 Super Duty, Econoline E350 Super Duty, Econoline E350 Super Duty Ext., F250 Super Duty, F350 Super Duty, Wagon E350 Super Duty, Wagon E350 Super Duty Ext. <i>Victo-Tech</i>	MS16297	1
			Club Wagon E150, Econoline E150, Econoline E250 <i>Victo-Tech</i>	MS16297	1
	1998		Navigator, Thru 7/20/97, (Contains Plenum Chamber Gasket) <i>Victo-Tech</i>	MS16260-1	1
			Club Wagon E350, Econoline E350, Expedition, F150, F250 <i>Victo-Tech</i>	MS16297	1
			Navigator, From 7/21/97 <i>Victo-Tech</i>	MS16297	1
1997		F150, F250, (Contains Plenum Chamber Gasket) <i>Victo-Tech</i>	MS16260-1	1	
		Club Wagon E150, Club Wagon E350, Econoline E150, Econoline E250, Econoline E350, Expedition, Thru 7/20/97, (Contains Plenum Chamber Gasket) <i>Victo-Tech</i>	MS16260-1	1	
		Club Wagon E150, Club Wagon E350, Econoline E150, Econoline E250, Econoline E350, Expedition, From 7/21/97 <i>Victo-Tech</i>	MS16297	1	
Plenum Chamber Gasket	1999		Expedition, F150, F250, Navigator <i>Victo-Tech</i>	MS16295	1

LIGHT TRUCK

47 330 CID (5.4L) Triton SOHC Ford Windsor V8 Cyl, 3.551in./90.2mm (1997-2003) **47**
(cont.) (cont.)

Part	Year	VIN	Model/Application	Part Number	Qty.
ENGINE GASKETS (cont.)					
Plenum Chamber Gasket (cont.)	1999		Club Wagon E150, Econoline E150, Econoline E250, Econoline E250 Ext., Econoline E250 Super Duty, Econoline E350 Super Duty, Econoline E350 Super Duty Ext., F250 Super Duty, F350 Super Duty, Wagon E350 Super Duty, Wagon E350 Super Duty Ext.		
				<i>Victo-Tech</i> MS16301	1
	1997-1998			<i>Victo-Tech</i> MS16301	1
Oil Pan Set	1997-2003			<i>Victo-Tech</i> OS32517	1
Rear Main Seal Set	1997-2001			JV1612	1
Timing Cover Set	1999-2001			<i>Victo-Tech</i> JV5014	1
	1997-1998			<i>Victo-Tech</i> JV5010	1
Timing Cover Seal	1999-2001			67616	1
	1997-1998			48322	1

MISCELLANEOUS GASKETS

Injector Nozzle O-Ring	1997-1999			GS33276	4
Oil Filter Adapt Gasket	1997-2001			<i>Victo-Tech</i> B31584	1
Thermostat O-Ring	1997-2001			C31302	1
Throttle Body Gasket	2000-2001		Except Lightning	<i>Victo-Tech</i> G31586	1
	2000		Excursion, Throttle Body To Adapter	G31569	1
	1997-2000		Throttle Body To Adapter	G31569	1
	1997-1999		Adapter To Manifold	G31570	1
Water Crossover Mount Set	2000-2001			<i>Victo-Tech</i> B31585	1
Water Pump Mount Gasket	1997-2001			K31309	1

48 330 CID (5.4L) Triton SOHC Ford Windsor Bi-Fuel Gasoline/Compressed Natural Gas V8 Cyl, 3.551in./90.2mm (1998-2003) **48**

Part	Year	VIN	Model/Application	Part Number	Qty.
ENGINE GASKETS					
Head Set	1998-1999		(Head Bolts Not Included, Plenum Chamber Gasket Not Included, Intake Manifold Gasket Not Included)	HS5931E	1
Cylinder Head Gasket	1998-2001		Left	<i>Nitroseal</i> 5931	1
			Right	<i>Nitroseal</i> 5932	1
Cyl. Head Bolt Set	1998-2003			GS33269	2
Valve Stem Seal, Exh.	1998-2001			B45892	8
Valve Stem Seal, Int.	1998-2001			B45892	8
Manifold Set, Exhaust	1998-2003			<i>Nitroseal</i> MS16112	1
Manifold Set, Intake	2000		F150, (Plenum Chamber Gasket Not Included)	<i>Victo-Tech</i> MS16296	1
			Econoline E250, Econoline E250 Ext., Econoline E250 Super Duty, Econoline E350 Super Duty, Econoline E350 Super Duty Ext., F150, Wagon E350 Super Duty, Wagon E350 Super Duty Ext., Except Reduced Coolant Port, (Plenum Chamber Gasket Not Included)	<i>Victo-Tech</i> MS16296	1
	1999		Navigator, Except Reduced Coolant Port, (Plenum Chamber Gasket Not Included)	<i>Victo-Tech</i> MS16296	1
			Econoline E250 Ext., Econoline E250 Super Duty, Econoline E350 Super Duty, Econoline E350 Super Duty Ext., Wagon E350 Super Duty, Wagon E350 Super Duty Ext.	<i>Victo-Tech</i> MS16297	1
	1998-1999		Econoline E250, F150, F250	<i>Victo-Tech</i> MS16297	1
	1998		Econoline E350, Expedition, Navigator	<i>Victo-Tech</i> MS16297	1
Oil Pan Set	1998-2003			<i>Victo-Tech</i> OS32517	1
Rear Main Seal Set	1998-2001			JV1612	1

Ford Truck

49 330 CID (5.4L) Triton SOHC Ford Windsor CNG V8 Cyl, 3.551in./90.2mm (1997-2003)

49

Part	Year	VIN	Model/Application	Part Number	Qty.
ENGINE GASKETS					
Head Set	1997-1999		(Head Bolts Not Included, Plenum Chamber Gasket Not Included, Intake Manifold Gasket Not Included)	HS5931E	1
Cylinder Head Gasket	1997-2001	Left	Nitroseal	5931	1
		Right	Nitroseal	5932	1
Cyl. Head Bolt Set	1997-2003			GS33269	2
Valve Stem Seal, Exh.	1997-2001			B45892	8
Valve Stem Seal, Int.	1997-2001			B45892	8
Manifold Set, Exhaust	1997-2003		Nitroseal	MS16112	1
Manifold Set, Intake	2000		Econoline E250, Econoline E250 Ext., Econoline E250 Super Duty, Econoline E350 Super Duty, Econoline E350 Super Duty Ext., F150, Wagon E350 Super Duty, Wagon E350 Super Duty Ext., Except Reduced Coolant Port, (Plenum Chamber Gasket Not Included) Victo-Tech	MS16296	1
	1999		Econoline E250 Ext., Econoline E250 Super Duty, Econoline E350 Super Duty, Econoline E350 Super Duty Ext., F150, Wagon E350 Super Duty, Wagon E350 Super Duty Ext. Victo-Tech	MS16297	1
	1998-1999		Econoline E250, F250 Victo-Tech	MS16297	1
	1998		Club Wagon E150, Club Wagon E350, Econoline E150, Econoline E350 Victo-Tech	MS16297	1
	1997		Club Wagon E150, Club Wagon E350, Econoline E150, Econoline E250, Econoline E350, F250, Thru 7/20/97, (Contains Plenum Chamber Gasket) Victo-Tech	MS16260-1	1
			Club Wagon E150, Club Wagon E350, Econoline E150, Econoline E250, Econoline E350, F250, From 7/21/97 Victo-Tech	MS16297	1
Oil Pan Set	1997-2003		Victo-Tech	OS32517	1
Rear Main Seal Set	1997-2001			JV1612	1

50 351 CID (5.8L) 351M Ford V8 Cyl, 4.000in./101.6mm (1975-1982)

50

Part	Year	VIN	Model/Application	Part Number	Qty.
ENGINE GASKETS					
Head Set	1975-1982		(Intake Manifold Gasket Not Included)	HS3502	1
Full Set	1975-1982		(Intake Manifold Gasket Not Included)	FS3502	1
Engine Kit Gasket Set	1975-1982		(Intake Manifold Gasket Not Included), Use With Part Number MS15938	95-3030VR	1
Cylinder Head Gasket	1975-1982		VR2000	3502	2
			Nitroseal	3502SG	2
Cyl. Head Bolt Set	1977-1982			GS33346	2
Valve Cover Set	1975-1982		Cork Rubber	VS38422	1
			(Contains Gasket With Pre-inserted Grommets) Grommeted Cork-Rubber	VS38422GR	1
			High Temperature Cork Rubber	VS38422H	1
			Victo-Tech	VS38422R	1
			Tuff-Cork	VS38422TC	1
Valve Stem Seal, Exh.	1975-1982			B45399	8
Valve Stem Seal, Int.	1975-1982			B45399	8
Manifold Set, Exhaust	1975-1982			MS15197	1
Manifold Set, Intake	1975-1982			MS15938	1
Oil Pan Set	1975-1982		Cork Rubber	OS30543	1
			Tuff-Cork	OS30543TC	1
Rear Main Seal Set	1975-1982		Molded Rubber	JV614	1
			Rope Packing	JV730	1
Timing Cover Set	1975-1982			JV869	1
			(Contains Repair Sleeve)	JV933	1
Timing Cover Gasket	1975-1982			T27150	1
Timing Cover Seal	1975-1982			46293	1
Harmonic Balancer Repair Sleeve	1975-1982		Ground Steel, .020" Thickness	66595RS	1

LIGHT TRUCK

50 351 CID (5.8L) 351M Ford V8 Cyl, 4.000in./101.6mm (1975-1982) **50**
(cont.) (cont.)

Part	Year	VIN	Model/Application	Part Number	Qty.
ENGINE GASKETS (cont.)					
Harmonic Balancer Repair Sleeve (cont.)	1975-1982		Use With Part Number A502 <i>Nickel Plated Formed Steel, .013" Thickness</i>	A226-2	1
MISCELLANEOUS GASKETS					
Carb. Mount Gasket	1977-1981		2 Barrel Carburetor, Spacer To Manifold	G26746	1
	1975-1981		2 Barrel Carburetor, Carburetor To Spacer	G26741	1
	1977-1979		Canadian, 2 Barrel Carburetor, Spacer To Manifold	G26074	1
	1975-1976		2 Barrel Carburetor, Spacer To Manifold	G26074	1
Choke Tube Gasket	1975-1979			B45788	1
Dist. Mounting Gasket	1975-1981			72125	1
	1977-1979		(Tapered Washer)	B25212	1
E.G.R. Gasket	1977-1982			G26702	1
	1975-1976			G26701	1
Fuel Pump Gasket	1975-1982			D24006	1
Oil Pan Drain Plug Gst.	1975-1982			2066A	1
Oil Pump Mounting Gasket	1977-1982			B25211	1
Water Outlet Gasket	1975-1982			C26650	1
Water Pump Backing Plate	1975-1982			K27151	1
Water Pump Mount Gasket	1975-1982			K27158	1

51 351 CID (5.8L) 351M Ford LPG V8 Cyl, 4.000in./101.6mm (1975-1982) **51**

Part	Year	VIN	Model/Application	Part Number	Qty.
ENGINE GASKETS					
Cyl. Head Bolt Set	1977-1982			GS33346	2
Valve Cover Set	1975-1979		<i>Grommited Cork-Rubber</i>	VS38422GR	1

52 351 CID (5.8L) 351C Ford Cleveland V8 Cyl, 4.000in./101.6mm (1970-1974) **52**

Part	Year	VIN	Model/Application	Part Number	Qty.
ENGINE GASKETS					
Head Set	1970-1974		(Intake Manifold Gasket Not Included)	HS3502	1
Full Set	1970-1974		(Intake Manifold Gasket Not Included)	FS3502	1
Cylinder Head Gasket	1970-1974		<i>VR2000</i>	3502	2
			<i>Nitroseal</i>	3502SG	2
Cyl. Head Bolt Set	1970-1974			GS33346	2
Valve Cover Set	1971-1974		(Contains Gasket With Pre-inserted Grommets)	VS38422GR	1
			<i>Cork Rubber</i>	VS38422	1
			<i>High Temperature Cork Rubber</i>	VS38422H	1
			<i>Victo-Tech</i>	VS38422R	1
			<i>Tuff-Cork</i>	VS38422TC	1
Valve Stem Seal, Exh.	1970-1974			B45399	8
Valve Stem Seal, Int.	1970-1974			B45399	8
Manifold Set, Exhaust	1970-1974			MS15197	1
Manifold Set, Intake	1971-1974		2 Barrel Carburetor	MS15815	1
	1970-1971		4 Barrel Carburetor	MS15816	1
Oil Pan Set	1970-1974		<i>Cork Rubber</i>	OS30543	1
			<i>Tuff-Cork</i>	OS30543TC	1
Rear Main Seal Set	1970-1974		<i>Molded Rubber</i>	JV614	1
			<i>Rope Packing</i>	JV730	1
Timing Cover Set	1970-1974			JV869	1
			(Contains Repair Sleeve)	JV933	1
Timing Cover Gasket	1970-1974			T27150	1
Timing Cover Seal	1970-1974			46293	1

Ford Truck

52 <small>(cont.)</small>	351 CID (5.8L) 351C Ford Cleveland V8 Cyl, 4.000in./101.6mm (1970-1974)	52 <small>(cont.)</small>
-------------------------------------	--	-------------------------------------

Part	Year	VIN	Model/Application	Part Number	Qty.
ENGINE GASKETS (cont.)					
Harmonic Balancer Repair Sleeve	1970-1974		<i>Ground Steel, .020" Thickness</i>	66595RS	1
			<i>Use With Part Number A502 Nickel Plated Formed Steel, .013" Thickness</i>	A226-2	1

MISCELLANEOUS GASKETS					
Air Cleaner Mount Gasket	1971-1974		2 Barrel Carburetor	G27098	1
Carb. Mount Gasket	1973-1974		2 Barrel Carburetor, Carburetor To Spacer	G26048	1
			2 Barrel Carburetor, Spacer To Manifold	G26050	1
Dist. Mounting Gasket	1970-1974		2 Barrel Carburetor	G26744	1
			(O-Ring Type)	72125	1
E.G.R. Gasket	1973-1974		(Tapered Washer)	B25212	1
			Valve	G26701	1
Fuel Pump Gasket	1973		To Valve Body	G24662	1
				D24006	1
Fuel Pump Gasket	1970-1974			D24006	1
Oil Pan Drain Plug Gst.	1970-1974			2066A	1
Oil Pump Mounting Gasket	1970-1974			B25211	1
Water Outlet Gasket	1970-1974			C26650	1
Water Pump Mount Gasket	1970-1974			K27151	1

53	351 CID (5.8L) Ford Windsor LPG V8 Cyl, 4.000in./101.6mm (1970-1994)	53
-----------	---	-----------

Part	Year	VIN	Model/Application	Part Number	Qty.
ENGINE GASKETS					
Engine Kit Gasket Set	1994			95-3460VR	1
Timing Cover Gasket	1971-1974			T27802	1
Timing Cover Seal	1970			46293	1

54	351 CID (5.8L) 351W Ford Windsor V8 Cyl, 4.000in./101.6mm (1969-1997)	54
-----------	--	-----------

Part	Year	VIN	Model/Application	Part Number	Qty.
ENGINE GASKETS					
Head Set	1994-1997			HS3428A	1
	1987-1993			HS3428R	1
	1986		From 7/21/86, (1 Piece Intake Manifold Gasket Not Included)	HS3428R	1
			Thru 7/21/86, (1 Piece Intake Manifold Gasket Not Included)	HS3428Y	1
	1975-1985		(1 Piece Intake Manifold Gasket Not Included)	HS3428Y	1
	1969-1974		(Exhaust Pipe Gasket Not Included)	HS3428E	1
Lower Set	1993-1997		(Requires Head Set To Make Full Set)	CS3428	1
Full Set	1988-1993			FS3428A	1
	1987		(1 Piece Intake Manifold Gasket Not Included)	FS3428R	1
	1986		Thru 7/21/86, (1 Piece Intake Manifold Gasket Not Included)	FS3428P	1
			From 7/21/86, (1 Piece Intake Manifold Gasket Not Included)	FS3428R	1
	1984-1985		(1 Piece Intake Manifold Gasket Not Included)	FS3428P	1
	1983		From 7/11/83, (1 Piece Intake Manifold Gasket Not Included)	FS3428P	1
			Thru 7/11/83, (1 Piece Intake Manifold Gasket Not Included)	FS3428Y	1
	1975-1982		(1 Piece Intake Manifold Gasket Not Included)	FS3428Y	1
	1969-1974		(Exhaust Pipe Gasket Not Included)	FS3428E	1
	Engine Kit Gasket Set	1994-1997			95-3460VR
1988-1993				95-3379VR	1
1987			Thru 5/31/87, (Valve Stem Seals Not Included), Use With Part Numbers B45418 (8), B45404 (8)	95-3364VR	1
		From 6/1/87	95-3379VR	1	

LIGHT TRUCK

Part	Year	VIN	Model/Application	Part Number	Qty.	
ENGINE GASKETS (cont.)						
Engine Kit Gasket Set (cont.)	1986		From 7/22/86, (Valve Stem Seals Not Included), Use With Part Numbers B45418 (8), B45404 (8)	95-3364VR	1	
			Over 8500 Pound Gross Vehicle Weight, Thru 7/21/86, (Intake Manifold Gasket Not Included), Use With Part Number MS15942	95-3364VR	1	
			Thru 7/21/86, Under 8500 Pound Gross Vehicle Weight	95-3364VR	1	
	1984-1985		Over 8500 Pound Gross Vehicle Weight, (Intake Manifold Gasket Not Included), Use With Part Number MS15942	95-3364VR	1	
			Over 8500 Pound Gross Vehicle Weight, Under 8500 Pound Gross Vehicle Weight, (Intake Manifold Gasket Not Included), Use With Part Number MS15942	95-3364VR	1	
			Under 8500 Pound Gross Vehicle Weight	95-3364VR	1	
	1983		E100/E250/F Series, Thru 7/10/83	95-3036VR	1	
			E150/E350, Thru 7/10/83, (Intake Manifold Gasket Not Included), Use With Part Number MS15942	95-3036VR	1	
			From 7/11/83, Over 8500 Pound Gross Vehicle Weight, (Intake Manifold Gasket Not Included), Use With Part Number MS15942	95-3364VR	1	
			From 7/11/83, Over 8500 Pound Gross Vehicle Weight, Under 8500 Pound Gross Vehicle Weight, (Intake Manifold Gasket Not Included), Use With Part Number MS15942	95-3364VR	1	
			From 7/11/83, Under 8500 Pound Gross Vehicle Weight	95-3364VR	1	
	1975-1982		E100/E250/F Series	95-3036VR	1	
			E150/E350, (Intake Manifold Gasket Not Included), Use With Part Number MS15942	95-3036VR	1	
	1969-1974			95-3029VR	1	
	Cylinder Head Gasket	1969-1997		<i>VR2000</i>	3428	2
			<i>Nitroseal</i>	3428SG	2	
Cyl. Head Bolt Set	1973-1994			GS33345	2	
Valve Cover Set	1988-1997		<i>Cork Rubber</i>	VS38300	1	
			<i>High Temperature Cork Rubber</i>	VS38300H	1	
			<i>High Temperature Tuff-Cork</i>	VS38300HTC	1	
			<i>Victo-Tech</i>	VS38300R	1	
			(Steel Reinforced, Original Equipment Type)	VS50203	1	
			(Steel Reinforced, Single Valve Cover, Original Equipment Type)	VS50203S	2	
	1987		From 5/29/87	<i>Cork Rubber</i>	VS38300	1
			Thru 5/28/87	<i>Cork Rubber</i>	VS38300	1
			From 5/29/87	<i>High Temperature Cork Rubber</i>	VS38300H	1
			Thru 5/28/87	<i>High Temperature Cork Rubber</i>	VS38300H	1
			From 5/29/87	<i>High Temperature Tuff-Cork</i>	VS38300HTC	1
			Thru 5/28/87	<i>High Temperature Tuff-Cork</i>	VS38300HTC	1
			From 5/29/87	<i>Victo-Tech</i>	VS38300R	1
			Thru 5/28/87	<i>Victo-Tech</i>	VS38300R	1
		From 5/29/87, (Steel Reinforced, Original Equipment Type)		VS50203	1	
		From 5/29/87, (Steel Reinforced, Single Valve Cover, Original Equipment Type)		VS50203S	2	
	1969-1986			<i>Cork Rubber</i>	VS38300	1
				<i>High Temperature Cork Rubber</i>	VS38300H	1
			<i>High Temperature Tuff-Cork</i>	VS38300HTC	1	
			<i>Victo-Tech</i>	VS38300R	1	
Valve Stem Seal, Exh.	1994-1997			B45591A	8	
	1987-1993			B45404	8	
	1986		Thru 6/86		B45399	8
			From 7/1/86		B45404	8
	1969-1985			B45399	8	
Valve Stem Seal, Int.	1987-1997		<i>Fluoroelastomer</i>	B45418	8	
	1986		Thru 6/86		B45399	8
			From 7/1/86	<i>Fluoroelastomer</i>	B45418	8
	1969-1985			B45399	8	

LIGHT TRUCK

Ford Truck

54 351 CID (5.8L) 351W Ford Windsor V8 Cyl, 4.000in./101.6mm (1969-1997) **54**
 (cont.) (cont.)

Part Year VIN Model/Application Part Number Qty.

ENGINE GASKETS (cont.)

Manifold Set, Exhaust	1969-1997			MS15129Y	1
Manifold Set, Intake	1988-1997		(Contains Plenum Chamber Gasket)	MS15202W	1
	1975-1987		Under 8500 Pound Gross Vehicle Weight	MS15202	1
				Over 8500 Pound Gross Vehicle Weight, (1 Piece Design)	MS15942
	1969-1974			MS15173W	1
Plenum Chamber Gasket	1988-1997			MS15452	1
Oil Pan Set	1994-1997		(Steel Reinforced) <i>Victo-Tech</i>	OS32144	1
	1988-1997		<i>Victo-Tech</i>	OS32492	1
	1969-1993		(Multi Piece) <i>Cork Rubber</i>	OS30541	1
			(Multi Piece) <i>Tuff-Cork</i>	OS30541TC	1
			(Multi Piece, Contains Gasket With Pre-inserted Grommets)	OS32173GR	1
	1969-1970		(Optional, One Piece) <i>Victo-Tech</i>	OS32492	1
Rear Main Seal Set	1984-1997			JV611	1
			<i>Teflon</i>	JV1636	1
	1983		From 7/11/83	JV611	1
			Thru 7/11/83 <i>Molded Rubber</i>	JV614	1
			Thru 7/11/83 <i>Rope Packing</i>	JV730	1
			From 7/11/83 <i>Teflon</i>	JV1636	1
	1969-1982		<i>Molded Rubber</i>	JV614	1
			<i>Rope Packing</i>	JV730	1
Crank Repair Sleeve	1983-1996		Use With Part Number A506, Rear <i>Nickel Plated Formed Steel, .013" Thickness</i>	A332	1
Timing Cover Set	1993-1997			JV1177	1
	1986-1992			JV1034	1
	1969-1985			JV856	1
			(Contains Repair Sleeve)	JV922	1
Timing Cover Gasket	1969-1994			T27802	1
Timing Cover Seal	1969-1997			46293	1
Harmonic Balancer Repair Sleeve	1969-1985		<i>Ground Steel, .020" Thickness</i>	66595RS	1
			Use With Part Number A502 <i>Nickel Plated Formed Steel, .013" Thickness</i>	A226-2	1

MISCELLANEOUS GASKETS

Air Cleaner Mount Gasket	1982-1987		4 Barrel Carburetor <i>5" Inside Diameter</i>	G27098	1
			4 Barrel Carburetor <i>5-3/8" Inside Diameter</i>	G31432	1
	1975-1978		2 Barrel Carburetor	G27098	1
Carb. Mount Gasket	1985-1987		4 Barrel Carburetor, Spacer To Manifold	G25178	1
			4 Barrel Carburetor, Carburetor To Spacer	G26183	1
			4 Barrel Carburetor, Carburetor To Manifold	G30618	1
	1983-1985		2 Barrel Carburetor, Spacer To Manifold	G26252	1
	1975-1985		2 Barrel Carburetor, Carburetor To Spacer	G26048	1
	1975-1982		2 Barrel Carburetor, Spacer To Manifold	G26740	1
	1969		4 Barrel Carburetor	G27190	1
Dist. Mounting Gasket	1975-1997			72125	1
	1969-1972		(Tapered Washer)	B25212	1
	1969		(O-Ring Type)	72125	1
Exhaust Air Supply Tube	1980-1987			B45834	1
E.G.R. Gasket	1993-1997		F250, F350	G26703	1
	1990-1996		F150	G26703	1
	1990-1994		Bronco, Club Wagon E150, Club Wagon E350, Econoline E150, Econoline E250, Econoline E350	G26703	1
	1990-1992		F350	G26703	1
	1990-1991		Club Wagon E250	G26703	1
	1978-1989			G26702	1
	1977		Valve	G26701	1

54 351 CID (5.8L) 351W Ford Windsor V8 Cyl, 4.000in./101.6mm (1969-1997) **54**
(cont.) (cont.)

Part	Year	VIN	Model/Application	Part Number	Qty.
MISCELLANEOUS GASKETS (cont.)					
E.G.R. Gasket (cont.)	1977		Valve Adapter	G26702	1
	1975-1976			G26701	1
Exhaust Pipe Gasket	1988-1997		(Flange Type), Pipe To Converter	F14762	1
	1986		Bronco, Club Wagon E150, Club Wagon E250, Club Wagon E350, Econoline E150, Econoline E250, Econoline E350, (Flange Type), Pipe To Converter	F14627	1
	1985-1986		F150, F250, F350, (Flange Type), Pipe To Converter	F14627	1
	1984-1985		Club Wagon E250, Econoline E250, (Flange Type), Pipe To Converter	F12306	1
	1984		Bronco, Club Wagon E150, Club Wagon E350, Econoline E150, Econoline E350, F150, F250, F350, (Flange Type), Pipe To Converter	F12306	1
	1975-1978		(Ring Type 'C'), Pipe To Manifold	F17250	1
			(Ring Type 'B'), Pipe To Manifold <i>Sintered Metal</i>	F17250S	1
1969-1974		(Ring Type 'B'), Pipe To Manifold	F17945	2	
Fuel Pump Gasket	1969-1987			D27094	1
			<i>Tuff-Cork</i>	D27094TC	1
Injector Nozzle O-Ring	1988-1996			GS33276	4
Oil Pan Drain Plug Gst.	1969-1993			2066A	1
Oil Pump Inlet Tube	1969-1989			B26151	1
Oil Pump Mounting Gasket	1969-1972			B25210	1
Throttle Body Gasket	1988-1997			G30941	1
Water Outlet Gasket	1969-1997			C24005	1
Water Pump Backing Plate	1986-1997			K30707	1
	1983-1985			K27989	1
	1975-1982			K27151	1
	1969-1970			K27142	1
Water Pump Mount Gasket	1988-1997			K30708	1
	1969-1987			K27955	1

55 351 CID (5.8L) High Performance Ford Windsor V8 Cyl, 4.000in./101.6mm (1993-1996) **55**

Part	Year	VIN	Model/Application	Part Number	Qty.
ENGINE GASKETS					
Lower Set	1993-1996		(Requires Head Set To Make Full Set)	CS3428	1
Cylinder Head Gasket	1993-1996		<i>VR2000</i>	3428	2
			<i>Nitroseal</i>	3428SG	2
Valve Cover Set	1993-1996		(Steel Reinforced) <i>Victo-Tech</i>	VS50203	1
			(Steel Reinforced, Single Valve Cover) <i>Victo-Tech</i>	VS50203S	2
Valve Stem Seal, Exh.	1994-1996			B45591A	8
	1993			B45404	8
Valve Stem Seal, Int.	1993-1996		<i>Fluoroelastomer</i>	B45418	8
Manifold Set, Exhaust	1993-1996		<i>Nitroseal</i>	MS16283	1
Manifold Set, Intake	1993-1996	R	(Contains Plenum Chamber Gasket)	MS16127W	1
Plenum Chamber Gasket	1993-1996	R		MS16100	1
Oil Pan Set	1994-1996		(Steel Reinforced) <i>Victo-Tech</i>	OS32144	1
	1993-1996		<i>Victo-Tech</i>	OS32492	1
Rear Main Seal Set	1993-1996			JV611	1
			<i>Teflon</i>	JV1636	1
Crank Repair Sleeve	1993-1996		Use With Part Number A506, Rear <i>Nickel Plated Formed Steel, .013" Thickness</i>	A332	1
Timing Cover Set	1993-1996			JV1177	1
Timing Cover Gasket	1993-1994			T27802	1
Timing Cover Seal	1993-1996	R		46293	1

Ford Truck

55 351 CID (5.8L) High Performance Ford Windsor V8 Cyl, 4.000in./101.6mm (1993-1996) **55**
(cont.) (cont.)

Part	Year	VIN	Model/Application	Part Number	Qty.
MISCELLANEOUS GASKETS					
Dist. Mounting Gasket	1993-1996			72125	1
E.G.R. Gasket	1993-1994	R		G26702	1
Injector Nozzle O-Ring	1993-1996	R		GS33276	4
Oil Pan Drain Plug Gst.	1993			2066A	1
Throttle Body Gasket	1993-1996			G30941	1
Water Outlet Gasket	1993-1996			C24005	1
Water Pump Backing Plate	1993-1996			K30707	1
Water Pump Mount Gasket	1993-1996			K30708	1

56 352 CID (5.8L) Ford V8 Cyl, 4.000in./101.6mm (1965-1967) **56**

Part	Year	VIN	Model/Application	Part Number	Qty.
ENGINE GASKETS					
Head Set	1965-1967		(Exhaust Pipe Gasket Not Included)	HS3389VJ	1
Full Set	1965-1967		(Exhaust Pipe Gasket Not Included)	FS3389VJ	1
Engine Kit Gasket Set	1965-1967		(Exhaust Manifold Heat Shield Gasket Not Included), Use With Part Number MS15521X	95-3359VR	1
Cylinder Head Gasket	1965-1967		VR2000	3389	2
Valve Cover Set	1965-1967		Cork Rubber	VS38308	1
			Victo-Tech	VS38308R	1
Valve Stem Seal, Exh.	1965-1967			B45390	8
Valve Stem Seal, Int.	1965-1967			B45390	8
Manifold Set, Exhaust	1966-1967		Before Serial Number A84, 001, Heat Shield Type, (Heat Shield)	MS15521X	1
	1965-1967		Except Heat Shield Type	MS15509	1
Manifold Set, Intake	1965-1967			MS15166X	1
Oil Pan Set	1965-1967		Cork Rubber	OS30764	1
Rear Main Seal Set	1965-1967		Rope Packing	JV707	1
			Molded Rubber	JV707P	1
Timing Cover Set	1965-1967			JV819	1
			(Contains Repair Sleeve)	JV921	1
Timing Cover Gasket	1965-1967			T27798	1
Timing Cover Seal	1965-1967			46293	1
Harmonic Balancer Repair Sleeve	1965-1967		Ground Steel, .020" Oversize	66595RS	1
			Use With Part Number A502 Nickel Plated Formed Steel, .013" Oversize	A226-2	1

MISCELLANEOUS GASKETS

Air Cleaner Mount Gasket	1965-1967		2 Barrel Carburetor	G27098	1
Carb. Mount Gasket	1966-1967		2 Barrel Carburetor, Carburetor To Spacer, Spacer To Manifold	G26072	2
	1965		2 Barrel Carburetor, Governor To Carburetor, Governor To Manifold	G26072	2
Dist. Mounting Gasket	1965-1967			B25212	1
Exhaust Pipe Gasket	1965-1967		(Flange Type), Manifold To Muffler Inlet Pipe	F5516BK	1
			(Ring Type 'C'), Pipe To Manifold	F7186	2
			(Ring Type 'B'), Pipe To Manifold Sintered Metal	F7199	2
Fuel Pump Bowl Gasket	1965-1967			D36016	1
Fuel Pump Gasket	1965-1967			D27094	1
			Tuff-Cork	D27094TC	1
Oil Filter Adapt Gasket	1965-1967		Adapter To Block	B25451	1
Oil Pan Drain Plug Gst.	1965-1967			2066A	1
Oil Pump Inlet Tube	1965-1967			B26151	1

LIGHT TRUCK

56 352 CID (5.8L) Ford V8 Cyl, 4.000in./101.6mm (1965-1967) **56**
(cont.) (cont.)

Part	Year	VIN	Model/Application	Part Number	Qty.
MISCELLANEOUS GASKETS (cont.)					
Oil Pump Mounting Gasket	1965-1967			B25412	1
Water Outlet Gasket	1965-1967			C25487	1
Water Pump Backing Plate	1965-1967			K27079	1
Water Pump Mount Gasket	1965-1967			K26442	2

57 359 CID (5.9L) OHV Ford V8 Cyl, 4.050in./102.9mm (1973-1978) **57**

Part	Year	VIN	Model/Application	Part Number	Qty.
ENGINE GASKETS					
Head Set	1974-1975		(Exhaust Manifold Gasket Not Included)	HS3417Y	1
Full Set	1974-1975		(Exhaust Manifold Gasket Not Included)	FS3417Y	1
Engine Kit Gasket Set	1974-1975		(Exhaust Manifold Heat Shield Gasket Not Included), Use With Part Number MS15573	95-3431VR	1
Cylinder Head Gasket	1974-1975		VR2000	3417	2
Valve Cover Set	1973-1978		Cork Rubber	VS38308	1
			Victo-Tech	VS38308R	1
Valve Stem Seal, Exh.	1973-1978			B45229	8
Valve Stem Seal, Int.	1973-1978			B45390	8
Manifold Set, Exhaust	1974-1975		(Heat Shield)	MS15573	1
				MS15969	1
Manifold Set, Intake	1974-1975			MS15133	1
Oil Pan Set	1974-1975		Cork Rubber	OS30764	1
Rear Main Seal Set	1974-1975		Rope Packing	JV707	1
			Molded Rubber	JV707P	1
Timing Cover Set	1974-1975			JV847	1
Timing Cover Seal	1974-1975			46442	1

MISCELLANEOUS GASKETS

Carb. Mount Gasket	1974-1975		2 Barrel Carburetor, Spacer To Manifold	G26072	2
			2 Barrel Carburetor, Carburetor To Spacer	G26073	2
Dist. Mounting Gasket	1973-1978			B25212	1
Exhaust Pipe Gasket	1973-1978		(Ring Type 'C'), Pipe To Manifold	F7186	2
			(Ring Type 'B'), Pipe To Manifold Sintered Metal	F7199	2
Fuel Pump Gasket	1973-1978			D27094	1
			Tuff-Cork	D27094TC	1
Oil Filter Gasket	1973-1978		Adapter To Block	B25451	1
Oil Pan Drain Plug Gst.	1973-1978			2066A	1
Oil Pump Inlet Tube	1973-1978			B26151	1
Oil Pump Mounting Gasket	1973-1978			B25412	1
Water Outlet Gasket	1973-1978		LN600, Lower	C24109	1
			LN600, Upper	C25487	1
	1974-1975		LN700, Lower	C24109	1
			B600, B700, C600, C700, F600, F700, Lower	C25487	1
			LN700, Upper	C25487	1
			B600, B700, C600, C700, F600, F700, Upper	C26670	1
Water Pump Mount Gasket	1973-1978			K27827	1

58 360 CID (5.9L) Ford V8 Cyl, 4.050in./102.9mm (1968-1976) **58**

Part	Year	VIN	Model/Application	Part Number	Qty.
ENGINE GASKETS					
Head Set	1968-1976		(Exhaust Pipe Gasket Not Included)	HS3389VJ	1
Full Set	1968-1976		(Exhaust Pipe Gasket Not Included)	FS3389VJ	1

Ford Truck

58 360 CID (5.9L) Ford V8 Cyl, 4.050in./102.9mm (1968-1976) **58**
 (cont.) (cont.)

Part Year VIN Model/Application Part Number Qty.

ENGINE GASKETS (cont.)

Engine Kit Gasket Set	1968-1976		(Exhaust Manifold Heat Shield Gasket Not Included), Use With Part Number MS15521X	95-3359VR	1
Cylinder Head Gasket	1968-1976		<i>VR2000</i>	3389	2
Valve Cover Set	1968-1976		<i>Cork Rubber</i>	VS38308	1
			<i>Victo-Tech</i>	VS38308R	1
Valve Stem Seal, Exh.	1968-1976			B45390	8
Valve Stem Seal, Int.	1968-1976			B45390	8
Manifold Set, Exhaust	1975-1976		F150, F250, F350, Before Serial Number W00, 001, Heat Shield Type, (Heat Shield)	MS15521X	1
	1968-1976		Except Heat Shield Type	MS15509	1
	1974		F250, F350, M450, Heat Shield Type, Thermactor Emission, (Heat Shield)	MS15521X	1
			Heat Shield Type, Thermactor Emission	MS15521X	1
	1973		M450, Heat Shield Type, (Heat Shield)	MS15521X	1
	1968-1973		F100, F250, F350, Heat Shield Type, (Heat Shield)	MS15521X	1
		Heat Shield Type	MS15521X	1	
Manifold Set, Intake	1968-1976			MS15166X	1
Oil Pan Set	1968-1976		<i>Cork Rubber</i>	OS30764	1
Rear Main Seal Set	1968-1976		<i>Rope Packing</i>	JV707	1
			<i>Molded Rubber</i>	JV707P	1
Timing Cover Set	1968-1976			JV819	1
			(Contains Repair Sleeve)	JV921	1
Timing Cover Gasket	1968-1976			T27798	1
Timing Cover Seal	1968-1976			46293	1
Harmonic Balancer Repair Sleeve	1968-1976		<i>Ground Steel, .020" Oversize</i>	66595RS	1
			Use With Part Number A502 <i>Nickel Plated Formed Steel, .013" Oversize</i>	A226-2	1

MISCELLANEOUS GASKETS

Air Cleaner Mount Gasket	1968-1976		2 Barrel Carburetor	G27098	1
Carb. Mount Gasket	1976		M400, M450, P450, From Serial Number W00, 001, 2 Barrel Carburetor, Carburetor To Spacer	G26048	1
	1975-1976		F100, 2 Barrel Carburetor, Spacer To Manifold	G26224	1
			F150, F250, From Serial Number W00, 001, 2 Barrel Carburetor, Spacer To Manifold	G26227	1
	1975		F100, F150, F250, F350, P450, 2 Barrel Carburetor, Carburetor To Spacer	G26048	1
			F100, From Serial Number W00, 001, 2 Barrel Carburetor, Spacer To Manifold	G26227	1
	1974-1975		F250, F350, Before Serial Number W00, 001, Except Thermactor Emission, 2 Barrel Carburetor, Spacer To Manifold	G7386	1
	1973-1975		M400, M450, 2 Barrel Carburetor, Carburetor To Spacer	G26048	1
	1974		F100, M400, M450, Except Thermactor Emission, 2 Barrel Carburetor, Spacer To Manifold	G7386	1
			Thermactor Emission, 2 Barrel Carburetor, Spacer To Manifold	G26229	1
	1973		2 Barrel Carburetor, Spacer To Manifold	G26242	1
	1968-1972		2 Barrel Carburetor, Carburetor To Spacer	G26073	2
			2 Barrel Carburetor, Spacer To Manifold	G26230	1
	1969		2 Barrel Carburetor, Governor To Carburetor	G26073	2
		2 Barrel Carburetor, Governor To Manifold	G26073	2	
Dist. Mounting Gasket	1968-1976			B25212	1
E.G.R. Gasket	1973-1976			G26701	1
Exhaust Pipe Gasket	1968-1976		(Ring Type 'C'), Pipe To Manifold	F7186	2
			(Ring Type 'B'), Pipe To Manifold <i>Sintered Metal</i>	F7199	2
Fuel Pump Gasket	1968-1976			D27094	1
				<i>Tuff-Cork</i>	D27094TC

LIGHT TRUCK

58 360 CID (5.9L) Ford V8 Cyl, 4.050in./102.9mm (1968-1976) **58**
(cont.) (cont.)

Part	Year	VIN	Model/Application	Part Number	Qty.
MISCELLANEOUS GASKETS (cont.)					
Oil Filter Adapt Gasket	1968-1976		Adapter To Block	B25451	1
Oil Pan Drain Plug Gst.	1968-1976			2066A	1
Oil Pump Inlet Tube	1968-1976			B26151	1
Oil Pump Mounting Gasket	1968-1976			B25412	1
Water Outlet Gasket	1975-1976		F150	C26154	1
	1973-1976		M450	C25487	1
			F100	C26154	1
	1972-1976			C25487	1
Water Outlet Gasket	1968-1972		F100, F250, F350	C25487	1
	1968-1976			K27079	1
Water Pump Mounting Gasket	1968-1976			K26442	2

59 361 CID (5.9L) OHV Ford V8 Cyl, 4.050in./102.9mm (1964-1978) **59**

Part	Year	VIN	Model/Application	Part Number	Qty.
ENGINE GASKETS					
Head Set	1964-1978		(Exhaust Pipe Gasket Not Included)	HS3417Y	1
Full Set	1964-1978		(Exhaust Pipe Gasket Not Included)	FS3417Y	1
Engine Kit Gasket Set	1964-1978		(Exhaust Manifold Heat Shield Gasket Not Included), Use With Part Number MS15573	95-3431VR	1
Cylinder Head Gasket	1964-1978		VR2000	3417	2
Valve Cover Set	1964-1978		Cork Rubber	VS38308	1
			Victo-Tech	VS38308R	1
Valve Stem Seal, Exh.	1964-1978			B45229	8
Valve Stem Seal, Int.	1964-1978			B45390	8
Manifold Set, Exhaust	1964-1978		(Heat Shield)	MS15573	1
				MS15969	1
Manifold Set, Intake	1964-1978			MS15133	1
Oil Pan Set	1964-1978		Cork Rubber	OS30764	1
Rear Main Seal Set	1964-1978		Rope Packing	JV707	1
			Molded Rubber	JV707P	1
Timing Cover Set	1964-1978			JV847	1
Timing Cover Seal	1964-1978			46442	1

MISCELLANEOUS GASKETS					
Carb. Mount Gasket	1976		Except California Emission, Used With Cast Aluminum Spacer, 4 Barrel Carburetor, Carburetor To Spacer, Spacer To Manifold	G30687	1
	1965-1974		2 Barrel Carburetor, Spacer To Manifold	G26072	1
			2 Barrel Carburetor, Carburetor To Spacer	G26073	1
	1964		2 Barrel Carburetor, Carburetor To Manifold, Carburetor To Spacer	G26072	2
Dist. Mounting Gasket	1964-1978			B25212	1
E.G.R. Gasket	1975-1978			G26701	1
Exhaust Pipe Gasket	1964-1978		(Ring Type 'C'), Pipe To Manifold	F7186	2
			(Ring Type 'B'), Pipe To Manifold	Sintered Metal F7199	2
Fuel Pump Bowl Gasket	1964-1970			D36016	1
Fuel Pump Gasket	1964-1978			D27094	1
				Tuff-Cork D27094TC	1
Oil Filter Adapt Gasket	1964-1978		Adapter To Block	B25451	1
Oil Pan Drain Plug Gst.	1964-1978			2066A	1
Oil Pump Inlet Tube	1964-1978			B26151	1
Oil Pump Mounting Gasket	1964-1978			B25412	1

LIGHT TRUCK

Ford Truck

59 361 CID (5.9L) OHV Ford V8 Cyl, 4.050in./102.9mm (1964-1978) **59**
(cont.) (cont.)

Part	Year	VIN	Model/Application	Part Number	Qty.
MISCELLANEOUS GASKETS (cont.)					
Water Outlet Gasket	1970-1978		LN600, LN700, L Series, Lower	C24109	1
			LN600, LN700, Except L Series, L Series, Lower, Upper	C25487	1
			LN600, LN700, Except L Series, Upper	C26670	1
	1964-1978		B600, B700, C600, C700, F600, F700, L Series, Lower	C24109	1
			B600, B700, C600, C700, F600, F700, Except L Series, L Series, Lower, Upper	C25487	1
			B600, B700, C600, C700, F600, F700, Except L Series, Upper	C26670	1
	1964-1969		N600, L Series, Lower	C24109	1
			N600, Except L Series, L Series, Lower, Upper	C25487	1
			N600, Except L Series, Upper	C26670	1
Water Pump Mount Gasket	1964-1978		K27827	1	

60 370 CID (6.1L) OHV Ford V8 Cyl, 4.046in./102.8mm (1979-1994) **60**

Part	Year	VIN	Model/Application	Part Number	Qty.
ENGINE GASKETS					
Head Set	1987-1991		(Exhaust Pipe Gasket Not Included, Intake Manifold Gasket Not Included)	HS3979X	1
	1979-1986		(Exhaust Pipe Gasket Not Included, Intake Manifold Gasket Not Included)	HS3979	1
Full Set	1990-1991		(Exhaust Pipe Gasket Not Included, Intake Manifold Gasket Not Included)	FS3979A	1
	1989		From 3/28/89, (Exhaust Pipe Gasket Not Included, Intake Manifold Gasket Not Included)	FS3979A	1
			Thru 3/28/89, (Exhaust Pipe Gasket Not Included, Intake Manifold Gasket Not Included)	FS3979X	1
	1987-1988		(Exhaust Pipe Gasket Not Included, Intake Manifold Gasket Not Included)	FS3979X	1
	1979-1986		(Exhaust Pipe Gasket Not Included, Intake Manifold Gasket Not Included)	FS3979	1
Engine Kit Gasket Set	1992-1994		(Valve Stem Seals Not Included, Intake Manifold Gasket Not Included, Exhaust Manifold Heat Shield Gasket Not Included), 2 Barrel Carburetor, Use With Part Numbers MS15937, MS15205W, B45591A (8), B45418 (8)	95-3434VR	1
	1990-1991		(Valve Stem Seals Not Included, Intake Manifold Gasket Not Included, Exhaust Manifold Heat Shield Gasket Not Included), 2 Barrel Carburetor, Use With Part Numbers MS15937, MS15205W, B45632 (16)	95-3434VR	1
	1979-1989		(Intake Manifold Gasket Not Included, Exhaust Manifold Heat Shield Gasket Not Included), Use With Part Numbers MS15937, MS15205W	95-3434VR	1
Cylinder Head Gasket	1979-1991		Nitroseal	3979	2
Valve Cover Set	1979-1991		Cork Rubber	VS38421	1
			High Temperature Cork Rubber	VS38421H	1
			Victo-Tech	VS38421R	1
			Tuff-Cork	VS38421TC	1
Valve Stem Seal, Exh.	1992-1994			B45591A	8
	1987-1991			B45632	8
	1979-1986			B45436	8
Valve Stem Seal, Int.	1992-1994		Fluoroelastomer	B45418	8
	1987-1991			B45632	8
	1979-1986			B45436	8
Manifold Set, Exhaust	1979-1991			MS15175	1
			(Heat Shield)	MS15205W	1
Manifold Set, Intake	1979-1991		Except Liquid Propane Gas	MS15937	1
	1980-1989		Liquid Propane Gas	MS15817	1
Oil Pan Set	1990-1991		(One Piece) Victo-Tech	OS32494	1
	1979-1991		(Multi Piece) Cork Rubber	OS30540	1
			(Multi Piece) Tuff-Cork	OS30540TC	1

LIGHT TRUCK

60 370 CID (6.1L) OHV Ford V8 Cyl, 4.046in./102.8mm (1979-1994) **60**
(cont.) (cont.)

Part	Year	VIN	Model/Application	Part Number	Qty.
ENGINE GASKETS (cont.)					
Oil Pan Set (cont.)	1989		From 3/28/89, (One Piece) <i>Victo-Tech</i>	OS32494	1
Rear Main Seal Set	1979-1991		<i>Molded Rubber</i>	JV618	1
Timing Cover Set	1979-1991			JV905	1
Timing Cover Seal	1979-1991			47682	1

MISCELLANEOUS GASKETS					
Carb. Mount Gasket	1979-1989		4 Barrel Carburetor, Carburetor To Spacer	G26179	1
			4 Barrel Carburetor, Carburetor To Spacer	G26183	1
			4 Barrel Carburetor, Spacer To Manifold	G27350	1
			2 Barrel Carburetor, Spacer To Manifold	G27370	1
Dist. Mounting Gasket	1979-1989			72125	1
Exhaust Air Supply Tube	1979-1989		Upper	B45570	1
E.G.R. Gasket	1979-1991			G26702	1
Exhaust Pipe Gasket	1979-1989		(Ring Type 'C'), Pipe To Manifold	F7186	2
			(Ring Type 'B'), Pipe To Manifold <i>Sintered Metal</i>	F7199	2
Fuel Pump Gasket	1979-1991			D27094	1
			<i>Tuff-Cork</i>	D27094TC	1
Oil Filter Gasket	1979-1989		(O-Ring Type), Adapter To Block	B45825	1
Oil Pan Drain Plug Gst.	1979-1991			2066A	1
Water Outlet Gasket	1979-1991		Lower	C26650	1
			Upper	C26670	1
Water Pump Backing Plate	1979-1991			K27148	1
Water Pump Mount Gasket	1979-1991			K27147	1

61 389 CID (6.4L) OHV Ford V8 Cyl, 4.050in./102.9mm (1975-1978) **61**

Part	Year	VIN	Model/Application	Part Number	Qty.
ENGINE GASKETS					
Head Set	1975-1978		(Exhaust Pipe Gasket Not Included)	HS3417Y	1
Full Set	1975-1978		(Exhaust Pipe Gasket Not Included)	FS3417Y	1
Engine Kit Gasket Set	1975-1978		(Exhaust Manifold Heat Shield Gasket Not Included), Use With Part Number MS15573	95-3431VR	1
Cylinder Head Gasket	1975-1978		(Exhaust Pipe Gasket Not Included) <i>VR2000</i>	3417	2
Valve Cover Set	1975-1978		<i>Cork Rubber</i>	VS38308	1
			<i>Victo-Tech</i>	VS38308R	1
Valve Stem Seal, Exh.	1975-1978			B45229	8
Valve Stem Seal, Int.	1975-1978			B45390	8
Manifold Set, Exhaust	1975-1978		(Heat Shield)	MS15573	1
				MS15969	1
Manifold Set, Intake	1975-1978			MS15133	1
Oil Pan Set	1975-1978		<i>Cork Rubber</i>	OS30764	1
Rear Main Seal Set	1975-1978		<i>Rope Packing</i>	JV707	1
			<i>Molded Rubber</i>	JV707P	1
Timing Cover Set	1975-1978			JV847	1
Timing Cover Seal	1975-1978			46442	1

MISCELLANEOUS GASKETS						
Carb. Mount Gasket	1976-1978		(Spacer), 4 Barrel Carburetor, Carburetor To Spacer, Spacer To Manifold <i>Cast Aluminum</i>	G30687	1	
			1975	4 Barrel Carburetor, Carburetor To Spacer	G26787	1
			4 Barrel Carburetor, Spacer To Manifold	G27111	2	
Dist. Mounting Gasket	1975-1978			B25212	1	
E.G.R. Gasket	1975-1978			G26701	1	
Exhaust Pipe Gasket	1975-1978		(Ring Type 'C'), Pipe To Manifold	F7186	2	
			(Ring Type 'B'), Pipe To Manifold <i>Sintered Metal</i>	F7199	2	

LIGHT TRUCK

Ford Truck

61 (cont.)	389 CID (6.4L) OHV Ford V8 Cyl, 4.050in./102.9mm (1975-1978)				61 (cont.)
----------------------	---	--	--	--	----------------------

Part	Year	VIN	Model/Application	Part Number	Qty.
MISCELLANEOUS GASKETS (cont.)					
Fuel Pump Gasket	1975-1978			D27094	1
				<i>Tuff-Cork</i> D27094TC	1
Oil Pan Drain Plug Gst.	1975-1978			2066A	1
Oil Pump Inlet Tube	1975-1978			B26151	1
Oil Pump Mounting Gasket	1975-1978			B25412	1
Water Outlet Gasket	1975-1978		LN700, Lower	C24109	1
			C700, F700, Lower	C25487	1
			LN700, Upper	C25487	1
			C700, F700, Upper	C26670	1
Water Pump Mount Gasket	1975-1978			K27827	1

62	390 CID (6.4L) Ford V8 Cyl, 4.050in./102.9mm (1968-1976)				62
-----------	---	--	--	--	-----------

Part	Year	VIN	Model/Application	Part Number	Qty.
ENGINE GASKETS					
Head Set	1968-1976		(Exhaust Pipe Gasket Not Included)	HS3389VJ	1
Full Set	1968-1976		(Exhaust Pipe Gasket Not Included)	FS3389VJ	1
Engine Kit Gasket Set	1968-1976		(Exhaust Manifold Heat Shield Gasket Not Included), Use With Part Number MS15521X	95-3359VR	1
Cylinder Head Gasket	1968-1976		<i>VR2000</i>	3389	2
Valve Cover Set	1968-1976		<i>Cork Rubber</i>	VS38308	1
			<i>Victo-Tech</i>	VS38308R	1
Valve Stem Seal, Exh.	1968-1976			B45390	8
Valve Stem Seal, Int.	1968-1976			B45390	8
Manifold Set, Exhaust	1975-1976		F150, F350, Before Serial Number W00, 001, (Heat Shield)	MS15521X	1
	1968-1976		Except Heat Shield Type	MS15509	1
			F100, (Heat Shield)	MS15521X	1
	1973-1974		M450, (Heat Shield)	MS15521X	1
	1972-1974		M500, (Heat Shield)	MS15521X	1
	1968-1974		F250, F350, M400, (Heat Shield)	MS15521X	1
	1968-1969		Ranchero, (Heat Shield)	MS15521X	1
Manifold Set, Intake	1968-1976			MS15166X	1
Oil Pan Set	1968-1976		<i>Cork Rubber</i>	OS30764	1
Rear Main Seal Set	1968-1976		<i>Rope Packing</i>	JV707	1
			<i>Molded Rubber</i>	JV707P	1
Timing Cover Set	1968-1976			JV819	1
			(Contains Repair Sleeve)	JV921	1
Timing Cover Gasket	1968-1976			T27798	1
Timing Cover Seal	1968-1976			46293	1
Harmonic Balancer Repair Sleeve	1968-1976		<i>Ground Steel, .020" Thickness</i>	66595RS	1

MISCELLANEOUS GASKETS

Air Cleaner Mount Gasket	1968-1976		2 Barrel Carburetor	G27098	1
Carb. Mount Gasket	1975-1976		M450, From Serial Number W00, 001, 2 Barrel Carburetor, Carburetor To Spacer	G26048	1
			F150, From Serial Number W00, 001, 4 Barrel Carburetor, Carburetor To Spacer	G26180	1
			F150, Except California, From Serial Number W00, 001, 4 Barrel Carburetor, Spacer To Manifold	G26220	1
			F150, California, 4 Barrel Carburetor, Spacer To Manifold	G26222	1
			M400, M500, From Serial Number W00, 001, 4 Barrel Carburetor, Spacer To Manifold	G26222	1
			F100, 2 Barrel Carburetor, Spacer To Manifold	G26224	1
	1974-1976		M400, M500, 4 Barrel Carburetor, Carburetor To Spacer	G26180	1

LIGHT TRUCK

62 390 CID (6.4L) Ford V8 Cyl, 4.050in./102.9mm (1968-1976) **62**
(cont.) (cont.)

Part	Year	VIN	Model/Application	Part Number	Qty.	
MISCELLANEOUS GASKETS (cont.)						
Carb. Mount Gasket (cont.)	1975		F150, Before Serial Number W00, 001, 4 Barrel Carburetor, Carburetor To Spacer	G26132	1	
			F150, P550, Before Serial Number W00, 001, 4 Barrel Carburetor, Spacer To Manifold	G26199	1	
			F100, 2 Barrel Carburetor, Carburetor To Spacer	G26741	1	
	1974-1975		F250, F350, M450, Before Serial Number W00, 001, 2 Barrel Carburetor, Spacer To Manifold	G7386	1	
			M400, M500, Before Serial Number W00, 001, 4 Barrel Carburetor, Spacer To Manifold	G26199	1	
	1973-1975		F250, F350, Before Serial Number W00, 001, 2 Barrel Carburetor, Carburetor To Spacer	G26048	1	
	1974		F250, F350, 2 Barrel Carburetor, Carburetor To Spacer	G26132	1	
	1973-1974		F100, M450, Before Serial Number W00, 001, 2 Barrel Carburetor, Carburetor To Spacer	G26048	1	
			F100, 2 Barrel Carburetor, Spacer To Manifold	G26242	1	
	1973		F250, F350, M450, 2 Barrel Carburetor, Spacer To Manifold	G26242	1	
	1970-1972		F100, F250, F350, Except Governor, 2 Barrel Carburetor, Carburetor To Spacer	G26073	2	
	1968-1972		F100, F250, F350, Except Governor, 2 Barrel Carburetor, Carburetor To Spacer, Governor Base To Manifold, Governor To Carburetor	G26073	2	
			F100, F250, F350, 2 Barrel Carburetor, Spacer To Manifold	G26230	1	
1968		F100, Except Governor, 2 Barrel Carburetor, Carburetor To Spacer	G26073	2		
Dist. Mounting Gasket	1968-1976			B25212	1	
E.G.R. Gasket	1973-1976			G26701	1	
Exhaust Pipe Gasket	1968-1976		(Ring Type 'C'), Pipe To Manifold	F7186	2	
			(Ring Type 'B'), Pipe To Manifold <i>Sintered Metal</i>	F7199	2	
Fuel Pump Gasket	1968-1976			D27094	1	
				<i>Tuff-Cork</i> D27094TC	1	
Oil Filter Gasket	1968-1976		Adapter To Block	B25451	1	
Oil Pan Drain Plug Gst.	1968-1976			2066A	1	
Oil Pump Inlet Tube	1968-1976			B26151	1	
Oil Pump Mounting Gasket	1968-1976			B25412	1	
Water Outlet Gasket	1975-1976		F150	C26154	1	
	1973-1976		M450	C25487	1	
					C25487	1
			F100	C26154	1	
	1968-1972		F100, F250, F350	C25487	1	
1968-1969		Rancho	C25487	1		
Water Pump Backing Plate	1968-1976			K27079	1	
Water Pump Mount Gasket	1968-1976			K26442	2	

63 400 CID (6.6L) OHV Ford V8 Cyl, 4.000in./101.6mm (1972-1982) **63**

Part	Year	VIN	Model/Application	Part Number	Qty.
ENGINE GASKETS					
Head Set	1977-1982		(Intake Manifold Gasket Not Included)	HS3502	1
Full Set	1977-1982		(Intake Manifold Gasket Not Included)	FS3502	1
Engine Kit Gasket Set	1977-1982		(Intake Manifold Gasket Not Included), Use With Part Number MS15938	95-3030VR	1
Cylinder Head Gasket	1977-1982		<i>VR2000</i>	3502	2
			<i>Nitroseal</i>	3502SG	2
Valve Cover Set	1977-1982		<i>Cork Rubber</i>	VS38422	1
			<i>High Temperature Cork Rubber</i>	VS38422H	1
			<i>Victo-Tech</i>	VS38422R	1

LIGHT TRUCK

Ford Truck

63 400 CID (6.6L) OHV Ford V8 Cyl, 4.000in./101.6mm (1972-1982) **63**
 (cont.) (cont.)

Part	Year	VIN	Model/Application	Part Number	Qty.
ENGINE GASKETS (cont.)					
Valve Cover Set (cont.)	1977-1982		<i>Tuff-Cork</i>	VS38422TC	1
	1972-1982		(Contains Gasket With Pre-inserted Grommets)	VS38422GR	1
Valve Stem Seal, Exh.	1977-1982			B45399	8
Valve Stem Seal, Int.	1977-1982			B45399	8
Manifold Set, Exhaust	1977-1982			MS15197	1
Manifold Set, Intake	1977-1982			MS15938	1
Oil Pan Set	1977-1982		<i>Cork Rubber</i>	OS30543	1
			<i>Tuff-Cork</i>	OS30543TC	1
Rear Main Seal Set	1977-1982		<i>Molded Rubber</i>	JV614	1
			<i>Rope Packing</i>	JV730	1
				JV869	1
Timing Cover Set	1977-1982			JV933	1
			(Contains Repair Sleeve)	JV933	1
Timing Cover Gasket	1977-1982			T27150	1
Timing Cover Seal	1977-1982			46293	1
Harmonic Balancer Repair Sleeve	1977-1982		<i>Ground Steel, .020" Thickness</i>	66595RS	1
			Use With Part Number A502 <i>Nickel Plated Formed Steel, .013" Thickness</i>	A226-2	1

MISCELLANEOUS GASKETS

Air Cleaner Mount Gasket	1977-1982		2 Barrel Carburetor <i>5" Inside Diameter</i>	G27098	1
Carb. Mount Gasket	1977-1982		2 Barrel Carburetor, Carburetor To Spacer	G26741	1
			2 Barrel Carburetor, Spacer To Manifold	G26746	1
Choke Tube Gasket	1977-1979			B45788	1
Dist. Mounting Gasket	1977-1982			72125	1
E.G.R. Gasket	1977-1982			G26702	1
Fuel Pump Gasket	1977-1982			D24006	1
Oil Pan Drain Plug Gst.	1977-1982			2066A	1
Oil Pump Mounting Gasket	1977-1982			B25211	1
Water Outlet Gasket	1977-1982			C26650	1
Water Pump Backing Plate	1977-1982			K27151	1
Water Pump Mount Gasket	1977-1982			K27158	1

64 400 CID (6.6L) OHV Ford LPG V8 Cyl, 4.000in./101.6mm (1972-1979) **64**

Part	Year	VIN	Model/Application	Part Number	Qty.
ENGINE GASKETS					
Valve Cover Set	1972-1979		<i>Grommeted Cork-Rubber</i>	VS38422GR	1

65 415 CID (6.8L) SOHC Ford Windsor V10 Cyl, 3.550in./90.1mm (1997-2003) **65**

Part	Year	VIN	Model/Application	Part Number	Qty.
ENGINE GASKETS					
Head Set	1997-2003		(Valve Cover Gasket Not Included, Plenum Chamber Gasket Not Included, Intake Manifold Gasket Not Included)	HS54242	1
Lower Set	1997-2003		(Requires Head Set To Make Full Set)	CS54242	1
Cylinder Head Gasket	1997-2003		Right <i>Multi-Layered Steel</i>	54242	1
			Left <i>Multi-Layered Steel</i>	54243	1
Cyl. Head Bolt Set	1997-2003			GS33361	2
Valve Stem Seal, Exh.	1997-2003			B45892A	10
Valve Stem Seal, Int.	1997-2003			B45892A	10
Manifold Set, Exhaust	1997-2003		<i>Nitroseal</i>	MS16332	1
Manifold Set, Intake	2001-2003		(Plenum Chamber Gasket Not Included) <i>Victo-Tech</i>	MS16331	1
	2000		(Plenum Chamber Gasket Not Included) <i>Victo-Tech</i>	MS16330	1

65 415 CID (6.8L) SOHC Ford Windsor V10 Cyl, 3.550in./90.1mm (1997-2003) **65**
(cont.) (cont.)

Part	Year	VIN	Model/Application	Part Number	Qty.
ENGINE GASKETS (cont.)					
Manifold Set, Intake (cont.)	1999		Thru 7/19/98, (Plenum Chamber Gasket Not Included) <i>Victo-Tech</i>	MS16328	1
			From 7/20/98, (Plenum Chamber Gasket Not Included) <i>Victo-Tech</i>	MS16329	1
	1997-1998		(Plenum Chamber Gasket Not Included) <i>Victo-Tech</i>	MS16328	1
Plenum Chamber Gasket	2000-2003		<i>Victo-Tech</i>	MS16326	1
	1999		<i>Performaseal</i>	MS16325	1
	1998		From 10/15/97 <i>Performaseal</i>	MS16325	1
	1997-1998		Thru 10/14/97 <i>Victo-Tech</i>	MS16324	1
Oil Pan Set	1997-2003		<i>Victo-Tech</i>	OS32222	1
Rear Main Seal Set	1997-2003			JV1612	1
Timing Cover Set	1999-2003		<i>Victo-Tech</i>	JV5014	1
	1997-1998		<i>Victo-Tech</i>	JV5010	1
Timing Cover Seal	1999-2003			67616	1
	1997-1998			48322	1

MISCELLANEOUS GASKETS

Injector Nozzle O-Ring	1997-2002			GS33276	5
Oil Filter Adapt Gasket	1997-2003		<i>Victo-Tech</i>	B31584	1
Throttle Body Gasket	2000-2003		Throttle Body To Adapter	G31601	1
	1999-2003		F250 Super Duty, F350 Super Duty, Throttle Body To Adapter	G31601	1
	1997-2003		Adapter To Plenum	G31600	1
	1999-2001		F450 Super Duty, F550 Super Duty, Throttle Body To Adapter	G31601	1
	1999		Econoline E350 Super Duty, Econoline E350 Super Duty Ext., Econoline E450 Super Duty, Wagon E350 Super Duty, Wagon E350 Super Duty Ext., Throttle Body To Adapter	G31575	1
	1997-1999		Throttle Body To Adapter	G31575	1
Water Outlet Gasket	1997-2003		(O-Ring Type)	C31302	1
Water Pump Mount Gasket	1997-2003			K31309	1

66 420 CID (6.9L) Navistar Diesel V8 Cyl, 4.000in./101.6mm (1983-1987) **66**

Part	Year	VIN	Model/Application	Part Number	Qty.
ENGINE GASKETS					
Head Set	1983-1987		(Intake Manifold Gasket Not Included)	HS3789	1
Lower Set	1983-1987		(Requires Head Set To Make Full Set)	CS5869	1
Full Set	1983-1987		(Intake Manifold Gasket Not Included)	FS3789	1
Engine Kit Gasket Set	1983-1987		(Intake Manifold Gasket Not Included), Use With Part Number MS15968	95-3337VR	1
Cylinder Head Gasket	1983-1987		<i>Nitroseal</i>	3789G	2
Valve Cover Set	1983-1987		<i>Cork Rubber</i>	VS39471	1
			<i>Victo-Tech</i>	VS50214	1
Valve Stem Seal, Exh.	1983-1987			B45662	8
Valve Stem Seal, Int.	1983-1987			B45560	8
Manifold Set, Exhaust	1983-1987		(One Piece Per Head Design Gasket) <i>VR2000</i>	MS15369	1
			(Multi Piece Per Head Design Gasket) <i>Beaded Steel</i>	MS15369A	1
Manifold Set, Intake	1983-1987			MS15968	1
Oil Pan Set	1983-1987		<i>Cork Rubber</i>	OS32053	1
Rear Main Seal Set	1983-1987			JV547	1
Crank Repair Sleeve	1983-1987		Use With Part Number A506 <i>Nickel Plated Formed Steel, .013" Thickness</i>	A336	1
Timing Cover Set	1983-1987			JV1019	1
MISCELLANEOUS GASKETS					
Exhaust Pipe Gasket	1986		(Flange Type), Pipe To Converter	F14627	1
	1985		Thru 2/85, (Flange Type), Pipe To Converter	F14145	1

Ford Truck

66	420 CID (6.9L) Navistar Diesel V8 Cyl, 4.000in./101.6mm (1983-1987)	66
(cont.)		(cont.)

Part	Year	VIN	Model/Application	Part Number	Qty.
MISCELLANEOUS GASKETS (cont.)					
Exhaust Pipe Gasket (cont.)	1985		From 2/85, (Flange Type), Pipe To Converter	F14627	1
	1983-1985		(Flange Type), Pipe To Converter	F14145	1
Fuel Pump Gasket	1983-1987			D27094	1
				<i>Tuff-Cork</i> D27094TC	1
Therm. Housing Gasket	1983-1987		Right	C24551	1
Water Outlet Gasket	1983-1987		Lower	C24550	1
Water Pump Mount Gasket	1983-1987			K27163	1

67	428 CID (7.0L) Cobra Jet Ford V8 Cyl, 4.130in./104.9mm (1968-1969)	67
-----------	---	-----------

Part	Year	VIN	Model/Application	Part Number	Qty.
ENGINE GASKETS					
Head Set	1969		(Exhaust Pipe Gasket Not Included)	HS3389VJ	1
Full Set	1969		(Exhaust Pipe Gasket Not Included)	FS3389VJ	1
Cylinder Head Gasket	1969			<i>VR2000</i> 3389	2
Valve Cover Set	1969			<i>Cork Rubber</i> VS38308	1
	1968-1969			<i>Victo-Tech</i> VS38308R	1
Valve Stem Seal, Exh.	1968-1969			B45390	8
Valve Stem Seal, Int.	1968-1969			B45390	8
Manifold Set, Exhaust	1969			MS15509	1
			(Heat Shield)	MS15521X	1
Manifold Set, Intake	1969			MS15166X	1
Oil Pan Set	1969			<i>Cork Rubber</i> OS30764	1
Rear Main Seal Set	1969			<i>Rope Packing</i> JV707	1
				<i>Molded Rubber</i> JV707P	1
Timing Cover Set	1969		(Repair Sleeve Not Included)	JV819	1
			(Contains Repair Sleeve)	JV921	1
Timing Cover Gasket	1968-1969			T27798	1

Part	Year	VIN	Model/Application	Part Number	Qty.
MISCELLANEOUS GASKETS					
Air Cleaner Mount Gasket	1968-1969		4 Barrel Carburetor	G27098	1
Carb. Mount Gasket	1968-1969		4 Barrel Carburetor	G14733	1
Dist. Mounting Gasket	1968-1969		(Tapered Washer)	B25212	1
Exhaust Pipe Gasket	1968-1969		(Ring Type 'C'), Pipe To Manifold	F7197	2
Fuel Pump Gasket	1968-1969			D27094	1
				<i>Tuff-Cork</i> D27094TC	1
Oil Filter Adapt Gasket	1968-1969			B25451	1
Oil Pump Inlet Tube	1968-1969			B26151	1
Oil Pump Mounting Gasket	1968-1969			B25412	1
Water Outlet Gasket	1968-1969			C25487	1
Water Pump Backing Plate	1968-1969			K27079	1
Water Pump Mount Gasket	1968-1969			K26442	2

68	429 CID (7.0L) Cobra Jet Ford V8 Cyl, 4.360in./110.7mm (1970-1973)	68
-----------	---	-----------

Part	Year	VIN	Model/Application	Part Number	Qty.
ENGINE GASKETS					
Head Set	1970-1973		(Exhaust Pipe Gasket Not Included)	HS3851	1
Full Set	1970-1973		(Exhaust Pipe Gasket Not Included)	FS3851E	1
Cylinder Head Gasket	1970-1973			<i>VR2000</i> 3909	2
				<i>Nitroseal</i> 3978SG	2
Valve Cover Set	1970-1973			<i>Cork Rubber</i> VS38421	1

LIGHT TRUCK

68 429 CID (7.0L) Cobra Jet Ford V8 Cyl, 4.360in./110.7mm (1970-1973) **68**
(cont.) (cont.)

Part	Year	VIN	Model/Application	Part Number	Qty.
ENGINE GASKETS (cont.)					
Valve Cover Set (cont.)	1970-1973		High Temperature Cork Rubber	VS38421H	1
			Victo-Tech	VS38421R	1
			Tuff-Cork	VS38421TC	1
Valve Stem Seal, Exh.	1970-1973			B45399	8
Valve Stem Seal, Int.	1970-1973			B45399	8
Manifold Set, Exhaust	1970-1973			MS15175	1
Manifold Set, Intake	1970-1973			MS15171	1
Oil Pan Set	1970-1973		Cork Rubber	OS30540	1
			Tuff-Cork	OS30540TC	1
Rear Main Seal Set	1970-1973		Molded Rubber	JV618	1
			Rope Packing	JV730	1
Timing Cover Set	1970-1973			JV865	1
			(Contains Repair Sleeve)	JV932	1
Timing Cover Gasket	1970-1973			T27842	1
Timing Cover Seal	1970-1971			46293	1

MISCELLANEOUS GASKETS

Air Cleaner Mount Gasket	1970-1973		4 Barrel Carburetor	G27098	1
Carb. Mount Gasket	1970		4 Barrel Carburetor, Carburetor To Spacer	G27186	1
			4 Barrel Carburetor, Spacer To Manifold	G27190	1
Choke Tube Gasket	1970-1973			B45789	1
Dist. Mounting Gasket	1970-1973		(Tapered Washer)	B25212	1
	1970-1971		(O-Ring Type)	72125	1
E.G.R. Gasket	1973		Valve To Adapter	G24663	1
			Valve	G26701	1
Exhaust Pipe Gasket	1970-1973		(Ring Type 'B'), Pipe To Manifold	F17947	1
Fuel Pump Gasket	1970-1973			D27094	1
			Tuff-Cork	D27094TC	1
Oil Pan Drain Plug Gst.	1970-1973			2066A	1
Oil Pump Inlet Tube	1970-1973			B26151	1
Water Outlet Gasket	1970-1973			C26650	1
Water Pump Backing Plate	1970-1973			K27148	1
Water Pump Mount Gasket	1970-1973			K27147	1

69 429 CID (7.0L) OHV Ford V8 Cyl, 4.360in./110.7mm (1979-1997) **69**

Part	Year	VIN	Model/Application	Part Number	Qty.
ENGINE GASKETS					
Head Set	1993-1995			HS3978C	1
	1991-1992			HS3978B	1
	1987-1990		(Exhaust Pipe Gasket Not Included, Intake Manifold Gasket Not Included)	HS3978Y	1
	1979-1986		(Exhaust Pipe Gasket Not Included, Intake Manifold Gasket Not Included)	HS3978	1
Lower Set	1993-1994		(Requires Head Set To Make Full Set)	CS3978A	1
Full Set	1991-1992			FS3978B	1
	1990		(Intake Manifold Gasket Not Included)	FS3978A	1
	1989		From 3/28/89, (Exhaust Pipe Gasket Not Included, Intake Manifold Gasket Not Included)	FS3978A	1
			Thru 3/28/89, (Exhaust Pipe Gasket Not Included, Intake Manifold Gasket Not Included)	FS3978Y	1
	1987-1988		(Exhaust Pipe Gasket Not Included, Intake Manifold Gasket Not Included)	FS3978Y	1
1979-1986		(Exhaust Pipe Gasket Not Included, Intake Manifold Gasket Not Included)	FS3978	1	

Ford Truck

69 429 CID (7.0L) OHV Ford V8 Cyl, 4.360in./110.7mm (1979-1997) **69**
 (cont.) (cont.)

Part Year VIN Model/Application Part Number Qty.

ENGINE GASKETS (cont.)

Engine Kit Gasket Set	1991-1995		(Valve Stem Seals Not Included, Intake Manifold Gasket Not Included, Exhaust Manifold Heat Shield Gasket Not Included), Multi-Port Fuel Injection, Use With Part Numbers MS15445, MS15205W, B45591A (8), B45418 (8)	95-3433VR	1
	1990		(Valve Stem Seals Not Included, Intake Manifold Gasket Not Included, Exhaust Manifold Heat Shield Gasket Not Included), 4 Barrel Carburetor, Use With Part Numbers MS15937, MS15205W, B45632 (16)	95-3433VR	1
	1979-1989		(Intake Manifold Gasket Not Included, Exhaust Manifold Heat Shield Gasket Not Included), 4 Barrel Carburetor, Use With Part Numbers MS15937, MS15205W	95-3433VR	1
Cylinder Head Gasket	1979-1997		(Tinplate Flange) <i>Nitroseal</i>	3978	2
			(Stainless Steel Flanges) <i>Nitroseal</i>	3978SG	2
Valve Cover Set	1996-1997		<i>Victo-Tech</i>	VS50239	1
	1995		Except .240" Valve Cover Groove Depth <i>Victo-Tech</i>	VS39800	1
			.240" Valve Cover Groove Depth <i>Victo-Tech</i>	VS50239	1
	1991-1994		<i>Victo-Tech</i>	VS39800	1
	1979-1990		<i>Cork Rubber</i>	VS38421	1
			<i>High Temperature Cork Rubber</i>	VS38421H	1
		<i>Tuff-Cork</i>	VS38421TC	1	
Valve Stem Seal, Exh.	1991-1997			B45591A	8
	1987-1990			B45632	8
	1979-1986			B45436	8
Valve Stem Seal, Int.	1991-1997		<i>Fluoroelastomer</i>	B45418	8
	1987-1990			B45632	8
	1979-1986			B45436	8
Manifold Set, Exhaust	1979-1995		(Heat Shield)	MS15205W	1
	1979-1990			MS15175	1
Manifold Set, Intake	1993-1995		(Contains Plenum Chamber Gasket)	MS15445	1
	1991-1992		Fuel Injection, (Contains Plenum Chamber Gasket)	MS15445	1
			Except Fuel Injection	MS15937	1
	1979-1990			MS15937	1
Plenum Chamber Gasket	1991-1997			MS14630	1
Oil Pan Set	1990-1997		(One Piece) <i>Victo-Tech</i>	OS32494	1
	1979-1994		(Multi Piece) <i>Cork Rubber</i>	OS30540	1
			(Multi Piece) <i>Tuff-Cork</i>	OS30540TC	1
	1989		From 3/28/89, (One Piece) <i>Victo-Tech</i>	OS32494	1
Rear Main Seal Set	1979-1995		<i>Molded Rubber</i>	JV618	1
Timing Cover Set	1979-1995			JV905	1
Timing Cover Seal	1979-1997			47682	1
Harmonic Balancer Repair Sleeve	1979-1984		Use With Part Number A502 <i>Nickel Plated Formed Steel, .013" Thickness</i>	A226-2	1

MISCELLANEOUS GASKETS

Carb. Mount Gasket	1979-1990		4 Barrel Carburetor, Carburetor To Spacer	G26183	1
			4 Barrel Carburetor, Spacer To Manifold	G27350	1
Dist. Mounting Gasket	1979-1997			72125	1
Exhaust Air Supply Tube	1979-1987		Upper	B45570	1
E.G.R. Gasket	1993-1997			G26703	1
	1979-1992			G26702	1
Exhaust Pipe Gasket	1979-1989		(Ring Type 'C'), Pipe To Manifold	F7186	2
			(Ring Type 'B'), Pipe To Manifold <i>Sintered Metal</i>	F7199	2
Fuel Pump Gasket	1979-1990			D27094	1
			<i>Tuff-Cork</i>	D27094TC	1
Oil Filter Gasket	1979-1989		Adapter To Block	B45825	1
Oil Pan Drain Plug Gst.	1979-1990			2066A	1
Throttle Body Gasket	1993-1997			G31286	1

69 429 CID (7.0L) OHV Ford V8 Cyl, 4.360in./110.7mm (1979-1997) **69**
(cont.) (cont.)

Part	Year	VIN	Model/Application	Part Number	Qty.
MISCELLANEOUS GASKETS (cont.)					
Water Outlet Gasket	1979-1997		Lower	C26650	1
			Upper	C26670	1
Water Pump Backing Plate	1979-1997			K27148	1
Water Pump Mount Gasket	1979-1995			K27147	1

70 429 CID (7.0L) OHV Ford LPG V8 Cyl, 4.360in./110.7mm (1990-1997) **70**

Part	Year	VIN	Model/Application	Part Number	Qty.
------	------	-----	-------------------	-------------	------

ENGINE GASKETS					
Head Set	1993-1995			HS3978C	1
	1991-1992			HS3978B	1
	1990-1992		(Intake Manifold Gasket Not Included)	HS3978Y	1
Lower Set	1993-1994		(Requires Head Set To Make Full Set)	CS3978A	1
Full Set	1991-1992			FS3978B	1
	1990-1992		(Intake Manifold Gasket Not Included)	FS3978A	1
Engine Kit Gasket Set	1991-1995		(Valve Stem Seals Not Included, Intake Manifold Gasket Not Included, Exhaust Manifold Heat Shield Gasket Not Included), Multi-Port Fuel Injection, Use With Part Numbers MS15445, MS15205W, B45591A (8), B45418 (8)	95-3433VR	1
Cylinder Head Gasket	1990-1997		(Tinplate Flange) Nitroseal	3978	2
			(Stainless Steel Flanges) Nitroseal	3978SG	2
Valve Cover Set	1996-1997			Victo-Tech VS50239	1
	1995		Except .240" Valve Cover Groove Depth	Victo-Tech VS39800	1
			.240" Valve Cover Groove Depth	Victo-Tech VS50239	1
	1991-1994			Victo-Tech VS39800	1
	1991-1992			Victo-Tech VS38421R	1
	1990-1992			Cork Rubber VS38421	1
				High Temperature Cork Rubber VS38421H	1
			Tuff-Cork VS38421TC	1	
Valve Stem Seal, Exh.	1991-1997			B45591A	8
	1990-1991			B45632	8
Valve Stem Seal, Int.	1991-1997		Fluoroelastomer	B45418	8
	1990-1991			B45632	8
Manifold Set, Exhaust	1990-1995			MS15175	1
			(Heat Shield)	MS15205W	1
Manifold Set, Intake	1991-1995		Fuel Injection, (Contains Plenum Chamber Gasket)	MS15445	1
Plenum Chamber Gasket	1991-1997			MS14630	1
Oil Pan Set	1990-1997		(One Piece) Victo-Tech	OS32494	1
	1990-1994		(Multi Piece) Cork Rubber	OS30540	1
			(Multi Piece) Tuff-Cork	OS30540TC	1
Rear Main Seal Set	1990-1995		Molded Rubber	JV618	1
Timing Cover Set	1990-1995			JV905	1
Timing Cover Seal	1990-1997			47682	1

MISCELLANEOUS GASKETS					
Carb. Mount Gasket	1990-1993		4 Barrel Carburetor, Carburetor To Spacer	G26183	1
			4 Barrel Carburetor, Spacer To Manifold	G27350	1
Dist. Mounting Gasket	1990-1997			72125	1
E.G.R. Gasket	1993-1997			G26703	1
	1990-1992			G26702	1
Fuel Pump Gasket	1990			D27094	1
				Tuff-Cork D27094TC	1
Oil Pan Drain Plug Gst.	1990			2066A	1
Throttle Body Gasket	1993-1997			G31286	1
Water Outlet Gasket	1990-1997		Lower	C26650	1

LIGHT TRUCK

Ford Truck

70 <small>(cont.)</small>	429 CID (7.0L) OHV Ford LPG V8 Cyl, 4.360in./110.7mm (1990-1997)	70 <small>(cont.)</small>
-------------------------------------	---	-------------------------------------

Part	Year	VIN	Model/Application	Part Number	Qty.
MISCELLANEOUS GASKETS (cont.)					
Water Outlet Gasket (cont.)	1990-1997		Upper	C26670	1
Water Pump Backing Plate	1990-1997			K27148	1
Water Pump Mount Gasket	1990-1995			K27147	1

71	429 CID (7.0L) Thunder Jet Ford V8 Cyl, 4.360in./110.7mm (1970-1973)	71
-----------	---	-----------

Part	Year	VIN	Model/Application	Part Number	Qty.
ENGINE GASKETS					
Head Set	1970-1973		(Exhaust Pipe Gasket Not Included)	HS3851	1
Full Set	1970-1973		(Exhaust Pipe Gasket Not Included)	FS3851E	1
Cylinder Head Gasket	1970-1973		VR2000	3909	2
			Nitroseal	3978SG	2
Valve Cover Set	1970-1973		Cork Rubber	VS38421	1
			High Temperature Cork Rubber	VS38421H	1
			Victo-Tech	VS38421R	1
			Tuff-Cork	VS38421TC	1
Manifold Set, Exhaust	1970-1973			MS15175	1
Manifold Set, Intake	1970-1973			MS15171	1
Oil Pan Set	1970-1973		Cork Rubber	OS30540	1
			Tuff-Cork	OS30540TC	1
Rear Main Seal Set	1970-1973		Molded Rubber	JV618	1
			Rope Packing	JV730	1
Timing Cover Set	1970-1973			JV865	1
			(Contains Repair Sleeve)	JV932	1
Timing Cover Gasket	1970-1973			T27842	1

MISCELLANEOUS GASKETS					
Air Cleaner Mount Gasket	1970-1973		4 Barrel Carburetor	G27098	1
Carb. Mount Gasket	1970-1973		4 Barrel Carburetor, Carburetor To Spacer	G27186	1
	1970-1972		4 Barrel Carburetor, Spacer To Manifold	G27190	1
Choke Tube Gasket	1970-1973			B45789	1
Dist. Mounting Gasket	1970-1973		(Tapered Washer)	B25212	1
E.G.R. Gasket	1973		Between Valve And Adapter	G24663	1
			Valve	G26701	1
Exhaust Pipe Gasket	1970-1973		(Ring Type 'B'), Pipe To Manifold	F17947	1
Fuel Pump Gasket	1970-1973			D27094	1
			Tuff-Cork	D27094TC	1
Oil Pump Inlet Tube	1970-1973			B26151	1
Water Outlet Gasket	1970-1973			C26650	1
Water Pump Backing Plate	1970-1973			K27148	1
Water Pump Mount Gasket	1970-1973			K27147	1

72	444 CID (7.3L) Indirect Injection Navistar Diesel V8 Cyl, 4.110in./104.4mm (1988-1994)	72
-----------	---	-----------

Part	Year	VIN	Model/Application	Part Number	Qty.
ENGINE GASKETS					
Head Set	1988-1993		(Intake Manifold Gasket Not Included)	HS5869	1
Lower Set	1988-1993		(Requires Head Set To Make Full Set)	CS5869	1
Full Set	1988-1993		(Intake Manifold Gasket Not Included)	FS5869	1
Engine Kit Gasket Set	1988-1994		(Intake Manifold Gasket Not Included), Use With Part Number MS15968	95-3299VR	1
Cylinder Head Gasket	1988-1994		Nitroseal	5869G	2
Cyl. Head Bolt Set	1988-1994			GS33348	2

LIGHT TRUCK

72 444 CID (7.3L) Indirect Injection Navistar Diesel V8 Cyl, 4.110in./104.4mm (1988-1994) **72**
(cont.) (cont.)

Part	Year	VIN	Model/Application	Part Number	Qty.
ENGINE GASKETS (cont.)					
Valve Cover Set	1988-1994			<i>Cork Rubber</i> VS39471	1
				<i>Victo-Tech</i> VS50214	1
Valve Stem Seal, Exh.	1988-1994			B45662	8
Valve Stem Seal, Int.	1988-1994			B45560	8
Manifold Set, Exhaust	1988-1994		(One Piece Per Head Design Gasket) <i>VR2000</i>	MS15369	1
			(Multi Piece Per Head Design Gasket) <i>Beaded Steel</i>	MS15369A	1
Manifold Set, Intake	1988-1994			MS15968	1
Oil Pan Set	1994		(Conventional Oil Pan Gasket Not Used) <i>Silicone</i>	JV6	1
	1988-1993			<i>Cork Rubber</i> OS32053	1
Rear Main Seal Set	1988-1994			JV547	1
Crank Repair Sleeve	1988-1993		Rear	A336	1
Timing Cover Set	1988-1994			JV1019	1

MISCELLANEOUS GASKETS

Exhaust Pipe Gasket	1988-1994		(Flange Type), Pipe To Converter	F14627	1
Fuel Pump Gasket	1988-1994			D27094	1
				<i>Tuff-Cork</i> D27094TC	1
Oil Pan Drain Plug Gst.	1988-1994			2066A	1
Therm. Housing Gasket	1988-1994		Right	C24551	1
Water Outlet Gasket	1988-1994		Lower	C24550	1
Water Pump Mount Gasket	1988-1994			K27163	1

73 444 CID (7.3L) Indirect Injection Turbocharged Navistar Diesel V8 Cyl, 4.110in./104.4mm (1994) **73**

Part	Year	VIN	Model/Application	Part Number	Qty.
------	------	-----	-------------------	-------------	------

ENGINE GASKETS

Engine Kit Gasket Set	1994		(Intake Manifold Gasket Not Included), Use With Part Number MS15968	95-3299VR	1
Cyl. Head Bolt Set	1994			GS33348	2
Manifold Set, Exhaust	1994		(Multi Piece Per Head Design Gasket) <i>Beaded Steel</i>	MS15369A	1

MISCELLANEOUS GASKETS

Therm. Housing Gasket	1994		Right	C24551	1
Water Outlet Gasket	1994		Lower	C24550	1

74 444 CID (7.3L) T444E (Power Stroke) Navistar Diesel V8 Cyl, 4.110in./104.4mm (1994-2002) **74**

Part	Year	VIN	Model/Application	Part Number	Qty.
------	------	-----	-------------------	-------------	------

ENGINE GASKETS

Head Set	1994-2001		(Valve Cover Gasket Not Included)	HS54204A	1
Lower Set	1997-2001			CS54204-4	1
	1996			CS54204-3	1
	1994-1995			CS54204-2	1
Cylinder Head Gasket	1994-2001			<i>Nitroseal</i> 54204	2
Cyl. Head Bolt Set	1994-2001			GS33379	2
Valve Cover Set	1998-2001		(Single Valve Cover) <i>Victo-Tech</i>	VS50329	2
	1994-1997		(Single Valve Cover) <i>Victo-Tech</i>	VS50328	2
Valve Stem Seal, Exh.	1994-2001			B45897	8
Valve Stem Seal, Int.	1994-2001			B45897	8
Manifold Set, Exhaust	1994-2001			<i>Nitroseal</i> MS16314	1
Rear Main Seal	1994-2002			67628	1
Timing Cover Seal	1994-2001			67631	1

Ford Truck

75 460 CID (7.5L) Ford V8 Cyl, 4.360in./110.7mm (1973-1998)

75

Part	Year	VIN	Model/Application	Part Number	Qty.	
ENGINE GASKETS						
Head Set	1995-1998		Over 8500 Pound Gross Vehicle Weight, (Valve Cover Gasket Not Included)	HS3978A	1	
	1993-1994			HS3978A	1	
	1992		From 2/15/92		HS3978A	1
			Thru 2/15/92		HS3978K	1
	1990-1991			HS3978K	1	
	1988-1989			HS3978X	1	
	1986-1987		(Intake Manifold Gasket Not Included)	HS3978W	1	
	1985			Except High Output Engine, Thru 6/28/85, (Exhaust Pipe Gasket Not Included, Valley Pan Type Intake Manifold Gasket Not Included)	HS3851	1
				High Output Engine, Thru 6/28/85, (Exhaust Pipe Gasket Not Included, Valley Pan Type Intake Manifold Gasket Not Included)	HS3978P	1
				From 6/28/85, (Intake Manifold Gasket Not Included)	HS3978W	1
	1973-1984			Except High Output Engine, (Exhaust Pipe Gasket Not Included, Valley Pan Type Intake Manifold Gasket Not Included)	HS3851	1
			High Output Engine, (Exhaust Pipe Gasket Not Included, Valley Pan Type Intake Manifold Gasket Not Included)	HS3978P	1	
Lower Set	1993-1998		(Requires Head Set To Make Full Set)	CS3978B	1	
	1992		From 2/15/92, (Requires Head Set To Make Full Set)	CS3978B	1	
Full Set	1992		Thru 2/15/92	FS3978K	1	
	1990-1991			FS3978K	1	
	1989		From 3/28/89		FS3978C	1
			Thru 3/28/89		FS3978X	1
	1988			FS3978X	1	
	1986-1987		(Intake Manifold Gasket Not Included)	FS3978W	1	
	1985			Except High Output Engine, Thru 6/28/85, (Exhaust Pipe Gasket Not Included, Valley Pan Type Intake Manifold Gasket Not Included)	FS3851E	1
				High Output Engine, Thru 6/28/85, (Exhaust Pipe Gasket Not Included, Valley Pan Type Intake Manifold Gasket Not Included)	FS3978P	1
				From 6/28/85, (Intake Manifold Gasket Not Included)	FS3978W	1
	1973-1984			Except High Output Engine, (Exhaust Pipe Gasket Not Included, Valley Pan Type Intake Manifold Gasket Not Included)	FS3851E	1
				High Output Engine, (Exhaust Pipe Gasket Not Included, Valley Pan Type Intake Manifold Gasket Not Included)	FS3978P	1
Engine Kit Gasket Set	1995-1998		E Series/F Series, Electronic Fuel Injection, Over 8500 Pound Gross Vehicle Weight, (Valve Stem Seals Not Included, Valve Cover Gasket Not Included), Use With Part Numbers B45591 (8), B45418 (8), VS50239	95-3452VR	1	
			E Series/F Series, Electronic Fuel Injection, Under 8500 Pound Gross Vehicle Weight, (Valve Stem Seals Not Included), Use With Part Numbers B45591 (8), B45418 (8)	95-3452VR	1	
	1995		4 Barrel Carburetor, F53 Motor Home, Over 8500 Pound Gross Vehicle Weight, (Valve Stem Seals Not Included, Valve Cover Gasket Not Included, Intake Manifold Gasket Not Included), Use With Part Numbers MS15937, B45591 (8), B45418 (8), VS50239	95-3452VR	1	
			4 Barrel Carburetor, F53 Motor Home, Under 8500 Pound Gross Vehicle Weight, (Valve Stem Seals Not Included, Intake Manifold Gasket Not Included), Use With Part Numbers MS15937, B45591 (8), B45418 (8)	95-3452VR	1	
	1993-1994		4 Barrel Carburetor, F53 Motor Home, (Valve Stem Seals Not Included, Intake Manifold Gasket Not Included), Use With Part Numbers MS15937, B45591 (8), B45418 (8)	95-3452VR	1	
			E Series/F Series, Electronic Fuel Injection, (Valve Stem Seals Not Included), Use With Part Numbers B45591 (8), B45418 (8)	95-3452VR	1	

LIGHT TRUCK

75 (cont.)	460 CID (7.5L) Ford V8 Cyl, 4.360in./110.7mm (1973-1998)				75 (cont.)
---------------	--	--	--	--	---------------

Part	Year	VIN	Model/Application	Part Number	Qty.
ENGINE GASKETS (cont.)					
Engine Kit Gasket Set (cont.)	1992		4 Barrel Carburetor, F53 Motor Home, From 2/16/92, (Valve Stem Seals Not Included, Intake Manifold Gasket Not Included), Use With Part Numbers MS15937, B45591 (8), B45418 (8)	95-3452VR	1
			4 Barrel Carburetor, F53 Motor Home, Thru 2/15/92, (Intake Manifold Gasket Not Included), Use With Part Number MS15937	95-3452VR	1
			E Series/F Series, Electronic Fuel Injection, From 2/16/92, (Valve Stem Seals Not Included), Use With Part Numbers B45591 (8), B45418 (8)	95-3452VR	1
			E Series/F Series, Electronic Fuel Injection, Thru 2/15/92	95-3452VR	1
	1990-1991		4 Barrel Carburetor, F53 Motor Home, (Intake Manifold Gasket Not Included), Use With Part Number MS15937	95-3452VR	1
			E Series/F Series, Electronic Fuel Injection	95-3452VR	1
	1989		Thru 3/28/89, (Oil Pan Gasket Not Included, Oil Filter Adapter To Block Gasket Not Included), Use With Part Numbers OS30540, B45825	95-3452VR	1
	1988		(Oil Pan Gasket Not Included, Oil Filter Adapter To Block Gasket Not Included), Use With Part Numbers OS30540, B45825	95-3452VR	1
	1986-1987		(Intake Manifold Gasket Not Included, Exhaust Manifold Heat Shield Gasket Not Included), Use With Part Numbers MS15937, MS15205	95-3453VR	1
	1985		Thru 3/11/85, (Intake Manifold Gasket Not Included, Exhaust Manifold Heat Shield Gasket Not Included), Use With Part Numbers MS15937, MS15205	95-3432VR	1
			From 3/12/85, (Intake Manifold Gasket Not Included, Exhaust Manifold Heat Shield Gasket Not Included), Use With Part Numbers MS15937, MS15205	95-3453VR	1
	1975-1984		(Intake Manifold Gasket Not Included, Exhaust Manifold Heat Shield Gasket Not Included), Use With Part Numbers MS15937, MS15205	95-3432VR	1
	1973-1974		(Exhaust Manifold Heat Shield Gasket Not Included), Use With Part Number MS15205	95-3432VR	1
Cylinder Head Gasket	1986-1998		(Tinplate Flange) Nitroseal	3978	2
			(Stainless Steel Flanges) Nitroseal	3978SG	2
	1985		Except High Output Engine, Thru 6/28/85 VR2000	3909	2
			From 6/28/85, (Tinplate Flange) Nitroseal	3978	2
			High Output Engine, Thru 6/28/85, (Tinplate Flange) Nitroseal	3978	2
			From 6/28/85, (Stainless Steel Flanges) Nitroseal	3978SG	2
	1973-1985		Except High Output Engine VR2000	3909	2
	1973-1984		High Output Engine Nitroseal	3978	2
Valve Cover Set	1995-1998		Except .240" Valve Cover Groove Depth, Under 8500 Pound Gross Vehicle Weight Victo-Tech	VS39800	1
			.240" Valve Cover Groove Depth, Over 8500 Pound Gross Vehicle Weight Victo-Tech	VS50239	1
	1988-1994		Victo-Tech	VS39800	1
	1973-1987		Cork Rubber	VS38421	1
			High Temperature Cork Rubber	VS38421H	1
			Victo-Tech	VS38421R	1
			Tuff-Cork	VS38421TC	1
Valve Stem Seal, Exh.	1993-1998			B45591A	8
	1992		Thru 2/15/92	B45581	8
			From 2/15/92	B45591A	8
	1987-1991			B45581	8
	1986		Thru 2/86	B45399	8
			From 2/86	B45581	8
	1973-1986			B45399	8
Valve Stem Seal, Int.	1993-1998		Fluoroelastomer	B45418	8
	1992		From 2/15/92 Fluoroelastomer	B45418	8
			Thru 2/15/92	B45580	8

LIGHT TRUCK

Ford Truck

75 460 CID (7.5L) Ford V8 Cyl, 4.360in./110.7mm (1973-1998) **75**
 (cont.) (cont.)

Part Year VIN Model/Application Part Number Qty.

ENGINE GASKETS (cont.)

Valve Stem Seal, Int. (cont.)	1987-1991			B45580	8
	1986		Thru 2/86	B45399	8
			From 2/86	B45580	8
	1980-1986			B45399	8
	1983		Borg Warner T18 4 Speed Transmission, Borg Warner T19 4 Speed Transmission	B45399	8
1973-1983			B45399	8	
Manifold Set, Exhaust	1993-1998			MS15499	1
	1990-1992			MS15663	1
	1988-1989			MS15499	1
	1973-1987			MS15175	1
		(Heat Shield)	MS15205	1	
Manifold Set, Intake	1988-1998		(Contains Plenum Chamber Gasket)	MS15445	1
	1973-1987		From Serial Number T20, 001, Valley Pan Design	MS15937	1
	1975-1986		Liquid Propane Gas, Valley Pan Design	MS15817	1
	1974		Before Serial Number T20, 001	MS15171	1
Plenum Chamber Gasket	1988-1998			MS14630	1
Oil Pan Set	1990-1998		(One Piece) <i>Victo-Tech</i>	OS32494	1
	1973-1994		(Multi Piece) <i>Cork Rubber</i>	OS30540	1
			(Multi Piece) <i>Tuff-Cork</i>	OS30540TC	1
	1989		From 3/28/89, (One Piece) <i>Victo-Tech</i>	OS32494	1
Rear Main Seal Set	1973-1998		<i>Molded Rubber</i>	JV618	1
	1985		Thru 6/28/85 <i>Rope Packing</i>	JV730	1
	1973-1985		<i>Rope Packing</i>	JV730	1
Timing Cover Set	1973-1998			JV865	1
	1973-1995		(Contains Repair Sleeve)	JV932	1
Timing Cover Gasket	1973-1997			T27842	1
Timing Cover Seal	1986-1998		Front Entry	46293	1
	1985		From 3/85, Front Entry	46293	1
			Thru 3/85, (Rear Entry)	48023	1
	1980-1984		(Rear Entry)	48023	1
	1973-1979			46293	1
Harmonic Balancer Repair Sleeve	1973-1995		<i>Ground Steel, .020" Thickness</i>	66595RS	1
			Use With Part Number A502 <i>Nickel Plated Formed Steel, .013" Thickness</i>	A226-2	1

MISCELLANEOUS GASKETS

Air Cleaner Mount Gasket	1973-1987		<i>5" Inside Diameter</i>	G27098	1
Carb. Mount Gasket	1979-1987		Carburetor To Spacer	G26183	1
			Spacer To Manifold	G27350	1
	1976-1978		Phenolic Carburetor Spacer, Carburetor To Spacer	G26160	1
			Metal Carburetor Spacer, Carburetor To Spacer	G26750	1
			Metal Carburetor Spacer, Spacer To Manifold	G26755	1
	1975		Carburetor To Spacer	G26750	1
	1973-1975		Spacer To Manifold	G26763	1
1973-1974		Carburetor To Spacer	G27186	1	
Choke Tube Gasket	1986-1990			B45789	1
Dist. Mounting Gasket	1973-1998			72125	1
Exhaust Air Supply Tube	1979-1987			B45570	1
E.G.R. Gasket	1990-1998		<i>Nitroseal</i>	G26703	1
	1978-1989		Valve	G26702	1
	1977-1979		Valve, Valve Adapter	G26702	1
	1977		Valve Adapter	G26702	1
	1974-1977		Valve	G26701	1

LIGHT TRUCK

75 (cont.)	460 CID (7.5L) Ford V8 Cyl, 4.360in./110.7mm (1973-1998)				75 (cont.)
----------------------	---	--	--	--	----------------------

<i>Part</i>	<i>Year</i>	<i>VIN</i>	<i>Model/Application</i>	<i>Part Number</i>	<i>Qty.</i>
MISCELLANEOUS GASKETS (cont.)					
E.G.R. Gasket (cont.)	1974-1976		Valve Adapter	G24663	1
	1973-1976		Valve, Valve Adapter	G24663	1
Exhaust Pipe Gasket	1987-1993		(Flange Type), Pipe To Converter	F14762	1
	1985-1986		(Flange Type), Pipe To Converter	F14627	1
	1973-1978		(Ring Type 'B'), Pipe To Manifold	F17947	1
Fuel Pump Gasket	1973-1987			D27094	1
				Tuff-Cork D27094TC	1
Injector Nozzle O-Ring	1985-1997			GS33276	4
Oil Filter Gasket	1978-1990		Adapter To Block	B45825	1
Oil Pan Drain Plug Gst.	1973-1998			2066A	1
Throttle Body Gasket	1988-1998			G30941	1
Water Outlet Gasket	1991-1997		Econoline E250	C26650	1
	1983-1997		F250, F350	C26650	1
	1984-1996		Club Wagon E350	C26650	1
	1979-1996		Econoline E350	C26650	1
	1989-1995		F53	C26650	1
	1979-1991		Club Wagon E250	C26650	1
	1983		Super Wagon E250	C26650	1
	1979-1983		Super Wagon E350	C26650	1
	1979-1980		Super Wagon E250	C26650	1
	1979		Econoline E250, F250	C26650	1
	1975-1979		F150	C26650	1
	1973-1979		F350	C26650	1
	1978		Super Wagon E250, Super Wagon E350	C26670	1
	1975-1978		Club Wagon E250, Econoline E250, Econoline E350	C26670	1
	1973-1978		F250	C26670	1
	1973-1977		F100	C26670	1
1974-1976		Ranchero	C26670	1	
1973-1976		M450	C26670	1	
Water Pump Backing Plate	1973-1997			K27148	1
Water Pump Mount Gasket	1973-1997			K27147	1

LIGHT TRUCK

General Motors Truck

Engine Index

<i>Engine</i>	<i>Year</i>	<i>Block</i>	<i>Engine</i>	<i>Year</i>	<i>Block</i>
97 CID (1.6L) LO1 16 Valve Suzuki	1994-1997	1	230 CID (3.8L) Chevrolet	1963-1969	24
97 CID (1.6L) LS5 8 Valve Suzuki	1989-1995	2	231 CID (3.8L) Carbureted Buick	1978-1984	25
1817CC (1.8L) SOHC Isuzu	1972-1982	3	231 CID (3.8L) Fuel Injected Buick	1992-1995	26
119 CID (1.9L) LR1 SOHC Isuzu	1982-1985	4	235 CID (3.9L) Chevrolet	1953-1962	27
121 CID (2.0L) LQ2 Chevrolet	1983-1984	5	236 CID (3.9L) OHV General Motors	1942-1946	28
134 CID (2.2L) OHV Chevrolet	1994-2003	6	248 CID (4.1L) General Motors	1939-1955	29
137 CID (2.2L) LQ7 OHV Isuzu Diesel	1984-1985	7	250 CID (4.1L) Chevrolet	1966-1984	30
2238CC (2.2L) OHV Isuzu Diesel	1981-1982	8	261 CID (4.3L) Chevrolet	1962	31
138 CID (2.3L) DOHC Oldsmobile	1993-1996	9	262 CID (4.3L) Chevrolet	1985-1996	32
140 CID (2.3L) Chevrolet	1971-1975	10	262 CID (4.3L) LB4 (ZR9/Z79) Turbo Chevrolet	1991-1993	33
145 CID (2.4L) Chevrolet Corvair	1961-1963	11	262 CID (4.3L) Vortec 4300 Chevrolet	1992-2003	34
151 CID (2.5L) Fuel Injected Pontiac	1985-1993	12	265 CID (4.3L) Chevrolet	1955-1957	35
153 CID (2.5L) Chevrolet	1963-1965	13	267 CID (4.4L) L39 Chevrolet	1979-1982	36
159 CID (2.6L) 3-53 Detroit Diesel Diesel	1967-1968	14	270 CID (4.4L) OHV General Motors	1939-1962	37
164 CID (2.7L) Chevrolet	1964	15	283 CID (4.6L) Chevrolet	1957-1967	38
173 CID (2.8L) Chevrolet	1982-1993	16	292 CID (4.8L) Chevrolet	1963-1989	39
189 CID (3.1L) Chevrolet	1990-1995	17	294 CID (4.8L) Vortec 4800 LR4 Chevrolet	1999-2003	40
194 CID (3.2L) Chevrolet	1964-1966	18	302 CID (5.0L) OHV General Motors	1952-1959	41
200 CID (3.3L) L26 Chevrolet	1978-1979	19	305 CID (5.0L) General Motors	1960-1974	42
207 CID (3.4L) LA1 Chevrolet	1996-2003	20	305 CID (5.0L) Chevrolet	1976-2002	43
216 CID (3.5L) Chevrolet	1937-1953	21	305 CID (5.0L) Chevrolet LPG	1976-1986	44
228 CID (3.7L) General Motors	1939-1953	22	307 CID (5.0L) Chevrolet	1968-1973	45
229 CID (3.8L) LC3 Chevrolet	1980-1984	23			

General Motors Truck

Engine Index (cont.)

Engine	Year	Block
325 CID (5.3L) Vortec 5300 Chevrolet	1999-2003	46
325 CID (5.3L) Vortec 5300 L59 Chevrolet Flex Fuel	2002-2003	47
327 CID (5.4L) Chevrolet	1962-1969	48
327 CID (5.4L) Chevrolet LPG	1962-1969	49
336 CID (5.5L) General Motors	1958-1959	50
348 CID (5.7L) Chevrolet	1958-1965	51
350 CID (5.7L) Carbureted Chevrolet	1969-1989	52
350 CID (5.7L) Fuel Injected Chevrolet	1987-2002	53
350 CID (5.7L) KL5 Chevrolet CNG	1997-2000	54
350 CID (5.7L) Oldsmobile Diesel	1978-1984	55
351 CID (5.8L) General Motors	1960-1972	56
365 CID (6.0L) Vortec 6000 Chevrolet	1999-2003	57
365 CID (6.0L) Vortec 6000 LQ4 (KL6) Chevrolet Bi-Fuel Gasoline/Compressed Natural Gas	2002-2003	58
365 CID (6.0L) Vortec 6000 LQ4 (KL8) Chevrolet CNG	2003	59

Model Index

Model	Engine	Year	Block
4	235 CID (3.9L) Chevrolet	1956-1959	27
6	235 CID (3.9L) Chevrolet	1955-1957	27
6PT042	427 CID (7.0L) Chevrolet	1990	68
100	228 CID (3.7L) General Motors	1939-1953	22
100	248 CID (4.1L) General Motors	1954-1955	29
100	270 CID (4.4L) OHV General Motors	1956-1959	37
100	336 CID (5.5L) General Motors	1958-1959	50
150	228 CID (3.7L) General Motors	1939-1942	22
150	248 CID (4.1L) General Motors	1954-1955	29
150	270 CID (4.4L) OHV General Motors	1956-1959	37
150	336 CID (5.5L) General Motors	1958-1959	50
250	228 CID (3.7L) General Motors	1939-1942	22
250	248 CID (4.1L) General Motors	1954-1955	29
250	270 CID (4.4L) OHV General Motors	1956-1959	37
250	336 CID (5.5L) General Motors	1958-1959	50
260 Series	228 CID (3.7L) General Motors	1941-1942	22
280 Series	228 CID (3.7L) General Motors	1947	22
300	270 CID (4.4L) OHV General Motors	1956-1959	37
300 Series	228 CID (3.7L) General Motors	1939-1942	22
300-24	248 CID (4.1L) General Motors	1954-1955	29
350	270 CID (4.4L) OHV General Motors	1956-1959	37
350-24	248 CID (4.1L) General Motors	1954-1955	29
350-27	270 CID (4.4L) OHV General Motors	1951-1955	37
370	270 CID (4.4L) OHV General Motors	1956-1959	37
400-24	248 CID (4.1L) General Motors	1954-1955	29
400-27	270 CID (4.4L) OHV General Motors	1951-1955	37
410V	270 CID (4.4L) OHV General Motors	1955	37
450	302 CID (5.0L) OHV General Motors	1955-1959	41
450-30	302 CID (5.0L) OHV General Motors	1952-1954	41
470-30	302 CID (5.0L) OHV General Motors	1952-1954	41
500	302 CID (5.0L) OHV General Motors	1955	41
1000	230 CID (3.8L) Chevrolet	1964-1965	24
1000	250 CID (4.1L) Chevrolet	1966	30
1000	305 CID (5.0L) General Motors	1960-1966	42
1200	283 CID (4.6L) Chevrolet	1958-1960	38
1500	230 CID (3.8L) Chevrolet	1964-1965	24
1500	250 CID (4.1L) Chevrolet	1966	30
1500	283 CID (4.6L) Chevrolet	1957	38

Engine	Year	Block
366 CID (6.0L) Chevrolet	1966-1998	60
379 CID (6.2L) General Motors	1973-1974	61
379 CID (6.2L) Chevrolet Diesel	1982-1993	62
395 CID/6468CC (6.5L) Chevrolet Diesel	1992-2002	63
396 CID (6.6L) Chevrolet	1966-1970	64
400 CID (6.6L) Chevrolet	1974-1980	65
401 CID (6.6L) General Motors	1960-1972	66
402 CID (6.6L) Chevrolet	1970-1972	67
427 CID (7.0L) Chevrolet	1966-1998	68
432 CID (7.1L) General Motors	1973-1974	69
454 CID (7.4L) Chevrolet	1966-2000	70
478 CID (7.8L) General Motors	1965	71
478 CID (7.8L) General Motors Diesel	1965-1974	72
496 CID/8135CC (8.1L) Vortec 8100 L18 OHV Chevrolet	2001-2003	73

Model	Engine	Year	Block
1500	305 CID (5.0L) General Motors	1960-1966	42
2500	230 CID (3.8L) Chevrolet	1964-1965	24
2500	250 CID (4.1L) Chevrolet	1966	30
2500	305 CID (5.0L) General Motors	1960-1963	42
3100	216 CID (3.5L) Chevrolet	1947-1953	21
3100	235 CID (3.9L) Chevrolet	1953-1959	27
3100	265 CID (4.3L) Chevrolet	1955-1957	35
3100	283 CID (4.6L) Chevrolet	1958-1959	38
3200	235 CID (3.9L) Chevrolet	1955-1959	27
3200	265 CID (4.3L) Chevrolet	1955-1957	35
3200	283 CID (4.6L) Chevrolet	1958-1959	38
3500	305 CID (5.0L) General Motors	1963-1966	42
3600	216 CID (3.5L) Chevrolet	1947-1952	21
3600	235 CID (3.9L) Chevrolet	1952-1959	27
3600	265 CID (4.3L) Chevrolet	1955-1957	35
3600	283 CID (4.6L) Chevrolet	1958-1959	38
3800	216 CID (3.5L) Chevrolet	1947-1952	21
3800	235 CID (3.9L) Chevrolet	1952-1959	27
3800	265 CID (4.3L) Chevrolet	1955-1957	35
3800	283 CID (4.6L) Chevrolet	1958-1959	38
4000	351 CID (5.8L) General Motors	1962-1966	56
4100	265 CID (4.3L) Chevrolet	1955-1957	35
4400	265 CID (4.3L) Chevrolet	1955-1957	35
4500	265 CID (4.3L) Chevrolet	1955-1957	35
5000	351 CID (5.8L) General Motors	1962-1965	56
5100	265 CID (4.3L) Chevrolet	1955-1956	35
5400	265 CID (4.3L) Chevrolet	1955-1956	35
5700	265 CID (4.3L) Chevrolet	1955-1956	35
6100	265 CID (4.3L) Chevrolet	1956	35
6400	265 CID (4.3L) Chevrolet	1956	35
6500	265 CID (4.3L) Chevrolet	1956	35
6700	265 CID (4.3L) Chevrolet	1956	35
6800	265 CID (4.3L) Chevrolet	1956	35
7100	265 CID (4.3L) Chevrolet	1956	35
7200	265 CID (4.3L) Chevrolet	1956	35
7300	265 CID (4.3L) Chevrolet	1956	35
8200	265 CID (4.3L) Chevrolet	1956	35
8400	265 CID (4.3L) Chevrolet	1956	35
8500	265 CID (4.3L) Chevrolet	1956	35
8700	265 CID (4.3L) Chevrolet	1956	35
8800	265 CID (4.3L) Chevrolet	1956	35
	305 CID (5.0L) Chevrolet	1976-1994	44
	327 CID (5.4L) Chevrolet	1962-1969	49
	327 CID (5.4L) Chevrolet	1962-1969	48
	396 CID (6.6L) Chevrolet	1968-1969	64
	305 CID (5.0L) Chevrolet	1976-1994	44
	327 CID (5.4L) Chevrolet	1962-1969	49
A60	478 CID (7.8L) General Motors Diesel	1965-1966	72
A4000	351 CID (5.8L) General Motors	1960-1961	56

General Motors Truck

Model Index (cont.)

Model	Engine	Year	Block	Model	Engine	Year	Block	
A5000	401 CID (6.6L) General Motors	1960-1961	66	Blazer	262 CID (4.3L) Chevrolet	1985-1988	32	
A6000	401 CID (6.6L) General Motors	1963-1965	66	Blazer	292 CID (4.8L) Chevrolet	1969-1986	39	
A6500	478 CID (7.8L) General Motors	1964-1965	71	Blazer	305 CID (5.0L) Chevrolet	1977-1988	43	
AC400	248 CID (4.1L) General Motors	1939-1940	29	Blazer	307 CID (5.0L) Chevrolet	1969-1972	45	
AC400	270 CID (4.4L) OHV General Motors	1939-1940	37	Blazer	350 CID (5.7L) Fuel Injected Chevrolet	1987-1994	53	
AC450	248 CID (4.1L) General Motors	1939-1940	29	Blazer	350 CID (5.7L) Oldsmobile Diesel	1978-1981	55	
ACS400	248 CID (4.1L) General Motors	1939-1940	29	Blazer	350 CID (5.7L) Carbureted Chevrolet	1969-1986	52	
ACS400	270 CID (4.4L) OHV General Motors	1939-1940	37	Blazer	379 CID (6.2L) Chevrolet Diesel	1982-1991	62	
ACS450	248 CID (4.1L) General Motors	1939-1940	29	Blazer	395 CID/6468CC (6.5L) Chevrolet Diesel	1994	63	
ACW400	248 CID (4.1L) General Motors	1939-1940	29	Blazer	400 CID (6.6L) Chevrolet	1975-1980	65	
ACW400	270 CID (4.4L) OHV General Motors	1939-1940	37	Blazer	454 CID (7.4L) Chevrolet	1973-1982	70	
AF400	248 CID (4.1L) General Motors	1939-1940	29	Blazer	262 CID (4.3L) Vortec 4300	2002-2004	34	
AF400	270 CID (4.4L) OHV General Motors	1939-1940	37	Xtreme	Chevrolet			
AF450	248 CID (4.1L) General Motors	1939-1940	29	Bravada	262 CID (4.3L) Vortec 4300 Chevrolet	1992-2001	34	
AK	216 CID (3.5L) Chevrolet	1941	21	Bravada	262 CID (4.3L) Chevrolet	1991-1994	32	
AL	216 CID (3.5L) Chevrolet	1941	21	C5D042	292 CID (4.8L) Chevrolet	1979-1986	39	
AN	216 CID (3.5L) Chevrolet	1941	21	C5D042	350 CID (5.7L) Carbureted Chevrolet	1979-1989	52	
Astro	151 CID (2.5L) Fuel Injected Pontiac	1985-1991	12	C5H042	366 CID (6.0L) Chevrolet	1990-1991	60	
Astro	262 CID (4.3L) Vortec 4300 Chevrolet	1992-2004	34	C6D042	292 CID (4.8L) Chevrolet	1979-1986	39	
Astro	262 CID (4.3L) Chevrolet	1985-1994	32	C6D042	350 CID (5.7L) Carbureted Chevrolet	1979-1989	52	
Astro EXT	262 CID (4.3L) Vortec 4300 Chevrolet	1992-1994	34	C6D042	366 CID (6.0L) Chevrolet	1979-1988	60	
Astro EXT	262 CID (4.3L) Chevrolet	1990-1994	32	C6D062	366 CID (6.0L) Chevrolet	1979-1982	60	
Avalanche 1500	325 CID (5.3L) Vortec 5300 Chevrolet	2002-2003	46	C6H042	366 CID (6.0L) Chevrolet	1990-1996	60	
Avalanche 2500	496 CID/8135CC (8.1L) Vortec	2002-2003	73	C7D042	366 CID (6.0L) Chevrolet	1979-1988	60	
Aztek	8100 L18 OHV Chevrolet			C7D042	427 CID (7.0L) Chevrolet	1979-1989	68	
B6P042	207 CID (3.4L) LA1 Chevrolet	2001-2004	20	C7D042	454 CID (7.4L) Chevrolet	1979-1982	70	
B6P042	350 CID (5.7L) Carbureted Chevrolet	1979-1989	52	C7D064	366 CID (6.0L) Chevrolet	1979-1988	60	
B6P042	366 CID (6.0L) Chevrolet	1979-1992	60	C7D064	427 CID (7.0L) Chevrolet	1979-1989	68	
B6P042	427 CID (7.0L) Chevrolet	1979-1984	68	C7D064	454 CID (7.4L) Chevrolet	1979-1982	70	
B7T042	366 CID (6.0L) Chevrolet	1993-1998	60	C7H042	366 CID (6.0L) Chevrolet	1990-1996	60	
B7T042	427 CID (7.0L) Chevrolet	1993-1998	68	C7H042	427 CID (7.0L) Chevrolet	1990-1996	68	
B3500	305 CID (5.0L) General Motors	1963-1966	42	C10	230 CID (3.8L) Chevrolet	1963-1969	24	
B4000	305 CID (5.0L) General Motors	1963-1966	42	C10	235 CID (3.9L) Chevrolet	1960-1962	27	
B4000	351 CID (5.8L) General Motors	1963-1965	56	C10	250 CID (4.1L) Chevrolet	1966-1984	30	
B5000	351 CID (5.8L) General Motors	1963-1965	56	C10	261 CID (4.3L) Chevrolet	1962	31	
B7500	454 CID (7.4L) Chevrolet	1999-2000	70	C10	262 CID (4.3L) Chevrolet	1985-1986	32	
BA4000	305 CID (5.0L) General Motors	1960-1963	42	C10	283 CID (4.6L) Chevrolet	1960-1967	38	
BA4000	351 CID (5.8L) General Motors	1960-1961	56	C10	292 CID (4.8L) Chevrolet	1963-1986	39	
BA5000	351 CID (5.8L) General Motors	1960-1962	56	C10	305 CID (5.0L) Chevrolet	1977-1986	43	
BA5500	401 CID (6.6L) General Motors	1960-1965	66	C10	307 CID (5.0L) Chevrolet	1968-1972	45	
BA6000	401 CID (6.6L) General Motors	1960-1965	66	C10	327 CID (5.4L) Chevrolet	1965-1968	48	
BA6500	478 CID (7.8L) General Motors	1964-1965	71	C10	350 CID (5.7L) Oldsmobile Diesel	1978-1981	55	
BH4000	305 CID (5.0L) General Motors	1963-1965	42	C10	350 CID (5.7L) Carbureted Chevrolet	1969-1986	52	
BH4000	351 CID (5.8L) General Motors	1963-1965	56	C10	379 CID (6.2L) Chevrolet Diesel	1982-1986	62	
BH5000	401 CID (6.6L) General Motors	1963-1965	66	C10	396 CID (6.6L) Chevrolet	1968-1969	64	
BK	216 CID (3.5L) Chevrolet	1942	21	C10	402 CID (6.6L) Chevrolet	1970-1972	67	
BL	216 CID (3.5L) Chevrolet	1942	21	C10	454 CID (7.4L) Chevrolet	1973-1982	70	
BN	216 CID (3.5L) Chevrolet	1942-1943	21	C10	230 CID (3.8L) Chevrolet	1963-1965	24	
BV4000	305 CID (5.0L) General Motors	1960-1963	42	Suburban	C10	235 CID (3.9L) Chevrolet	1960-1962	27
BV4000	351 CID (5.8L) General Motors	1960-1961	56	Suburban	C10	250 CID (4.1L) Chevrolet	1966-1984	30
BV5000	351 CID (5.8L) General Motors	1960-1962	56	Suburban	C10	261 CID (4.3L) Chevrolet	1962	31
BV5500	401 CID (6.6L) General Motors	1960-1965	66	Suburban	C10	262 CID (4.3L) Chevrolet	1985-1986	32
BV6000	401 CID (6.6L) General Motors	1960-1965	66	Suburban	C10	283 CID (4.6L) Chevrolet	1960-1967	38
BWA5000	351 CID (5.8L) General Motors	1960-1962	56	Suburban				
BWA5000	401 CID (6.6L) General Motors	1960-1961	66					
BWA5500	401 CID (6.6L) General Motors	1960-1965	66					
BWV5000	351 CID (5.8L) General Motors	1960-1962	56					
BWV5000	401 CID (6.6L) General Motors	1960-1961	66					
BWV5500	401 CID (6.6L) General Motors	1960-1965	66					
Blazer	250 CID (4.1L) Chevrolet	1969-1984	30					
Blazer	262 CID (4.3L) Vortec 4300 Chevrolet	1995-2004	34					

General Motors Truck

Model Index (cont.)

Model	Engine	Year	Block	Model	Engine	Year	Block
C10	292 CID (4.8L) Chevrolet	1963-1986	39	C30	379 CID (6.2L) Chevrolet Diesel	1982-1986	62
Suburban				C30	396 CID (6.6L) Chevrolet	1968-1969	64
C10	305 CID (5.0L) Chevrolet	1977-1986	43	C30	402 CID (6.6L) Chevrolet	1970-1972	67
Suburban				C30	454 CID (7.4L) Chevrolet	1973-1986	70
C10	307 CID (5.0L) Chevrolet	1968-1972	45	C40	235 CID (3.9L) Chevrolet	1960-1962	27
Suburban				C50	230 CID (3.8L) Chevrolet	1963-1965	24
C10	327 CID (5.4L) Chevrolet	1965-1968	48	C50	235 CID (3.9L) Chevrolet	1960-1962	27
Suburban				C60	366 CID (6.0L) Chevrolet	1966	60
C10	350 CID (5.7L) Oldsmobile	1978-1981	55	C70	348 CID (5.7L) Chevrolet	1960-1961	51
Suburban	Diesel			C1500	262 CID (4.3L) Vortec 4300 Chevrolet	1996-1998	34
C10	350 CID (5.7L) Carbureted Chevrolet	1969-1986	52	C1500	262 CID (4.3L) Chevrolet	1988-1995	32
Suburban				C1500	305 CID (5.0L) Chevrolet	1988-1998	43
C10	379 CID (6.2L) Chevrolet	1982-1986	62	C1500	350 CID (5.7L) Fuel Injected Chevrolet	1988-1998	53
Suburban	Diesel			C1500	379 CID (6.2L) Chevrolet Diesel	1988-1993	62
C10	396 CID (6.6L) Chevrolet	1968-1969	64	C1500	395 CID/6468CC (6.5L) Chevrolet Diesel	1994-1998	63
Suburban				C1500	454 CID (7.4L) Chevrolet	1988-1993	70
C10	402 CID (6.6L) Chevrolet	1970-1972	67	C1500	350 CID (5.7L) Fuel Injected Chevrolet	1992-1999	53
Suburban				Suburban			
C10	454 CID (7.4L) Chevrolet	1973-1982	70	C1500	395 CID/6468CC (6.5L) Chevrolet Diesel	1994-1999	63
Suburban				Suburban	Chevrolet Diesel		
C20	230 CID (3.8L) Chevrolet	1963-1969	24	C1500	250 CID (4.1L) Chevrolet	1967-1984	30
C20	235 CID (3.9L) Chevrolet	1960-1962	27	C1500	262 CID (4.3L) Chevrolet	1985-1986	32
C20	250 CID (4.1L) Chevrolet	1966-1984	30	Suburban	(GMC)		
C20	261 CID (4.3L) Chevrolet	1962	31	C1500	292 CID (4.8L) Chevrolet	1967-1971	39
C20	262 CID (4.3L) Chevrolet	1985-1986	32	Suburban	(GMC)		
C20	283 CID (4.6L) Chevrolet	1960-1967	38	C1500	305 CID (5.0L) Chevrolet	1977-1986	43
C20	292 CID (4.8L) Chevrolet	1963-1986	39	Suburban	(GMC)		
C20	305 CID (5.0L) Chevrolet	1977-1986	43	C1500	305 CID (5.0L) General Motors	1967-1969	42
C20	307 CID (5.0L) Chevrolet	1968-1972	45	Suburban	(GMC)		
C20	327 CID (5.4L) Chevrolet	1965-1968	48	C1500	307 CID (5.0L) Chevrolet	1970-1972	45
C20	350 CID (5.7L) Carbureted Chevrolet	1969-1986	52	Suburban	(GMC)		
C20	379 CID (6.2L) Chevrolet Diesel	1982-1986	62	C1500	350 CID (5.7L) Fuel Injected Chevrolet	1992-1999	53
C20	396 CID (6.6L) Chevrolet	1968-1969	64	Suburban	(GMC)		
C20	402 CID (6.6L) Chevrolet	1970-1972	67	C1500	350 CID (5.7L) Oldsmobile Diesel	1978-1981	55
C20	454 CID (7.4L) Chevrolet	1973-1986	70	Suburban	(GMC)		
Suburban				C1500	350 CID (5.7L) Carbureted Chevrolet	1970-1986	52
C20	262 CID (4.3L) Chevrolet	1985-1986	32	Suburban	(GMC)		
Suburban				C1500	379 CID (6.2L) Chevrolet Diesel	1982-1986	62
C20	283 CID (4.6L) Chevrolet	1967	38	Suburban	(GMC)		
Suburban				C1500	395 CID/6468CC (6.5L) Chevrolet Diesel	1994-1999	63
C20	292 CID (4.8L) Chevrolet	1967-1986	39	Suburban	(GMC)		
Suburban				C1500	396 CID (6.6L) Chevrolet	1968-1970	64
C20	305 CID (5.0L) Chevrolet	1977-1986	43	Suburban	(GMC)		
Suburban				C1500	402 CID (6.6L) Chevrolet	1971-1972	67
C20	307 CID (5.0L) Chevrolet	1968-1972	45	Suburban	(GMC)		
Suburban				C1500	454 CID (7.4L) Chevrolet	1973-1979	70
C20	327 CID (5.4L) Chevrolet	1967-1968	48	Suburban	(GMC)		
Suburban				C1500(GMC)	250 CID (4.1L) Chevrolet	1967-1984	30
C20	350 CID (5.7L) Carbureted Chevrolet	1969-1986	52	C1500(GMC)	262 CID (4.3L) Vortec 4300 Chevrolet	1996-1998	34
Suburban				C1500(GMC)	262 CID (4.3L) Chevrolet	1985-1995	32
C20	379 CID (6.2L) Chevrolet Diesel	1982-1986	62	C1500(GMC)	292 CID (4.8L) Chevrolet	1967-1971	39
Suburban							
C20	396 CID (6.6L) Chevrolet	1968-1969	64				
Suburban							
C20	402 CID (6.6L) Chevrolet	1970-1972	67				
Suburban							
C20	454 CID (7.4L) Chevrolet	1973-1986	70				
Suburban							
C30	230 CID (3.8L) Chevrolet	1963-1969	24				
C30	235 CID (3.9L) Chevrolet	1960-1962	27				
C30	250 CID (4.1L) Chevrolet	1966-1975	30				
C30	261 CID (4.3L) Chevrolet	1962	31				
C30	283 CID (4.6L) Chevrolet	1960-1967	38				
C30	292 CID (4.8L) Chevrolet	1963-1986	39				
C30	305 CID (5.0L) Chevrolet	1981-1986	43				
C30	307 CID (5.0L) Chevrolet	1968-1972	45				
C30	327 CID (5.4L) Chevrolet	1965-1968	48				
C30	350 CID (5.7L) Carbureted Chevrolet	1969-1986	52				

General Motors Truck

Model Index (cont.)

Model	Engine	Year	Block	Model	Engine	Year	Block
CC300	236 CID (3.9L) OHV General Motors	1942-1946	28	CM6500	432 CID (7.1L) General Motors	1973-1974	69
CC350	236 CID (3.9L) OHV General Motors	1942-1946	28	CS40	250 CID (4.1L) Chevrolet	1967-1972	30
CC400	248 CID (4.1L) General Motors	1941-1946	29	CS50	250 CID (4.1L) Chevrolet	1966	30
CC400	270 CID (4.4L) OHV General Motors	1941-1947	37	CS4500	292 CID (4.8L) Chevrolet	1970-1972	39
CC450	248 CID (4.1L) General Motors	1941-1947	29	CS5000	292 CID (4.8L) Chevrolet	1973-1978	39
CCS300	236 CID (3.9L) OHV General Motors	1942-1946	28	CS5500	292 CID (4.8L) Chevrolet	1970-1972	39
CCS350	236 CID (3.9L) OHV General Motors	1942-1946	28	CS6000	292 CID (4.8L) Chevrolet	1973-1978	39
CCS400	248 CID (4.1L) General Motors	1941-1946	29	CTF350	236 CID (3.9L) OHV General Motors	1942-1946	28
CCS400	270 CID (4.4L) OHV General Motors	1941-1947	37	Caballero	200 CID (3.3L) L26 Chevrolet	1978-1979	19
CCS450	248 CID (4.1L) General Motors	1941-1946	29	Caballero	229 CID (3.8L) LC3 Chevrolet	1980-1984	23
CCT350	236 CID (3.9L) OHV General Motors	1942-1946	28	Caballero	231 CID (3.8L) Carbureted Buick	1978-1984	25
CCT400	270 CID (4.4L) OHV General Motors	1941-1947	37	Caballero	262 CID (4.3L) Chevrolet	1985-1987	32
CCW400	248 CID (4.1L) General Motors	1941-1946	29	Caballero	267 CID (4.4L) L39 Chevrolet	1979-1982	36
CCW400	270 CID (4.4L) OHV General Motors	1941-1947	37	Caballero	305 CID (5.0L) Chevrolet	1978-1987	43
CE40	350 CID (5.7L) Carbureted Chevrolet	1969-1972	52	Caballero	350 CID (5.7L) Oldsmobile Diesel	1983-1984	55
CE50	327 CID (5.4L) Chevrolet	1966-1968	48	Caballero	350 CID (5.7L) Carbureted Chevrolet	1978-1980	52
CE50	350 CID (5.7L) Carbureted Chevrolet	1969-1978	52	Classic Sierra 1500	305 CID (5.0L) Chevrolet	1999	43
CE50	366 CID (6.0L) Chevrolet	1967-1972	60	Classic Sierra 1500	350 CID (5.7L) Fuel Injected Chevrolet	1999	53
CE60	327 CID (5.4L) Chevrolet	1966-1968	48	Classic Sierra 2500	350 CID (5.7L) KL5 Chevrolet	1997-2000	54
CE60	350 CID (5.7L) Carbureted Chevrolet	1973-1978	52	Classic Sierra 2500	350 CID (5.7L) Fuel Injected Chevrolet	1997-2000	53
CE60	366 CID (6.0L) Chevrolet	1967-1978	60	Classic Sierra 2500	395 CID/6468CC (6.5L) Chevrolet Diesel	1999-2000	63
CE60	427 CID (7.0L) Chevrolet	1966-1972	68	Classic Sierra 2500	454 CID (7.4L) Chevrolet	1999-2000	70
CE65	366 CID (6.0L) Chevrolet	1973-1978	60	Classic Sierra 3500	350 CID (5.7L) KL5 Chevrolet	1997-2000	54
CE65	427 CID (7.0L) Chevrolet	1973-1978	68	Classic Sierra 3500	350 CID (5.7L) Fuel Injected Chevrolet	1999-2000	53
CE5500	366 CID (6.0L) Chevrolet	1969-1972	60	Classic Sierra 3500	395 CID/6468CC (6.5L) Chevrolet Diesel	1999-2000	63
CE6000	366 CID (6.0L) Chevrolet	1973-1978	60	Classic Sierra 3500	454 CID (7.4L) Chevrolet	1999-2000	70
CE6500	366 CID (6.0L) Chevrolet	1969-1978	60	Classic Sierra 3500HD	395 CID/6468CC (6.5L) Chevrolet Diesel	1999-2002	63
CE6500	427 CID (7.0L) Chevrolet	1969-1978	68	Classic Sierra 3500HD	454 CID (7.4L) Chevrolet	1999-2000	70
CF300	236 CID (3.9L) OHV General Motors	1942-1946	28	Classic Sierra 3500HD	496 CID/8135CC (8.1L) Vortec	2001-2002	73
CF350	236 CID (3.9L) OHV General Motors	1942-1946	28	3500HD	8100 L18 OHV Chevrolet		
CF400	248 CID (4.1L) General Motors	1941-1946	29	Corvair	145 CID (2.4L) Chevrolet	1961-1963	11
CF400	270 CID (4.4L) OHV General Motors	1941-1947	37	Corvair	164 CID (2.7L) Chevrolet	1964	15
CF450	248 CID (4.1L) General Motors	1941-1947	29	DA4000	478 CID (7.8L) General Motors Diesel	1964-1966	72
CFT400	270 CID (4.4L) OHV General Motors	1941-1947	37	DAH5000	478 CID (7.8L) General Motors Diesel	1964-1965	72
CFW350	236 CID (3.9L) OHV General Motors	1942-1946	28	DAV5000	478 CID (7.8L) General Motors Diesel	1964-1965	72
CFW400	270 CID (4.4L) OHV General Motors	1941-1947	37	DBA4000	478 CID (7.8L) General Motors Diesel	1964-1965	72
CG50	478 CID (7.8L) General Motors Diesel	1967-1970	72	DBAH5000	478 CID (7.8L) General Motors Diesel	1964-1965	72
CG60	478 CID (7.8L) General Motors Diesel	1967-1969	72	DBV4000	478 CID (7.8L) General Motors Diesel	1964-1965	72
CG5500	478 CID (7.8L) General Motors Diesel	1970-1972	72	DBVH5000	478 CID (7.8L) General Motors Diesel	1964-1965	72
CG6000	478 CID (7.8L) General Motors Diesel	1973-1974	72	DLA4000	478 CID (7.8L) General Motors Diesel	1964-1969	72
CK	216 CID (3.5L) Chevrolet	1944-1945	21	DLAH5000	478 CID (7.8L) General Motors Diesel	1964-1965	72
CM65	432 CID (7.1L) General Motors	1973-1974	69	DLV4000	478 CID (7.8L) General Motors Diesel	1964-1969	72
CM3500	305 CID (5.0L) General Motors	1967-1969	42	DLVH5000	478 CID (7.8L) General Motors Diesel	1964-1965	72
CM3500	351 CID (5.8L) General Motors	1967-1969	56	DP	216 CID (3.5L) Chevrolet	1946	21
CM5500	305 CID (5.0L) General Motors	1970-1972	42				
CM5500	351 CID (5.8L) General Motors	1970-1972	56				
CM6000	305 CID (5.0L) General Motors	1973-1974	42				
CM6000	379 CID (6.2L) General Motors	1973-1974	61				
CM6500	351 CID (5.8L) General Motors	1970-1972	56				
CM6500	379 CID (6.2L) General Motors	1973-1974	61				

General Motors Truck

Model Index (cont.)

Model	Engine	Year	Block	Model	Engine	Year	Block
DR	216 CID (3.5L) Chevrolet	1946	21	Express 2500	262 CID (4.3L) Vortec 4300 Chevrolet	1996-2002	34
DS4000	478 CID (7.8L) General Motors Diesel	1965-1966	72	Express 2500	294 CID (4.8L) Vortec 4800 LR4 Chevrolet	2003-2004	40
DS	216 CID (3.5L) Chevrolet	1946	21	Express 2500	305 CID (5.0L) Chevrolet	1996-2002	43
DSPA5000	478 CID (7.8L) General Motors Diesel	1964-1965	72	Express 2500	325 CID (5.3L) Vortec 5300 Chevrolet	2003-2004	46
DSPV5000	478 CID (7.8L) General Motors Diesel	1964-1965	72	Express 2500	350 CID (5.7L) Fuel Injected Chevrolet	1996-2002	53
DV4000	478 CID (7.8L) General Motors Diesel	1964-1966	72	Express 2500	365 CID (6.0L) Vortec 6000 LQ4 (KL8) Chevrolet	2003-2004	59
DWA5000	478 CID (7.8L) General Motors Diesel	1964-1965	72	Express 2500	365 CID (6.0L) Vortec 6000 LQ4 (KL6) Chevrolet	2003-2004	58
DWV5000	478 CID (7.8L) General Motors Diesel	1964-1965	72	Express 2500	365 CID (6.0L) Vortec 6000 Chevrolet	2003-2004	57
EC470	270 CID (4.4L) OHV General Motors	1947-1950	37	Express 2500	395 CID/6468CC (6.5L) Chevrolet Diesel	1996-2002	63
EF470	270 CID (4.4L) OHV General Motors	1947-1950	37	Express 2500	262 CID (4.3L) Vortec 4300 Chevrolet	1996-2004	34
EG5500	478 CID (7.8L) General Motors Diesel	1967-1969	72	EXT	294 CID (4.8L) Vortec 4800 LR4 Chevrolet	2003-2004	40
EG6500	478 CID (7.8L) General Motors Diesel	1967-1969	72	Express 2500	305 CID (5.0L) Chevrolet	1996-2002	43
EM4500	305 CID (5.0L) General Motors	1967-1969	42	EXT	325 CID (5.3L) Vortec 5300 Chevrolet	2003-2004	46
EM5500	305 CID (5.0L) General Motors	1967-1969	42	Express 2500	350 CID (5.7L) Fuel Injected Chevrolet	1996-2002	53
EM5500	351 CID (5.8L) General Motors	1967-1969	56	EXT	365 CID (6.0L) Vortec 6000 LQ4 (KL8) Chevrolet	2003-2004	59
EM6500	305 CID (5.0L) General Motors	1967-1969	42	Express 2500	365 CID (6.0L) Vortec 6000 LQ4 (KL6) Chevrolet	2003-2004	58
EM6500	351 CID (5.8L) General Motors	1967-1969	56	EXT	365 CID (6.0L) Vortec 6000 Chevrolet	2003-2004	57
ES4500	292 CID (4.8L) Chevrolet	1967-1969	39	Express 2500	395 CID/6468CC (6.5L) Chevrolet Diesel	1996-2002	63
ES5500	292 CID (4.8L) Chevrolet	1967-1969	39	EXT	350 CID (5.7L) Fuel Injected Chevrolet	1996-2002	53
ES6500	292 CID (4.8L) Chevrolet	1967-1968	39	Express 3500	365 CID (6.0L) Vortec 6000 LQ4 (KL8) Chevrolet	2003-2004	59
El Camino	194 CID (3.2L) Chevrolet	1964-1966	18	Express 3500	365 CID (6.0L) Vortec 6000 LQ4 (KL6) Chevrolet	2003-2004	58
El Camino	200 CID (3.3L) L26 Chevrolet	1978-1979	19	Express 3500	365 CID (6.0L) Vortec 6000 Chevrolet	2003-2004	57
El Camino	229 CID (3.8L) LC3 Chevrolet	1980-1984	23	EXT	395 CID/6468CC (6.5L) Chevrolet Diesel	1996-2002	63
El Camino	230 CID (3.8L) Chevrolet	1964-1969	24	Express 2500	350 CID (5.7L) Fuel Injected Chevrolet	1996-2002	53
El Camino	231 CID (3.8L) Carbureted Buick	1978-1984	25	Express 3500	365 CID (6.0L) Vortec 6000 LQ4 (KL8) Chevrolet	2003-2004	59
El Camino	250 CID (4.1L) Chevrolet	1970-1977	30	Express 3500	365 CID (6.0L) Vortec 6000 LQ4 (KL6) Chevrolet	2003-2004	58
El Camino	262 CID (4.3L) Chevrolet	1985-1987	32	Express 3500	365 CID (6.0L) Vortec 6000 Chevrolet	2003-2004	57
El Camino	267 CID (4.4L) L39 Chevrolet	1979-1982	36	Express 3500	395 CID/6468CC (6.5L) Chevrolet Diesel	1996-2002	63
El Camino	283 CID (4.6L) Chevrolet	1959-1967	38	Express 3500	454 CID (7.4L) Chevrolet	1996-2000	70
El Camino	305 CID (5.0L) Chevrolet	1976-1987	43	Express 3500	496 CID/8135CC (8.1L) Vortec 8100 L18 OHV Chevrolet	2001-2002	73
El Camino	307 CID (5.0L) Chevrolet	1968-1973	45	Express 3500	350 CID (5.7L) Fuel Injected Chevrolet	1996-2002	53
El Camino	327 CID (5.4L) Chevrolet	1965-1968	48	EXT	365 CID (6.0L) Vortec 6000 LQ4 (KL8) Chevrolet	2003-2004	59
El Camino	350 CID (5.7L) Oldsmobile Diesel	1982-1984	55	Express 3500	365 CID (6.0L) Vortec 6000 LQ4 (KL6) Chevrolet	2003-2004	58
El Camino	350 CID (5.7L) Carbureted Chevrolet	1970-1981	52	EXT	365 CID (6.0L) Vortec 6000 Chevrolet	2003-2004	57
El Camino	396 CID (6.6L) Chevrolet	1965-1971	64	Express 3500	395 CID/6468CC (6.5L) Chevrolet Diesel	1996-2002	63
El Camino	400 CID (6.6L) Chevrolet	1974-1976	65	EXT	454 CID (7.4L) Chevrolet	1996-2000	70
El Camino	402 CID (6.6L) Chevrolet	1970-1972	67	Express 3500	270 CID (4.4L) OHV General Motors	1956-1959	37
El Camino	454 CID (7.4L) Chevrolet	1970-1975	70	F350-24	248 CID (4.1L) General Motors	1954-1955	29
Envoy	262 CID (4.3L) Vortec 4300 Chevrolet	1998-2001	34	F350-27	270 CID (4.4L) OHV General Motors	1951-1955	37
Envoy XL	325 CID (5.3L) Vortec 5300 Chevrolet	2003	46	F370	270 CID (4.4L) OHV General Motors	1956-1959	37
Escalade	325 CID (5.3L) Vortec 5300 Chevrolet	2002-2004	46	F410V	270 CID (4.4L) OHV General Motors	1955	37
Escalade	350 CID (5.7L) Fuel Injected Chevrolet	1999-2000	53	F450	302 CID (5.0L) OHV General Motors	1955-1959	41
Escalade	365 CID (6.0L) Vortec 6000 Chevrolet	2002-2004	57				
Escalade	365 CID (6.0L) Vortec 6000 Chevrolet	2003-2004	57				
ESV	365 CID (6.0L) Vortec 6000 Chevrolet	2002-2004	57				
Escalade EXT	365 CID (6.0L) Vortec 6000 Chevrolet	2002-2004	57				
Express 1500	262 CID (4.3L) Vortec 4300 Chevrolet	1996-2004	34				
Express 1500	305 CID (5.0L) Chevrolet	1996-2002	43				
Express 1500	325 CID (5.3L) Vortec 5300 Chevrolet	2003-2004	46				
Express 1500	350 CID (5.7L) Fuel Injected Chevrolet	1996-2002	53				

General Motors Truck

Model Index (cont.)

Model	Engine	Year	Block	Model	Engine	Year	Block
F450-30	302 CID (5.0L) OHV General Motors	1952-1954	41	G1500(GMC)	262 CID (4.3L) Vortec 4300 Chevrolet	1996-1999	34
F470-30	302 CID (5.0L) OHV General Motors	1952-1954	41	G1500(GMC)	262 CID (4.3L) Chevrolet	1985-1995	32
F500	302 CID (5.0L) OHV General Motors	1955	41	G1500(GMC)	283 CID (4.6L) Chevrolet	1967	38
FC300	248 CID (4.1L) General Motors	1947-1950	29	G1500(GMC)	292 CID (4.8L) Chevrolet	1970	39
FC350	248 CID (4.1L) General Motors	1947-1950	29	G1500(GMC)	305 CID (5.0L) Chevrolet	1977-1999	43
FC350	270 CID (4.4L) OHV General Motors	1948-1950	37	G1500(GMC)	307 CID (5.0L) Chevrolet	1968-1972	45
FC450	270 CID (4.4L) OHV General Motors	1947-1950	37	G1500(GMC)	350 CID (5.7L) Fuel Injected Chevrolet	1987-1999	53
FCS300	248 CID (4.1L) General Motors	1947-1950	29	G1500(GMC)	350 CID (5.7L) Carbureted Chevrolet	1972-1986	52
FCS450	270 CID (4.4L) OHV General Motors	1947-1950	37	G2500	262 CID (4.3L) Vortec 4300 Chevrolet	1996-1999	34
FF350	248 CID (4.1L) General Motors	1939-1953	29	G2500	305 CID (5.0L) Chevrolet	1996-1999	43
FF350	270 CID (4.4L) OHV General Motors	1948-1950	37	G2500	350 CID (5.7L) Fuel Injected Chevrolet	1996-1999	53
FF450	270 CID (4.4L) OHV General Motors	1947-1950	37	G2500	395 CID/6468CC (6.5L) Chevrolet Diesel	1996-1999	63
G10	153 CID (2.5L) Chevrolet	1964-1965	13	G2500(GMC)	230 CID (3.8L) Chevrolet	1967-1970	24
G10	194 CID (3.2L) Chevrolet	1964-1966	18	G2500(GMC)	250 CID (4.1L) Chevrolet	1973-1984	30
G10	230 CID (3.8L) Chevrolet	1964-1969	24	G2500(GMC)	262 CID (4.3L) Vortec 4300 Chevrolet	1996-1999	34
G10	250 CID (4.1L) Chevrolet	1966-1984	30	G2500(GMC)	262 CID (4.3L) Chevrolet	1985-1995	32
G10	262 CID (4.3L) Chevrolet	1985-1995	32	G2500(GMC)	283 CID (4.6L) Chevrolet	1967	38
G10	283 CID (4.6L) Chevrolet	1964-1967	38	G2500(GMC)	292 CID (4.8L) Chevrolet	1970-1978	39
G10	305 CID (5.0L) Chevrolet	1977-1995	43	G2500(GMC)	305 CID (5.0L) Chevrolet	1978-1999	43
G10	307 CID (5.0L) Chevrolet	1968-1972	45	G2500(GMC)	307 CID (5.0L) Chevrolet	1968-1971	45
G10	350 CID (5.7L) Fuel Injected Chevrolet	1987-1995	53	G2500(GMC)	350 CID (5.7L) Fuel Injected Chevrolet	1987-1999	53
G10	350 CID (5.7L) Carbureted Chevrolet	1969-1986	52	G2500(GMC)	350 CID (5.7L) Carbureted Chevrolet	1971-1988	52
G20	230 CID (3.8L) Chevrolet	1967-1969	24	G2500(GMC)	379 CID (6.2L) Chevrolet Diesel	1983-1993	62
G20	250 CID (4.1L) Chevrolet	1967-1984	30	G2500(GMC)	395 CID/6468CC (6.5L) Chevrolet Diesel	1994-1999	63
G20	262 CID (4.3L) Chevrolet	1985-1995	32	G2500(GMC)	400 CID (6.6L) Chevrolet	1975-1980	65
G20	283 CID (4.6L) Chevrolet	1967	38	G3500	350 CID (5.7L) Fuel Injected Chevrolet	1996-1999	53
G20	292 CID (4.8L) Chevrolet	1973-1989	39	G3500	395 CID/6468CC (6.5L) Chevrolet Diesel	1996-1999	63
G20	305 CID (5.0L) Chevrolet	1977-1995	43	G3500	454 CID (7.4L) Chevrolet	1996-1999	70
G20	307 CID (5.0L) Chevrolet	1968-1972	45	G3500(GMC)	250 CID (4.1L) Chevrolet	1971-1984	30
G20	350 CID (5.7L) Fuel Injected Chevrolet	1987-1995	53	G3500(GMC)	262 CID (4.3L) Chevrolet	1985-1995	32
G20	350 CID (5.7L) Carbureted Chevrolet	1969-1988	52	G3500(GMC)	292 CID (4.8L) Chevrolet	1975-1978	39
G20	379 CID (6.2L) Chevrolet Diesel	1982-1993	62	G3500(GMC)	305 CID (5.0L) Chevrolet	1985-1991	43
G20	395 CID/6468CC (6.5L) Chevrolet Diesel	1994-1995	63	G3500(GMC)	307 CID (5.0L) Chevrolet	1971	45
G20	400 CID (6.6L) Chevrolet	1975-1980	65	G3500(GMC)	350 CID (5.7L) Fuel Injected Chevrolet	1987-1999	53
G30	250 CID (4.1L) Chevrolet	1971-1984	30	G3500(GMC)	350 CID (5.7L) Carbureted Chevrolet	1971-1988	52
G30	262 CID (4.3L) Chevrolet	1985-1996	32	G3500(GMC)	379 CID (6.2L) Chevrolet Diesel	1983-1993	62
G30	292 CID (4.8L) Chevrolet	1973-1989	39	G3500(GMC)	395 CID/6468CC (6.5L) Chevrolet Diesel	1994-1999	63
G30	305 CID (5.0L) Chevrolet	1981-1995	43	G3500(GMC)	400 CID (6.6L) Chevrolet	1975-1979	65
G30	350 CID (5.7L) Fuel Injected Chevrolet	1987-1996	53	G3500(GMC)	454 CID (7.4L) Chevrolet	1988-1999	70
G30	350 CID (5.7L) Carbureted Chevrolet	1971-1988	52	GC	216 CID (3.5L) Chevrolet	1937	21
G30	379 CID (6.2L) Chevrolet Diesel	1982-1993	62	H4000	305 CID (5.0L) General Motors	1966	42
G30	395 CID/6468CC (6.5L) Chevrolet Diesel	1994-1996	63	H4000	351 CID (5.8L) General Motors	1963-1966	56
G30	400 CID (6.6L) Chevrolet	1975-1980	65	H5000	401 CID (6.6L) General Motors	1961-1965	66
G30	454 CID (7.4L) Chevrolet	1987-1996	70	HC470	270 CID (4.4L) OHV General Motors	1948-1950	37
G1000	153 CID (2.5L) Chevrolet	1964-1965	13	HC	216 CID (3.5L) Chevrolet	1938	21
G1000	194 CID (3.2L) Chevrolet	1966	18	HE70	427 CID (7.0L) Chevrolet	1973-1978	68
G1000	230 CID (3.8L) Chevrolet	1964-1966	24	HE75	427 CID (7.0L) Chevrolet	1975-1978	68
G1500	262 CID (4.3L) Vortec 4300 Chevrolet	1996-1999	34	HE80	427 CID (7.0L) Chevrolet	1973-1978	68
G1500	305 CID (5.0L) Chevrolet	1996-1999	43	HG5500	478 CID (7.8L) General Motors Diesel	1965-1967	72
G1500	350 CID (5.7L) Fuel Injected Chevrolet	1996-1999	53	HG7500	478 CID (7.8L) General Motors Diesel	1965-1969	72
G1500(GMC)	230 CID (3.8L) Chevrolet	1967-1970	24	HI4000	292 CID (4.8L) Chevrolet	1966	39
G1500(GMC)	250 CID (4.1L) Chevrolet	1971-1984	30	HM5500	305 CID (5.0L) General Motors	1966-1967	42

LIGHT TRUCK

General Motors Truck

Model Index (cont.)

Model	Engine	Year	Block	Model	Engine	Year	Block
HM5500	351 CID (5.8L) General Motors	1966-1969	56	K10	396 CID (6.6L) Chevrolet	1968-1969	64
HM7500	401 CID (6.6L) General Motors	1966-1972	66	Suburban			
HM8500	351 CID (5.8L) General Motors	1966-1969	56	K10	400 CID (6.6L) Chevrolet	1975-1980	65
HM8500	401 CID (6.6L) General Motors	1966-1969	66	Suburban			
I4000	292 CID (4.8L) Chevrolet	1966	39	K10	454 CID (7.4L) Chevrolet	1973-1982	70
J8C042	427 CID (7.0L) Chevrolet	1979-1982	68	Suburban			
J8C064	427 CID (7.0L) Chevrolet	1979-1982	68	K20	230 CID (3.8L) Chevrolet	1963-1969	24
JC	216 CID (3.5L) Chevrolet	1939	21	K20	235 CID (3.9L) Chevrolet	1960-1962	27
JE70	427 CID (7.0L) Chevrolet	1973-1978	68	K20	250 CID (4.1L) Chevrolet	1966-1984	30
JE75	427 CID (7.0L) Chevrolet	1975-1978	68	K20	261 CID (4.3L) Chevrolet	1962	31
JE80	427 CID (7.0L) Chevrolet	1973-1978	68	K20	262 CID (4.3L) Chevrolet	1985-1986	32
JM7500	351 CID (5.8L) General Motors	1966-1969	56	K20	283 CID (4.6L) Chevrolet	1960-1967	38
JM7500	401 CID (6.6L) General Motors	1966-1972	66	K20	292 CID (4.8L) Chevrolet	1963-1986	39
JM8500	401 CID (6.6L) General Motors	1966-1970	66	K20	305 CID (5.0L) Chevrolet	1977-1986	43
Jimmy	250 CID (4.1L) Chevrolet	1971-1984	30	K20	307 CID (5.0L) Chevrolet	1968-1972	45
Jimmy	262 CID (4.3L) Vortec 4300 Chevrolet	1995-2003	34	K20	327 CID (5.4L) Chevrolet	1965-1968	48
Jimmy	262 CID (4.3L) Chevrolet	1985-1986	32	K20	350 CID (5.7L) Carbureted Chevrolet	1969-1986	52
Jimmy	292 CID (4.8L) Chevrolet	1985	39	K20	379 CID (6.2L) Chevrolet Diesel	1982-1986	62
Jimmy	305 CID (5.0L) Chevrolet	1977-1986	43	K20	396 CID (6.6L) Chevrolet	1968-1969	64
Jimmy	307 CID (5.0L) Chevrolet	1971-1972	45	K20	400 CID (6.6L) Chevrolet	1975-1980	65
Jimmy	350 CID (5.7L) Fuel Injected Chevrolet	1987-1991	53	K20	454 CID (7.4L) Chevrolet	1976-1986	70
Jimmy	350 CID (5.7L) Oldsmobile Diesel	1978-1981	55	K20	250 CID (4.1L) Chevrolet	1967-1984	30
Jimmy	350 CID (5.7L) Carbureted Chevrolet	1971-1986	52	Suburban			
Jimmy	379 CID (6.2L) Chevrolet Diesel	1982-1991	62	K20	262 CID (4.3L) Chevrolet	1985-1986	32
Jimmy	400 CID (6.6L) Chevrolet	1975-1979	65	Suburban			
K10	230 CID (3.8L) Chevrolet	1963-1969	24	K20	283 CID (4.6L) Chevrolet	1967	38
K10	235 CID (3.9L) Chevrolet	1960-1962	27	Suburban			
K10	250 CID (4.1L) Chevrolet	1966-1984	30	K20	292 CID (4.8L) Chevrolet	1967-1986	39
K10	261 CID (4.3L) Chevrolet	1962	31	Suburban			
K10	262 CID (4.3L) Chevrolet	1985-1986	32	K20	305 CID (5.0L) Chevrolet	1977-1986	43
K10	283 CID (4.6L) Chevrolet	1960-1967	38	Suburban			
K10	292 CID (4.8L) Chevrolet	1963-1986	39	K20	307 CID (5.0L) Chevrolet	1968-1972	45
K10	305 CID (5.0L) Chevrolet	1977-1986	43	Suburban			
K10	307 CID (5.0L) Chevrolet	1968-1972	45	K20	327 CID (5.4L) Chevrolet	1967-1968	48
K10	327 CID (5.4L) Chevrolet	1965-1968	48	Suburban			
K10	350 CID (5.7L) Carbureted Chevrolet	1969-1986	52	K20	350 CID (5.7L) Carbureted Chevrolet	1969-1986	52
K10	379 CID (6.2L) Chevrolet Diesel	1982-1986	62	Suburban			
K10	396 CID (6.6L) Chevrolet	1968-1969	64	K20	400 CID (6.6L) Chevrolet	1975-1980	65
K10	400 CID (6.6L) Chevrolet	1975-1980	65	Suburban			
K10	454 CID (7.4L) Chevrolet	1973-1982	70	K20	454 CID (7.4L) Chevrolet	1976-1986	70
K10	230 CID (3.8L) Chevrolet	1963-1969	24	Suburban			
Suburban				K30	292 CID (4.8L) Chevrolet	1977-1986	39
K10	235 CID (3.9L) Chevrolet	1960-1962	27	K30	305 CID (5.0L) Chevrolet	1981-1986	43
Suburban				K30	350 CID (5.7L) Carbureted Chevrolet	1977-1986	52
K10	250 CID (4.1L) Chevrolet	1966-1984	30	K30	379 CID (6.2L) Chevrolet Diesel	1982-1986	62
Suburban				K30	400 CID (6.6L) Chevrolet	1977-1980	65
K10	261 CID (4.3L) Chevrolet	1962	31	K30	454 CID (7.4L) Chevrolet	1977-1986	70
Suburban				K1500	262 CID (4.3L) Vortec 4300 Chevrolet	1996-1999	34
K10	262 CID (4.3L) Chevrolet	1985-1986	32	K1500	262 CID (4.3L) Chevrolet	1988-1995	32
Suburban				K1500	305 CID (5.0L) Chevrolet	1988-1999	43
K10	283 CID (4.6L) Chevrolet	1960-1967	38	K1500	350 CID (5.7L) Fuel Injected Chevrolet	1988-1999	53
Suburban				K1500	379 CID (6.2L) Chevrolet Diesel	1988-1993	62
K10	292 CID (4.8L) Chevrolet	1963-1986	39	K1500	395 CID/6468CC (6.5L) Chevrolet Diesel	1994-1999	63
Suburban				K1500	454 CID (7.4L) Chevrolet	1988-1991	70
K10	305 CID (5.0L) Chevrolet	1977-1986	43	K1500	350 CID (5.7L) Fuel Injected Chevrolet	1992-1999	53
Suburban				Suburban			
K10	307 CID (5.0L) Chevrolet	1968-1972	45	K1500	395 CID/6468CC (6.5L) Chevrolet Diesel	1994-1999	63
Suburban				Suburban			
K10	327 CID (5.4L) Chevrolet	1965-1968	48	K1500	454 CID (7.4L) Chevrolet	1988-1991	70
Suburban				K1500	350 CID (5.7L) Fuel Injected Chevrolet	1992-1999	53
K10	350 CID (5.7L) Carbureted Chevrolet	1967-1986	52	Suburban			
Suburban				K1500	395 CID/6468CC (6.5L) Chevrolet Diesel	1994-1999	63
K10	379 CID (6.2L) Chevrolet Diesel	1982-1986	62	Suburban			
Suburban							

LIGHT TRUCK

General Motors Truck

Model Index (cont.)

Model	Engine	Year	Block	Model	Engine	Year	Block
K1500 Suburban (GMC)	250 CID (4.1L) Chevrolet	1967-1984	30	K2500 Suburban	454 CID (7.4L) Chevrolet	1992-1999	70
K1500 Suburban (GMC)	262 CID (4.3L) Chevrolet	1985-1986	32	K2500 Suburban (GMC)	250 CID (4.1L) Chevrolet	1967-1984	30
K1500 Suburban (GMC)	292 CID (4.8L) Chevrolet	1967-1971	39	K2500 Suburban (GMC)	262 CID (4.3L) Chevrolet	1985-1986	32
K1500 Suburban (GMC)	305 CID (5.0L) Chevrolet	1977-1986	43	K2500 Suburban (GMC)	292 CID (4.8L) Chevrolet	1967-1986	39
K1500 Suburban (GMC)	305 CID (5.0L) General Motors	1967-1969	42	K2500 Suburban (GMC)	305 CID (5.0L) Chevrolet	1977-1986	43
K1500 Suburban (GMC)	307 CID (5.0L) Chevrolet	1970-1972	45	K2500 Suburban (GMC)	305 CID (5.0L) General Motors	1967-1969	42
K1500 Suburban (GMC)	350 CID (5.7L) Fuel Injected Chevrolet	1992-1999	53	K2500 Suburban (GMC)	307 CID (5.0L) Chevrolet	1970-1972	45
K1500 Suburban (GMC)	350 CID (5.7L) Carbureted Chevrolet	1970-1986	52	K2500 Suburban (GMC)	350 CID (5.7L) Fuel Injected Chevrolet	1992-1999	53
K1500 Suburban (GMC)	379 CID (6.2L) Chevrolet Diesel	1983-1986	62	K2500 Suburban (GMC)	350 CID (5.7L) Carbureted Chevrolet	1970-1986	52
K1500 Suburban (GMC)	395 CID/6468CC (6.5L) Chevrolet Diesel	1994-1999	63	K2500 Suburban (GMC)	379 CID (6.2L) Chevrolet Diesel	1983-1986	62
K1500 Suburban (GMC)	396 CID (6.6L) Chevrolet	1968-1970	64	K2500 Suburban (GMC)	395 CID/6468CC (6.5L) Chevrolet Diesel	1992-1999	63
K1500 Suburban (GMC)	400 CID (6.6L) Chevrolet	1975-1979	65	K2500 Suburban (GMC)	396 CID (6.6L) Chevrolet	1968-1970	64
K1500 Suburban (GMC)	454 CID (7.4L) Chevrolet	1975-1980	70	K2500 Suburban (GMC)	400 CID (6.6L) Chevrolet	1975-1980	65
K1500(GMC)	250 CID (4.1L) Chevrolet	1967-1984	30	K2500 Suburban (GMC)	454 CID (7.4L) Chevrolet	1979-1999	70
K1500(GMC)	262 CID (4.3L) Vortec 4300 Chevrolet	1996-1998	34	K2500(GMC)	250 CID (4.1L) Chevrolet	1967-1984	30
K1500(GMC)	262 CID (4.3L) Chevrolet	1985-1995	32	K2500(GMC)	262 CID (4.3L) Chevrolet	1985-1995	32
K1500(GMC)	292 CID (4.8L) Chevrolet	1967-1971	39	K2500(GMC)	292 CID (4.8L) Chevrolet	1967-1986	39
K1500(GMC)	305 CID (5.0L) Chevrolet	1977-1999	43	K2500(GMC)	305 CID (5.0L) Chevrolet	1977-1995	43
K1500(GMC)	305 CID (5.0L) General Motors	1967-1969	42	K2500(GMC)	305 CID (5.0L) General Motors	1967-1969	42
K1500(GMC)	307 CID (5.0L) Chevrolet	1970-1972	45	K2500(GMC)	307 CID (5.0L) Chevrolet	1970-1972	45
K1500(GMC)	350 CID (5.7L) Fuel Injected Chevrolet	1988-1999	53	K2500(GMC)	350 CID (5.7L) Fuel Injected Chevrolet	1988-1999	53
K1500(GMC)	350 CID (5.7L) Carbureted Chevrolet	1970-1986	52	K2500(GMC)	350 CID (5.7L) Carbureted Chevrolet	1970-1986	52
K1500(GMC)	379 CID (6.2L) Chevrolet Diesel	1982-1993	62	K2500(GMC)	379 CID (6.2L) Chevrolet Diesel	1983-1986	62
K1500(GMC)	395 CID/6468CC (6.5L) Chevrolet Diesel	1994-1999	63	K2500(GMC)	395 CID/6468CC (6.5L) Chevrolet Diesel	1992-1999	63
K1500(GMC)	396 CID (6.6L) Chevrolet	1968-1970	64	K2500(GMC)	396 CID (6.6L) Chevrolet	1968-1970	64
K1500(GMC)	400 CID (6.6L) Chevrolet	1975-1979	65	K2500(GMC)	400 CID (6.6L) Chevrolet	1975-1980	65
K1500(GMC)	454 CID (7.4L) Chevrolet	1975-1991	70	K2500(GMC)	454 CID (7.4L) Chevrolet	1979-1999	70
K2500	262 CID (4.3L) Chevrolet	1988-1995	32	K3500	262 CID (4.3L) Chevrolet	1988-1991	32
K2500	305 CID (5.0L) Chevrolet	1988-1995	43	K3500	305 CID (5.0L) Chevrolet	1988-1991	43
K2500	350 CID (5.7L) KL5 Chevrolet	1997-2000	54	K3500	350 CID (5.7L) KL5 Chevrolet	1997-2000	54
K2500	350 CID (5.7L) Fuel Injected Chevrolet	1988-2000	53	K3500	350 CID (5.7L) Fuel Injected Chevrolet	1988-2000	53
K2500	379 CID (6.2L) Chevrolet Diesel	1988-1993	62	K3500	379 CID (6.2L) Chevrolet Diesel	1988-1993	62
K2500	395 CID/6468CC (6.5L) Chevrolet Diesel	1992-2000	63	K3500	395 CID/6468CC (6.5L) Chevrolet Diesel	1992-2000	63
K2500	454 CID (7.4L) Chevrolet	1990-2000	70	K3500	454 CID (7.4L) Chevrolet	1988-2000	70
K2500 Suburban	350 CID (5.7L) Fuel Injected Chevrolet	1992-1999	53	K3500(GMC)	262 CID (4.3L) Chevrolet	1988-1991	32
K2500 Suburban	395 CID/6468CC (6.5L) Chevrolet Diesel	1992-1999	63	K3500(GMC)	292 CID (4.8L) Chevrolet	1977-1986	39
				K3500(GMC)	305 CID (5.0L) Chevrolet	1985-1991	43

LIGHT TRUCK

General Motors Truck

Model Index (cont.)

Model	Engine	Year	Block	Model	Engine	Year	Block
K3500(GMC)	350 CID (5.7L) Fuel Injected Chevrolet	1988-1999	53	P4T042	292 CID (4.8L) Chevrolet	1979-1984	39
K3500(GMC)	350 CID (5.7L) Carbureted Chevrolet	1977-1986	52	P6S042	366 CID (6.0L) Chevrolet	1991-1996	60
K3500(GMC)	379 CID (6.2L) Chevrolet Diesel	1983-1991	62	P6S042	427 CID (7.0L) Chevrolet	1991-1996	68
K3500(GMC)	395 CID/6468CC (6.5L) Chevrolet Diesel	1992-1999	63	P6T042	350 CID (5.7L) Carbureted Chevrolet	1983-1989	52
K3500(GMC)	400 CID (6.6L) Chevrolet	1977-1980	65	P6T042	366 CID (6.0L) Chevrolet	1983-1990	60
K3500(GMC)	454 CID (7.4L) Chevrolet	1979-1999	70	P10	153 CID (2.5L) Chevrolet	1963-1965	13
K4000	351 CID (5.8L) General Motors	1963-1966	56	P10	194 CID (3.2L) Chevrolet	1964-1966	18
K	235 CID (3.9L) Chevrolet	1953-1955	27	P10	230 CID (3.8L) Chevrolet	1963-1969	24
KC	216 CID (3.5L) Chevrolet	1940	21	P10	235 CID (3.9L) Chevrolet	1960-1962	27
KV4000	305 CID (5.0L) General Motors	1964-1966	42	P10	250 CID (4.1L) Chevrolet	1966-1975	30
L50	230 CID (3.8L) Chevrolet	1963-1965	24	P10	292 CID (4.8L) Chevrolet	1963-1982	39
L50	235 CID (3.9L) Chevrolet	1960-1962	27	P10	307 CID (5.0L) Chevrolet	1968-1972	45
L60	366 CID (6.0L) Chevrolet	1966	60	P10	327 CID (5.4L) Chevrolet	1965-1968	48
L70	348 CID (5.7L) Chevrolet	1960-1961	51	P20	230 CID (3.8L) Chevrolet	1963-1969	24
L3500	305 CID (5.0L) General Motors	1965-1966	42	P20	235 CID (3.9L) Chevrolet	1960-1962	27
L4000	305 CID (5.0L) General Motors	1963-1968	42	P20	250 CID (4.1L) Chevrolet	1966-1975	30
L4000	351 CID (5.8L) General Motors	1963-1966	56	P20	292 CID (4.8L) Chevrolet	1973-1989	39
L5000	351 CID (5.8L) General Motors	1963-1965	56	P20	307 CID (5.0L) Chevrolet	1968-1972	45
LA4000	305 CID (5.0L) General Motors	1960-1961	42	P20	327 CID (5.4L) Chevrolet	1965-1968	48
LA5000	351 CID (5.8L) General Motors	1960-1962	56	P20	350 CID (5.7L) Fuel Injected Chevrolet	1987-1989	53
LA5500	401 CID (6.6L) General Motors	1960-1965	66	P20	350 CID (5.7L) Carbureted Chevrolet	1969-1989	52
LA6000	401 CID (6.6L) General Motors	1960-1965	66	P20	379 CID (6.2L) Chevrolet Diesel	1982-1989	62
LA6500	478 CID (7.8L) General Motors	1964-1965	71	P20	454 CID (7.4L) Chevrolet	1970-1989	70
LH4000	305 CID (5.0L) General Motors	1963-1967	42	P30	230 CID (3.8L) Chevrolet	1963-1969	24
LH4000	351 CID (5.8L) General Motors	1963-1965	56	P30	235 CID (3.9L) Chevrolet	1960-1962	27
LH5000	401 CID (6.6L) General Motors	1963-1965	66	P30	250 CID (4.1L) Chevrolet	1966-1975	30
LLV Postal Vehicle	134 CID (2.2L) OHV Chevrolet	1994-1995	6	P30	262 CID (4.3L) Vortec 4300 Chevrolet	1996-1999	34
LLV Postal Vehicle	151 CID (2.5L) Fuel Injected Pontiac	1987-1993	12	P30	262 CID (4.3L) Chevrolet	1985-1995	32
LS50	250 CID (4.1L) Chevrolet	1966	30	P30	292 CID (4.8L) Chevrolet	1963-1989	39
LV4000	305 CID (5.0L) General Motors	1960-1961	42	P30	307 CID (5.0L) Chevrolet	1968-1972	45
LV5000	351 CID (5.8L) General Motors	1960-1962	56	P30	327 CID (5.4L) Chevrolet	1965-1968	48
LV5500	401 CID (6.6L) General Motors	1960-1965	66	P30	350 CID (5.7L) Fuel Injected Chevrolet	1987-1999	53
LVI4000	292 CID (4.8L) Chevrolet	1966-1968	39	P30	350 CID (5.7L) Carbureted Chevrolet	1969-1989	52
LVI4000	292 CID (4.8L) Chevrolet	1966-1969	39	P30	379 CID (6.2L) Chevrolet Diesel	1982-1993	62
LWA5000	351 CID (5.8L) General Motors	1960-1962	56	P30	395 CID/6468CC (6.5L) Chevrolet Diesel	1994-1999	63
LWA5500	401 CID (6.6L) General Motors	1960-1965	66	P30	454 CID (7.4L) Chevrolet	1970-1999	70
LWB5000	351 CID (5.8L) General Motors	1960-1962	56	P50	230 CID (3.8L) Chevrolet	1965	24
Lo Pro	366 CID (6.0L) Chevrolet	1992-1996	60	P350	270 CID (4.4L) OHV General Motors	1956-1959	37
Lumina APV	189 CID (3.1L) Chevrolet	1990-1995	17	P1000	153 CID (2.5L) Chevrolet	1963-1965	13
Lumina APV	207 CID (3.4L) LA1 Chevrolet	1996	20	P1000	230 CID (3.8L) Chevrolet	1966	24
Lumina APV	231 CID (3.8L) Fuel Injected Buick	1992-1995	26	P1000	270 CID (4.4L) OHV General Motors	1960-1962	37
Luv	1817CC (1.8L) SOHC Isuzu	1971-1982	3	P1500(GMC)	230 CID (3.8L) Chevrolet	1963-1970	24
Luv	2238CC (2.2L) OHV Isuzu Diesel	1981-1982	8	P1500(GMC)	250 CID (4.1L) Chevrolet	1966-1974	30
M60	366 CID (6.0L) Chevrolet	1966	60	P1500(GMC)	292 CID (4.8L) Chevrolet	1963-1982	39
M70	348 CID (5.7L) Chevrolet	1960-1961	51	P1500(GMC)	307 CID (5.0L) Chevrolet	1970	45
M	235 CID (3.9L) Chevrolet	1953-1955	27	P2500(GMC)	159 CID (2.6L) 3-53 Detroit Diesel Diesel	1967-1968	14
ME50	327 CID (5.4L) Chevrolet	1967-1968	48	P2500(GMC)	230 CID (3.8L) Chevrolet	1963-1970	24
ME50	350 CID (5.7L) Carbureted Chevrolet	1969-1970	52	P2500(GMC)	250 CID (4.1L) Chevrolet	1966-1972	30
ME50	366 CID (6.0L) Chevrolet	1967-1970	60	P2500(GMC)	292 CID (4.8L) Chevrolet	1963-1989	39
ME60	366 CID (6.0L) Chevrolet	1967-1972	60	P2500(GMC)	307 CID (5.0L) Chevrolet	1970-1971	45
ME60	427 CID (7.0L) Chevrolet	1968-1972	68	P2500(GMC)	350 CID (5.7L) Fuel Injected Chevrolet	1987-1989	53
ME65	366 CID (6.0L) Chevrolet	1973-1978	60	P2500(GMC)	350 CID (5.7L) Carbureted Chevrolet	1972-1988	52
ME65	427 CID (7.0L) Chevrolet	1973-1978	68	P2500(GMC)	379 CID (6.2L) Chevrolet Diesel	1983-1989	62
ME6500	366 CID (6.0L) Chevrolet	1969-1978	60	P2500(GMC)	454 CID (7.4L) Chevrolet	1984-1986	70
ME6500	427 CID (7.0L) Chevrolet	1969-1978	68	P3500(GMC)	159 CID (2.6L) 3-53 Detroit Diesel Diesel	1967-1968	14
MG60	478 CID (7.8L) General Motors Diesel	1967-1969	72				
MM65	432 CID (7.1L) General Motors	1974	69				
MM6500	432 CID (7.1L) General Motors	1974	69				
Montana	207 CID (3.4L) LA1 Chevrolet	1999-2004	20				
N60	478 CID (7.8L) General Motors Diesel	1965-1966	72				

General Motors Truck

Model Index (cont.)

Model	Engine	Year	Block	Model	Engine	Year	Block
P3500(GMC)	250 CID (4.1L) Chevrolet	1967-1972	30	R30	292 CID (4.8L) Chevrolet	1987-1988	39
P3500(GMC)	262 CID (4.3L) Vortec 4300 Chevrolet	1996-1999	34	R30	305 CID (5.0L) Chevrolet	1987-1988	43
P3500(GMC)	262 CID (4.3L) Chevrolet	1990-1995	32	R30	350 CID (5.7L) Fuel Injected Chevrolet	1987-1988	53
P3500(GMC)	292 CID (4.8L) Chevrolet	1966-1989	39	R30	350 CID (5.7L) Carbureted Chevrolet	1987-1988	52
P3500(GMC)	307 CID (5.0L) Chevrolet	1970-1971	45	R30	379 CID (6.2L) Chevrolet Diesel	1987-1988	62
P3500(GMC)	350 CID (5.7L) Fuel Injected Chevrolet	1987-1999	53	R30	454 CID (7.4L) Chevrolet	1987-1988	70
P3500(GMC)	350 CID (5.7L) Carbureted Chevrolet	1972-1988	52	R1500	350 CID (5.7L) Fuel Injected Chevrolet	1989-1991	53
P3500(GMC)	379 CID (6.2L) Chevrolet Diesel	1983-1993	62	Suburban	379 CID (6.2L) Chevrolet Diesel	1989-1991	62
P3500(GMC)	395 CID/6468CC (6.5L) Chevrolet Diesel	1994-1999	63	Suburban	454 CID (7.4L) Chevrolet	1989-1991	70
P3500(GMC)	454 CID (7.4L) Chevrolet	1974-1999	70	Suburban	262 CID (4.3L) Chevrolet	1987	32
PB1500	292 CID (4.8L) Chevrolet	1963-1966	39	R1500	305 CID (5.0L) Chevrolet	1987	43
PB2500	292 CID (4.8L) Chevrolet	1963-1966	39	Suburban (GMC)	350 CID (5.7L) Fuel Injected Chevrolet	1987-1991	53
PE30 MHC	454 CID (7.4L) Chevrolet	1966-1982	70	R1500	379 CID (6.2L) Chevrolet Diesel	1987-1991	62
PE3500	454 CID (7.4L) Chevrolet	1975-1982	70	Suburban (GMC)	454 CID (7.4L) Chevrolet	1990	70
PM150	228 CID (3.7L) General Motors	1951-1953	22	R1500(GMC)	262 CID (4.3L) Chevrolet	1987	32
PM150	248 CID (4.1L) General Motors	1954-1955	29	R1500(GMC)	305 CID (5.0L) Chevrolet	1987	43
PM150	270 CID (4.4L) OHV General Motors	1956-1959	37	R1500(GMC)	350 CID (5.7L) Fuel Injected Chevrolet	1987	53
PM150	336 CID (5.5L) General Motors	1958-1959	50	R1500(GMC)	379 CID (6.2L) Chevrolet Diesel	1987	62
PM250	228 CID (3.7L) General Motors	1951-1953	22	R2500	292 CID (4.8L) Chevrolet	1989	39
PM250	248 CID (4.1L) General Motors	1954-1955	29	R2500	350 CID (5.7L) Fuel Injected Chevrolet	1989	53
PM250	270 CID (4.4L) OHV General Motors	1956-1959	37	R2500	350 CID (5.7L) Carbureted Chevrolet	1989	52
PM250	336 CID (5.5L) General Motors	1958-1959	50	R2500	379 CID (6.2L) Chevrolet Diesel	1989	62
PS40	250 CID (4.1L) Chevrolet	1967-1970	30	R2500	454 CID (7.4L) Chevrolet	1989	70
PS50	250 CID (4.1L) Chevrolet	1966	30	R2500	292 CID (4.8L) Chevrolet	1989	39
PS4500	292 CID (4.8L) Chevrolet	1967-1978	39	Suburban	350 CID (5.7L) Fuel Injected Chevrolet	1989-1991	53
Q60	478 CID (7.8L) General Motors Diesel	1965-1966	72	Suburban	350 CID (5.7L) Carbureted Chevrolet	1989	52
R10	262 CID (4.3L) Chevrolet	1987	32	R2500	379 CID (6.2L) Chevrolet Diesel	1989	62
R10	305 CID (5.0L) Chevrolet	1987	43	R2500	454 CID (7.4L) Chevrolet	1989	70
R10	350 CID (5.7L) Fuel Injected Chevrolet	1987	53	R2500	292 CID (4.8L) Chevrolet	1989	39
R10	379 CID (6.2L) Chevrolet Diesel	1987	62	Suburban	350 CID (5.7L) Fuel Injected Chevrolet	1989-1991	53
R10	262 CID (4.3L) Chevrolet	1987-1988	32	Suburban	350 CID (5.7L) Carbureted Chevrolet	1989	52
Suburban	305 CID (5.0L) Chevrolet	1987-1988	43	R2500	379 CID (6.2L) Chevrolet Diesel	1989-1991	62
Suburban	350 CID (5.7L) Fuel Injected Chevrolet	1987-1988	53	R2500	454 CID (7.4L) Chevrolet	1989	70
R10	379 CID (6.2L) Chevrolet Diesel	1987-1988	62	R2500	292 CID (4.8L) Chevrolet	1989	39
Suburban	262 CID (4.3L) Chevrolet	1987-1988	32	Suburban	350 CID (5.7L) Fuel Injected Chevrolet	1989-1991	53
R20	262 CID (4.3L) Chevrolet	1987-1988	32	Suburban	350 CID (5.7L) Carbureted Chevrolet	1989	52
R20	292 CID (4.8L) Chevrolet	1987-1988	39	R2500	379 CID (6.2L) Chevrolet Diesel	1989-1991	62
R20	305 CID (5.0L) Chevrolet	1987-1988	43	R2500	454 CID (7.4L) Chevrolet	1989-1991	70
R20	350 CID (5.7L) Fuel Injected Chevrolet	1987-1988	53	Suburban	262 CID (4.3L) Chevrolet	1987	32
R20	350 CID (5.7L) Carbureted Chevrolet	1987-1988	52	Suburban (GMC)	292 CID (4.8L) Chevrolet	1987-1989	39
R20	379 CID (6.2L) Chevrolet Diesel	1987-1988	62	Suburban (GMC)	305 CID (5.0L) Chevrolet	1987	43
R20	454 CID (7.4L) Chevrolet	1987-1988	70	R2500	350 CID (5.7L) Fuel Injected Chevrolet	1987-1991	53
R20	262 CID (4.3L) Chevrolet	1987-1988	32	Suburban (GMC)	350 CID (5.7L) Carbureted Chevrolet	1987-1989	52
Suburban	292 CID (4.8L) Chevrolet	1987-1988	39	R2500	379 CID (6.2L) Chevrolet Diesel	1987-1991	62
Suburban	305 CID (5.0L) Chevrolet	1987-1988	43	Suburban (GMC)	454 CID (7.4L) Chevrolet	1987-1988	70
R20	350 CID (5.7L) Fuel Injected Chevrolet	1987-1988	53	Suburban	262 CID (4.3L) Chevrolet	1987	32
Suburban	350 CID (5.7L) Carbureted Chevrolet	1987-1988	52	R2500	292 CID (4.8L) Chevrolet	1987-1989	39
Suburban	379 CID (6.2L) Chevrolet Diesel	1987-1988	62	Suburban (GMC)	305 CID (5.0L) Chevrolet	1987	43
Suburban	454 CID (7.4L) Chevrolet	1987-1988	70	R2500	350 CID (5.7L) Fuel Injected Chevrolet	1987-1991	53
				Suburban (GMC)	350 CID (5.7L) Carbureted Chevrolet	1987-1989	52
				R2500	379 CID (6.2L) Chevrolet Diesel	1987-1991	62
				Suburban (GMC)	454 CID (7.4L) Chevrolet	1987-1988	70

LIGHT TRUCK

General Motors Truck

Model Index (cont.)

Model	Engine	Year	Block	Model	Engine	Year	Block
R2500	454 CID (7.4L) Chevrolet	1987-1991	70	S5000	351 CID (5.8L) General Motors	1963-1965	56
Suburban (GMC)				S6200	327 CID (5.4L) Chevrolet	1962-1966	48
R2500(GMC)	262 CID (4.3L) Chevrolet	1987	32	S	235 CID (3.9L) Chevrolet	1953-1955	27
R2500(GMC)	292 CID (4.8L) Chevrolet	1987-1989	39	SA4000	305 CID (5.0L) General Motors	1960-1961	42
R2500(GMC)	305 CID (5.0L) Chevrolet	1987	43	SA4000	351 CID (5.8L) General Motors	1960-1962	56
R2500(GMC)	350 CID (5.7L) Fuel Injected Chevrolet	1987-1989	53	SA5000	351 CID (5.8L) General Motors	1960-1962	56
R2500(GMC)	350 CID (5.7L) Carbureted Chevrolet	1987-1989	52	SE50	350 CID (5.7L) Carbureted Chevrolet	1969-1971	52
R2500(GMC)	379 CID (6.2L) Chevrolet Diesel	1987-1989	62	SE50	366 CID (6.0L) Chevrolet	1967-1970	60
R2500(GMC)	454 CID (7.4L) Chevrolet	1987-1989	70	SE60	350 CID (5.7L) Carbureted Chevrolet	1973-1978	52
R3500	292 CID (4.8L) Chevrolet	1989	39	SE60	366 CID (6.0L) Chevrolet	1967-1978	60
R3500	350 CID (5.7L) Fuel Injected Chevrolet	1989-1991	53	SE5000	327 CID (5.4L) Chevrolet	1967-1968	48
R3500	379 CID (6.2L) Chevrolet Diesel	1989-1991	62	SE5500	366 CID (6.0L) Chevrolet	1970-1972	60
R3500	454 CID (7.4L) Chevrolet	1989-1991	70	SE6000	327 CID (5.4L) Chevrolet	1967-1968	48
R3500(GMC)	292 CID (4.8L) Chevrolet	1987-1989	39	SE6000	366 CID (6.0L) Chevrolet	1973-1978	60
R3500(GMC)	305 CID (5.0L) Chevrolet	1987	43	SG50	478 CID (7.8L) General Motors Diesel	1972	72
R3500(GMC)	350 CID (5.7L) Fuel Injected Chevrolet	1987-1991	53	SG60	478 CID (7.8L) General Motors Diesel	1973-1974	72
R3500(GMC)	350 CID (5.7L) Carbureted Chevrolet	1987-1988	52	SG5500	478 CID (7.8L) General Motors Diesel	1967-1972	72
R3500(GMC)	379 CID (6.2L) Chevrolet Diesel	1987-1991	62	SG6000	478 CID (7.8L) General Motors Diesel	1973-1974	72
R3500(GMC)	454 CID (7.4L) Chevrolet	1987-1991	70	SI4000	292 CID (4.8L) Chevrolet	1966	39
RM7500	351 CID (5.8L) General Motors	1966-1972	56	SM5500	305 CID (5.0L) General Motors	1967-1972	42
RM7500	401 CID (6.6L) General Motors	1966-1972	66	SM5500	351 CID (5.8L) General Motors	1967-1972	56
Rendezvous	207 CID (3.4L) LA1 Chevrolet	2002-2004	20	SM6000	305 CID (5.0L) General Motors	1973-1974	42
S10	119 CID (1.9L) LR1 SOHC Isuzu	1982-1985	4	SM6000	379 CID (6.2L) General Motors	1973-1974	61
S10	121 CID (2.0L) LQ2 Chevrolet	1983-1984	5	SM6500	351 CID (5.8L) General Motors	1967-1969	56
S10	134 CID (2.2L) OHV Chevrolet	1994-2002	6	SM6500	401 CID (6.6L) General Motors	1967-1969	66
S10	137 CID (2.2L) LQ7 OHV Isuzu Diesel	1984-1985	7	SP5000	351 CID (5.8L) General Motors	1963-1965	56
S10	151 CID (2.5L) Fuel Injected Pontiac	1985-1993	12	SP5000	478 CID (7.8L) General Motors	1964-1965	71
S10	173 CID (2.8L) Chevrolet	1982-1993	16	SPA5000	351 CID (5.8L) General Motors	1960-1962	56
S10	262 CID (4.3L) Vortec 4300 Chevrolet	1992-2004	34	SPA5000	401 CID (6.6L) General Motors	1960-1965	66
S10	262 CID (4.3L) Chevrolet	1988-1995	32	SPV5000	351 CID (5.8L) General Motors	1960-1962	56
S15	119 CID (1.9L) LR1 SOHC Isuzu	1982-1985	4	SPV5000	401 CID (6.6L) General Motors	1960-1965	66
S15	121 CID (2.0L) LQ2 Chevrolet	1983-1984	5	SS40	250 CID (4.1L) Chevrolet	1968-1971	30
S15	137 CID (2.2L) LQ7 OHV Isuzu Diesel	1984-1985	7	SS50	250 CID (4.1L) Chevrolet	1966-1967	30
S15	151 CID (2.5L) Fuel Injected Pontiac	1985-1990	12	SS5500	292 CID (4.8L) Chevrolet	1970-1972	39
S15	173 CID (2.8L) Chevrolet	1982-1990	16	SS6000	292 CID (4.8L) Chevrolet	1973-1976	39
S15	262 CID (4.3L) Vortec 4300 Chevrolet	1992-1995	34	SV4000	305 CID (5.0L) General Motors	1960-1961	42
S15	262 CID (4.3L) Chevrolet	1988-1995	32	SV4000	351 CID (5.8L) General Motors	1960-1962	56
S50	230 CID (3.8L) Chevrolet	1963-1965	24	SV5000	351 CID (5.8L) General Motors	1960-1962	56
S50	235 CID (3.9L) Chevrolet	1960-1962	27	Safari	151 CID (2.5L) Fuel Injected Pontiac	1985-1990	12
S60	366 CID (6.0L) Chevrolet	1966	60	Safari	262 CID (4.3L) Vortec 4300 Chevrolet	1992-2004	34
S70	348 CID (5.7L) Chevrolet	1960-1961	51	Safari	262 CID (4.3L) Chevrolet	1985-1994	32
S300	270 CID (4.4L) OHV General Motors	1956-1959	37	Safari EXT	262 CID (4.3L) Vortec 4300 Chevrolet	1992-1994	34
S300-24	248 CID (4.1L) General Motors	1954-1955	29	Safari EXT	262 CID (4.3L) Chevrolet	1990-1994	32
S370	270 CID (4.4L) OHV General Motors	1957-1959	37	Savana 1500	262 CID (4.3L) Vortec 4300 Chevrolet	1996-2004	34
S400-24	248 CID (4.1L) General Motors	1954-1955	29	Savana 1500	305 CID (5.0L) Chevrolet	1996-2002	43
S400-27	270 CID (4.4L) OHV General Motors	1951-1955	37	Savana 1500	325 CID (5.3L) Vortec 5300 Chevrolet	2003-2004	46
S450	302 CID (5.0L) OHV General Motors	1955-1959	41	Savana 1500	350 CID (5.7L) Fuel Injected Chevrolet	1996-2002	53
S450-30	302 CID (5.0L) OHV General Motors	1952-1954	41	Savana 2500	262 CID (4.3L) Vortec 4300 Chevrolet	1996-2004	34
S4000	305 CID (5.0L) General Motors	1963-1966	42	Savana 2500	294 CID (4.8L) Vortec 4800 LR4 Chevrolet	2003-2004	40
S4000	351 CID (5.8L) General Motors	1963-1966	56	Savana 2500	305 CID (5.0L) Chevrolet	1996-2002	43
				Savana 2500	325 CID (5.3L) Vortec 5300 Chevrolet	2003-2004	46
				Savana 2500	350 CID (5.7L) Fuel Injected Chevrolet	1996-2002	53
				Savana 2500	365 CID (6.0L) Vortec 6000 LQ4 (KL8) Chevrolet	2003-2004	59

General Motors Truck

Model Index (cont.)

Model	Engine	Year	Block	Model	Engine	Year	Block
Savana 2500	365 CID (6.0L) Vortec 6000 LQ4 (KL6) Chevrolet	2003-2004	58	Sierra 2500HD	365 CID (6.0L) Vortec 6000 Chevrolet	2001-2003	57
Savana 2500	365 CID (6.0L) Vortec 6000 Chevrolet	2003-2004	57	Sierra 2500HD	496 CID/8135CC (8.1L) Vortec 8100 L18 OHV Chevrolet	2001-2003	73
Savana 2500	395 CID/6468CC (6.5L) Chevrolet Diesel	1996-2002	63	Sierra 3500	365 CID (6.0L) Vortec 6000 Chevrolet	2001-2003	57
Savana 2500 EXT	262 CID (4.3L) Vortec 4300 Chevrolet	1996-2004	34	Sierra 3500	496 CID/8135CC (8.1L) Vortec 8100 L18 OHV Chevrolet	2001-2003	73
Savana 2500 EXT	294 CID (4.8L) Vortec 4800 LR4 Chevrolet	2003-2004	40	Sierra Denali	365 CID (6.0L) Vortec 6000 Chevrolet	2002-2003	57
Savana 2500 EXT	305 CID (5.0L) Chevrolet	1996-2002	43	Silhouette	138 CID (2.3L) DOHC Oldsmobile	1993-1996	9
Savana 2500 EXT	325 CID (5.3L) Vortec 5300 Chevrolet	2003-2004	46	Silhouette	189 CID (3.1L) Chevrolet	1990-1994	17
Savana 2500 EXT	350 CID (5.7L) Fuel Injected Chevrolet	1996-2002	53	Silhouette	207 CID (3.4L) LA1 Chevrolet	1996-2004	20
Savana 2500 EXT	365 CID (6.0L) Vortec 6000 LQ4 (KL8) Chevrolet	2003-2004	59	Silhouette	231 CID (3.8L) Fuel Injected Buick	1992-1995	26
Savana 2500 EXT	365 CID (6.0L) Vortec 6000 LQ4 (KL6) Chevrolet	2003-2004	58	Silverado 1500	262 CID (4.3L) Vortec 4300 Chevrolet	1999-2003	34
Savana 2500 EXT	365 CID (6.0L) Vortec 6000 Chevrolet	2003-2004	57	Silverado 1500	294 CID (4.8L) Vortec 4800 LR4 Chevrolet	1999-2003	40
Savana 2500 EXT	395 CID/6468CC (6.5L) Chevrolet Diesel	1996-2001	63	Silverado 1500	325 CID (5.3L) Vortec 5300 L59 Chevrolet	2003	47
Savana 3500	262 CID (4.3L) Vortec 4300 Chevrolet	1997-1998	34	Silverado 1500	325 CID (5.3L) Vortec 5300 Chevrolet	1999-2003	46
Savana 3500	350 CID (5.7L) Fuel Injected Chevrolet	1996-2002	53	Silverado 1500	365 CID (6.0L) Vortec 6000 Chevrolet	2003	57
Savana 3500	365 CID (6.0L) Vortec 6000 LQ4 (KL8) Chevrolet	2003-2004	59	Silverado 1500HD	365 CID (6.0L) Vortec 6000 Chevrolet	2001-2003	57
Savana 3500	365 CID (6.0L) Vortec 6000 LQ4 (KL6) Chevrolet	2003-2004	58	Silverado 2500	325 CID (5.3L) Vortec 5300 Chevrolet	1999-2001	46
Savana 3500	365 CID (6.0L) Vortec 6000 Chevrolet	2003-2004	57	Silverado 2500	365 CID (6.0L) Vortec 6000 LQ4 (KL6) Chevrolet	2002-2003	58
Savana 3500	395 CID/6468CC (6.5L) Chevrolet Diesel	1996-2002	63	Silverado 2500	365 CID (6.0L) Vortec 6000 Chevrolet	1999-2003	57
Savana 3500	454 CID (7.4L) Chevrolet	1996-2000	70	Silverado 2500HD	365 CID (6.0L) Vortec 6000 LQ4 (KL6) Chevrolet	2003	58
Savana 3500	496 CID/8135CC (8.1L) Vortec 8100 L18 OHV Chevrolet	2001-2002	73	Silverado 2500HD	365 CID (6.0L) Vortec 6000 Chevrolet	2001-2003	57
Savana 3500 EXT	350 CID (5.7L) Fuel Injected Chevrolet	1996-2002	53	Silverado 2500HD	496 CID/8135CC (8.1L) Vortec 8100 L18 OHV Chevrolet	2001-2003	73
Savana 3500 EXT	365 CID (6.0L) Vortec 6000 LQ4 (KL8) Chevrolet	2003-2004	59	Silverado 3500	365 CID (6.0L) Vortec 6000 Chevrolet	2001-2003	57
Savana 3500 EXT	365 CID (6.0L) Vortec 6000 LQ4 (KL6) Chevrolet	2003-2004	58	Silverado 3500	496 CID/8135CC (8.1L) Vortec 8100 L18 OHV Chevrolet	2001-2003	73
Savana 3500 EXT	365 CID (6.0L) Vortec 6000 Chevrolet	2003-2004	57	Sonoma	134 CID (2.2L) OHV Chevrolet	1994-2004	6
Savana 3500 EXT	395 CID/6468CC (6.5L) Chevrolet Diesel	1996-2002	63	Sonoma	151 CID (2.5L) Fuel Injected Pontiac	1991-1993	12
Savana 3500 EXT	454 CID (7.4L) Chevrolet	1996-2000	70	Sonoma	173 CID (2.8L) Chevrolet	1991-1993	16
Savana 3500 EXT	496 CID/8135CC (8.1L) Vortec 8100 L18 OHV Chevrolet	2001-2002	73	Sonoma	262 CID (4.3L) Vortec 4300 Chevrolet	1992-2002	34
Sierra 1500	262 CID (4.3L) Vortec 4300 Chevrolet	1999-2003	34	Sonoma	262 CID (4.3L) Chevrolet	1991-1995	32
Sierra 1500	294 CID (4.8L) Vortec 4800 LR4 Chevrolet	1999-2003	40	Sprint	250 CID (4.1L) Chevrolet	1971-1977	30
Sierra 1500	325 CID (5.3L) Vortec 5300 L59 Chevrolet	2003	47	Sprint	305 CID (5.0L) Chevrolet	1976	43
Sierra 1500	325 CID (5.3L) Vortec 5300 Chevrolet	1999-2003	46	Sprint	307 CID (5.0L) Chevrolet	1971-1973	45
Sierra 1500	365 CID (6.0L) Vortec 6000 Chevrolet	2002	57	Sprint	350 CID (5.7L) Carbureted Chevrolet	1971-1977	52
Sierra 1500HD	365 CID (6.0L) Vortec 6000 Chevrolet	2002-2003	57	Sprint	400 CID (6.6L) Chevrolet	1974-1976	65
Sierra 2500	325 CID (5.3L) Vortec 5300 Chevrolet	1999-2000	46	Sprint	402 CID (6.6L) Chevrolet	1971-1972	67
Sierra 2500	365 CID (6.0L) Vortec 6000 LQ4 (KL6) Chevrolet	2002-2003	58	Sprint	454 CID (7.4L) Chevrolet	1971-1975	70
Sierra 2500	365 CID (6.0L) Vortec 6000 Chevrolet	1999-2003	57	Suburban 1500	294 CID (4.8L) Vortec 4800 LR4 Chevrolet	2000-2001	40
Sierra 2500HD	365 CID (6.0L) Vortec 6000 LQ4 (KL6) Chevrolet	2002-2003	58	Suburban 1500	325 CID (5.3L) Vortec 5300 Chevrolet	2000-2004	46
				Suburban 1500	365 CID (6.0L) Vortec 6000 Chevrolet	2000-2004	57
				Suburban 2500	496 CID/8135CC (8.1L) Vortec 8100 L18 OHV Chevrolet	2001-2004	73
				Sunrunner	97 CID (1.6L) LO1 16 Valve Suzuki	1995-1997	1
				Syclone	262 CID (4.3L) LB4 (ZR9/Z79) Turbo Chevrolet	1991-1993	33
				T50	230 CID (3.8L) Chevrolet	1965	24

LIGHT TRUCK

General Motors Truck

Model Index (cont.)

Model	Engine	Year	Block	Model	Engine	Year	Block
T60	366 CID (6.0L) Chevrolet	1966	60	V10	379 CID (6.2L) Chevrolet Diesel	1987	62
T70	348 CID (5.7L) Chevrolet	1960	51	V10	262 CID (4.3L) Chevrolet	1987-1988	32
T5500	366 CID (6.0L) Chevrolet	1997-1998	60	Suburban			
T6500	366 CID (6.0L) Chevrolet	1997-1998	60	V10	305 CID (5.0L) Chevrolet	1987-1988	43
T	235 CID (3.9L) Chevrolet	1953-1955	27	Suburban			
TE50	327 CID (5.4L) Chevrolet	1967-1968	48	V10	350 CID (5.7L) Fuel Injected Chevrolet	1987-1988	53
TE50	350 CID (5.7L) Carbureted Chevrolet	1969-1972	52	Suburban			
TE50	366 CID (6.0L) Chevrolet	1967-1972	60	V10	379 CID (6.2L) Chevrolet Diesel	1987-1988	62
TE60	350 CID (5.7L) Carbureted Chevrolet	1973-1978	52	Suburban			
TE60	366 CID (6.0L) Chevrolet	1967-1978	60	V20	262 CID (4.3L) Chevrolet	1987	32
TE60	427 CID (7.0L) Chevrolet	1968-1972	68	V20	292 CID (4.8L) Chevrolet	1987	39
TE65	366 CID (6.0L) Chevrolet	1973-1978	60	V20	305 CID (5.0L) Chevrolet	1987	43
TE65	427 CID (7.0L) Chevrolet	1973-1978	68	V20	350 CID (5.7L) Fuel Injected Chevrolet	1987	53
TE5500	366 CID (6.0L) Chevrolet	1970-1972	60	V20	350 CID (5.7L) Carbureted Chevrolet	1987	52
TE6000	366 CID (6.0L) Chevrolet	1973-1978	60	V20	379 CID (6.2L) Chevrolet Diesel	1987	62
TE6500	366 CID (6.0L) Chevrolet	1970-1978	60	V20	454 CID (7.4L) Chevrolet	1987	70
TE6500	427 CID (7.0L) Chevrolet	1970-1978	68	V20	262 CID (4.3L) Chevrolet	1987-1988	32
TG50	478 CID (7.8L) General Motors Diesel	1967-1969	72	Suburban			
TG60	478 CID (7.8L) General Motors Diesel	1967-1969	72	V20	292 CID (4.8L) Chevrolet	1987-1988	39
TG5500	478 CID (7.8L) General Motors Diesel	1970-1972	72	Suburban			
TG6000	478 CID (7.8L) General Motors Diesel	1973-1974	72	V20	305 CID (5.0L) Chevrolet	1987-1988	43
TG31303	292 CID (4.8L) Chevrolet	1976-1978	39	Suburban			
TG31603	292 CID (4.8L) Chevrolet	1976-1978	39	V20	350 CID (5.7L) Carbureted Chevrolet	1987-1988	52
TM65	432 CID (7.1L) General Motors	1973-1974	69	Suburban			
TM5500	305 CID (5.0L) General Motors	1970-1972	42	V20	379 CID (6.2L) Chevrolet Diesel	1987-1988	62
TM5500	351 CID (5.8L) General Motors	1970-1972	56	Suburban			
TM6000	305 CID (5.0L) General Motors	1973-1974	42	V20	454 CID (7.4L) Chevrolet	1987-1988	70
TM6000	379 CID (6.2L) General Motors	1973-1974	61	Suburban			
TM6500	351 CID (5.8L) General Motors	1970-1972	56	V30	292 CID (4.8L) Chevrolet	1987-1988	39
TM6500	379 CID (6.2L) General Motors	1973-1974	61	V30	305 CID (5.0L) Chevrolet	1987-1988	43
TM6500	432 CID (7.1L) General Motors	1973-1974	69	V30	350 CID (5.7L) Fuel Injected Chevrolet	1987-1988	53
TM7500	351 CID (5.8L) General Motors	1966-1970	56	V30	350 CID (5.7L) Carbureted Chevrolet	1987-1988	52
TM7500	401 CID (6.6L) General Motors	1966-1972	66	V30	379 CID (6.2L) Chevrolet Diesel	1987-1988	62
TM8500	351 CID (5.8L) General Motors	1966-1969	56	V30	454 CID (7.4L) Chevrolet	1987-1988	70
TM8500	401 CID (6.6L) General Motors	1966-1969	66	V60	478 CID (7.8L) General Motors Diesel	1965-1966	72
TS40	250 CID (4.1L) Chevrolet	1967-1968	30	V1500	350 CID (5.7L) Fuel Injected Chevrolet	1989-1991	53
TS50	250 CID (4.1L) Chevrolet	1966	30	Suburban			
TS5000	292 CID (4.8L) Chevrolet	1970-1971	39	V1500	379 CID (6.2L) Chevrolet Diesel	1989-1991	62
Tahoe	294 CID (4.8L) Vortec 4800	2000-2004	40	Suburban			
Tahoe	LR4 Chevrolet			V1500	262 CID (4.3L) Chevrolet	1987	32
Tahoe	325 CID (5.3L) Vortec 5300	2002-2004	47	Suburban			
Tahoe	L59 Chevrolet			V1500	305 CID (5.0L) Chevrolet	1987	43
Tahoe	325 CID (5.3L) Vortec 5300	2000-2004	46	Suburban			
Tahoe	350 CID (5.7L) Fuel Injected Chevrolet	1995-2000	53	V1500	350 CID (5.7L) Fuel Injected Chevrolet	1987-1991	53
Tahoe	395 CID/6468CC (6.5L) Chevrolet Diesel	1995-1999	63	Suburban			
Tracker	97 CID (1.6L) LO1 16 Valve Suzuki	1994-1998	1	V1500	379 CID (6.2L) Chevrolet Diesel	1987-1991	62
Tracker	97 CID (1.6L) LS5 8 Valve Suzuki	1989-1995	2	Suburban			
Trail Blazer EXT	325 CID (5.3L) Vortec 5300 Chevrolet	2003-2004	46	V1500	262 CID (4.3L) Chevrolet	1987	32
Transport	189 CID (3.1L) Chevrolet	1990-1995	17	V1500	305 CID (5.0L) Chevrolet	1987	43
Transport	207 CID (3.4L) LA1 Chevrolet	1996-2000	20	V1500	350 CID (5.7L) Fuel Injected Chevrolet	1987	53
Transport	231 CID (3.8L) Fuel Injected Buick	1992-1995	26	V1500	379 CID (6.2L) Chevrolet Diesel	1987	62
Typhoon	262 CID (4.3L) LB4 (ZR9/Z79) Turbo Chevrolet	1992-1993	33	V1500	262 CID (4.3L) Chevrolet	1987	32
U	235 CID (3.9L) Chevrolet	1953-1955	27	V1500	305 CID (5.0L) Chevrolet	1987	43
V10	262 CID (4.3L) Chevrolet	1987	32	V1500	350 CID (5.7L) Fuel Injected Chevrolet	1987	53
V10	305 CID (5.0L) Chevrolet	1987	43	Suburban			
V10	350 CID (5.7L) Fuel Injected Chevrolet	1987	53	V2500	379 CID (6.2L) Chevrolet Diesel	1989-1991	53
				Suburban			
				V2500	350 CID (5.7L) Fuel Injected Chevrolet	1989-1991	53
				Suburban			
				V2500	379 CID (6.2L) Chevrolet Diesel	1989-1991	62
				Suburban			

LIGHT TRUCK

General Motors Truck

Model Index (cont.)

Model	Engine	Year	Block	Model	Engine	Year	Block
V2500 Suburban (GMC)	262 CID (4.3L) Chevrolet	1987	32	Vega	140 CID (2.3L) Chevrolet	1971-1975	10
V2500 Suburban (GMC)	292 CID (4.8L) Chevrolet	1987-1988	39	Venture W4	207 CID (3.4L) LA1 Chevrolet	1997-2004	20
V2500 Suburban (GMC)	305 CID (5.0L) Chevrolet	1987	43		350 CID (5.7L) Fuel Injected Chevrolet	1993-1999	53
V2500 Suburban (GMC)	350 CID (5.7L) Fuel Injected Chevrolet	1987-1991	53	W6N042	350 CID (5.7L) Carbureted Chevrolet	1979-1980	52
V2500 Suburban (GMC)	350 CID (5.7L) Carbureted Chevrolet	1987-1988	52	W6N042	366 CID (6.0L) Chevrolet	1979-1980	60
V2500 Suburban (GMC)	379 CID (6.2L) Chevrolet Diesel	1987-1991	62	W7N042	366 CID (6.0L) Chevrolet	1979-1980	60
V2500 Suburban (GMC)	454 CID (7.4L) Chevrolet	1987-1988	70	W7N042	427 CID (7.0L) Chevrolet	1979-1980	68
V2500(GMC)	262 CID (4.3L) Chevrolet	1987	32	W450	302 CID (5.0L) OHV General Motors	1955-1959	41
V2500(GMC)	292 CID (4.8L) Chevrolet	1987	39	W450-30	302 CID (5.0L) OHV General Motors	1952-1954	41
V2500(GMC)	305 CID (5.0L) Chevrolet	1987	43	W5000	351 CID (5.8L) General Motors	1963-1965	56
V2500(GMC)	350 CID (5.7L) Fuel Injected Chevrolet	1987	53	W	235 CID (3.9L) Chevrolet	1953-1955	27
V2500(GMC)	350 CID (5.7L) Carbureted Chevrolet	1987	52	WA5000	351 CID (5.8L) General Motors	1960-1962	56
V2500(GMC)	379 CID (6.2L) Chevrolet Diesel	1987	62	WA5000	401 CID (6.6L) General Motors	1960-1962	66
V2500(GMC)	454 CID (7.4L) Chevrolet	1987	70	WA5500	401 CID (6.6L) General Motors	1960-1965	66
V3000	305 CID (5.0L) General Motors	1960-1961	42	WA6500	478 CID (7.8L) General Motors	1964-1965	71
V3500	292 CID (4.8L) Chevrolet	1989	39	WM7500	401 CID (6.6L) General Motors	1966-1972	66
V3500	350 CID (5.7L) Fuel Injected Chevrolet	1989-1991	53	WM8500	401 CID (6.6L) General Motors	1966-1969	66
V3500	379 CID (6.2L) Chevrolet Diesel	1989-1991	62	WV5000	351 CID (5.8L) General Motors	1960-1962	56
V3500	454 CID (7.4L) Chevrolet	1989-1991	70	WV5000	401 CID (6.6L) General Motors	1960-1962	66
V3500(GMC)	292 CID (4.8L) Chevrolet	1987-1989	39	X	235 CID (3.9L) Chevrolet	1953-1955	27
V3500(GMC)	305 CID (5.0L) Chevrolet	1987	43	Y	235 CID (3.9L) Chevrolet	1953-1955	27
V3500(GMC)	305 CID (5.0L) General Motors	1960-1961	42	Yukon	294 CID (4.8L) Vortec 4800 LR4 Chevrolet	2000-2003	40
V3500(GMC)	350 CID (5.7L) Fuel Injected Chevrolet	1987-1991	53	Yukon	325 CID (5.3L) Vortec 5300 Chevrolet	2000-2003	46
V3500(GMC)	350 CID (5.7L) Carbureted Chevrolet	1987-1988	52	Yukon	350 CID (5.7L) Fuel Injected Chevrolet	1992-2000	53
V3500(GMC)	379 CID (6.2L) Chevrolet Diesel	1987-1991	62	Yukon	365 CID (6.0L) Vortec 6000 Chevrolet	1999-2003	57
V3500(GMC)	454 CID (7.4L) Chevrolet	1987-1991	70	Yukon	395 CID/6468CC (6.5L) Chevrolet Diesel	1994-1999	63
V4000	351 CID (5.8L) General Motors	1960-1961	56	Yukon 1500	325 CID (5.3L) Vortec 5300 L59 Chevrolet	2003	47
V5000	401 CID (6.6L) General Motors	1960-1961	66	Yukon XL 1500	325 CID (5.3L) Vortec 5300 L59 Chevrolet	2003	47
V	235 CID (3.9L) Chevrolet	1953-1955	27	Yukon XL 1500	325 CID (5.3L) Vortec 5300 Chevrolet	2000-2003	46
				Yukon XL 2500	365 CID (6.0L) Vortec 6000 Chevrolet	2001-2003	57
				Yukon XL 2500	365 CID (6.0L) Vortec 6000 Chevrolet	2000-2003	57
				Z	496 CID/8135CC (8.1L) Vortec 8100 L18 OHV Chevrolet	2001-2003	73
					235 CID (3.9L) Chevrolet	1953-1955	27

LIGHT TRUCK

1 97 CID (1.6L) LO1 16 Valve Suzuki 4 Cyl, 2.953in./75mm (1994-1997) 1

Part	Year	VIN	Model/Application	Part Number	Qty.
------	------	-----	-------------------	-------------	------

ENGINE GASKETS

Cylinder Head Gasket	1994-1997			Nitroseal 5866	1
Oil Pan Set	1994-1997			Cork Rubber OS32089	1
Rear Main Seal Set	1994-1997			JV594	1
Timing Cover Set	1994-1997		(Camshaft Seal Not Included)	JV1110	1

MISCELLANEOUS GASKETS

Camshaft Seal	1994-1997			66982	1
E.G.R. Gasket	1994-1997			G30785	1
Exhaust Pipe Gasket	1994-1997		(Ring Type 'F'), Pipe To Manifold	F12434	1
Throttle Body Gasket	1994-1995		Except California	G31095	1
Water Outlet Gasket	1994-1997			C31402	1
Water Pump Mount Gasket	1994-1997			K30640	1

2 97 CID (1.6L) LS5 8 Valve Suzuki 4 Cyl, 2.953in./75mm (1989-1995) **2**

Part	Year	VIN	Model/Application	Part Number	Qty.
ENGINE GASKETS					
Head Set	1989-1995		(Head Bolts Not Included, Exhaust Manifold Gasket Not Included)	HS5866	1
			(Contains Head Bolts, Exhaust Manifold Gasket Not Included)	HS5866WB	1
Full Set	1989-1995		(Head Bolts Not Included, Exhaust Manifold Gasket Not Included)	FS5866	1
Cylinder Head Gasket	1989-1995		<i>Nitroseal</i>	5866	1
Cyl. Head Bolt Set	1989-1995			GS33244	1
Valve Cover Set	1989-1995		<i>Cork Rubber</i>	VS50042	1
Valve Stem Seal, Exh.	1989-1995			B45590	4
Valve Stem Seal, Int.	1989-1995			B45590	4
Manifold Set, Exhaust	1989-1995			MS15629	1
Manifold Set, Intake	1989-1995			MS15628	1
Oil Pan Set	1989-1995		<i>Cork Rubber</i>	OS32089	1
Rear Main Seal Set	1989-1995			JV594	1
Timing Cover Set	1989-1995		(Camshaft Seal Not Included)	JV1110	1
				JV5009	1

MISCELLANEOUS GASKETS					
Camshaft Seal	1989-1995			66982	1
E.G.R. Gasket	1989-1995		Except California	G30785	1
Exhaust Pipe Gasket	1989-1995		(Ring Type 'F'), Exhaust Pipe To Muffler	F7437	1
			Except California, (Flange Type), Pipe To Manifold	F7483	1
Throttle Body Gasket	1989-1995		Except California	G31095	1
Water Inlet Gasket	1989-1995		(O-Ring Type)	C31514	1
Water Outlet Gasket	1989-1995			C30645	1
Water Pump Mount Gasket	1989-1995			K30640	1

3 1817CC (1.8L) SOHC Isuzu 4 Cyl, 3.307in./84mm (1972-1982) **3**

Part	Year	VIN	Model/Application	Part Number	Qty.
ENGINE GASKETS					
Head Set	1976-1982			HS3553	1
	1972-1975			HS3529	1
Full Set	1976-1982			FS3553	1
	1973-1975			FS3529W	1
	1972			FS3529	1
Engine Kit Gasket Set	1976-1982		Series 5, 6, 8, 9, 10, 11, 12	95-3404VR	1
Cylinder Head Gasket	1976-1982		<i>Nitroseal</i>	3553	1
	1972-1975			3529	1
Valve Cover Set	1976-1982		<i>Cork Rubber</i>	VS38132	1
	1972-1975		(Complete Cam Carrier And Cover Set) <i>Victo-Tech</i>	VS38341	1
Valve Stem Seal, Exh.	1972-1982			B20183	4
Valve Stem Seal, Int.	1972-1982			B20183	4
Manifold Set, Exhaust	1976-1982			MS12282	1
Manifold Set, Intake	1976-1982			MS12279	1
Manifold Set, Int. & Exh.	1972-1975			MS15246X	1
Oil Pan Set	1976-1982		<i>Victo-Tech</i>	OS30164	1
	1973-1975		<i>Victo-Tech</i>	OS30339	1
	1972		<i>Cork Rubber</i>	OS30308	1
Rear Main Seal Set	1972-1982			JV626	1
Timing Cover Set	1976-1982			JV950	1
	1972-1975			JV949	1
Timing Cover Seal	1972-1982			47604	1

MISCELLANEOUS GASKETS					
Carb. Mount Gasket	1972-1982		Series 11, Series 12, 2 Barrel Carburetor	G26674	1
			Series 5, 6, 8, 9, 10, 2 Barrel Carburetor	G26707	1

LIGHT TRUCK

General Motors Truck

3	1817CC (1.8L) SOHC Isuzu 4 Cyl, 3.307in./84mm (1972-1982)	3
(cont.)		(cont.)

Part	Year	VIN	Model/Application	Part Number	Qty.
MISCELLANEOUS GASKETS (cont.)					
Carb. Mount Gasket (cont.)	1972-1982		Series 4, 2 Barrel Carburetor	G26778	1
Cylinder Head End Plug	1976-1982		Series 5 Through 12	B24130	2
E.G.R. Gasket	1976-1982		To Manifold	G26276	1
Exhaust Pipe Gasket	1976-1982		(Flange Type), Front, Pipe To Converter, Rear	F7277	2
			Except Series 12, (Ring Type 'B'), Pipe To Manifold	F20223	1
			Series 12, (Ring Type 'A'), Pipe To Manifold	F20371	1
	1972-1975		(Flange Type), Pipe To Manifold	F20320	1
Fuel Pump Gasket	1972-1982			D27265	1
Water Outlet Gasket	1972-1982		(2 Holes) <i>Victopac</i>	C20115	1
Water Pump Mount Gasket	1976-1982			K27272	1
	1972-1975			K27224	1

4	119 CID (1.9L) LR1 SOHC Isuzu 4 Cyl, 3.425in./87mm (1982-1985)	4
----------	---	----------

Part	Year	VIN	Model/Application	Part Number	Qty.
ENGINE GASKETS					
Head Set	1982-1985		(Exhaust Pipe Gasket Not Included)	HS3716	1
Full Set	1982-1985		(Exhaust Pipe Gasket Not Included)	FS3716	1
Engine Kit Gasket Set	1982-1985			95-3404VR	1
Cylinder Head Gasket	1982-1985		<i>Nitroseal</i>	3716G	1
Valve Cover Set	1982-1985		<i>Cork Rubber</i>	VS38132	1
Valve Stem Seal, Exh.	1982-1985			B20183	4
Valve Stem Seal, Int.	1982-1985			B20183	4
Manifold Set, Exhaust	1982-1985			MS12282	1
Manifold Set, Intake	1982-1985			MS12279	1
Oil Pan Set	1982-1985		<i>Victo-Tech</i>	OS30164	1
Rear Main Seal Set	1982-1985			JV626	1
Timing Cover Set	1982-1985		(Requires Oil Pan Set, Requires Valve Cover Set)	JV950	1
Timing Cover Seal	1982-1985			47604	1

MISCELLANEOUS GASKETS

Carb. Mount Gasket	1982-1985		2 Barrel Carburetor	G26781	1
Cylinder Head End Plug	1982-1985			B24130	2
E.G.R. Gasket	1982-1985		To Manifold	G26276	1
Exhaust Pipe Gasket	1982-1985		(Ring Type 'E'), Pipe To Manifold	F7271	1
Fuel Pump Gasket	1982-1985			D27265	1
Water Outlet Gasket	1982-1985		(2 Holes) <i>Victopac</i>	C20115	1
Water Pump Mount Gasket	1982-1985			K27272	1

5	121 CID (2.0L) LQ2 Chevrolet 4 Cyl, 3.504in./89mm (1983-1984)	5
----------	--	----------

Part	Year	VIN	Model/Application	Part Number	Qty.
ENGINE GASKETS					
Head Set	1983-1984		(Exhaust Pipe Gasket Not Included)	HS3722	1
Full Set	1983-1984		(Contains 5.5 Wide Rear Main Seal, Exhaust Pipe Gasket Not Included)	FS3722	1
Cylinder Head Gasket	1983-1984		<i>Solicor</i>	3722	1
Valve Cover Set	1983-1984		<i>Cork Rubber</i>	VS39362	1
Valve Stem Seal, Exh.	1983-1984		(Positive Type)	B45411	4
Valve Stem Seal, Int.	1983-1984		(Positive Type)	B45410	4
Manifold Set, Exhaust	1983-1984			MS15331	1
Manifold Set, Intake	1983-1984			MS15330	1
Oil Pan Set	1983-1984		<i>Cork Rubber</i>	OS30590	1
Rear Main Seal Set	1983-1984		(2 Piece, Not Contained In Full Set)	JV526	1

5 121 CID (2.0L) LQ2 Chevrolet 4 Cyl, 3.504in./89mm (1983-1984) **5**
(cont.) (cont.)

Part	Year	VIN	Model/Application	Part Number	Qty.	
ENGINE GASKETS (cont.)						
Rear Main Seal Set (cont.)	1983-1984		(Contained In Full Set)			
				5.5mm Wide	JV531	1
			(Not Contained In Full Set)	11mm Wide	JV544	1
			Teflon, 11mm Wide	JV1633	1	
Timing Cover Set	1983-1984			JV989	1	
Timing Cover Gasket	1983-1984			T27725	1	
Timing Cover Seal	1983-1984			48277SF	1	
Harmonic Balancer Repair Sleeve	1983-1984		Ground Steel, .020" Thickness	66597RS	1	
			Use With Part Number A504 Nickel Plated Formed Steel, .013" Thickness	A228	1	

MISCELLANEOUS GASKETS

Air Cleaner Mount Gasket	1983-1984		2 Barrel Carburetor	G26170	1
Dist. Mounting Gasket	1983-1984			72214	1
E.G.R. Gasket	1983-1984		Valve To Adapter	G17797	1
			Adapter To Cylinder Head	G26305	1
Exhaust Pipe Gasket	1983-1984		(Ring Type 'E'), Pipe To Manifold	F7271	1
Fuel Pump Gasket	1983-1984			D27094	1
			Tuff-Cork	D27094TC	1
Oil Pan Drain Plug Gst.	1983-1984			2051	1
Therm. Housing Gasket	1983-1984		Housing To Head	C25169	1
Water Outlet Gasket	1983-1984			C25163	1
Water Pump Mount Gasket	1983-1984			K27452	1

6 134 CID (2.2L) OHV Chevrolet 4 Cyl, 3.504in./89mm (1994-2003) **6**

Part	Year	VIN	Model/Application	Part Number	Qty.
------	------	-----	-------------------	-------------	------

ENGINE GASKETS

Head Set	2000-2002	5	(Head Bolts Not Included, Exhaust Pipe Gasket Not Included)	HS54051C	1	
	1998-2000	4	(Head Bolts Not Included, Exhaust Pipe Gasket Not Included)	HS54051B	1	
	1994-1997		(Head Bolts Not Included, Exhaust Pipe Gasket Not Included)	HS4023	1	
Lower Set	1994-2002		(Requires Head Set To Make Full Set)	CS4023	1	
Engine Kit Gasket Set	1994-1997			95-3493VR	1	
Cylinder Head Gasket	1998-2003		Nitroseal	54051	1	
	1994-1997			4023	1	
Cyl. Head Bolt Set	1998-2003			GS33362	1	
	1994-1997			GS33295	1	
Valve Cover Set	1998-2003		Victo-Tech	VS50249	1	
	1994-1997		Victo-Tech	VS50051	1	
Valve Stem Seal, Exh.	1998-2003			B45864	4	
	1994-1997		7mm Valve Stem Diameter	B45814	4	
Valve Stem Seal, Int.	1998-2003			B45864	4	
	1994-1997		7mm Valve Stem Diameter	B45814	4	
Manifold Set, Exhaust	2000-2002			MS16312	1	
	1998-2000			MS16311	1	
	1994-1997			MS15440	1	
Manifold Set, Intake	2001-2003		To Be Replaced By MS16507	Victo-Tech	MS16313	1
	1998-2003			Victo-Tech	MS16507	1
	2000-2002	5	To Be Replaced By MS16507	Victo-Tech	MS16313	1
		5		Victo-Tech	MS16507	1
	1998-2000	4		Victo-Tech	MS16507	1

General Motors Truck

6 (cont.)	134 CID (2.2L) OHV Chevrolet 4 Cyl, 3.504in./89mm (1994-2003)				6 (cont.)
---------------------	--	--	--	--	---------------------

<i>Part</i>	<i>Year</i>	<i>VIN</i>	<i>Model/Application</i>	<i>Part Number</i>	<i>Qty.</i>
ENGINE GASKETS (cont.)					
Manifold Set, Intake (cont.)	1994-1997		(Contains Plenum Chamber Gasket)	MS15687	1
Plenum Chamber Gasket	1994-1997			MS15687A	1
Oil Pan Set	1994-2002		<i>Cork Rubber</i>	OS32120	1
Rear Main Seal Set	1994-2003			JV544	1
			<i>Teflon</i>	JV1633	1
Timing Cover Set	1994-2003			JV1061	1
Timing Cover Gasket	1994-2003			T31351	1
Timing Cover Seal	1994-2003			48277SF	1

MISCELLANEOUS GASKETS

E.G.R. Gasket	1998-2003		Adapter Or Cover To Cylinder Head, Rear	G31583	1
	1998-2002		Cover To Cylinder Head, Intake Side	G31525	1
	1996-1998		Valve To Adapter	G31356	1
	1996-1997		Adapter Or Cover To Cylinder Head, Rear	G31481	1
	1994-1995		Valve To Adapter	G17797	1
			Adapter To Cylinder Head	G31425	1
Exhaust Pipe Gasket	1997-2003		(Flange Type), Pipe To Converter, Rear	F7555	1
			(Flange Type), Front, Pipe To Converter	F7556	1
	1996-1998		(Flange Type), Pipe To Manifold	F7537	1
	1996		(Flange Type), Front, Pipe To Converter	F7535	1
			(Flange Type), Pipe To Converter, Rear	F7536	1
	1994-1995		(Ring Type 'E'), Pipe To Manifold	F7271	1
Oil Pan Drain Plug Gst.	1998-2003			B45828	1
	1994-1997			2051	1
Oil Pan Seal	1994-2003		Rear	B45598	1
Thermostat Seal	1998-2003		<i>Victo-Tech</i>	C31156	1
	1994-1997		<i>Victo-Tech</i>	C31301	1
Throttle Body Gasket	1998-2003			G31524	1
	1994-1995			G31275	1
Water Inlet Gasket	1994-2003			C31275	1
Water Outlet Gasket	1998-2003		Water Outlet Adapter To Cylinder Head	C31506	1
	1994-1997		Water Outlet Adapter To Cylinder Head	C31397	1
Water Pump Mount Gasket	1994-2003			K31274	1

7	137 CID (2.2L) LQ7 OHV Isuzu Diesel 4 Cyl, 3.465in./88mm (1984-1985)				7
----------	---	--	--	--	----------

<i>Part</i>	<i>Year</i>	<i>VIN</i>	<i>Model/Application</i>	<i>Part Number</i>	<i>Qty.</i>
ENGINE GASKETS					
Head Set	1984-1985			HS3717	1
Full Set	1984-1985		(Oil Pan Gasket For 4 Wheel Drive Not Included)	FS3717	1
Cylinder Head Gasket	1984-1985		<i>Steel</i>	3717	1
Valve Cover Set	1984-1985		<i>Victo-Tech</i>	VS39367	1
Valve Stem Seal, Exh.	1984-1985		(O-Ring Type)	B45562	4
			(Positive Type)	B45565	4
Valve Stem Seal, Int.	1984-1985		(O-Ring Type)	B45562	4
			(Positive Type)	B45565	4
Manifold Set, Int. & Exh.	1984-1985			MS15332	1
Oil Pan Set	1984-1985		2 Wheel Drive <i>Cork Rubber</i>	OS30579	1
			4 Wheel Drive <i>Cork Rubber</i>	OS30580	1
Rear Main Seal Set	1984-1985			JV626	1
Timing Cover Set	1984-1985			JV972	1
Timing Cover Seal	1984-1985			47935	1

7 137 CID (2.2L) LQ7 OHV Isuzu Diesel 4 Cyl, 3.465in./88mm (1984-1985) **7**
(cont.) (cont.)

Part	Year	VIN	Model/Application	Part Number	Qty.
MISCELLANEOUS GASKETS					
Camshaft Seal	1984-1985			47945	1
Exhaust Pipe Gasket	1984-1985		(Ring Type 'F'), Pipe To Manifold	F7210	1
Push Rod Cover Set	1984-1985			PS38796	1
Water Outlet Gasket	1984-1985			C24129	1
Water Pump Mount Gasket	1984-1985			K27422	1

8 2238CC (2.2L) OHV Isuzu Diesel 4 Cyl, 3.465in./88mm (1981-1982) **8**

Part	Year	VIN	Model/Application	Part Number	Qty.
ENGINE GASKETS					
Head Set	1981-1982			HS3717	1
Full Set	1981-1982		(Oil Pan Gasket For 4 Wheel Drive Not Included)	FS3717	1
Cylinder Head Gasket	1981-1982		<i>Steel</i>	3717	1
Valve Cover Set	1981-1982		<i>Victo-Tech</i>	VS39367	1
Valve Stem Seal, Exh.	1981-1982		(O-Ring Type)	B45562	4
			(Positive Type)	B45565	4
Valve Stem Seal, Int.	1981-1982		(O-Ring Type)	B45562	4
			(Positive Type)	B45565	4
Manifold Set, Int. & Exh.	1981-1982			MS15332	1
Oil Pan Set	1981-1982		2 Wheel Drive <i>Cork Rubber</i>	OS30579	1
			4 Wheel Drive <i>Cork Rubber</i>	OS30580	1
Rear Main Seal Set	1981-1982			JV626	1
Timing Cover Set	1981-1982			JV972	1
Timing Cover Seal	1981-1982			47935	1

MISCELLANEOUS GASKETS					
Push Rod Cover Set	1981-1982			PS38796	1
Water Outlet Gasket	1981-1982			C24129	1
Water Pump Mount Gasket	1981-1982			K27422	1

9 138 CID (2.3L) DOHC Oldsmobile 4 Cyl, 3.622in./92mm (1993-1996) **9**

Part	Year	VIN	Model/Application	Part Number	Qty.
ENGINE GASKETS					
Head Set	1995		(Head Bolts Not Included)	HS5870C	1
	1994		(Head Bolts Not Included, Exhaust Pipe Gasket Not Included)	HS5870A	1
	1993		2nd Design: Seals Fit Into Grooves In Camshaft Housing Cover, 2nd Design: With 21 Hole Timing Cover Gasket 3.40mm Thick, (Head Bolts Not Included, Exhaust Pipe Gasket Not Included)	HS5870A	1
Lower Set	1995		(Requires Head Set To Make Full Set)	CS5870A	1
	1993-1994		(Requires Head Set To Make Full Set)	CS5870	
Cylinder Head Gasket	1993-1995		<i>Nitroseal</i>	5870	1
Cyl. Head Bolt Set	1993-1996			GS33239	1
Valve Cover Set	1994-1996		Exhaust Camshaft Carrier	VS50204	1
			(Contains Camshaft Seal), Intake Camshaft Carrier	VS50205	1
	1993		1st Design: Seals Fit Into Grooves In Camshaft Housing, Exhaust Camshaft Carrier	VS50113	1
			1st Design: Seals Fit Into Grooves In Camshaft Housing, (Contains Camshaft Seal), Intake Camshaft Carrier	VS50114	1
			2nd Design: Seals Fit Into Grooves In Camshaft Housing Cover, Exhaust Camshaft Carrier	VS50204	1
		2nd Design: Seals Fit Into Grooves In Camshaft Housing Cover, (Contains Camshaft Seal), Intake Camshaft Carrier	VS50205	1	
Valve Stem Seal, Exh.	1993-1996			B45672	8
Valve Stem Seal, Int.	1993-1996			B45672	8

General Motors Truck

9 (cont.)	138 CID (2.3L) DOHC Oldsmobile 4 Cyl, 3.622in./92mm (1993-1996)				9 (cont.)
---------------------	--	--	--	--	---------------------

Part	Year	VIN	Model/Application	Part Number	Qty.
------	------	-----	-------------------	-------------	------

ENGINE GASKETS (cont.)

Manifold Set, Exhaust	1995			MS16142	1
	1993-1994			MS16135	1
Manifold Set, Intake	1993-1996			MS15636	1
Oil Pan Set	1995			OS32150	1
	1993-1994		<i>Tuff-Cork</i>	OS32094	1
Rear Main Seal Set	1993-1996			JV596	1
Crank Repair Sleeve	1993-1996		<i>Nickel Plated Formed Steel, .013" Thickness</i>	A353	1
Timing Cover Set	1994-1995			JV1167	1
	1993		2nd Design: With 21 Hole Timing Cover Gasket 3.40mm Thick	JV1167	1
Timing Cover Seal	1993-1996			48176	1

MISCELLANEOUS GASKETS

Camshaft Seal	1993-1996			48174	1
Exhaust Pipe Gasket	1993-1996		Catalytic Converter <i>51mm Inside Diameter</i>	F10131	1
Injector Nozzle O-Ring	1993-1995			GS33276	2
Thermostat O-Ring	1995			C31156	1
Throttle Body Gasket	1993-1996			G31113	1
Water Outlet Gasket	1993-1996			C31114	1
Water Pump Mount Set	1993-1995		(Requires Exhaust Manifold Gasket)	GS33188	1

10	140 CID (2.3L) Chevrolet 4 Cyl, 3.500in./88.9mm (1971-1975)				10
-----------	--	--	--	--	-----------

Part	Year	VIN	Model/Application	Part Number	Qty.
------	------	-----	-------------------	-------------	------

ENGINE GASKETS

Head Set	1971-1975			HS3445VC	1
Full Set	1971-1975			FS3445VC	1
Engine Kit Gasket Set	1971-1975			95-3027VR	1
Cylinder Head Gasket	1971-1975		<i>VR2000</i>	3445VC	1
Valve Cover Set	1971-1975		<i>Cork Rubber</i>	VS38424	1
Valve Stem Seal, Exh.	1971-1975		(Positive Type)	B45404	4
Valve Stem Seal, Int.	1971-1975		(Positive Type) <i>Fluoroelastomer</i>	B45418	4
Manifold Set, Exhaust	1971-1975			MS15210	1
Manifold Set, Intake	1971-1975			MS15178	1
Oil Pan Set	1971-1975		<i>Cork Rubber</i>	OS20770	1
Rear Main Seal Set	1971-1975			JV610	1
Timing Cover Set	1971-1975			JV873	1
Timing Cover Gasket	1971-1975		(Oil Pump Cover)	T27613	1
Timing Cover Seal	1971-1975			47483	1

MISCELLANEOUS GASKETS

Air Cleaner Mount Gasket	1973-1975		2 Barrel Carburetor	G26813	1
	1971-1975		1 Barrel Carburetor	G25936	1
	1971-1972		2 Barrel Carburetor	G26617	1
Carb. Mount Gasket	1973-1975		2 Barrel Carburetor, (Insulator)	G25462	1
			2 Barrel Carburetor	G25469	1
	1971-1975		(Insulator), 1 Barrel Carburetor	G26718	1
			1 Barrel Carburetor	G26841	1
Dist. Mounting Gasket	1971-1975			B26466	1
Water Outlet Gasket	1971-1975			C24004	1
Water Pump Mount Gasket	1971-1975			K26041	1

LIGHT TRUCK

11 145 CID (2.4L) Chevrolet Corvair 6 Cyl, 3.438in./87.33mm (1961-1963) 11

Part	Year	VIN	Model/Application	Part Number	Qty.
ENGINE GASKETS					
Head Set	1961-1963			HS1170X	2
Full Set	1961-1963			FS1170X	1
Cylinder Head Gasket	1961-1963			1170	6
Valve Cover Set	1961-1963		<i>Victo-Tech</i>	VS28294	1
Manifold Set, Exhaust	1961-1963			MS7158	1
Oil Pan Set	1961-1963		<i>Cork Rubber</i>	OS30664	1
Rear Main Seal Set	1961-1963			JV646	1
Timing Cover Set	1961-1963			JV858	1

MISCELLANEOUS GASKETS					
Air Cleaner Mount Gasket	1961-1963		2-1 Barrel Carburetors	G25936	2
Dist. Mounting Gasket	1961-1963			B26466	1
Exhaust Pipe Gasket	1961-1963		(Ring Type 'C'), Pipe To Manifold	F7140	2
Fuel Pump Gasket	1961-1963			72210	1

12 151 CID (2.5L) Fuel Injected Pontiac 4 Cyl, 4.000in./101.6mm (1985-1993) 12

Part	Year	VIN	Model/Application	Part Number	Qty.
ENGINE GASKETS					
Head Set	1991-1993	A	(Head Bolts Not Included, Exhaust Pipe Gasket Not Included)	HS5701A	1
		A	(Contains Head Bolts, Exhaust Pipe Gasket Not Included)	HS5701WB4	1
	1987-1991	E	(Head Bolts Not Included, Exhaust Pipe Gasket Not Included)	HS5701W	1
		E	(Contains Head Bolts, Exhaust Pipe Gasket Not Included)	HS5701WB1	1
	1985-1986	E	(Head Bolts Not Included, Exhaust Pipe Gasket Not Included)	HS5701	1
		E	(Contains Head Bolts, Exhaust Pipe Gasket Not Included)	HS5701WB	1
Full Set	1991-1993	A	(Head Bolts Not Included, Exhaust Pipe Gasket Not Included)	FS5701A	1
	1987-1991	E	(Head Bolts Not Included, Exhaust Pipe Gasket Not Included)	FS5701W	1
	1985-1986	E	(Head Bolts Not Included, Exhaust Pipe Gasket Not Included)	FS5701	1
Engine Kit Gasket Set	1991-1993	A		95-3253VR	1
	1987-1991	E		95-3449VR	1
	1985-1986	E	(Push Rod Cover Set Not Included), Use With Part Number PS39841	95-3399VR	1
Cylinder Head Gasket	1985-1993		<i>VR2000</i>	5701	1
Cyl. Head Bolt Set	1985-1993			GS33190	1
Cyl. Head Spacer Shim	1985-1993		Requires Sealing Compound <i>Steel</i>	5701S	1
Sealing Compound	1985-1993		(4 Ounce Brush Top Can)	JV66B	1
			(12 Ounce Spray Can)	JV66S	1
Valve Cover Set	1985-1993		<i>Cork Rubber</i>	VS39354	1
			<i>High Temperature Tuff-Cork</i>	VS39354HTC	1
			<i>Victo-Tech</i>	VS39354R	1
Valve Stem Seal, Exh.	1987-1993		(Positive Type)	B45613	4
	1985-1986		(O-Ring Type)	B45229	4
Valve Stem Seal, Int.	1987-1993		(Positive Type)	B45613	4
	1985-1986		(O-Ring Type)	B45229	4
			(Positive Type)	<i>Fluoroelastomer</i>	B45418
Manifold Set, Exhaust	1987-1993			MS15433	1
	1985-1986			MS15303	1
Manifold Set, Intake	1991-1993	A		MS15668	1
	1987-1991	E		MS15438	1
	1985-1986			MS15304	1
Oil Pan Set	1985-1993		<i>Cork Rubber</i>	OS30539X	1
			<i>Tuff-Cork</i>	OS30539XTC	1

General Motors Truck

12 151 CID (2.5L) Fuel Injected Pontiac 4 Cyl, 4.000in./101.6mm (1985-1993) **12**
 (cont.) (cont.)

Part Year VIN Model/Application Part Number Qty.

ENGINE GASKETS (cont.)

Rear Main Seal Set	1985-1993			JV553	1
Crank Repair Sleeve	1985-1993		1 Piece Rear Main Seal, Use With Part Number A510, Rear <i>Nickel Plated Formed Steel, .013" Thickness</i>	A339	1
Timing Cover Set	1991-1993	A	(Repair Sleeve Not Included)	JV1140	1
	1985-1991	E	(Repair Sleeve Not Included)	JV883	1
		E	(Contains Repair Sleeve)	JV1136	1
Timing Cover Gasket	1985-1993			T27634	1
Timing Cover Seal	1985-1993			48277SF	1
Harmonic Balancer Repair Sleeve	1985-1993		<i>Ground Steel, .020" Thickness</i>	66597RS	1
			Use With Part Number A504 <i>Nickel Plated Formed Steel, .013" Thickness</i>	A228	1

MISCELLANEOUS GASKETS

Air Cleaner Mount Gasket	1991-1992		Throttle Body Injection	G26410	1
	1985-1990		Throttle Body Injection	G26803	1
Dist. Mounting Gasket	1985-1990			72216	1
E.G.R. Gasket	1991-1993			G31178	1
	1985-1990			G26985	1
Exhaust Pipe Gasket	1985-1993		(Ring Type 'F'), Pipe To Manifold	F7398	1
Fuel Pump Gasket	1985-1986			D27094	1
			<i>Tuff-Cork</i>	D27094TC	1
Oil Pan Drain Plug Gst.	1985-1993			2051	1
Push Rod Cover Set	1985-1993		<i>Cork Rubber</i>	PS39841	1
Therm. Housing Gasket	1991-1993		Housing To Head <i>Victo-Tech</i>	C31216	1
	1987-1990		Housing To Head	C31377	1
	1985-1986		Housing To Head <i>Victo-Tech</i>	C31422	1
Throttle Body Gasket	1987-1993			G30969	1
	1985-1986			G26794	1
Water Outlet Gasket	1985-1993			C24109	1
Water Pump Mount Gasket	1991-1993			K31217	1
	1985-1990			K26545	1

13 153 CID (2.5L) Chevrolet 4 Cyl, 3.875in./98.4mm (1963-1965) **13**

Part Year VIN Model/Application Part Number Qty.

ENGINE GASKETS

Head Set	1963-1965			HS1179VC	1
Full Set	1963-1965			FS1179VC	1
Cylinder Head Gasket	1963-1965		<i>VR2000</i>	1179VC	1
Valve Cover Set	1963-1965		<i>Cork Rubber</i>	VS38114	1
Valve Stem Seal, Exh.	1963-1965		(O-Ring Type)	B45229	4
Valve Stem Seal, Int.	1963-1965		(O-Ring Type)	B45229	4
Manifold Set, Int. & Exh.	1963-1965			MS15104	1
Oil Pan Set	1963-1965		<i>Cork Rubber</i>	OS30539	1
Rear Main Seal Set	1963-1965			JV728	1
Timing Cover Set	1963-1965		(Repair Sleeve Not Included)	JV862	1
			(Contains Repair Sleeve)	JV925	1
Timing Cover Gasket	1963-1965			T14744	1
Timing Cover Seal	1963-1965		<i>3/8" Wide</i>	49328	1
			(Lip Relocator Type) <i>1/2" Wide</i>	65022	1
Harmonic Balancer Repair Sleeve	1963-1965		<i>Ground Steel, .020" Thickness</i>	66597RS	1

LIGHT TRUCK

General Motors Truck

13	153 CID (2.5L) Chevrolet 4 Cyl, 3.875in./98.4mm (1963-1965)	13
(cont.)		(cont.)

Part	Year	VIN	Model/Application	Part Number	Qty.
------	------	-----	-------------------	-------------	------

ENGINE GASKETS (cont.)

Harmonic Balancer Repair Sleeve (cont.)	1963-1965		Use With Part Number A504 <i>Nickel Plated Formed Steel, .013" Thickness</i>	A228	1
---	-----------	--	---	------	---

MISCELLANEOUS GASKETS

Air Cleaner Mount Gasket	1963-1965		1 Barrel Carburetor	G25936	1
Carb. Mount Gasket	1963-1965		1 Barrel Carburetor	G5349AD	1
Dist. Mounting Gasket	1963-1965			B26466	1
Exhaust Pipe Gasket	1963-1965		(Ring Type 'C'), Pipe To Manifold	F17250	1
			(Ring Type 'B'), Pipe To Manifold	<i>Sintered Metal</i> F17250S	1
Fuel Pump Gasket	1963-1965			D27094	1
Push Rod Cover Set	1963-1965			PS38112	1
Therm. Housing Gasket	1963-1965		Housing To Head	C26544	1
Water Outlet Gasket	1963-1965		(Universal Type)	C24109	1
				C25930	1
Water Pump Mount Gasket	1963-1965			K26545	1

14	159 CID (2.6L) 3-53 Detroit Diesel Diesel 3 Cyl, 3.875in./98.4mm (1967-1968)	14
-----------	---	-----------

Part	Year	VIN	Model/Application	Part Number	Qty.
------	------	-----	-------------------	-------------	------

ENGINE GASKETS

Head Set	1967-1968		(Original Equipment Type)	HS12232A	1
Full Set	1967-1968		(Original Equipment Type, Crankshaft Seals Not Included)	FS12232A	1

15	164 CID (2.7L) Chevrolet 6 Cyl, 3.500in./88.9mm (1964)	15
-----------	---	-----------

Part	Year	VIN	Model/Application	Part Number	Qty.
------	------	-----	-------------------	-------------	------

ENGINE GASKETS

Head Set	1964			HS1170X	2
Full Set	1964			FS1170X	1
Cylinder Head Gasket	1964			1170	6
Valve Cover Set	1964		<i>Victo-Tech</i>	VS28294	1
Manifold Set, Exhaust	1964			MS7158	1
Oil Pan Set	1964		<i>Cork Rubber</i>	OS30664	1
Rear Main Seal Set	1964			JV646	1
Timing Cover Set	1964			JV858	1

MISCELLANEOUS GASKETS

Air Cleaner Mount Gasket	1964		2-1 Barrel Carburetors	G25936	2
Carb. Mount Gasket	1964		2-1 Barrel Carburetors	G7177	2
Clutch Throwout Brg. Seal	1964		Inner	47448	1
Crankcase Cover Gasket	1964		Top Cover	OS20604	1
Dist. Mounting Gasket	1964			B26466	1
Fuel Pump Gasket	1964			72210	1
Oil Pan Drain Plug Gst.	1964			2051	1

16	173 CID (2.8L) Chevrolet V6 Cyl, 3.504in./89mm (1982-1993)	16
-----------	---	-----------

Part	Year	VIN	Model/Application	Part Number	Qty.
------	------	-----	-------------------	-------------	------

ENGINE GASKETS

Head Set	1986-1993		(Head Bolts Not Included, Exhaust Pipe Gasket Not Included)	HS3549T	1
			(Contains Head Bolts, Exhaust Pipe Gasket Not Included)	HS3549WB4	1

LIGHT TRUCK

General Motors Truck

16 173 CID (2.8L) Chevrolet V6 Cyl, 3.504in./89mm (1982-1993)

16
(cont.)

Part	Year	VIN	Model/Application	Part Number	Qty.
ENGINE GASKETS (cont.)					
Head Set (cont.)	1982-1985		(Head Bolts Not Included, Exhaust Pipe Gasket Not Included)	HS3549	1
			(Contains Head Bolts, Exhaust Pipe Gasket Not Included)	HS3549WB	1
Lower Set	1987-1993		(Requires Head Set To Make Full Set)	CS3549	1
	1982-1984		(Requires Head Set To Make Full Set)	CS3549B	1
Full Set	1987-1991		(Head Bolts Not Included, Exhaust Pipe Gasket Not Included)	FS3549U	1
	1986		(Head Bolts Not Included, Exhaust Pipe Gasket Not Included)	FS3549T	1
	1985		(Head Bolts Not Included, Exhaust Pipe Gasket Not Included, Contains Externally Mounted 11mm Wide Rear Main Seal)	FS3549W	1
	1982-1984		(Head Bolts Not Included, Exhaust Pipe Gasket Not Included)	FS3549	1
Engine Kit Gasket Set	1987-1993	R	Cast Iron Cylinder Heads	95-3416VR	1
	1986	R	(Optional Oil Pan Set For Goodwrench Replacement Engine Not Included), Use With Part Number OS32495	95-3406VR	1
	1985	B	(Valve Cover Set Not Included, First Design 5.5mm Rear Main Seal Not Included, Contains Second Design 11mm Thick Rear Main Seal, Optional Oil Pan Set For Goodwrench Replacement Engine Not Included), Use With Part Numbers OS32495, VS39772, JV531	95-3406VR	1
	1982-1984		(5.5mm Rear Main Seal Not Included, Optional Oil Pan Set For Goodwrench Replacement Engine Not Included), Use With Part Numbers JV531, OS32495	95-3435VR	1
Cylinder Head Gasket	1982-1993		VR2000	3549	2
Cyl. Head Bolt Set	1982-1993			GS33223	2
Valve Cover Set	1986-1993		Cork Rubber	VS50019	1
	1982-1985		Cork Rubber	VS39772	1
				Victo-Tech	VS39772R
Valve Stem Seal, Exh.	1982-1993		(O-Ring Type)	B45229	6
Valve Stem Seal, Int.	1982-1993		(O-Ring Type)	B45229	6
			(Positive Type)	Fluoroelastomer	B45418
Manifold Set, Exhaust	1982-1993			MS15310	1
Manifold Set, Intake	1982-1993			MS15307	1
Oil Pan Set	1987-1993		Tuff-Cork	OS32476TC	1
			Victo-Tech	OS32495	1
	1985-1986		Cork Rubber	OS32025	1
	1982-1984		Cork Rubber	OS32104	1
Rear Main Seal Set	1985-1993		(1 Piece) 11mm Wide	JV544	1
			(1 Piece) Teflon	JV1633	1
	1982-1985		(1 Piece) 5.5mm Wide	JV531	1
	1982-1984		(2 Piece)	JV526	1
Crank Repair Sleeve	1985-1993		Use With Part Number A510, Rear Nickel Plated Formed Steel, .013" Thickness	A337	1
Timing Cover Set	1987-1993		(Repair Sleeve Not Included)	JV1066	1
	1982-1986		(Repair Sleeve Not Included)	JV948	1
				(Contains Repair Sleeve)	JV1131
Timing Cover Gasket	1982-1993			T27635	1
Timing Cover Seal	1982-1993		3/8" Wide	49328	1
			(Lip Relocator Type) 1/2" Wide	65022	1
Harmonic Balancer Repair Sleeve	1982-1993		Use With Part Number A504 Nickel Plated Formed Steel, .013" Thickness	A228-1	1
MISCELLANEOUS GASKETS					
Air Cleaner Mount Gasket	1986-1993		Throttle Body Injection	G27098	1
	1982-1985		2 Barrel Carburetor	G26672	1
Cam. Cover Gasket	1982-1993			H36978	1
Carb. Mount Gasket	1982-1985		Except Heater Type, 2 Barrel Carburetor	G26773	1

LIGHT TRUCK

16 173 CID (2.8L) Chevrolet V6 Cyl, 3.504in./89mm (1982-1993) **16**
(cont.) (cont.)

Part	Year	VIN	Model/Application	Part Number	Qty.
MISCELLANEOUS GASKETS (cont.)					
Dist. Mounting Gasket	1982-1993			72214	1
E.G.R. Gasket	1982-1993			G17797	1
Exhaust Pipe Gasket	1983-1993		(Ring Type 'E'), Pipe To Manifold	F7271	1
	1982		(Ring Type 'F'), Pipe To Manifold	F7210	1
Fuel Pump Gasket	1982-1993			D27228	1
Oil Filter Adapt Gasket	1982-1993			B31606	1
Oil Pan Drain Plug Gst.	1982-1993			2051	1
Throttle Body Gasket	1986-1993			G31132	1
Water Outlet Gasket	1986-1993			C30820	1
	1985		3.310" Bolt Center To Bolt Center	C25930	1
	1982-1984		Tuff-Cork	C24159TC	1
Water Pump Mount Gasket	1987-1993			K30947	1
	1982-1986			K24689	1

17 189 CID (3.1L) Chevrolet V6 Cyl, 3.504in./89mm (1990-1995) **17**

Part	Year	VIN	Model/Application	Part Number	Qty.
ENGINE GASKETS					
Head Set	1990-1995		(Head Bolts Not Included, Exhaust Pipe Gasket Not Included)	HS3549A	1
			(Contains Head Bolts, Exhaust Pipe Gasket Not Included)	HS3549WB5	1
Lower Set	1990-1995		(Requires Head Set To Make Full Set)	CS3549	1
Full Set	1990-1995		(Head Bolts Not Included, Exhaust Pipe Gasket Not Included)	FS3549A	1
Engine Kit Gasket Set	1990-1995		Cast Iron Cylinder Heads	95-3416VR	1
Cylinder Head Gasket	1990-1995		VR2000	3549	2
Cyl. Head Bolt Set	1990-1995		Rear Head	GS33223	1
			Front Head	GS33232	1
Valve Cover Set	1990-1995		Cork Rubber	VS50019	1
Valve Stem Seal, Exh.	1990-1995		(O-Ring Type)	B45229	6
Valve Stem Seal, Int.	1990-1995		(O-Ring Type)	B45229	6
			Fluoroelastomer	B45418	6
Manifold Set, Exhaust	1990-1995			MS15310	1
Manifold Set, Intake	1990-1995			MS15307	1
Oil Pan Set	1993-1995		Victo-Tech	OS32497	1
	1990-1992		Tuff-Cork	OS32476TC	1
			Victo-Tech	OS32495	1
Rear Main Seal Set	1990-1995			JV544	1
			Teflon	JV1633	1
Timing Cover Set	1991-1995			JV1149	1
	1990			JV1066	1
Timing Cover Gasket	1991-1995			T31259	1
	1990			T27635	1
Timing Cover Seal	1990-1995		3/8" Wide	49328	1
			(Lip Relocator Type) 1/2" Wide	65022	1
Harmonic Balancer Repair Sleeve	1990-1995		Use With Part Number A504 Nickel Plated Formed Steel, .013" Thickness	A228-2	1

MISCELLANEOUS GASKETS					
Air Cleaner Mount Gasket	1990-1995		Multi-Port Fuel Injection	G27098	1
Cam. Cover Gasket	1990-1995			H36978	1
Dist. Mounting Gasket	1990-1995			72214	1
E.G.R. Gasket	1990-1995			G31125	1
Exhaust Pipe Gasket	1990-1995		(Ring Type 'F'), Pipe To Manifold	F7210	1
Injector Nozzle O-Ring	1990-1995			GS33276	3
Oil Filter Adapt Gasket	1990-1995			B31606	1

General Motors Truck

17	189 CID (3.1L) Chevrolet V6 Cyl, 3.504in./89mm (1990-1995)	17
(cont.)		(cont.)

Part	Year	VIN	Model/Application	Part Number	Qty.
MISCELLANEOUS GASKETS (cont.)					
Oil Pan Drain Plug Gskt.	1990-1995			2051	1
Throttle Body Gasket	1990-1995			G31132	1
Water By-Pass Gasket	1990-1995			C31326	1
Water Outlet Gasket	1990-1995			C30820	1
Water Outlet Seal	1994-1995		Victo-Tech	C31156	1
Water Pump Mount Gasket	1990-1995			K30946	1

18	194 CID (3.2L) Chevrolet 6 Cyl, 3.563in./90.5mm (1964-1966)	18
-----------	--	-----------

Part	Year	VIN	Model/Application	Part Number	Qty.
ENGINE GASKETS					
Head Set	1964-1966		(Exhaust Pipe Gasket Not Included)	HS1185E	1
Lower Set	1964-1966		(Requires Head Set To Make Full Set)	CS1185	1
Full Set	1964-1966		(Exhaust Pipe Gasket Not Included)	FS1185E	1
Engine Kit Gasket Set	1964-1966		(Rear Main Seal Not Included), Use With Part Number JV728	95-3000VR	1
Cylinder Head Gasket	1964-1966		VR2000	3829	1
Valve Cover Set	1964-1966		Cork Rubber	VS39693	1
Valve Stem Seal, Exh.	1964-1966		(O-Ring Type)	B45229	6
Valve Stem Seal, Int.	1964-1966		(O-Ring Type)	B45229	6
Manifold Set, Int. & Exh.	1964-1966			MS16033X	1
Oil Pan Set	1964-1966		Cork Rubber	OS30988X	1
Rear Main Seal Set	1964-1966			JV728	1
Timing Cover Set	1964-1966		(Repair Sleeve Not Included)	JV862	1
			(Contains Repair Sleeve)	JV925	1
Harmonic Balancer Repair Sleeve	1964-1966		Ground Steel, .020" Thickness	66597RS	1
			Use With Part Number A504 Nickel Plated Formed Steel, .013" Thickness	A228	1

MISCELLANEOUS GASKETS					
Air Cleaner Mount Gasket	1964-1966		1 Barrel Carburetor	G25936	1
Carb. Mount Gasket	1964-1966		1 Barrel Carburetor	G5349AD	1
Dist. Mounting Gasket	1964-1966			B26466	1
Exhaust Pipe Gasket	1964-1966		(Ring Type 'C'), Pipe To Manifold	F17250	1
			(Ring Type 'B'), Pipe To Manifold	Sintered Metal F17250S	1
Fuel Pump Gasket	1964-1966			D27094	1
Oil Pan Drain Plug Gskt.	1964-1966			2051	1
Push Rod Cover Set	1964-1966		Cork Rubber	PS38113	1
Therm. Housing Gasket	1964-1966		Housing To Head	C26544	1
Water Outlet Gasket	1964-1966		(Universal Type)	C24109	1
				C25930	1
Water Pump Mount Gasket	1964-1966			K26545	1

19	200 CID (3.3L) L26 Chevrolet V6 Cyl, 3.500in./88.9mm (1978-1979)	19
-----------	---	-----------

Part	Year	VIN	Model/Application	Part Number	Qty.
ENGINE GASKETS					
Head Set	1978-1979		(Head Bolts Not Included, Exhaust Pipe Gasket Not Included)	HS3564VC	1
			(Head Bolts Not Included, Exhaust Pipe Gasket Not Included, Contains Beaded Steel Cylinder Head Gasket)	HS3925	1

LIGHT TRUCK

19 200 CID (3.3L) L26 Chevrolet V6 Cyl, 3.500in./88.9mm (1978-1979) **19**
(cont.) (cont.)

Part	Year	VIN	Model/Application	Part Number	Qty.
ENGINE GASKETS (cont.)					
Full Set	1978-1979		(Head Bolts Not Included, Exhaust Pipe Gasket Not Included)	FS3564VC	1
			(Head Bolts Not Included, Exhaust Pipe Gasket Not Included, Contains Beaded Steel Cylinder Head Gasket)	FS3925	1
Engine Kit Gasket Set	1978-1979			95-3063VR	1
Cylinder Head Gasket	1978-1979		VR2000	3564VC	2
			Beaded Steel	3925	2
			Nitroseal	3925SG	2
Cyl. Head Bolt Set	1978-1979			GS33286	2
Valve Cover Set	1978-1979		Cork Rubber	VS39766	1
			High Temperature Cork Rubber	VS39766H	1
Valve Stem Seal, Exh.	1978-1979		(O-Ring Type)	B45229	6
			(Shedder Type)	B45264	6
			(High Temperature)	B45779	6
Valve Stem Seal, Int.	1978-1979		(O-Ring Type)	B45229	6
			(Positive Type)	Fluoroelastomer B45418	6
Manifold Set, Exhaust	1978-1979			MS15251	1
Manifold Set, Intake	1978-1979			MS15224	1
Oil Pan Set	1978-1979		Cork Rubber	OS30934	1
			Tuff-Cork	OS30934TC	1
Rear Main Seal Set	1978-1979		(Lip Relocator Type)	JV1627	1
Timing Cover Set	1978-1979		(Repair Sleeve Not Included)	JV881	1
			(Repair Sleeve Not Included)	Tuff-Cork JV881TC	1
			(Contains Repair Sleeve)	JV926	1
Timing Cover Gasket	1978-1979			T27781	1
Timing Cover Seal	1978-1979		3/8" Wide	49328	1
			(Lip Relocator Type)	1/2" Wide 65022	1
Harmonic Balancer Repair Sleeve	1978-1979		Ground Steel, .020" Thickness	66597RS	1
			Use With Part Number A504 Nickel Plated Formed Steel, .013" Thickness	A228	1

MISCELLANEOUS GASKETS

Air Cleaner Mount Gasket	1978-1979		2 Barrel Carburetor	G26906	1
Carb. Mount Gasket	1978-1979		2 Barrel Carburetor	G26693	1
Dist. Mounting Gasket	1978-1979			B25934	1
E.G.R. Gasket	1978-1979			G17797	1
Exhaust Pipe Gasket	1978-1979		(Ring Type 'C'), Pipe To Manifold	F17250	1
			(Ring Type 'B'), Pipe To Manifold	Sintered Metal F17250S	1
Fuel Pump Gasket	1978-1979		Pump To Plate	D27094	1
			Pump To Plate	Tuff-Cork D27094TC	1
			Plate To Block	D27211	1
Oil Pan Drain Plug Gst.	1978-1979			2051	1
Oil Pump Shaft Retainer	1978-1979			H31354	1
Water Outlet Gasket	1978-1979		(Universal Type)	C24109	1
				C25930	1
Water Pump Mount Gasket	1978-1979			K25935	2

20 207 CID (3.4L) LA1 Chevrolet V6 Cyl, 3.622in./92mm (1996-2003) **20**

Part	Year	VIN	Model/Application	Part Number	Qty.
ENGINE GASKETS					
Head Set	2000-2003		(Exhaust Pipe Gasket Not Included)	HS4956A	1
	1996-1999		(Exhaust Pipe Gasket Not Included)	HS4956	1
Lower Set	1996-2003		(Requires Head Set To Make Full Set)	CS3793A	1

General Motors Truck

20 207 CID (3.4L) LA1 Chevrolet V6 Cyl, 3.622in./92mm (1996-2003) **20**
(cont.) (cont.)

Part Year VIN Model/Application Part Number Qty.

ENGINE GASKETS (cont.)

Cylinder Head Gasket	1996-2003		VR2000	4956	2
Cyl. Head Bolt Set	1996-2003		(1 Set Per Engine)	GS33377	1
Valve Cover Set	1996-2003		Victo-Tech	VS50173	1
			Victo-Tech	VS50174	2
Valve Stem Seal, Exh.	2000-2003			B45905	6
	1996-1999			B45829	6
Valve Stem Seal, Int.	2000-2003			B45905	6
	1996-1999			B45829	6
Manifold Set, Exhaust	1996-2003			MS16173	1
Manifold Set, Intake	1996-2003		(Contains Plenum Chamber Gasket)	MS16259	1
Plenum Chamber Gasket	1996-2003			MS17828	1
Oil Pan Set	1996-2003		Victo-Tech	OS32132	1
Rear Main Seal Set	1996-2003			JV544	1
			Teflon	JV1633	1
Timing Cover Gasket	1996-2003			T31259	1
Timing Cover Seal	1996-2003		3/8" Wide	49328	1
			1/2" Wide	65022	1

MISCELLANEOUS GASKETS

E.G.R. Gasket	2000-2003		Valve	G31582	1
	1996-1999		Pipe	G31412	1
				Valve	G31479
Exhaust Pipe Gasket	1997-2003		Pipe To Manifold	F31588	1
	1997-2002		Catalytic Converter	F31589	1
Injector Nozzle O-Ring	1996-1997			GS33276	3
Oil Filter Adapt Gasket	1996-2002			B31606	1
Oil Pan Drain Plug Gst.	1996-2003			B45828	1
Thermostat Seal	1996-2003		Victo-Tech	C31301	1
Throttle Body Gasket	2000-2003			G31581	1
	1996-1999			G31269	1
Water Pump Mount Gasket	1996-2003			K30946	1

21 216 CID (3.5L) Chevrolet 6 Cyl, 3.500in./88.9mm (1937-1953) **21**

Part Year VIN Model/Application Part Number Qty.

ENGINE GASKETS

Head Set	1937-1953			HS1050K	1
Full Set	1940-1953			FS1050K	1
Cylinder Head Gasket	1937-1953		VR2000	1050K	1
Valve Cover Set	1937-1953		Cork Rubber	VS39725	1
Valve Stem Seal, Exh.	1947-1953		(O-Ring Type)	B45229	6
Valve Stem Seal, Int.	1947-1953		(O-Ring Type)	B45229	6
Manifold Set, Int. & Exh.	1937-1953			MS12185X	1
Oil Pan Set	1940-1953		Cork Rubber	OS30902	1
Rear Main Seal Set	1940-1953			JV650	1
Timing Cover Set	1949-1953			JV754	1
	1940-1948			JV753	1
Timing Cover Seal	1937-1953		(Lip Relocator Type) 1/2" Wide	65022	1
	1937-1952		3/8" Wide	49328	1

MISCELLANEOUS GASKETS

Carb. Mount Gasket	1950-1952		Double Duty, 1 Barrel Carburetor	G17969	1
Exhaust Pipe Gasket	1940-1953		(Flange Type), Pipe To Manifold	F5436AK	3
Fuel Pump Bowl Gasket	1940-1953			D34545	1

LIGHT TRUCK

General Motors Truck

21 (cont.)	216 CID (3.5L) Chevrolet 6 Cyl, 3.500in./88.9mm (1937-1953)				21 (cont.)
----------------------	--	--	--	--	----------------------

<i>Part</i>	<i>Year</i>	<i>VIN</i>	<i>Model/Application</i>	<i>Part Number</i>	<i>Qty.</i>
MISCELLANEOUS GASKETS (cont.)					
Fuel Pump Gasket	1937-1953			D27094	1
Oil Pan Drain Plug Gst.	1940-1953			2051	1
Push Rod Cover Seal	1937-1953			H34510	6
Push Rod Cover Set	1937-1953		Cork Rubber	PS39840	1
Therm. Housing Gasket	1937-1953			C24529	1
U Joint Housing Gasket	1939-1950			GS33066	1
Water Outlet Gasket	1937-1953			C24109	1
Water Pump Mount Gasket	1940-1953			K25739	1

22	228 CID (3.7L) General Motors 6 Cyl, 3.563in./90.5mm (1939-1953)				22
-----------	---	--	--	--	-----------

<i>Part</i>	<i>Year</i>	<i>VIN</i>	<i>Model/Application</i>	<i>Part Number</i>	<i>Qty.</i>
ENGINE GASKETS					
Head Set	1939-1953			HS1935S	1
Full Set	1939-1953			FS1935S	1
Cylinder Head Gasket	1939-1953			1935S	1
Valve Cover Set	1939-1953		Cork Rubber	VS39729	1
Valve Stem Seal, Exh.	1939-1953		(O-Ring Type)	B45229	6
Valve Stem Seal, Int.	1939-1953		(O-Ring Type)	B45229	6
Manifold Set, Int. & Exh.	1939-1953			MS12146	1
Oil Pan Set	1939-1953		(Oil Pan Is Fastened With Self Tapping Screws) Cork Rubber	OS30901	1
Rear Main Seal Set	1939-1953			JV658	1
Timing Cover Set	1939-1953			JV786	1
Timing Cover Seal	1939-1953		3/8" Wide	49328	1
			(Lip Relocator Type) 1/2" Wide	65022	1

MISCELLANEOUS GASKETS					
Air Cleaner Mount Gasket	1939-1953		1 Barrel Carburetor	G25936	1
Exhaust Pipe Gasket	1939-1953		(Flange Type), Pipe To Manifold	F17370	1
Fuel Pump Gasket	1939-1953			D27094	1
Push Rod Cover Set	1939-1953			PS39744	1
Rocker Shaft, Front Support Bracket	1939-1953			2014A	1
U Joint Housing Gasket	1939-1950			GS33066	1
Water Outlet Gasket	1939-1953		(Universal Type)	C24109	1
				C25930	1

23	229 CID (3.8L) LC3 Chevrolet V6 Cyl, 3.736in./95mm (1980-1984)				23
-----------	---	--	--	--	-----------

<i>Part</i>	<i>Year</i>	<i>VIN</i>	<i>Model/Application</i>	<i>Part Number</i>	<i>Qty.</i>
ENGINE GASKETS					
Head Set	1980-1984		(Head Bolts Not Included, Exhaust Pipe Gasket Not Included, Contains Beaded Steel Cylinder Head Gasket)	HS3564BS	1
			(Head Bolts Not Included, Exhaust Pipe Gasket Not Included, Contains VR2000 Cylinder Head Gasket)	HS3564VC	1
Full Set	1980-1984		(Head Bolts Not Included, Exhaust Pipe Gasket Not Included, Contains Beaded Steel Cylinder Head Gasket)	FS3564BS	1
			(Head Bolts Not Included, Exhaust Pipe Gasket Not Included, Contains VR2000 Cylinder Head Gasket)	FS3564VC	1
Engine Kit Gasket Set	1980-1984			95-3063VR	1
Cylinder Head Gasket	1980-1984		Beaded Steel	3564BS	2
			VR2000	3564VC	2

LIGHT TRUCK

General Motors Truck

23 229 CID (3.8L) LC3 Chevrolet V6 Cyl, 3.736in./95mm (1980-1984) **23**
 (cont.) (cont.)

Part Year VIN Model/Application Part Number Qty.

ENGINE GASKETS (cont.)

Cylinder Head Gasket (cont.)	1980-1984		Nitroseal	3925SG	2
Cyl. Head Bolt Set	1980-1984			GS33286	2
Valve Cover Set	1980-1984		Cork Rubber	VS39766	1
			High Temperature Cork Rubber	VS39766H	1
Valve Stem Seal, Exh.	1980-1984	(O-Ring Type)		B45229	6
		(Shedder Type)		B45264	6
		(High Temperature)		B45779	6
Valve Stem Seal, Int.	1980-1984	(O-Ring Type)		B45229	6
		(Positive Type)	Fluoroelastomer	B45418	6
Manifold Set, Exhaust	1980-1984			MS15251	1
Manifold Set, Intake	1980-1984			MS15224	1
Oil Pan Set	1980-1984		Cork Rubber	OS30934	1
			Tuff-Cork	OS30934TC	1
Rear Main Seal Set	1980-1984	(Lip Relocator Type)		JV1627	1
Timing Cover Set	1980-1984	(Repair Sleeve Not Included)		JV881	1
		(Repair Sleeve Not Included)	Tuff-Cork	JV881TC	1
		(Contains Repair Sleeve)		JV926	1
Timing Cover Gasket	1980-1984			T27781	1
Timing Cover Seal	1980-1984		3/8" Wide	49328	1
		(Lip Relocator Type)	1/2" Wide	65022	1
Harmonic Balancer Repair Sleeve	1980-1984		Ground Steel, .020" Thickness	66597RS	1
		Use With Part Number A504	Nickel Plated Formed Steel, .013" Thickness	A228	1

MISCELLANEOUS GASKETS

Air Cleaner Mount Gasket	1980-1984		2 Barrel Carburetor	G26906	1
Carb. Mount Gasket	1980-1984		2 Barrel Carburetor	G26693	1
Dist. Mounting Gasket	1980-1984			B25934	1
E.G.R. Gasket	1980-1984			G17797	1
Exhaust Pipe Gasket	1980-1984	(Ring Type 'C'), Pipe To Manifold		F17250	1
		(Ring Type 'B'), Pipe To Manifold	Sintered Metal	F17250S	1
Fuel Pump Gasket	1980-1984	Pump To Plate		D27094	1
		Pump To Plate	Tuff-Cork	D27094TC	1
		Plate To Block		D27211	1
Oil Pan Drain Plug Gst.	1980-1984			2051	1
Oil Pump Shaft Retainer	1980-1984			H31354	1
Water Outlet Gasket	1980-1984	(Universal Type)		C24109	1
				C25930	1
Water Pump Mount Gasket	1980-1984			K25935	2

24 230 CID (3.8L) Chevrolet 6 Cyl, 3.875in./98.4mm (1963-1969) **24**

Part Year VIN Model/Application Part Number Qty.

ENGINE GASKETS

Head Set	1963-1969		(Exhaust Pipe Gasket Not Included)	HS1185E	1
Lower Set	1963-1969		(Requires Head Set To Make Full Set)	CS1185	1
Full Set	1963-1969		(Exhaust Pipe Gasket Not Included)	FS1185E	1
Engine Kit Gasket Set	1968-1969			95-3000VR	1
	1963-1967		(Rear Main Seal Not Included), Use With Part Number JV728	95-3000VR	1
Cylinder Head Gasket	1963-1969		VR2000	3829	1
Valve Cover Set	1963-1969		Cork Rubber	VS39693	1
Valve Stem Seal, Exh.	1963-1969	(O-Ring Type)		B45229	6

LIGHT TRUCK

24 230 CID (3.8L) Chevrolet 6 Cyl, 3.875in./98.4mm (1963-1969) **24**
(cont.) (cont.)

Part	Year	VIN	Model/Application	Part Number	Qty.
ENGINE GASKETS (cont.)					
Valve Stem Seal, Int.	1963-1969		(O-Ring Type)	B45229	6
Manifold Gasket	1963-1969		Intake To Exhaust	B7354	1
Manifold Set, Int. & Exh.	1963-1969			MS16033X	1
Oil Pan Set	1963-1969		<i>Cork Rubber</i>	OS30988X	1
Rear Main Seal Set	1968-1969		Except Distributor Boss Stamped F0623 With "R" Under Date, (Lip Relocator Type)	JV1627	1
	1963-1968		Distributor Boss Stamped F0623 With "R" Under Date	JV728	1
Timing Cover Set	1963-1969		(Repair Sleeve Not Included)	JV862	1
			(Contains Repair Sleeve)	JV925	1
Timing Cover Gasket	1963-1969			T14744	1
Timing Cover Seal	1963-1969		<i>3/8" Wide</i>	49328	1
			(Lip Relocator Type) <i>1/2" Wide</i>	65022	1
Harmonic Balancer Repair Sleeve	1963-1969		<i>Ground Steel, .020" Thickness</i>	66597RS	1
			Use With Part Number A504 <i>Nickel Plated Formed Steel, .013" Thickness</i>	A228	1

MISCELLANEOUS GASKETS

Air Cleaner Mount Gasket	1963-1969		1 Barrel Carburetor	G25936	1
Carb. Mount Gasket	1963-1969		1 Barrel Carburetor	G5349AD	1
Exhaust Pipe Gasket	1963-1969		(Ring Type 'C'), Pipe To Manifold	F17250	1
			(Ring Type 'B'), Pipe To Manifold <i>Sintered Metal</i>	F17250S	1
Fuel Pump Gasket	1963-1969			D27094	1
	1963-1965		<i>Tuff-Cork</i>	D27094TC	1
Oil Pan Drain Plug Gst.	1963-1969			2051	1
Push Rod Cover Set	1963-1969		<i>Cork Rubber</i>	PS38113	1
Therm. Housing Gasket	1963-1969		Housing To Head	C26544	1
Water Outlet Gasket	1963-1969		Except Cab Over Engine	C24109	1
			Cab Over Engine	C26565	1
Water Pump Mount Gasket	1963-1969			K26545	1

25 231 CID (3.8L) Carbureted Buick V6 Cyl, 3.800in./96.5mm (1978-1984) **25**

Part	Year	VIN	Model/Application	Part Number	Qty.
ENGINE GASKETS					
Head Set	1979-1984		(Contains Overbore Head Gasket, Exhaust Pipe Gasket Not Included, Intake Manifold Gasket Not Included)	HS3741	1
			(Exhaust Pipe Gasket Not Included, Intake Manifold Gasket Not Included)	HS5706	1
	1978		Requires Exhaust Manifold Gasket, (Contains Overbore Head Gasket, Exhaust Pipe Gasket Not Included, Intake Manifold Gasket Not Included, Exhaust Manifold Gasket Not Included)	HS3741	1
			Requires Exhaust Manifold Gasket, (Exhaust Pipe Gasket Not Included, Intake Manifold Gasket Not Included, Exhaust Manifold Gasket Not Included)	HS5706	1
Full Set	1979-1984		(Contains Overbore Head Gasket, Exhaust Pipe Gasket Not Included, Intake Manifold Gasket Not Included)	FS3741	1
			(Exhaust Pipe Gasket Not Included, Intake Manifold Gasket Not Included)	FS5706	1
	1978		Requires Exhaust Manifold Gasket, (Contains Overbore Head Gasket, Exhaust Pipe Gasket Not Included, Intake Manifold Gasket Not Included, Exhaust Manifold Gasket Not Included)	FS3741	1
			Requires Exhaust Manifold Gasket, (Exhaust Pipe Gasket Not Included, Intake Manifold Gasket Not Included, Exhaust Manifold Gasket Not Included)	FS5706	1

General Motors Truck

25 231 CID (3.8L) Carbureted Buick V6 Cyl, 3.800in./96.5mm (1978-1984) **25**
 (cont.) (cont.)

Part Year VIN Model/Application Part Number Qty.

ENGINE GASKETS (cont.)

Engine Kit Gasket Set	1984		Aluminum Intake Manifold, (Intake Manifold Gasket Not Included, Contains 2 Piece Rope Rear Main Seal, Optional 2 Piece Rubber Rear Main Seal Not Included), Use With Part Numbers MS15960, JV742R	95-3420VR	1	
			Cast Iron Intake Manifold, (Intake Manifold Gasket Not Included, Contains 2 Piece Rope Rear Main Seal, Optional 2 Piece Rubber Rear Main Seal Not Included), Use With Part Numbers MS15958, JV742R	95-3420VR	1	
	1983		(Rear Main Seal Not Included, Intake Manifold Gasket Not Included, Contains 2 Piece Rope Rear Main Seal, Optional 2 Piece Rubber Rear Main Seal Not Included), Use With Part Numbers MS15958, JV742R	95-3420VR	1	
	1982		Thru 11/30/82, (Intake Manifold Gasket Not Included, Contains 2 Piece Rope Rear Main Seal, Optional 2 Piece Rubber Rear Main Seal Not Included), Use With Part Numbers MS15958, JV742R	95-3402VR	1	
			From 12/1/82, (Rear Main Seal Not Included, Intake Manifold Gasket Not Included, Contains 2 Piece Rope Rear Main Seal, Optional 2 Piece Rubber Rear Main Seal Not Included), Use With Part Numbers MS15958, JV742R	95-3420VR	1	
	1979-1981		(Intake Manifold Gasket Not Included, Contains 2 Piece Rope Rear Main Seal, Optional 2 Piece Rubber Rear Main Seal Not Included), Use With Part Numbers MS15958, JV742R	95-3402VR	1	
	1978		(Intake Manifold Gasket Not Included, Contains 2 Piece Rope Rear Main Seal, Optional 2 Piece Rubber Rear Main Seal Not Included), Use With Part Numbers MS15948, JV742R	95-3402VR	1	
Cylinder Head Gasket	1978-1984		<i>VR2000</i>	5819	2	
			Overbore	<i>VR2000</i>	5820	2
			Overbore	<i>Nitroseal</i>	5820SG	2
Valve Cover Set	1978-1984		<i>Cork Rubber</i>	VS39763	1	
			<i>High Temperature Cork Rubber</i>	VS39763H	1	
			<i>Victo-Tech</i>	VS39763R	1	
Valve Stem Seal, Int.	1978-1984			B45497	6	
Manifold Set, Exhaust	1979-1984			MS15327	1	
	1978		(Not Contained In Head Or Full Set)	MS15214	1	
Manifold Set, Intake	1984		Cast Iron Intake Manifold	MS15958	1	
			Aluminum Intake Manifold	MS15960	1	
	1979-1983			MS15958	1	
	1978			MS15948	1	
Oil Pan Set	1978-1984		<i>Cork Rubber</i>	OS30668	1	
			<i>Tuff-Cork</i>	OS30668TC	1	
Rear Main Seal Set	1978-1984		<i>Rope Packing</i>	JV742	1	
			<i>Molded Rubber</i>	JV742R	1	
Timing Cover Set	1978-1984		(Contains Rope Packing)	JV906	1	
			(Contains Superflex Seal)	JV1051SF	1	
Timing Cover Gasket	1978-1984			T27960	1	
Timing Cover Seal	1978-1984		(Superflex)	65025SF	1	
Harmonic Balancer Repair Sleeve	1978-1984		<i>Ground Steel, .020" Thickness</i>	66597RS	1	
			Use With Part Number A504 <i>Nickel Plated Formed Steel, .013" Thickness</i>	A228	1	

MISCELLANEOUS GASKETS

Air Cleaner Mount Gasket	1979-1984		2 Barrel Carburetor	G26906	1
	1978		2 Barrel Carburetor	G26617	1
Carb. Mount Gasket	1979-1982		2 Barrel Carburetor	G26696	1
	1978		2 Barrel Carburetor	G26712	1
Dist. Mounting Gasket	1978-1984			72215	1
E.G.R. Gasket	1978-1984			G26315	1

LIGHT TRUCK

25 231 CID (3.8L) Carbureted Buick V6 Cyl, 3.800in./96.5mm (1978-1984) **25**
(cont.) (cont.)

Part	Year	VIN	Model/Application	Part Number	Qty.
MISCELLANEOUS GASKETS (cont.)					
Exhaust Pipe Gasket	1978-1984		(Ring Type 'E'), Pipe To Manifold	F7394	1
Fuel Pump Gasket	1978-1984			D27094	1
				<i>Tuff-Cork</i> D27094TC	1
Oil Pan Drain Plug Gst.	1978-1984			2051	1
Oil Pump Cover Gasket	1982-1984			B45577	1
	1979-1981			B45578	1
	1978		2nd Design	B45578	1
			1st Design	B45579	1
Water Outlet Gasket	1978-1984			C26515	1
Water Pump Mount Gasket	1978-1984			K27571	1

26 231 CID (3.8L) Fuel Injected Buick V6 Cyl, 3.800in./96.5mm (1992-1995) **26**

Part	Year	VIN	Model/Application	Part Number	Qty.
------	------	-----	-------------------	-------------	------

ENGINE GASKETS					
Head Set	1992-1995		(Head Bolts Not Included, Exhaust Pipe Gasket Not Included, Plenum Chamber Gasket Not Included), Use With Part Number MS14638	HS5768W	1
			(Contains Head Bolts, Exhaust Pipe Gasket Not Included, Plenum Chamber Gasket Not Included), Use With Part Number MS14638	HS5768WB1	1
Lower Set	1995		(Oil Pan Gasket Not Included)	CS5828	1
Full Set	1992-1994		(Head Bolts Not Included, Exhaust Pipe Gasket Not Included)	FS5768W	1
Engine Kit Gasket Set	1992-1994			95-3164VR	1
Cylinder Head Gasket	1992-1995		<i>Nitroseal</i>	5768	2
Cyl. Head Bolt Set	1992-1995			GS33233	2
Valve Cover Set	1992-1995		<i>Victo-Tech</i>	VS50052	1
			(Single Valve Cover) <i>Victo-Tech</i>	VS50123	2
Valve Stem Seal, Exh.	1992-1995			B45591	6
Valve Stem Seal, Int.	1992-1995			B45484	6
Manifold Set, Exhaust	1992-1995			MS15569	1
Manifold Set, Intake	1992-1995		(Plenum Chamber Gasket Not Included), Use With Part Number MS14638 <i>Nitroseal</i>	MS15634	1
Plenum Chamber Gasket	1992-1995			MS14638	1
Oil Pan Set	1995		<i>Victo-Tech</i>	OS32147	1
	1992-1994		<i>Victo-Tech</i>	OS32022	1
Rear Main Seal Set	1992-1995			JV599	1
Crank Repair Sleeve	1992-1995		<i>Nickel Plated Formed Steel, .013" Thickness</i>	A353	1
Timing Cover Set	1992-1995			JV1114	1
Timing Cover Seal	1992-1995			48069	1
Harmonic Balancer Repair Sleeve	1992-1995		<i>Nickel Plated Formed Steel, .013" Thickness</i>	A237	1

MISCELLANEOUS GASKETS					
E.G.R. Gasket	1994-1995			G31266	1
	1992-1993			G31264	1
Exhaust Pipe Gasket	1993-1995		(Ring Type 'F'), Crossover Pipe	F7515	1
	1992-1995		(Ring Type 'F'), Pipe To Manifold	F7523	1
	1992		(Ring Type 'F'), Crossover Pipe	F7514	1
Injector Nozzle O-Ring	1992-1994			GS33276	3
Manifold By-Pass Gasket	1994			C31272	1
Oil Pan Drain Plug Gst.	1995			B45828	1
	1992-1994			2051	1

General Motors Truck

26 231 CID (3.8L) Fuel Injected Buick V6 Cyl, 3.800in./96.5mm (1992-1995) **26**
 (cont.) (cont.)

Part	Year	VIN	Model/Application	Part Number	Qty.
MISCELLANEOUS GASKETS (cont.)					
Thermostat O-Ring	1992-1995		<i>Victo-Tech</i>	C31227	1
Throttle Body Gasket	1993-1995			G31271	1
	1992			G31270	1
Valve Cover Grommet	1992-1995			GS33304	1
Water Outlet Gasket	1992-1995			C31271	1
Water Pump Mount Gasket	1992-1995			K30793	1

27 235 CID (3.9L) Chevrolet 6 Cyl, 3.563in./90.5mm (1953-1962) **27**

Part	Year	VIN	Model/Application	Part Number	Qty.	
ENGINE GASKETS						
Head Set	1954-1962			HS1090KX	1	
	1953			HS1090K	1	
Full Set	1956-1962			FS1090KY	1	
	1955		Late	FS1090KY	1	
	1954-1955		Early	FS1090KX	1	
	1953			FS1090K	1	
Engine Kit Gasket Set	1953-1962			95-3010VR	1	
Cylinder Head Gasket	1953-1962		<i>VR2000</i>	1090K	1	
Valve Cover Set	1954-1962		<i>Cork Rubber</i>	VS39687	1	
	1953		<i>Cork Rubber</i>	VS39725	1	
Valve Stem Seal, Exh.	1953-1962		(O-Ring Type)	B45229	6	
Valve Stem Seal, Int.	1953-1962		(O-Ring Type)	B45229	6	
Manifold Gasket	1953-1962		Intake To Exhaust	B17897	1	
Manifold Set, Int. & Exh.	1953-1962			MS12185X	1	
Oil Pan Set	1956-1962		<i>Cork Rubber</i>	OS31116	1	
	1955		Early	<i>Cork Rubber</i>	OS30902	1
			Late	<i>Cork Rubber</i>	OS31116	1
	1953-1954		<i>Cork Rubber</i>	OS30902	1	
Rear Main Seal Set	1953-1962		<i>Rope Packing</i>	JV650	1	
			<i>Molded Rubber</i>	JV737	1	
Timing Cover Set	1953-1962			JV754	1	
Timing Cover Seal	1953-1962		<i>3/8" Wide</i>	49328	1	
			(Lip Relocator Type) <i>1/2" Wide</i>	65022	1	
Harmonic Balancer Repair Sleeve	1953-1962		<i>Ground Steel, .020" Thickness</i>	66597RS	1	
			Use With Part Number A504 <i>Nickel Plated Formed Steel, .013" Thickness</i>	A228	1	

MISCELLANEOUS GASKETS					
Air Cleaner Mount Gasket	1953-1962		1 Barrel Carburetor	G25936	1
Carb. Mount Gasket	1960-1962		Except Double Duty, Governor, 1 Barrel Carburetor	G7117	1
			Except Double Duty, Governor	G7117	1
			Synchromesh, 1 Barrel Carburetor	G17969	1
			Synchromesh	G17969	1
	1958-1962		Except Double Duty, Governor, 1 Barrel Carburetor	G7117	1
			Synchromesh, 1 Barrel Carburetor	G17969	1
	1958-1959		Synchromesh	G17969	1
	1956-1959		Except Double Duty, Governor	G7117	1
	1956-1957		Synchromesh, 1 Barrel Carburetor	G17969	1
			Synchromesh	G17969	1
	1955-1957		Except Double Duty, Governor, 1 Barrel Carburetor	G7117	1
			Cab Over Engine, Synchromesh, 1 Barrel Carburetor	G17969	1
	1953-1957		Except Cab Over Engine, Except Double Duty, Except School Bus, Governor, 1 Barrel Carburetor	G7117	1
1956		Except Double Duty, Governor	G7117	1	

LIGHT TRUCK

27 235 CID (3.9L) Chevrolet 6 Cyl, 3.563in./90.5mm (1953-1962) **27**
(cont.) (cont.)

Part	Year	VIN	Model/Application	Part Number	Qty.
MISCELLANEOUS GASKETS (cont.)					
Carb. Mount Gasket (cont.)	1954-1955		Cab Over Engine, 1 Barrel Carburetor	G17969	1
	1953-1955		Except Cab Over Engine, Except Double Duty, Except School Bus, Governor	G7117	1
			Except Cab Over Engine, Except Double Duty, Except School Bus, Governor, 1 Barrel Carburetor	G7117	1
			Except Cab Over Engine, Except Double Duty, Except School Bus, Governor	G7117	1
			Cab Over Engine, School Bus, 1 Barrel Carburetor	G17969	1
			Cab Over Engine, School Bus	G17969	1
	1953		Cab Over Engine, School Bus, 1 Barrel Carburetor	G17969	1
Exhaust Pipe Gasket	1953-1962		(Flange Type), Pipe To Manifold	F5436AK	3
Fuel Pump Bowl Gasket	1953-1962			D34545	1
Fuel Pump Gasket	1953-1962			D27094	1
			<i>Tuff-Cork</i>	D27094TC	1
Oil Pan Drain Plug Gst.	1953-1962			2051	1
Push Rod Cover Set	1953-1962			<i>Cork Rubber</i> PS39685	1
Therm. Housing Gasket	1953-1962			C24529	1
Water Outlet Gasket	1953-1962		(Universal Type)	C24109	1
				C25930	1
Water Pump Gasket	1954-1962			K27069	1
	1953			K25739	1
Water Pump Mount Gasket	1954-1962			K27069	1
	1953			K25739	1

28 236 CID (3.9L) OHV General Motors 6 Cyl, 3.562in./90.5mm (1942-1946) **28**

Part	Year	VIN	Model/Application	Part Number	Qty.
ENGINE GASKETS					
Head Set	1942-1946			HS1935S	1
Full Set	1942-1946			FS1935S	1
Cylinder Head Gasket	1942-1946			1935S	1
Valve Cover Set	1942-1946			<i>Cork Rubber</i> VS39729	1
Valve Stem Seal, Exh.	1942-1946		(O-Ring Type)	B45229	6
Valve Stem Seal, Int.	1942-1946		(O-Ring Type)	B45229	6
Manifold Set, Int. & Exh.	1942-1946			MS12146	1
Oil Pan Set	1942-1946		(Oil Pan Is Fastened With Self Tapping Screws)	<i>Cork Rubber</i> OS30901	1
Rear Main Seal Set	1942-1946			JV658	1
Timing Cover Set	1942-1946			JV786	1
Timing Cover Seal	1942-1946			<i>3/8" Wide</i> 49328	1
			(Lip Relocator Type)	<i>1/2" Wide</i> 65022	1

MISCELLANEOUS GASKETS					
Air Cleaner Mount Gasket	1942-1946		1 Barrel Carburetor	G25936	1
Exhaust Pipe Gasket	1942-1946		(Flange Type), Pipe To Manifold	F17370	1
Fuel Pump Gasket	1942-1946			D27094	1
			<i>Tuff-Cork</i>	D27094TC	1
Push Rod Cover Set	1942-1946			PS39744	1
Rocker Shaft, Front Support Bracket	1942-1946			2014A	1
U Joint Housing Gasket	1942-1946			GS33066	1
Water Outlet Gasket	1942-1946		(Universal Type)	C24109	1

General Motors Truck

28 (cont.)	236 CID (3.9L) OHV General Motors 6 Cyl, 3.562in./90.5mm (1942-1946)				28 (cont.)
----------------------	---	--	--	--	----------------------

Part	Year	VIN	Model/Application	Part Number	Qty.
------	------	-----	-------------------	-------------	------

MISCELLANEOUS GASKETS (cont.)

Water Outlet Gasket (cont.)	1942-1946			C25930	1
--------------------------------	-----------	--	--	--------	---

29	248 CID (4.1L) General Motors 6 Cyl, 3.719in./94.5mm (1939-1955)				29
-----------	---	--	--	--	-----------

Part	Year	VIN	Model/Application	Part Number	Qty.
------	------	-----	-------------------	-------------	------

ENGINE GASKETS

Head Set	1939-1955			HS1935S	1
Full Set	1939-1955			FS1935S	1
Cylinder Head Gasket	1939-1955			1935S	1
Valve Cover Set	1939-1955		Cork Rubber	VS39729	1
Valve Stem Seal, Int.	1939-1955		(O-Ring Type)	B45229	6
Manifold Set, Int. & Exh.	1939-1955			MS12146	1
Oil Pan Set	1939-1955		(Oil Pan Is Fastened With Self Tapping Screws) Cork Rubber	OS30901	1
Rear Main Seal Set	1939-1955			JV658	1
Timing Cover Set	1955			JV809	1
	1939-1954			JV786	1
Timing Cover Seal	1939-1955		3/8" Wide	49328	1
			(Lip Relocator Type) 1/2" Wide	65022	1

MISCELLANEOUS GASKETS

Exhaust Pipe Gasket	1939-1955		(Flange Type), Pipe To Manifold	F17370	1
Fuel Pump Gasket	1939-1955			D27094	1
			Tuff-Cork	D27094TC	1
Push Rod Cover Set	1939-1955			PS39744	1
Rocker Shaft, Front Support Bracket	1939-1955			2014A	1
U Joint Housing Gasket	1939-1953			GS33066	1
Water Outlet Gasket	1939-1955		(Universal Type)	C24109	1
				C25930	1

30	250 CID (4.1L) Chevrolet 6 Cyl, 3.875in./98.4mm (1966-1984)				30
-----------	--	--	--	--	-----------

Part	Year	VIN	Model/Application	Part Number	Qty.
------	------	-----	-------------------	-------------	------

ENGINE GASKETS

Head Set	1979-1984		(Exhaust Pipe Gasket Not Included)	HS3829X	1
	1975-1978		Separate Head And Intake Manifold, (Exhaust Pipe Gasket Not Included)	HS1185E	1
			Integral Head And Intake Manifold, (Exhaust Pipe Gasket Not Included)	HS3829	1
	1966-1974		(Exhaust Pipe Gasket Not Included)	HS1185E	1
Lower Set	1966-1979		24 Bolt Oil Pan, (Requires Head Set To Make Full Set)	CS1185	1
Full Set	1980-1984		(Exhaust Pipe Gasket Not Included, 16 Bolt Oil Pan Gasket Not Included)	FS3829X	1
	1979		24 Bolt Oil Pan, (Exhaust Pipe Gasket Not Included)	FS3829X	1
	1975-1978		24 Bolt Oil Pan, Separate Head And Intake Manifold, (Exhaust Pipe Gasket Not Included)	FS1185E	1
			24 Bolt Oil Pan, Integral Head And Intake Manifold, (Exhaust Pipe Gasket Not Included)	FS3829	1
	1966-1974		24 Bolt Oil Pan, (Exhaust Pipe Gasket Not Included)	FS1185E	1
Engine Kit Gasket Set	1980-1984		(16 Bolt Oil Pan Gasket Not Included)	95-3400VR	1
	1979		24 Bolt Oil Pan	95-3400VR	1
	1975-1978		Separate Head And Intake Manifold	95-3000VR	1
			Integral Head And Intake Manifold	95-3044VR	1
	1968-1974			95-3000VR	1
1966-1967		(Rear Main Seal Not Included), Use With Part Number JV728	95-3000VR	1	

LIGHT TRUCK

30 (cont.)	250 CID (4.1L) Chevrolet 6 Cyl, 3.875in./98.4mm (1966-1984)				30 (cont.)
----------------------	--	--	--	--	----------------------

Part	Year	VIN	Model/Application	Part Number	Qty.
------	------	-----	-------------------	-------------	------

ENGINE GASKETS (cont.)

Cylinder Head Gasket	1979-1984			3829X	1	
	1966-1978		VR2000	3829	1	
Valve Cover Set	1979-1984		Cork Rubber	VS39755	1	
	1975-1978		Separate Head And Intake Manifold	Cork Rubber	VS39693	1
				Integral Head And Intake Manifold	Cork Rubber	VS39755
	1966-1974			Cork Rubber	VS39693	1
Valve Stem Seal, Exh.	1966-1984		(O-Ring Type)	B45229	6	
Valve Stem Seal, Int.	1966-1984		(O-Ring Type)	B45229	6	
Manifold Gasket	1966-1978		Intake To Exhaust	B7354	1	
Manifold Set, Exhaust	1979-1984			MS15753	1	
	1975-1978		Integral Head And Intake Manifold	MS15750	1	
Manifold Set, Int. & Exh.	1966-1978			MS16033X	1	
Oil Pan Set	1966-1984		24 Bolt Oil Pan	Cork Rubber	OS30988X	1
Rear Main Seal Set	1969-1984		(Lip Relocator Type)	JV1627	1	
	1968		Distributor Boss Stamped F0623 With "R" Under Date	JV728	1	
				Except Distributor Boss Stamped F0623 With "R" Under Date, (Lip Relocator Type)	JV1627	1
	1966-1967			JV728	1	
Timing Cover Set	1966-1984		(Repair Sleeve Not Included)	JV862	1	
			(Contains Repair Sleeve)	JV925	1	
Timing Cover Gasket	1966-1984			T14744	1	
Timing Cover Seal	1966-1984			3/8" Wide	49328	1
			(Lip Relocator Type)	1/2" Wide	65022	1
Harmonic Balancer Repair Sleeve	1966-1984			Ground Steel, .020" Thickness	66597RS	1
			Use With Part Number A504	Nickel Plated Formed Steel, .013" Thickness	A228	1

MISCELLANEOUS GASKETS

Air Cleaner Mount Gasket	1979-1984		2 Barrel Carburetor	G26170	1	
	1974-1978		1 Barrel Carburetor	G25936	1	
	1972-1973		1 Barrel Carburetor	G26617	1	
	1966-1971		1 Barrel Carburetor	G25936	1	
Carb. Mount Gasket	1979-1984		2 Barrel Carburetor	G26773	1	
	1973-1978		1 Barrel Carburetor	G14142	1	
	1967-1972		1 Barrel Carburetor	G5349AD	1	
	1966		Except Forward Control, 1 Barrel Carburetor, Governor To Carburetor	G31381	1	
Dist. Mounting Gasket	1966-1984			B26466	1	
E.G.R. Gasket	1979-1984			G17797	1	
	1975-1978		Integral Head And Intake Manifold	G17797	1	
				Separate Head And Intake Manifold	G26338	1
	1973-1974			G26338	1	
Exhaust Pipe Gasket	1966-1984		(Ring Type 'C'), Pipe To Manifold	F17250	1	
			(Ring Type 'B'), Pipe To Manifold	Sintered Metal	F17250S	1
Fuel Pump Gasket	1966-1984			D27094	1	
				Tuff-Cork	D27094TC	1
Oil Pan Drain Plug Gst.	1966-1984			2051	1	
Push Rod Cover Set	1966-1984			Cork Rubber	PS38113	1
Therm. Housing Gasket	1966-1984		Housing To Head	C26544	1	
Water Outlet Gasket	1979-1984			C24167	1	
	1966-1978		(Universal Type)	C24109	1	
					C25930	1
Water Pump Mount Gasket	1966-1984			K26545	1	

General Motors Truck

31 261 CID (4.3L) Chevrolet 6 Cyl, 3.750in./95.3mm (1962)

31

Part	Year	VIN	Model/Application	Part Number	Qty.
ENGINE GASKETS					
Head Set	1962			HS3210	1
Full Set	1962			FS3210	1
Cylinder Head Gasket	1962		VR2000	3210	1
Valve Cover Set	1962		Cork Rubber	VS39687	1
Valve Stem Seal, Exh.	1962		(O-Ring Type)	B45229	6
Valve Stem Seal, Int.	1962		(O-Ring Type)	B45229	6
Manifold Gasket	1962		Intake To Exhaust	B17897	1
Manifold Set, Int. & Exh.	1962			MS12185X	1
Oil Pan Set	1962		Cork Rubber	OS31116	1
Rear Main Seal Set	1962		Rope Packing	JV650	1
Timing Cover Set	1962			JV754	1
Timing Cover Seal	1962		3/8" Wide	49328	1
			(Lip Relocator Type) 1/2" Wide	65022	1
Harmonic Balancer Repair Sleeve	1962		Ground Steel, .020" Thickness	66597RS	1
			Use With Part Number A504 Nickel Plated Formed Steel, .013" Thickness	A228	1

MISCELLANEOUS GASKETS

Air Cleaner Mount Gasket	1962		1 Barrel Carburetor	G25936	1
Carb. Mount Gasket	1962		Except Double Duty, Governor, 1 Barrel Carburetor	G7117	1
			Synchromesh, 1 Barrel Carburetor	G17969	1
Exhaust Pipe Gasket	1962		(Flange Type), Pipe To Manifold	F5436AK	3
Fuel Pump Gasket	1962			D27094	1
Oil Pan Drain Plug Gst.	1962			2051	1
Push Rod Cover Set	1962		Cork Rubber	PS39685	1
Therm. Housing Gasket	1962			C24529	1
Water Outlet Gasket	1962		1-13/16" Hole	C24109	1
Water Pump Mount Gasket	1962			K27069	1

32 262 CID (4.3L) Chevrolet V6 Cyl, 4.000in./101.6mm (1985-1996)

32

Part	Year	VIN	Model/Application	Part Number	Qty.
ENGINE GASKETS					
Head Set	1994-1996	Z	(Exhaust Pipe Gasket Not Included)	HS5744D	1
	1993	Z	(Exhaust Pipe Gasket Not Included)	HS5744A	1
	1988-1992	Z	(Exhaust Pipe Gasket Not Included)	HS5744W	1
	1990	B	(Exhaust Pipe Gasket Not Included)	HS5744W	1
	1985-1987	N, Z	(Exhaust Pipe Gasket Not Included, Intake Manifold Gasket For Astro And Safari Not Included)	HS5744	1
Lower Set	1995-1996		Metal Timing Cover, (Requires Head Set To Make Full Set)	CS5744A	1
			Plastic Timing Cover, (Requires Head Set To Make Full Set, Timing Cover Gasket And Seal Not Included)	CS5744B	1
	1986-1994		(Requires Head Set To Make Full Set)	CS5744A	1
Full Set	1988-1991	Z	(Exhaust Pipe Gasket Not Included)	FS5744X	1
	1986-1987	N, Z	(Exhaust Pipe Gasket Not Included, Intake Manifold Gasket For Astro And Safari Not Included)	FS5744W	1
	1985	N, Z	(Exhaust Pipe Gasket Not Included)	FS5744	1
Engine Kit Gasket Set	1994-1995	Z	Metal Timing Cover	95-3485VR	1
	1993		Except Balance Shaft Engine, Except S10, (Intake Manifold Gasket Not Included), Use With Part Number MS15622	95-3407VR	1
	1986-1992		Except Balance Shaft Engine	95-3407VR	1
	1985	N	Except Balance Shaft Engine, 4 Barrel Carburetor	95-3442VR	1
Cylinder Head Gasket	1985-1996		(Single Sided Graphite) Nitroseal	5744	2
Cyl. Head Bolt Set	1985-1994			GS33286	2
Valve Cover Set	1994-1996		Victo-Tech	VS50211	1

32
(cont.)

262 CID (4.3L) Chevrolet V6 Cyl, 4.000in./101.6mm (1985-1996)

32
(cont.)

Part	Year	VIN	Model/Application	Part Number	Qty.	
ENGINE GASKETS (cont.)						
Valve Cover Set (cont.)	1985-1993		<i>Tuff-Cork</i>	VS50024TC	1	
			(Single Valve Cover)	<i>Tuff-Cork</i>	VS50125TC	2
				<i>Victo-Tech</i>	VS50160	1
			(Single Valve Cover)	<i>Victo-Tech</i>	VS50162	2
Valve Stem Seal, Exh.	1996			B45796	6	
	1985-1995		(O-Ring Type)	B45229	6	
	1985-1991		(High Temperature)	B45779	6	
Valve Stem Seal, Int.	1996			B45796	6	
	1985-1995		(O-Ring Type)	B45229	6	
			(Positive Type)	<i>Fluoroelastomer</i>	B45418	6
Manifold Set, Exhaust	1985-1996			MS15251	1	
Manifold Set, Intake	1993-1996			MS15622	1	
	1986-1992		Safari	MS15373	1	
					MS15373	1
	1986-1987		Except Astro, Safari	MS15352	1	
			Astro	MS15373	1	
	1985			MS15352	1	
Oil Pan Set	1986-1996		Rear Wheel Drive	<i>Tuff-Cork</i>	OS32470TC	1
				<i>Victo-Tech</i>	OS32485	1
			(Original Equipment Style Steel Backbone)	<i>Victo-Tech</i>	OS32485B	1
	1985			<i>Cork Rubber</i>	OS30934	1
Rear Main Seal Set	1986-1996		(1 Piece)	JV554	1	
			(1 Piece)	<i>Teflon</i>	JV1634	1
	1985		(2 Piece, Lip Relocator Type)	JV1627	1	
Crank Repair Sleeve	1986-1996		Use With Part Number A506, Rear <i>Nickel Plated Formed Steel, .013" Thickness</i>	A338	1	
Seal Extender	1986-1996			E300	1	
Timing Cover Set	1993-1996		Balance Shaft Engine, Metal Timing Cover	JV1176	1	
	1986-1993		Except Balance Shaft Engine	JV1041	1	
	1985			JV881	1	
				<i>Tuff-Cork</i>	JV881TC	1
Timing Cover Gasket	1993-1995		Balance Shaft Engine	T31282	1	
	1985-1993		Except Balance Shaft Engine	T27781	1	
Timing Cover Seal	1996		Plastic Timing Cover	48382	1	
	1985-1995			<i>3/8" Wide</i>	49328	1
				(Lip Relocator Type)	<i>1/2" Wide</i>	65022
Harmonic Balancer Repair Sleeve	1985-1995		Use With Part Number A504 <i>Nickel Plated Formed Steel, .013" Thickness</i>	A228	1	
MISCELLANEOUS GASKETS						
Air Cleaner Mount Gasket	1985-1995		Throttle Body Injection	G27098	1	
	1987-1994			G27098	1	
	1986-1994		Throttle Body Injection	G27098	1	
				G27098	1	
	1985-1991		Throttle Body Injection	G27098	1	
Carb. Mount Gasket	1985-1986		4 Barrel Carburetor	G26717	1	
Dist. Mounting Gasket	1985-1996			B25934	1	
E.G.R. Gasket	1992-1996		<i>2.875" Bolt Center To Bolt Center</i>	G31459	1	
	1988-1996		<i>2.250" Bolt Center To Bolt Center</i>	G31178	1	
	1985-1987			G26315	1	
Exhaust Pipe Gasket	1996		G30, G3500(GMC), (Ring Type 'E'), Pipe To Manifold	F17990	2	
	1988-1995		(Ring Type 'E'), Pipe To Manifold	F7507	2	
	1985-1987		(Ring Type 'E'), Pipe To Manifold	F7447	2	
Fuel Pump Gasket	1985-1991			D27211	1	
Oil Cooler Mount Kit	1985-1996		(Contains O-Ring And Gasket Mounting Kit), Adapter To Block	GS33281	1	

LIGHT TRUCK

General Motors Truck

32 262 CID (4.3L) Chevrolet V6 Cyl, 4.000in./101.6mm (1985-1996) **32**
(cont.) (cont.)

Part	Year	VIN	Model/Application	Part Number	Qty.
MISCELLANEOUS GASKETS (cont.)					
Oil Pan Drain Plug Gst.	1995-1996		Metric Thread <i>10.7mm Inside Diameter</i>	B45828	1
	1985-1994			2051	1
Oil Pump Shaft Retainer	1985-1996			H31354	1
Thermostat Seal	1985-1995		<i>Victo-Tech</i>	C31273	1
Throttle Body Gasket	1986-1995			G31133	1
Water Outlet Gasket	1992-1995			C31349	1
	1985			C25930	1
Water Pump Backing Plate	1985-1996		Pump To Plate	K27091	1
Water Pump Gasket	1986-1994		Pump To Plate	K27091	1
Water Pump Mount Gasket	1985-1996			K25935	2

33 262 CID (4.3L) LB4 (ZR9/Z79) Turbo Chevrolet V6 Cyl, 4.000in./101.6mm (1991-1993) **33**

Part	Year	VIN	Model/Application	Part Number	Qty.
ENGINE GASKETS					
Head Set	1991-1993		(Head Bolts Not Included, Exhaust Pipe Gasket Not Included)	HS5855	1
Lower Set	1991-1993		(Requires Head Set To Make Full Set)	CS5744A	1
Cylinder Head Gasket	1991-1993		<i>Nitroseal</i>	5855	2
Cyl. Head Bolt Set	1991-1993			GS33286	2
Valve Cover Set	1991-1993		<i>Tuff-Cork</i>	VS50024TC	1
			(Single Valve Cover) <i>Tuff-Cork</i>	VS50125TC	2
			<i>Victo-Tech</i>	VS50160	1
			(Single Valve Cover) <i>Victo-Tech</i>	VS50162	2
Valve Stem Seal, Exh.	1991-1993		(O-Ring Type)	B45229	6
			(High Temperature)	B45779	6
Valve Stem Seal, Int.	1991-1993		(O-Ring Type)	B45229	6
			(Positive Type) <i>Fluoroelastomer</i>	B45418	6
Manifold Set, Exhaust	1991-1993			MS15251	1
Manifold Set, Intake	1991-1993		(Contains Plenum Chamber Gasket)	MS16154	1
Plenum Chamber Gasket	1991-1993			MS38103	1
Oil Pan Set	1991-1993		<i>Victo-Tech</i>	OS32485	1
			(Original Equipment Style Steel Backbone) <i>Victo-Tech</i>	OS32485B	1
Rear Main Seal Set	1991-1993		(1 Piece)	JV554	1
			(1 Piece) <i>Teflon</i>	JV1634	1
Crank Repair Sleeve	1991-1993		Use With Part Number A506, Rear <i>Nickel Plated Formed Steel, .013" Thickness</i>	A338	1
Timing Cover Set	1991-1993		(Requires Oil Pan Set)	JV1041	1
Timing Cover Gasket	1991-1993			T27781	1
Timing Cover Seal	1991-1993		<i>3/8" Wide</i>	49328	1
			(Lip Relocator Type) <i>1/2" Wide</i>	65022	1
Harmonic Balancer Repair Sleeve	1991-1993		Use With Part Number A504 <i>Nickel Plated Formed Steel, .013" Thickness</i>	A228	1

MISCELLANEOUS GASKETS					
Air Cleaner Mount Gasket	1991-1993			G27098	1
Dist. Mounting Gasket	1991-1993			B25934	1
E.G.R. Gasket	1992-1993		<i>2.875" Bolt Center To Bolt Center</i>	G31459	1
	1991-1993		<i>2.250" Bolt Center To Bolt Center</i>	G31178	1
Exhaust Pipe Gasket	1991-1993		(Ring Type 'E'), Pipe To Manifold	F7507	2
Fuel Pump Gasket	1991-1993			D27211	1
Oil Cooler Mount Kit	1991-1993		(Contains O-Ring And Gasket Mounting Kit), Adapter To Block	GS33281	1

LIGHT TRUCK

33 262 CID (4.3L) LB4 (ZR9/Z79) Turbo Chevrolet V6 Cyl, 4.000in./101.6mm (1991-1993) **33**
(cont.) (cont.)

Part	Year	VIN	Model/Application	Part Number	Qty.
MISCELLANEOUS GASKETS (cont.)					
Oil Pan Drain Plug Gst.	1991-1993			2051	1
Oil Pump Shaft Retainer	1991-1993			H31354	1
Thermostat Seal	1991-1993		Victo-Tech	C31273	1
Throttle Body Gasket	1991-1993			G31350	1
Water Pump Backing Plate	1991-1993		Pump To Plate	K27091	1
Water Pump Mount Gasket	1991-1993			K25935	2

34 262 CID (4.3L) Vortec 4300 Chevrolet V6 Cyl, 4.000in./101.6mm (1992-2003) **34**

Part	Year	VIN	Model/Application	Part Number	Qty.
ENGINE GASKETS					
Head Set	1996-2003		(Exhaust Pipe Gasket Not Included, Plenum Chamber Gasket Not Included)	HS5744E	1
	1994-1995	W	(Exhaust Pipe Gasket Not Included)	HS5744C	1
	1992-1993	W	(Exhaust Pipe Gasket Not Included)	HS5744B	1
Lower Set	2002-2003		(Requires Head Set To Make Full Set, Timing Cover Gasket And Seal Not Included)	CS5744D	1
	1999-2001		Full Size Van, Pull Ahead Design Rear Main Seal, (Requires Head Set To Make Full Set, Timing Cover Gasket And Seal Not Included)	CS5744C	1
			Except Fullsize Van, (Requires Head Set To Make Full Set, Timing Cover Gasket And Seal Not Included)	CS5744D	1
			Except Pull Ahead Design Rear Main Seal, Full Size Van, (Requires Head Set To Make Full Set, Timing Cover Gasket And Seal Not Included)	CS5744D	1
	1997-1998		(Requires Head Set To Make Full Set, Timing Cover Gasket And Seal Not Included)	CS5744C	1
	1996		Astro, C1500, C1500(GMC), K1500, K1500(GMC), Safari, (Requires Head Set To Make Full Set)	CS5744B	1
			Blazer, Bravada, Express 1500, Express 2500, Express 2500 EXT, G1500, G1500(GMC), G2500, G2500(GMC), Jimmy, P30, P3500(GMC), S10, Savana 1500, Savana 2500, Savana 2500 EXT, Sonoma, (Requires Head Set To Make Full Set)	CS5744C	1
	1995		Metal Timing Cover, (Requires Head Set To Make Full Set)	CS5744A	1
1992-1994		(Requires Head Set To Make Full Set)	CS5744A	1	
Engine Kit Gasket Set	1997-1998	W, X	(Timing Cover Gasket And Seal Not Included), Use With Part Number 48382	95-3491VR	1
	1994-1995	W	Metal Timing Cover	95-3484VR	1
	1992-1993	W		95-3486VR	1
Cylinder Head Gasket	1992-2003		(Single Sided Graphite) Nitroseal	5744	2
Cyl. Head Bolt Set	1992-2003			GS33286	2
Valve Cover Set	1994-2003		Victo-Tech	VS50211	1
	1992-1993		Tuff-Cork	VS50024TC	1
			(Single Valve Cover) Tuff-Cork	VS50125TC	2
			Victo-Tech	VS50160	1
			(Single Valve Cover) Victo-Tech	VS50162	2
Valve Stem Seal, Exh.	1996-2003			B45796	6
	1992-1995		(O-Ring Type)	B45229	6
			(High Temperature)	B45779	6
Valve Stem Seal, Int.	1996-2003			B45796	6
	1992-1995		(O-Ring Type)	B45229	6
			(Positive Type) Fluoroelastomer	B45418	6
Manifold Set, Exhaust	1996-2003			MS12407	1
	1992-1995			MS15251	1
Manifold Set, Intake	1996-2003		(Plenum Chamber Gasket Not Included)	MS16168	1
	1992-1995		(Contains Plenum Chamber Gasket)	MS15497	1

General Motors Truck

34 262 CID (4.3L) Vortec 4300 Chevrolet V6 Cyl, 4.000in./101.6mm (1992-2003) **34**
 (cont.) (cont.)

Part Year VIN Model/Application Part Number Qty.

ENGINE GASKETS (cont.)

Plenum Chamber Gasket	1996-2003			MS14803	1	
	1992-1995			MS37103	1	
Oil Pan Set	1996-2003		<i>Victo-Tech</i>	OS32133	1	
	1992-1995	Rear Wheel Drive	<i>Tuff-Cork</i>	OS32470TC	1	
				<i>Victo-Tech</i>	OS32485	1
		(Original Equipment Style Steel Backbone)	<i>Victo-Tech</i>	OS32485B	1	
Rear Main Seal Set	2002-2003			JV1656	1	
	1999-2001	Full Size Van, Pull Ahead Design Rear Main Seal		JV1620	1	
		Except Fullsize Van		JV1656	1	
		Except Pull Ahead Design Rear Main Seal, Full Size Van		JV1656	1	
	1997-1998			JV1620	1	
	1996	Astro, C1500, C1500(GMC), K1500, K1500(GMC), P30, P3500(GMC), Safari, (1 Piece)			JV554	1
		Blazer, Bravada, Express 1500, Express 2500, Express 2500 EXT, G1500, G1500(GMC), G2500, G2500(GMC), Jimmy, P30, P3500(GMC), S10, Savana 1500, Savana 2500, Savana 2500 EXT, Sonoma			JV1620	1
Astro, C1500, C1500(GMC), K1500, K1500(GMC), Safari, (1 Piece)			<i>Teflon</i>	JV1634	1	
1992-1995	(1 Piece)			JV554	1	
	(1 Piece)		<i>Teflon</i>	JV1634	1	
Crank Repair Sleeve	1992-1995		Use With Part Number A506, Rear <i>Nickel Plated Formed Steel, .013" Thickness</i>	A338	1	
Seal Extender	1992-1995			E300	1	
Timing Cover Set	1995		Balance Shaft Engine, Metal Timing Cover	JV1176	1	
	1992-1994		Balance Shaft Engine	JV1176	1	
Timing Cover Gasket	1992-1995		Balance Shaft Engine	T31282	1	
Timing Cover Seal	2003			48382	1	
	1997-2003		Plastic Timing Cover	48382	1	
	1996-2003			48382	1	
	1995		Plastic Timing Cover		48382	1
			Metal Timing Cover	<i>3/8" Wide</i>	49328	1
			Metal Timing Cover, (Lip Relocator Type)	<i>1/2" Wide</i>	65022	1
	1992-1994			<i>3/8" Wide</i>	49328	1
		(Lip Relocator Type)	<i>1/2" Wide</i>	65022	1	
Harmonic Balancer Repair Sleeve	1992-1995		<i>Ground Steel, .020" Thickness</i>	66597RS	1	
			Use With Part Number A504 <i>Nickel Plated Formed Steel, .013" Thickness</i>	A228	1	

MISCELLANEOUS GASKETS

Air Cleaner Mount Gasket	1992-1995		Central Port Fuel Injection	G27098	1
Dist. Mounting Gasket	1992-2003			B25934	1
E.G.R. Gasket	1992-2002			G31459	1
Exhaust Pipe Gasket	2002	X	Astro, (Ring Type 'E'), Pipe To Manifold	F17990	2
		W	Blazer Xtreme, (Ring Type 'E'), Pipe To Manifold	F17990	2
		X	Safari, (Ring Type 'E'), Pipe To Manifold	F17990	2
	1999-2002	W	Savana 1500, (Ring Type 'E'), Pipe To Manifold	F17990	2
	1996-2002	W	S10, Sonoma, (Ring Type 'E'), Pipe To Manifold	F17990	2
	1998-2001	W	Envoy, (Ring Type 'E'), Pipe To Manifold	F17990	2
	1996-2001	W	Astro, Blazer, Bravada, Express 1500, Express 2500, Express 2500 EXT, Jimmy, Safari, Savana 2500, Savana 2500 EXT, (Ring Type 'E'), Pipe To Manifold	F17990	2
	1999-2000	W	S10, (Ring Type 'E'), Pipe To Manifold	F17990	2
	1996-2000	W	Express 1500, Express 2500, Express 2500 EXT, Savana 1500, Savana 2500, Savana 2500 EXT, 3 Bolt, Catalytic Converter	F7538	1
	1999	W	S10, Catalytic Converter To Muffler Inlet Pipe	F7534	1

LIGHT TRUCK

34 262 CID (4.3L) Vortec 4300 Chevrolet V6 Cyl, 4.000in./101.6mm (1992-2003) **34**
(cont.) (cont.)

Part	Year	VIN	Model/Application	Part Number	Qty.
MISCELLANEOUS GASKETS (cont.)					
Exhaust Pipe Gasket (cont.)	1998-1999	W	Envoy, Catalytic Converter To Muffler Inlet Pipe	F7534	1
	1996-1999	W	Blazer, Bravada, Jimmy, Catalytic Converter To Muffler Inlet Pipe	F7534	1
		W, X	S10, Sonoma, Catalytic Converter To Muffler Inlet Pipe	F7534	1
		W	Astro, G1500, G1500(GMC), G2500, G2500(GMC), Safari, Catalytic Converter	F7538	1
		W	G1500, G1500(GMC), G2500, G2500(GMC), K1500, P30, P3500(GMC), (Ring Type 'E'), Pipe To Manifold	F17990	2
		X	S10, Sonoma, (Ring Type 'E'), Pipe To Manifold	F17990	2
		1997-1998	W	Savana 3500, Catalytic Converter	F7538
		W	Savana 3500, (Ring Type 'E'), Pipe To Manifold	F17990	2
	1996-1998	W	C1500, C1500(GMC), K1500(GMC), (Ring Type 'E'), Pipe To Manifold	F17990	2
	1995	W	Blazer, Jimmy, (Ring Type 'E'), Pipe To Manifold	F7507	2
	1992-1995	W	Astro, S10, S15, Safari, Sonoma, (Ring Type 'E'), Pipe To Manifold	F7507	2
	1992-1994	W	Astro EXT, Bravada, Safari EXT, (Ring Type 'E'), Pipe To Manifold	F7507	2
Oil Cooler Mount Kit	1992-2002		(Contains O-Ring And Gasket Mounting Kit), Adapter To Block	GS33281	1
Oil Pan Drain Plug Gst.	1995-2003		Metric Thread <i>10.7mm Inside Diameter</i>	B45828	1
	1992-1994			2051	1
Oil Pump Shaft Retainer	1992-2003			H31354	1
Thermostat Seal	1996-2003		<i>Victo-Tech</i>	C31273	1
	1992-1995		<i>Victo-Tech</i>	C31227	1
Throttle Body Gasket	1996-2003			G31329	1
Water Outlet Gasket	1992-1995	W		C31349	1
Water Pump Backing Plate	1992-2003		Pump To Plate	K27091	1
Water Pump Mount Gasket	1992-2003			K25935	2

35 265 CID (4.3L) Chevrolet V8 Cyl, 3.750in./95.3mm (1955-1957) **35**

Part	Year	VIN	Model/Application	Part Number	Qty.
ENGINE GASKETS					
Head Set	1957		(Head Bolts Not Included)	HS1178VJ	1
	1955-1956		(Head Bolts Not Included)	HS1178VC	1
Lower Set	1955-1957		(Rear Main Seal Not Included, Requires Head Set To Make Full Set)	CS1178	1
Full Set	1957		(Head Bolts Not Included)	FS1178VJ	1
	1955-1956		(Head Bolts Not Included)	FS1178VC	1
Engine Kit Gasket Set	1957		(Rear Main Seal Not Included), Use With Part Number JV688	95-3033VR	1
	1955-1956		(Rear Main Seal Not Included, Intake Manifold Gasket Not Included), Use With Part Numbers MS18680, JV688	95-3033VR	1
Cylinder Head Gasket	1955-1957		<i>VR2000</i>	1178VC	2
Cyl. Head Bolt Set	1955-1957			GS33285	2
Valve Cover Set	1955-1957		<i>Cork Rubber</i>	VS38110	1
			<i>High Temperature Cork Rubber</i>	VS38110HA	1
			<i>High Temperature Tuff-Cork</i>	VS38110HTC	1
			<i>Victo-Tech</i>	VS38110R	1
			<i>Tuff-Cork</i>	VS38110TC	1
Valve Stem Seal, Exh.	1955-1957		(O-Ring Type)	B45229	8
			(Shedder Type)	B45264	8
			(High Temperature)	B45779	8
Valve Stem Seal, Int.	1955-1957		(O-Ring Type)	B45229	8

General Motors Truck

35 265 CID (4.3L) Chevrolet V8 Cyl, 3.750in./95.3mm (1955-1957) **35**
 (cont.) (cont.)

Part	Year	VIN	Model/Application	Part Number	Qty.
ENGINE GASKETS (cont.)					
Valve Stem Seal, Int. (cont.)	1955-1957		(Shedder Type)	B45264	8
			(High Temperature)	B45779	8
Manifold Set, Exhaust	1955-1957			MS7110X	1
Manifold Set, Intake	1957			MS15315	1
	1955-1956			MS18680	1
Oil Pan Set	1957		Cork Rubber	OS30568X	1
			Tuff-Cork	OS30568XTC	1
	1955-1956		Cork Rubber	OS30568	1
Rear Main Seal Set	1955-1957			JV688	1
Timing Cover Set	1955-1957		(Repair Sleeve Not Included)	JV779	1
			(Contains Repair Sleeve)	JV919	1
Timing Cover Gasket	1955-1957			T27781	1
Timing Cover Seal	1955-1957		3/8" Wide	49328	1
			(Lip Relocator Type) 1/2" Wide	65022	1
Harmonic Balancer Repair Sleeve	1955-1957		Ground Steel, .020" Thickness	66597RS	1
			Use With Part Number A504 Nickel Plated Formed Steel, .013" Thickness	A228	1

MISCELLANEOUS GASKETS

Air Cleaner Mount Gasket	1955-1957		2 Barrel Carburetor	G25936	1	
			4 Barrel Carburetor	G26410	1	
Carb. Mount Gasket	1955-1957		2 Barrel Carburetor	G7327	1	
Dist. Mounting Gasket	1955-1957			B25934	1	
Exhaust Pipe Gasket	1957		(Flange Type), Pipe To Manifold	F7135	1	
	1955-1956		(Flange Type), Crossover Pipe	F5436AK	3	
Fuel Pump Gasket	1955-1957		Plate To Block	D25932	1	
			Plate To Block	Tuff-Cork	D25932TC	1
			Pump To Plate	D27094	1	
			Pump To Plate	Tuff-Cork	D27094TC	1
Oil Pan Drain Plug Gst.	1955-1957			2051	1	
Water Outlet Gasket	1955-1957		(Universal Type)	C24109	1	
				C25930	1	
Water Pump Backing Plate	1955-1957			K27091	1	
Water Pump Mount Gasket	1955-1957			K25935	2	

36 267 CID (4.4L) L39 Chevrolet V8 Cyl, 3.500in./88.9mm (1979-1982) **36**

Part	Year	VIN	Model/Application	Part Number	Qty.
ENGINE GASKETS					
Head Set	1981-1982		(Head Bolts Not Included)	HS3514VK	1
	1979-1980		(Head Bolts Not Included)	HS3514VJ	1
Lower Set	1979-1982		(Requires Head Set To Make Full Set)	CS1178	1
Full Set	1981-1982		(Head Bolts Not Included)	FS3514VK	1
	1979-1980		(Head Bolts Not Included)	FS3514VJ	1
Engine Kit Gasket Set	1981-1982			95-3071VR	1
	1979-1980			95-3045VR	1
Cylinder Head Gasket	1979-1982		(Stainless Steel Flanges) Nitroseal	3514SG	2
				VR2000	2
			(Single Sided Graphite) Nitroseal	5745	2
Cyl. Head Bolt Set	1979-1982			GS33285	2
Valve Cover Set	1979-1982		Cork Rubber	VS38110	1
			High Temperature Cork Rubber	VS38110HA	1
			High Temperature Tuff-Cork	VS38110HTC	1

LIGHT TRUCK

36 267 CID (4.4L) L39 Chevrolet V8 Cyl, 3.500in./88.9mm (1979-1982) **36**
(cont.) (cont.)

Part	Year	VIN	Model/Application	Part Number	Qty.	
ENGINE GASKETS (cont.)						
Valve Cover Set (cont.)	1979-1982		<i>Victo-Tech</i>	VS38110R	1	
				<i>Tuff-Cork</i>	VS38110TC	1
Valve Stem Seal, Exh.	1979-1982		(O-Ring Type)	B45229	8	
			(Shedder Type)	B45264	8	
			(Shedder Type, High Temperature)	B45779	8	
Valve Stem Seal, Int.	1979-1982		(O-Ring Type)	B45229	8	
			(Positive Type)	<i>Fluoroelastomer</i>	B45418	8
Manifold Set, Exhaust	1979-1982			MS7110X	1	
Manifold Set, Intake	1979-1982		Liquid Propane Gas	MS15219BF	1	
			Except Liquid Propane Gas	MS15315	1	
Oil Pan Set	1980-1982		Right Hand Dip Stick	<i>Victo-Tech</i>	OS30568RRH	1
				<i>Tuff-Cork</i>	OS30572TC	1
	1979-1982			<i>Cork Rubber</i>	OS30568Z	1
		1979		Left Hand Dip Stick	<i>Victo-Tech</i>	OS30568RLH
				<i>Tuff-Cork</i>	OS30568ZTC	1
Rear Main Seal Set	1979-1982		(Lip Relocator Type)	JV1627	1	
Timing Cover Set	1979-1982		(Repair Sleeve Not Included)	JV881	1	
			(Repair Sleeve Not Included)	<i>Tuff-Cork</i>	JV881TC	1
			(Contains Repair Sleeve)		JV926	1
Timing Cover Gasket	1979-1982			T27781	1	
Timing Cover Seal	1979-1982			<i>3/8" Wide</i>	49328	1
			(Lip Relocator Type)	<i>1/2" Wide</i>	65022	1
Harmonic Balancer Repair Sleeve	1979-1982			<i>Ground Steel, .020" Thickness</i>	66597RS	1
			Use With Part Number A504	<i>Nickel Plated Formed Steel, .013" Thickness</i>	A228	1

MISCELLANEOUS GASKETS

Air Cleaner Mount Gasket	1979-1982		2 Barrel Carburetor	G26906	1	
Carb. Mount Gasket	1979-1982		2 Barrel Carburetor	G26693	1	
Choke Tube Gasket	1979-1980			B45784	1	
Dist. Mounting Gasket	1979-1982			B25934	1	
E.G.R. Gasket	1979-1982			G17797	1	
Fuel Pump Gasket	1979-1982		Plate To Block	D25932	1	
			Plate To Block	<i>Tuff-Cork</i>	D25932TC	1
			Pump To Plate		D27094	1
			Pump To Plate	<i>Tuff-Cork</i>	D27094TC	1
Oil Pan Drain Plug Gst.	1979-1982			2051	1	
Oil Pump Shaft Retainer	1979-1982			H31354	1	
Water Outlet Gasket	1979-1982		(Universal Type)	C24109	1	
				C25930	1	
Water Pump Backing Plate	1979-1982		Pump To Plate	K27091	1	
Water Pump Mount Gasket	1979-1982			K25935	2	

37 270 CID (4.4L) OHV General Motors 6 Cyl, 3.781in./96mm (1939-1962) **37**

Part	Year	VIN	Model/Application	Part Number	Qty.	
ENGINE GASKETS						
Head Set	1939-1962			HS1935S	1	
Full Set	1939-1962			FS1935S	1	
Cylinder Head Gasket	1939-1962			1935S	1	
Valve Cover Set	1939-1962			<i>Cork Rubber</i>	VS39729	1
Valve Stem Seal, Exh.	1939-1962		(O-Ring Type)	B45229	6	
Valve Stem Seal, Int.	1939-1962		(O-Ring Type)	B45229	6	

General Motors Truck

37 270 CID (4.4L) OHV General Motors 6 Cyl, 3.781in./96mm (1939-1962) **37**
 (cont.) (cont.)

Part	Year	VIN	Model/Application	Part Number	Qty.
ENGINE GASKETS (cont.)					
Manifold Set, Int. & Exh.	1955-1962			MS12146	1
	1950-1954			MS12189	1
	1939-1949			MS12146	1
Oil Pan Set	1939-1962		(Oil Pan Is Fastened With Self Tapping Screws) <i>Cork Rubber</i>	OS30901	1
Rear Main Seal Set	1939-1962			JV658	1
Timing Cover Set	1955-1962			JV809	1
	1939-1954			JV786	1
Timing Cover Seal	1939-1962		<i>3/8" Wide</i>	49328	1
			(Lip Relocator Type) <i>1/2" Wide</i>	65022	1

MISCELLANEOUS GASKETS

Air Cleaner Mount Gasket	1939-1962		1 Barrel Carburetor	G25936	1
Exhaust Pipe Gasket	1955-1962		(Ring Type 'C'), Pipe To Manifold	F17250	1
	1939-1954		(Flange Type), Pipe To Manifold	F17370	1
Fuel Pump Gasket	1939-1962			D27094	1
			<i>Tuff-Cork</i>	D27094TC	1
Push Rod Cover Set	1939-1962			PS39744	1
Rocker Shaft, Front Support Bracket	1939-1962			2014A	1
U Joint Housing Gasket	1939-1950			GS33066	1
Water Outlet Gasket	1939-1962		(Universal Type)	C24109	1
				C25930	1

38 283 CID (4.6L) Chevrolet V8 Cyl, 3.875in./98.4mm (1957-1967) **38**

Part	Year	VIN	Model/Application	Part Number	Qty.
ENGINE GASKETS					
Head Set	1957-1967		(Head Bolts Not Included, Exhaust Pipe Gasket Not Included, Contains Beaded Steel Cylinder Head Gasket)	HS1178BJ	1
			(Head Bolts Not Included, Exhaust Pipe Gasket Not Included, Contains VR2000 Cylinder Head Gasket)	HS1178VJ	1
Lower Set	1957-1967		(Requires Head Set To Make Full Set)	CS1178	1
Full Set	1959-1967		(Head Bolts Not Included, Exhaust Pipe Gasket Not Included, Contains Beaded Steel Cylinder Head Gasket)	FS1178BJ	1
			(Head Bolts Not Included, Exhaust Pipe Gasket Not Included, Contains VR2000 Cylinder Head Gasket)	FS1178VJ	1
	1957-1960		Requires Rear Main Seal, (Head Bolts Not Included, Rear Main Seal Not Included, Exhaust Pipe Gasket Not Included, Contains VR2000 Cylinder Head Gasket)	FS1178VJ	1
	1959		(Head Bolts Not Included, Rear Main Seal Not Included, Exhaust Pipe Gasket Not Included, Contains VR2000 Cylinder Head Gasket)	FS1178VJ	1
	1957-1958		Requires Rear Main Seal, (Rear Main Seal Not Included, Exhaust Pipe Gasket Not Included, Contains Beaded Steel Cylinder Head Gasket)	FS1178BJ	1
Engine Kit Gasket Set	1959-1967			95-3033VR	1
	1957-1958		(Rear Main Seal Not Included), Use With Part Number JV688	95-3033VR	1
Cylinder Head Gasket	1957-1967		<i>Beaded Steel</i>	1178BS	2
			(Stainless Steel Flanges) <i>Nitroseal, 4.160" Combustion Chamber Opening</i>	1178SG	2
			<i>VR2000</i>	1178VC	2
			(Stainless Steel Flanges) <i>Nitroseal, 4.100" Combustion Chamber Opening</i>	54052	2
Cyl. Head Bolt Set	1957-1967			GS33285	2
Valve Cover Set	1957-1967		<i>Cork Rubber</i>	VS38110	1
			<i>High Temperature Cork Rubber</i>	VS38110HA	1

LIGHT TRUCK

38 283 CID (4.6L) Chevrolet V8 Cyl, 3.875in./98.4mm (1957-1967) **38**
(cont.) (cont.)

Part	Year	VIN	Model/Application	Part Number	Qty.
ENGINE GASKETS (cont.)					
Valve Cover Set (cont.)	1957-1967		High Temperature Tuff-Cork	VS38110HTC	1
			Victo-Tech	VS38110R	1
			Tuff-Cork	VS38110TC	1
Valve Stem Seal, Exh.	1957-1967		(O-Ring Type)	B45229	8
			(Shedder Type)	B45264	8
			(High Temperature)	B45779	8
Valve Stem Seal, Int.	1957-1967		(O-Ring Type)	B45229	8
			(Shedder Type)	B45264	8
			(High Temperature)	B45779	8
Manifold Set, Exhaust	1957-1967			MS7110X	1
Manifold Set, Intake	1957-1967			MS15315	1
Oil Pan Set	1957-1967		Cork Rubber	OS30568X	1
			Tuff-Cork	OS30568XTC	1
Rear Main Seal Set	1959-1967		(Lip Relocator Type)	JV1627	1
	1957-1958			JV688	1
Timing Cover Set	1957-1967		(Repair Sleeve Not Included)	JV779	1
			(Contains Repair Sleeve)	JV919	1
Timing Cover Gasket	1957-1967			T27781	1
Timing Cover Seal	1957-1967			3/8" Wide 49328	1
			(Lip Relocator Type)	1/2" Wide 65022	1
Harmonic Balancer Repair Sleeve	1957-1967		Ground Steel, .020" Thickness	66597RS	1
			Use With Part Number A504 Nickel Plated Formed Steel, .013" Thickness	A228	1

MISCELLANEOUS GASKETS

Air Cleaner Mount Gasket	1957-1967		2 Barrel Carburetor	G25936	1
			4 Barrel Carburetor	G27098	1
Carb. Mount Gasket	1962-1967		2 Barrel Carburetor	G12216	1
	1959-1967		Adapter, Governor, 2 Barrel Carburetor	G7327	1
	1957-1961		4 Barrel Carburetor	G14116	1
	1959-1960		2 Barrel Carburetor	G12216	1
	1958-1960		Adapter, Governor, Governor And Carburetor, 2 Barrel Carburetor	G7327	1
	1957		Governor And Carburetor, 2 Barrel Carburetor	G7327	1
Dist. Mounting Gasket	1957-1967			B25934	1
Exhaust Pipe Gasket	1957-1967		(Flange Type), Pipe To Manifold	F7135	1
Fuel Pump Gasket	1957-1967		Plate To Block	D25932	1
			Plate To Block	Tuff-Cork D25932TC	1
			Pump To Plate	D27094	1
			Pump To Plate	Tuff-Cork D27094TC	1
Heat Riser Gasket	1957-1967			F7135	1
Oil Pan Drain Plug Gst.	1957-1967			2051	1
Oil Pump Shaft Retainer	1957-1967			H31354	1
Water Outlet Gasket	1957-1967		1-13/16" Hole	C24109	1
	1957-1963		2-11/32" Hole	C31409	1
Water Pump Backing Plate	1957-1967			K27091	1
Water Pump Mount Gasket	1957-1967			K25935	2

39 292 CID (4.8L) Chevrolet 6 Cyl, 3.875in./98.4mm (1963-1989) **39**

Part	Year	VIN	Model/Application	Part Number	Qty.
ENGINE GASKETS					
Head Set	1986-1989		(Exhaust Pipe Gasket Not Included)	HS1185W	1

General Motors Truck

39 292 CID (4.8L) Chevrolet 6 Cyl, 3.875in./98.4mm (1963-1989) **39**
 (cont.) (cont.)

Part	Year	VIN	Model/Application	Part Number	Qty.
ENGINE GASKETS (cont.)					
Head Set (cont.)	1963-1985		(Exhaust Pipe Gasket Not Included)	HS1185E	1
Lower Set	1963-1989		24 Bolt Oil Pan, (Requires Head Set To Make Full Set)	CS1185	1
Full Set	1986-1989		(Exhaust Pipe Gasket Not Included)	FS1185W	1
	1963-1985		24 Bolt Oil Pan, (Exhaust Pipe Gasket Not Included)	FS1185E	1
Engine Kit Gasket Set	1985-1989		(Valve Stem Seals Not Included), Use With Part Number B45418 (6)	95-3000VR	1
	1968-1984		24 Bolt Oil Pan	95-3000VR	1
	1980		16 Bolt Oil Pan, (16 Bolt Oil Pan Gasket Not Included)	95-3000VR	1
	1963-1967		(Rear Main Seal Not Included), Use With Part Number JV728	95-3000VR	1
Cylinder Head Gasket	1963-1989		VR2000	3829	1
Valve Cover Set	1963-1989		Cork Rubber	VS39693	1
Valve Stem Seal, Exh.	1963-1989		(O-Ring Type)	B45229	6
Valve Stem Seal, Int.	1963-1989		(O-Ring Type)	B45229	6
			(Positive Type) Fluoroelastomer	B45418	6
Manifold Gasket	1963-1989		Except Liquid Propane Gas, Intake To Exhaust	B7354	1
Manifold Set, Int. & Exh.	1963-1989			MS16033X	1
Oil Pan Set	1963-1989		24 Bolt Oil Pan Cork Rubber	OS30988X	1
Rear Main Seal Set	1969-1989		(Lip Relocator Type)	JV1627	1
	1968		Distributor Boss Stamped F0623 With "R" Under Date	JV728	1
			Except Distributor Boss Stamped F0623 With "R" Under Date, (Lip Relocator Type)	JV1627	1
	1963-1967			JV728	1
Timing Cover Set	1963-1989		(Repair Sleeve Not Included)	JV862	1
			(Contains Repair Sleeve)	JV925	1
Timing Cover Gasket	1963-1989			T14744	1
Timing Cover Seal	1963-1989		3/8" Wide	49328	1
			(Lip Relocator Type) 1/2" Wide	65022	1
Harmonic Balancer Repair Sleeve	1963-1989		Ground Steel, .020" Thickness	66597RS	1
			Use With Part Number A504 Nickel Plated Formed Steel, .013" Thickness	A228	1
MISCELLANEOUS GASKETS					
Air Cleaner Mount Gasket	1963-1989		1 Barrel Carburetor	G25936	1
Carb. Mount Gasket	1973-1989		1 Barrel Carburetor	G14142	1
	1979-1982		1 Barrel Carburetor, Governor Base To Manifold	G14142	1
	1973-1982		1 Barrel Carburetor	G14142	1
	1963-1972		1 Barrel Carburetor	G5349AD	1
Dist. Mounting Gasket	1963-1989			B26466	1
E.G.R. Gasket	1977-1989			G26338	1
	1973-1983			G17797	1
Exhaust Pipe Gasket	1985-1989		(Ring Type 'E'), Pipe To Manifold	F20423	1
	1983-1984		(Ring Type 'E'), Pipe To Manifold	F7269	2
	1963-1982		(Ring Type 'C'), Pipe To Manifold	F17250	1
			(Ring Type 'B'), Pipe To Manifold Sintered Metal	F17250S	1
Fuel Pump Gasket	1963-1989			D27094	1
			Tuff-Cork	D27094TC	1
Oil Pan Drain Plug Gst.	1963-1989			2051	1
Push Rod Cover Set	1963-1989		Cork Rubber	PS38417	1
Therm. Housing Gasket	1963-1989		Housing To Head	C26544	1
Water Outlet Gasket	1967-1989			C25930	1
	1963-1989		(Universal Type)	C24109	1
	1963-1966		1-3/4" Hole	C25930	1
			2-3/8" Hole	C26565	1

LIGHT TRUCK

39 292 CID (4.8L) Chevrolet 6 Cyl, 3.875in./98.4mm (1963-1989) **39**
(cont.) (cont.)

Part Year VIN Model/Application Part Number Qty.

MISCELLANEOUS GASKETS (cont.)

Water Pump Mount Gasket	1963-1989			K26572	1
-------------------------	-----------	--	--	--------	---

40 294 CID (4.8L) Vortec 4800 LR4 Chevrolet V8 Cyl, 3.780in./96mm (1999-2003) **40**

Part Year VIN Model/Application Part Number Qty.

ENGINE GASKETS

Head Set	2002-2003		(Head Bolts Not Included)	HS54340	1
	1999-2001		(Head Bolts Not Included, Valve Stem Seals Used With 22.8mm Outside Diameter Valve Guides Not Included)	HS54331	1
Lower Set	1999-2003		(Requires Head Set To Make Full Set)	CS5975	1
Cylinder Head Gasket	2002-2003		<i>Multi-Layered Steel</i>	54340	2
	1999-2001		<i>VR2000</i>	54331	2
Cyl. Head Bolt Set	1999-2003			GS33380	2
Valve Cover Set	1999-2003		<i>Victo-Tech</i>	VS50250	1
Valve Stem Seal, Exh.	2002-2003			B45920	8
	2001		1st Design With 14.4mm Valve Guide Outside Diameter	B45919	8
			2nd Design With 22.8mm Valve Guide Outside Diameter	B45920	8
1999-2000			B45919	8	
Valve Stem Seal, Int.	2002-2003			B45921	8
	2001		2nd Design With 22.8mm Valve Guide Outside Diameter	B45921	8
			1st Design With 14.4mm Valve Guide Outside Diameter	B45922	8
1999-2000			B45922	8	
Manifold Set, Exhaust	1999-2003		<i>Multi-Layered Steel</i>	MS16124	1
Manifold Set, Intake	1999-2003			MS16340	1
Oil Pan Set	1999-2003			OS32241	1
Rear Main Seal Set	1999-2003			JV1657	1
Timing Cover Set	1999-2003		Requires Oil Pan Set	JV5022	1

MISCELLANEOUS GASKETS

E.G.R. Gasket	1999-2002		Tube To Exhaust Manifold	G31535	1
			(O-Ring Type), Pipe	G31626	1
	1999-2001		Valve	G31620	1
Exhaust Pipe Gasket	1999-2003		Except Fullsize Van, Left, Pipe To Manifold	F31618	1
			Except Fullsize Van, Pipe To Manifold, Right	F31619	1
Oil Pan Drain Plug Gst.	1999-2003			B45828	1
Thermostat O-Ring	1999-2003			72141	1
Throttle Body Gasket	1999-2003			G31617	1
Water Pump Backing Plate	1999-2003		(O-Ring Type)	K31629	1
Water Pump Gasket	1999-2003			K31628	2

41 302 CID (5.0L) OHV General Motors 6 Cyl, 4.000in./101.6mm (1952-1959) **41**

Part Year VIN Model/Application Part Number Qty.

ENGINE GASKETS

Head Set	1952-1959			HS3013	1
Full Set	1952-1959			FS3013	1
Cylinder Head Gasket	1952-1959			3013	1
Valve Cover Set	1952-1959		<i>Cork Rubber</i>	VS39729	1
Valve Stem Seal, Int.	1952-1959		(O-Ring Type)	B45229	6
Manifold Set, Int. & Exh.	1952-1959			MS12189	1
Oil Pan Set	1952-1959		(Oil Pan Is Fastened With Self Tapping Screws) <i>Cork Rubber</i>	OS30901	1
Rear Main Seal Set	1952-1959			JV658	1
Timing Cover Set	1955-1959			JV809	1
	1952-1954			JV786	1

General Motors Truck

41 <small>(cont.)</small>	302 CID (5.0L) OHV General Motors 6 Cyl, 4.000in./101.6mm (1952-1959)	41 <small>(cont.)</small>
-------------------------------------	--	-------------------------------------

Part	Year	VIN	Model/Application	Part Number	Qty.
MISCELLANEOUS GASKETS					
Air Cleaner Mount Gasket	1952-1959		1 Barrel Carburetor	G25936	1
Exhaust Pipe Gasket	1952-1959		(Flange Type), Pipe To Manifold	F17370	1
Fuel Pump Gasket	1952-1959			D27094	1
				Tuff-Cork	D27094TC
Rocker Shaft, Front Support Bracket	1952-1959			2014A	1
Water Outlet Gasket	1952-1959		(Universal Type)	C24109	1
				C25930	1

42	305 CID (5.0L) General Motors V6 Cyl, 4.250in./108mm (1960-1974)	42
-----------	---	-----------

Part	Year	VIN	Model/Application	Part Number	Qty.
ENGINE GASKETS					
Head Set	1960-1974			HS3380	1
Full Set	1973-1974			FS3380W	1
	1960-1972			FS3380	1
Cylinder Head Gasket	1960-1974			3380	2
Valve Cover Set	1960-1974		Cork Rubber	VS38290	1
Valve Stem Seal, Int.	1960-1974		(O-Ring Type)	B45229	6
Manifold Set, Exhaust	1960-1974			MS10009	1
Manifold Set, Intake	1960-1974			MS15955	1
Oil Pan Set	1960-1974		Cork Rubber	OS31577	1
Rear Main Seal Set	1973-1974			JV616	1
	1960-1972			JV716	1
Timing Cover Set	1960-1974			JV815	1
Harmonic Balancer Repair Sleeve	1960-1974		Use With Part Number A503 Nickel Plated Formed Steel, .013" Thickness	A227	1

Part	Year	VIN	Model/Application	Part Number	Qty.		
MISCELLANEOUS GASKETS							
Air Cleaner Mount Gasket	1973-1974			G25936	1		
Carb. Mount Gasket	1973-1974			G7363	1		
Exhaust Pipe Gasket	1973-1974		(Flange Type), Crossover Pipe	F7135	1		
	1960-1974		(Flange Type), Pipe To Manifold	F7135	1		
Fuel Pump Gasket	1960-1974			D27094	1		
				Tuff-Cork	D27094TC	1	
Push Rod Cover Set	1960-1974			PS38029	1		
Water Outlet Gasket	1973-1974			C26501	1		
	1967-1972		Hydraulic Brakes	C24109	1		
			Air Brakes	C26501	1		
1960-1966			C24109	1			
Water Pump Mount Gasket	1973-1974			K27540	1		
				1960-1972	Pump Number 522934	K27540	1
				1960-1972	Pump Number 2384840	K27566	1

43	305 CID (5.0L) Chevrolet V8 Cyl, 3.736in./95mm (1976-2002)	43
-----------	---	-----------

Part	Year	VIN	Model/Application	Part Number	Qty.
ENGINE GASKETS					
Head Set	1996-2002		(Head Bolts Not Included, Contains Graphite Head Gasket, Exhaust Pipe Gasket Not Included, Plenum Chamber Gasket Not Included)	HS5745A	1
	1987-1995		(Head Bolts Not Included, Contains Graphite Head Gasket, Exhaust Pipe Gasket Not Included)	HS5745W	1
	1987-1993		(Head Bolts Not Included, Exhaust Pipe Gasket Not Included, Contains VR2000 Cylinder Head Gasket)	HS3514VN	1
	1986		(Head Bolts Not Included, Exhaust Pipe Gasket Not Included, Contains VR2000 Cylinder Head Gasket)	HS3514VL	1

LIGHT TRUCK

43
(cont.)

305 CID (5.0L) Chevrolet V8 Cyl, 3.736in./95mm (1976-2002)

43
(cont.)

Part	Year	VIN	Model/Application	Part Number	Qty.
ENGINE GASKETS (cont.)					
Head Set (cont.)	1986		(Contains Graphite Head Gasket, Exhaust Pipe Gasket Not Included)	HS5745	1
	1980-1985		(Head Bolts Not Included, Exhaust Pipe Gasket Not Included, Contains VR2000 Cylinder Head Gasket, Contains Positive Type Valve Stem Seals)	HS3514VK	1
	1976-1985		(Head Bolts Not Included, Exhaust Pipe Gasket Not Included, Contains VR2000 Cylinder Head Gasket)	HS3514VJ	1
Lower Set	1996-2002		(Requires Head Set To Make Full Set, Timing Cover Gasket And Seal Not Included)	CS5746	1
	1993-1995		(Requires Head Set To Make Full Set)	CS1178C	1
	1985-1992		1 Piece Rear Main Seal, (Requires Head Set To Make Full Set)	CS1178A	1
	1976-1985		2 Piece Rear Main Seal, (Requires Head Set To Make Full Set)	CS1178	1
Full Set	1987-1993		(Head Bolts Not Included, Exhaust Pipe Gasket Not Included, Contains VR2000 Cylinder Head Gasket)	FS3514VN	1
	1986		(Head Bolts Not Included, Exhaust Pipe Gasket Not Included, Contains VR2000 Cylinder Head Gasket)	FS3514VL	1
	1980-1985		(Head Bolts Not Included, Exhaust Pipe Gasket Not Included, Contains VR2000 Cylinder Head Gasket, Contains Positive Type Valve Stem Seals)	FS3514VK	1
	1976-1985		(Head Bolts Not Included, Exhaust Pipe Gasket Not Included, Contains VR2000 Cylinder Head Gasket)	FS3514VJ	1
Engine Kit Gasket Set	1996-1999		(Timing Cover Gasket And Seal Not Included), Use With Part Number 48382	95-3489VR	1
	1987-1995		(Exhaust Valve Stem Seal For 3/8" Valve Stem Diameter For Series 10 And 20 Not Included), Use With Part Number B45874 (8)	95-3412VR	1
	1985-1986		1 Piece Rear Main Seal, (Exhaust Valve Stem Seal For 3/8" Valve Stem Diameter For Series 10 And 20 Not Included), Use With Part Number B45874 (8)	95-3443VR	1
	1981-1985		2 Piece Rear Main Seal, (Exhaust Valve Stem Seal For 3/8" Valve Stem Diameter For Series 10 And 20 Not Included), Use With Part Number B45874 (8)	95-3071VR	1
	1981		2 Piece Rear Main Seal, (Exhaust Valve Stem Seal For 3/8" Valve Stem Diameter For Series 10 And 20 Not Included)	95-3071VR	1
	1976-1980			95-3045VR	1
Cylinder Head Gasket	1976-2002		(Stainless Steel Flanges) Nitroseal	3514SG	2
			VR2000	3514VC	2
			(Single Sided Graphite) Nitroseal	5745	2
Cyl. Head Bolt Set	1976-2002			GS33285	2
Valve Cover Set	1987-2002		Tuff-Cork	VS50025TC	1
			(Single Valve Cover) Tuff-Cork	VS50126TC	2
			Victo-Tech	VS50161	1
			(Single Valve Cover) Victo-Tech	VS50163	2
	1976-1986		Cork Rubber	VS38110	1
			High Temperature Cork Rubber	VS38110HA	1
			High Temperature Tuff-Cork	VS38110HTC	1
			Victo-Tech	VS38110R	1
		Tuff-Cork	VS38110TC	1	
Valve Stem Seal, Exh.	1996-2002	M		B45796	8
	1981-1995		3/4 Ton, 3/8" Valve Stem	B45874	8
	1976-1995		(O-Ring Type)	B45229	8
			(Shedder Type)	B45264	8
			(High Temperature)	B45779	8
Valve Stem Seal, Int.	1996-2002	M		B45796	8
	1981-1995		(Positive Type) Fluoroelastomer	B45418	8
	1976-1995		(O-Ring Type)	B45229	8
	1976-1980		(Shedder Type)	B45264	8
			(High Temperature)	B45779	8
Manifold Set, Exhaust	1996-2002			MS16093	1

General Motors Truck

43 305 CID (5.0L) Chevrolet V8 Cyl, 3.736in./95mm (1976-2002)
(cont.)

43
(cont.)

Part Year VIN Model/Application Part Number Qty.

ENGINE GASKETS (cont.)

Manifold Set, Exhaust (cont.)	1976-1995			MS7110X	1
Manifold Set, Intake	1996-2002		(Plenum Chamber Gasket Not Included)	MS16167	1
	1987-1995			MS15401	1
	1976-1986			MS15315	1
	1976-1985		Liquid Propane Gas	MS15219BF	1
Plenum Chamber Gasket	1996-2002		(Contains Plenum)	MS14804	1
Oil Pan Set	1986-1999			<i>Tuff-Cork</i> OS32471TC	1
				<i>Victo-Tech</i> OS32496	1
			(Original Equipment Style Steel Backbone)	<i>Victo-Tech</i> OS32496B	1
	1985		1 Piece Rear Main Seal	<i>Tuff-Cork</i> OS32471TC	1
			1 Piece Rear Main Seal	<i>Victo-Tech</i> OS32496	1
			1 Piece Rear Main Seal, (Original Equipment Style Steel Backbone)	<i>Victo-Tech</i> OS32496B	1
	1980-1985		2 Piece Rear Main Seal	<i>Tuff-Cork</i> OS30572TC	1
	1976-1984			<i>Cork Rubber</i> OS30568Z	1
	1976-1979			<i>Tuff-Cork</i> OS30568ZTC	1
Rear Main Seal Set	1996-1999			JV1620	1
	1985-1995		(1 Piece)	JV554	1
			(1 Piece)	<i>Teflon</i> JV1634	1
	1976-1985		(2 Piece, Lip Relocator Type)	JV1627	1
Crank Repair Sleeve	1986-1995		Use With Part Number A506, Rear <i>Nickel Plated Formed Steel, .013" Thickness</i>	A338	1
Seal Extender	1985-1999		1 Piece Rear Main Seal	E300	1
Timing Cover Set	1986-1995		(Repair Sleeve Not Included)	JV1041	1
	1976-1985		(Repair Sleeve Not Included)	JV881	1
			(Repair Sleeve Not Included)	<i>Tuff-Cork</i> JV881TC	1
			(Contains Repair Sleeve)	JV926	1
Timing Cover Gasket	1976-1995			T27781	1
Timing Cover Seal	1996-2002			48382	1
	1976-1995			<i>3/8" Wide</i> 49328	1
			(Lip Relocator Type)	<i>1/2" Wide</i> 65022	1
Harmonic Balancer Repair Sleeve	1976-1995			<i>Ground Steel, .020" Thickness</i> 66597RS	1
			Use With Part Number A504 <i>Nickel Plated Formed Steel, .013" Thickness</i>	A228	1

MISCELLANEOUS GASKETS

Air Cleaner Mount Gasket	1987-1995		Throttle Body Injection	G27098	1
	1979-1986		4 Barrel Carburetor	G27098	1
	1979-1981		2 Barrel Carburetor	G26906	1
	1976-1978		2 Barrel Carburetor	G26617	1
Carb. Mount Gasket	1982-1986		4 Barrel Carburetor	G26792	1
	1981		Except Automatic Transmission, 4 Barrel Carburetor	G26719	1
			Automatic Transmission, 4 Barrel Carburetor	G26792	1
	1979-1981		2 Barrel Carburetor	G26693	1
	1979-1980		4 Barrel Carburetor	G26719	1
	1976-1978		2 Barrel Carburetor	G26711	1
Choke Tube Gasket	1979-1980			B45784	1
	1976-1978			B45787	1
Dist. Mounting Gasket	1976-2002			B25934	1
E.G.R. Gasket	1996-2002	M		G31459	1
	1987-1995		Throttle Body Injection	G31178	1
	1981-1986		4 Barrel Carburetor	G26748	2
	1979-1981		2 Bolt In-Line Pattern, 2 Barrel Carburetor	G17797	1
Exhaust Pipe Gasket	1996-2002		(3 Holes), Converter To Exhaust Pipe	F7538	1
		M	(Ring Type 'E'), Pipe To Manifold	F17990	2

LIGHT TRUCK

43 305 CID (5.0L) Chevrolet V8 Cyl, 3.736in./95mm (1976-2002) **43**
(cont.) (cont.)

Part	Year	VIN	Model/Application	Part Number	Qty.
MISCELLANEOUS GASKETS (cont.)					
Exhaust Pipe Gasket (cont.)	1987-1995		(Ring Type 'E'), Pipe To Manifold	F7507	2
	1985-1986		(Ring Type 'E'), Pipe To Manifold	F7447	2
	1983-1984		(Ring Type 'E'), Pipe To Manifold	F7269	2
	1976-1982		2.5" Pipe, (Ring Type 'C'), Pipe To Manifold	F7139	2
			2.5" Pipe, (Ring Type 'B'), Pipe To Manifold <i>Sintered Metal</i>	F7139S	2
			2" Pipe, (Ring Type 'C'), Pipe To Manifold	F17250	2
Fuel Pump Gasket	1976-1999		Plate To Block	D25932	1
			Plate To Block <i>Tuff-Cork</i>	D25932TC	1
	1976-1995		Pump To Plate	D27094	1
			Pump To Plate <i>Tuff-Cork</i>	D27094TC	1
Oil Cooler Gasket	1979-1999		2 Wheel Drive, (Contains Gasket Only), Adapter To Block	H31318	1
	1981-1986		(Contains Gasket Only), Adapter To Block	H31318	1
			2 Wheel Drive, (Contains Gasket Only), Adapter To Block	H31318	1
	1979-1986		2 Wheel Drive, (Contains Gasket Only), Adapter To Block	H31318	1
	1979-1982		2 Wheel Drive, (Contains Gasket Only), Adapter To Block	H31318	1
	1976-1982		2 Wheel Drive, (Contains Gasket Only), Adapter To Block	H31318	1
	1977-1978		Rear Wheel Drive, (Contains Gasket Only), Adapter To Block	H31318	1
Oil Cooler Mount Kit	1976-1999		(Contains O-Ring And Gasket Mounting Kit), Adapter To Block	GS33272	1
Oil Pan Drain Plug Gst.	1996-2002	M		B45828	1
	1995		English Thread <i>1/2" Inside Diameter</i>	2051	1
			Metric Thread <i>10.7mm Inside Diameter</i>	B45828	1
	1976-1994		<i>1/2" Inside Diameter</i>	2051	1
Oil Pump Shaft Retainer	1976-2002			H31354	1
Thermostat Seal	1991-1999		<i>Victo-Tech</i>	C31273	1
Throttle Body Gasket	1996-2002	M		G31329	1
	1991-1995			G31133	1
	1987-1990			G30948	1
Water Outlet Gasket	1976-1991		(Universal Type)	C24109	1
				C25930	1
Water Pump Backing Plate	1976-2002			K27091	1
Water Pump Mount Gasket	1976-2002			K25935	2

44 305 CID (5.0L) Chevrolet LPG V8 Cyl, 3.736in./95mm (1976-1986) **44**

Part	Year	VIN	Model/Application	Part Number	Qty.
ENGINE GASKETS					
Engine Kit Gasket Set	1985-1986		1 Piece Rear Main Seal, (Exhaust Valve Stem Seal For 3/8" Valve Stem Diameter For Series 10 And 20 Not Included), Use With Part Number B45874 (8)	95-3443VR	1
	1981-1985		2 Piece Rear Main Seal, (Exhaust Valve Stem Seal For 3/8" Valve Stem Diameter For Series 10 And 20 Not Included), Use With Part Number B45874 (8)	95-3071VR	1
	1976-1980			95-3045VR	1

45 307 CID (5.0L) Chevrolet V8 Cyl, 3.875in./98.4mm (1968-1973) **45**

Part	Year	VIN	Model/Application	Part Number	Qty.
ENGINE GASKETS					
Head Set	1968-1973		(Head Bolts Not Included, Exhaust Pipe Gasket Not Included, Contains Beaded Steel Cylinder Head Gasket)	HS1178BJ	1
			(Head Bolts Not Included, Exhaust Pipe Gasket Not Included, Contains VR2000 Cylinder Head Gasket)	HS1178VJ	1

General Motors Truck

45 307 CID (5.0L) Chevrolet V8 Cyl, 3.875in./98.4mm (1968-1973) **45**
 (cont.) (cont.)

Part Year VIN Model/Application Part Number Qty.

ENGINE GASKETS (cont.)

Lower Set	1968-1973		(Requires Head Set To Make Full Set)	CS1178	1
Full Set	1968-1973		(Head Bolts Not Included, Exhaust Pipe Gasket Not Included, Contains Beaded Steel Cylinder Head Gasket)	FS1178BJ	1
			(Head Bolts Not Included, Exhaust Pipe Gasket Not Included, Contains VR2000 Cylinder Head Gasket)	FS1178VJ	1
Engine Kit Gasket Set	1968-1973			95-3033VR	1
Cylinder Head Gasket	1968-1973		<i>Beaded Steel</i>	1178BS	2
			(Stainless Steel Flanges) <i>Nitroseal, 4.160" Combustion Chamber Opening</i>	1178SG	2
			<i>VR2000</i>	1178VC	2
			(Stainless Steel Flanges) <i>Nitroseal, 4.100" Combustion Chamber Opening</i>	54052	2
Cyl. Head Bolt Set	1968-1973			GS33285	2
Valve Cover Set	1968-1973		<i>Cork Rubber</i>	VS38110	1
			<i>High Temperature Cork Rubber</i>	VS38110HA	1
			<i>High Temperature Tuff-Cork</i>	VS38110HTC	1
			<i>Victo-Tech</i>	VS38110R	1
			<i>Tuff-Cork</i>	VS38110TC	1
Valve Stem Seal, Exh.	1968-1973		(O-Ring Type)	B45229	8
			(Shedder Type)	B45264	8
			(High Temperature)	B45779	8
Valve Stem Seal, Int.	1968-1973		(O-Ring Type)	B45229	8
			(Shedder Type)	B45264	8
			(High Temperature)	B45779	8
Manifold Set, Exhaust	1968-1973			MS7110X	1
Manifold Set, Intake	1968-1973			MS15315	1
Oil Pan Set	1968-1973		<i>Cork Rubber</i>	OS30568X	1
			<i>Tuff-Cork</i>	OS30568XTC	1
Rear Main Seal Set	1968-1973		(Lip Relocator Type)	JV1627	1
Timing Cover Set	1968-1973		(Repair Sleeve Not Included)	JV779	1
			(Contains Repair Sleeve)	JV919	1
Timing Cover Gasket	1968-1973			T27781	1
Timing Cover Seal	1968-1973		<i>3/8" Wide</i>	49328	1
			(Lip Relocator Type) <i>1/2" Wide</i>	65022	1
Harmonic Balancer Repair Sleeve	1968-1973		<i>Ground Steel, .020" Thickness</i>	66597RS	1
			Use With Part Number A504 <i>Nickel Plated Formed Steel, .013" Thickness</i>	A228	1

MISCELLANEOUS GASKETS

Air Cleaner Mount Gasket	1968-1973		2 Barrel Carburetor	G25936	1
Carb. Mount Gasket	1971		Blazer, C10, C10 Suburban, G10, K10, K10 Suburban, P10, 2 Barrel Carburetor	G25458	1
	1968-1970		Heat Passage Cutouts, 2 Barrel Carburetor	G12216	1
	1968-1969		Except Heat Passage Cutouts, 2 Barrel Carburetor	G7327	1
Dist. Mounting Gasket	1968-1973			B25934	1
E.G.R. Gasket	1973			G17797	1
Exhaust Pipe Gasket	1968-1973		(Flange Type), Pipe To Manifold	F7135	1
			2.5" Pipe, (Ring Type 'C'), Pipe To Manifold	F7139	2
			2.5" Pipe, (Ring Type 'B'), Pipe To Manifold <i>Sintered Metal</i>	F7139S	1
			2" Pipe, (Ring Type 'C'), Pipe To Manifold	F17250	1
			2" Pipe, (Ring Type 'B'), Pipe To Manifold <i>Sintered Metal</i>	F17250S	1
Fuel Pump Gasket	1968-1973		Plate To Block	D25932	1
			Plate To Block <i>Tuff-Cork</i>	D25932TC	1
			Pump To Plate	D27094	1
			Pump To Plate <i>Tuff-Cork</i>	D27094TC	1
Heat Riser Gasket	1968-1973			F7135	1

LIGHT TRUCK

General Motors Truck

45 (cont.)	307 CID (5.0L) Chevrolet V8 Cyl, 3.875in./98.4mm (1968-1973)				45 (cont.)
----------------------	---	--	--	--	----------------------

<i>Part</i>	<i>Year</i>	<i>VIN</i>	<i>Model/Application</i>	<i>Part Number</i>	<i>Qty.</i>
MISCELLANEOUS GASKETS (cont.)					
Oil Pan Drain Plug Gst.	1968-1973			2051	1
Oil Pump Shaft Retainer	1968-1973			H31354	1
Water Outlet Gasket	1968-1973		(Universal Type)	C24109	1
				C25930	1
Water Pump Backing Plate	1968-1973			K27091	1
Water Pump Mount Gasket	1968-1973			K25935	2

46	325 CID (5.3L) Vortec 5300 Chevrolet V8 Cyl, 3.780in./96mm (1999-2003)				46
-----------	---	--	--	--	-----------

<i>Part</i>	<i>Year</i>	<i>VIN</i>	<i>Model/Application</i>	<i>Part Number</i>	<i>Qty.</i>
ENGINE GASKETS					
Head Set	2002-2003		(Requires Head Set To Make Full Set)	HS54340	1
	1999-2001		(Head Bolts Not Included, Valve Stem Seals Used With 22.8mm Outside Diameter Valve Guides Not Included)	HS54331	1
Lower Set	1999-2003		(Requires Head Set To Make Full Set)	CS5975	1
Cylinder Head Gasket	2002-2003		<i>Multi-Layered Steel</i>	54340	2
	1999-2001		<i>VR2000</i>	54331	2
Cyl. Head Bolt Set	1999-2003			GS33380	2
Valve Cover Set	1999-2003		<i>Victo-Tech</i>	VS50250	1
Valve Stem Seal, Exh.	2002-2003			B45920	8
	2001		1st Design With 14.4mm Valve Guide Outside Diameter	B45919	8
			2nd Design With 22.8mm Valve Guide Outside Diameter	B45920	8
	1999-2000			B45919	8
Valve Stem Seal, Int.	2002-2003			B45921	8
	2001		2nd Design With 22.8mm Valve Guide Outside Diameter	B45921	8
			1st Design With 14.4mm Valve Guide Outside Diameter	B45922	8
	1999-2000			B45922	8
Manifold Set, Exhaust	1999-2003		<i>Multi-Layered Steel</i>	MS16124	1
Manifold Set, Intake	1999-2003			MS16340	1
Oil Pan Set	1999-2003			OS32241	1
Rear Main Seal Set	1999-2003			JV1657	1
Timing Cover Set	1999-2003		Requires Oil Pan Set	JV5022	1

MISCELLANEOUS GASKETS					
E.G.R. Gasket	1999-2002		Tube To Exhaust Manifold	G31535	1
			Valve	G31620	1
			(O-Ring Type), Pipe	G31626	1
Exhaust Pipe Gasket	1999-2003		Left, Pipe To Manifold	F31618	1
			Pipe To Manifold, Right	F31619	1
Oil Pan Drain Plug Gst.	1999-2003			B45828	1
Thermostat O-Ring	1999-2003			72141	1
Throttle Body Gasket	1999-2003			G31617	1
Water Pump Backing Plate	1999-2003		(O-Ring Type)	K31629	1
Water Pump Gasket	1999-2003			K31628	1

47	325 CID (5.3L) Vortec 5300 L59 Chevrolet Flex Fuel V8 Cyl, 3.780in./96mm (2002-2003)				47
-----------	---	--	--	--	-----------

<i>Part</i>	<i>Year</i>	<i>VIN</i>	<i>Model/Application</i>	<i>Part Number</i>	<i>Qty.</i>
ENGINE GASKETS					
Head Set	2002-2003		(Requires Head Set To Make Full Set)	HS54340	1
Lower Set	2002-2003		(Requires Head Set To Make Full Set)	CS5975	1
Cylinder Head Gasket	2002-2003		<i>Multi-Layered Steel</i>	54340	2
Cyl. Head Bolt Set	2002-2003			GS33380	2

General Motors Truck

47 325 CID (5.3L) Vortec 5300 L59 Chevrolet Flex Fuel V8 Cyl, 3.780in./96mm (2002-2003) **47**
 (cont.) (cont.)

Part Year VIN Model/Application Part Number Qty.

ENGINE GASKETS (cont.)

Valve Cover Set	2002-2003		<i>Victo-Tech</i>	VS50250	1
Valve Stem Seal, Exh.	2002-2003			B45920	8
Valve Stem Seal, Int.	2002-2003			B45921	8
Manifold Set, Exhaust	2002-2003		<i>Multi-Layered Steel</i>	MS16124	1
Manifold Set, Intake	2002-2003			MS16340	1
Oil Pan Set	2002-2003			OS32241	1
Rear Main Seal Set	2002-2003			JV1657	1
Timing Cover Set	2002-2003		Requires Oil Pan Set	JV5022	1

MISCELLANEOUS GASKETS

E.G.R. Gasket	2002-2003		Tube To Exhaust Manifold	G31535	1
	2002		Valve	G31620	1
				(O-Ring Type), Pipe	G31626
Exhaust Pipe Gasket	2002-2003		Left, Tube To Exhaust Manifold	F31618	1
			Right, Tube To Exhaust Manifold	F31619	1
Oil Pan Drain Plug Gst.	2002-2003			B45828	1
Thermostat O-Ring	2002-2003			72141	1
Throttle Body Gasket	2002-2003			G31617	1
Water Pump Backing Plate	2002-2003		(O-Ring Type)	K31629	1
Water Pump Gasket	2002-2003			K31628	1

48 327 CID (5.4L) Chevrolet V8 Cyl, 4.000in./101.6mm (1962-1969) **48**

Part Year VIN Model/Application Part Number Qty.

ENGINE GASKETS

Head Set	1962-1969		(Head Bolts Not Included, Exhaust Pipe Gasket Not Included, Contains Beaded Steel Cylinder Head Gasket)	HS1178BJ	1
			(Head Bolts Not Included, Exhaust Pipe Gasket Not Included, Contains VR2000 Cylinder Head Gasket)	HS1178VJ	1
Lower Set	1962-1969		(Requires Head Set To Make Full Set)	CS1178	1
Full Set	1962-1969		(Head Bolts Not Included, Exhaust Pipe Gasket Not Included, Contains Beaded Steel Cylinder Head Gasket)	FS1178BJ	1
			(Head Bolts Not Included, Exhaust Pipe Gasket Not Included, Contains VR2000 Cylinder Head Gasket)	FS1178VJ	1
Engine Kit Gasket Set	1962-1969			95-3033VR	1
Cylinder Head Gasket	1965-1969		Contoured Combustion Chamber, (Stainless Steel Flanges) <i>Nitroseal, 4.100" Combustion Chamber Opening</i>	54052	2
			<i>Beaded Steel</i>	1178BS	2
	1962-1969		Contoured Combustion Chamber, (Stainless Steel Flanges) <i>Nitroseal, 4.160" Combustion Chamber Opening</i>	1178SG	2
			<i>VR2000</i>	1178VC	2
			Cylindrical Combustion Chamber, (Stainless Steel Flanges) <i>Nitroseal</i>	3432SG	2
		(Cylindrical Combustion Chamber Openings, Gasket Has Steam Holes Required For Street Operation) <i>Stainless Steel, 8.8cc Combustion Chamber Volume, 4.190" Combustion Chamber Opening, .040" Compressed Operating Thickness</i>	3512	2	
Cyl. Head Bolt Set	1962-1969			GS33285	2
Valve Cover Set	1962-1969		<i>Cork Rubber</i>	VS38110	1
			<i>High Temperature Cork Rubber</i>	VS38110HA	1
			<i>High Temperature Tuff-Cork</i>	VS38110HTC	1
			<i>Victo-Tech</i>	VS38110R	1
			<i>Tuff-Cork</i>	VS38110TC	1
Valve Stem Seal, Exh.	1962-1969		(O-Ring Type)	B45229	8
			(Shedder Type)	B45264	8
			(High Temperature)	B45779	8
Valve Stem Seal, Int.	1962-1969		(O-Ring Type)	B45229	8

LIGHT TRUCK

48 327 CID (5.4L) Chevrolet V8 Cyl, 4.000in./101.6mm (1962-1969) **48**
(cont.) (cont.)

Part Year VIN Model/Application Part Number Qty.

ENGINE GASKETS (cont.)

Valve Stem Seal, Int. (cont.)	1962-1969		(Shedder Type)	B45264	8
			(High Temperature)	B45779	8
Manifold Set, Exhaust	1962-1969			MS7110X	1
Manifold Set, Intake	1962-1969			MS15315	1
Oil Pan Set	1962-1969			<i>Cork Rubber</i> OS30568X	1
				<i>Tuff-Cork</i> OS30568XTC	1
Rear Main Seal Set	1962-1969		(Lip Relocator Type)	JV1627	1
Timing Cover Set	1962-1969		(Repair Sleeve Not Included)	JV779	1
			(Contains Repair Sleeve)	JV919	1
Timing Cover Gasket	1962-1969			T27781	1
Timing Cover Seal	1962-1969			<i>3/8" Wide</i> 49328	1
			(Lip Relocator Type)	<i>1/2" Wide</i> 65022	1
Harmonic Balancer Repair Sleeve	1962-1969			<i>Ground Steel, .020" Thickness</i> 66597RS	1
				Use With Part Number A504 <i>Nickel Plated Formed Steel, .013" Thickness</i> A228	1

MISCELLANEOUS GASKETS

Air Cleaner Mount Gasket	1962-1969		2 Barrel Carburetor	G25936	1
			4 Barrel Carburetor	G26410	1
	1965-1968		4 Barrel Carburetor	G26410	1
	1962-1968		2 Barrel Carburetor	G25936	1
	1962-1966		4 Barrel Carburetor	G26410	1
Carb. Mount Gasket	1968-1969		4 Barrel Carburetor	G14579	1
	1962-1969		2 Barrel Carburetor, Except Heat Passage Cutouts	G7327	1
			2 Barrel Carburetor, Heat Passage Cutouts	G12216	1
	1968		4 Barrel Carburetor	G14579	1
	1962-1968		Except Heat Passage Cutouts, 2 Barrel Carburetor	G7327	1
			Heat Passage Cutouts, 2 Barrel Carburetor	G12216	1
1965-1967		4 Barrel Carburetor	G14112	1	
			4 Barrel Carburetor	G14112	1
Dist. Mounting Gasket	1962-1969			B25934	1
Exhaust Pipe Gasket	1962-1969		(Ring Type 'C'), Pipe To Manifold	F17250	1
			(Ring Type 'B'), Pipe To Manifold	<i>Sintered Metal</i> F17250S	1
Fuel Pump Gasket	1962-1969		Plate To Block	D25932	1
			Plate To Block	<i>Tuff-Cork</i> D25932TC	1
			Pump To Plate	D27094	1
			Pump To Plate	<i>Tuff-Cork</i> D27094TC	1
Heat Riser Gasket	1962-1969			F7135	1
Oil Pan Drain Plug Gst.	1962-1969			2051	1
Oil Pump Shaft Retainer	1962-1969			H31354	1
Water Outlet Gasket	1962-1969		(Universal Type)	C24109	1
				C25930	1
	1962-1968		1-13/16" Hole	C24109	1
	1962-1966		(Universal Type)	C24109	1
Water Pump Backing Plate	1962-1969			K27091	1
Water Pump Mount Gasket	1962-1969			K25935	2

49 327 CID (5.4L) Chevrolet LPG V8 Cyl, 4.000in./101.6mm (1962-1969) **49**

Part Year VIN Model/Application Part Number Qty.

ENGINE GASKETS

Engine Kit Gasket Set	1962-1969			95-3033VR	1
-----------------------	-----------	--	--	-----------	---

LIGHT TRUCK

General Motors Truck

50 336 CID (5.5L) General Motors V8 Cyl, 3.875in./98.4mm (1958-1959) 50

Part	Year	VIN	Model/Application	Part Number	Qty.
ENGINE GASKETS					
Manifold Set, Exhaust	1959		From Engine Serial Number 33635001	MS15085W	1
Rear Main Seal Set	1959		From Engine Serial Number 33635001	JV708	1
Timing Cover Set	1958-1959			JV817	1

51 348 CID (5.7L) Chevrolet V8 Cyl, 4.125in./104.8mm (1958-1965) 51

Part	Year	VIN	Model/Application	Part Number	Qty.
ENGINE GASKETS					
Head Set	1960-1961		(Exhaust Pipe Gasket Not Included, Exhaust Manifold Gasket Not Included)	HS1195VC	1
Full Set	1960-1961		(Exhaust Pipe Gasket Not Included, Exhaust Manifold Gasket Not Included)	FS1195VC	1
Cylinder Head Gasket	1960-1961		VR2000	1195VC	2
Valve Cover Set	1960-1961		Cork Rubber	VS38408	1
Manifold Set, Exhaust	1960-1961			MS15151	1
Manifold Set, Intake	1960-1961			MS18699	1
Oil Pan Set	1960-1961		Cork Rubber	OS30525	1
Rear Main Seal Set	1960-1961			JV699	1
Timing Cover Set	1960-1961			JV802	1
Timing Cover Seal	1960-1961		3/8" Wide	49328	1
			(Lip Relocator Type) 1/2" Wide	65022	1
Harmonic Balancer Repair Sleeve	1960-1961		Ground Steel, .020" Thickness	66597RS	1
			Use With Part Number A504 Nickel Plated Formed Steel, .013" Thickness	A228	1

MISCELLANEOUS GASKETS

Air Cleaner Mount Gasket	1960-1961		2 Barrel Carburetor	G25936	1
			4 Barrel Carburetor	G26410	1
Carb. Mount Gasket	1960-1961		2 Barrel Carburetor	G7327	1
			4 Barrel Carburetor	G14112	1
Dist. Mounting Gasket	1960-1961			B25934	1
Exhaust Pipe Gasket	1960-1961		(Ring Type 'C'), Pipe To Manifold	F17250	1
			(Ring Type 'B'), Pipe To Manifold	Sintered Metal F17250S	1
Fuel Pump Gasket	1958-1965			Tuff-Cork D27094TC	1
	1960-1961			D27094	1
Oil Pan Drain Plug Gst.	1960-1961			2051	1
Oil Pump Shaft Retainer	1958-1964			H31354	1
Water Outlet Gasket	1960-1961		1-13/16" Hole	C24109	1
Water Pump Gasket	1960-1961		Pump To Plate	K27078	1
Water Pump Mount Gasket	1960-1961			K26004	2

52 350 CID (5.7L) Carbureted Chevrolet V8 Cyl, 4.000in./101.6mm (1969-1989) 52

Part	Year	VIN	Model/Application	Part Number	Qty.
ENGINE GASKETS					
Head Set	1975-1989		(Head Bolts Not Included, Exhaust Pipe Gasket Not Included, Contains VR2000 Cylinder Head Gasket)	HS1178VK	1
	1969-1974		(Head Bolts Not Included, Exhaust Pipe Gasket Not Included, Contains Beaded Steel Cylinder Head Gasket)	HS1178BJ	1
			(Head Bolts Not Included, Exhaust Pipe Gasket Not Included, Contains VR2000 Cylinder Head Gasket)	HS1178VJ	1
Lower Set	1986-1989		(Requires Head Set To Make Full Set)	CS1178A	1
	1969-1985		(Requires Head Set To Make Full Set)	CS1178	1
Full Set	1986-1989		(Head Bolts Not Included, Exhaust Pipe Gasket Not Included, Contains VR2000 Cylinder Head Gasket)	FS1178VP	1

52 (cont.)	350 CID (5.7L) Carbureted Chevrolet V8 Cyl, 4.000in./101.6mm (1969-1989)				52 (cont.)
---------------	--	--	--	--	---------------

Part	Year	VIN	Model/Application	Part Number	Qty.
ENGINE GASKETS (cont.)					
Full Set (cont.)	1975-1985		(Head Bolts Not Included, Exhaust Pipe Gasket Not Included, Contains VR2000 Cylinder Head Gasket)	FS1178VK	1
	1969-1985		(Performer, Contains Stainless Steel Layered Type Head Gasket)	FS3512	1
	1969-1974		(Exhaust Pipe Gasket Not Included, Contains Beaded Steel Cylinder Head Gasket)	FS1178BJ	1
			(Exhaust Pipe Gasket Not Included)	FS1178VJ	1
Engine Kit Gasket Set	1986-1989		2 Barrel Carburetor	95-3444VR	1
	1986-1988		(Exhaust Valve Stem Seal For 3/8" Valve Stem Diameter For Series 10 And 20 Not Included), 4 Barrel Carburetor, Use With Part Number B45874 (8)	95-3444VR	1
	1981-1985		(Exhaust Valve Stem Seal For 3/8" Valve Stem Diameter For Series 10 And 20 Not Included), Use With Part Number B45874 (8)	95-3072VR	1
	1969-1980			95-3033VR	1
Cylinder Head Gasket	1969-1989		<i>Beaded Steel</i>	1178BS	2
			Contoured Combustion Chamber, (Stainless Steel Flanges) <i>Nitroseal, 4.160" Combustion Chamber Opening</i>	1178SG	2
			<i>VR2000</i>	1178VC	2
			Cylindrical Combustion Chamber, (Stainless Steel Flanges) <i>Nitroseal</i>	3432SG	2
			(Cylindrical Combustion Chamber Openings, Gasket Has Steam Holes Required For Street Operation) <i>Stainless Steel, 8.8cc Combustion Chamber Volume, 4.190" Combustion Chamber Opening, .040" Compressed Operating Thickness</i>	3512	2
			(Single Sided Graphite) <i>Nitroseal</i>	5746	2
			Contoured Combustion Chamber, (Stainless Steel Flanges) <i>Nitroseal, 4.100" Combustion Chamber Opening</i>	54052	2
Cyl. Head Bolt Set	1969-1989			GS33285	2
Valve Cover Set	1969-1989		<i>Cork Rubber</i>	VS38110	1
			<i>High Temperature Cork Rubber</i>	VS38110HA	1
			<i>High Temperature Tuff-Cork</i>	VS38110HTC	1
			<i>Victo-Tech</i>	VS38110R	1
			<i>Tuff-Cork</i>	VS38110TC	1
Valve Stem Seal, Exh.	1981-1989		3/8" Valve Stem, (Shedder Type)	B45874	8
	1969-1989		(O-Ring Type)	B45229	8
			(Shedder Type)	B45264	8
			(High Temperature)	B45779	8
Valve Stem Seal, Int.	1969-1989		(O-Ring Type)	B45229	8
			(Shedder Type)	B45264	8
			(Positive Type) <i>Fluoroelastomer</i>	B45418	8
			(High Temperature)	B45779	8
Manifold Set, Exhaust	1969-1989			MS7110X	1
Manifold Set, Intake	1969-1989		Liquid Propane Gas	MS15219BF	1
				MS15315	1
Oil Pan Set	1986-1989		<i>Tuff-Cork</i>	OS32471TC	1
			<i>Victo-Tech</i>	OS32496	1
			(Original Equipment Style Steel Backbone) <i>Victo-Tech</i>	OS32496B	1
	1980-1985		Right Hand Dip Stick <i>Victo-Tech</i>	OS30568RRH	1
			<i>Tuff-Cork</i>	OS30572TC	1
	1975-1985		<i>Cork Rubber</i>	OS30568Z	1
	1975-1979		Left Hand Dip Stick <i>Victo-Tech</i>	OS30568RLH	1
			<i>Tuff-Cork</i>	OS30568ZTC	1
	1969-1974		<i>Cork Rubber</i>	OS30568X	1
			<i>Tuff-Cork</i>	OS30568XTC	1
Rear Main Seal Set	1986-1989		(1 Piece)	JV554	1
			<i>Teflon</i>	JV1634	1
	1969-1985		(Lip Relocator Type)	JV1627	1

General Motors Truck

52 350 CID (5.7L) Carbureted Chevrolet V8 Cyl, 4.000in./101.6mm (1969-1989) **52**
 (cont.) (cont.)

Part Year VIN Model/Application Part Number Qty.

ENGINE GASKETS (cont.)

Crank Repair Sleeve	1986-1989		Use With Part Number A506, Rear <i>Nickel Plated Formed Steel, .013" Thickness</i>	A338	1
Seal Extender	1986-1989			E300	1
Timing Cover Set	1986-1989		(Repair Sleeve Not Included)	JV1041	1
	1975-1985		(Repair Sleeve Not Included)	JV881	1
			(Contains Repair Sleeve)	JV926	1
	1969-1974			JV779	1
		(Contains Repair Sleeve)	JV919	1	
Timing Cover Gasket	1969-1989			T27781	1
Timing Cover Seal	1969-1989		<i>3/8" Wide</i>	49328	1
			(Lip Relocator Type) <i>1/2" Wide</i>	65022	1
Harmonic Balancer Repair Sleeve	1969-1989		<i>Ground Steel, .020" Thickness</i>	66597RS	1
			Use With Part Number A504 <i>Nickel Plated Formed Steel, .013" Thickness</i>	A228	1

MISCELLANEOUS GASKETS

Air Cleaner Mount Gasket	1973-1989		2 Barrel Carburetor	G26617	1
	1969-1989		4 Barrel Carburetor	G31176	1
	1969-1972		2 Barrel Carburetor	G25936	1
Carb. Mount Gasket	1981-1989		4 Barrel Carburetor	G26792	1
	1979-1982		2 Barrel Carburetor	G26711	1
	1974-1980		4 Barrel Carburetor	G26719	1
	1974-1976		2 Barrel Carburetor	G26711	1
	1971-1973		4 Barrel Carburetor	G26666	1
	1970		4 Barrel Carburetor	G18565	1
	1969-1970		2 Barrel Carburetor, 40 Series	G7327	1
	1969		4 Barrel Carburetor	G14579	1
	Choke Tube Gasket	1975-1985			B45787
Dist. Mounting Gasket	1969-1989			B25934	1
E.G.R. Gasket	1987-1989			G31178	1
	1975-1986			G26748	2
	1973-1974			G17797	1
Exhaust Pipe Gasket	1985-1988		(Ring Type 'E'), Pipe To Manifold	F7447	1
	1983-1984		(Ring Type 'E'), Pipe To Manifold	F7269	2
	1969-1982		(Flange Type), Pipe To Manifold	F7135	1
			2.5" Pipe, (Ring Type 'C'), Pipe To Manifold	F7139	2
			2.5" Pipe, (Ring Type 'B'), Pipe To Manifold <i>Sintered Metal</i>	F7139S	1
			2" Pipe, (Ring Type 'C'), Pipe To Manifold	F17250	1
			2" Pipe, (Ring Type 'B'), Pipe To Manifold <i>Sintered Metal</i>	F17250S	1
1970-1974		1.875" Pipe, (Ring Type 'E'), Pipe To Manifold	F17355	1	
Fuel Pump Gasket	1969-1989		Plate To Block	D25932	1
			Plate To Block <i>Tuff-Cork</i>	D25932TC	1
			Pump To Plate	D27094	1
			Pump To Plate <i>Tuff-Cork</i>	D27094TC	1
Heat Riser Gasket	1981-1985			F7135	1
	1969-1980		3 Bolt <i>2.437" Inside Diameter</i>	F7192	1
Oil Cooler Gasket	1976-1989		2 Wheel Drive, (Contains Gasket Only), Adapter To Block	H31318	1
	1976-1986		Rear Wheel Drive, (Contains Gasket Only), Adapter To Block	H31318	1
Oil Cooler Mount Kit	1976-1989		(Contains O-Ring And Gasket Mounting Kit), Adapter To Block	GS33272	1
Oil Pan Drain Plug Gst.	1969-1989		English Thread	2051	1
Oil Pump Shaft Retainer	1969-1989			H31354	1
Water Outlet Gasket	1969-1989		(Universal Type)	C24109	1
				C25930	1

LIGHT TRUCK

52 350 CID (5.7L) Carbureted Chevrolet V8 Cyl, 4.000in./101.6mm (1969-1989) **52**
(cont.) (cont.)

Part	Year	VIN	Model/Application	Part Number	Qty.
MISCELLANEOUS GASKETS (cont.)					
Water Pump Backing Plate	1980-1989			K27091	1
	1969-1989		Pump To Plate	K27091	1
	1969-1988			K27091	1
Water Pump Mount Gasket	1969-1989			K25935	2

53 350 CID (5.7L) Fuel Injected Chevrolet V8 Cyl, 4.000in./101.6mm (1987-2002) **53**

Part	Year	VIN	Model/Application	Part Number	Qty.
------	------	-----	-------------------	-------------	------

ENGINE GASKETS					
Head Set	1996-2002	R	(Contains Graphite Head Gasket, Exhaust Pipe Gasket Not Included, Plenum Chamber Gasket Not Included)	HS5746B	1
	1987-1995		(Exhaust Pipe Gasket Not Included, Contains VR2000 Cylinder Head Gasket)	HS1178VN	1
			(Contains Graphite Head Gasket, Exhaust Pipe Gasket Not Included)	HS5746A	1
Lower Set	1996-2002	R	(Requires Head Set To Make Full Set, Timing Cover Gasket And Seal Not Included)	CS5746	1
	1993-1995		(Requires Head Set To Make Full Set)	CS1178C	1
	1987-1992		(Requires Head Set To Make Full Set)	CS1178A	1
Full Set	1987-1995	K	(Head Bolts Not Included, Exhaust Pipe Gasket Not Included, Contains VR2000 Cylinder Head Gasket)	FS1178VN	1
Engine Kit Gasket Set	1996-1999		(Timing Cover Gasket And Seal Not Included), Use With Part Number 48382	95-3488VR	1
	1987-1995	K	(Exhaust Valve Stem Seal For 3/8" Valve Stem Diameter For Series 10 And 20 Not Included), Use With Part Number B45874 (8)	95-3418VR	1
Cylinder Head Gasket	1987-2002		<i>Beaded Steel</i>	1178BS	2
			Contoured Combustion Chamber, (Stainless Steel Flanges) <i>Nitroseal, 4.160" Combustion Chamber Opening</i>	1178SG	2
			<i>VR2000</i>	1178VC	2
			Cylindrical Combustion Chamber, (Stainless Steel Flanges) <i>Nitroseal</i>	3432SG	2
			(Cylindrical Combustion Chamber Openings, Gasket Has Steam Holes Required For Street Operation) <i>Stainless Steel, 8.8cc Combustion Chamber Volume, 4.190" Combustion Chamber Opening, .040" Compressed Operating Thickness</i>	3512	2
			(Single Sided Graphite) <i>Nitroseal</i>	5746	2
			Contoured Combustion Chamber, (Stainless Steel Flanges) <i>Nitroseal, 4.100" Combustion Chamber Opening</i>	54052	2
Cyl. Head Bolt Set	1987-2002			GS33285	2
Valve Cover Set	1994-2002		(Single Valve Cover) <i>Victo-Tech</i>	VS50163	2
	1987-2002		<i>Tuff-Cork</i>	VS50025TC	1
			(Single Valve Cover) <i>Tuff-Cork</i>	VS50126TC	2
			<i>Victo-Tech</i>	VS50161	1
Valve Stem Seal, Exh.	1996-2002	R		B45796	8
	1996	K	(O-Ring Type)	B45229	8
		K	(Shedder Type)	B45264	8
		K	(Shedder Type, High Temperature)	B45779	8
		K	3/8" Valve Stem, (Shedder Type)	B45874	8
	1987-1995		(O-Ring Type)	B45229	8
			(Shedder Type)	B45264	8
			(Shedder Type, High Temperature)	B45779	8
		3/8" Valve Stem, (Shedder Type)	B45874	8	
Valve Stem Seal, Int.	1996-2002	R		B45796	8
	1996	K	(O-Ring Type)	B45229	8
		K	(Shedder Type)	B45264	8
		K	(Positive Type) <i>Fluoroelastomer</i>	B45418	8

LIGHT TRUCK

General Motors Truck

53 350 CID (5.7L) Fuel Injected Chevrolet V8 Cyl, 4.000in./101.6mm (1987-2002) **53**
 (cont.) (cont.)

Part Year VIN Model/Application Part Number Qty.

ENGINE GASKETS (cont.)

Valve Stem Seal, Int. (cont.)	1996	K	(Shedder Type, High Temperature)	B45779	8
	1987-1996		(Positive Type) <i>Fluoroelastomer</i>	B45418	8
	1987-1995		(O-Ring Type)	B45229	8
			(Shedder Type)	B45264	8
			(Shedder Type, High Temperature)	B45779	8
Manifold Set, Exhaust	1996-2002	R		MS16093	1
	1987-1996			MS7110X	1
		K		MS7110X	1
Manifold Set, Intake	1996-2002	R	(Plenum Chamber Gasket Not Included)	MS16167	1
	1987-1996	K		MS15401	1
Plenum Chamber Gasket	1996-2002	R	(Contains Plenum)	MS14804	1
Oil Pan Set	1987-1999		<i>Tuff-Cork</i>	OS32471TC	1
			<i>Victo-Tech</i>	OS32496	1
			(Original Equipment Style Steel Backbone) <i>Victo-Tech</i>	OS32496B	1
Rear Main Seal Set	1997-2002			JV1620	1
	1996	K	(1 Piece)	JV554	1
		R		JV1620	1
		K	(1 Piece) <i>Teflon</i>	JV1634	1
	1987-1995		(1 Piece)	JV554	1
			(1 Piece) <i>Teflon</i>	JV1634	1
Crank Repair Sleeve	1996	K	Use With Part Number A506, Rear <i>Nickel Plated Formed Steel, .013" Thickness</i>	A338	1
	1987-1995		Use With Part Number A506, Rear <i>Nickel Plated Formed Steel, .013" Thickness</i>	A338	1
Seal Extender	1987-1996	K		E300	1
Timing Cover Set	1987-1996	K	(Repair Sleeve Not Included)	JV1041	1
Timing Cover Gasket	1987-1996	K		T27781	1
Timing Cover Seal	1996-2002	R		48382	1
	1987-1996	K		<i>3/8" Wide</i> 49328	1
		K	(Lip Relocator Type) <i>1/2" Wide</i>	65022	1
Harmonic Balancer Repair Sleeve	1996	K	<i>Ground Steel, .020" Thickness</i>	66597RS	1
		K	Use With Part Number A504 <i>Nickel Plated Formed Steel, .013" Thickness</i>	A228	1
	1987-1995		<i>Ground Steel, .020" Thickness</i>	66597RS	1
			Use With Part Number A504 <i>Nickel Plated Formed Steel, .013" Thickness</i>	A228	1

MISCELLANEOUS GASKETS

Air Cleaner Mount Gasket	1987-1995		Throttle Body Injection	G27098	2
Dist. Mounting Gasket	1987-2002			B25934	1
E.G.R. Gasket	1996-1999	R		G31304	1
	1987-1996	K		G31178	1
	1994-1995	A		G31178	1
Exhaust Pipe Gasket	1996-2002		Express 1500, Express 2500, Express 2500 EXT, Express 3500, Express 3500 EXT, Savana 1500, Savana 2500, Savana 2500 EXT, Savana 3500, Savana 3500 EXT, (3 Holes), Converter To Exhaust Pipe	F7538	1
	1996-2001	R	(Ring Type 'E'), Pipe To Manifold	F17990	2
	1996-1999		G1500, G1500(GMC), G2500, G2500(GMC), G3500, G3500(GMC), (3 Holes), Converter To Exhaust Pipe	F7538	1
	1994-1995	A	(Ring Type 'E'), Pipe To Manifold	F7507	1
	1987-1995	K	(Ring Type 'E'), Pipe To Manifold	F7507	1
Fuel Pump Gasket	1987-1995		Plate To Block	D25932	1
			Plate To Block <i>Tuff-Cork</i>	D25932TC	1
			Pump To Plate	D27094	1
			Pump To Plate <i>Tuff-Cork</i>	D27094TC	1

LIGHT TRUCK

53 350 CID (5.7L) Fuel Injected Chevrolet V8 Cyl, 4.000in./101.6mm (1987-2002) **53**
(cont.) (cont.)

Part	Year	VIN	Model/Application	Part Number	Qty.
MISCELLANEOUS GASKETS (cont.)					
Oil Cooler Gasket	1987-1999		2 Wheel Drive, (Contains Gasket Only), Adapter To Block	H31318	1
	1992-1994		Rear Wheel Drive, (Contains Gasket Only), Adapter To Block	H31318	1
Oil Cooler Mount Kit	1987-2000		(Contains O-Ring And Gasket Mounting Kit), Adapter To Block	GS33272	1
Oil Pan Drain Plug Gst.	1996-2002		Metric Thread 10.7mm Inside Diameter	B45828	1
	1987-1996		English Thread 1/2" Inside Diameter	2051	1
Oil Pump Shaft Retainer	1987-2002			H31354	1
Thermostat Seal	1991-1999		Victo-Tech	C31273	1
Throttle Body Gasket	1996-2002	R		G31329	1
	1995		Over 8500 Pound Gross Vehicle Weight	G31342	1
	1991-1995		Under 8500 Pound Gross Vehicle Weight	G31133	1
	1987-1990			G30948	1
Water Outlet Gasket	1987-1990		(Universal Type)	C24109	1
				C25930	1
Water Pump Backing Plate	1987-2002			K27091	1
Water Pump Mount Gasket	1987-2002			K25935	2

54 350 CID (5.7L) KL5 Chevrolet CNG V8 Cyl, 4.000in./101.6mm (1997-2000) **54**

Part	Year	VIN	Model/Application	Part Number	Qty.
ENGINE GASKETS					
Head Set	1997-1999	R	(Contains Graphite Head Gasket, Exhaust Pipe Gasket Not Included, Plenum Chamber Gasket Not Included)	HS5746B	1
Cylinder Head Gasket	1997-2000		Beaded Steel	1178BS	2
			Contoured Combustion Chamber, (Stainless Steel Flanges) Nitroseal, 4.160" Combustion Chamber Opening	1178SG	2
			VR2000	1178VC	2
			Cylindrical Combustion Chamber, (Stainless Steel Flanges) Nitroseal	3432SG	2
			(Cylindrical Combustion Chamber Openings, Gasket Has Steam Holes Required For Street Operation) Stainless Steel, 8.8cc Combustion Chamber Volume, 4.190" Combustion Chamber Opening, .040" Compressed Operating Thickness	3512	2
			(Single Sided Graphite) Nitroseal	5746	2
Valve Cover Set	1997-2000		Tuff-Cork	VS50025TC	1
			(Single Valve Cover) Tuff-Cork	VS50126TC	2
			Victo-Tech	VS50161	1
Valve Stem Seal, Exh.	1997-2000	R		B45796	8
Valve Stem Seal, Int.	1997-2000	R		B45796	8
Manifold Set, Exhaust	1997-2000			MS16093	1
Manifold Set, Intake	1997-2000		(Plenum Chamber Gasket Not Included)	MS16167	1
Plenum Chamber Gasket	1997-2000			MS14804	1
Oil Pan Set	1997-1999		Tuff-Cork	OS32471TC	1
			Victo-Tech	OS32496	1
			(Original Equipment Style Steel Backbone) Victo-Tech	OS32496B	1
Rear Main Seal Set	1997-2000			JV1620	1

LIGHT TRUCK

General Motors Truck

55 350 CID (5.7L) Oldsmobile Diesel V8 Cyl, 4.057in./103mm (1978-1984)

55

Part	Year	VIN	Model/Application	Part Number	Qty.
ENGINE GASKETS					
Head Set	1981		2 Stud Air Cleaner, Internal Exhaust Gas Recirculation	HS3685W	1
			.010" Thicker And .030" Overbore Cylinder Head Gasket, 2 Stud Air Cleaner, Internal Exhaust Gas Recirculation, (Exhaust Gasket Not Included)	HS3736W	1
	1978-1981		1 Stud Air Cleaner, External Exhaust Gas Recirculation	HS3685	1
	1978-1980		.010" Thicker And .030" Overbore Cylinder Head Gasket, 1 Stud Air Cleaner, External Exhaust Gas Recirculation, (Exhaust Gasket Not Included)	HS3736	1
Full Set	1981		2 Stud Air Cleaner, Internal Exhaust Gas Recirculation	FS3685W	1
			.010" Thicker And .030" Overbore Cylinder Head Gasket, 2 Stud Air Cleaner, Internal Exhaust Gas Recirculation	FS3736W	1
	1978-1980		1 Stud Air Cleaner, External Exhaust Gas Recirculation, (Exhaust Gasket Not Included)	FS3685	1
			.010" Thicker And .030" Overbore Cylinder Head Gasket, 1 Stud Air Cleaner, External Exhaust Gas Recirculation, (Exhaust Gasket Not Included)	FS3736	1
Engine Kit Gasket Set	1981-1984		Internal Exhaust Gas Recirculation, (Intake Manifold Gasket Not Included), Use With Part Number MS15321	95-3085VR	1
	1978-1981		External Exhaust Gas Recirculation, (Intake Manifold Gasket Not Included), Use With Part Number MS15122	95-3085VR	1
Cylinder Head Gasket	1978-1981		<i>Solicor</i>	3685SCR	2
			.010" Thicker And .030" Overbore Cylinder Head Gasket <i>Nitroseal</i>	3736	2
Valve Cover Set	1978-1981		<i>Cork Rubber</i>	VS38305	1
			<i>High Temperature Cork Rubber</i>	VS38305H	1
			<i>Victo-Tech</i>	VS38305R	1
			<i>Tuff-Cork</i>	VS38305TC	1
Valve Stem Seal, Exh.	1978-1981			B45416	8
Valve Stem Seal, Int.	1978-1981			B45416	8
Manifold Set, Exhaust	1978-1981			MS15141	1
Manifold Set, Intake	1981		2 Stud Air Cleaner, Internal Exhaust Gas Recirculation	MS15321	1
	1978-1980		1 Stud Air Cleaner, External Exhaust Gas Recirculation	MS15122	1
Oil Pan Set	1978-1981		<i>Tuff-Cork</i>	OS30534TC	1
Rear Main Seal Set	1978-1981		<i>Molded Rubber</i>	JV618	1
			<i>Rope Packing</i>	JV749	1
Timing Cover Set	1978-1981			JV845	1
Timing Cover Gasket	1978-1981			T27823	1
Timing Cover Seal	1978-1981			47398	1
Harmonic Balancer Repair Sleeve	1978-1981		Use With Part Number A500 <i>Nickel Plated Formed Steel, .013" Thickness</i>	A231	1
MISCELLANEOUS GASKETS					
Air Cleaner Mount Gasket	1978-1981			G27098	1
Air Crossover Gasket	1981		2 Stud Air Cleaner, Internal Exhaust Gas Recirculation	H30786	2
	1978-1980		1 Stud Air Cleaner, External Exhaust Gas Recirculation	H30787	2
E.G.R. Gasket	1981			G26280	1
Exhaust Pipe Gasket	1978-1981		(Ring Type 'E'), Pipe To Manifold	F7207	1
Fuel Pump Gasket	1978-1981			D26606	1
			<i>Tuff-Cork</i>	D26606TC	1
Inj. Pump Mtg. Adapter	1978-1981			72216	1
Inj. Pump Mtg. Gasket	1978-1981			B26350	1
Oil Filter Mount Gasket	1978-1981			B26607	1
Oil Pan Drain Plug Gst.	1978-1981			2051	1
Oil Pump Cover Gasket	1978-1981			B45813	1
Water Outlet Gasket	1978-1984			C24111	1
Water Pump Mount Gasket	1978-1981		Air Conditioning, Heavy Duty Cooling	K27156	1

LIGHT TRUCK

General Motors Truck

55	350 CID (5.7L) Oldsmobile Diesel V8 Cyl, 4.057in./103mm (1978-1984)	55
(cont.)		(cont.)

Part	Year	VIN	Model/Application	Part Number	Qty.
------	------	-----	-------------------	-------------	------

MISCELLANEOUS GASKETS (cont.)

Water Pump Mount Gasket (cont.)	1978-1981		Air Conditioning, Heavy Duty Cooling	<i>Tuff-Cork</i> K27156TC	1
			Except Air Conditioning, Except Heavy Duty Cooling	K27821A	1
			Except Air Conditioning, Except Heavy Duty Cooling	<i>Tuff-Cork</i> K27821ATC	1

56	351 CID (5.8L) General Motors V6 Cyl, 4.563in./115.9mm (1960-1972)	56
-----------	---	-----------

Part	Year	VIN	Model/Application	Part Number	Qty.
------	------	-----	-------------------	-------------	------

ENGINE GASKETS

Head Set	1966-1972		C Series	HS3463	1	
			1966-1969	E And M Series	HS3379J	1
			1960-1965		HS3463	1
Full Set	1966-1972		C Series	FS3463J	1	
	1966-1969		E And M Series	FS3379J	1	
	1960-1965			FS3463J	1	
Cylinder Head Gasket	1960-1972		<i>VR2000</i>	3379	2	
Valve Cover Set	1960-1972		<i>Cork Rubber</i>	VS38290	1	
Valve Stem Seal, Int.	1960-1972		(O-Ring Type)	B45229	6	
Manifold Set, Exhaust	1966-1972		C Series	MS10009	1	
	1966-1969		E And M Series	MS10019BS	1	
	1960-1965			MS10009	1	
Manifold Set, Intake	1970-1972		C Series	MS15955	1	
	1966-1969		C, E And M Series	MS15512	1	
	1960-1965			MS15955	1	
Oil Pan Set	1960-1972		<i>Cork Rubber</i>	OS31577	1	
Rear Main Seal Set	1960-1972			JV716	1	
Timing Cover Set	1960-1972			JV815	1	
Harmonic Balancer Repair Sleeve	1960-1972		Use With Part Number A503 <i>Nickel Plated Formed Steel, .013" Thickness</i>	A227	1	

MISCELLANEOUS GASKETS

Air Cleaner Mount Gasket	1960-1970		2 Barrel Carburetor	G25936	1
Carb. Mount Gasket	1960-1972		2 Barrel Carburetor	G26685	1
Exhaust Pipe Gasket	1960-1972		(Flange Type), Pipe To Manifold	F7135	1
Fuel Pump Gasket	1960-1972			D27094	1
				<i>Tuff-Cork</i> D27094TC	1
Push Rod Cover Set	1960-1972			PS38029	1
Water Outlet Gasket	1967-1972		Hydraulic Brakes	C24109	1
			Air Brakes	C26501	1
	1960-1966			C24109	1
Water Pump Mount Gasket	1960-1972			K27540	1

57	365 CID (6.0L) Vortec 6000 Chevrolet V8 Cyl, 4.000in./101.6mm (1999-2003)	57
-----------	--	-----------

Part	Year	VIN	Model/Application	Part Number	Qty.
------	------	-----	-------------------	-------------	------

ENGINE GASKETS

Head Set	2002-2003		(Head Bolts Not Included)	HS54332	1	
			2001	Valve Stem Seals Used With 14.4mm Outside Diameter Guides Not Included, (Head Bolts Not Included)	HS54332	1
			1999-2000	(Head Bolts Not Included)	HS54341	1
Lower Set	1999-2003		(Requires Head Set To Make Full Set)	CS5975	1	
Cylinder Head Gasket	2001-2003		<i>Multi-Layered Steel</i>	54332	2	
	1999-2000		<i>VR2000</i>	54341	2	
Cyl. Head Bolt Set	1999-2003			GS33380	2	
Valve Cover Set	1999-2003		<i>Victo-Tech</i>	VS50250	1	
Valve Stem Seal, Exh.	2002-2003			B45920	8	

General Motors Truck

57 (cont.)	365 CID (6.0L) Vortec 6000 Chevrolet V8 Cyl, 4.000in./101.6mm (1999-2003)				57 (cont.)
----------------------	--	--	--	--	----------------------

Part	Year	VIN	Model/Application	Part Number	Qty.
ENGINE GASKETS (cont.)					
Valve Stem Seal, Exh. (cont.)	2001		1st Design With 14.4mm Valve Guide Outside Diameter	B45919	8
			2nd Design With 22.8mm Valve Guide Outside Diameter	B45920	8
	1999-2000			B45919	8
Valve Stem Seal, Int.	2002-2003			B45921	8
	2001		2nd Design With 22.8mm Valve Guide Outside Diameter	B45921	8
			1st Design With 14.4mm Valve Guide Outside Diameter	B45922	8
1999-2000			B45922	8	
Manifold Set, Exhaust	1999-2003		<i>Multi-Layered Steel</i>	MS16124	1
Manifold Set, Intake	1999-2003			MS16340	1
Oil Pan Set	1999-2003			OS32241	1
Rear Main Seal Set	1999-2003			JV1657	1
Timing Cover Set	1999-2003		Requires Oil Pan Set	JV5022	1

MISCELLANEOUS GASKETS

E.G.R. Gasket	1999-2002		Pipe To Manifold	G31535	1
			Valve	G31620	1
			(O-Ring Type), Pipe	G31626	1
Exhaust Pipe Gasket	1999-2003		Pipe To Manifold	F31618	2
Oil Pan Drain Plug Gst.	1999-2003			B45828	1
Thermostat O-Ring	1999-2003			72141	1
Throttle Body Gasket	1999-2003			G31617	1
Water Pump Backing Plate	1999-2003		(O-Ring Type)	K31629	1
Water Pump Gasket	1999-2003			K31628	1

58	365 CID (6.0L) Vortec 6000 LQ4 (KL6) Chevrolet Bi-Fuel Gasoline/Compressed Natural Gas V8 Cyl, 4.000in./101.6mm (2002-2003)				58
-----------	--	--	--	--	-----------

Part	Year	VIN	Model/Application	Part Number	Qty.
ENGINE GASKETS					
Head Set	2002-2003		(Head Bolts Not Included)	HS54332	1
Lower Set	2002-2003		(Requires Head Set To Make Full Set)	CS5975	1
Cylinder Head Gasket	2002-2003		<i>Multi-Layered Steel</i>	54332	2
Cyl. Head Bolt Set	2002-2003			GS33380	2
Valve Cover Set	2002-2003		<i>Victo-Tech</i>	VS50250	1
Valve Stem Seal, Exh.	2002-2003			B45920	8
Valve Stem Seal, Int.	2002-2003			B45921	8
Manifold Set, Exhaust	2002-2003		<i>Multi-Layered Steel</i>	MS16124	1
Manifold Set, Intake	2002-2003			MS16340	1
Oil Pan Set	2002-2003			OS32241	1
Rear Main Seal Set	2002-2003			JV1657	1
Timing Cover Set	2002-2003		Requires Oil Pan Set	JV5022	1

MISCELLANEOUS GASKETS

E.G.R. Gasket	2002		Valve	G31620	1
			(O-Ring Type), Pipe	G31626	1
Exhaust Pipe Gasket	2002-2003		Pipe To Manifold	F31618	2
Oil Pan Drain Plug Gst.	2003			B45828	1
Thermostat O-Ring	2002-2003			72141	1
Throttle Body Gasket	2002-2003			G31617	1
Water Pump Backing Plate	2002-2003		(O-Ring Type)	K31629	1
Water Pump Gasket	2002-2003			K31628	1

59 365 CID (6.0L) Vortec 6000 LQ4 (KL8) Chevrolet CNG V8 Cyl, 4.000in./101.6mm (2003) 59

Part	Year	VIN	Model/Application	Part Number	Qty.
ENGINE GASKETS					
Head Set	2003		(Head Bolts Not Included)	HS54332	1
Lower Set	2003		(Requires Head Set To Make Full Set)	CS5975	1
Cylinder Head Gasket	2003		<i>Multi-Layered Steel</i>	54332	2
Cyl. Head Bolt Set	2003			GS33380	2
Valve Cover Set	2003		<i>Victo-Tech</i>	VS50250	1
Valve Stem Seal, Exh.	2003			B45920	8
Valve Stem Seal, Int.	2003			B45921	8
Manifold Set, Exhaust	2003		<i>Multi-Layered Steel</i>	MS16124	1
Manifold Set, Intake	2003			MS16340	1
Oil Pan Set	2003			OS32241	1
Rear Main Seal Set	2003			JV1657	1
Timing Cover Set	2003		Requires Oil Pan Set	JV5022	1

MISCELLANEOUS GASKETS					
Exhaust Pipe Gasket	2003		Pipe To Manifold	F31618	2
Oil Pan Drain Plug Gst.	2003			B45828	1
Thermostat O-Ring	2003			72141	1
Throttle Body Gasket	2003			G31617	1
Water Pump Backing Plate	2003		(O-Ring Type)	K31629	1
Water Pump Gasket	2003			K31628	1

60 366 CID (6.0L) Chevrolet V8 Cyl, 3.938in./100mm (1966-1998) 60

Part	Year	VIN	Model/Application	Part Number	Qty.
ENGINE GASKETS					
Head Set	1991-1998		Except Liquid Propane Gas, (Exhaust Pipe Gasket Not Included)	HS4879	1
	1966-1990		(Exhaust Pipe Gasket Not Included, Intake Manifold Gasket For Liquid Propane Gas Not Included)	HS3820VC	1
Lower Set	1997-1998		(Requires Head Set To Make Full Set)	CS4878A	1
	1996		10 Bolt Front Cover, (Requires Head Set To Make Full Set)	CS4878	1
			6 Bolt Front Cover, (Requires Head Set To Make Full Set)	CS4878A	1
	1991-1995		(Requires Head Set To Make Full Set)	CS4878	1
	1966-1990		(Requires Head Set To Make Full Set)	CS3805	1
Full Set	1966-1990		(Exhaust Pipe Gasket Not Included, Intake Manifold Gasket For Liquid Propane Gas Not Included)	FS3820VC	1
Cylinder Head Gasket	1991-1998		Liquid Propane Gas, (Single Sided Graphite) <i>Nitroseal</i>	4878	2
			Except Liquid Propane Gas, (Single Sided Graphite) <i>Nitroseal</i>	4879	2
	1966-1990		<i>VR2000</i>	3820VC	2
Cyl. Head Bolt Set	1966-1995			GS33287	2
Valve Cover Set	1991-1998		<i>Victo-Tech</i>	VS50182	1
			(Single Valve Cover) <i>Victo-Tech</i>	VS50183	2
	1986-1990		<i>Victo-Tech</i>	VS50169	1
	1985		Except H5D Emission <i>Cork Rubber</i>	VS38420	1
			Except H5D Emission <i>High Temperature Cork Rubber</i>	VS38420H	1
			Except H5D Emission <i>Victo-Tech</i>	VS38420R	1
			Except H5D Emission <i>Tuff-Cork</i>	VS38420TC	1
			H5D Emission, H5D Emission Identified By Stainless Steel Exhaust Manifolds <i>Victo-Tech</i>	VS50169	1
	1966-1984		<i>Cork Rubber</i>	VS38420	1
			<i>High Temperature Cork Rubber</i>	VS38420H	1
		<i>Victo-Tech</i>	VS38420R	1	
		<i>Tuff-Cork</i>	VS38420TC	1	
Valve Stem Seal, Exh.	1991-1998			B45804	8
	1966-1990		(Shedder Type) <i>Fluoroelastomer</i>	B45296	8
Valve Stem Seal, Int.	1991-1998			B45804	8
	1966-1990		(Shedder Type) <i>Fluoroelastomer</i>	B45296	8

General Motors Truck

60 366 CID (6.0L) Chevrolet V8 Cyl, 3.938in./100mm (1966-1998) **60**
 (cont.) (cont.)

Part	Year	VIN	Model/Application	Part Number	Qty.	
ENGINE GASKETS (cont.)						
Manifold Set, Exhaust	1991-1998		<i>Multi-Layered Steel</i>	MS16500	1	
	1966-1990			MS15164	1	
Manifold Set, Intake	1991-1998			MS15479A	1	
	1966-1990		Except Liquid Propane Gas And Restricted Crossover	MS15188	1	
				Liquid Propane Gas, Restricted Crossover	MS15190	1
Oil Pan Set	1991-1998		<i>Victo-Tech</i>	OS32121	1	
	1966-1990		<i>Cork Rubber</i>	OS30931X	1	
				<i>Tuff-Cork</i>	OS30931XTC	1
Rear Main Seal Set	1991-1998			JV1614	1	
	1966-1990			JV705	1	
Crank Repair Sleeve	1991-1998	Rear	<i>Nickel Plated Formed Steel, .013" Thickness</i>	A356	1	
Timing Cover Set	1997-1998			JV1183	1	
	1996		10 Bolt Front Cover, 1st Design	JV1162	1	
				2nd Design, 6 Bolt Front Cover	JV1183	1
	1991-1995			JV1162	1	
	1966-1990			(Repair Sleeve Not Included)	JV866	1
				(Contains Repair Sleeve)	JV929	1
Timing Cover Gasket	1997-1998			T31378	1	
	1996		10 Bolt Front Cover, 1st Design	T27119	1	
				2nd Design, 6 Bolt Front Cover	T31378	1
1966-1995			T27119	1		
Timing Cover Seal	1966-1998			46467	1	
Harmonic Balancer Repair Sleeve	1966-1998		<i>Ground Steel, .020" Thickness</i>	66598RS	1	
			Use With Part Number A503 <i>Nickel Plated Formed Steel, .013" Thickness</i>	A230	1	
MISCELLANEOUS GASKETS						
Air Cleaner Mount Gasket	1966-1996		4 Barrel Carburetor, Fuel Injection	G27098	1	
	1966		2 Barrel Carburetor	G26617	1	
Carb. Mount Gasket	1979-1990		4 Barrel Carburetor	G26905	1	
	1971-1978		Except Holley Carburetor, 4 Barrel Carburetor	G14733	1	
				Holley Carburetor, 4 Barrel Carburetor	G26905	1
	1966-1970		4 Barrel Carburetor	G14733	1	
	1966		2 Barrel Carburetor, Governor	G7327	1	
Dist. Mounting Gasket	1966-1998			B25934	1	
E.G.R. Gasket	1991-1998			G31178	1	
	1985-1990			G17797	1	
Exhaust Pipe Gasket	1991-1998		2.225" Pipe, (Ring Type 'E'), Pipe To Manifold	F20423	1	
	1985-1990		2.225" Pipe, (Steel Insert, Ring Type 'E')	F20423	1	
	1966-1990			(Flange Type), Pipe To Manifold	F7135	1
				2.5" Pipe, (Ring Type 'C'), Pipe To Manifold	F7139	2
				2.5" Pipe, (Ring Type 'B'), Pipe To Manifold <i>Sintered Metal</i>	F7139S	1
				2" Pipe, (Ring Type 'C'), Pipe To Manifold	F17250	1
				2" Pipe, (Ring Type 'B'), Pipe To Manifold <i>Sintered Metal</i>	F17250S	1
Fuel Pump Gasket	1966-1996			D27094	1	
				<i>Tuff-Cork</i>	D27094TC	1
Heat Riser Gasket	1966-1996			F7192	1	
Oil Cooler Gasket	1976-1996		2 Wheel Drive, (Contains Gasket Only), Adapter To Block	H31318	1	
Oil Cooler Mount Kit	1976-1996		(Contains O-Ring And Gasket Mounting Kit), Adapter To Block	GS33272	1	
Oil Pan Drain Plug Gst.	1966-1998			2051	1	
Oil Pump Cover Gasket	1988-1998			B45810	1	
Oil Pump Shaft Retainer	1966-1998			H31354	1	
Thermostat Seal	1991-1998		<i>Victo-Tech</i>	C31273	1	

LIGHT TRUCK

General Motors Truck

60 (cont.)	366 CID (6.0L) Chevrolet V8 Cyl, 3.938in./100mm (1966-1998)				60 (cont.)
----------------------	--	--	--	--	----------------------

<i>Part</i>	<i>Year</i>	<i>VIN</i>	<i>Model/Application</i>	<i>Part Number</i>	<i>Qty.</i>
MISCELLANEOUS GASKETS (cont.)					
Therm. By-Pass Adapter	1966-1998		Adapter To Pump	C31330	1
Throttle Body Gasket	1991-1998			G31386	1
Water Outlet Gasket	1966-1998			C26620	1
Water Pump Gasket	1966-1998		Pump To Plate	K27078	1
Water Pump Mount Gasket	1966-1998			K26632	2

61	379 CID (6.2L) General Motors V6 Cyl, 4.563in./115.9mm (1973-1974)				61
-----------	---	--	--	--	-----------

<i>Part</i>	<i>Year</i>	<i>VIN</i>	<i>Model/Application</i>	<i>Part Number</i>	<i>Qty.</i>
ENGINE GASKETS					
Head Set	1973-1974			HS3463	1
Full Set	1973-1974			FS3463J	1
Cylinder Head Gasket	1973-1974		VR2000	3379	2
Valve Cover Set	1973-1974		Cork Rubber	VS38290	1
Valve Stem Seal, Int.	1973-1974		(O-Ring Type)	B45229	6
Manifold Set, Exhaust	1973-1974			MS10009	1
Manifold Set, Intake	1973-1974			MS15955	1
Oil Pan Set	1973-1974		Cork Rubber	OS31577	1
Rear Main Seal Set	1973-1974			JV616	1
Timing Cover Set	1973-1974			JV815	1

MISCELLANEOUS GASKETS					
Carb. Mount Gasket	1973-1974		2 Barrel Carburetor	G7363	1
Exhaust Pipe Gasket	1973-1974		(Flange Type), Pipe To Manifold	F7135	1
Fuel Pump Gasket	1973-1974		Plate To Block	D25932	1
			Plate To Block	Tuff-Cork D25932TC	1
			Pump To Plate	D27094	1
			Pump To Plate	Tuff-Cork D27094TC	1
Push Rod Cover Set	1973-1974			PS38029	1
Water Outlet Gasket	1973-1974			C26501	1
Water Pump Mount Gasket	1973-1974			K27540	1

62	379 CID (6.2L) Chevrolet Diesel V8 Cyl, 3.976in./101mm (1982-1993)				62
-----------	---	--	--	--	-----------

<i>Part</i>	<i>Year</i>	<i>VIN</i>	<i>Model/Application</i>	<i>Part Number</i>	<i>Qty.</i>
ENGINE GASKETS					
Head Set	1982-1993		(Head Bolts Not Included, Exhaust Pipe Gasket Not Included, Heavy Duty Intake Manifold Gasket Not Included, Positive Type Exhaust Valve Stem Seals Not Included)	HS3678	1
Lower Set	1992-1993		(Requires Head Set To Make Full Set)	CS3678A	1
Full Set	1982-1991		(Head Bolts Not Included, Exhaust Pipe Gasket Not Included, Heavy Duty Intake Manifold Gasket Not Included, Positive Type Exhaust Valve Stem Seals Not Included)	FS3678	1
Engine Kit Gasket Set	1992-1993	C	(Intake Manifold Gasket Not Included, Positive Type Exhaust Valve Stem Seals Not Included), Use With Part Numbers B45812, MS15306	95-3503VR	1
		J	(Intake Manifold Gasket Not Included, Positive Type Exhaust Valve Stem Seals Not Included), Use With Part Numbers B45812, MS15335	95-3503VR	1
		C	(Contains .010" Thicker Head Gasket, Intake Manifold Gasket Not Included, Positive Type Exhaust Valve Stem Seals Not Included), Use With Part Numbers B45812, MS15306	95-3504VR	1
		J	(Contains .010" Thicker Head Gasket, Intake Manifold Gasket Not Included, Positive Type Exhaust Valve Stem Seals Not Included), Use With Part Numbers B45812, MS15335	95-3504VR	1

LIGHT TRUCK

General Motors Truck

62 379 CID (6.2L) Chevrolet Diesel V8 Cyl, 3.976in./101mm (1982-1993) **62**
 (cont.) (cont.)

Part Year VIN Model/Application Part Number Qty.

ENGINE GASKETS (cont.)

Engine Kit Gasket Set (cont.)	1982-1991	C	(Intake Manifold Gasket Not Included, Positive Type Exhaust Valve Stem Seals Not Included), Use With Part Numbers B45812, MS15306	95-3131VR	1
		J	(Intake Manifold Gasket Not Included, Positive Type Exhaust Valve Stem Seals Not Included), Use With Part Numbers B45812, MS15335	95-3131VR	1
		C	(Contains .010" Thicker Head Gasket, Intake Manifold Gasket Not Included, Positive Type Exhaust Valve Stem Seals Not Included), Use With Part Numbers B45812, MS15306	95-3502VR	1
		J	(Contains .010" Thicker Head Gasket, Intake Manifold Gasket Not Included, Positive Type Exhaust Valve Stem Seals Not Included), Use With Part Numbers B45812, MS15335	95-3502VR	1
Cylinder Head Gasket	1982-1993		<i>Solicor</i>	3678	2
			.010" Thicker Cylinder Head Gasket	<i>Solicor</i>	3678T
Cyl. Head Bolt Set	1982-1993			GS33193	2
Valve Cover Set	1982-1993		<i>Cork Rubber</i>	VS38327	1
Valve Stem Seal, Exh.	1988-1993		(Positive Type)	B45812	8
	1982-1993		(O-Ring Type)	B45229	8
Valve Stem Seal, Int.	1982-1993		(O-Ring Type)	B45229	8
Manifold Set, Exhaust	1982-1993			MS15336	1
Manifold Set, Intake	1982-1993	C	Light Duty	MS15306	1
		J	Heavy Duty, (Not Contained In Head Or Full Set)	MS15335	1
Oil Pan Set	1992-1993		<i>Cork Rubber</i>	OS32134	1
	1982-1991		<i>Cork Rubber</i>	OS30591	1
Rear Main Seal Set	1992-1993		(1 Piece)	JV1617	1
	1982-1991		(2 Piece)	JV560	1
	1982-1987		<i>Rope Packing</i>	JV749	1
Timing Cover Set	1982-1993		(Repair Sleeve Not Included)	JV971	1
			(Contains Repair Sleeve)	JV1134	1
Timing Cover Gasket	1982-1993			T31352	1
Timing Cover Seal	1982-1993			46467	1
Harmonic Balancer Repair Sleeve	1982-1993		Use With Part Number A503 <i>Nickel Plated Formed Steel, .013' Thickness</i>	A232	1

MISCELLANEOUS GASKETS

Air Cleaner Mount Gasket	1982-1993			G27655	1	
Exhaust Pipe Gasket	1982-1993		(Ring Type 'E'), Pipe To Manifold	F7507	1	
Fuel Pump Gasket	1982-1993		Plate To Block	D25932	1	
			Plate To Block	<i>Tuff-Cork</i>	D25932TC	1
			Pump To Plate		D27094	1
			Pump To Plate	<i>Tuff-Cork</i>	D27094TC	1
Inj. Pump Mtg. Gasket	1982-1993			B26454	1	
Oil Pan Drain Plug Gst.	1982-1993			2051	1	
Therm. Housing Gasket	1982-1993		Crossover	C30677	2	
Water Manifold Gasket	1982-1987			C30677	2	
Water Outlet Gasket	1982-1993		2 Bolt Hole Housing	C24125	1	
			3 Bolt Hole Housing	C30811	1	
Water Pump Backing Plate	1992-1993		C2500 Suburban, C2500 Suburban(GMC), Reverse Rotation	K31288	1	
	1988-1993		C1500, C1500(GMC), C2500, C2500(GMC), C3500, C3500(GMC), K1500, K1500(GMC), K2500, K2500(GMC), K3500, K3500(GMC), Reverse Rotation	K31288	1	
	1983-1993		G2500(GMC), G3500(GMC), P3500(GMC)	K27395	1	
	1982-1993		G20, G30, P30	K27395	1	
	1983-1989		P2500(GMC)	K27395	1	
	1982-1989		P20	K27395	1	

LIGHT TRUCK

62 379 CID (6.2L) Chevrolet Diesel V8 Cyl, 3.976in./101mm (1982-1993) **62**
(cont.) (cont.)

Part	Year	VIN	Model/Application	Part Number	Qty.
MISCELLANEOUS GASKETS (cont.)					
Water Pump Backing Plate (cont.)	1987		R10, R10 Suburban, R1500 Suburban(GMC), R1500(GMC), R20, R20 Suburban, R2500 Suburban (GMC), R2500(GMC), R30, R3500(GMC), V10, V10 Suburban, V1500 Suburban(GMC), V1500(GMC), V20, V20 Suburban, V2500 Suburban(GMC), V2500(GMC), V30, V3500(GMC)	K27395	1
	1982-1987		Blazer, Jimmy	K27395	1
	1983-1986		K1500 Suburban (GMC), K2500 Suburban(GMC), K2500(GMC), K3500(GMC)	K27395	1
	1982-1986		C10, C10 Suburban, C1500 Suburban(GMC), C1500(GMC), C20, C20 Suburban, C2500 Suburban(GMC), C2500(GMC), C30, C3500(GMC), K10, K10 Suburban, K1500(GMC), K20, K20 Suburban, K30	K27395	1
Water Pump Mount Gasket	1982-1993		Plate To Timing Cover	K31317	1

63 395 CID/6468CC (6.5L) Chevrolet Diesel V8 Cyl, 4.055in./103mm (1992-2002) **63**

Part	Year	VIN	Model/Application	Part Number	Qty.
ENGINE GASKETS					
Head Set	1994-1998	S	Except High Output Engine, (Head Bolts Not Included, Exhaust Pipe Gasket Not Included, Positive Type Valve Stem Seals Not Included)	HS4021	1
		Y	High Output Engine, (Head Bolts Not Included, Exhaust Pipe Gasket Not Included, Positive Type Valve Stem Seals Not Included)	HS4021A	1
	1992-1998	F	High Output Engine, (Head Bolts Not Included, Exhaust Pipe Gasket Not Included, Positive Type Valve Stem Seals Not Included)	HS4021A	1
	1994-1995	P	Except High Output Engine, (Head Bolts Not Included, Exhaust Pipe Gasket Not Included, Positive Type Valve Stem Seals Not Included)	HS4021	1
Lower Set	1992-2002		(Requires Head Set To Make Full Set)	CS3678A	1
Engine Kit Gasket Set	1992-1998		(Head Gasket Not Included, Positive Type Valve Stem Seals Not Included, Requires Standard Thickness Head Gaskets; Or For Resurfaced Blocks .010" Thicker Head Gaskets), Use With Part Numbers 4021, 4021T, B45812	95-3461VR	1
Cylinder Head Gasket	1992-2002			4021	2
			.010" Thicker Cylinder Head Gasket	4021T	2
Cyl. Head Bolt Set	1992-2002			GS33193	2
Valve Cover Set	1992-2002		<i>Cork Rubber</i>	VS38327	1
Valve Stem Seal, Exh.	1992-2002		(O-Ring Type)	B45229	8
			(Positive Type)	B45812	8
Valve Stem Seal, Int.	1992-2002		(O-Ring Type)	B45229	8
Manifold Set, Exhaust	1992-2002			MS15336	1
Manifold Set, Intake	1996-2002	F	Except Fullsize Van, High Output Engine, (Contains Plenum Chamber Gasket)	MS15335A	1
	1996-1999	Y	Except Fullsize Van, High Output Engine, (Contains Plenum Chamber Gasket)	MS15335A	1
	1994-1999	S	Except High Output Engine, (Contains Plenum Chamber Gasket)	MS15306A	1
	1994-1995	P	Except High Output Engine, (Contains Plenum Chamber Gasket)	MS15306A	1
		Y	High Output Engine, (Contains Plenum Chamber Gasket)	MS15335A	1
	1992-1995	F	High Output Engine, (Contains Plenum Chamber Gasket)	MS15335A	1
Plenum Chamber Gasket	1996-2002	F	Except Fullsize Van	MS16316	1
	1996-1999	S, Y		MS16316	1
	1992-1995			MS16316	1
Oil Pan Set	1992-2002		<i>Cork Rubber</i>	OS32134	1
Rear Main Seal Set	1992-2002			JV1617	1
Timing Cover Set	1992-2002		(Repair Sleeve Not Included)	JV971	1
			(Contains Repair Sleeve)	JV1134	1

LIGHT TRUCK

General Motors Truck

63 395 CID/6468CC (6.5L) Chevrolet Diesel V8 Cyl, 4.055in./103mm (1992-2002) **63**
 (cont.) (cont.)

Part Year VIN Model/Application Part Number Qty.

ENGINE GASKETS (cont.)

Timing Cover Gasket	1992-2002			T31352	1
Timing Cover Seal	1992-2002			46467	1
Harmonic Balancer Repair Sleeve	1992-2002		Use With Part Number A503 <i>Nickel Plated Formed Steel, .013" Thickness</i>	A232	1

MISCELLANEOUS GASKETS

Air Cleaner Mount Gasket	1992-1999		Indirect Injection	G27655	1
E.G.R. Gasket	1997-1998	F	Except G Series	G31327	1
	1996	F	Except Fullsize Van	G31327	1
	1994-1996			G31327	1
Exhaust Pipe Gasket	1996-2002		Express 2500, Express 2500 EXT, Express 3500, Express 3500 EXT, Savana 2500, Savana 3500, Savana 3500 EXT, 3 Bolt Mounting, Pipe To Converter	F7538	1
			4 Bolt Flange, (Flange Type), Front, Pipe To Converter	F7566	1
	1996-2001		Savana 2500 EXT, 3 Bolt Mounting, Pipe To Converter	F7538	1
	1996-1999		G2500, G2500(GMC), G3500, G3500(GMC), 3 Bolt Mounting, Pipe To Converter	F7538	1
	1992-1999		(Ring Type 'E'), Pipe To Manifold	F7507	1
Fuel Pump Gasket	1992-1999		Plate To Block	D25932	1
			Plate To Block <i>Tuff-Cork</i>	D25932TC	1
			Pump To Plate	D27094	1
			Pump To Plate <i>Tuff-Cork</i>	D27094TC	1
Inj. Pump Mtg. Gasket	1992-2002			B26454	1
Oil Pan Drain Plug Gst.	1996-2002			B45828	1
	1992-1995			2051	1
Therm. Housing Gasket	1992-2002		Crossover	C30677	2
Thermostat Seal	1992-1999		<i>Victo-Tech</i>	C31273	1
Water Outlet Gasket	1996-1999		4 Bolt Housing	C31427	1
			2 Bolt Hole Housing	C24125	1
			3 Bolt Hole Housing	C30811	1
Water Pump Mount Gasket	1992-2002			K31288	1
			Plate To Timing Cover	K31317	1

64 396 CID (6.6L) Chevrolet V8 Cyl, 4.094in./104mm (1966-1970) **64**

Part Year VIN Model/Application Part Number Qty.

ENGINE GASKETS

Head Set	1968-1970		(Head Bolts Not Included; Exhaust Pipe Gaskets And Intake Manifold Gaskets For LPG Engines Not Included)	HS3805VJ	1
Lower Set	1968-1970		(Requires Head Set To Make Full Set)	CS3805	1
Full Set	1968-1970		(Head Bolts Not Included; Exhaust Pipe Gaskets And Intake Manifold Gaskets For LPG Engines Not Included)	FS3805VJ	1
Engine Kit Gasket Set	1966-1970			95-3026VR	1
Cylinder Head Gasket	1968-1970		<i>VR2000</i>	3805VC	2
			(Stainless Steel Flanges) <i>VR2000</i>	3868VC	2
			(Stainless Steel Flanges) <i>Nitroseal</i>	3884SG	2
Cyl. Head Bolt Set	1968-1970			GS33287	2
Valve Cover Set	1968-1970		<i>Cork Rubber</i>	VS38420	1
			<i>High Temperature Cork Rubber</i>	VS38420H	1
			<i>Victo-Tech</i>	VS38420R	1
			<i>Tuff-Cork</i>	VS38420TC	1
Valve Stem Seal, Exh.	1968-1970		(Shedder Type) <i>Fluoroelastomer</i>	B45296	8
Valve Stem Seal, Int.	1968-1970		(Shedder Type) <i>Fluoroelastomer</i>	B45296	8
Manifold Set, Exhaust	1968-1970			MS15164	1

LIGHT TRUCK

64 396 CID (6.6L) Chevrolet V8 Cyl, 4.094in./104mm (1966-1970) **64**
(cont.) (cont.)

Part Year VIN Model/Application Part Number Qty.

ENGINE GASKETS (cont.)

Manifold Set, Intake	1968-1970			MS15188	1
			Liquid Propane Gas	MS15190	1
Oil Pan Set	1968-1970		<i>Cork Rubber</i>	OS30931X	1
Rear Main Seal Set	1968-1970			JV705	1
Timing Cover Set	1968-1970		(Repair Sleeve Not Included)	JV866	1
			(Contains Repair Sleeve)	JV929	1
Timing Cover Gasket	1968-1970			T27119	1
Timing Cover Seal	1968-1970			46467	1
Harmonic Balancer Repair Sleeve	1968-1970		<i>Ground Steel, .020" Thickness</i>	66598RS	1
			Use With Part Number A503 <i>Nickel Plated Formed Steel, .013" Thickness</i>	A230	1

MISCELLANEOUS GASKETS

Air Cleaner Mount Gasket	1968-1970		4 Barrel Carburetor	G27098	1
Carb. Mount Gasket	1970		4 Barrel Carburetor	G18565	1
			Rochester, 4 Barrel Carburetor	G18565	1
	1968-1969		2 Barrel Carburetor	G7327	1
			4 Barrel Carburetor	G14579	1
Dist. Mounting Gasket	1968-1970			B25934	1
Exhaust Pipe Gasket	1968-1970		(Ring Type 'C'), Pipe To Manifold	F7139	2
			(Ring Type 'B'), Pipe To Manifold <i>Sintered Metal</i>	F7139S	1
			(Flange Type), Pipe To Manifold	F7192	1
Fuel Pump Gasket	1968-1970		Pump To Plate	D27094	1
			Pump To Plate <i>Tuff-Cork</i>	D27094TC	1
Heat Riser Gasket	1968-1970			F7192	1
Oil Pan Drain Plug Gst.	1968-1970			2051	1
Water Outlet Gasket	1968-1970		(Universal Type)	C24109	1
				C25930	1
Water Pump Backing Plate	1968-1970		Pump To Plate	K27078	1
Water Pump Mount Gasket	1968-1970			K26632	2

65 400 CID (6.6L) Chevrolet V8 Cyl, 4.125in./104.8mm (1974-1980) **65**

Part Year VIN Model/Application Part Number Qty.

ENGINE GASKETS

Head Set	1975-1980		(Head Bolts Not Included)	HS3432VJ	1
Lower Set	1975-1980		(Requires Head Set To Make Full Set)	CS1178	1
Full Set	1975-1980		(Head Bolts Not Included)	FS3432VJ	1
Engine Kit Gasket Set	1974-1980			95-3031VR	1
Cylinder Head Gasket	1975-1980		<i>Nitroseal</i>	3432SG	2
	1974-1980		(Cylindrical Combustion Chamber Openings, Gasket Has Steam Holes Required For Street Operation) <i>Stainless Steel, 8.8cc Combustion Chamber Volume, 4.190" Combustion Chamber Opening, .040" Compressed Operating Thickness</i>	3512	2
Cyl. Head Bolt Set	1975-1980			GS33285	2
Valve Cover Set	1975-1980		<i>Cork Rubber</i>	VS38110	1
			<i>High Temperature Cork Rubber</i>	VS38110HA	1
			<i>High Temperature Tuff-Cork</i>	VS38110HTC	1
			<i>Victo-Tech</i>	VS38110R	1
			<i>Tuff-Cork</i>	VS38110TC	1
Valve Stem Seal, Exh.	1975-1980		(O-Ring Type)	B45229	8
			(Shedder Type)	B45264	8
			(Shedder Type, High Temperature)	B45779	8

LIGHT TRUCK

General Motors Truck

65 (cont.)	400 CID (6.6L) Chevrolet V8 Cyl, 4.125in./104.8mm (1974-1980)				65 (cont.)
----------------------	--	--	--	--	----------------------

<i>Part</i>	<i>Year</i>	<i>VIN</i>	<i>Model/Application</i>	<i>Part Number</i>	<i>Qty.</i>	
ENGINE GASKETS (cont.)						
Valve Stem Seal, Int.	1975-1980		(O-Ring Type)	B45229	8	
			(Shedder Type)	B45264	8	
			(Positive Type) <i>Fluoroelastomer</i>	B45418	8	
			(Shedder Type, High Temperature)	B45779	8	
Manifold Set, Exhaust	1975-1980			MS7110X	1	
Manifold Set, Intake	1975-1980			MS15315	1	
Oil Pan Set	1975-1980		Left Hand Dip Stick <i>Victo-Tech</i>	OS30568RLH	1	
				<i>Cork Rubber</i>	OS30568Z	1
				<i>Tuff-Cork</i>	OS30568ZTC	1
Rear Main Seal Set	1975-1980		Align Bored Engine, (Oversize) <i>2.8406" To 2.8415" Outside Diameter</i>	JV1603	1	
			(Lip Relocator Type)	JV1627	1	
Timing Cover Set	1975-1980		(Repair Sleeve Not Included)	JV881	1	
			(Repair Sleeve Not Included) <i>Tuff-Cork</i>	JV881TC	1	
			(Contains Repair Sleeve)	JV926	1	
Timing Cover Gasket	1975-1980			T27781	1	
Timing Cover Seal	1975-1980		<i>3/8" Wide</i>	49328	1	
			(Lip Relocator Type) <i>1/2" Wide</i>	65022	1	
Harmonic Balancer Repair Sleeve	1975-1980		<i>Ground Steel, .020" Thickness</i>	66597RS	1	
			Use With Part Number A504 <i>Nickel Plated Formed Steel, .013" Oversize</i>	A228	1	

MISCELLANEOUS GASKETS

Air Cleaner Mount Gasket	1975-1980		4 Barrel Carburetor	G27098	1
Carb. Mount Gasket	1975-1980		4 Barrel Carburetor	G26719	1
Choke Tube Gasket	1978-1980			B45787	1
Dist. Mounting Gasket	1975-1980			B25934	1
E.G.R. Gasket	1978-1980			G26748	1
Exhaust Pipe Gasket	1975-1980		(Ring Type 'C'), Pipe To Manifold	F17250	1
			(Ring Type 'B'), Pipe To Manifold <i>Sintered Metal</i>	F17250S	1
Fuel Pump Gasket	1975-1980		Plate To Block	D25932	1
			Plate To Block <i>Tuff-Cork</i>	D25932TC	1
			Pump To Plate	D27094	1
			Pump To Plate <i>Tuff-Cork</i>	D27094TC	1
Heat Riser Gasket	1975-1980		<i>2.437" Inside Diameter</i>	F7192	1
Oil Pan Drain Plug Gst.	1975-1980			2051	1
Oil Pump Shaft Retainer	1975-1980			H31354	1
Water Outlet Gasket	1975-1980		(Universal Type)	C24109	1
				C25930	1
Water Pump Backing Plate	1975-1980			K27091	1
Water Pump Mount Gasket	1975-1980			K25935	2

66	401 CID (6.6L) General Motors V6 Cyl, 4.875in./123.8mm (1960-1972)				66
<i>Part</i>	<i>Year</i>	<i>VIN</i>	<i>Model/Application</i>	<i>Part Number</i>	<i>Qty.</i>

ENGINE GASKETS

Head Set	1966-1972			HS3379J	1
	1960-1965			HS3463	1
Full Set	1966-1972			FS3379J	1
	1960-1965			FS3463J	1
Cylinder Head Gasket	1960-1972		<i>VR2000</i>	3379	2
Valve Cover Set	1960-1972		<i>Cork Rubber</i>	VS38290	1
Valve Stem Seal, Int.	1960-1972		(O-Ring Type)	B45229	6

66 401 CID (6.6L) General Motors V6 Cyl, 4.875in./123.8mm (1960-1972) **66**
(cont.) (cont.)

Part Year VIN Model/Application Part Number Qty.

ENGINE GASKETS (cont.)

Manifold Set, Exhaust	1966-1972			MS10019BS	1
	1960-1965			MS10009	1
Manifold Set, Intake	1966-1972			MS15512	1
	1960-1965			MS15955	1
Oil Pan Set	1960-1972		<i>Cork Rubber</i>	OS31577	1
Rear Main Seal Set	1960-1972			JV716	1
Timing Cover Set	1960-1972			JV815	1
Harmonic Balancer Repair Sleeve	1960-1972		Use With Part Number A503 <i>Nickel Plated Formed Steel, .013" Oversize</i>	A227	1

MISCELLANEOUS GASKETS

Carb. Mount Gasket	1966-1972		2 Barrel Carburetor	G26685	1
Exhaust Pipe Gasket	1960-1972		(Flange Type), Pipe To Manifold	F7135	1
Fuel Pump Gasket	1960-1972			D27094	1
				<i>Tuff-Cork</i>	D27094TC
Push Rod Cover Set	1960-1972			PS38029	1
Water Outlet Gasket	1960-1972			C26501	1
Water Pump Mount Gasket	1966-1972			K27540	1
	1960-1965			K27566	1

67 402 CID (6.6L) Chevrolet V8 Cyl, 4.125in./104.8mm (1970-1972) **67**

Part Year VIN Model/Application Part Number Qty.

ENGINE GASKETS

Head Set	1970-1972			HS3805VJ	1	
Lower Set	1970-1972		(Requires Head Set To Make Full Set)	CS3805	1	
Full Set	1970-1972			FS3805VJ	1	
Engine Kit Gasket Set	1970-1972			95-3026VR	1	
Cylinder Head Gasket	1970-1972		<i>VR2000</i>	3805VC	2	
			(Stainless Steel Flanges)	<i>VR2000</i>	3868VC	2
			(Stainless Steel Flanges)	<i>Nitroseal</i>	3884SG	2
Cyl. Head Bolt Set	1970-1972			GS33287	2	
Valve Cover Set	1970-1972		<i>Cork Rubber</i>	VS38420	1	
			<i>High Temperature Cork Rubber</i>	VS38420H	1	
			<i>Victo-Tech</i>	VS38420R	1	
			<i>Tuff-Cork</i>	VS38420TC	1	
Valve Stem Seal, Exh.	1970-1972		(Shedder Type) <i>Fluoroelastomer</i>	B45296	8	
Valve Stem Seal, Int.	1970-1972		(Shedder Type) <i>Fluoroelastomer</i>	B45296	8	
Manifold Set, Exhaust	1970-1972			MS15164	1	
Manifold Set, Intake	1970-1972			MS15188	1	
Oil Pan Set	1970-1972		<i>Cork Rubber</i>	OS30931X	1	
			<i>Tuff-Cork</i>	OS30931XTC	1	
Rear Main Seal Set	1970-1972			JV705	1	
Timing Cover Set	1970-1972		(Repair Sleeve Not Included)	JV866	1	
			(Contains Repair Sleeve)	JV929	1	
Timing Cover Gasket	1970-1972			T27119	1	
Timing Cover Seal	1970-1972			46467	1	
Harmonic Balancer Repair Sleeve	1970-1972		<i>Ground Steel, .020" Oversize</i>	66598RS	1	
			Use With Part Number A503 <i>Nickel Plated Formed Steel, .013" Oversize</i>	A230	1	

MISCELLANEOUS GASKETS

Air Cleaner Mount Gasket	1970-1972		4 Barrel Carburetor	G27098	1
			4 Barrel Carburetor	G27098	1
Carb. Mount Gasket	1971-1972		4 Barrel Carburetor, Except Performance Engine	G26666	1
			Except Performance Engine, 4 Barrel Carburetor	G26666	1

LIGHT TRUCK

General Motors Truck

67 (cont.)	402 CID (6.6L) Chevrolet V8 Cyl, 4.125in./104.8mm (1970-1972)				67 (cont.)
----------------------	--	--	--	--	----------------------

<i>Part</i>	<i>Year</i>	<i>VIN</i>	<i>Model/Application</i>	<i>Part Number</i>	<i>Qty.</i>
MISCELLANEOUS GASKETS (cont.)					
Carb. Mount Gasket (cont.)	1970		4 Barrel Carburetor	G18565	1
Dist. Mounting Gasket	1970-1972			B25934	1
Exhaust Pipe Gasket	1971-1972		(Flange Type), Pipe To Manifold	F7135	2
			2" Pipe, (Ring Type 'C'), Pipe To Manifold	F17250	2
			2" Pipe, (Ring Type 'B'), Pipe To Manifold <i>Sintered Metal</i>	F17250S	2
	1970-1972		2.5" Pipe, (Ring Type 'C'), Pipe To Manifold	F7139	2
			2.5" Pipe, (Ring Type 'B'), Pipe To Manifold <i>Sintered Metal</i>	F7139S	2
Fuel Pump Gasket	1970-1972			D27094	1
				<i>Tuff-Cork</i> D27094TC	1
Oil Pan Drain Plug Gst.	1970-1972			2051	1
Oil Pump Shaft Retainer	1971-1972			H31354	1
Water Outlet Gasket	1970-1972		(Universal Type)	C24109	1
				C25930	1
Water Pump Backing Plate	1970-1972			K27078	1
Water Pump Mount Gasket	1970-1972			K26632	2

68	427 CID (7.0L) Chevrolet V8 Cyl, 4.250in./108mm (1966-1998)				68
-----------	--	--	--	--	-----------

<i>Part</i>	<i>Year</i>	<i>VIN</i>	<i>Model/Application</i>	<i>Part Number</i>	<i>Qty.</i>
ENGINE GASKETS					
Head Set	1991-1996		(Exhaust Pipe Gasket Not Included)	HS4878A	1
	1974-1990		(Exhaust Pipe Gasket Not Included, Intake Manifold Gasket For Liquid Propane Gas Not Included)	HS3902VC	1
	1968-1973		(Exhaust Pipe Gasket Not Included, Intake Manifold Gasket For Liquid Propane Gas Not Included)	HS3805VJ	1
Lower Set	1997-1998		(Requires Head Set To Make Full Set)	CS4878A	1
	1996		10 Bolt Front Cover, 1st Design, (Requires Head Set To Make Full Set)	CS4878	1
			2nd Design, 6 Bolt Front Cover, (Requires Head Set To Make Full Set)	CS4878A	1
	1991-1995		(Requires Head Set To Make Full Set)	CS4878	1
	1968-1990		(Requires Head Set To Make Full Set)	CS3805	1
Full Set	1974-1990		(Exhaust Pipe Gasket Not Included, Intake Manifold Gasket For Liquid Propane Gas Not Included)	FS3902VC	1
	1968-1973		(Exhaust Pipe Gasket Not Included, Intake Manifold Gasket For Liquid Propane Gas Not Included)	FS3805VJ	1
Engine Kit Gasket Set	1991-1995			95-3467VR	1
	1990		4 Barrel Carburetor, Throttle Body Injection	95-3425VR	1
	1985-1989		4 Barrel Carburetor, H5D Emission, Throttle Body Injection	95-3425VR	1
	1985		4 Barrel Carburetor, Except H5D Emission	95-3049VR	1
	1974-1984		4 Barrel Carburetor	95-3049VR	1
	1968-1973		4 Barrel Carburetor	95-3026VR	1
Cylinder Head Gasket	1991-1996		(Single Sided Graphite) <i>Nitroseal</i>	4878	2
	1974-1990		<i>VR2000</i>	3902VC	2
	1968-1973		<i>VR2000</i>	3805VC	2
			(Stainless Steel Flanges) <i>VR2000</i>	3868VC	2
			(Stainless Steel Flanges) <i>Nitroseal</i>	3884SG	2
Cyl. Head Bolt Set	1968-1996			GS33287	2
Valve Cover Set	1991-1998		<i>Victo-Tech</i>	VS50182	1
			(Single Valve Cover) <i>Victo-Tech</i>	VS50183	2
	1986-1990		<i>Victo-Tech</i>	VS50169	1
	1985		Except H5D Emission <i>Cork Rubber</i>	VS38420	1
			Except H5D Emission <i>Victo-Tech</i>	VS38420R	1

LIGHT TRUCK

68
(cont.)

427 CID (7.0L) Chevrolet V8 Cyl, 4.250in./108mm (1966-1998)

68
(cont.)

Part Year VIN Model/Application Part Number Qty.

ENGINE GASKETS (cont.)

Valve Cover Set (cont.)	1985		H5D Emission, H5D Emission Identified By Stainless Steel Exhaust Manifolds <i>Victo-Tech</i>	VS50169	1	
	1979-1985		Except H5D Emission <i>High Temperature Cork Rubber</i>	VS38420H	1	
			Except H5D Emission <i>Tuff-Cork</i>	VS38420TC	1	
	1966-1984			<i>Cork Rubber</i>	VS38420	1
				<i>High Temperature Cork Rubber</i>	VS38420H	1
				<i>Victo-Tech</i>	VS38420R	1
				<i>Tuff-Cork</i>	VS38420TC	1
Valve Stem Seal, Exh.	1991-1998			B45804	8	
	1968-1990	(Shedder Type)	<i>Fluoroelastomer</i>	B45296	8	
Valve Stem Seal, Int.	1991-1998			B45804	8	
	1968-1990	(Shedder Type)	<i>Fluoroelastomer</i>	B45296	8	
Manifold Set, Exhaust	1991-1998		<i>Multi-Layered Steel</i>	MS16500	1	
			<i>Nitroseal</i>	MS16500G	1	
	1968-1990			MS15164	1	
Manifold Set, Intake	1991-1998			MS15479A	1	
	1968-1990		High Performance Engine	MS15168	1	
			Except High Performance, Except Liquid Propane Gas, Except Restricted Crossover		MS15188	1
			Liquid Propane Gas, Restricted Crossover		MS15190	1
Oil Pan Set	1991-1998		<i>Victo-Tech</i>	OS32121	1	
	1968-1990		<i>Cork Rubber</i>	OS30931X	1	
				<i>Tuff-Cork</i>	OS30931XTC	1
Rear Main Seal Set	1991-1998			JV1614	1	
	1968-1990			JV705	1	
Crank Repair Sleeve	1991-1998	Rear	<i>Nickel Plated Formed Steel, .013" Oversize</i>	A356	1	
Timing Cover Set	1997-1998			JV1183	1	
	1996-1998		2nd Design, 6 Bolt Front Cover	JV1183	1	
	1996		10 Bolt Front Cover, 1st Design	JV1162	1	
	1991-1995			JV1162	1	
	1968-1990		(Repair Sleeve Not Included)		JV866	1
			(Contains Repair Sleeve)		JV929	1
Timing Cover Gasket	1997-1998			T31378	1	
	1996-1998		2nd Design, 6 Bolt Front Cover	T31378	1	
	1990-1996		10 Bolt Front Cover, 1st Design	T27119	1	
	1968-1990			T27119	1	
Timing Cover Seal	1968-1998			46467	1	
Harmonic Balancer Repair Sleeve	1968-1998		<i>Ground Steel, .020" Oversize</i>	66598RS	1	
			Use With Part Number A503 <i>Nickel Plated Formed Steel, .013" Oversize</i>	A230	1	

MISCELLANEOUS GASKETS

Air Cleaner Mount Gasket	1991-1996			G27098	1
	1993		Throttle Body Injection	G27098	1
	1991-1993			G27098	1
	1990-1993		Throttle Body Injection	G27098	1
	1990			G27098	1
	1979-1989		4 Barrel Carburetor	G27098	1
	1979-1984			G27098	1
	1975-1982		4 Barrel Carburetor	G27098	1
	1973-1978			G27098	1
			4 Barrel Carburetor	G27098	1
Carb. Mount Gasket	1979-1990		4 Barrel Carburetor	G26905	1
	1968-1978		4 Barrel Carburetor	G14733	1
Dist. Mounting Gasket	1968-1998			B25934	1

LIGHT TRUCK

General Motors Truck

68 427 CID (7.0L) Chevrolet V8 Cyl, 4.250in./108mm (1966-1998) **68**
 (cont.) (cont.)

Part	Year	VIN	Model/Application	Part Number	Qty.	
MISCELLANEOUS GASKETS (cont.)						
E.G.R. Gasket	1991-1998			G31178	1	
	1985-1990			G17797	1	
Exhaust Pipe Gasket	1991-1998		(Ring Type 'E'), Pipe To Manifold	F20423	1	
	1985-1990		2.5" Pipe, Steel Insert, (Ring Type 'E'), Pipe To Manifold	F20423	1	
	1968-1990			(Flange Type), Pipe To Manifold	F7135	1
				2.5" Pipe, (Ring Type 'C'), Pipe To Manifold	F7139	2
				2.5" Pipe, (Ring Type 'B'), Pipe To Manifold <i>Sintered Metal</i>	F7139S	1
				2" Pipe, (Ring Type 'C'), Pipe To Manifold	F17250	1
				2" Pipe, (Ring Type 'B'), Pipe To Manifold <i>Sintered Metal</i>	F17250S	1
Fuel Pump Gasket	1968-1996			D27094	1	
				<i>Tuff-Cork</i> D27094TC	1	
Heat Riser Gasket	1968-1996			F7192	1	
Oil Cooler Gasket	1976-1996		2 Wheel Drive, (Contains Gasket Only), Adapter To Block	H31318	1	
Oil Cooler Mount Kit	1976-1996		(Contains O-Ring And Gasket Mounting Kit), Adapter To Block	GS33272	1	
Oil Pan Drain Plug Gst.	1968-1998			2051	1	
Oil Pump Cover Gasket	1988-1998			B45810	1	
Oil Pump Shaft Retainer	1968-1997			H31354	1	
Thermostat Seal	1991-1998			<i>Victo-Tech</i> C31273	1	
Therm. By-Pass Adapter	1991-1998		Adapter To Pump	C31330	1	
Throttle Body Gasket	1991-1998			G31386	1	
Water Outlet Gasket	1991-1998			C25930	1	
	1968-1990			C26620	1	
Water Pump Backing Plate	1968-1998		Pump To Plate	K27078	1	
Water Pump Mount Gasket	1968-1998			K26632	2	

69 432 CID (7.1L) General Motors V6 Cyl, 4.875in./123.8mm (1973-1974) **69**

Part	Year	VIN	Model/Application	Part Number	Qty.
ENGINE GASKETS					
Head Set	1973-1974			HS3379J	1
Full Set	1973-1974			FS3379J	1
Cylinder Head Gasket	1973-1974			<i>VR2000</i> 3379	2
Valve Cover Set	1973-1974			<i>Cork Rubber</i> VS38290	1
Valve Stem Seal, Int.	1973-1974		(O-Ring Type)	B45229	6
Manifold Set, Exhaust	1973-1974			MS10019BS	1
Manifold Set, Intake	1973-1974			MS15512	1
Oil Pan Set	1973-1974			<i>Cork Rubber</i> OS31577	1
Rear Main Seal Set	1973-1974			JV616	1
Timing Cover Set	1973-1974			JV815	1
Harmonic Balancer Repair Sleeve	1973-1974		Use With Part Number A503 <i>Nickel Plated Formed Steel, .013" Oversize</i>	A227	1
MISCELLANEOUS GASKETS					
Carb. Mount Gasket	1973-1974		2 Barrel Carburetor	G26685	1
Exhaust Pipe Gasket	1973-1974		(Flange Type), Pipe To Manifold	F7135	1
Fuel Pump Gasket	1973-1974			D27094	1
				<i>Tuff-Cork</i> D27094TC	1
Push Rod Cover Set	1973-1974			PS38029	1
Water Outlet Gasket	1973-1974			C26501	1
Water Pump Mount Gasket	1973-1974			K27540	1

LIGHT TRUCK

70 454 CID (7.4L) Chevrolet V8 Cyl, 4.250in./108mm (1966-2000) 70

Part	Year	VIN	Model/Application	Part Number	Qty.
ENGINE GASKETS					
Head Set	1998-2000	J	(Head Bolts Not Included, Exhaust Pipe Gasket Not Included)	HS4878B	1
	1996-1997		(Head Bolts Not Included, Exhaust Pipe Gasket Not Included)	HS4878B	1
	1991-1995		(Head Bolts Not Included, Exhaust Pipe Gasket Not Included)	HS4878	1
	1980-1990		(Head Bolts Not Included, Exhaust Pipe Gasket Not Included, Intake Manifold Gasket For Liquid Propane Gas Not Included)	HS3902VC	1
	1970-1979		(Head Bolts Not Included, Exhaust Pipe Gasket Not Included, Intake Manifold Gasket For Liquid Propane Gas Not Included)	HS3805VJ	1
Lower Set	1997-2000		(Requires Head Set To Make Full Set)	CS4878A	1
	1996		10 Bolt Front Cover, (Requires Head Set To Make Full Set)	CS4878	1
			6 Bolt Front Cover, (Requires Head Set To Make Full Set)	CS4878A	1
	1991-1996		(Requires Head Set To Make Full Set)	CS4878	1
	1970-1990		(Requires Head Set To Make Full Set)	CS3805	1
Full Set	1980-1990		(Head Bolts Not Included, Exhaust Pipe Gasket Not Included, Intake Manifold Gasket For Liquid Propane Gas Not Included)	FS3902VC	1
	1970-1979		(Head Bolts Not Included, Exhaust Pipe Gasket Not Included, Intake Manifold Gasket For Liquid Propane Gas Not Included)	FS3805VJ	1
Engine Kit Gasket Set	1991-1995			95-3467VR	1
	1986-1990			95-3425VR	1
	1985		H5D Emission	95-3425VR	1
	1980-1985		Except H5D Emission	95-3049VR	1
	1970-1979			95-3026VR	1
Cylinder Head Gasket	1991-2000		(Single Sided Graphite) Nitroseal	4878	2
	1980-1990		VR2000	3902VC	2
	1970-1979		VR2000	3805VC	2
			(Stainless Steel Flanges) VR2000	3868VC	2
			(Stainless Steel Flanges) Nitroseal	3884SG	2
Cyl. Head Bolt Set	1970-1995			GS33287	2
Valve Cover Set	1991-2000		Victo-Tech	VS50182	1
		(Single Valve Cover) Victo-Tech	VS50183	2	
	1986-1990		Victo-Tech	VS50169	1
	1985		Except H5D Emission Cork Rubber	VS38420	1
			Except H5D Emission High Temperature Cork Rubber	VS38420H	1
			Except H5D Emission Victo-Tech	VS38420R	1
			Except H5D Emission Tuff-Cork	VS38420TC	1
			H5D Emission, H5D Emission Identified By Stainless Steel Exhaust Manifolds Victo-Tech	VS50169	1
	1966-1984		Cork Rubber	VS38420	1
			High Temperature Cork Rubber	VS38420H	1
			Victo-Tech	VS38420R	1
		Tuff-Cork	VS38420TC	1	
Valve Stem Seal, Exh.	1991-2000			B45804	8
	1970-1990		(Shedder Type) Fluoroelastomer	B45296	8
Valve Stem Seal, Int.	1991-2000			B45804	8
	1970-1990		(Shedder Type) Fluoroelastomer	B45296	8
Manifold Set, Exhaust	1996-2000			MS16091	1
	1991-1995		Multi-Layered Steel	MS16500	1
			Nitroseal	MS16500G	1
	1970-1990			MS15164	1
Manifold Set, Intake	1996-2000		(Contains Plenum Chamber Gasket)	MS15688	1
	1991-1995			MS15479	1
	1970-1990		High Performance Engine	MS15168	1
			Except High Performance, Except Liquid Propane Gas, Except Restricted Crossover	MS15188	1

LIGHT TRUCK

General Motors Truck

70 454 CID (7.4L) Chevrolet V8 Cyl, 4.250in./108mm (1966-2000) **70**
 (cont.) (cont.)

Part	Year	VIN	Model/Application	Part Number	Qty.
ENGINE GASKETS (cont.)					
Manifold Set, Intake (cont.)	1970-1990		Liquid Propane Gas Or Restricted Crossover	MS15190	1
Plenum Chamber Gasket	1996-2000			MS36560	1
Oil Pan Set	1991-2000		<i>Victo-Tech</i>	OS32121	1
	1970-1990		<i>Cork Rubber</i>	OS30931X	1
				<i>Tuff-Cork</i>	OS30931XTC
Rear Main Seal Set	1991-2000			JV1614	1
	1970-1990			JV705	1
Crank Repair Sleeve	1991-2000		Rear <i>Nickel Plated Formed Steel, .013" Oversize</i>	A356	1
Timing Cover Set	1997-2000		(Requires Oil Pan Set)	JV1183	1
	1996		10 Bolt Front Cover, (Requires Oil Pan Set)	JV1162	1
			6 Bolt Front Cover, (Requires Oil Pan Set)	JV1183	1
	1991-1995		(Requires Oil Pan Set)	JV1162	1
	1970-1990		(Repair Sleeve Not Included)	JV866	1
			(Repair Sleeve Not Included) <i>Tuff-Cork</i>	JV866TC	1
			(Contains Repair Sleeve)	JV929	1
Timing Cover Gasket	1997-2000			T31378	1
	1996		10 Bolt Front Cover	T27119	1
			6 Bolt Front Cover	T31378	1
1970-1996			T27119	1	
Timing Cover Seal	1970-2000			46467	1
Harmonic Balancer Repair Sleeve	1970-1999		<i>Ground Steel, .020" Oversize</i>	66598RS	1
			Use With Part Number A503 <i>Nickel Plated Formed Steel, .013" Oversize</i>	A230	1
MISCELLANEOUS GASKETS					
Air Cleaner Mount Gasket	1987-1997	N		G27098	1
	1970-1997			G27098	1
Carb. Mount Gasket	1981-1987		4 Barrel Carburetor	G26792	1
	1979-1980		4 Barrel Carburetor	G26905	1
	1974-1978		4 Barrel Carburetor	G26719	1
	1971-1973		4 Barrel Carburetor	G26666	1
	1971		Except Special High Performance Engine, 4 Barrel Carburetor	G26666	1
	1970		4 Barrel Carburetor, Shield To Manifold	G14733	1
	Choke Tube Gasket	1976-1987			B45785
Dist. Mounting Gasket	1970-2000			B25934	1
E.G.R. Gasket	1994-2000			G31304	1
	1991-1993			G31178	1
	1975-1990			G17797	1
	1973-1974			G26338	1
Exhaust Pipe Gasket	1999-2000		C3500HD, Classic Sierra 3500, Classic Sierra 3500HD, 15000 Pound Gross Vehicle Weight, (Flange Type), Pipe To Converter	F7577	1
	1997-2000		C3500, 15000 Pound Gross Vehicle Weight, (Flange Type), Pipe To Converter	F7577	1
	1997-1999		C3500(GMC), 15000 Pound Gross Vehicle Weight, (Flange Type), Pipe To Converter	F7577	1
	1983-1995		2.5" Pipe, (Steel Insert, Ring Type 'E'), Pipe To Manifold	F20423	1
	1992-1993		C1500, C1500(GMC), Catalytic Converter	F7567	1
	1980-1982		(Ring Type 'B'), Pipe To Manifold <i>Sintered Metal</i>	F7139S	1
	1970-1982		(Ring Type 'C'), Pipe To Manifold	F7139	2
	Fuel Pump Gasket	1970-1990			D27094
			<i>Tuff-Cork</i>	D27094TC	1
Heat Riser Gasket	1970-1971		<i>2.437" Inside Diameter</i>	F7192	1
Oil Cooler Gasket	1976-1995		2 Wheel Drive, (Contains Gasket Only), Adapter To Block	H31318	1

LIGHT TRUCK

70 454 CID (7.4L) Chevrolet V8 Cyl, 4.250in./108mm (1966-2000) **70**
(cont.) (cont.)

Part	Year	VIN	Model/Application	Part Number	Qty.
MISCELLANEOUS GASKETS (cont.)					
Oil Cooler Gasket (cont.)	1976-1982		Rear Wheel Drive, (Contains Gasket Only), Adapter To Block	H31318	1
Oil Cooler Mount Kit	1976-1995		(Contains O-Ring And Gasket Mounting Kit), Adapter To Block	GS33272	1
Oil Pan Drain Plug Gst.	1970-2000		Metric Thread .42" Inside Diameter	B45828	1
	1970-1998		English Thread 1/2" Inside Diameter	2051	1
Oil Pump Cover Gasket	1992-2000			B45810	1
Oil Pump Shaft Retainer	1970-2000			H31354	1
Therm. Mount Gasket	1991-2000		Victo-Tech	C31301	1
Throttle Body Gasket	1998-1999	B		G31388	1
	1996-1999	J		G31388	1
	1994-1997	N		G31387	1
	1991-1993			G31386	1
	1988-1990		Throttle Body To Adapter Adapter To Intake Manifold	G31406 G31411	1 1
Water Outlet Gasket	1970-1995		(Universal Type)	C24109	1
				C25930	1
Water Pump Backing Plate	1992-2000		Pump To Plate	K27091	2
	1970-1991		Pump To Plate	K27078	1
Water Pump Mount Gasket	1970-2000			K26632	2

71 478 CID (7.8L) General Motors V6 Cyl, 5.125in./130.2mm (1965) **71**

Part	Year	VIN	Model/Application	Part Number	Qty.
ENGINE GASKETS					
Cylinder Head Gasket	1965		VR2000	3328	2
Valve Cover Set	1965		Cork Rubber	VS38290	1
Valve Stem Seal, Int.	1965		(O-Ring Type)	B45229	6
Manifold Set, Exhaust	1965			MS10009	1
Manifold Set, Intake	1965			MS15955	1
Oil Pan Set	1965		Cork Rubber	OS31577	1
Rear Main Seal Set	1965			JV716	1
Timing Cover Set	1965			JV815	1
Harmonic Balancer Repair Sleeve	1965		Use With Part Number A503 Nickel Plated Formed Steel, .013" Oversize	A227	1
MISCELLANEOUS GASKETS					
Carb. Mount Gasket	1965		2 Barrel Carburetor	G26685	1
Exhaust Pipe Gasket	1965		(Flange Type), Pipe To Manifold	F7135	1
Fuel Pump Gasket	1965			D27094	1
				Tuff-Cork	D27094TC
Push Rod Cover Set	1965			PS38029	1
Water Outlet Gasket	1965			C26501	1
Water Pump Mount Gasket	1965			K27540	1

72 478 CID (7.8L) General Motors Diesel V6 Cyl, 5.125in./130.2mm (1965-1974) **72**

Part	Year	VIN	Model/Application	Part Number	Qty.
ENGINE GASKETS					
Head Set	1965-1974			HS3473	1
Full Set	1965-1974			FS3473	1
Cylinder Head Gasket	1965-1974		VR2000	3473	2
Valve Cover Set	1965-1974		Cork Rubber	VS38290	1

General Motors Truck

72 478 CID (7.8L) General Motors Diesel V6 Cyl, 5.125in./130.2mm (1965-1974) **72**
(cont.) (cont.)

Part Year VIN Model/Application Part Number Qty.

ENGINE GASKETS (cont.)

Valve Stem Seal, Int.	1965-1974		(O-Ring Type)	B45229	6
Manifold Set, Int. & Exh.	1965-1974			MS15124	1
Oil Pan Set	1965-1974		Cork Rubber	OS31577	1
Rear Main Seal Set	1965-1974			JV716	1
Timing Cover Set	1965-1974			JV849	1
Timing Cover Seal	1965-1974			46442	1
Harmonic Balancer Repair Sleeve	1965-1974		Use With Part Number A503 Nickel Plated Formed Steel, .013" Oversize	A227	1

MISCELLANEOUS GASKETS

Fuel Pump Gasket	1965-1974		Tuff-Cork	D27094TC	1
Push Rod Cover Set	1965-1974			PS38029	1
Water Outlet Gasket	1965-1974			C26501	1
Water Pump Mount Gasket	1965-1974			K27540	1

73 496 CID/8135CC (8.1L) Vortec 8100 L18 OHV Chevrolet V8 Cyl, 4.252in./108mm **73**
(2001-2003)

Part Year VIN Model/Application Part Number Qty.

ENGINE GASKETS

Valve Stem Seal, Exh.	2001-2003			B45925	8
Valve Stem Seal, Int.	2001-2003			B45925	8

MISCELLANEOUS GASKETS

Oil Pan Drain Plug Gst.	2001-2003			B45828	1
Thermostat Seal	2001-2003			C31156	1
Throttle Body Gasket	2001-2002			G31388	1

Honda Truck

Engine Index

Engine	Year	Block	Engine	Year	Block
1972CC (2.0L) B20B4 Honda	1997-1998	1	3165CC (3.2L) DOHC 6VD1 Isuzu	1998-2002	6
1972CC (2.0L) B20Z2 DOHC Honda	1999-2001	2	3165CC (3.2L) SOHC ISZ (6VD1) Isuzu	1994-1997	7
2156CC (2.2L) F22B6 SOHC Honda	1995-1997	3	3471CC (3.5L) J35A1 V-TEC SOHC Honda	1999-2001	8
2254CC (2.3L) F23A7 V-TEC SOHC Honda	1998	4	3471CC (3.5L) J35A4 V-TEC SOHC Honda	2002-2003	9
2559CC (2.6L) 4ZE1 SOHC Isuzu	1994-1997	5			

Model Index

Model	Engine	Year	Block	Model	Engine	Year	Block
CR-V	1972CC (2.0L) B20Z2 DOHC Honda	1999-2001	2	Passport	2559CC (2.6L) 4ZE1 SOHC Isuzu	1994-1997	5
CR-V	1972CC (2.0L) B20B4 Honda	1997-1998	1	Passport	3165CC (3.2L) DOHC 6VD1 Isuzu	1998-2002	6
Odyssey	2156CC (2.2L) F22B6 SOHC Honda	1995-1997	3	Passport	3165CC (3.2L) SOHC ISZ (6VD1) Isuzu	1994-1997	7
Odyssey	2254CC (2.3L) F23A7 V-TEC SOHC Honda	1998	4	Pilot	3471CC (3.5L) J35A4 V-TEC SOHC Honda	2003-2004	9
Odyssey	3471CC (3.5L) J35A4 V-TEC SOHC Honda	2002-2004	9				
Odyssey	3471CC (3.5L) J35A1 V-TEC SOHC Honda	1999-2001	8				

1 1972CC (2.0L) B20B4 Honda 4 Cyl, 3.307in./84mm (1997-1998) **1**

Part Year VIN Model/Application Part Number Qty.

ENGINE GASKETS

Cylinder Head Gasket	1997-1998		Multi-Layered Steel	54255	1
Valve Cover Set	1997-1998		(Contains Spark Plug Tube Seals, Valve Cover Washers Not Included) Victo-Tech	VS50138	1
Rear Main Seal	1997-1998		Rubber	67121	1

1	1972CC (2.0L) B20B4 Honda 4 Cyl, 3.307in./84mm (1997-1998)					1
(cont.)						(cont.)
Part	Year	VIN	Model/Application	Part Number	Qty.	
MISCELLANEOUS GASKETS						
Exhaust Pipe Gasket	1997-1998		Dual Pipe, Pipe To Manifold	F7467	2	
			Single Pipe, Pipe To Manifold	F14616	1	
Therm. Mount Gasket	1997-1998			C31051	1	
Valve Cover Grommet	1997-1998			B45689	7	
Water Pump Mount Gasket	1997-1998			K31158	1	
2	1972CC (2.0L) B20Z2 DOHC Honda 4 Cyl, 3.307in./84mm (1999-2001)					2
(cont.)						(cont.)
Part	Year	VIN	Model/Application	Part Number	Qty.	
ENGINE GASKETS						
Cylinder Head Gasket	1999-2001		<i>Multi-Layered Steel</i>	54255	1	
Valve Cover Set	1999-2001		(Contains Spark Plug Tube Seals, Valve Cover Washers Not Included) <i>Victo-Tech</i>	VS50138	1	
Rear Main Seal	1999-2001		<i>Rubber</i>	67121	1	
MISCELLANEOUS GASKETS						
Exhaust Pipe Gasket	1999-2001		Dual Pipe, Pipe To Manifold	F7467	2	
			Single Pipe, Pipe To Manifold	F14616	1	
Therm. Mount Gasket	1999-2001			C31051	1	
Throttle Body Gasket	1999-2001		Automatic Transmission	G31186	1	
Valve Cover Grommet	1999-2001			B45689	7	
Water Pump Mount Gasket	1999-2001			K31158	1	
3	2156CC (2.2L) F22B6 SOHC Honda 4 Cyl, 3.346in./85mm (1995-1997)					3
(cont.)						(cont.)
Part	Year	VIN	Model/Application	Part Number	Qty.	
ENGINE GASKETS						
Head Set	1995-1997			HS4051	1	
Lower Set	1995-1997		(Requires Head Set To Make Full Set)	CS4051	1	
Cylinder Head Gasket	1995-1997		<i>Multi-Layered Steel</i>	4051	1	
Valve Cover Set	1995-1997		(Contains Valve Cover Grommets, Contains Spark Plug Tube Seals) <i>Victo-Tech</i>	VS50072	1	
Valve Stem Seal, Exh.	1995-1997			B45627	8	
Valve Stem Seal, Int.	1995-1997			B45626	8	
Manifold Set, Exhaust	1995-1997			MS16163	1	
Manifold Set, Intake	1995-1997		(Contains Plenum Chamber Gasket)	MS16164	1	
Plenum Chamber Gasket	1995-1997			MS16162	1	
Oil Pan Set	1995-1997		<i>Victo-Tech</i>	OS32055	1	
Rear Main Seal	1995-1997		<i>Rubber</i>	67121	1	
Timing Cover Set	1995-1997			JV1187	1	
Timing Cover Seal	1995-1997			67591	1	
MISCELLANEOUS GASKETS						
Camshaft Seal	1995-1997			67032	1	
E.G.R. Gasket	1995-1997			G26315	1	
Exhaust Pipe Gasket	1995-1997		(Ring Type 'A'), Pipe To Manifold	F7482	1	
Therm. Mount Gasket	1995-1997		<i>Victo-Tech</i>	C31051	1	
Throttle Body Gasket	1995-1997			G31417	1	
Timing Cover Dust Seal Set	1995-1997			JV1192	1	
Water Outlet Gasket	1995-1997		<i>Victo-Tech</i>	C31052	1	
Water Pump Mount Gasket	1995-1997		<i>Victo-Tech</i>	GS31184	1	

Honda Truck

4 2254CC (2.3L) F23A7 V-TEC SOHC Honda 4 Cyl, 3.386in./86mm (1998) 4

Part	Year	VIN	Model/Application	Part Number	Qty.
ENGINE GASKETS					
Valve Cover Set	1998		(Contains Valve Cover Grommets, Contains Spark Plug Tube Seals) <i>Victo-Tech</i>	VS50222	1
Valve Stem Seal, Exh.	1998			B45627	8
Valve Stem Seal, Int.	1998			B45626	8
Oil Pan Set	1998		Original Equipment Uses RTV <i>Silicone</i>	JV6	1

MISCELLANEOUS GASKETS					
Camshaft Seal	1998			67032	1
E.G.R. Gasket	1998			G26315	1
Exhaust Pipe Gasket	1998		(Ring Type 'A'), Pipe To Manifold	F7467	2
			Center Pipe To Muffler	F10108	1
Therm. Mount Gasket	1998		<i>Victo-Tech</i>	C31051	1
Water Outlet Gasket	1998		<i>Victo-Tech</i>	C31052	1

5 2559CC (2.6L) 4ZE1 SOHC Isuzu 4 Cyl, 3.646in./92.6mm (1994-1997) 5

Part	Year	VIN	Model/Application	Part Number	Qty.
ENGINE GASKETS					
Head Set	1994-1997			HS5850W	1
Lower Set	1994-1997		(Requires Head Set To Make Full Set)	CS5850	1
Engine Kit Gasket Set	1994-1995			95-3396VR	1
Cylinder Head Gasket	1994-1997		<i>Nitroseal</i>	5850	1
Cyl. Head Spacer Shim	1994-1997		Requires Sealing Compound <i>Steel</i>	5850S	1
Sealing Compound	1994-1997		(4 Ounce Brush Top Can)	JV66B	1
			(12 Ounce Spray Can)	JV66S	1
Valve Cover Set	1994-1997		(Contains Valve Cover End Plug) <i>Victo-Tech</i>	VS50041	1
Valve Stem Seal, Exh.	1994-1997			B20183	4
Valve Stem Seal, Int.	1994-1997			B20183	4
Manifold Set, Exhaust	1994-1997			MS15424	1
Manifold Set, Intake	1994-1997		(Contains Plenum Chamber Gasket)	MS15617	1
Oil Pan Set	1994-1997		<i>Victo-Foam</i>	OS32045	1
Rear Main Seal Set	1994-1997			JV525	1
Timing Cover Set	1994-1997		(Camshaft Seal Not Included)	JV1188	1
Timing Cover Seal	1994-1997			47927	1

MISCELLANEOUS GASKETS					
Camshaft Seal	1994-1997			66780	1
Cylinder Head End Plug	1994-1997			B24130	2
E.G.R. Gasket	1994-1997			G26276	1
Exhaust Pipe Gasket	1994-1997		(Ring Type 'A'), Pipe To Manifold	F10039	2
			(Flange Type), Converter To Exhaust Pipe	F10086	2
Therm. Housing Gasket	1994-1997			C31066	1
Throttle Body Gasket	1996-1997			G31441	1
	1994-1995			G31440	1
Water Outlet Gasket	1994-1997		(2 Holes) <i>Victopac</i>	C20115	1
Water Pump Mount Gasket	1994-1997			K30743	1

6 3165CC (3.2L) DOHC 6VD1 Isuzu V6 Cyl, 3.677in./93.4mm (1998-2002) 6

Part	Year	VIN	Model/Application	Part Number	Qty.
ENGINE GASKETS					
Timing Cover Set	1998-2002			JV1194	1
MISCELLANEOUS GASKETS					
Camshaft Seal	1998-2002			JV1195	2
E.G.R. Gasket	1998-2002			G31466	1

7 3165CC (3.2L) SOHC ISZ (6VD1) Isuzu V6 Cyl, 3.677in./93.4mm (1994-1997) 7

Part	Year	VIN	Model/Application	Part Number	Qty.
ENGINE GASKETS					
Head Set	1994-1997			HS54038	1
Lower Set	1994-1997		(Requires Head Set To Make Full Set)	CS54038	1
Cylinder Head Gasket	1994-1997		Nitroseal	54038	2
Valve Cover Set	1994-1997		Victo-Tech	VS50226	1
Valve Stem Seal, Exh.	1994-1997			B45571	12
Valve Stem Seal, Int.	1994-1997			B45571	12
Manifold Set, Exhaust	1994-1997			MS12450	1
Manifold Set, Intake	1994-1997		(Contains Plenum Chamber Gasket)	MS12449W	1
Plenum Chamber Gasket	1994-1997			MS16186	1
Oil Pan Set	1994-1997		Cork Rubber	OS32143	1
Rear Main Seal Set	1994-1997			JV1626	1
Timing Cover Set	1994-1997			JV1194	1

MISCELLANEOUS GASKETS

Cam. Circular Plug	1994-1997			B45856	2
Camshaft Seal	1994-1997			JV1195	1
E.G.R. Gasket	1994-1997		Valve	G31211	1
			Pipe	G31466	1
Exhaust Pipe Gasket	1994-1997		(Ring Type 'A'), Pipe To Manifold	F10039	2
Therm. Housing Gasket	1994-1997			C31463	1
Throttle Body Gasket	1994-1997			G31465	1
Water Manifold Gasket	1994-1997			C31467	2
Water Outlet Gasket	1994-1997			C31462	1
Water Pump Mount Gasket	1994-1997			K31464	1

8 3471CC (3.5L) J35A1 V-TEC SOHC Honda V6 Cyl, 3.504in./89mm (1999-2001) 8

Part	Year	VIN	Model/Application	Part Number	Qty.
ENGINE GASKETS					
Valve Cover Set	1999-2001		Victo-Tech	VS17822	1
Manifold Set, Exhaust	1999-2001		Stainless Steel	MS17814	1
Manifold Set, Intake	1999-2001		Multi-Layered Steel	MS17808	1
Plenum Chamber Gasket	1999-2001		Boost Chamber Vacuum Plate To Plenum	B17806	1
			Plenum To Manifold	Multi-Layered Steel	MS17810

MISCELLANEOUS GASKETS

Camshaft Seal	1999-2001			67617	2
E.G.R. Gasket	1999-2001			G30797	1
Exhaust Pipe Gasket	1999-2001		(Ring Type 'A'), Pipe To Manifold	F7413	2
			(Ring Type 'A'), Catalytic Converter To Exhaust Pipe	F12387	1
Water By-Pass Gasket	1999-2001			C17813	1
Water Outlet Gasket	1999-2001			C31207	1
Water Pump Gasket	1999-2001			K17818	1

9 3471CC (3.5L) J35A4 V-TEC SOHC Honda V6 Cyl, 3.504in./89mm (2002-2003) 9

Part	Year	VIN	Model/Application	Part Number	Qty.
ENGINE GASKETS					
Valve Cover Set	2002-2003		Victo-Tech	VS17822	1
Manifold Set, Exhaust	2002-2003		Stainless Steel	MS17814	1

MISCELLANEOUS GASKETS

Camshaft Seal	2002-2003			67617	2
E.G.R. Gasket	2002-2003			G30797	1
Exhaust Pipe Gasket	2002-2003		(Ring Type 'A'), Pipe To Manifold	F7413	2
Water Outlet Gasket	2002-2003			C31207	1

Honda Truck

9 (cont.)	3471CC (3.5L) J35A4 V-TEC SOHC Honda V6 Cyl, 3.504in./89mm (2002-2003)					9 (cont.)
---------------------	---	--	--	--	--	---------------------

Part	Year	VIN	Model/Application	Part Number	Qty.
MISCELLANEOUS GASKETS (cont.)					
Water Pump Gasket	2002-2003			K17818	1

Hummer

Engine Index

Engine	Year	Block	Engine	Year	Block
365 CID (6.0L) Vortec 6000 Chevrolet	2003	1	395 CID/6468CC (6.5L) Chevrolet Diesel	1994-2002	3
379 CID (6.2L) Chevrolet Diesel	1983-1993	2			

Model Index

Model	Engine	Year	Block	Model	Engine	Year	Block
H1	395 CID/6468CC (6.5L) Chevrolet Diesel	2002-2004	3	HMCO	395 CID/6468CC (6.5L) Chevrolet Diesel	1994-2001	3
H2	365 CID (6.0L) Vortec 6000 Chevrolet	2002-2004	1	HMCS	379 CID (6.2L) Chevrolet Diesel	1983-1993	2
HMC4	379 CID (6.2L) Chevrolet Diesel	1983-1993	2	HMCS	395 CID/6468CC (6.5L) Chevrolet Diesel	1994-2001	3
HMC4	395 CID/6468CC (6.5L) Chevrolet Diesel	1994-2001	3	XLC2	379 CID (6.2L) Chevrolet Diesel	1983-1993	2
HMCO	379 CID (6.2L) Chevrolet Diesel	1983-1993	2	XLC2	395 CID/6468CC (6.5L) Chevrolet Diesel	1994-2001	3

1	365 CID (6.0L) Vortec 6000 Chevrolet V8 Cyl, 4.000in./101.6mm (2003)					1
----------	---	--	--	--	--	----------

Part	Year	VIN	Model/Application	Part Number	Qty.
ENGINE GASKETS					
Valve Cover Set	2003		<i>Victo-Tech</i>	VS50250	1
Manifold Set, Exhaust	2003		<i>Multi-Layered Steel</i>	MS16124	1

MISCELLANEOUS GASKETS

Oil Pan Drain Plug Gst.	2003			B45828	1
-------------------------	------	--	--	--------	---

2	379 CID (6.2L) Chevrolet Diesel V8 Cyl, 3.976in./101mm (1983-1993)					2
----------	---	--	--	--	--	----------

Part	Year	VIN	Model/Application	Part Number	Qty.
ENGINE GASKETS					
Cyl. Head Bolt Set	1983-1993			GS33193	2

3	395 CID/6468CC (6.5L) Chevrolet Diesel V8 Cyl, 4.055in./103mm (1994-2002)					3
----------	--	--	--	--	--	----------

Part	Year	VIN	Model/Application	Part Number	Qty.
ENGINE GASKETS					
Lower Set	2000-2002		(Requires Head Set To Make Full Set)	CS3678A	1
Cylinder Head Gasket	1999-2002			4021	2
			.010" Thicker Cylinder Head Gasket	4021T	2
Cyl. Head Bolt Set	1994-2002			GS33193	2
Valve Cover Set	2000-2002		<i>Cork Rubber</i>	VS38327	1
Valve Stem Seal, Exh.	2000-2002		(Positive Type)	B45812	8
Manifold Set, Exhaust	2000-2002			MS15336	1
Manifold Set, Intake	1999-2002	F	Except G Series, High Output Engine, (Contains Plenum Chamber Gasket)	MS15335A	1
Plenum Chamber Gasket	2001-2002		Except G Series	MS16316	1
Oil Pan Set	2000-2002		<i>Cork Rubber</i>	OS32134	1
Rear Main Seal Set	2000-2002			JV1617	1
Timing Cover Set	2000-2002		(Repair Sleeve Not Included)	JV971	1
			(Contains Repair Sleeve)	JV1134	1
Timing Cover Gasket	2000-2002			T31352	1
Timing Cover Seal	2000-2002			46467	1

3 (cont.)	395 CID/6468CC (6.5L) Chevrolet Diesel V8 Cyl, 4.055in./103mm (1994-2002)				3 (cont.)
---------------------	--	--	--	--	---------------------

Part	Year	VIN	Model/Application	Part Number	Qty.
------	------	-----	-------------------	-------------	------

ENGINE GASKETS (cont.)

Harmonic Balancer Repair Sleeve	2000-2002		Use With Part Number A503 <i>Nickel Plated Formed Steel, .013" Thickness</i>	A232	1
--	-----------	--	---	-------------	---

MISCELLANEOUS GASKETS

E.G.R. Gasket	1997-1998	F	Except G Series	G31327	1
Exhaust Pipe Gasket	2000-2002		4 Bolt Flange, (Flange Type), Front, Pipe To Converter	F7566	1
Inj. Pump Mtg. Gasket	2000-2002			B26454	1
Oil Pan Drain Plug Gst.	2000-2002			B45828	1
Therm. Housing Gasket	2000-2002		Crossover	C30677	2
Water Pump Mount Gasket	2000-2002			K31288	1
			Plate To Timing Cover	K31317	1

Hyundai Truck

Engine Index

Engine	Year	Block
1439CC (1.4L) 4G33 Mitsubishi	1984-1987	1

Model Index

Model	Engine	Year	Block
Pony	1439CC (1.4L) 4G33 Mitsubishi	1984-1988	1

1	1439CC (1.4L) 4G33 Mitsubishi 4 Cyl, 2.874in./73mm (1984-1987)				1
----------	---	--	--	--	----------

Part	Year	VIN	Model/Application	Part Number	Qty.
------	------	-----	-------------------	-------------	------

ENGINE GASKETS

Head Set	1984-1987		Canadian	HS5767	1
Full Set	1984-1987		Canadian	FS5767	1
Cylinder Head Gasket	1984-1987		Canadian	<i>Nitroseal</i> 5767	1
Valve Cover Set	1984-1987		Canadian, (Contains Valve Cover Washers)	<i>Victo-Tech</i> VS39753	1
Valve Stem Seal, Exh.	1984-1987		Canadian, (Original Equipment Type)	B45441	4
			Canadian, (Premium)	B45806	4
Valve Stem Seal, Int.	1984-1987		Canadian, (Original Equipment Type)	B45441	4
			Canadian, (Premium)	B45806	4
Manifold Set, Exhaust	1984-1987		Canadian	MS15309	1
Manifold Set, Intake	1984-1987		Canadian	MS15294	1
Oil Pan Set	1984-1987		Canadian	<i>Cork Rubber</i> OS30549	1
Rear Main Seal Set	1984-1987		Canadian	JV506	1
Timing Cover Set	1984-1987		Canadian	JV941	1
Timing Cover Gasket	1984-1987		Canadian	T26807	1
Timing Cover Seal	1984-1987		Canadian	47734	1

MISCELLANEOUS GASKETS

Air Cleaner Mount Gasket	1984-1987		Canadian, 2 Barrel Carburetor	G24090	1
Cam. Semi-Circular Plug	1984-1987		Canadian	B24180	1
Carb. Mount Gasket	1984-1987		Canadian, 2 Barrel Carburetor	G24967	1
E.G.R. Gasket	1984-1987		Canadian	G24092	1
Fuel Pump Gasket	1984-1987		Canadian	D24076	2
Valve Cover Grommet	1984-1987		Canadian	B45729	2
Water Outlet Gasket	1984-1987		Canadian	C24082	1
Water Pump Mount Gasket	1984-1987		Canadian	K26239	1

Infiniti Truck

Engine Index

Engine	Year	Block
3275CC (3.3L) VG33E SOHC Nissan	1997-2000	1

Model Index

Model	Engine	Year	Block
QX4	3275CC (3.3L) VG33E SOHC Nissan	1997-2000	1

1	3275CC (3.3L) VG33E SOHC Nissan V6 Cyl, 3.602in./91.5mm (1997-2000)	1			
Part	Year	VIN	Model/Application	Part Number	Qty.

ENGINE GASKETS

Valve Cover Set	1997-2000			VS38376	1
Plenum Chamber Gasket	1997-2000			MS15494	1

MISCELLANEOUS GASKETS

Valve Stem Seal, Int.	1997-2000			B20183	6
Camshaft Seal	1997-2000			66864	2
E.G.R. Gasket	1997-2000			G20610	1
Exhaust Pipe Gasket	1997-2000		Manifold To Exhaust Pipe	F7281	2
			Muffler To Resonator	F7282	1
			(Flange Type), Front Pipe To Front Intermediate Pipe	Metal F7480	2

Isuzu Truck

Engine Index

Engine	Year	Block
1817CC (1.8L) G180Z SOHC Isuzu	1981-1982	1
1949CC (1.9L) G200Z SOHC Isuzu	1983-1987	2
134 CID (2.2L) OHV Chevrolet	1996-2000	3
2156CC (2.2L) F22B6 SOHC Honda	1996-1997	4
2238CC (2.2L) C223 OHV Isuzu Diesel	1981-1987	5
2254CC (2.3L) F23A7 V-TEC SOHC Honda	1998-1999	6
2254CC (2.3L) 4ZD1 SOHC Isuzu	1986-1995	7

Engine	Year	Block
2559CC (2.6L) 4ZE1 SOHC Isuzu	1988-1995	8
2827CC (2.8L) LL2 Chevrolet	1989-1991	9
3137CC (3.1L) CPC (LG6) Chevrolet	1991-1994	10
3165CC (3.2L) DOHC 6VD1 Isuzu	1992-2003	11
3165CC (3.2L) SOHC ISZ (6VD1) Isuzu	1992-1997	12
262 CID (4.3L) Vortec 4300 Chevrolet	1997-2000	13
350 CID (5.7L) Fuel Injected Chevrolet	1993-2002	14

Model Index

Model	Engine	Year	Block
Amigo	2254CC (2.3L) 4ZD1 SOHC Isuzu	1989-1993	7
Amigo	2559CC (2.6L) 4ZE1 SOHC Isuzu	1989-1994	8
Amigo	3165CC (3.2L) DOHC 6VD1 Isuzu	1998-2000	11
Hombre	134 CID (2.2L) OHV Chevrolet	1996-2000	3
Hombre	262 CID (4.3L) Vortec 4300 Chevrolet	1997-2000	13
NPR	350 CID (5.7L) Fuel Injected Chevrolet	1993-2004	14
Oasis	2156CC (2.2L) F22B6 SOHC Honda	1996-1997	4
Oasis	2254CC (2.3L) F23A7 V-TEC SOHC Honda	1998-1999	6
Pickup	1817CC (1.8L) G180Z SOHC Isuzu	1981-1982	1
Pickup	1949CC (1.9L) G200Z SOHC Isuzu	1983-1987	2
Pickup	2238CC (2.2L) C223 OHV Isuzu Diesel	1981-1987	5
Pickup	2254CC (2.3L) 4ZD1 SOHC Isuzu	1986-1995	7
Pickup	2559CC (2.6L) 4ZE1 SOHC Isuzu	1987-1995	8

Model	Engine	Year	Block
Pickup	3137CC (3.1L) CPC (LG6) Chevrolet	1991-1994	10
Rodeo	2559CC (2.6L) 4ZE1 SOHC Isuzu	1991-1997	8
Rodeo	3137CC (3.1L) CPC (LG6) Chevrolet	1991-1992	10
Rodeo	3165CC (3.2L) SOHC ISZ (6VD1) Isuzu	1993-1997	12
Rodeo	3165CC (3.2L) DOHC 6VD1 Isuzu	1998-2004	11
Rodeo Sport	3165CC (3.2L) DOHC 6VD1 Isuzu	2001-2003	11
Trooper	3165CC (3.2L) SOHC ISZ (6VD1) Isuzu	1992-1997	12
Trooper	3165CC (3.2L) DOHC 6VD1 Isuzu	1992-1995	11
Trooper II	1949CC (1.9L) G200Z SOHC Isuzu	1984-1985	2
Trooper II	2254CC (2.3L) 4ZD1 SOHC Isuzu	1986-1987	7
Trooper II	2559CC (2.6L) 4ZE1 SOHC Isuzu	1988-1991	8
Trooper II	2827CC (2.8L) LL2 Chevrolet	1989-1991	9

1 1817CC (1.8L) G180Z SOHC Isuzu 4 Cyl, 3.307in./84mm (1981-1982) **1**

Part	Year	VIN	Model/Application	Part Number	Qty.	
ENGINE GASKETS						
Head Set	1981-1982			HS3553	1	
Full Set	1981-1982			FS3553	1	
Engine Kit Gasket Set	1981-1982			95-3404VR	1	
Cylinder Head Gasket	1981-1982		Nitroseal	3553	1	
Cyl. Head Spacer Shim	1981-1982		Requires Sealing Compound			
				Steel	3553S	1
Sealing Compound	1981-1982		(4 Ounce Brush Top Can)	JV66B	1	
			(12 Ounce Spray Can)	JV66S	1	
Valve Cover Set	1981-1982		(Contains Valve Cover End Plug)	Cork Rubber	VS38132	1
Valve Stem Seal, Exh.	1981-1982			B20183	4	
Valve Stem Seal, Int.	1981-1982			B20183	4	
Manifold Set, Exhaust	1981-1982			MS12282	1	
Manifold Set, Intake	1981-1982			MS12279	1	
Oil Pan Set	1981-1982			Victo-Tech	OS30164	1
Rear Main Seal Set	1981-1982			JV626	1	
Timing Cover Set	1981-1982		(Requires Oil Pan Set, Requires Valve Cover Set)	JV950	1	
Timing Cover Seal	1981-1982			47604	1	

MISCELLANEOUS GASKETS

Carb. Mount Gasket	1982		2 Barrel Carburetor	G26781	2	
	1981		2 Barrel Carburetor	G26674	2	
Cylinder Head End Plug	1981-1982			B24130	2	
E.G.R. Gasket	1981-1982		To Manifold	G26276	1	
Exhaust Pipe Gasket	1982		(Ring Type 'A'), Pipe To Manifold	F20371	1	
	1981-1982		(Flange Type), Catalytic Converter To Exhaust Pipe	F7277	2	
	1981		(Ring Type 'B'), Pipe To Manifold	F20223	1	
Water Outlet Gasket	1981-1982		(2 Holes)	Victopac	C20115	1
Water Pump Mount Gasket	1981-1982				K27272	1

2 1949CC (1.9L) G200Z SOHC Isuzu 4 Cyl, 3.425in./87mm (1983-1987) **2**

Part	Year	VIN	Model/Application	Part Number	Qty.	
ENGINE GASKETS						
Head Set	1983-1987		(Exhaust Pipe Gasket Not Included)	HS3716	1	
Full Set	1985-1987		(Exhaust Pipe Gasket Not Included)	FS3716W	1	
	1983-1984		(Exhaust Pipe Gasket Not Included)	FS3716	1	
Engine Kit Gasket Set	1987		2 Barrel Carburetor, (Rear Main Seal Not Included), Use With Part Number JV572	95-3404VR	1	
	1983-1986			95-3404VR	1	
Cylinder Head Gasket	1983-1987			Nitroseal	3716G	1
Cyl. Head Spacer Shim	1983-1987		Requires Sealing Compound			
				Steel	3716S	1
Sealing Compound	1983-1987		(4 Ounce Brush Top Can)	JV66B	1	
			(12 Ounce Spray Can)	JV66S	1	
Valve Cover Set	1983-1987		(Contains Valve Cover End Plug)	Cork Rubber	VS38132	1
Valve Stem Seal, Exh.	1983-1987			B20183	4	
Valve Stem Seal, Int.	1983-1987			B20183	4	
Manifold Set, Exhaust	1983-1987			MS12282	1	
Manifold Set, Intake	1983-1987			MS12279	1	
Oil Pan Set	1983-1987			Victo-Tech	OS30164	1
Rear Main Seal Set	1985-1987			JV572	1	
	1983-1984			JV626	1	
Timing Cover Set	1983-1987		(Requires Oil Pan Set, Requires Valve Cover Set)	JV950	1	
Timing Cover Seal	1983-1987			47604	1	

MISCELLANEOUS GASKETS

Carb. Mount Gasket	1983-1987		2 Barrel Carburetor	G26781	2
--------------------	-----------	--	---------------------	--------	---

Isuzu Truck

2 (cont.)	1949CC (1.9L) G200Z SOHC Isuzu 4 Cyl, 3.425in./87mm (1983-1987)				2 (cont.)
---------------------	--	--	--	--	---------------------

Part	Year	VIN	Model/Application	Part Number	Qty.
------	------	-----	-------------------	-------------	------

MISCELLANEOUS GASKETS (cont.)

Cylinder Head End Plug	1983-1986			B24130	2
E.G.R. Gasket	1983-1987		To Manifold	G26276	1
Exhaust Pipe Gasket	1983-1987		(Flange Type), Catalytic Converter To Exhaust Pipe	F7277	2
			(Ring Type 'A'), Pipe To Manifold	F20371	1
Fuel Pump Gasket	1983-1987			D27265	2
Water Outlet Gasket	1983-1987		(2 Holes) <i>Victopac</i>	C20115	1
Water Pump Mount Gasket	1983-1987			K27272	1

3	134 CID (2.2L) OHV Chevrolet 4 Cyl, 3.504in./89mm (1996-2000)				3
----------	--	--	--	--	----------

Part	Year	VIN	Model/Application	Part Number	Qty.
------	------	-----	-------------------	-------------	------

ENGINE GASKETS

Head Set	1996-1997			HS4023	1
Lower Set	1996-2000		(Requires Head Set To Make Full Set)	CS4023	1
Cylinder Head Gasket	1998-2000		<i>Nitroseal</i>	54051	1
	1996-1997			4023	1
Cyl. Head Bolt Set	1996-1997			GS33295	1
Valve Cover Set	1998-2000		<i>Victo-Tech</i>	VS50249	1
	1996-1997		<i>Victo-Tech</i>	VS50051	1
Valve Stem Seal, Exh.	1998-2000			B45864	4
	1996-1997		7mm Valve Stem Diameter	B45814	4
Valve Stem Seal, Int.	1998-2000			B45864	4
	1996-1997		7mm Valve Stem Diameter	B45814	4
Manifold Set, Exhaust	1998-2000			MS16311	1
	1996-1997			MS15440	1
Manifold Set, Intake	1998-2000		<i>Victo-Tech</i>	MS16507	1
	1996-1997		(Contains Plenum Chamber Gasket)	MS15687	1
Plenum Chamber Gasket	1996-1997			MS15687A	1
Oil Pan Set	1996-2000		<i>Cork Rubber</i>	OS32120	1
Rear Main Seal Set	1996-2000			JV544	1
			<i>Teflon</i>	JV1633	1
Timing Cover Set	1996-2000			JV1061	1
Timing Cover Gasket	1996-2000			T31351	1
Timing Cover Seal	1996-2000			48277SF	1

MISCELLANEOUS GASKETS

E.G.R. Gasket	1998-2000		Cover To Cylinder Head, Intake Side	G31525	1
			Adapter Or Cover To Cylinder Head, Rear	G31583	1
	1996-1998		Valve To Adapter	G31356	1
Exhaust Pipe Gasket	1996-1997		Adapter Or Cover To Cylinder Head, Rear	G31481	1
			(Flange Type), Pipe To Converter, Rear	F7555	1
	1997-2000		(Flange Type), Front, Pipe To Converter	F7556	1
			(Flange Type), Pipe To Manifold	F7537	1
	1996		(Flange Type), Front, Pipe To Converter	F7535	1
		(Flange Type), Pipe To Converter, Rear	F7536	1	
Oil Pan Seal	1996-2000		Rear	B45598	1
Throttle Body Gasket	1998-2000			G31524	1
Water Inlet Gasket	1996-2000			C31275	1
Water Outlet Gasket	1998-2000			C31506	1
	1996-1997			C31397	1
Water Pump Mount Gasket	1996-2000			K31274	1

4 2156CC (2.2L) F22B6 SOHC Honda 4 Cyl, 3.346in./85mm (1996-1997) 4

Part	Year	VIN	Model/Application	Part Number	Qty.
ENGINE GASKETS					
Head Set	1996-1997			HS4051	1
Lower Set	1996-1997		(Requires Head Set To Make Full Set)	CS4051	1
Cylinder Head Gasket	1996-1997		<i>Multi-Layered Steel</i>	4051	1
Valve Cover Set	1996-1997		(Contains Valve Cover Grommets, Contains Spark Plug Tube Seals) <i>Victo-Tech</i>	VS50072	1
Valve Stem Seal, Exh.	1996-1997			B45627	8
Valve Stem Seal, Int.	1996-1997			B45626	8
Manifold Set, Exhaust	1996-1997			MS16163	1
Manifold Set, Intake	1996-1997		(Contains Plenum Chamber Gasket)	MS16164	1
Plenum Chamber Gasket	1996-1997			MS16162	1
Oil Pan Set	1996-1997		<i>Victo-Tech</i>	OS32055	1
Rear Main Seal	1996-1997		<i>Rubber</i>	67121	1
Timing Cover Set	1996-1997			JV1187	1
Timing Cover Seal	1996-1997			67591	1

MISCELLANEOUS GASKETS					
Camshaft Seal	1996-1997			67032	1
Exhaust Pipe Gasket	1996-1997		(Ring Type 'A'), Pipe To Manifold	F7467	2
			Center Pipe To Muffler	F10108	1
			Catalytic Converter To Center Pipe	F12387	1
Therm. Mount Gasket	1996-1997		<i>Victo-Tech</i>	C31051	1
Water Outlet Gasket	1996-1997		<i>Victo-Tech</i>	C31052	1

5 2238CC (2.2L) C223 OHV Isuzu Diesel 4 Cyl, 3.465in./88mm (1981-1987) 5

Part	Year	VIN	Model/Application	Part Number	Qty.
ENGINE GASKETS					
Head Set	1981-1987			HS3717	1
Full Set	1981-1987		(Requires Oil Pan Set)	FS3717	1
Cylinder Head Gasket	1981-1987		<i>Steel</i>	3717	1
Valve Cover Set	1981-1987		<i>Victo-Tech</i>	VS39367	1
Valve Stem Seal, Exh.	1981-1987		(O-Ring Type)	B45562	4
				B45565	4
Valve Stem Seal, Int.	1981-1987		(O-Ring Type)	B45562	4
				B45565	4
Manifold Set, Int. & Exh.	1981-1987			MS15332	1
Oil Pan Set	1981-1987		2 Wheel Drive <i>Cork Rubber</i>	OS30579	1
			4 Wheel Drive <i>Cork Rubber</i>	OS30580	1
Rear Main Seal Set	1981-1987			JV626	1
Timing Cover Set	1981-1987			JV972	1

MISCELLANEOUS GASKETS					
Camshaft Seal	1981-1987		(O-Ring Type)	B45743	1
Exhaust Pipe Gasket	1983-1986		(Ring Type 'B'), Pipe To Manifold	F20223	1
	1981-1982		(Ring Type 'B'), Pipe To Manifold	F7276	1
Push Rod Cover Set	1981-1987			PS38796	1
Water Outlet Gasket	1981-1987			C24129	1
Water Pump Mount Gasket	1981-1987			K27422	1

6 2254CC (2.3L) F23A7 V-TEC SOHC Honda 4 Cyl, 3.386in./86mm (1998-1999) 6

Part	Year	VIN	Model/Application	Part Number	Qty.
ENGINE GASKETS					
Valve Cover Set	1998-1999		(Contains Valve Cover Grommets, Contains Spark Plug Tube Seals) <i>Victo-Tech</i>	VS50222	1
Valve Stem Seal, Exh.	1998-1999			B45627	8
Valve Stem Seal, Int.	1998-1999			B45626	8

LIGHT TRUCK

Isuzu Truck

6 (cont.)	2254CC (2.3L) F23A7 V-TEC SOHC Honda 4 Cyl, 3.386in./86mm (1998-1999)				6 (cont.)
---------------------	--	--	--	--	---------------------

Part	Year	VIN	Model/Application	Part Number	Qty.
------	------	-----	-------------------	-------------	------

ENGINE GASKETS (cont.)

Oil Pan Set	1998-1999		Original Equipment Uses RTV	Silicone JV6	1
-------------	-----------	--	-----------------------------	--------------	---

MISCELLANEOUS GASKETS

Camshaft Seal	1998-1999			67032	1
E.G.R. Gasket	1998-1999			G26315	1
Exhaust Pipe Gasket	1998-1999		(Ring Type 'A'), Pipe To Manifold	F7467	2
			Center Pipe To Muffler	F10108	1
Therm. Mount Gasket	1998-1999			Victo-Tech C31051	1
Water Outlet Gasket	1998-1999			Victo-Tech C31052	1

7	2254CC (2.3L) 4ZD1 SOHC Isuzu 4 Cyl, 3.516in./89.3mm (1986-1995)				7
----------	---	--	--	--	----------

Part	Year	VIN	Model/Application	Part Number	Qty.
------	------	-----	-------------------	-------------	------

ENGINE GASKETS

Head Set	1986-1995			HS5743	1
Lower Set	1988-1995			CS5743A	1
	1986-1987		4 Wheel Drive	CS5743	1
				2 Wheel Drive	CS5743A
Full Set	1986-1987		Oil Pan Gasket For Two Wheel Drive Not Included	FS5743	1
Engine Kit Gasket Set	1986-1995		2 Barrel Carburetor	95-3302VR	1
Cylinder Head Gasket	1986-1995			Nitroseal 5743	1
Cyl. Head Spacer Shim	1986-1995		Requires Sealing Compound	5743S	1
Sealing Compound	1986-1995		(4 Ounce Brush Top Can)	JV66B	1
			(12 Ounce Spray Can)	JV66S	1
Valve Cover Set	1986-1995		(Contains Valve Cover End Plug)	Victo-Tech VS50041	1
Valve Stem Seal, Exh.	1986-1995			B20183	4
Valve Stem Seal, Int.	1986-1995			B20183	4
Manifold Set, Exhaust	1986-1995			MS15424	1
Manifold Set, Intake	1986-1995			MS15423	1
Oil Pan Set	1988-1995			Victo-Tech OS32042	1
	1986-1987		2 Wheel Drive	Victo-Tech OS32042	1
				4 Wheel Drive	Victo-Foam OS32045
Rear Main Seal Set	1986-1995			JV525	1
Timing Cover Set	1986-1995		(Camshaft Seal Not Included)	JV1058	1
Timing Cover Seal	1986-1995			47927	1

MISCELLANEOUS GASKETS

Camshaft Seal	1986-1995			66780	1
Carb. Mount Gasket	1986-1994		2 Barrel Carburetor	G30745	2
Cylinder Head End Plug	1986-1995			B24130	2
E.G.R. Gasket	1986-1995			G26276	1
Exhaust Pipe Gasket	1986-1995		(Flange Type), Catalytic Converter To Exhaust Pipe	F7277	2
			(Ring Type 'A'), Pipe To Manifold	F20371	1
Fuel Pump Gasket	1986-1995			D30744	2
Oil Pump Mounting Gasket	1986-1995			B45701	1
Oil Pump Seal	1986-1995			66793	1
Throttle Body Gasket	1994-1995		Multi-Port Fuel Injection	G31440	1
Water Outlet Gasket	1986-1995		(2 Holes)	Victopac C20115	1
Water Pump Mount Gasket	1986-1995			K30743	1

8	2559CC (2.6L) 4ZE1 SOHC Isuzu 4 Cyl, 3.646in./92.6mm (1988-1995)				8
----------	---	--	--	--	----------

Part	Year	VIN	Model/Application	Part Number	Qty.
------	------	-----	-------------------	-------------	------

ENGINE GASKETS

Head Set	1992-1995		(Requires Lower Set To Make Full Set)	HS5850W	1
----------	-----------	--	---------------------------------------	---------	---

LIGHT TRUCK

8 2559CC (2.6L) 4ZE1 SOHC Isuzu 4 Cyl, 3.646in./92.6mm (1988-1995) **8**
(cont.) (cont.)

Part Year VIN Model/Application Part Number Qty.

ENGINE GASKETS (cont.)

Head Set (cont.)	1988-1991			HS5850	1
Lower Set	1992-1995		(Requires Head Set To Make Full Set)	CS5850	1
Full Set	1988-1991			FS5850	1
Engine Kit Gasket Set	1988-1995			95-3396VR	1
Cylinder Head Gasket	1988-1995		<i>Nitroseal</i>	5850	1
Cyl. Head Spacer Shim	1988-1995		Requires Sealing Compound	<i>Steel</i> 5850S	1
Sealing Compound	1988-1995		(4 Ounce Brush Top Can)	JV66B	1
			(12 Ounce Spray Can)	JV66S	1
Valve Cover Set	1988-1995		(Contains Valve Cover End Plug) <i>Victo-Tech</i>	VS50041	1
Valve Stem Seal, Exh.	1988-1995			B20183	4
Valve Stem Seal, Int.	1988-1995			B20183	4
Manifold Set, Exhaust	1988-1995			MS15424	1
Manifold Set, Intake	1988-1995		(Contains Plenum Chamber Gasket)	MS15617	1
Oil Pan Set	1988-1995		<i>Victo-Foam</i>	OS32045	1
Rear Main Seal Set	1988-1995			JV525	1
Timing Cover Set	1992-1995		(Camshaft Seal Not Included)	JV1188	1
	1988-1991		(Camshaft Seal Not Included)	JV1058	1
Timing Cover Seal	1988-1995			47927	1

MISCELLANEOUS GASKETS

Camshaft Seal	1988-1995			66780	1
Cylinder Head End Plug	1988-1995			B24130	2
E.G.R. Gasket	1988-1995			G26276	1
Exhaust Pipe Gasket	1992-1995		(Ring Type 'A'), Pipe To Manifold	F10039	1
	1988-1991		(Flange Type), Catalytic Converter To Exhaust Pipe	F7277	2
			(Flange Type), Pipe To Manifold	F7279	1
Oil Pump Mounting Gasket	1988-1995			B45701	1
Therm. Housing Gasket	1988-1991			C31066	1
Throttle Body Gasket	1992-1995			G31440	1
	1988-1991			G31073	2
Water Outlet Gasket	1988-1995		(2 Holes) <i>Victopac</i>	C20115	1
Water Pump Mount Gasket	1988-1995			K30743	1

9 2827CC (2.8L) LL2 Chevrolet V6 Cyl, 3.500in./88.9mm (1989-1991) **9**

Part Year VIN Model/Application Part Number Qty.

ENGINE GASKETS

Head Set	1989-1991			HS3549T	1
Full Set	1989-1991			FS3549U	1
Engine Kit Gasket Set	1989-1991			95-3416VR	1
Cylinder Head Gasket	1989-1991		<i>VR2000</i>	3549	2
Valve Cover Set	1989-1991		<i>Cork Rubber</i>	VS50019	1
Valve Stem Seal, Int.	1989-1991		<i>Fluoroelastomer</i>	B45418	6
Manifold Set, Exhaust	1989-1991			MS15310	1
Manifold Set, Intake	1989-1991			MS15307	1
Oil Pan Set	1989-1991		<i>Tuff-Cork</i>	OS32476TC	1
Rear Main Seal Set	1989-1991			JV544	1
Timing Cover Set	1989-1991			JV1066	1

MISCELLANEOUS GASKETS

Dist. Mounting Gasket	1989-1991			72214	1
Exhaust Pipe Gasket	1989-1991		(Ring Type 'A'), Pipe To Manifold	F10039	2
Fuel Pump Gasket	1989-1991			D27228	1
Water Outlet Gasket	1989-1991			C30820	1

Isuzu Truck

9 (cont.)	2827CC (2.8L) LL2 Chevrolet V6 Cyl, 3.500in./88.9mm (1989-1991)				9 (cont.)
---------------------	--	--	--	--	---------------------

Part	Year	VIN	Model/Application	Part Number	Qty.
------	------	-----	-------------------	-------------	------

MISCELLANEOUS GASKETS (cont.)

Water Pump Mount Gasket	1989-1991			K30947	1
-------------------------	-----------	--	--	--------	---

10	3137CC (3.1L) CPC (LG6) Chevrolet V6 Cyl, 3.504in./89mm (1991-1994)				10
-----------	--	--	--	--	-----------

Part	Year	VIN	Model/Application	Part Number	Qty.
------	------	-----	-------------------	-------------	------

ENGINE GASKETS

Head Set	1991-1992			HS3549T	1
Full Set	1991-1992			FS3549U	1
Engine Kit Gasket Set	1991-1994			95-3416VR	1
Cylinder Head Gasket	1991-1994		VR2000	3549	2
Valve Cover Set	1991-1994		Cork Rubber	VS50019	1
Valve Stem Seal, Exh.	1991-1994		(O-Ring Type)	B45229	6
Valve Stem Seal, Int.	1991-1994		(O-Ring Type)	B45229	6
			Fluoroelastomer	B45418	6
Manifold Set, Exhaust	1991-1994			MS15310	1
Manifold Set, Intake	1991-1994			MS15307	1
Oil Pan Set	1991-1994		Tuff-Cork	OS32476TC	1
Rear Main Seal Set	1991-1994			JV544	1
			Teflon	JV1633	1
Timing Cover Set	1991-1994			JV1066	1

MISCELLANEOUS GASKETS

Dist. Mounting Gasket	1991-1994			72214	1
E.G.R. Gasket	1991-1994			G17797	1
Exhaust Pipe Gasket	1991-1992		(Ring Type 'A'), Pipe To Manifold	F10039	2
Fuel Pump Gasket	1991-1992			D27228	1
Oil Pan Drain Plug Gst.	1991-1994			2051	1
Throttle Body Gasket	1991-1994			G31132	1
Water Outlet Gasket	1991-1992			C30820	1
Water Pump Mount Gasket	1991-1994			K30947	1

11	3165CC (3.2L) DOHC 6VD1 Isuzu V6 Cyl, 3.677in./93.4mm (1992-2003)				11
-----------	--	--	--	--	-----------

Part	Year	VIN	Model/Application	Part Number	Qty.
------	------	-----	-------------------	-------------	------

ENGINE GASKETS

Head Set	1992-1995			HS54038W	1
Lower Set	1992-1995		(Requires Head Set To Make Full Set)	CS54038	1
Cylinder Head Gasket	1992-1995		Nitroseal	54038	2
Valve Cover Set	1992-1995		Victo-Tech	VS50227	1
Valve Stem Seal, Exh.	1992-1995			B45571	12
Valve Stem Seal, Int.	1992-1995			B45571	12
Manifold Set, Exhaust	1992-1995			MS12450	1
Manifold Set, Intake	1992-1995			MS12449	1
Plenum Chamber Gasket	1992-1995			MS16187	1
Oil Pan Set	1992-1995		Cork Rubber	OS32143	1
Rear Main Seal Set	1992-1995			JV1626	1
Timing Cover Set	1998-2003			JV1194	1
	1992-1995			JV1194	1

MISCELLANEOUS GASKETS

Cam. Circular Plug	1992-1995			B45856	6
Camshaft Seal	1998-2003			JV1195	2
	1992-1995			JV1195	2
E.G.R. Gasket	1998-2003			G31466	1
	1992-1995		Valve	G31211	1

LIGHT TRUCK

11 3165CC (3.2L) DOHC 6VD1 Isuzu V6 Cyl, 3.677in./93.4mm (1992-2003) **11**
(cont.) (cont.)

Part	Year	VIN	Model/Application	Part Number	Qty.
MISCELLANEOUS GASKETS (cont.)					
E.G.R. Gasket (cont.)	1992-1995		Pipe	G31466	1
Exhaust Pipe Gasket	1992-1995		(Ring Type 'A')	F10039	2
Therm. Housing Gasket	1992-1995			C31463	1
Throttle Body Gasket	1992-1995			G31465	1
Water Manifold Gasket	1992-1995			C31467	2
Water Outlet Gasket	1992-1995			C31462	1
Water Pump Mount Gasket	1992-1995			K31464	1

12 3165CC (3.2L) SOHC ISZ (6VD1) Isuzu V6 Cyl, 3.677in./93.4mm (1992-1997) **12**

Part	Year	VIN	Model/Application	Part Number	Qty.
ENGINE GASKETS					
Head Set	1992-1997			HS54038	1
Lower Set	1992-1997		(Requires Head Set To Make Full Set)	CS54038	1
Cylinder Head Gasket	1992-1997		<i>Nitroseal</i>	54038	2
Valve Cover Set	1992-1997		<i>Victo-Tech</i>	VS50226	1
Valve Stem Seal, Exh.	1992-1997			B45571	12
Valve Stem Seal, Int.	1992-1997			B45571	12
Manifold Set, Exhaust	1992-1997			MS12450	1
Manifold Set, Intake	1992-1997		(Contains Plenum Chamber Gasket)	MS12449W	1
Plenum Chamber Gasket	1992-1997			MS16186	1
Oil Pan Set	1992-1997		<i>Cork Rubber</i>	OS32143	1
Rear Main Seal Set	1992-1997			JV1626	1
Timing Cover Set	1992-1997			JV1194	1

MISCELLANEOUS GASKETS					
Cam. Circular Plug	1992-1997			B45856	2
Camshaft Seal	1992-1997			JV1195	1
E.G.R. Gasket	1992-1997		Valve	G31211	1
			Pipe	G31466	1
Exhaust Pipe Gasket	1992-1997		(Ring Type 'A')	F10039	1
Therm. Housing Gasket	1992-1997			C31463	1
Throttle Body Gasket	1992-1997			G31465	1
Water Manifold Gasket	1992-1997			C31467	2
Water Outlet Gasket	1992-1997			C31462	1
Water Pump Mount Gasket	1992-1997			K31464	1

13 262 CID (4.3L) Vortec 4300 Chevrolet V6 Cyl, 4.000in./101.6mm (1997-2000) **13**

Part	Year	VIN	Model/Application	Part Number	Qty.
ENGINE GASKETS					
Head Set	1997-2000		(Exhaust Pipe Gasket Not Included, Plenum Chamber Gasket Not Included)	HS5744E	1
Engine Kit Gasket Set	1997-1998		(Timing Cover Gasket And Seal Not Included)	95-3491VR	1
Cylinder Head Gasket	1997-2000		(Single Sided Graphite) <i>Nitroseal</i>	5744	2
Cyl. Head Bolt Set	1997-2000			GS33286	2
Valve Cover Set	1997-2000		<i>Victo-Tech</i>	VS50211	1
Valve Stem Seal, Exh.	1997-2000			B45796	6
Valve Stem Seal, Int.	1997-2000			B45796	6
Manifold Set, Exhaust	1997-2000			MS12407	1
Manifold Set, Intake	1997-2000		(Plenum Chamber Gasket Not Included)	MS16168	1
Plenum Chamber Gasket	1997-2000			MS14803	1
Oil Pan Set	1997-2000		<i>Victo-Tech</i>	OS32133	1

LIGHT TRUCK

Isuzu Truck

13 262 CID (4.3L) Vortec 4300 Chevrolet V6 Cyl, 4.000in./101.6mm (1997-2000) **13**
 (cont.) (cont.)

Part Year VIN Model/Application Part Number Qty.

ENGINE GASKETS (cont.)

Timing Cover Seal	1997-2000			48382	1
-------------------	-----------	--	--	-------	---

MISCELLANEOUS GASKETS

Dist. Mounting Gasket	1997-2000			B25934	1
E.G.R. Gasket	1997-2000			G31459	1
Exhaust Pipe Gasket	1997-2000		(Ring Type 'E'), Pipe To Manifold	F17990	2
	1997-1999		Catalytic Converter To Muffler Inlet Pipe	F7534	1
Oil Cooler Mount Kit	2000		(Contains O-Ring And Gasket Mounting Kit), Adapter To Block	GS33281	1
Oil Pan Drain Plug Gst.	1997-2000		Metric Thread 10.7mm Inside Diameter	B45828	1
Oil Pump Shaft Retainer	1997-2000			H31354	1
Thermostat Seal	1997-2000		<i>Victo-Tech</i>	C31273	1
Throttle Body Gasket	1997-2000			G31329	1
Water Pump Backing Plate	1997-2000		Pump To Plate	K27091	1
Water Pump Mount Gasket	1997-2000			K25935	2

14 350 CID (5.7L) Fuel Injected Chevrolet V8 Cyl, 4.000in./101.6mm (1993-2002) **14**

Part Year VIN Model/Application Part Number Qty.

ENGINE GASKETS

Head Set	1996-1999		(Contains Graphite Head Gasket, Exhaust Pipe Gasket Not Included, Plenum Chamber Gasket Not Included)	HS5746B	1	
	1993-1995		(Exhaust Pipe Gasket Not Included, Contains VR2000 Cylinder Head Gasket)	HS1178VN	1	
				(Contains Graphite Head Gasket, Exhaust Pipe Gasket Not Included)	HS5746A	1
Lower Set	1996-1998		(Requires Head Set To Make Full Set, Timing Cover Gasket And Seal Not Included)	CS5746	1	
	1993-1995		(Requires Head Set To Make Full Set)	CS1178C	1	
Cylinder Head Gasket	1993-2002		(Single Sided Graphite) <i>Nitroseal</i>	5746	2	
Cyl. Head Bolt Set	1993-2002			GS33285	2	
Valve Cover Set	1993-2002			<i>Tuff-Cork</i>	VS50025TC	1
			(Single Valve Cover) <i>Tuff-Cork</i>	VS50126TC	2	
				<i>Victo-Tech</i>	VS50161	1
			(Single Valve Cover) <i>Victo-Tech</i>	VS50163	2	
Valve Stem Seal, Exh.	1998-2002			B45796	8	
	1993-1995		3/8" Valve Stem	B45874	8	
Valve Stem Seal, Int.	1998-2002			B45796	8	
	1993-1997		(O-Ring Type)	B45229	8	
				(Positive Type) <i>Fluoroelastomer</i>	B45418	8
Manifold Set, Exhaust	1996-2002			MS16093	1	
	1993-1995			MS7110X	1	
Manifold Set, Intake	1996-2002		(Plenum Chamber Gasket Not Included)	MS16167	1	
Plenum Chamber Gasket	1996-2002		(Contains Plenum)	MS14804	1	
Oil Pan Set	1993-2002			<i>Tuff-Cork</i>	OS32471TC	1
				<i>Victo-Tech</i>	OS32496	1
			(Original Equipment Style Steel Backbone) <i>Victo-Tech</i>	OS32496B	1	
Rear Main Seal Set	1996-1999			JV1620	1	
	1993-1995		(1 Piece)	JV554	1	
Crank Repair Sleeve	1993-1995		Use With Part Number A506, Rear <i>Nickel Plated Formed Steel, .013" Thickness</i>	A338	1	
Timing Cover Seal	1996-2002			48382	1	
	1993-1995			<i>3/8" Wide</i>	49328	1
Harmonic Balancer Repair Sleeve	1993-1995			<i>Ground Steel, .020" Thickness</i>	66597RS	1

LIGHT TRUCK

14 350 CID (5.7L) Fuel Injected Chevrolet V8 Cyl, 4.000in./101.6mm (1993-2002) **14**
 (cont.) (cont.)

Part	Year	VIN	Model/Application	Part Number	Qty.
ENGINE GASKETS (cont.)					
Harmonic Balancer Repair Sleeve (cont.)	1993-1995		Use With Part Number A504 <i>Nickel Plated Formed Steel, .013" Thickness</i>	A228	1
MISCELLANEOUS GASKETS					
Dist. Mounting Gasket	1993-2002			B25934	1
E.G.R. Gasket	1993-1995			G31178	1
Exhaust Pipe Gasket	1993-1995		(Ring Type 'E'), Pipe To Manifold	F17990	2
Fuel Pump Gasket	1993-2002		Plate To Block	D25932	1
			Plate To Block <i>Tuff-Cork</i>	D25932TC	1
Oil Cooler Mount Kit	1993-2002		(Contains O-Ring And Gasket Mounting Kit), Adapter To Block	GS33272	1
Oil Pan Drain Plug Gst.	1996-2002		Metric Thread <i>10.7mm Inside Diameter</i>	B45828	1
	1993-1995		English Thread <i>1/2" Inside Diameter</i>	2051	1
Oil Pump Shaft Retainer	1993-2002			H31354	1
Thermostat Seal	1993-2002			<i>Victo-Tech</i> C31273	1
Throttle Body Gasket	1996-2002			G31329	1
	1995			G31342	1
	1993-1994			G31133	1
Water Pump Backing Plate	1993-2002			K27091	1
Water Pump Mount Gasket	1993-2002			K25935	2

Jeep

Engine Index

Engine	Year	Block
126 CID (2.1L) Turbo Renault Diesel	1985-1989	1
134 CID (2.2L) F-Head	1950-1973	2
134 CID (2.2L) L-Head	1939-1966	3
148 CID/2429CC (2.4L) ED1 DOHC	2002-2003	4
150 CID (2.5L)	1983-2002	5
151 CID (2.5L) Carbureted Pontiac	1980-1983	6
173 CID (2.8L) Chevrolet	1984-1986	7
225 CID (3.7L) Buick	1966-1971	8
226 CID (3.7L) Continental	1947-1965	9
226 CID/3701CC (3.7L) EKG SOHC 12 Valve Chrysler	2002-2003	10
230 CID (3.8L) Tornado	1962-1968	11

Engine	Year	Block
232 CID (3.8L) American Motors Co.	1965-1978	12
242 CID (4.0L)	1986-2003	13
258 CID (4.2L) American Motors Co.	1971-1990	14
287 CID (4.7L) SOHC Chrysler	1999-2003	15
304 CID (5.0L) American Motors Co.	1971-1981	16
318 CID (5.2L) Chrysler	1993-1998	17
327 CID (5.4L)	1965-1968	18
350 CID (5.7L) Buick	1968-1971	19
360 CID (5.9L) American Motors Co.	1971-1991	20
360 CID (5.9L) Chrysler	1998	21
401 CID (6.6L) American Motors Co.	1973-1978	22

Model Index

Model	Engine	Year	Block
4 X 2	134 CID (2.2L) L-Head	1948-1950	3
4 X 4	134 CID (2.2L) L-Head	1947-1950	3
6-230	230 CID (3.8L) Tornado	1962-1965	11
38	134 CID (2.2L) L-Head	1939	3
48	134 CID (2.2L) L-Head	1939	3
440	134 CID (2.2L) L-Head	1940	3
441	134 CID (2.2L) L-Head	1941	3
442	134 CID (2.2L) L-Head	1942	3
454	134 CID (2.2L) F-Head	1954	2
473	134 CID (2.2L) F-Head	1950-1952	2
475	134 CID (2.2L) F-Head	1953-1956	2
654	226 CID (3.7L) Continental	1947-1954	9
CJ2A	134 CID (2.2L) L-Head	1945-1949	3
CJ3A	134 CID (2.2L) L-Head	1949-1952	3
CJ3B	134 CID (2.2L) F-Head	1953-1966	2
CJ5	134 CID (2.2L) F-Head	1955-1970	2
CJ5	151 CID (2.5L) Carbureted Pontiac	1980-1983	6
CJ5	225 CID (3.7L) Buick	1966-1970	8
CJ5	232 CID (3.8L) American Motors Co.	1972-1978	12

Model	Engine	Year	Block
CJ5	258 CID (4.2L) American Motors Co.	1972-1977	14
CJ5	304 CID (5.0L) American Motors Co.	1972-1981	16
CJ5A	134 CID (2.2L) F-Head	1964-1968	2
CJ5A	225 CID (3.7L) Buick	1966-1968	8
CJ6	134 CID (2.2L) F-Head	1956-1968	2
CJ6	225 CID (3.7L) Buick	1966-1968	8
CJ6	232 CID (3.8L) American Motors Co.	1972-1975	12
CJ6	258 CID (4.2L) American Motors Co.	1972-1975	14
CJ6	304 CID (5.0L) American Motors Co.	1972-1975	16
CJ6A	134 CID (2.2L) F-Head	1964-1968	2
CJ6A	225 CID (3.7L) Buick	1966-1968	8
CJ7	150 CID (2.5L)	1983-1986	5
CJ7	151 CID (2.5L) Carbureted Pontiac	1980-1983	6
CJ7	232 CID (3.8L) American Motors Co.	1975-1978	12

Jeep

Model Index (cont.)

<i>Model</i>	<i>Engine</i>	<i>Year</i>	<i>Block</i>	<i>Model</i>	<i>Engine</i>	<i>Year</i>	<i>Block</i>
CJ7	258 CID (4.2L) American Motors Co.	1975-1986	14	Gladiator J2600	350 CID (5.7L) Buick	1968-1970	19
CJ7	304 CID (5.0L) American Motors Co.	1975-1981	16	Gladiator J2700	230 CID (3.8L) Tornado	1965-1966	11
CJ8	150 CID (2.5L)	1984-1985	5	Gladiator J2700	232 CID (3.8L) American Motors Co.	1967-1970	12
CJ8	151 CID (2.5L) Carbureted Pontiac	1981-1983	6	Gladiator J2700	327 CID (5.4L)	1965-1970	18
CJ8	258 CID (4.2L) American Motors Co.	1981-1985	14	Gladiator J2700	350 CID (5.7L) Buick	1968-1970	19
CJ8	304 CID (5.0L) American Motors Co.	1981	16	Gladiator J2800	230 CID (3.8L) Tornado	1965-1966	11
Cherokee	126 CID (2.1L) Turbo Renault Diesel	1984-1996	1	Gladiator J2800	232 CID (3.8L) American Motors Co.	1967-1968	12
Cherokee	150 CID (2.5L)	1984-2000	5	Gladiator J2800	327 CID (5.4L)	1965-1968	18
Cherokee	173 CID (2.8L) Chevrolet	1984-1987	7	Gladiator J2800	350 CID (5.7L) Buick	1968	19
Cherokee	232 CID (3.8L) American Motors Co.	1974-1978	12	Gladiator J2800	230 CID (3.8L) Tornado	1965-1968	11
Cherokee	242 CID (4.0L)	1986-2001	13	Gladiator J3500	232 CID (3.8L) American Motors Co.	1967-1970	12
Cherokee	258 CID (4.2L) American Motors Co.	1974-1983	14	Gladiator J3500	327 CID (5.4L)	1965-1970	18
Cherokee	360 CID (5.9L) American Motors Co.	1974-1983	20	Gladiator J3500	350 CID (5.7L) Buick	1968-1970	19
Cherokee	401 CID (6.6L) American Motors Co.	1974-1978	22	Gladiator J3600	230 CID (3.8L) Tornado	1965-1968	11
Comanche	126 CID (2.1L) Turbo Renault Diesel	1986-1989	1	Gladiator J3600	232 CID (3.8L) American Motors Co.	1965-1970	12
Comanche	150 CID (2.5L)	1986-1992	5	Gladiator J3600	327 CID (5.4L)	1965-1970	18
Comanche	173 CID (2.8L) Chevrolet	1986-1987	7	Gladiator J3600	350 CID (5.7L) Buick	1968-1970	19
Comanche	242 CID (4.0L)	1986-1992	13	Gladiator J3700	230 CID (3.8L) Tornado	1965-1966	11
Comanche	258 CID (4.2L) American Motors Co.	1989-1990	14	Gladiator J3700	232 CID (3.8L) American Motors Co.	1967-1970	12
DJ3A	134 CID (2.2L) L-Head	1956-1966	3	Gladiator J3700	327 CID (5.4L)	1965-1970	18
DJ5	134 CID (2.2L) F-Head	1965-1970	2	Gladiator J3700	350 CID (5.7L) Buick	1968-1970	19
DJ5	225 CID (3.7L) Buick	1966-1970	8	Gladiator J3700	230 CID (3.8L) Tornado	1965-1966	11
DJ5	232 CID (3.8L) American Motors Co.	1972-1973	12	Gladiator J3800	232 CID (3.8L) American Motors Co.	1967-1970	12
DJ6	134 CID (2.2L) F-Head	1965-1970	2	Gladiator J3800	327 CID (5.4L)	1965-1970	18
DJ6	225 CID (3.7L) Buick	1966-1970	8	Gladiator J3800	350 CID (5.7L) Buick	1968-1970	19
F4-134	134 CID (2.2L) F-Head	1957-1965	2	Gladiator J3800	230 CID (3.8L) Tornado	1965-1966	11
FC150	134 CID (2.2L) F-Head	1961-1966	2	Gladiator J4500	232 CID (3.8L) American Motors Co.	1970	12
FC150	134 CID (2.2L) L-Head	1957-1960	3	Gladiator J4500	350 CID (5.7L) Buick	1970	19
FC170	226 CID (3.7L) Continental	1957-1966	9	Gladiator J4600	232 CID (3.8L) American Motors Co.	1970	12
FC170 HD	226 CID (3.7L) Continental	1963-1966	9	Gladiator J4600	350 CID (5.7L) Buick	1970	19
FJ3	134 CID (2.2L) F-Head	1961-1962	2	Grand Cherokee	242 CID (4.0L)	1993-2004	13
Gladiator	230 CID (3.8L) Tornado	1962-1968	11	Grand Cherokee	287 CID (4.7L) SOHC Chrysler	1999-2004	15
Gladiator	232 CID (3.8L) American Motors Co.	1970-1973	12	Grand Cherokee	318 CID (5.2L) Chrysler	1993-1998	17
Gladiator	258 CID (4.2L) American Motors Co.	1971-1973	14	Grand Cherokee	360 CID (5.9L) Chrysler	1998	21
Gladiator	304 CID (5.0L) American Motors Co.	1971-1972	16	Grand Cherokee	258 CID (4.2L) American Motors Co.	1984-1986	14
Gladiator	327 CID (5.4L)	1965-1971	18	Wagoneer Grand	360 CID (5.9L) American Motors Co.	1984-1991	20
Gladiator	350 CID (5.7L) Buick	1968-1971	19	Wagoneer			
Gladiator	360 CID (5.9L) American Motors Co.	1971-1973	20				
Gladiator J200	230 CID (3.8L) Tornado	1963-1965	11				
Gladiator J300	230 CID (3.8L) Tornado	1963-1965	11				
Gladiator J2500	230 CID (3.8L) Tornado	1965-1966	11				
Gladiator J2500	232 CID (3.8L) American Motors Co.	1967-1970	12				
Gladiator J2500	327 CID (5.4L)	1965-1970	18				
Gladiator J2600	230 CID (3.8L) Tornado	1965-1966	11				
Gladiator J2600	232 CID (3.8L) American Motors Co.	1967-1970	12				
Gladiator J2600	327 CID (5.4L)	1965-1970	18				

Model Index (cont.)

Model	Engine	Year	Block	Model	Engine	Year	Block
J10	232 CID (3.8L) American Motors Co.	1974-1978	12	J4700	232 CID (3.8L) American Motors Co.	1971-1973	12
J10	258 CID (4.2L) American Motors Co.	1974-1988	14	J4700	258 CID (4.2L) American Motors Co.	1971-1973	14
J10	360 CID (5.9L) American Motors Co.	1974-1988	20	J4700	304 CID (5.0L) American Motors Co.	1971-1972	16
J10	401 CID (6.6L) American Motors Co.	1974-1978	22	J4700	350 CID (5.7L) Buick	1971	19
J20	232 CID (3.8L) American Motors Co.	1974-1978	12	J4700	360 CID (5.9L) American Motors Co.	1971-1973	20
J20	258 CID (4.2L) American Motors Co.	1974-1988	14	J4800	134 CID (2.2L) F-Head	1973	2
J20	360 CID (5.9L) American Motors Co.	1974-1988	20	J4800	232 CID (3.8L) American Motors Co.	1971-1973	12
J20	401 CID (6.6L) American Motors Co.	1974-1978	22	J4800	258 CID (4.2L) American Motors Co.	1971-1973	14
J2500	134 CID (2.2L) F-Head	1973	2	J4800	304 CID (5.0L) American Motors Co.	1971-1972	16
J2500	232 CID (3.8L) American Motors Co.	1971-1973	12	J4800	350 CID (5.7L) Buick	1971	19
J2500	258 CID (4.2L) American Motors Co.	1971-1973	14	J4800	360 CID (5.9L) American Motors Co.	1971-1973	20
J2500	304 CID (5.0L) American Motors Co.	1971-1972	16	Jeepster	134 CID (2.2L) F-Head	1966-1973	2
J2500	350 CID (5.7L) Buick	1971	19	Jeepster	225 CID (3.7L) Buick	1966-1970	8
J2500	360 CID (5.9L) American Motors Co.	1971-1973	20	Jeepster	232 CID (3.8L) American Motors Co.	1972-1973	12
J2600	134 CID (2.2L) F-Head	1973	2	Jeepster	258 CID (4.2L) American Motors Co.	1971-1973	14
J2600	232 CID (3.8L) American Motors Co.	1972-1973	12	Jeepster	304 CID (5.0L) American Motors Co.	1972-1973	16
J2600	258 CID (4.2L) American Motors Co.	1972-1973	14	Jeepster	350 CID (5.7L) Buick	1971	19
J2600	304 CID (5.0L) American Motors Co.	1972	16	Jeepster	360 CID (5.9L) American Motors Co.	1971	20
J2600	360 CID (5.9L) American Motors Co.	1972-1973	20	L6-226 Liberty	226 CID (3.7L) Continental	1955-1964	9
J3800	232 CID (3.8L) American Motors Co.	1971	12	Liberty	148 CID/2429CC (2.4L) ED1 DOHC	2002-2004	4
J3800	258 CID (4.2L) American Motors Co.	1971	14	Liberty	226 CID/3701CC (3.7L) EKG SOHC 12 Valve Chrysler	2002-2004	10
J3800	304 CID (5.0L) American Motors Co.	1971	16	TJ	148 CID/2429CC (2.4L) ED1 DOHC	2003-2004	4
J3800	350 CID (5.7L) Buick	1971	19	TJ	150 CID (2.5L)	2002	5
J3800	360 CID (5.9L) American Motors Co.	1971	20	TJ	242 CID (4.0L)	2002-2004	13
J4500	134 CID (2.2L) F-Head	1973	2	Wagoneer	126 CID (2.1L) Turbo Renault Diesel	1984-1990	1
J4500	232 CID (3.8L) American Motors Co.	1971-1973	12	Wagoneer	134 CID (2.2L) F-Head	1972-1973	2
J4500	258 CID (4.2L) American Motors Co.	1971-1973	14	Wagoneer	150 CID (2.5L)	1984-1990	5
J4500	304 CID (5.0L) American Motors Co.	1971-1972	16	Wagoneer	173 CID (2.8L) Chevrolet	1984-1987	7
J4500	350 CID (5.7L) Buick	1971	19	Wagoneer	230 CID (3.8L) Tornado	1963-1966	11
J4500	360 CID (5.9L) American Motors Co.	1971-1973	20	Wagoneer	232 CID (3.8L) American Motors Co.	1966-1978	12
J4600	134 CID (2.2L) F-Head	1973	2	Wagoneer	242 CID (4.0L)	1986-1990	13
J4600	232 CID (3.8L) American Motors Co.	1971-1973	12	Wagoneer	258 CID (4.2L) American Motors Co.	1971-1983	14
J4600	258 CID (4.2L) American Motors Co.	1971-1973	14	Wagoneer	304 CID (5.0L) American Motors Co.	1971-1972	16
J4600	304 CID (5.0L) American Motors Co.	1971-1972	16	Wagoneer	327 CID (5.4L)	1965-1970	18
J4600	350 CID (5.7L) Buick	1971	19	Wagoneer	350 CID (5.7L) Buick	1968-1970	19
J4600	360 CID (5.9L) American Motors Co.	1971-1973	20	Wagoneer	360 CID (5.9L) American Motors Co.	1971-1983	20
J4600	258 CID (4.2L) American Motors Co.	1971-1973	14	Wagoneer	401 CID (6.6L) American Motors Co.	1974-1978	22
J4600	304 CID (5.0L) American Motors Co.	1971-1972	16	Wrangler	148 CID/2429CC (2.4L) ED1 DOHC	2003-2004	4
J4600	350 CID (5.7L) Buick	1971	19	Wrangler	150 CID (2.5L)	1987-2002	5
J4600	360 CID (5.9L) American Motors Co.	1971-1973	20	Wrangler	242 CID (4.0L)	1989-2004	13
J4700	134 CID (2.2L) F-Head	1973	2	Wrangler	258 CID (4.2L) American Motors Co.	1987-1990	14

LIGHT TRUCK

1 126 CID (2.1L) Turbo Renault Diesel 4 Cyl, 3.386in./86mm (1985-1989) 1

Part	Year	VIN	Model/Application	Part Number	Qty.
ENGINE GASKETS					
Cylinder Head Gasket	1985-1989		Piston Stand Out Under .96mm	1.6mm Thickness 5724	1

Jeep

1 (cont.)	126 CID (2.1L) Turbo Renault Diesel 4 Cyl, 3.386in./86mm (1985-1989)	1 (cont.)
---------------------	---	---------------------

Part	Year	VIN	Model/Application	Part Number	Qty.
ENGINE GASKETS (cont.)					
Cylinder Head Gasket (cont.)	1985-1989		Piston Stand Out From .96mm To 1.04mm <i>1.70mm Thickness</i>	5725	1
			Piston Stand Out Over 1.04mm <i>1.8mm Thickness</i>	5726	1
Valve Cover Set	1985-1989		<i>Cork Rubber</i>	VS50031	1
Oil Pan Set	1985-1989		<i>Cork Rubber</i>	OS32040	1
Timing Cover Seal	1985-1989			48063	1

2	134 CID (2.2L) F-Head 4 Cyl, 3.125in./79.4mm (1950-1973)	2
----------	---	----------

Part	Year	VIN	Model/Application	Part Number	Qty.
ENGINE GASKETS					
Head Set	1950-1973			HS1057K	1
Full Set	1950-1973			FS1057K	1
Cylinder Head Gasket	1950-1973		<i>VR2000</i>	1057K	1
Valve Cover Set	1950-1973		<i>Cork Rubber</i>	VS38092	1
Manifold Set, Int. & Exh.	1950-1973			MS18202	1
Oil Pan Set	1950-1973		<i>Cork Rubber</i>	OS30656	1
Rear Main Seal Set	1950-1973			JV687	1
Timing Cover Set	1950-1973			JV797	1
Timing Cover Seal	1950-1973			49575	1

MISCELLANEOUS GASKETS

Carb. Mount Gasket	1950-1972		1 Barrel Carburetor	G17886	1
Exhaust Pipe Gasket	1950-1973		(Flange Type), Pipe To Manifold	F5360C	1
Fuel Pump Bowl Gasket	1950-1973			D34545	1
Fuel Pump Gasket	1950-1973			D27094	1
Push Rod Cover Set	1950-1973		<i>Cork Rubber</i>	VS38055	1
Water Pump Mount Gasket	1950-1973			K26226	1

3	134 CID (2.2L) L-Head 4 Cyl, 3.125in./79.4mm (1939-1966)	3
----------	---	----------

Part	Year	VIN	Model/Application	Part Number	Qty.
ENGINE GASKETS					
Head Set	1956-1964			HS1023K	1
	1945-1953			HS1023K	1
	1939-1942			HS1023K	1
Full Set	1956-1964			FS1023KJ	1
	1945-1953			FS1023KJ	1
	1939-1942			FS1023KJ	1
Cylinder Head Gasket	1956-1964		<i>VR2000</i>	1023K	1
	1945-1953		<i>VR2000</i>	1023K	1
	1939-1942		<i>VR2000</i>	1023K	1
Manifold Set, Int. & Exh.	1956-1964			MS18632	1
	1945-1953			MS18632	1
	1939-1942			MS18632	1
Oil Pan Set	1956-1964		<i>Cork Rubber</i>	OS30656	1
	1945-1953		<i>Cork Rubber</i>	OS30656	1
	1939-1942		<i>Cork Rubber</i>	OS30656	1
Rear Main Seal Set	1956-1964			JV687	1
	1945-1953			JV687	1
	1939-1942			JV687	1
Timing Cover Set	1956-1966		From Serial Number 54100	JV797	1
			Thru Serial Number 54100	JV855	1
	1945-1953		From Serial Number 54100	JV797	1
			Thru Serial Number 54100	JV855	1

LIGHT TRUCK

3 134 CID (2.2L) L-Head 4 Cyl, 3.125in./79.4mm (1939-1966) **3**
 (cont.) (cont.)

Part Year VIN Model/Application Part Number Qty.

ENGINE GASKETS (cont.)

Timing Cover Set (cont.)	1939-1942		From Serial Number 54100	JV797	1
			Thru Serial Number 54100	JV855	1
Timing Cover Seal	1956-1964		DJ3A, From Serial Number 54100	49575	1
	1957-1960		FC150, From Serial Number 54100	49575	1
	1949-1953		CJ3A, From Serial Number 54100	49575	1
	1948-1950		4 X 2, From Serial Number 54100	49575	1
	1947-1950		4 X 4, From Serial Number 54100	49575	1
	1945-1949		CJ2A, From Serial Number 54100	49575	1
	1942		442, From Serial Number 54100	49575	1
	1941		441, From Serial Number 54100	49575	1
	1940		440, From Serial Number 54100	49575	1
1939		38, 48, From Serial Number 54100	49575	1	

MISCELLANEOUS GASKETS

Exhaust Pipe Gasket	1956-1964		(Flange Type), Pipe To Manifold	F5360C	1
	1945-1953		(Flange Type), Pipe To Manifold	F5360C	1
	1939-1942		(Flange Type), Pipe To Manifold	F5360C	1
Fuel Pump Bowl Gasket	1956-1964			D34545	1
	1945-1953			D34545	1
	1939-1942			D34545	1
Fuel Pump Gasket	1956-1964			D27094	1
	1945-1953			D27094	1
	1939-1942			D27094	1
Push Rod Cover Set	1956-1964		<i>Cork Rubber</i>	VS38055	1
	1945-1953		<i>Cork Rubber</i>	VS38055	1
	1939-1942		<i>Cork Rubber</i>	VS38055	1
Water Pump Mount Gasket	1956-1964			K26226	1
	1945-1953			K26226	1
	1939-1942			K26226	1

4 148 CID/2429CC (2.4L) ED1 DOHC 4 Cyl, 3.445in./87.5mm (2002-2003) **4**

Part Year VIN Model/Application Part Number Qty.

ENGINE GASKETS

Cyl. Head Bolt Set	2002-2003			GS33343	1
Valve Stem Seal, Exh.	2002-2003			B45844	8
Valve Stem Seal, Int.	2002-2003			B45844	8
Oil Pan Set	2002-2003		<i>Victo-Tech</i>	OS32155	1

MISCELLANEOUS GASKETS

Camshaft Seal	2002-2003		Front	48392	2
Water Pump Mount Gasket	2002-2003			K31502	1

5 150 CID (2.5L) 4 Cyl, 3.875in./98.4mm (1983-2002) **5**

Part Year VIN Model/Application Part Number Qty.

ENGINE GASKETS

Head Set	1994-1998		Except KDX Export Engine	HS3799B	1
	1991-1993		Except KDX Export Engine	HS3799A	1
	1983-1990			HS3799	1
Lower Set	1992-1998			CS3799A	1
	1991			CS3799	1
Full Set	1983-1990			FS3799	1
Engine Kit Gasket Set	1994-1998			95-3479VR	1
	1991-1993		Aluminum Valve Cover	95-3482VR	1

LIGHT TRUCK

Jeep

5 (cont.)	150 CID (2.5L) 4 Cyl, 3.875in./98.4mm (1983-2002)				5 (cont.)
---------------------	--	--	--	--	---------------------

<i>Part</i>	<i>Year</i>	<i>VIN</i>	<i>Model/Application</i>	<i>Part Number</i>	<i>Qty.</i>
ENGINE GASKETS (cont.)					
Engine Kit Gasket Set (cont.)	1991-1993		Plastic Valve Cover	95-3483VR	1
	1983-1990		(Valve Stem Seals Not Included), Use With Part Numbers B45410 (4), B45411 (4)	95-3341VR	1
Cylinder Head Gasket	1983-1998			3799	1
Valve Cover Set	1994-1998			VS50243	1
	1991-1993		Aluminum Cover	VS50243	1
				Plastic Cover	VS50244
	1983-1990		<i>Victo-Tech</i>	VS50001	1
Valve Stem Seal, Exh.	1994-2002			B45799B	4
	1986-1993			B45411	4
Valve Stem Seal, Int.	1994-2002			B45798B	4
	1986-1993			B45410	4
Manifold Set, Int. & Exh.	1983-2002			MS15963X	1
Oil Pan Set	1992-2002		<i>Victo-Tech</i>	OS32135	1
	1983-1990		<i>Cork Rubber</i>	OS32030	1
Rear Main Seal Set	1983-2002			JV553	1
Timing Cover Set	1991-2002			JV1166	1
	1983-1990			JV878	1
Timing Cover Seal	1983-2002			46134	1

MISCELLANEOUS GASKETS

Carb. Mount Gasket	1991-1998			G31485	2
	1983-1990		1 Barrel Carburetor	G31485	2
Dist. Mounting Gasket	1983-2002			B26466	1
E.G.R. Gasket	1991-1998			G31473	1
	1983-1990			G26315	1
Exhaust Pipe Gasket	1992-1996		Catalytic Converter	F7570	1
	1983-1991		Catalytic Converter	F10076	1
Fuel Pump Gasket	1983-1996			D27094	1
Injector Nozzle O-Ring	1991-1998			GS33276	2
Throttle Body Gasket	1991-2002			G33268	1
	1986-1990			G31486	1
Water Outlet Gasket	1994-2002			C31312	1
	1983-1990			C24003	1
Water Pump Mount Gasket	1994-2002			K31313	1
	1983-1990			K27110	1

6	151 CID (2.5L) Carbureted Pontiac 4 Cyl, 4.000in./101.6mm (1980-1983)				6
----------	--	--	--	--	----------

<i>Part</i>	<i>Year</i>	<i>VIN</i>	<i>Model/Application</i>	<i>Part Number</i>	<i>Qty.</i>
ENGINE GASKETS					
Head Set	1980-1983		(Exhaust Pipe Gasket Not Included)	HS3684	1
Full Set	1980-1983		(Exhaust Pipe Gasket Not Included)	FS3684	1
Engine Kit Gasket Set	1980-1983			95-3399VR	1
Cylinder Head Gasket	1980-1983		(Standard Thickness) <i>VR2000</i>	3684	1
			Field Fix For Excessive Carbon Build Up, (Thicker Head Gasket) <i>VR2000</i>	CH3548T	1
Valve Cover Set	1980-1983		<i>Cork Rubber</i>	VS39354	1
			<i>High Temperature Tuff-Cork</i>	VS39354HTC	1
Valve Stem Seal, Exh.	1980-1983			B45229	4
Valve Stem Seal, Int.	1980-1983			B45229	4
Manifold Set, Exhaust	1980-1983			MS15303	1
Manifold Set, Intake	1980-1983			MS15304	1
Oil Pan Set	1980-1983		<i>Cork Rubber</i>	OS30539X	1
			<i>Tuff-Cork</i>	OS30539XTC	1

LIGHT TRUCK

6	151 CID (2.5L) Carbureted Pontiac 4 Cyl, 4.000in./101.6mm (1980-1983)	6
(cont.)		(cont.)

Part	Year	VIN	Model/Application	Part Number	Qty.
ENGINE GASKETS (cont.)					
Rear Main Seal Set	1980-1983			JV553	1
Timing Cover Set	1980-1983			JV883	1
			(Contains Repair Sleeve)	JV1136	1
Timing Cover Gasket	1980-1983			T27634	1
Timing Cover Seal	1980-1983			48277SF	1

MISCELLANEOUS GASKETS					
Air Cleaner Mount Gasket	1980-1983		2 Barrel Carburetor	G26672	1
Carb. Mount Gasket	1980-1983		2 Barrel Carburetor	G14147	1
E.G.R. Gasket	1980-1983			G17797	1
Exhaust Pipe Gasket	1980-1981		(Ring Type 'F'), Pipe To Manifold	F7209	1
Fuel Pump Gasket	1980-1983			D27094	1
				<i>Tuff-Cork</i> D27094TC	1
Push Rod Cover Set	1980-1983			<i>Cork Rubber</i> PS38792	1
Water Outlet Gasket	1980-1983			C24109	1
Water Pump Mount Gasket	1980-1983			K26545	1

7	173 CID (2.8L) Chevrolet V6 Cyl, 3.504in./89mm (1984-1986)	7
----------	---	----------

Part	Year	VIN	Model/Application	Part Number	Qty.
ENGINE GASKETS					
Head Set	1986		(Exhaust Pipe Gasket Not Included), Multi-Port Fuel Injection	HS3549X	1
	1984-1986		(Exhaust Pipe Gasket Not Included)	HS3549	1
Full Set	1986		(Exhaust Pipe Gasket Not Included), Multi-Port Fuel Injection	FS3549X	1
	1985-1986		(Exhaust Pipe Gasket Not Included, Externally Mounted 11mm Wide Rear Main Seal Not Included)	FS3549W	1
	1984		(Exhaust Pipe Gasket Not Included)	FS3549	1
Engine Kit Gasket Set	1985		11mm Wide Rear Main Seal, 5.5mm Wide Rear Main Seal, Second Design, (Rear Main Seal Not Included, Valve Cover Gasket Not Included, 5.5mm Rear Main Seal Not Included, Optional Oil Pan Set For Goodwrench Replacement Engine Not Included), Use With Part Numbers VS39772, JV531	95-3406VR	1
	1984		(Oil Pan Gasket Not Included, Rear Main Seal Not Included), Use With Part Numbers JV531, OS32104	95-3435VR	1
Cylinder Head Gasket	1984-1986		<i>VR2000</i>	3549	2
Valve Cover Set	1986		Multi-Port Fuel Injection	<i>Cork Rubber</i> VS50019	1
	1984-1986			<i>Cork Rubber</i> VS39772	1
Valve Stem Seal, Exh.	1984-1986		(O-Ring Type)	B45229	6
Valve Stem Seal, Int.	1984-1986		(O-Ring Type)	B45229	6
			(Positive Type)	<i>Fluoroelastomer</i> B45418	6
Manifold Set, Exhaust	1984-1986			MS15310	1
Manifold Set, Intake	1986		(Plenum Chamber Gasket Not Included), Multi-Port Fuel Injection	MS15222	1
	1984-1986			MS15307	1
Plenum Chamber Gasket	1986		Multi-Port Fuel Injection	MS14752	1
Oil Pan Set	1985-1986			<i>Cork Rubber</i> OS32025	1
	1984			<i>Cork Rubber</i> OS32104	1
Rear Main Seal Set	1986		(Externally Mounted)	<i>11mm Wide</i> JV544	1
			Multi-Port Fuel Injection	JV544	1
	1985-1986		(Externally Mounted)	<i>11mm Wide</i> JV544	1
	1984-1986		(One Piece, Smooth Shaft)	<i>5.5mm Wide</i> JV531	1
Crank Repair Sleeve	1985-1986		Use With Part Number A510, Rear <i>Nickel Plated Formed Steel, .013" Thickness</i>	A337	1
Timing Cover Set	1984-1986			JV948	1
			(Contains Repair Sleeve)	JV1131	1

Jeep

7 (cont.)	173 CID (2.8L) Chevrolet V6 Cyl, 3.504in./89mm (1984-1986)	7 (cont.)
---------------------	---	---------------------

Part	Year	VIN	Model/Application	Part Number	Qty.
ENGINE GASKETS (cont.)					
Timing Cover Gasket	1984			T27635	1
Timing Cover Seal	1984-1986		<i>3/8" Wide</i>	49328	1
			<i>(Lip Relocator Type) 1/2" Wide</i>	65022	1
Harmonic Balancer Repair Sleeve	1984-1986		Use With Part Number A504 <i>Nickel Plated Formed Steel, .013" Thickness</i>	A228-1	1

MISCELLANEOUS GASKETS

Air Cleaner Mount Gasket	1984-1985		2 Barrel Carburetor	G26672	1
Cam. Cover Gasket	1984-1986			H36978	1
Carb. Mount Gasket	1984		2 Barrel Carburetor	G26773	1
Dist. Mounting Gasket	1984-1986			B25934	1
E.G.R. Gasket	1984-1986			G17797	1
Exhaust Pipe Gasket	1986		Multi-Port Fuel Injection, Pipe To Manifold	F7210	1
	1984-1986		Catalytic Converter	F10076	1
	1984		Pipe To Manifold	F7210	1
Fuel Pump Gasket	1984-1986			D27228	1
Oil Pan Drain Plug Gst.	1984-1986			2051	1
Throttle Body Gasket	1986		Multi-Port Fuel Injection	G30949	1
Water Outlet Gasket	1986		Multi-Port Fuel Injection	C24118	1
				C25930	1
	1984-1985			C24118	1
Water Pump Mount Gasket	1984-1986			K24689	1

8	225 CID (3.7L) Buick V6 Cyl, 3.750in./95.3mm (1966-1971)	8
----------	---	----------

Part	Year	VIN	Model/Application	Part Number	Qty.
ENGINE GASKETS					
Head Set	1966-1971			HS1193VC	1
Full Set	1966-1971			FS1193VE	1
Cylinder Head Gasket	1966-1971		<i>VR2000</i>	5820	2
Valve Cover Set	1966-1971		<i>Cork Rubber</i>	VS38303	1
Manifold Set, Exhaust	1966-1971			MS15214	1
Manifold Set, Intake	1966-1971			MS15123	1
Oil Pan Set	1966-1971		<i>Cork Rubber</i>	OS30668	1
Rear Main Seal Set	1966-1971		<i>Rope Packing</i>	JV742	1
			<i>Molded Rubber</i>	JV742R	1
Timing Cover Set	1966-1971		<i>Rope Packing</i>	JV844	1
			<i>(Superflex)</i>	JV1052SF	1
Timing Cover Gasket	1966-1971			T27960	1

MISCELLANEOUS GASKETS

Dist. Mounting Gasket	1966-1971			72215	1
Fuel Pump Gasket	1966-1971			D27094	1
Heat Riser Gasket	1966			F5421K	4
Oil Pan Drain Plug Gst.	1966-1971			2051	1
Water Outlet Gasket	1966-1971			C26515	1
Water Pump Mount Gasket	1966-1971			K27571	1

9	226 CID (3.7L) Continental 6 Cyl, 3.313in./84.1mm (1947-1965)	9
----------	--	----------

Part	Year	VIN	Model/Application	Part Number	Qty.
ENGINE GASKETS					
Head Set	1947-1965			HS986SY	1
Full Set	1963-1964			FS986SW	1

9 226 CID (3.7L) Continental 6 Cyl, 3.313in./84.1mm (1947-1965) **9**
(cont.) (cont.)

Part	Year	VIN	Model/Application	Part Number	Qty.
ENGINE GASKETS (cont.)					
Full Set (cont.)	1962		2 Wheel Drive, From Serial Number SW6L16848	FS986SW	1
			4 Wheel Drive, From Serial Number TW6L143634	FS986SW	1
			2 Wheel Drive, Thru Serial Number SW6L16847	FS986SY	1
			4 Wheel Drive, Thru Serial Number TW6L143633	FS986SY	1
	1947-1961			FS986SY	1
Cylinder Head Gasket	1947-1965			986S	1
Valve Cover Set	1947-1965		Cork Rubber	VS38063	1
Manifold Set, Int. & Exh.	1947-1965			MS18651S	1
Oil Pan Set	1963-1964		Cork Rubber	OS20928	1
	1962		2 Wheel Drive, Thru Serial Number SW6L16847	Cork Rubber	OS20927
			4 Wheel Drive, Thru Serial Number TW6L143633		
			2 Wheel Drive, From Serial Number SW6L16848	Cork Rubber	OS20928
			4 Wheel Drive, From Serial Number TW6L143634		
	1947-1961		Cork Rubber	OS20927	1
	Rear Main Seal Set	1963-1964			JV734
1962			2 Wheel Drive, Thru Serial Number SW6L16847	JV663	1
			4 Wheel Drive, Thru Serial Number TW6L143633	JV663	1
			2 Wheel Drive, From Serial Number SW6L16848	JV734	1
			4 Wheel Drive, From Serial Number TW6L143634	JV734	1
1947-1961			JV663	1	
Timing Cover Set	1947-1965			JV768	1
Timing Cover Seal	1947-1965			49575	1

MISCELLANEOUS GASKETS

Carb. Mount Gasket	1954-1961		1 Barrel Carburetor	G7117	1
Exhaust Pipe Gasket	1947-1965		Pipe To Manifold	F5438AK	1
Fuel Pump Gasket	1947-1965			D27094	1

10 226 CID/3701CC (3.7L) EKG SOHC 12 Valve Chrysler V6 Cyl, 3.661in./93mm (2002-2003) **10**

Part	Year	VIN	Model/Application	Part Number	Qty.
ENGINE GASKETS					
Head Set	2002-2003			HS54250	1
Lower Set	2002-2003		(Requires Head Set To Make Full Set)	CS54250	1
Cylinder Head Gasket	2002-2003		Multi-Layered Steel	54250	2
Valve Cover Set	2002-2003			VS50325	1
Valve Stem Seal, Exh.	2002-2003			B45909A	6
Valve Stem Seal, Int.	2002-2003			B45909A	6
Manifold Set, Exhaust	2002-2003			MS16349	1
Manifold Set, Intake	2002-2003			MS16353	1
Oil Pan Set	2002-2003			OS32234	1
Rear Main Seal	2002-2003			67632	1
Timing Cover Seal	2002-2003			67629	1
MISCELLANEOUS GASKETS					
Throttle Body Gasket	2002-2003			G31637	1
Water Pump Mount Gasket	2002-2003			K31598	1

11 230 CID (3.8L) Tornado 6 Cyl, 3.344in./84.9mm (1962-1968) **11**

Part	Year	VIN	Model/Application	Part Number	Qty.
ENGINE GASKETS					
Cylinder Head Gasket	1962-1968		Beaded Steel	3844BS	1

Jeep

11	230 CID (3.8L) Tornado 6 Cyl, 3.344in./84.9mm (1962-1968)	11
(cont.)		(cont.)

Part	Year	VIN	Model/Application	Part Number	Qty.
ENGINE GASKETS (cont.)					
Valve Cover Set	1962-1968		<i>Victo-Tech</i>	VS26587	1
Oil Pan Set	1962-1968		<i>Cork Rubber</i>	OS20927	1
Rear Main Seal Set	1962-1968			JV734	1
Timing Cover Set	1962-1968			JV839	1
Timing Cover Seal	1962-1968			49024	1

MISCELLANEOUS GASKETS					
Exhaust Pipe Gasket	1962-1968		Pipe To Manifold	F5438AK	1
Fuel Pump Gasket	1962-1968			D27094	1

12	232 CID (3.8L) American Motors Co. 6 Cyl, 3.750in./95.3mm (1965-1978)	12
-----------	--	-----------

Part	Year	VIN	Model/Application	Part Number	Qty.
ENGINE GASKETS					
Head Set	1965-1978		(Exhaust Pipe Gasket Not Included)	HS1199VC	1
Full Set	1965-1978		(Exhaust Pipe Gasket Not Included)	FS1199VC	1
Engine Kit Gasket Set	1965-1978			95-3020VR	1
Cylinder Head Gasket	1965-1978		<i>VR2000</i>	1199	1
Valve Cover Set	1965-1978		<i>Cork Rubber</i>	VS39695	1
			<i>High Temperature Cork Rubber</i>	VS39695H	1
Valve Stem Seal, Exh.	1965-1978			B45323	6
Valve Stem Seal, Int.	1965-1978			B45323	6
Manifold Set, Int. & Exh.	1965-1978			MS15510	1
Oil Pan Set	1965-1978		<i>Cork Rubber</i>	OS30990	1
Rear Main Seal Set	1965-1978			JV1611	1
Timing Cover Set	1965-1978			JV878	1
			(Contains Repair Sleeve)	JV1130	1
Timing Cover Seal	1965-1978			46134	1
Harmonic Balancer Repair Sleeve	1965-1978		Use With Part Number A504 <i>Nickel Plated Formed Steel, .013" Thickness</i>	A221	1

MISCELLANEOUS GASKETS					
Air Cleaner Mount Gasket	1974-1978		2 Barrel Carburetor	G25936	1
	1965-1978		1 Barrel Carburetor	G26540	1
Carb. Mount Gasket	1965-1978		1 Barrel Carburetor	G26639	2
E.G.R. Gasket	1973-1978			G26315	1
Exhaust Pipe Gasket	1975-1978		Catalytic Converter	F10076	1
	1965-1978		(Ring Type 'D'), Pipe To Manifold	F7171	1
	1965-1970		Catalytic Converter	F10076	1
Fuel Pump Gasket	1965-1978			D27094	1
			<i>Tuff-Cork</i>	D27094TC	1
Water Outlet Gasket	1968-1978			C24003	1
	1965-1967			C26618	1
Water Pump Mount Gasket	1965-1978			K27110	1

13	242 CID (4.0L) 6 Cyl, 3.875in./98.4mm (1986-2003)	13
-----------	--	-----------

Part	Year	VIN	Model/Application	Part Number	Qty.
ENGINE GASKETS					
Head Set	1999-2001			HS5713A	1
	1996-1998			HS5713Z	1
	1994-1995		(Exhaust Pipe Gasket Not Included)	HS5713Y	1
	1991-1993		(Exhaust Pipe Gasket Not Included)	HS5713X	1
	1986-1990			HS5713	1
Lower Set	2000-2001		(Requires Head Set To Make Full Set)	CS5713A	1
	1999		Grand Cherokee, (Requires Head Set To Make Full Set)	CS5713A	1

LIGHT TRUCK

Part	Year	VIN	Model/Application	Part Number	Qty.
ENGINE GASKETS (cont.)					
Lower Set (cont.)	1999		Cherokee, Wrangler, (Requires Head Set To Make Full Set)	CS5713X	1
	1992-1998		(Requires Head Set To Make Full Set)	CS5713X	1
	1991		(Requires Head Set To Make Full Set)	CS5713	1
Full Set	1986-1990			FS5713	1
Engine Kit Gasket Set	1996-1998		(Valve Cover Gasket Not Included), Use With Part Number VS50266	95-3480VR	1
	1994-1995			95-3480VR	1
	1992-1993			95-3499VR	1
	1987-1991			95-3232VR	1
Cylinder Head Gasket	1986-2003		<i>Nitroseal</i>	5713	1
			<i>Multi-Layered Steel</i>	54249	1
Valve Cover Set	1996-2003		<i>Victo-Tech</i>	VS50266	1
	1986-1995		<i>Cork Rubber</i>	VS50060	1
Valve Stem Seal, Exh.	1994-2003			B45799	6
	1986-1993			B45411	6
Valve Stem Seal, Int.	1994-2003			B45798	6
	1986-1993			B45410	6
Manifold Set, Int. & Exh.	1999-2003		<i>Multi-Layered Steel</i>	MS16315	1
	1991-1998			MS16120	1
	1986-1990			MS16053	1
Oil Pan Set	1992-2001		<i>Victo-Tech</i>	OS32118	1
	1986-1991		<i>Cork Rubber</i>	OS30990	1
Rear Main Seal Set	2000-2001			JV1658	1
	1999		Cherokee, Wrangler	JV1611	1
				Grand Cherokee	JV1658
Timing Cover Set	1986-1998			JV1611	1
	1992-2003			JV1166	1
				(Contains Repair Sleeve)	JV1130
	1986-1991			JV878	1
Timing Cover Seal	1986-2003			46134	1
Harmonic Balancer Repair Sleeve	1986-1991		Use With Part Number A504 <i>Nickel Plated Formed Steel, .013" Thickness</i>	A221	1
MISCELLANEOUS GASKETS					
E.G.R. Gasket	1986-1990			G26315	1
Exhaust Pipe Gasket	1991-1998		Pipe To Manifold	F7549	1
	1992-1996		Cherokee, Catalytic Converter	F7570	1
	1992-1993		Wrangler, Catalytic Converter	F7570	1
	1991-1992		Comanche, Catalytic Converter	F7570	1
	1986-1990		Catalytic Converter	F10076	1
Fuel Pump Gasket	1986-1990			D27094	1
				<i>Tuff-Cork</i>	D27094TC
Injector Nozzle O-Ring	1991-1998			GS33276	3
Oil Filter Adapt Gasket	1991-2001		Cherokee, (O-Ring Type)	72230	1
	1993-1998		Grand Cherokee, (O-Ring Type)	72230	1
	1991-1992		Comanche, (O-Ring Type)	72230	1
Throttle Body Gasket	1991-2003		Throttle Body To Intake Manifold	G33268	1
	1986-1990		Throttle Body To Intake Manifold	G31510	1
Water Outlet Gasket	1997-2003			C31312	1
	1994-2003		Grand Cherokee	C31312	1
	1994-1996		Cherokee	C24003	1
	1986-1996			C24003	1
	1994-1995		Wrangler	C31312	1
Water Pump Gasket	1987-1991			K27110	1
Water Pump Mount Gasket	1992-2003			K31313	1
	1986-1991			K27110	1

Part	Year	VIN	Model/Application	Part Number	Qty.
ENGINE GASKETS					
Head Set	1986-1990		(Exhaust Pipe Gasket Not Included, Aluminum Cover Gasket Not Included)	HS1199W	1
	1981-1985		Except Engine Build Code Stamped On Right Side Of Block with 4th Digit M, (Exhaust Pipe Gasket Not Included)	HS3957	1
	1971-1980		(Exhaust Pipe Gasket Not Included)	HS1199VC	1
Full Set	1986-1990		(Exhaust Pipe Gasket Not Included, Aluminum Cover Gasket Not Included)	FS1199W	1
	1981-1985		Except Engine Build Code Stamped On Right Side Of Block with 4th Digit M, (Exhaust Pipe Gasket Not Included)	FS3957	1
	1971-1980		(Exhaust Pipe Gasket Not Included)	FS1199VC	1
Engine Kit Gasket Set	1986-1990		Plastic Valve Cover	95-3100VR	1
			Aluminum Valve Cover	95-3342VR	1
	1981-1985		Except Engine Build Code Stamped On Right Side Of Block with 4th Digit M, Use With Part Number VS50061	95-3437VR	1
	1971-1980			95-3020VR	1
Cylinder Head Gasket	1986-1990		VR2000	1199	1
	1981-1985		Except Engine Build Code Stamped On Right Side Of Block with 4th Digit M VR2000	3957	1
	1971-1980		VR2000	1199	1
Valve Cover Set	1989-1990		Tuff-Cork	VS50000TC	1
	1987-1990		Except Type II Aluminum Valve Cover Tuff-Cork	VS50000TC	1
			Type II Aluminum Valve Cover Cork Rubber	VS50060	1
			Except Type II Aluminum Valve Cover Cork Rubber	VS50061	1
	1986		Tuff-Cork	VS50000TC	1
			Cork Rubber	VS50061	1
	1981-1985		Except Engine Build Code Stamped On Right Side Of Block with 4th Digit M Tuff-Cork	VS50000TC	1
			Except Engine Build Code Stamped On Right Side Of Block with 4th Digit M Cork Rubber	VS50061	1
1971-1980		Cork Rubber	VS39695	1	
		High Temperature Cork Rubber	VS39695H	1	
Valve Stem Seal, Exh.	1971-1990			B45323	6
Valve Stem Seal, Int.	1971-1990			B45323	6
Manifold Set, Int. & Exh.	1975-1990			MS15510	1
	1981-1985		Except Engine Build Code Stamped On Right Side Of Block with 4th Digit M	MS15510	1
	1971-1980			MS15510	1
Oil Pan Set	1986-1990		Cork Rubber	OS30990	1
	1971-1990		(One Piece) Victo-Tech	OS32118	1
	1981-1985		Except Engine Build Code Stamped On Right Side Of Block with 4th Digit M Cork Rubber	OS30990	1
	1971-1980		Cork Rubber	OS30990	1
Rear Main Seal Set	1986-1990			JV1611	1
	1981-1985		Except Engine Build Code Stamped On Right Side Of Block with 4th Digit M	JV1611	1
	1971-1980			JV1611	1
Timing Cover Set	1986-1990			JV878	1
			(Contains Repair Sleeve)	JV1130	1
	1981-1985		Except Engine Build Code Stamped On Right Side Of Block with 4th Digit M	JV878	1
			Except Engine Build Code Stamped On Right Side Of Block with 4th Digit M, (Contains Repair Sleeve)	JV1130	1
	1971-1980			JV878	1
		(Contains Repair Sleeve)	JV1130	1	
Timing Cover Seal	1986-1990			46134	1
	1981-1985		Except Engine Build Code Stamped On Right Side Of Block with 4th Digit M	46134	1
	1971-1980			46134	1
Harmonic Balancer Repair Sleeve	1971-1990		Use With Part Number A504 Nickel Plated Formed Steel, .013" Thickness	A221	1

14 258 CID (4.2L) American Motors Co. 6 Cyl, 3.750in./95.3mm (1971-1990) **14**
(cont.) (cont.)

Part	Year	VIN	Model/Application	Part Number	Qty.
MISCELLANEOUS GASKETS					
Air Cleaner Mount Gasket	1986-1989		2 Barrel Carburetor	G25936	1
	1981-1985		Except Engine Build Code Stamped On Right Side Of Block with 4th Digit M, 2 Barrel Carburetor	G25936	1
	1974-1980		2 Barrel Carburetor	G25936	1
	1971-1978		1 Barrel Carburetor	G26540	1
Carb. Mount Gasket	1986-1989		2 Barrel Carburetor	G26827	2
	1981-1985		Except Engine Build Code Stamped On Right Side Of Block with 4th Digit M, 2 Barrel Carburetor	G26827	2
	1979-1980		2 Barrel Carburetor	G26827	2
	1971-1978		1 Barrel Carburetor	G26639	2
E.G.R. Gasket	1986-1989			G26315	1
	1981-1985		Except Engine Build Code Stamped On Right Side Of Block with 4th Digit M	G26315	1
	1973-1980			G26315	1
Exhaust Pipe Gasket	1986-1990		(Flange Type), Catalytic Converter	F10076	1
	1981-1985		Except Engine Build Code Stamped On Right Side Of Block with 4th Digit M, (Ring Type 'D'), Pipe To Manifold	F7171	1
			Except Engine Build Code Stamped On Right Side Of Block with 4th Digit M, (Flange Type), Catalytic Converter	F10076	1
	1975-1980		(Flange Type), Catalytic Converter	F10076	1
	1971-1980		(Ring Type 'D'), Pipe To Manifold	F7171	1
Fuel Pump Gasket	1986-1990			D27094	1
			<i>Tuff-Cork</i>	D27094TC	1
	1981-1985		Except Engine Build Code Stamped On Right Side Of Block with 4th Digit M	D27094	1
			Except Engine Build Code Stamped On Right Side Of Block with 4th Digit M <i>Tuff-Cork</i>	D27094TC	1
	1971-1980			D27094	1
			<i>Tuff-Cork</i>	D27094TC	1
Water Outlet Gasket	1986-1990			C24003	1
	1981-1985		Except Engine Build Code Stamped On Right Side Of Block with 4th Digit M	C24003	1
	1971-1980			C24003	1
Water Pump Mount Gasket	1975-1990			K27110	1
	1981-1985		Except Engine Build Code Stamped On Right Side Of Block with 4th Digit M	K27110	1
	1971-1980			K27110	1

15 287 CID (4.7L) SOHC Chrysler V8 Cyl, 3.661in./93mm (1999-2003) **15**

Part	Year	VIN	Model/Application	Part Number	Qty.
ENGINE GASKETS					
Head Set	1999-2002			HS54237	1
Lower Set	1999-2002		(Requires Head Set To Make Full Set)	CS54237	1
Cylinder Head Gasket	1999-2003		<i>Multi-Layered Steel</i>	54237	2
Cyl. Head Bolt Set	1999-2003			GS33368	2
Valve Cover Set	1999-2003			VS50308	1
Valve Stem Seal, Exh.	1999-2003			B45909	8
Valve Stem Seal, Int.	1999-2003			B45909	8
Manifold Set, Exhaust	1999-2002			MS16336	1
Manifold Set, Intake	1999-2002			MS16323	1
Oil Pan Set	1999-2002			OS32233	1
Rear Main Seal	1999-2003			67632	1
Timing Cover Gasket	2003		Engines With Chamfered Timing Cover Surface	T31616	1
	1999-2002			T31616	1
Timing Cover Seal	1999-2003			67629	1

Jeep

15 (cont.)	287 CID (4.7L) SOHC Chrysler V8 Cyl, 3.661in./93mm (1999-2003)				15 (cont.)
----------------------	---	--	--	--	----------------------

Part	Year	VIN	Model/Application	Part Number	Qty.
MISCELLANEOUS GASKETS					
Throttle Body Gasket	1999-2003			G31597	1
Water Pump Mount Gasket	1999-2003			K31598	1

16	304 CID (5.0L) American Motors Co. V8 Cyl, 3.750in./95.3mm (1971-1981)				16
-----------	---	--	--	--	-----------

Part	Year	VIN	Model/Application	Part Number	Qty.
ENGINE GASKETS					
Head Set	1971-1981		(Exhaust Pipe Gasket Not Included, Intake Manifold Gasket Not Included)	HS3484VC	1
Full Set	1971-1981		(Exhaust Pipe Gasket Not Included, Intake Manifold Gasket Not Included)	FS3484VC	1
Engine Kit Gasket Set	1971-1981		(Intake Manifold Gasket Not Included), Use With Part Number MS15922	95-3340VR	1
Cylinder Head Gasket	1971-1981		<i>VR2000</i>	3484VC	2
Valve Cover Set	1971-1981		<i>Cork Rubber</i>	VS28317	1
Valve Stem Seal, Exh.	1971-1981			B45298	8
Valve Stem Seal, Int.	1971-1981			B45298	8
Manifold Set, Exhaust	1971-1981			MS14143	1
Manifold Set, Intake	1971-1981			MS15922	1
Oil Pan Set	1971-1981		<i>Cork Rubber</i>	OS30538	1
			<i>Tuff-Cork</i>	OS30538TC	1
Rear Main Seal Set	1971-1981			JV638	1
Timing Cover Set	1971-1981		(Repair Sleeve Not Included)	JV870	1
			(Contains Repair Sleeve)	JV928	1
Timing Cover Seal	1971-1981			46483	1
Harmonic Balancer Repair Sleeve	1971-1981		<i>Ground Steel, .020" Thickness</i>	66590RS	1
			Use With Part Number A500 <i>Nickel Plated Formed Steel, .013" Thickness</i>	A222	1

Part	Year	VIN	Model/Application	Part Number	Qty.
MISCELLANEOUS GASKETS					
Air Cleaner Mount Gasket	1971-1981		2 Barrel Carburetor	G27098	1
Carb. Mount Gasket	1974-1981		2 Barrel Carburetor, Insulator To Manifold	G26043	1
			2 Barrel Carburetor, Carburetor To Insulator	G26044	1
	1971-1972		2 Barrel Carburetor, Carburetor To Insulator	G26043	1
Choke Tube Gasket	1973-1981			B45780	1
E.G.R. Gasket	1973-1981			G26315	1
Exhaust Pipe Gasket	1975-1981		(Flange Type), Catalytic Converter	F10076	1
	1971-1981		(Ring Type 'B'), Pipe To Manifold	F7201	2
Fuel Pump Gasket	1971-1981			D27094	1
			<i>Tuff-Cork</i>	D27094TC	1
Water Outlet Gasket	1971-1981			C24111	1
Water Pump Mount Gasket	1971-1981			K14740	1

17	318 CID (5.2L) Chrysler V8 Cyl, 3.910in./99.3mm (1993-1998)				17
-----------	--	--	--	--	-----------

Part	Year	VIN	Model/Application	Part Number	Qty.
ENGINE GASKETS					
Head Set	1997-1998			HS5940A	1
	1993-1996			HS5940	1
Lower Set	1993-1998		(Requires Head Set To Make Full Set)	CS5928	1
Cyl. Head Bolt Set	1993-1998			GS33375	2
Valve Cover Set	1993-1998		(Original Equipment Style Shimmed Molded Rubber) <i>Victo-Tech</i>	VS50170	1
Valve Stem Seal, Exh.	1993-1998		<i>Fluoroelastomer</i>	B45799A	8
Valve Stem Seal, Int.	1993-1998		<i>Fluoroelastomer</i>	B45798A	8

LIGHT TRUCK

17 318 CID (5.2L) Chrysler V8 Cyl, 3.910in./99.3mm (1993-1998) **17**
(cont.) (cont.)

Part	Year	VIN	Model/Application	Part Number	Qty.
ENGINE GASKETS (cont.)					
Manifold Set, Exhaust	1993-1998			MS16209	1
Manifold Set, Intake	1997-1998		(Contains Steel Carrier End Seal)	MS16292	1
	1993-1998			MS16089	1
Oil Pan Set	1993-1998		<i>Victo-Tech</i>	OS32114	1
Rear Main Seal Set	1993-1998			JV1607	1
Timing Cover Set	1993-1998			JV1158	1

MISCELLANEOUS GASKETS					
Air Cleaner Mount Gasket	1993			G31043	1
Air Pump Gasket	1993		Air Injection Tube	B45559	1
Distributor Seal	1993-1998		(O-Ring Type), Shaft	72133	1
Injector Nozzle O-Ring	1993-1998			GS33276	4
Oil Filter Adapt Gasket	1993-1998			B31605	1
Throttle Body Gasket	1993-1998		Throttle Body To Intake Manifold	G31527	1
Water Outlet Gasket	1993-1998			C24672	1
Water Pump Mount Gasket	1993-1998			K31140	1

18 327 CID (5.4L) V8 Cyl, 4.000in./101.6mm (1965-1968) **18**

Part	Year	VIN	Model/Application	Part Number	Qty.
ENGINE GASKETS					
Head Set	1965-1968		(Head Bolts Not Included, Exhaust Pipe Gasket Not Included)	HS1137VX	1
Full Set	1965-1968		(Exhaust Pipe Gasket Not Included)	FS1137BX	1
Cylinder Head Gasket	1965-1968		<i>VR2000</i>	1137VC	2
Valve Cover Set	1965-1968		<i>Victo-Tech</i>	VS27546	1
Manifold Set, Intake	1965-1968			MS15054	1
Oil Pan Set	1965-1968		<i>Cork Rubber</i>	OS30569	1
Rear Main Seal Set	1965-1968			JV696	1
Timing Cover Set	1965-1968			JV796	1
Timing Cover Seal	1965-1968			46019	1

MISCELLANEOUS GASKETS					
Carb. Mount Gasket	1965-1968		4 Barrel Carburetor	G14560	2
Exhaust Pipe Gasket	1965-1968		(Flange Type), Pipe To Manifold, Right	F5360C	1
			(Flange Type), Left, Pipe To Manifold	F5438AK	1
Fuel Pump Gasket	1965-1968			D27094	1
Heat Riser Gasket	1966-1968			F5360C	1
Push Rod Cover Set	1965-1968			PS38754	1
Water Outlet Gasket	1965-1968		Manifold To Block	C24110	2
				C25487	1

19 350 CID (5.7L) Buick V8 Cyl, 3.800in./96.5mm (1968-1971) **19**

Part	Year	VIN	Model/Application	Part Number	Qty.
ENGINE GASKETS					
Head Set	1968-1971		(Head Bolts Not Included, Intake Manifold Gasket Not Included)	HS3899VE	1
Full Set	1968-1971		(Head Bolts Not Included, Intake Manifold Gasket Not Included)	FS3899VE	1
Engine Kit Gasket Set	1968-1971		(Intake Manifold Gasket Not Included), Use With Part Number MS15931	95-3008VR	1
Cylinder Head Gasket	1968-1971		<i>VR2000</i>	3899	2
Valve Cover Set	1968-1971		<i>Cork Rubber</i>	VS38320	1
Valve Stem Seal, Exh.	1968-1971		<i>Nitrile</i>	B45403	8
Valve Stem Seal, Int.	1968-1971		<i>Nitrile</i>	B45403	8
Manifold Set, Exhaust	1968-1971			MS15201	1

Jeep

19 <small>(cont.)</small>	350 CID (5.7L) Buick V8 Cyl, 3.800in./96.5mm (1968-1971)	19 <small>(cont.)</small>
-------------------------------------	---	-------------------------------------

Part	Year	VIN	Model/Application	Part Number	Qty.
ENGINE GASKETS (cont.)					
Manifold Set, Intake	1968-1971			MS15931	1
Oil Pan Set	1968-1971		<i>Cork Rubber</i>	OS30669	1
Rear Main Seal Set	1968-1971			JV742	1
Timing Cover Set	1968-1971			JV860	1
Timing Cover Gasket	1968-1971			T27960	1

MISCELLANEOUS GASKETS					
Air Cleaner Mount Gasket	1968-1971		2 Barrel Carburetor	G25936	1
			4 Barrel Carburetor	G27098	1
Carb. Mount Gasket	1970-1971		2 Barrel Carburetor	G25452	1
	1968-1969		2 Barrel Carburetor	G7374	1
Dist. Mounting Gasket	1968-1971			72215	1
Fuel Pump Gasket	1968-1971			D27094	1
Oil Pan Drain Plug Gst.	1968-1971			2051	1
Water Outlet Gasket	1968-1971			C26515	1
Water Pump Mount Gasket	1968-1971			K27571	1

20	360 CID (5.9L) American Motors Co. V8 Cyl, 4.080in./103.6mm (1971-1991)	20
-----------	--	-----------

Part	Year	VIN	Model/Application	Part Number	Qty.
ENGINE GASKETS					
Head Set	1971-1991		(Exhaust Pipe Gasket Not Included, Intake Manifold Gasket Not Included)	HS3467	1
Full Set	1971-1991		(Exhaust Pipe Gasket Not Included, Intake Manifold Gasket Not Included)	FS3467	1
Engine Kit Gasket Set	1971-1991		(Intake Manifold Gasket Not Included), Use With Part Number MS15922	95-3339VR	1
Cylinder Head Gasket	1971-1991		<i>VR2000</i>	3467	2
Valve Cover Set	1971-1991		<i>Cork Rubber</i>	VS28317	1
Valve Stem Seal, Exh.	1971-1991			B45298	8
Valve Stem Seal, Int.	1971-1991			B45298	8
Manifold Set, Exhaust	1971-1991			MS14143	1
Manifold Set, Intake	1971-1991			MS15922	1
Oil Pan Set	1971-1991		<i>Cork Rubber</i>	OS30538	1
			<i>Tuff-Cork</i>	OS30538TC	1
Rear Main Seal Set	1971-1991			JV638	1
Timing Cover Set	1971-1991		(Repair Sleeve Not Included)	JV870	1
			(Contains Repair Sleeve)	JV928	1
Timing Cover Seal	1971-1991			46483	1
Harmonic Balancer Repair Sleeve	1971-1991		<i>Ground Steel, .020" Thickness</i>	66590RS	1
			<i>Nickel Plated Formed Steel, .013" Thickness</i>	A222	1

MISCELLANEOUS GASKETS					
Air Cleaner Mount Gasket	1989		2 Barrel Carburetor	G27098	1
	1984-1988			G27098	1
	1971-1988		2 Barrel Carburetor	G27098	1
Carb. Mount Gasket	1989		2 Barrel Carburetor, Insulator To Manifold	G26043	1
			2 Barrel Carburetor, Carburetor To Insulator	G26044	1
	1984-1988		Insulator To Manifold	G26043	1
			Carburetor To Insulator	G26044	1
	1974-1988		2 Barrel Carburetor, Insulator To Manifold	G26043	1
			2 Barrel Carburetor, Carburetor To Insulator	G26044	1
	1975-1978		4 Barrel Carburetor, Insulator To Manifold	G25504	1
1971-1972		2 Barrel Carburetor, Carburetor To Insulator	G26043	1	

LIGHT TRUCK

20 360 CID (5.9L) American Motors Co. V8 Cyl, 4.080in./103.6mm (1971-1991) **20**
(cont.) (cont.)

Part	Year	VIN	Model/Application	Part Number	Qty.
MISCELLANEOUS GASKETS (cont.)					
Choke Tube Gasket	1973-1991			B45780	1
E.G.R. Gasket	1973-1989			G26315	1
Exhaust Pipe Gasket	1971-1991		(Ring Type 'B'), Pipe To Manifold	F7201	2
	1984-1987			F7201	1
	1975-1987		(Flange Type), Catalytic Converter	F10076	1
Fuel Pump Gasket	1971-1991			D27094	1
				Tuff-Cork	D27094TC
Water Outlet Gasket	1971-1991			C24111	1
Water Pump Mount Gasket	1971-1991			K14740	1

21 360 CID (5.9L) Chrysler V8 Cyl, 4.000in./101.6mm (1998) **21**

Part	Year	VIN	Model/Application	Part Number	Qty.
ENGINE GASKETS					
Head Set	1998			HS5940A	1
Lower Set	1998		(Requires Head Set To Make Full Set)	CS5940	1
Engine Kit Gasket Set	1998			95-3481VR	1
Cylinder Head Gasket	1998		Nitroseal	5940	2
Cyl. Head Bolt Set	1998			GS33375	2
Valve Cover Set	1998		Victo-Tech	VS50170	1
Valve Stem Seal, Exh.	1998		Fluoroelastomer	B45799A	8
Valve Stem Seal, Int.	1998		Fluoroelastomer	B45798A	8
Manifold Set, Exhaust	1998			MS16209	1
Manifold Set, Intake	1998		(Contains Steel Carrier End Seal)	MS16292	1
Oil Pan Set	1998		Victo-Tech	OS32115	1
Rear Main Seal Set	1998			JV1610	1
Timing Cover Set	1998			JV1158	1

MISCELLANEOUS GASKETS					
Distributor Seal	1998		(O-Ring Type), Shaft	72133	1
Injector Nozzle O-Ring	1998			GS33276	4
Oil Filter Adapt Gasket	1998			B31605	1
Throttle Body Gasket	1998		Throttle Body To Intake Manifold	G31527	1
Water Outlet Gasket	1998			C24672	1
Water Pump Mount Gasket	1998			K31140	1

22 401 CID (6.6L) American Motors Co. V8 Cyl, 4.165in./105.8mm (1973-1978) **22**

Part	Year	VIN	Model/Application	Part Number	Qty.	
ENGINE GASKETS						
Head Set	1973-1978		(Exhaust Pipe Gasket Not Included, Intake Manifold Gasket Not Included)	HS3467	1	
Full Set	1973-1978		(Exhaust Pipe Gasket Not Included, Intake Manifold Gasket Not Included)	FS3467	1	
Engine Kit Gasket Set	1974-1978		(Intake Manifold Gasket Not Included), Use With Part Number MS15922	95-3339VR	1	
Cylinder Head Gasket	1973-1978		VR2000	3467	2	
Valve Cover Set	1973-1978		Cork Rubber	VS28317	1	
Valve Stem Seal, Exh.	1973-1978			B45298	8	
Valve Stem Seal, Int.	1973-1978			B45298	8	
Manifold Set, Exhaust	1973-1978			MS14143	1	
Manifold Set, Intake	1973-1978			MS15922	1	
Oil Pan Set	1973-1978			Cork Rubber	OS30538	1
				Tuff-Cork	OS30538TC	1
Rear Main Seal Set	1973-1978			JV638	1	
Timing Cover Set	1973-1978		(Repair Sleeve Not Included)	JV870	1	
			(Contains Repair Sleeve)	JV928	1	

Jeep

22 (cont.)	401 CID (6.6L) American Motors Co. V8 Cyl, 4.165in./105.8mm (1973-1978)				22 (cont.)
----------------------	--	--	--	--	----------------------

Part	Year	VIN	Model/Application	Part Number	Qty.
------	------	-----	-------------------	-------------	------

ENGINE GASKETS (cont.)

Timing Cover Seal	1973-1978			46483	1
Harmonic Balancer Repair Sleeve	1973-1978		Ground Steel, .020" Thickness	66590RS	1
			Use With Part Number A500 Nickel Plated Formed Steel, .013" Thickness	A222	1

MISCELLANEOUS GASKETS

Air Cleaner Mount Gasket	1973-1978			G27098	1
Carb. Mount Gasket	1975-1976		4 Barrel Carburetor, Insulator To Manifold	G25504	1
	1973-1974		4 Barrel Carburetor, Insulator To Manifold	G25503	1
Choke Tube Gasket	1973-1978			B45780	1
E.G.R. Gasket	1973-1976			G26315	1
Exhaust Pipe Gasket	1975-1978		(Flange Type), Catalytic Converter	F10076	1
	1973-1978		(Ring Type 'B'), Pipe To Manifold	F7201	2
Fuel Pump Gasket	1973-1978			D27094	1
			Tuff-Cork	D27094TC	1
Water Outlet Gasket	1973-1978			C24111	1
Water Pump Mount Gasket	1973-1978			K14740	1

Kia Truck

Engine Index

Engine	Year	Block
1998CC (2.0L) DOHC 16 Valve Kia	1995-1998	1
1998CC (2.0L) SOHC Kia	1995	2

Model Index

Model	Engine	Year	Block	Model	Engine	Year	Block
Sportage	1998CC (2.0L) DOHC 16 Valve Kia	1995-2002	1	Sportage	1998CC (2.0L) SOHC Kia	1995	2

1	1998CC (2.0L) DOHC 16 Valve Kia 4 Cyl, 3.390in./86.11mm (1995-1998)				1
----------	--	--	--	--	----------

Part	Year	VIN	Model/Application	Part Number	Qty.
------	------	-----	-------------------	-------------	------

ENGINE GASKETS

Valve Cover Set	1995-1998			VS50307	1
-----------------	-----------	--	--	---------	---

2	1998CC (2.0L) SOHC Kia 4 Cyl, 3.390in./86.11mm (1995)				2
----------	--	--	--	--	----------

Part	Year	VIN	Model/Application	Part Number	Qty.
------	------	-----	-------------------	-------------	------

ENGINE GASKETS

Valve Cover Set	1995			VS18027	1
-----------------	------	--	--	---------	---

Lexus Truck

Engine Index

Engine	Year	Block
2995CC (3.0L) 1MZFE DOHC Toyota	1999-2003	1

Model Index

Model	Engine	Year	Block
RX300	2995CC (3.0L) 1MZFE DOHC Toyota	1999-2003	1

1	2995CC (3.0L) 1MZFE DOHC Toyota V6 Cyl, 3.445in./87.5mm (1999-2003)				1
----------	--	--	--	--	----------

Part	Year	VIN	Model/Application	Part Number	Qty.
------	------	-----	-------------------	-------------	------

ENGINE GASKETS

Head Set	1999-2003			HS54339	1
----------	-----------	--	--	---------	---

1	2995CC (3.0L) 1MZFE DOHC Toyota V6 Cyl, 3.445in./87.5mm (1999-2003)	1
(cont.)		(cont.)

Part	Year	VIN	Model/Application	Part Number	Qty.
ENGINE GASKETS (cont.)					
Lower Set	1999-2003			CS54339	1
Cylinder Head Gasket	1999-2002		Left	Multi-Layered Steel 54338	1
			Right	Multi-Layered Steel 54339	1
Manifold Gasket, Exh.	1999-2003			Multi-Layered Steel MS16344	1
Manifold Gasket, Int.	1999-2003			MS16348	1
Plenum Chamber Gasket	1999-2001			MS16073	1
Oil Pan Set	1999-2003			Cork Rubber OS32237	1
Rear Main Seal Set	1999-2003			JV1655	1
Timing Cover Set	1999-2003			JV1145	1
Timing Cover Seal	1999-2003			67010	1

MISCELLANEOUS GASKETS					
Camshaft Seal	1999-2003			66905	2
Camshaft Seal Set	1999-2001			JV5023	1
Exhaust Pipe Gasket	1999-2001		Pipe To Manifold	F7572	2
	1999-2000		Center Inlet Pipe To Manifold, Right Front	F20252	1
Fuel Inj. O-Ring	1999-2001			B45744	4
Fuel Injection Seal	1999-2001		(Grommet), Injector To Fuel Rail	B45854	2
Thermostat O-Ring	1999-2001			Victo-Tech C31090	1
Throttle Body Gasket	1999-2003			G31624	1
Water Pump Gasket	1999-2003			K31626	1

Mack

Engine Index

Engine	Year	Block
335 CID/5495CC (5.5L) MIDR 06.02.12 Renault Diesel		1

Engine	Year	Block
538 CID/8829CC (8.8L) MIDS 06.20.30 Renault Diesel		2

Model Index

Model	Engine	Year	Block
	335 CID/5495CC (5.5L) MIDR 06.02.12 Renault Diesel	0	1

Model	Engine	Year	Block
	538 CID/8829CC (8.8L) MIDS 06.20.30 Renault Diesel	0	2

1	335 CID/5495CC (5.5L) MIDR 06.02.12 Renault Diesel 6 Cyl, 4.016in./102mm	1
----------	---	----------

Part	Year	VIN	Model/Application	Part Number	Qty.
------	------	-----	-------------------	-------------	------

ENGINE GASKETS					
Full Set				FS4924	1

2	538 CID/8829CC (8.8L) MIDS 06.20.30 Renault Diesel 6 Cyl, 4.724in./120mm	2
----------	---	----------

Part	Year	VIN	Model/Application	Part Number	Qty.
------	------	-----	-------------------	-------------	------

ENGINE GASKETS					
Head Set				HS4943	1
Lower Set			(Requires Head Set To Make Full Set)	CS4943	1

Mazda Truck

Engine Index

Engine	Year	Block
1272CC (1.3L) TC SOHC Mazda	1975-1979	1
1586CC (1.6L) NA SOHC Mazda	1972-1976	2
1796CC (1.8L) VB SOHC Mazda	1977-1978	3
1970CC (2.0L) MA SOHC Mazda	1979-1984	4
1989CC (2.0L) Zetec/DOHC/16 Valve Ford	2001-2003	5
1998CC (2.0L) FE SOHC Mazda	1986-1987	6
2184CC (2.2L) F2 SOHC Mazda	1987-1993	7
2209CC (2.2L) S2 OHV Mazda Diesel	1982-1984	8
140 CID (2.3L) SOHC Ford	1994-1997	9

Engine	Year	Block
153 CID (2.5L) SOHC Ford	1998-2001	10
2555CC (2.6L) AM1 SOHC Mazda	1987-1988	11
2606CC (2.6L) G6 SOHC Mazda	1989-1994	12
181 CID/2967CC (3.0L) Duratec/DOHC/24 Valve Ford	2001-2002	13
183 CID (3.0L) FFV/OHV Ford Flex Fuel	1999-2001	14
183 CID (3.0L) OHV Ford	1994-2003	15
2954CC (3.0L) JE SOHC Mazda	1989-1995	16
4016CC (4.0L) OHV Ford	1991-2000	17

LIGHT TRUCK

Mazda Truck

Engine Index (cont.)

Engine	Year	Block
4016CC (4.0L) SOHC Ford	2001	18

Model Index

Model	Engine	Year	Block	Model	Engine	Year	Block
1300	1272CC (1.3L) TC SOHC Mazda	1975-1979	1	B2600	2606CC (2.6L) G6 SOHC Mazda	1989-1993	12
B1600	1586CC (1.6L) NA SOHC Mazda	1972-1976	2	B3000	183 CID (3.0L) FFV/OHV Ford	1999-2002	14
B1800	1796CC (1.8L) VB SOHC Mazda	1977-1978	3	B3000	183 CID (3.0L) OHV Ford	1994-2004	15
B2000	1970CC (2.0L) MA SOHC Mazda	1979-1984	4	B4000	4016CC (4.0L) SOHC Ford	2001	18
B2000	1998CC (2.0L) FE SOHC Mazda	1986-1987	6	B4000	4016CC (4.0L) OHV Ford	1994-2000	17
B2200	2184CC (2.2L) F2 SOHC Mazda	1987-1993	7	MPV	2606CC (2.6L) G6 SOHC Mazda	1989-1994	12
B2200	2209CC (2.2L) S2 OHV Mazda Diesel	1982-1984	8	MPV	2954CC (3.0L) JE SOHC Mazda	1989-1998	16
B2300	140 CID (2.3L) SOHC Ford	1994-1997	9	Navajo	4016CC (4.0L) OHV Ford	1991-1994	17
B2500	153 CID (2.5L) SOHC Ford	1998-2001	10	Tribute	181 CID/2967CC (3.0L) Duratec/DOHC/24 Valve Ford	2001-2004	13
B2600	2555CC (2.6L) AM1 SOHC Mazda	1987-1988	11	Tribute	1989CC (2.0L) Zetec/DOHC/16 Valve Ford	2001-2004	5

1 1272CC (1.3L) TC SOHC Mazda 4 Cyl, 2.874in./73mm (1975-1979) 1

Part	Year	VIN	Model/Application	Part Number	Qty.
------	------	-----	-------------------	-------------	------

ENGINE GASKETS

Head Set	1975-1979			HS3662	1
Full Set	1975-1979			FS3662	1
Cylinder Head Gasket	1975-1979			3662	1
Valve Cover Set	1975-1979		(Camshaft Seal Not Included) Cork Rubber	VS30203	1
Valve Stem Seal, Exh.	1975-1979			B45437	4
Valve Stem Seal, Int.	1975-1979			B45437	4
Manifold Set, Exhaust	1975-1979			MS15288	1
Manifold Set, Intake	1975-1979			MS15287	1
Oil Pan Set	1975-1979		Cork Rubber	OS30204	1
Rear Main Seal Set	1975-1979			JV503	1
Timing Cover Set	1975-1979			JV973	1

MISCELLANEOUS GASKETS

Cam. Semi-Circular Plug	1975-1979		(Half Round)	B45464	2
E.G.R. Gasket	1976-1979			G24843	1
Exhaust Pipe Gasket	1975-1979		(Flange Type), Pipe To Manifold	F20282	1
Fuel Pump Gasket	1975-1979			D20208	2
Water Outlet Gasket	1975-1979		(2 Holes) Victopac	C20115	1
Water Pump Mount Gasket	1975-1979			K20207	1

2 1586CC (1.6L) NA SOHC Mazda 4 Cyl, 3.071in./78mm (1972-1976) 2

Part	Year	VIN	Model/Application	Part Number	Qty.
------	------	-----	-------------------	-------------	------

ENGINE GASKETS

Head Set	1972-1976			HS3683	1
Full Set	1972-1976			FS3683	1
Engine Kit Gasket Set	1972-1976		(Exhaust Manifold Gasket Not Included), Use With Part Numbers MS85718, MS12281	95-3366VR	1
Cylinder Head Gasket	1972-1976		Nitroseal	3683	1
Cyl. Head Spacer Shim	1972-1976		Requires Sealing Compound Steel	3683S	1
Sealing Compound	1972-1976		(4 Ounce Brush Top Can)	JV66B	1
			(12 Ounce Spray Can)	JV66S	1
Valve Cover Set	1972-1976		(Camshaft Seal Not Included) Cork Rubber	VS39754	1
			(Camshaft Seal Not Included) Tuff-Cork	VS39754TC	1
			(Contains Camshaft Seal) Cork Rubber	VS39754W	1

2 1586CC (1.6L) NA SOHC Mazda 4 Cyl, 3.071in./78mm (1972-1976) **2**
(cont.) (cont.)

Part	Year	VIN	Model/Application	Part Number	Qty.
ENGINE GASKETS (cont.)					
Valve Cover Set (cont.)	1972-1976		(Camshaft Seal Not Included) <i>Victo-Tech</i>	VS50144	1
Valve Stem Seal, Exh.	1972-1976			B45437	4
Valve Stem Seal, Int.	1972-1976			B45437	4
Manifold Set, Exhaust	1972-1976		(Requires Both Sets)	MS12281	1
			(Requires Both Sets)	MS85718	1
Manifold Set, Intake	1972-1976			MS85719	1
Oil Pan Set	1972-1976		<i>Cork Rubber</i>	OS30548	1
Rear Main Seal Set	1972-1976			JV627	1
Timing Cover Set	1972-1976			JV963	1

MISCELLANEOUS GASKETS

Cam. Semi-Circular Plug	1972-1976		(Half Round)	B45450	2
Carb. Mount Gasket	1972-1976		2 Barrel Carburetor	G26825	2
Exhaust Pipe Gasket	1972-1976		(Flange Type), Pipe To Manifold	F7393	1
Water Outlet Gasket	1972-1976			C20136	1
Water Pump Mount Gasket	1972-1976			K20222	1

3 1796CC (1.8L) VB SOHC Mazda 4 Cyl, 3.071in./78mm (1977-1978) **3**

Part	Year	VIN	Model/Application	Part Number	Qty.
ENGINE GASKETS					
Head Set	1977-1978		(Exhaust Manifold Gasket Not Included)	HS3683	1
Full Set	1977-1978		(Exhaust Manifold Gasket Not Included)	FS3683	1
Engine Kit Gasket Set	1977-1978		(Exhaust Manifold Gasket Not Included), Use With Part Number MS12324	95-3366VR	1
Cylinder Head Gasket	1977-1978		<i>Nitroseal</i>	3683	1
Cyl. Head Spacer Shim	1977-1978		Requires Sealing Compound <i>Steel</i>	3683S	1
Sealing Compound	1977-1978		(4 Ounce Brush Top Can)	JV66B	1
			(12 Ounce Spray Can)	JV66S	1
Valve Cover Set	1977-1978		(Camshaft Seal Not Included) <i>Cork Rubber</i>	VS39754	1
			(Camshaft Seal Not Included) <i>Tuff-Cork</i>	VS39754TC	1
			(Contains Camshaft Seal) <i>Cork Rubber</i>	VS39754W	1
			(Camshaft Seal Not Included) <i>Victo-Tech</i>	VS50144	1
Valve Stem Seal, Exh.	1977-1978			B45437	4
Valve Stem Seal, Int.	1977-1978			B45437	4
Manifold Set, Exhaust	1977-1978			MS12324	1
Manifold Set, Intake	1977-1978			MS85719	1
Oil Pan Set	1977-1978		<i>Cork Rubber</i>	OS30548	1
Rear Main Seal Set	1977-1978			JV627	1
Timing Cover Set	1977-1978			JV963	1

MISCELLANEOUS GASKETS

Cam. Semi-Circular Plug	1977-1978		(Half Round)	B45450	2
Carb. Mount Gasket	1977-1978		2 Barrel Carburetor	G26825	2
Distributor Seal	1977-1978		(O-Ring Type)	B45781	1
E.G.R. Gasket	1977-1978			G24843	1
Exhaust Pipe Gasket	1977-1978		(Flange Type), Pipe To Manifold	F7393	1
Water Outlet Gasket	1977-1978			C20136	1
Water Pump Mount Gasket	1977-1978			K20222	1

Mazda Truck

4 1970CC (2.0L) MA SOHC Mazda 4 Cyl, 3.150in./80mm (1979-1984) 4

Part	Year	VIN	Model/Application	Part Number	Qty.
ENGINE GASKETS					
Head Set	1979-1984		(Exhaust Manifold Gasket For California Engine Not Included)	HS3683	1
Full Set	1979-1984		(Exhaust Manifold Gasket For California Engine Not Included)	FS3683	1
Engine Kit Gasket Set	1979-1984		(Exhaust Manifold Gasket Not Included), Use With Part Number MS12281	95-3366VR	1
Cylinder Head Gasket	1979-1984		<i>Nitroseal</i>	3683	1
Cyl. Head Spacer Shim	1979-1984		Requires Sealing Compound <i>Steel</i>	3683S	1
Sealing Compound	1979-1984		(4 Ounce Brush Top Can)	JV66B	1
			(12 Ounce Spray Can)	JV66S	1
Valve Cover Set	1979-1984		(Camshaft Seal Not Included) <i>Cork Rubber</i>	VS39754	1
			(Camshaft Seal Not Included) <i>Tuff-Cork</i>	VS39754TC	1
			(Contains Camshaft Seal) <i>Cork Rubber</i>	VS39754W	1
			(Camshaft Seal Not Included) <i>Victo-Tech</i>	VS50144	1
Valve Stem Seal, Exh.	1979-1984			B45437	4
Valve Stem Seal, Int.	1979-1984			B45437	4
Manifold Set, Exhaust	1979-1984		Except California	MS12281	1
			California	MS12324	1
Manifold Set, Intake	1979-1984			MS85719	1
Oil Pan Set	1979-1984		<i>Cork Rubber</i>	OS30548	1
Rear Main Seal Set	1979-1984			JV627	1
Timing Cover Set	1979-1984			JV963	1

MISCELLANEOUS GASKETS

Cam. Semi-Circular Plug	1979-1984			B45450	2
Carb. Mount Gasket	1979-1984		2 Barrel Carburetor	G30697	1
Dist. Mounting Gasket	1979-1984			66979	1
			(O-Ring Type)	B45781	1
E.G.R. Gasket	1979-1984			G24843	1
Exhaust Pipe Gasket	1984		Except California, (Flange Type), Pipe To Manifold	F10064	1
	1979-1984		California, (Flange Type), Pipe To Manifold	F7393	1
	1979-1983		Except California, (Flange Type), Pipe To Manifold	F20282	1
Water Outlet Gasket	1979-1984			C20136	1
Water Pump Mount Gasket	1979-1984			K27363	1

5 1989CC (2.0L) Zetec/DOHC/16 Valve Ford 4 Cyl, 3.339in./84.8mm (2001-2003) 5

Part	Year	VIN	Model/Application	Part Number	Qty.
ENGINE GASKETS					
Cylinder Head Gasket	2001-2003		<i>Multi-Layered Steel</i>	54197	1
Cyl. Head Bolt Set	2001-2003			GS33376	1
Valve Cover Set	2001-2003			VS50314	1
Valve Stem Seal, Exh.	2001-2003			B45915	8
Valve Stem Seal, Int.	2001-2003			B45915	8
Manifold Set, Exhaust	2001-2003			MS16177	1
Oil Pan Set	2001-2003			OS32228	1

MISCELLANEOUS GASKETS

Throttle Body Gasket	2001-2003		<i>Victo-Tech</i>	G31609	1
----------------------	-----------	--	-------------------	--------	---

6 1998CC (2.0L) FE SOHC Mazda 4 Cyl, 3.386in./86mm (1986-1987) 6

Part	Year	VIN	Model/Application	Part Number	Qty.
ENGINE GASKETS					
Head Set	1986-1987			HS3763W	1
Lower Set	1986-1987		(Requires Head Set To Make Full Set)	CS3763	1
Full Set	1986-1987			FS3763W	1

6 1998CC (2.0L) FE SOHC Mazda 4 Cyl, 3.386in./86mm (1986-1987) **6**
(cont.) (cont.)

Part	Year	VIN	Model/Application	Part Number	Qty.
ENGINE GASKETS (cont.)					
Engine Kit Gasket Set	1986-1987			95-3235VR	1
Cylinder Head Gasket	1986-1987		Nitroseal	3763	1
Cyl. Head Spacer Shim	1986-1987		Requires Sealing Compound Steel	3763S	1
Sealing Compound	1986-1987		(4 Ounce Brush Top Can)	JV66B	1
			(12 Ounce Spray Can)	JV66S	1
Valve Cover Set	1986-1987		(Contains Valve Cover Grommets, Camshaft Circular Plug Not Included) Victo-Tech	VS38374	1
Valve Stem Seal, Exh.	1986-1987			B45490	4
Valve Stem Seal, Int.	1986-1987			B45490	4
Manifold Set, Exhaust	1986-1987		Except California Multi-Layered Steel	MS15432	1
Manifold Set, Intake	1986-1987			MS15360	1
Oil Pan Set	1986-1987		Cork Rubber	OS30598	1
Rear Main Seal Set	1986-1987			JV535	1
Timing Cover Set	1986-1987			JV1001	1

MISCELLANEOUS GASKETS

Cam. Circular Plug	1986-1987			B45808	1
Camshaft Seal	1986-1987			66864	1
Carb. Mount Gasket	1986-1987		2 Barrel Carburetor	G30804	2
Dist. Mounting Gasket	1986-1987			66979	1
			(O-Ring Type) Rubber	B45781	1
Exhaust Pipe Gasket	1986-1987		(Flange Type), Catalytic Converter To Exhaust Pipe, Rear	F7486	2
			Carbureted Engine, (Flange Type), Pipe To Manifold	F10122	1
			(Flange Type), Catalytic Converter To Front Exhaust Pipe	GS33310	1
Fuel Pump Gasket	1986-1987			D24099	2
Oil Pump Seal	1986-1987		(O-Ring Type)	B45858	1
Water Outlet Gasket	1986-1987		(2 Holes) Victopac	C20115	1
Water Pump Hsg. O-Ring	1986-1987			B45807	1
Water Pump Mount Gasket	1986-1987			K27625	1

7 2184CC (2.2L) F2 SOHC Mazda 4 Cyl, 3.386in./86mm (1987-1993) **7**

Part	Year	VIN	Model/Application	Part Number	Qty.
------	------	-----	-------------------	-------------	------

ENGINE GASKETS

Head Set	1987-1993		(Throttle Body Gasket Not Included)	HS5770	1
Lower Set	1987-1993		(Requires Head Set To Make Full Set)	CS5851	1
Engine Kit Gasket Set	1987-1993			95-3303VR	1
Cylinder Head Gasket	1987-1993		Nitroseal	5851	1
Valve Cover Set	1987-1993		(Contains Valve Cover Grommets, Camshaft Circular Plug Not Included) Victo-Tech	VS38374	1
Valve Stem Seal, Exh.	1987-1993			B45490	4
Valve Stem Seal, Int.	1987-1993			B45490	4
Manifold Set, Exhaust	1990-1993		2 Barrel Carburetor Multi-Layered Steel	MS15432	1
			Multi-Port Fuel Injection	MS16504	1
	1987-1989		Multi-Layered Steel	MS15432	1
Manifold Set, Intake	1987-1993		(Contains Plenum Chamber Gasket)	MS15360	1
Oil Pan Set	1987-1993		Cork Rubber	OS30598	1
Rear Main Seal Set	1987-1993			JV535	1
Crank Repair Sleeve	1987-1993		Rear Nickel Plated Formed Steel, .013" Thickness	A347	1
Timing Cover Set	1987-1993			JV1057	1

MISCELLANEOUS GASKETS

Cam. Circular Plug	1987-1993			B45808	1
Camshaft Seal	1987-1993			66864	1
Carb. Mount Gasket	1987-1993		2 Barrel Carburetor	G30804	2
E.G.R. Gasket	1987-1993			G30748	1

Mazda Truck

7 (cont.)	2184CC (2.2L) F2 SOHC Mazda 4 Cyl, 3.386in./86mm (1987-1993)				7 (cont.)
---------------------	---	--	--	--	---------------------

Part	Year	VIN	Model/Application	Part Number	Qty.
------	------	-----	-------------------	-------------	------

MISCELLANEOUS GASKETS (cont.)

Exhaust Pipe Gasket	1993		Thru Vehicle Identification Number 381968, (Flange Type), Multi-Port Fuel Injection, Muffler To Tailpipe	F7476	1
			Thru Vehicle Identification Number 381968, (Flange Type), 2 Barrel Carburetor, Catalytic Converter To Center Pipe, Catalytic Converter To Muffler, Front Pipe to Center Pipe, Muffler To Tailpipe	F7476	4
			From Vehicle Identification Number 381968, (Flange Type), Multi-Port Fuel Injection, Muffler To Tailpipe	F10100	1
			From Vehicle Identification Number 381968, (Flange Type), 2 Barrel Carburetor, Catalytic Converter To Center Pipe, Catalytic Converter To Muffler, Front Pipe to Center Pipe, Muffler To Tailpipe	F10100	4
	1990-1993		(Flange Type), Multi-Port Fuel Injection, Catalytic Converter To Center Pipe, Catalytic Converter To Muffler, Front Pipe to Center Pipe	F7486	3
			(Flange Type), 2 Barrel Carburetor, Manifold To Pre-Catalytic Converter	F12332	1
			(Flange Type), Multi-Port Fuel Injection, Pipe To Manifold	F12454	1
			(Flange Type), 2 Barrel Carburetor, Pre-Catalytic Converter To Exhaust Pipe	GS33310	1
	1990-1992		(Flange Type), Multi-Port Fuel Injection, Muffler To Tailpipe	F7476	1
			(Flange Type), 2 Barrel Carburetor, Catalytic Converter To Center Pipe, Catalytic Converter To Muffler, Front Pipe to Center Pipe, Muffler To Tailpipe	F7476	4
	1987-1989		(Flange Type), Catalytic Converter To Center Pipe, Catalytic Converter To Muffler, Front Pipe to Center Pipe, Muffler To Tailpipe	F7476	4
			(Flange Type), Manifold To Pre-Catalytic Converter	F12332	1
			(Flange Type), Pre-Catalytic Converter To Exhaust Pipe	GS33310	1
Fuel Pump Gasket	1987-1993			D24099	2
Oil Pump Seal	1987-1993		(O-Ring Type) <i>Rubber</i>	B45858	1
Throttle Body Gasket	1990-1993			G31149	1
Water Outlet Gasket	1987-1993		(2 Holes) <i>Victopac</i>	C20115	1
Water Pump Gasket	1987-1993		Inlet	C31112	1
Water Pump Mount Gasket	1987-1993			K31069	1
			(O-Ring Type)	K31111	1

8	2209CC (2.2L) S2 OHV Mazda Diesel 4 Cyl, 3.504in./89mm (1982-1984)				8
----------	---	--	--	--	----------

Part	Year	VIN	Model/Application	Part Number	Qty.
------	------	-----	-------------------	-------------	------

ENGINE GASKETS

Head Set	1982-1984			HS3743	1
Valve Cover Set	1982-1984		(Valve Cover Grommets Not Included) <i>Victo-Tech</i>	VS39798	1
Valve Stem Seal, Int.	1982-1984			B45483	4
Rear Main Seal Set	1982-1984			JV529	1
Timing Cover Set	1982-1984			JV990	1

MISCELLANEOUS GASKETS

E.G.R. Gasket	1982-1984			G26703	1
Fuel Pump Gasket	1982-1984			D27094	1
Valve Cover Grommet	1982-1984			B45482	4
Water Outlet Gasket	1982-1984			C24553	1
Water Pump Mount Gasket	1983-1984			K27630	1
	1982			K27612	1

9	140 CID (2.3L) SOHC Ford 4 Cyl, 3.780in./96mm (1994-1997)	9
----------	--	----------

Part	Year	VIN	Model/Application	Part Number	Qty.	
ENGINE GASKETS						
Head Set	1995-1997			HS4029	1	
	1994			HS5938	1	
Lower Set	1995-1997		(Requires Head Set To Make Full Set)	CS5938B	1	
	1994		(Requires Head Set To Make Full Set)	CS5938A	1	
Engine Kit Gasket Set	1994		(Oil Pan Gasket Not Included), Use With Part Number OS32481	95-3384VR	1	
			(Oil Pan Gasket Not Included)	95-3384VR	1	
Cylinder Head Gasket	1994-1997		<i>VR2000</i>	4029	1	
			<i>Nitroseal</i>	4029SG	1	
Cyl. Head Bolt Set	1994-1997			GS33328	1	
Cyl. Head Spacer Shim	1994-1997		Requires Sealing Compound	<i>Steel</i>	4029S	1
Sealing Compound	1994-1997		(4 Ounce Brush Top Can)	JV66B	1	
Valve Cover Set	1994-1997			<i>Victo-Tech</i>	VS50208	1
Valve Stem Seal, Exh.	1995-1997			B45823	4	
	1994			B45404	4	
Valve Stem Seal, Int.	1995-1997			B45823	4	
	1994			<i>Fluoroelastomer</i>	B45418	4
Manifold Set, Exhaust	1994-1997			<i>Nitroseal</i>	MS16104	1
Manifold Set, Intake	1995-1997		(Contains Plenum Chamber Gasket)	MS16128	1	
	1994		(Contains Plenum Chamber Gasket)	MS15480	1	
Plenum Chamber Gasket	1995-1997			MS16129	1	
	1994			MS15547	1	
Oil Pan Set	1994-1997			<i>Victo-Tech</i>	OS32481	1
Rear Main Seal Set	1995-1997			JV1612	1	
				JV523	1	
				<i>Teflon</i>	JV1635	1
Crank Repair Sleeve	1994-1997		Use With Part Number A509 <i>Nickel Plated Formed Steel, .013" Thickness</i>	A335	1	
Timing Cover Set	1994-1997		(Auxiliary Shaft Seal Not Included)	JV1175	1	

MISCELLANEOUS GASKETS

Dist. Mounting Gasket	1994-1997		(O-Ring Type)	72122	1
E.G.R. Gasket	1995-1997			G30625	1
	1994			G26703	1
Exhaust Pipe Gasket	1994-1997		(Ring Type 'F'), Pipe To Converter	F10085	1
Injector Nozzle O-Ring	1994-1997			GS33276	2
Throttle Body Gasket	1994-1997			G30942	1
Water Outlet Gasket	1994-1997			C26681	1
Water Pump Mount Gasket	1995-1997			K31355	1
	1994			K27612	1

10	153 CID (2.5L) SOHC Ford 4 Cyl, 3.780in./96mm (1998-2001)	10
-----------	--	-----------

Part	Year	VIN	Model/Application	Part Number	Qty.	
ENGINE GASKETS						
Cylinder Head Gasket	1998-2001			<i>VR2000</i>	4029	1
				<i>Nitroseal</i>	4029SG	1
Cyl. Head Bolt Set	1998-2001			GS33328	1	
Valve Cover Set	1998-2001			<i>Victo-Tech</i>	VS50208	1
Valve Stem Seal, Exh.	1998			B45823	4	
Valve Stem Seal, Int.	1998			B45823	4	
Manifold Set, Intake	1998-2001		(Contains Plenum Chamber Gasket)	MS16128	1	
Plenum Chamber Gasket	1998-2001			MS16129	1	
Timing Cover Seal	1998-2001			47524	1	

Mazda Truck

10 (cont.)	153 CID (2.5L) SOHC Ford 4 Cyl, 3.780in./96mm (1998-2001)				10 (cont.)
----------------------	--	--	--	--	----------------------

Part	Year	VIN	Model/Application	Part Number	Qty.
MISCELLANEOUS GASKETS					
Aux. Shaft Seal	1998-2001			47524	1
Camshaft Seal	1998-2001			47524	1
E.G.R. Gasket	1998-2001			G30625	1
Injector Nozzle O-Ring	1998-2001			GS33276	2
Throttle Body Gasket	1998-2001			G30942	1

11	2555CC (2.6L) AM1 SOHC Mazda 4 Cyl, 3.587in./91.1mm (1987-1988)				11
-----------	--	--	--	--	-----------

Part	Year	VIN	Model/Application	Part Number	Qty.
ENGINE GASKETS					
Head Set	1987-1988			HS3697W	1
Full Set	1987-1988			FS3697W	1
Engine Kit Gasket Set	1987-1988		2 Barrel Carburetor	95-3104VR	1
Cylinder Head Gasket	1987-1988			VR2000 3697	1
Cyl. Head Spacer Shim	1987-1988		Requires Sealing Compound	Steel 3697S	1
Sealing Compound	1987-1988		(4 Ounce Brush Top Can)	JV66B	1
			(12 Ounce Spray Can)	JV66S	1
Valve Cover Set	1987-1988			Victo-Tech VS39865	1
Valve Stem Seal, Exh.	1987-1988		(Original Equipment Type)	B45441	4
Valve Stem Seal, Int.	1987-1988		(Original Equipment Type)	B45441	4
Manifold Set, Exhaust	1987-1988			MS15299	1
Manifold Set, Intake	1987-1988			Performaseal MS15320	1
Oil Pan Set	1987-1988			Cork Rubber OS20776	1
Rear Main Seal Set	1987-1988			JV534	1
Timing Cover Set	1987-1988			JV943	1
Timing Cover Seal	1987-1988			47735	1

MISCELLANEOUS GASKETS					
Air Cleaner Mount Gasket	1987-1988		2 Barrel Carburetor	G24965	1
Cam. Semi-Circular Plug	1987-1988			B24180	1
Carb. Mount Gasket	1987-1988		2 Barrel Carburetor	G25771	1
E.G.R. Gasket	1987-1988			G24078	1
Fuel Pump Gasket	1987-1988			D24076	2
Jet Valve Seal	1987-1988		(Jet Valve)	B45471	4
Water Outlet Gasket	1987-1988			C24082	1
Water Pump Mount Gasket	1987-1988			K26487	1

12	2606CC (2.6L) G6 SOHC Mazda 4 Cyl, 3.622in./92mm (1989-1994)				12
-----------	---	--	--	--	-----------

Part	Year	VIN	Model/Application	Part Number	Qty.
ENGINE GASKETS					
Head Set	1989-1994			HS4906	1
Full Set	1989-1994			FS4906	1
Cylinder Head Gasket	1989-1994			Nitroseal 4906	1
Valve Cover Set	1989-1994		(Contains Valve Cover End Plugs)	Victo-Tech VS50136	1
Valve Stem Seal, Exh.	1989-1994			B45588	4
Valve Stem Seal, Int.	1989-1994			B45588	4
Manifold Set, Exhaust	1989-1994			Multi-Layered Steel MS15673	1
Manifold Set, Intake	1989-1994		(Contains Plenum Chamber Gasket)	MS15671	1
Plenum Chamber Gasket	1989-1994			MS15672	1
Oil Pan Set	1990-1994		(Requires RTV)	Silicone JV6	1
	1989			Cork Rubber OS32097	1
Rear Main Seal	1989-1994			Rubber 67150	1
Timing Cover Set	1989-1994			JV1120	1

12 2606CC (2.6L) G6 SOHC Mazda 4 Cyl, 3.622in./92mm (1989-1994) **12**
(cont.) (cont.)

Part	Year	VIN	Model/Application	Part Number	Qty.
MISCELLANEOUS GASKETS					
Exhaust Pipe Gasket	1989-1994		(Flange Type), Catalytic Converter To Exhaust Pipe	F7486	2
			(Flange Type), Pipe To Manifold	F7491	1
Therm. Housing Gasket	1989-1994			C31146	1
Throttle Body Gasket	1991-1994			G31149	1
			Thru Chassis Serial Number 880548	G31148	1
	1990		From Chassis Serial Number 880549	G31149	1
	1989			G31148	1
Water Outlet Gasket	1989-1994		(2 Holes) <i>Victopac</i>	C20115	1
Water Pump Mount Gasket	1989-1994			K31147	1

13 181 CID/2967CC (3.0L) Duratec/DOHC/24 Valve Ford V6 Cyl, 3.504in./89mm (2001-2002) **13**

Part	Year	VIN	Model/Application	Part Number	Qty.
ENGINE GASKETS					
Valve Stem Seal, Exh.	2001-2002			B45837	12
Valve Stem Seal, Int.	2001-2002			B45837	12
Rear Main Seal Set	2001-2002			JV1612	1
MISCELLANEOUS GASKETS					
E.G.R. Gasket	2001-2002			G30625	1
Water Outlet Gasket	2001-2002			C31302	1

14 183 CID (3.0L) FFV/OHV Ford Flex Fuel V6 Cyl, 3.504in./89mm (1999-2001) **14**

Part	Year	VIN	Model/Application	Part Number	Qty.
ENGINE GASKETS					
Timing Cover Set	1999-2001		(Requires Oil Pan Set), Use With Part Number OS32486	JV1032	1

15 183 CID (3.0L) OHV Ford V6 Cyl, 3.504in./89mm (1994-2003) **15**

Part	Year	VIN	Model/Application	Part Number	Qty.
ENGINE GASKETS					
Head Set	1994-1997		(Contains Head Bolts)	HS5752WB1	1
			(Head Bolts Not Included)	HS5885	1
Lower Set	1994-1997		(Requires Head Set To Make Full Set)	CS5891	1
Cylinder Head Gasket	1994-2000		Right <i>Nitroseal</i>	5926	1
			Left <i>Nitroseal</i>	5927	1
Cyl. Head Bolt Set	1998		Thru 7/13/98	GS33220	2
	1994-1997			GS33220	2
Valve Cover Set	1994-2001		<i>Victo-Tech</i>	VS50145	1
Valve Stem Seal, Exh.	1999		8mm Valve Stem Diameter, Thru 12/9/99	B45576	6
	1994-1998		8mm Valve Stem Diameter	B45576	6
Valve Stem Seal, Int.	1999		8mm Valve Stem Diameter, Thru 12/9/99	B45575	6
	1998			B45575	6
			8mm Valve Stem Diameter	B45575	6
	1996		Thru 6/1/96	B45575	6
	1994-1995			B45575	6
Manifold Set, Exhaust	1994-1997			MS15426	1
Manifold Set, Intake	1994-2003		(Contains Plenum Chamber Gasket)	MS16068	1
Plenum Chamber Gasket	1994-2003			MS15404	1
Oil Pan Set	1994-2001		<i>Victo-Tech</i>	OS32486	1
Rear Main Seal	1994-2001			47753	1
Rear Main Seal Set	1994-1997			JV555	1
Timing Cover Set	1994-2001		(Requires Oil Pan Set), Use With Part Number OS32486	JV1032	1
Timing Cover Seal	1994-2001			46293	1

Mazda Truck

15 (cont.)	183 CID (3.0L) OHV Ford V6 Cyl, 3.504in./89mm (1994-2003)				15 (cont.)
----------------------	--	--	--	--	----------------------

Part	Year	VIN	Model/Application	Part Number	Qty.
MISCELLANEOUS GASKETS					
E.G.R. Gasket	1994-1997			G30625	1
Exhaust Pipe Gasket	1994		(Ring Type 'F'), Catalytic Converter To Muffler	F10085	1
			Inlet Pipe To Catalytic Converter	F14763	1
Therm. Housing Gasket	1994-1997			C30719	1
Water Pump Mount Gasket	1994-1997			K30629	1

16	2954CC (3.0L) JE SOHC Mazda V6 Cyl, 3.543in./90mm (1989-1995)				16
-----------	--	--	--	--	-----------

Part	Year	VIN	Model/Application	Part Number	Qty.
ENGINE GASKETS					
Head Set	1989-1995			HS5856	1
Full Set	1989-1995			FS5856	1
Cylinder Head Gasket	1989-1995		Left <i>Multi-Layered Steel</i>	5856	1
			Right <i>Multi-Layered Steel</i>	5857	1
Cyl. Head Bolt Set	1989-1995		(1 Set Per Head)	GS33314	2
Cyl. Head Spacer Shim	1989-1995		Requires Sealing Compound, Left <i>Steel</i>	5856S	1
			Requires Sealing Compound, Right <i>Steel</i>	5857S	1
Sealing Compound	1989-1995		(4 Ounce Brush Top Can)	JV66B	1
			(12 Ounce Spray Can)	JV66S	1
Valve Cover Set	1989-1995		(Valve Cover Washers Not Included) <i>Victo-Tech</i>	VS50097	1
Valve Stem Seal, Exh.	1989-1995			B45490	6
Valve Stem Seal, Int.	1989-1995			B45588	12
Manifold Set, Exhaust	1989-1995		<i>Multi-Layered Steel</i>	MS15557	1
Manifold Set, Intake	1989-1995		(Contains Plenum Chamber Gasket)	MS15556	1
Oil Pan Set	1989-1995		(Requires RTV) <i>Cork Rubber</i>	OS32081	1
Rear Main Seal Set	1989-1995			JV593	1
Timing Cover Set	1989-1995		(Camshaft Seal Not Included)	JV1104	1

Part	Year	VIN	Model/Application	Part Number	Qty.
MISCELLANEOUS GASKETS					
Camshaft Seal	1989-1995		Rear Cap	B45688	2
Camshaft Seal Set	1989-1995		Front	JV1106	1
Exhaust Pipe Gasket	1989-1995		(Flange Type), Pipe To Manifold	F7280	1
Oil Pump Mounting Gasket	1989-1992			L45700	1
Therm. Housing Gasket	1989-1995			C31074	1
Throttle Body Gasket	1989-1992			G31078	1
Valve Cover Grommet	1989-1995			B45656	14
Water Outlet Gasket	1989-1995		Original Equipment Uses RTV <i>Silicone</i>	JV6	1
Water Pump Mount Gasket	1989-1995			K31077	1

17	4016CC (4.0L) OHV Ford V6 Cyl, 3.953in./100.4mm (1991-2000)				17
-----------	--	--	--	--	-----------

Part	Year	VIN	Model/Application	Part Number	Qty.
ENGINE GASKETS					
Head Set	1991-1994		(Head Bolts Not Included)	HS5887	1
			(Contains Head Bolts)	HS5887WB	1
Lower Set	1991-1993		(Requires Head Set To Make Full Set)	CS5887A	1
Full Set	1991-1993		(Head Bolts Not Included)	FS5887	1
Engine Kit Gasket Set	1991-1994			95-3390VR	1
Cylinder Head Gasket	1991-1997		Left <i>VR2000</i>	5887	1
			Right <i>VR2000</i>	5888	1
Cyl. Head Bolt Set	1991-2000			GS33221	2
Valve Cover Set	1991-1997		<i>Tuff-Cork</i>	VS50153TC	1
Valve Stem Seal, Exh.	1991-2000			B45900	6

LIGHT TRUCK

17 4016CC (4.0L) OHV Ford V6 Cyl, 3.953in./100.4mm (1991-2000) **17**
(cont.) (cont.)

Part	Year	VIN	Model/Application	Part Number	Qty.
ENGINE GASKETS (cont.)					
Valve Stem Seal, Int.	1991-2000			B45900	6
Manifold Set, Exhaust	1991-1994			MS12396	1
Manifold Set, Intake	1991-1996		(Requires Valve Cover Set, Plenum Chamber Gasket Not Included, 1 Piece Design With Attached Victo-Foam End Strips) <i>Nitroseal</i>	MS15985	1
Plenum Chamber Gasket	1991-1994		Fuel Rail To Plenum	MS15675	1
Oil Pan Set	1994-2000		<i>Victo-Tech</i>	OS32521	1
	1991-1993		<i>Victo-Tech</i>	OS32468	1
Rear Main Seal Set	1991-1994			JV617	1
Timing Cover Set	1994-2000		(Requires Oil Pan Set), Use With Part Number OS32521	JV1139	1
	1991-1993		(Requires Oil Pan Set), Use With Part Number OS32468	JV1139	1
Timing Cover Seal	1991-2000			47518	1

MISCELLANEOUS GASKETS

Dist. Mounting Gasket	1991-1994		(O-Ring Type)	72025	1
Throttle Body Gasket	1991-1994			G31110	1
Water Pump Mount Gasket	1991-2000			K27985	1

18 4016CC (4.0L) SOHC Ford V6 Cyl, 3.953in./100.4mm (2001) **18**

Part	Year	VIN	Model/Application	Part Number	Qty.
ENGINE GASKETS					
Timing Cover Seal	2001			47518	1

Mercedes Benz Truck

Engine Index

Engine	Year	Block
346 CID/5675CC (5.7L) OM352 Mercedes Benz Diesel		1

Engine	Year	Block
346 CID/5675CC (5.7L) OM352A Mercedes Benz Diesel		2

Model Index

Model	Engine	Year	Block
L1013/36	346 CID/5675CC (5.7L) OM352 Mercedes Benz Diesel		1
L1013/42	346 CID/5675CC (5.7L) OM352 Mercedes Benz Diesel		1
L1013/51	346 CID/5675CC (5.7L) OM352 Mercedes Benz Diesel		1
L1113/36	346 CID/5675CC (5.7L) OM352 Mercedes Benz Diesel		1
L1113/42	346 CID/5675CC (5.7L) OM352 Mercedes Benz Diesel		1
L1113/48	346 CID/5675CC (5.7L) OM352 Mercedes Benz Diesel		1
L1113/51	346 CID/5675CC (5.7L) OM352 Mercedes Benz Diesel		1
L1116/36	346 CID/5675CC (5.7L) OM352A Mercedes Benz Diesel		2
L1116/42	346 CID/5675CC (5.7L) OM352A Mercedes Benz Diesel		2

Model	Engine	Year	Block
L1116/48	346 CID/5675CC (5.7L) OM352A Mercedes Benz Diesel		2
L1116/51	346 CID/5675CC (5.7L) OM352A Mercedes Benz Diesel		2
L1316/36	346 CID/5675CC (5.7L) OM352A Mercedes Benz Diesel		2
L1316/42	346 CID/5675CC (5.7L) OM352A Mercedes Benz Diesel		2
L1316/48	346 CID/5675CC (5.7L) OM352A Mercedes Benz Diesel		2
L1316/51	346 CID/5675CC (5.7L) OM352A Mercedes Benz Diesel		2
L10143/48	346 CID/5675CC (5.7L) OM352 Mercedes Benz Diesel		1

1 346 CID/5675CC (5.7L) OM352 Mercedes Benz Diesel 6 Cyl, 3.819in./97mm **1**

Part	Year	VIN	Model/Application	Part Number	Qty.
ENGINE GASKETS					
Head Set			(Valve Stem Seals Not Included)	HS4801	1
Full Set			(Valve Stem Seals Not Included)	FS4801	1
Valve Stem Seal, Exh.			Thru Engine Serial Number 794938	B45604	6

Mercedes Benz Truck

1 (cont.)	346 CID/5675CC (5.7L) OM352 Mercedes Benz Diesel 6 Cyl, 3.819in./97mm				1 (cont.)
---------------------	--	--	--	--	---------------------

Part	Year	VIN	Model/Application	Part Number	Qty.
ENGINE GASKETS (cont.)					
Valve Stem Seal, Exh. (cont.)			From Engine Serial Number794939	B45605	6
Valve Stem Seal, Int.			Thru Engine Serial Number 794938	B45602	6
			From Engine Serial Number794939	B45603	6

2	346 CID/5675CC (5.7L) OM352A Mercedes Benz Diesel 6 Cyl, 3.819in./97mm				2
----------	---	--	--	--	----------

Part	Year	VIN	Model/Application	Part Number	Qty.
ENGINE GASKETS					
Head Set			(Valve Stem Seals Not Included)	HS4801	1
Full Set			(Valve Stem Seals Not Included)	FS4801	1
Valve Stem Seal, Exh.			Thru Engine Serial Number 794938	B45604	6
			From Engine Serial Number794939	B45605	6
Valve Stem Seal, Int.			Thru Engine Serial Number 794938	B45602	6
			From Engine Serial Number794939	B45603	6

Mitsubishi Truck

Engine Index

Engine	Year	Block	Engine	Year	Block
1997CC (2.0L) G63B SOHC Mitsubishi	1983-1989	1	2555CC (2.6L) G54B Mitsubishi	1983-1989	6
2346CC (2.3L) 4D55 Mitsubishi Diesel	1983-1985	2	2972CC (3.0L) 6G72 SOHC 12 Valve Mitsubishi	1989-1997	7
2351CC (2.4L) 4G64 SOHC 16 Valve Mitsubishi	1993-1999	3	2972CC (3.0L) 6G72 SOHC 24 Valve Mitsubishi	1994-2001	8
2351CC (2.4L) 4G64 SOHC 8 Valve Mitsubishi	1989-1996	4	3497CC (3.5L) 6G74 DOHC Mitsubishi	1994-1996	9
2351CC (2.4L) G64B SOHC Mitsubishi	1987-1988	5	3497CC (3.5L) 6G74 SOHC Mitsubishi	1997-2000	10

Model Index

Model	Engine	Year	Block	Model	Engine	Year	Block
2300	2346CC (2.3L) 4D55 Mitsubishi Diesel	1983-1985	2	Montero	2972CC (3.0L) 6G72 SOHC 12 Valve Mitsubishi	1989-1994	7
2600	2555CC (2.6L) G54B Mitsubishi	1983-1986	6	Montero	3497CC (3.5L) 6G74 SOHC Mitsubishi	1997-2000	10
Expo	2351CC (2.4L) 4G64 SOHC 16 Valve Mitsubishi	1993-1995	3	Montero	3497CC (3.5L) 6G74 DOHC Mitsubishi	1994-1996	9
Expo	2351CC (2.4L) 4G64 SOHC 8 Valve Mitsubishi	1992	4	Montero Sport	2351CC (2.4L) 4G64 SOHC 16 Valve Mitsubishi	1997-1999	3
Expo LRV	2351CC (2.4L) 4G64 SOHC 16 Valve Mitsubishi	1993-1994	3	Montero Sport	2972CC (3.0L) 6G72 SOHC 24 Valve Mitsubishi	1997-2003	8
Mighty Max	1997CC (2.0L) G63B SOHC Mitsubishi	1983-1989	1	Montero Sport	3497CC (3.5L) 6G74 SOHC Mitsubishi	1999-2003	10
Mighty Max	2351CC (2.4L) 4G64 SOHC 8 Valve Mitsubishi	1990-1996	4	SPX	2555CC (2.6L) G54B Mitsubishi	1987-1989	6
Mighty Max	2555CC (2.6L) G54B Mitsubishi	1984-1989	6	Van	2351CC (2.4L) 4G64 SOHC 8 Valve Mitsubishi	1989-1990	4
Mighty Max	2972CC (3.0L) 6G72 SOHC 12 Valve Mitsubishi	1990-1995	7	Van	2351CC (2.4L) G64B SOHC Mitsubishi	1987-1988	5
Montero	2555CC (2.6L) G54B Mitsubishi	1983-1989	6	Wagon	2351CC (2.4L) 4G64 SOHC 8 Valve Mitsubishi	1989-1990	4
Montero	2972CC (3.0L) 6G72 SOHC 24 Valve Mitsubishi	1994-1996	8	Wagon	2351CC (2.4L) G64B SOHC Mitsubishi	1987-1988	5

1	1997CC (2.0L) G63B SOHC Mitsubishi 4 Cyl, 3.346in./85mm (1983-1989)				1
----------	--	--	--	--	----------

Part	Year	VIN	Model/Application	Part Number	Qty.
ENGINE GASKETS					
Head Set	1987-1989		(Exhaust Pipe Gasket Not Included)	HS5703Y	1
	1983-1986		(Exhaust Pipe Gasket Not Included)	HS5703	1
Lower Set	1983-1989			CS5875	1
Full Set	1987-1989		(Exhaust Pipe Gasket Not Included)	FS5703Y	1
	1983-1986		(Exhaust Pipe Gasket Not Included)	FS5703	1
Engine Kit Gasket Set	1983-1989			95-3133VR	1

1 1997CC (2.0L) G63B SOHC Mitsubishi 4 Cyl, 3.346in./85mm (1983-1989) **1**
(cont.) (cont.)

Part	Year	VIN	Model/Application	Part Number	Qty.
ENGINE GASKETS (cont.)					
Cylinder Head Gasket	1983-1989		VR2000	5703	1
Cyl. Head Spacer Shim	1983-1989		Requires Sealing Compound Steel	5703S	1
Sealing Compound	1983-1989		(4 Ounce Brush Top Can)	JV66B	1
			(12 Ounce Spray Can)	JV66S	1
Valve Cover Set	1983-1989		(Valve Cover Grommets Not Included, Camshaft Semi Circular Plug Not Included) Victo-Tech	VS40003	1
			(Contains Valve Cover Grommets, Contains Camshaft Semi Circular Plug) Victo-Tech	VS40003CP	1
Valve Stem Seal, Exh.	1983-1989		(Original Equipment Type)	B45441	4
			(Premium)	B45806	4
Valve Stem Seal, Int.	1983-1989		(Original Equipment Type)	B45441	4
			(Premium)	B45806	4
Manifold Set, Exhaust	1987-1989			MS15389	1
	1983-1986			MS15392	1
Manifold Set, Intake	1983-1989			MS15387	1
Oil Pan Set	1983-1989		Cork Rubber	OS32008	1
Rear Main Seal Set	1983-1989			JV534	1
Timing Cover Set	1987-1989			JV1036	1
	1983-1986			JV994	1
Timing Cover Seal	1983-1989			47730	1

MISCELLANEOUS GASKETS

Air Cleaner Mount Gasket	1983-1989		2 Barrel Carburetor	G24965	1
Camshaft Seal	1983-1989			47918	1
Cam. Semi-Circular Plug	1983-1989			B24180	1
Carb. Mount Gasket	1987-1989		2 Barrel Carburetor	G30713	1
	1983-1986		2 Barrel Carburetor	G25771	1
E.G.R. Gasket	1987-1989		Nitroseal	G30714	1
	1983-1986			G24078	1
Exhaust Pipe Gasket	1987-1989		(Flange Type), Catalytic Converter To Center Pipe	F7422	1
			(Flange Type), Pipe To Manifold	F12287	1
	1983-1986		(Flange Type), Pipe To Manifold	F7409	1
			(Ring Type 'F'), Catalytic Converter To Exhaust Pipe	F7424	1
Fuel Pump Gasket	1983-1989			D24085	2
Jet Valve Seal	1983-1989			B45471	4
Valve Cover Grommet	1983-1989			B45729	2
Water Outlet Gasket	1983-1989			C24082	1
Water Pump Mount Gasket	1983-1989			K30615	1

2 2346CC (2.3L) 4D55 Mitsubishi Diesel 4 Cyl, 3.587in./91.1mm (1983-1985) **2**

Part	Year	VIN	Model/Application	Part Number	Qty.
ENGINE GASKETS					
Head Set	1983-1985		Turbocharged	HS3786	1
Full Set	1983-1985		Turbocharged	FS3786	1
Cylinder Head Gasket	1983-1985		Turbocharged VR2000	3786	1
Valve Cover Set	1983-1985		(Valve Cover End Plugs Not Included), Turbocharged Victo-Tech	VS39371	1
Valve Stem Seal, Exh.	1983-1985		(Original Equipment Type), Turbocharged	B45441	4
			(Premium), Turbocharged	B45806	4
Valve Stem Seal, Int.	1983-1985		(Original Equipment Type), Turbocharged	B45441	4
			(Premium), Turbocharged	B45806	4
Manifold Set, Int. & Exh.	1983-1985		Turbocharged	MS15378	1
Oil Pan Set	1983-1985		Turbocharged Cork Rubber	OS20776	1

Mitsubishi Truck

2 (cont.)	2346CC (2.3L) 4D55 Mitsubishi Diesel 4 Cyl, 3.587in./91.1mm (1983-1985)				2 (cont.)
---------------------	--	--	--	--	---------------------

Part	Year	VIN	Model/Application	Part Number	Qty.
------	------	-----	-------------------	-------------	------

ENGINE GASKETS (cont.)

Rear Main Seal Set	1983-1985		Turbocharged	JV534	1
Timing Cover Set	1983-1985		Turbocharged	JV995	1
Timing Cover Seal	1983-1985		Turbocharged	47730	1

MISCELLANEOUS GASKETS

Camshaft Seal	1983-1985		Turbocharged	47918	1
Jet Valve Seal	1983-1985		Turbocharged	B45471	4
Water Inlet Gasket	1983-1985		Turbocharged	C26842	1
Water Outlet Gasket	1983-1985		Turbocharged	C26846	1
Water Pump Mount Gasket	1983-1985		Turbocharged	K30620	1

3	2351CC (2.4L) 4G64 SOHC 16 Valve Mitsubishi 4 Cyl, 3.406in./86.5mm (1993-1999)				3
----------	---	--	--	--	----------

Part	Year	VIN	Model/Application	Part Number	Qty.
------	------	-----	-------------------	-------------	------

ENGINE GASKETS

Head Set	1997		(Exhaust Pipe Gasket Not Included)	HS54119	1
	1993-1995		(Exhaust Pipe Gasket Not Included)	HS54119	1
Cylinder Head Gasket	1997		Nitroseal	54119G	1
	1993-1995		Nitroseal	54119G	1
Valve Cover Set	1997-1999		(Contains Spark Plug Tube Seals) Victo-Tech	VS50267	1
	1993-1995		(Contains Spark Plug Tube Seals) Victo-Tech	VS50267	1
Valve Stem Seal, Exh.	1997-1999			B45870	8
	1993-1995			B45870	8
Valve Stem Seal, Int.	1997-1999			B45870	8
	1993-1995			B45870	8
Manifold Set, Exhaust	1997-1999			MS16215	1
	1993-1995			MS16215	1
Manifold Set, Intake	1997			MS16250	1
	1993-1995			MS16250	1
Timing Cover Seal	1997-1999			47730	1
	1993-1995			47730	1

MISCELLANEOUS GASKETS

Camshaft Seal	1997-1999			47918	1
	1993-1995			47918	1
E.G.R. Gasket	1997-1999		Nitroseal	G30714	1
	1993-1995		Nitroseal	G30714	1
Exhaust Pipe Gasket	1997-1999		California Emission, (Flange Type), Manifold To Pre-Catalytic Converter	F7409	1
			California Emission, (Flange Type), Catalytic Converter To Front Exhaust Pipe, Pre-Catalytic Converter To Exhaust Pipe	F7409	2
			Federal Emission, (Flange Type), Pipe To Manifold	F7409	1
			California Emission, Federal Emission, (Flange Type), Catalytic Converter To Center Pipe, Catalytic Converter To Front Exhaust Pipe	F7422	2
			Muffler To Tailpipe	F10120	1
	1995		California Emission, (Flange Type), Catalytic Converter To Center Pipe	F7409	1
			California Emission, (Flange Type), Catalytic Converter To Front Exhaust Pipe, Pre-Catalytic Converter To Exhaust Pipe	F7409	2
	1993-1995		Federal Emission, (Flange Type), Catalytic Converter To Center Pipe, Catalytic Converter To Front Exhaust Pipe	F7409	2
			Muffler To Tailpipe	F10120	1
			Federal Emission, (Flange Type), Pipe To Manifold	F12336	1
1994		California Emission, From 6/94, (Flange Type), Catalytic Converter To Center Pipe	F7409	1	

3 2351CC (2.4L) 4G64 SOHC 16 Valve Mitsubishi 4 Cyl, 3.406in./86.5mm (1993-1999) **3**
(cont.) (cont.)

Part	Year	VIN	Model/Application	Part Number	Qty.
MISCELLANEOUS GASKETS (cont.)					
Exhaust Pipe Gasket (cont.)	1994		California Emission, From 6/94, (Flange Type), Catalytic Converter To Front Exhaust Pipe, Pre-Catalytic Converter To Exhaust Pipe	F7409	2
Spark Plug Tube Seal	1997			B45881	4
	1993-1995			B45881	4
Throttle Body Gasket	1997-1999			G31558	1
	1993-1995			G31558	1
Water Pipe O-Ring	1997-1999			B45797	3
	1993-1995			B45797	3
Water Pump Gasket	1997-1999			K31552	1
	1993-1995			K31552	1

4 2351CC (2.4L) 4G64 SOHC 8 Valve Mitsubishi 4 Cyl, 3.406in./86.5mm (1989-1996) **4**
(cont.) (cont.)

Part	Year	VIN	Model/Application	Part Number	Qty.
ENGINE GASKETS					
Head Set	1989-1992		(Exhaust Pipe Gasket Not Included)	HS5747X	1
Lower Set	1993-1994		(Requires Head Set To Make Full Set)	CS5875A	1
Full Set	1989-1992		(Jet Valve Seals Not Included, Exhaust Pipe Gasket Not Included)	FS5747X	1
Cylinder Head Gasket	1989-1996		<i>Nitroseal</i>	5747	1
Valve Cover Set	1989-1994		(Valve Cover Grommets Not Included, Camshaft Semi Circular Plug Not Included) <i>Victo-Tech</i>	VS40003	1
			(Contains Valve Cover Grommets, Contains Camshaft Semi Circular Plug) <i>Victo-Tech</i>	VS40003CP	1
Valve Stem Seal, Exh.	1993-1994			B45870	4
	1989-1992		(Original Equipment Type)	B45441	4
	1989-1991		(Premium)	B45806	4
Valve Stem Seal, Int.	1993-1994			B45870	4
	1989-1992		(Original Equipment Type)	B45441	4
	1989-1991		(Premium)	B45806	4
Manifold Set, Exhaust	1993-1994		<i>Multi-Layered Steel</i>	MS16215	1
	1989-1992			MS15389	1
Manifold Set, Intake	1992-1994		(Contains Plenum Chamber Gasket)	MS15387W	1
	1989-1992			MS15387	1
Plenum Chamber Gasket	1992			MS14901	1
	1990-1991		Mighty Max	MS14901	1
	1989-1990		Van, Wagon	MS14900	1
Oil Pan Set	1993-1994		<i>Cork Rubber</i>	OS32137	1
	1989-1992		<i>Cork Rubber</i>	OS32008	1
Rear Main Seal Set	1993-1994			JV1646	1
	1989-1992			JV534	1
Timing Cover Set	1989-1992			JV1036	1
Timing Cover Seal	1989-1996			47730	1

MISCELLANEOUS GASKETS					
Air Flow Sensor	1989-1990			G30807	1
Camshaft Seal	1989-1996			47918	1
Cam. Semi-Circular Plug	1989-1996			B24180	1
E.G.R. Gasket	1989-1996		<i>Nitroseal</i>	G30714	1
Exhaust Pipe Gasket	1989-1996		(Flange Type), Catalytic Converter	F7422	2
	1992		Expo, (Flange Type), Pipe To Manifold	F12336	1
	1990-1992		Mighty Max, (Flange Type), Pipe To Manifold	F12287	1
	1989-1991		(Flange Type), Pipe To Manifold	F12287	1
Jet Valve Seal	1989-1991			B45471	4
Throttle Body Gasket	1996			G31526	1
	1994-1995		California	G31526	1

LIGHT TRUCK

Mitsubishi Truck

4 (cont.)	2351CC (2.4L) 4G64 SOHC 8 Valve Mitsubishi 4 Cyl, 3.406in./86.5mm (1989-1996)				4 (cont.)
---------------------	--	--	--	--	---------------------

Part	Year	VIN	Model/Application	Part Number	Qty.
------	------	-----	-------------------	-------------	------

MISCELLANEOUS GASKETS (cont.)

Throttle Body Gasket (cont.)	1993-1995		Except California	G31115	1
	1990-1992			G31115	1
	1989			G30808	1
Valve Cover Grommet	1989-1996			B45729	2
Water Outlet Gasket	1989-1996			C24082	1
Water Pump Mount Gasket	1989-1994			K30615	1

5	2351CC (2.4L) G64B SOHC Mitsubishi 4 Cyl, 3.406in./86.5mm (1987-1988)				5
----------	--	--	--	--	----------

Part	Year	VIN	Model/Application	Part Number	Qty.
------	------	-----	-------------------	-------------	------

ENGINE GASKETS

Head Set	1987-1988		(Jet Valve Seals Not Included, Exhaust Pipe Gasket Not Included)	HS5747X	1
Full Set	1987-1988		(Jet Valve Seals Not Included, Exhaust Pipe Gasket Not Included)	FS5747X	1
Cylinder Head Gasket	1987-1988		<i>Nitroseal</i>	5747	1
Valve Cover Set	1987-1988		(Valve Cover Grommets Not Included, Camshaft Semi Circular Plug Not Included) <i>Victo-Tech</i>	VS40003	1
			(Contains Valve Cover Grommets, Contains Camshaft Semi Circular Plug) <i>Victo-Tech</i>	VS40003CP	1
Valve Stem Seal, Exh.	1987-1988		(Original Equipment Type)	B45441	4
			(Premium)	B45806	4
Valve Stem Seal, Int.	1987-1988		(Original Equipment Type)	B45441	4
			(Premium)	B45806	4
Manifold Set, Exhaust	1987-1988			MS15389	1
Manifold Set, Intake	1987-1988			MS15387	1
Plenum Chamber Gasket	1987-1988			MS12339	1
Oil Pan Set	1987-1988		<i>Cork Rubber</i>	OS32008	1
Rear Main Seal Set	1987-1988			JV534	1
Timing Cover Set	1987-1988			JV1036	1
Timing Cover Seal	1987-1988			47730	1

MISCELLANEOUS GASKETS

Air Flow Sensor	1987-1988			G30807	1
Camshaft Seal	1987-1988			47918	1
Cam. Semi-Circular Plug	1987-1988			B24180	1
E.G.R. Gasket	1987-1988		<i>Nitroseal</i>	G30714	1
Exhaust Pipe Gasket	1987-1988		(Flange Type), Pipe To Manifold	F12287	1
Jet Valve Seal	1987-1988			B45471	4
Throttle Body Gasket	1987-1988			G30806	1
Valve Cover Grommet	1987-1988			B45729	2
Water Outlet Gasket	1987-1988			C24082	1
Water Pump Mount Gasket	1987-1988			K30615	1

6	2555CC (2.6L) G54B Mitsubishi 4 Cyl, 3.587in./91.1mm (1983-1989)				6
----------	---	--	--	--	----------

Part	Year	VIN	Model/Application	Part Number	Qty.
------	------	-----	-------------------	-------------	------

ENGINE GASKETS

Head Set	1983-1989		(Exhaust Pipe Gasket Not Included)	HS3697W	1
Full Set	1983-1989		(Exhaust Pipe Gasket Not Included)	FS3697W	1
Engine Kit Gasket Set	1983-1989		2 Barrel Carburetor	95-3104VR	1
Cylinder Head Gasket	1983-1989		<i>VR2000</i>	3697	1
Cyl. Head Spacer Shim	1983-1989		Requires Sealing Compound <i>Steel</i>	3697S	1
Sealing Compound	1983-1989		(4 Ounce Brush Top Can)	JV66B	1

6 2555CC (2.6L) G54B Mitsubishi 4 Cyl, 3.587in./91.1mm (1983-1989) **6**
(cont.) (cont.)

Part Year VIN Model/Application Part Number Qty.

ENGINE GASKETS (cont.)

Sealing Compound (cont.)	1983-1989		(12 Ounce Spray Can)	JV66S	1
Valve Cover Set	1983-1989		(Valve Cover Grommets Not Included, Camshaft Semi Circular Plug Not Included)	<i>Victo-Tech</i> VS39865	1
			(Contains Valve Cover Grommets, Contains Camshaft Semi Circular Plug)	<i>Victo-Tech</i> VS39865CP	1
Valve Stem Seal, Exh.	1983-1989		(Original Equipment Type)	B45441	4
			(Premium)	B45806	4
Valve Stem Seal, Int.	1983-1989		(Original Equipment Type)	B45441	4
			(Premium)	B45806	4
Manifold Set, Exhaust	1983-1989			MS15299	1
Manifold Set, Intake	1983-1989			<i>Performaseal</i> MS15320	1
Oil Pan Set	1983-1989			<i>Cork Rubber</i> OS20776	1
Rear Main Seal Set	1983-1989			JV534	1
Crank Repair Sleeve	1983-1989		Use With Part Number A512, Rear <i>Nickel Plated Formed Steel, .013" Thickness</i>	A346	1
Timing Cover Set	1983-1989			JV943	1
Timing Cover Seal	1983-1989			47735	1
Harmonic Balancer Repair Sleeve	1983-1989		Use With Part Number A500 <i>Nickel Plated Formed Steel, .013" Thickness</i>	A238	1

MISCELLANEOUS GASKETS

Air Cleaner Mount Gasket	1983-1989			G24965	1
Cam. Circular Plug	1983-1989			B45685	1
Cam. Semi-Circular Plug	1983-1989			B24180	1
Carb. Mount Gasket	1987-1989		2 Barrel Carburetor	G30713	1
	1983-1986		2 Barrel Carburetor	G25771	1
E.G.R. Gasket	1987-1989			<i>Nitroseal</i> G30714	1
	1983-1986			G24078	1
Exhaust Pipe Gasket	1987-1989		(Flange Type), Pipe To Manifold	F12287	1
	1987-1988		(Flange Type), Catalytic Converter To Center Pipe	F7422	1
	1983-1986		(Flange Type), Pipe To Manifold	F7409	1
			(Ring Type 'F'), Catalytic Converter To Exhaust Pipe	F7424	1
Fuel Pump Gasket	1983-1989			D24076	2
Jet Valve Seal	1983-1989			B45471	4
Valve Cover Grommet	1983-1989			B45729	2
Water Outlet Gasket	1983-1989			C24082	1
Water Pipe O-Ring	1983-1989			B45797	1
Water Pump Mount Gasket	1983-1989			K26487	1

7 2972CC (3.0L) 6G72 SOHC 12 Valve Mitsubishi V6 Cyl, 3.587in./91.1mm (1989-1997) **7**

Part Year VIN Model/Application Part Number Qty.

ENGINE GASKETS

Head Set	1989-1995		(Exhaust Pipe Gasket Not Included)	HS5765-2	1
Lower Set	1989-1995		(Requires Head Set To Make Full Set)	CS5765-1	1
Engine Kit Gasket Set	1989-1995			95-3192VR	1
Cylinder Head Gasket	1989-1997			<i>Nitroseal</i> 5765	2
Cyl. Head Bolt Set	1989-1997			GS33327	1
Cyl. Head Spacer Shim	1989-1995		Requires Sealing Compound	<i>Steel</i> 5765S	2
Sealing Compound	1989-1995		(4 Ounce Brush Top Can)	JV66B	1
			(12 Ounce Spray Can)	JV66S	1
Valve Cover Set	1996-1997		Montero, (Contains Valve Cover Washers)	<i>Victo-Tech</i> VS50054	1
			Montero, (Valve Cover Grommets Not Included, Camshaft Circular Plug Not Included)	<i>Victo-Tech</i> VS50256	1

LIGHT TRUCK

Mitsubishi Truck

7 2972CC (3.0L) 6G72 SOHC 12 Valve Mitsubishi V6 Cyl, 3.587in./91.1mm (1989-1997) **7**
(cont.) (cont.)

Part	Year	VIN	Model/Application	Part Number	Qty.
ENGINE GASKETS (cont.)					
Valve Cover Set (cont.)	1996-1997		Montero, (Contains Valve Cover Grommets, Contains Camshaft Circular Plugs) <i>Victo-Tech</i>	VS50257	1
	1995		Mighty Max, (Contains Valve Cover Grommets) <i>Victo-Tech</i>	VS50054	1
			Mighty Max, (Valve Cover Grommets Not Included, Camshaft Circular Plug Not Included) <i>Victo-Tech</i>	VS50256	1
			Mighty Max, (Contains Valve Cover Grommets, Contains Camshaft Circular Plugs, Contains Camshaft Semi Circular Plug) <i>Victo-Tech</i>	VS50257	1
	1989-1994		(Contains Valve Cover Grommets) <i>Victo-Tech</i>	VS50054	1
			(Valve Cover Grommets Not Included, Camshaft Circular Plug Not Included) <i>Victo-Tech</i>	VS50256	1
		(Contains Valve Cover Grommets, Contains Camshaft Circular Plugs, Contains Camshaft Semi Circular Plug) <i>Victo-Tech</i>	VS50257	1	
Valve Stem Seal, Exh.	1989-1997		<i>Fluoroelastomer</i>	B45790	6
	1992		Thru 9/92, (Original Equipment Type)	B45441	6
	1989-1991		(Original Equipment Type)	B45441	6
Valve Stem Seal, Int.	1989-1997		<i>Fluoroelastomer</i>	B45790	6
	1992		Thru 9/92, (Original Equipment Type)	B45441	6
	1989-1991		(Original Equipment Type)	B45441	6
Manifold Set, Exhaust	1989-1995			MS15543	1
Manifold Set, Intake	1989-1997		(Contains Plenum Chamber Gasket)	MS15444X	1
Plenum Chamber Gasket	1989-1997			MS15982	1
Oil Pan Set	1989-1995		<i>Cork Rubber</i>	OS32054	1
Rear Main Seal Set	1989-1997			JV1062	1
Crank Repair Sleeve	1989-1995		Use With Part Number A505, Rear <i>Nickel Plated Formed Steel, .013" Thickness</i>	A342	1
			Front <i>Nickel Plated Formed Steel, .013" Thickness</i>	A357	1
Timing Cover Set	1989-1995			JV1118	1

MISCELLANEOUS GASKETS

Air Flow Sensor	1989-1990			G30807	1
Cam. Circular Plug	1989-1997			B45682	2
Camshaft Seal	1990-1997			47918	2
Exhaust Pipe Gasket	1996-1997		(Flange Type), Catalytic Converter To Center Pipe, Pipe To Manifold	F7409	3
	1989-1995		(Flange Type), Pipe To Manifold	F7409	2
Therm. Mount Gasket	1996-1997			C24082	1
Throttle Body Gasket	1989-1996			G31558	1
Valve Cover Grommet	1989-1995			B45729	4
Water Outlet Gasket	1989-1995			C24082	1
Water Pipe O-Ring	1989-1995			B45797	2
Water Pump Mount Gasket	1989-1997		Adapter To Block	K30816	1
	1989-1995		Pump To Adapter	K31160	1

8 2972CC (3.0L) 6G72 SOHC 24 Valve Mitsubishi V6 Cyl, 3.587in./91.1mm (1994-2001) **8**

Part	Year	VIN	Model/Application	Part Number	Qty.
ENGINE GASKETS					
Cyl. Head Bolt Set	1996-2001			GS33327	1
Valve Cover Set	1994-2001		(Contains Spark Plug Tube Seals) <i>Victo-Tech</i>	VS50270	1
Manifold Set, Exhaust	1996-2001			MS16267	1
Manifold Set, Intake	1994-2001		(Contains Plenum Chamber Gasket)	MS16266	1
Rear Main Seal Set	1996-2001			JV1062	1
MISCELLANEOUS GASKETS					
Camshaft Seal	1994-2001			47918	2
Exhaust Pipe Gasket	1997-2001		(Flange Type), Pipe To Manifold	F7409	2

8 2972CC (3.0L) 6G72 SOHC 24 Valve Mitsubishi V6 Cyl, 3.587in./91.1mm (1994-2001) **8**
(cont.) (cont.)

Part	Year	VIN	Model/Application	Part Number	Qty.
MISCELLANEOUS GASKETS (cont.)					
Exhaust Pipe Gasket (cont.)	1997-2001		Muffler To Tailpipe	F10120	1
	1997-2000		(Flange Type), Catalytic Converter To Center Pipe, Catalytic Converter To Front Exhaust Pipe	F7409	2
	1997		(Flange Type), Catalytic Converter To Center Pipe, Catalytic Converter To Front Exhaust Pipe, Pipe To Manifold	F7409	2
	1994-1996		(Flange Type), Catalytic Converter To Center Pipe, Pipe To Manifold	F7409	3
Fuel Inj. O-Ring	1994-2001			72011	1
Throttle Body Gasket	1994-2001			G31567	1
Water Pipe O-Ring	1994-2001			B45797	2

9 3497CC (3.5L) 6G74 DOHC Mitsubishi V6 Cyl, 3.661in./93mm (1994-1996) **9**

Part	Year	VIN	Model/Application	Part Number	Qty.
ENGINE GASKETS					
Head Set	1994-1996		(Head Bolts Not Included, Exhaust Pipe Gasket Not Included)	HS54142	1
Lower Set	1994-1996		(Requires Head Set To Make Full Set)	CS54142	1
Cylinder Head Gasket	1994-1996		<i>Nitroseal</i>	54142G	2
Valve Cover Set	1994-1996		(Contains Spark Plug Tube Seals) <i>Victo-Tech</i>	VS50269	1
Valve Stem Seal, Exh.	1994-1996			B45883	12
Valve Stem Seal, Int.	1994-1996			B45883	12
Manifold Set, Exhaust	1994-1996		<i>Nitroseal</i>	MS16265	1
Manifold Set, Intake	1994-1996		(Contains Plenum Chamber Gasket)	MS16264	1
Oil Pan Set	1994-1996		<i>Cork Rubber</i>	OS32194	1
Rear Main Seal Set	1994-1996			JV1649	1
MISCELLANEOUS GASKETS					
Injector Nozzle O-Ring	1994-1996			GS33339	1
Spark Plug Tube Seal	1994-1996			B45884	1
Throttle Body Gasket	1994-1996			G31567	1

10 3497CC (3.5L) 6G74 SOHC Mitsubishi V6 Cyl, 3.661in./93mm (1997-2000) **10**

Part	Year	VIN	Model/Application	Part Number	Qty.
ENGINE GASKETS					
Head Set	1997-2000		(Head Bolts Not Included, Exhaust Pipe Gasket Not Included)	HS54143	1
Lower Set	1997-2000		(Requires Head Set To Make Full Set)	CS54142	1
Cylinder Head Gasket	1997-2000		<i>Multi-Layered Steel</i>	54143S	2
Valve Cover Set	1997-2000		(Contains Spark Plug Tube Seals) <i>Victo-Tech</i>	VS50270	1
Valve Stem Seal, Exh.	1997-2000			B45870A	12
Valve Stem Seal, Int.	1997-2000			B45870A	12
Manifold Set, Exhaust	1997-2000		<i>Multi-Layered Steel</i>	MS16267	1
Manifold Set, Intake	1997-2000		(Contains Plenum Chamber Gasket)	MS16266	1
Oil Pan Set	1997-2000		<i>Cork Rubber</i>	OS32194	1
Rear Main Seal Set	1997-2000			JV1649	1
MISCELLANEOUS GASKETS					
Injector Nozzle O-Ring	1997-2000			GS33340	1
Spark Plug Tube Seal	1997-2000			B45881-A	1
Throttle Body Gasket	1997-2000			G31567	1

Navistar/International

Engine Index

Engine	Year	Block
133 CID (2.2L) FC Waukesha	1937-1940	1
133 CID (2.2L) FK Waukesha	1936-1937	2
152 CID (2.5L) 4-152 International	1967-1968	3
152 CID (2.5L) Comanche Four International	1961-1967	4
152 CID (2.5L) Turbo III International	1965-1967	5
175 CID (2.9L) GRD175/HD174 International	1938-1942	6
196 CID (3.2L) 4-196 International	1966-1980	7
220 CID (3.6L) BD220 International	1957-1962	8
220 CID (3.6L) BG220 International	1963-1968	9
220 CID (3.6L) SD220 International	1950-1957	10
220 CID (3.6L) SD220 International LPG	1953-1954	11
232 CID (3.8L) PT6 International	1969-1972	12
233 CID (3.8L) GRD233 International	1941-1949	13
233 CID (3.8L) HD232 International	1937-1941	14
240 CID (3.9L) BD240 International	1955-1962	15
240 CID (3.9L) SD240 International	1950-1969	16
240 CID (3.9L) SD240 International LPG	1953-1955	17
241 CID (3.9L) FAB International	1937-1941	18
241 CID (3.9L) FAC International	1941-1947	19
241 CID (3.9L) BG241 International	1965-1966	20
241 CID (3.9L) BG241 International LPG	1963-1969	21
250 CID (4.1L) BLD250 International	1941-1949	22
258 CID (4.2L) American Motors Co.	1972-1974	23
259 CID (4.2L) FAB International	1939-1940	24
264 CID (4.3L) BD264 International	1955-1968	25
265 CID (4.3L) BG265 International	1955-1968	26
266 CID (4.4L) V266 International	1959-1972	27
269 CID (4.4L) BLD269 International	1955-1956	28
282 CID (4.6L) BD282 International	1957-1962	29
301 CID (4.9L) D301 International Diesel	1960-1969	30
304 CID (5.0L) V304 International	1959-1980	31
304 CID (5.0L) V304 International LPG	1964-1975	32

Engine	Year	Block
308 CID (5.0L) BD308 International	1957-1971	33
345 CID (5.6L) V345 International	1959-1982	34
345 CID (5.6L) V345LPG International LPG	1962-1982	35
361 CID (5.9L) FBB361 International	1937-1941	36
372 CID (6.1L) RD372 International	1950-1968	37
392 CID (6.4L) V392 International	1969-1982	38
400 CID (6.6L) V400 International	1974-1975	39
401 CID (6.6L) V401 International	1956-1972	40
401 CID (6.6L) VS401 International	1968-1974	41
404 CID (6.6L) MV404 International	1975-1982	42
406 CID (6.7L) RD406 International	1952-1974	43
420 CID (6.9L) Navistar Diesel	1983-1987	44
444 CID (7.3L) Indirect Injection International Diesel	1988-1994	45
444 CID (7.3L) T444E (Power Stroke) International Diesel	1994-2001	46
446 CID (7.3L) MV446 International	1975-1981	47
450 CID (7.4L) FBC450 International	1941-1943	48
450 CID (7.4L) RD450 International	1955-1974	49
450 CID (7.4L) RED450 International	1944-1957	50
461 CID (7.6L) V461 International	1956-1964	51
478 CID (7.8L) V478 International	1965-1972	52
478 CID (7.8L) VS478 International	1968-1977	53
501 CID (8.2L) RD501 International	1955-1974	54
501 CID (8.2L) RD501LPG International LPG	1955-1972	55
537 CID (8.8L) V537 International	1978-1981	56
537 CID (8.8L) VS537 International	1975-1981	57
549 CID (9.0L) FTV549 International	1970-1972	58
549 CID (9.0L) FTVS549 International	1970-1975	59
549 CID (9.0L) V549 International	1956-1972	60
549 CID (9.0L) VS549 International	1968-1978	61

Model Index

Model	Engine	Year	Block
100	258 CID (4.2L) American Motors Co.	1974	23
100	345 CID (5.6L) V345 International	1974	34
100	392 CID (6.4L) V392 International	1974	38
100	400 CID (6.6L) V400 International	1973-1974	39
150	345 CID (5.6L) V345 International	1975	34
150	392 CID (6.4L) V392 International	1975	38
183RE	345 CID (5.6L) V345 International	1970	34
193RE	401 CID (6.6L) V401 International	1962-1972	40
200	258 CID (4.2L) American Motors Co.	1974	23
200	345 CID (5.6L) V345 International	1974	34
200	392 CID (6.4L) V392 International	1974-1975	38
200	400 CID (6.6L) V400 International	1973-1975	39
900A	152 CID (2.5L) 4-152 International	1967	3
900A	152 CID (2.5L) Turbo III International	1966	5
900A	152 CID (2.5L) Comanche Four International	1966-1967	4
908B	266 CID (4.4L) V266 International	1967	27
908C	266 CID (4.4L) V266 International	1968	27
1000A	241 CID (3.9L) BG241 International	1966	21

Model	Engine	Year	Block
1000A	266 CID (4.4L) V266 International	1966	27
1000A	304 CID (5.0L) V304 International	1966	32
1000B	241 CID (3.9L) BG241 International	1967	21
1000B	266 CID (4.4L) V266 International	1967	27
1000C	241 CID (3.9L) BG241 International	1968	21
1000C	266 CID (4.4L) V266 International	1968	27
1000D	232 CID (3.8L) PT6 International	1969-1971	12
1000D	304 CID (5.0L) V304 International	1969-1971	32
1000D	392 CID (6.4L) V392 International	1969-1971	38
1010	258 CID (4.2L) American Motors Co.	1971-1973	23
1010	304 CID (5.0L) V304 International	1971-1973	31
1100A	241 CID (3.9L) BG241 International	1966	20
1100A	241 CID (3.9L) BG241 International	1966	21
1100A	266 CID (4.4L) V266 International	1966	27
1100A	304 CID (5.0L) V304 International	1966	32
1100A	304 CID (5.0L) V304 International	1966	31
1100B	241 CID (3.9L) BG241 International	1967	21
1100B	266 CID (4.4L) V266 International	1967	27

Navistar/International

Model Index (cont.)

Model	Engine	Year	Block	Model	Engine	Year	Block
1100C	241 CID (3.9L) BG241 International	1968	21	1300D	241 CID (3.9L) BG241 International	1969-1970	21
1100C	266 CID (4.4L) V266 International	1968	27	1300D	266 CID (4.4L) V266 International	1969-1970	27
1100D	232 CID (3.8L) PT6 International	1969-1971	12	1300D	304 CID (5.0L) V304 International	1969-1971	32
1100D	241 CID (3.9L) BG241 International	1969-1970	21	1300D	304 CID (5.0L) V304 International	1969-1971	31
1100D	304 CID (5.0L) V304 International	1969-1971	32	1300D	392 CID (6.4L) V392 International	1969-1971	38
1100D	392 CID (6.4L) V392 International	1969-1971	38	1310	258 CID (4.2L) American Motors Co.	1972-1973	23
1110	258 CID (4.2L) American Motors Co.	1972-1973	23	1310	304 CID (5.0L) V304 International	1972-1973	32
1110	304 CID (5.0L) V304 International	1971-1973	31	1310	304 CID (5.0L) V304 International	1972-1973	31
1110	345 CID (5.6L) V345 International	1971-1973	34	1310	345 CID (5.6L) V345 International	1972-1973	34
1110	392 CID (6.4L) V392 International	1972-1973	38	1310	392 CID (6.4L) V392 International	1972-1973	38
1200A	241 CID (3.9L) BG241 International	1966	21	1400 Metro II	420 CID (6.9L) Navistar Diesel	1987	44
1200A	266 CID (4.4L) V266 International	1966	27	1400 Metro II	444 CID (7.3L) Indirect Injection International Diesel	1988-1989	45
1200A	304 CID (5.0L) V304 International	1966	32	1452SC	444 CID (7.3L) Indirect Injection International Diesel	1988-1992	45
1200A	304 CID (5.0L) V304 International	1966	31	1600	240 CID (3.9L) BD240 International	1962	15
1200B	241 CID (3.9L) BG241 International	1967	21	1600	240 CID (3.9L) SD240 International	1962-1969	16
1200B	266 CID (4.4L) V266 International	1967	27	1600	264 CID (4.3L) BD264 International	1962-1969	25
1200C	241 CID (3.9L) BG241 International	1968	21	1600	265 CID (4.3L) BG265 International	1962-1969	26
1200C	266 CID (4.4L) V266 International	1968	27	1600	266 CID (4.4L) V266 International	1970-1975	27
1200D	241 CID (3.9L) BG241 International	1969-1970	21	1600	301 CID (4.9L) D301 International Diesel	1962-1975	30
1200D	266 CID (4.4L) V266 International	1969-1970	27	1600	304 CID (5.0L) V304 International	1964-1975	32
1200D	304 CID (5.0L) V304 International	1969-1971	32	1600	304 CID (5.0L) V304 International	1962-1975	31
1200D	392 CID (6.4L) V392 International	1969-1971	38	1600	308 CID (5.0L) BD308 International	1970-1975	33
1210	258 CID (4.2L) American Motors Co.	1971-1973	23	1600	345 CID (5.6L) V345LPG International	1970-1978	35
1210	304 CID (5.0L) V304 International	1971-1973	31	1600	345 CID (5.6L) V345 International	1970-1978	34
1210	345 CID (5.6L) V345 International	1971-1973	34	1600 Metro II	420 CID (6.9L) Navistar Diesel	1987	44
1210	392 CID (6.4L) V392 International	1971-1973	38	1600 Metro II	444 CID (7.3L) Indirect Injection International Diesel	1988-1989	45
1300A	241 CID (3.9L) BG241 International	1966	21	1603	240 CID (3.9L) BD240 International	1962	15
1300A	304 CID (5.0L) V304 International	1966	32	1603	240 CID (3.9L) SD240 International	1962-1969	16
1300A	304 CID (5.0L) V304 International	1966	31	1603	264 CID (4.3L) BD264 International	1962-1969	25
1300B	241 CID (3.9L) BG241 International	1967	21	1603	265 CID (4.3L) BG265 International	1962-1969	26
1300B	266 CID (4.4L) V266 International	1967	27	1603	301 CID (4.9L) D301 International Diesel	1962-1965	30
1300C	241 CID (3.9L) BG241 International	1968	21	1603	304 CID (5.0L) V304 International	1964-1975	32
1300C	266 CID (4.4L) V266 International	1968	27	1603	304 CID (5.0L) V304 International	1973-1975	31
1300C	304 CID (5.0L) V304 International	1968	32	1603	345 CID (5.6L) V345 International	1976-1978	34
1300C	304 CID (5.0L) V304 International	1968	31	1610FC	345 CID (5.6L) V345 International	1978	34
1300D	232 CID (3.8L) PT6 International	1969-1971	12	1610FC	392 CID (6.4L) V392 International	1978-1979	38
				1624	345 CID (5.6L) V345 International	1979-1982	34

Navistar/International

Model Index (cont.)

Model	Engine	Year	Block	Model	Engine	Year	Block
1652SC	420 CID (6.9L) Navistar Diesel	1987	44	1824	392 CID (6.4L) V392	1980-1982	38
1652SC	444 CID (7.3L) T444E (Power Stroke) International Diesel	1994-2001	46	1824	404 CID (6.6L) MV404 International	1979-1982	42
1652SC	444 CID (7.3L) Indirect Injection International Diesel	1988-1995	45	1824	446 CID (7.3L) MV446 International	1979-1981	47
1654	420 CID (6.9L) Navistar Diesel	1983-1987	44	1853	372 CID (6.1L) RD372 International	1964-1968	37
1654	444 CID (7.3L) Indirect Injection International Diesel	1988-1989	45	1853	406 CID (6.7L) RD406 International	1964-1977	43
1654LP	444 CID (7.3L) Indirect Injection International Diesel	1989	45	1853	420 CID (6.9L) Navistar Diesel	1980-1988	44
1700	301 CID (4.9L) D301 International Diesel	1962-1978	30	1853	450 CID (7.4L) RD450 International	1964-1974	49
1700	304 CID (5.0L) V304 International	1964-1974	32	1853FC	372 CID (6.1L) RD372 International	1962-1968	37
1700	308 CID (5.0L) BD308 International	1962-1975	33	1853FC	406 CID (6.7L) RD406 International	1962-1977	43
1700	345 CID (5.6L) V345 International	1970-1978	34	1890	308 CID (5.0L) BD308 International	1970-1971	33
1700	404 CID (6.6L) MV404 International	1975-1978	42	1890	345 CID (5.6L) V345 International	1970-1971	34
1703	304 CID (5.0L) V304 International	1964-1975	32	1890	392 CID (6.4L) V392 International	1970-1971	38
1703	304 CID (5.0L) V304 International	1973-1975	31	1910A	401 CID (6.6L) VS401 International	1970-1972	41
1703	308 CID (5.0L) BD308 International	1962-1975	33	1910A	406 CID (6.7L) RD406 International	1969-1972	43
1703	345 CID (5.6L) V345 International	1976-1978	34	1910A	450 CID (7.4L) RD450 International	1969-1972	49
1703	392 CID (6.4L) V392 International	1976-1978	38	1910A	478 CID (7.8L) VS478 International	1969-1972	53
1723	345 CID (5.6L) V345LPG International	1982	35	1910A	549 CID (9.0L) VS549 International	1969-1972	61
1723	345 CID (5.6L) V345 International	1979-1982	34	1924	404 CID (6.6L) MV404 International	1979-1982	42
1723	392 CID (6.4L) V392 International	1980-1982	38	1924	446 CID (7.3L) MV446 International	1979-1981	47
1723	404 CID (6.6L) MV404 International	1979-1981	42	1925	404 CID (6.6L) MV404 International	1979-1982	42
1724	345 CID (5.6L) V345 International	1979-1982	34	1925	446 CID (7.3L) MV446 International	1979-1981	47
1724	392 CID (6.4L) V392 International	1980-1982	38	2010A	401 CID (6.6L) VS401 International	1968-1975	41
1724	404 CID (6.6L) MV404 International	1979-1982	42	2010A	406 CID (6.7L) RD406 International	1968-1969	43
1753	444 CID (7.3L) Indirect Injection International Diesel	1988-1989	45	2010A	450 CID (7.4L) RD450 International	1968-1974	49
1800	301 CID (4.9L) D301 International Diesel	1962-1975	30	2010A	478 CID (7.8L) VS478 International	1968-1977	53
1800	308 CID (5.0L) BD308 International	1962-1975	33	2010A	501 CID (8.2L) RD501 International	1970-1974	54
1800	345 CID (5.6L) V345LPG International	1962-1978	35	2010A	537 CID (8.8L) VS537 International	1975-1978	57
1800	345 CID (5.6L) V345 International	1962-1978	34	2010A	549 CID (9.0L) FTVS549 International	1970-1975	59
1800	392 CID (6.4L) V392 International	1975-1978	38	2010A	549 CID (9.0L) VS549 International	1968-1978	61
1800	404 CID (6.6L) MV404 International	1975-1978	42	2110A	450 CID (7.4L) RD450 International	1968-1973	49
1800	446 CID (7.3L) MV446 International	1975-1978	47	2125	537 CID (8.8L) V537 International	1979-1981	56
1803	308 CID (5.0L) BD308 International	1962-1975	33	2524	537 CID (8.8L) V537 International	1978-1981	56
1803	345 CID (5.6L) V345 International	1962-1978	34	3700	444 CID (7.3L) Indirect Injection International Diesel	1990-1994	45
1803	392 CID (6.4L) V392 International	1976-1978	38	4600	444 CID (7.3L) T444E (Power Stroke) International Diesel	1995	46
1823	404 CID (6.6L) MV404 International	1979-1981	42	4600	444 CID (7.3L) Indirect Injection International Diesel	1990-1995	45
1823	446 CID (7.3L) MV446 International	1979-1981	47	4600LP	444 CID (7.3L) T444E (Power Stroke) International Diesel	1995	46
1824	345 CID (5.6L) V345 International	1979-1982	34				

LIGHT TRUCK

Navistar/International

Model Index (cont.)

Model	Engine	Year	Block	Model	Engine	Year	Block
4600LP	444 CID (7.3L) Indirect Injection International Diesel	1990-1995	45	B120	240 CID (3.9L) BD240 International	1959-1960	15
A100	220 CID (3.6L) BD220 International	1957-1958	8	B120	264 CID (4.3L) BD264 International	1959-1960	25
A100	240 CID (3.9L) BD240 International	1957-1958	15	B120	266 CID (4.4L) V266 International	1959-1960	27
A100	264 CID (4.3L) BD264 International	1957-1958	25	B130	240 CID (3.9L) BD240 International	1959-1960	15
A110	240 CID (3.9L) BD240 International	1957-1958	15	B130	264 CID (4.3L) BD264 International	1959-1960	25
A110	264 CID (4.3L) BD264 International	1957-1958	25	B130	266 CID (4.4L) V266 International	1959-1960	27
A120	240 CID (3.9L) BD240 International	1957-1958	15	B-140 Series	240 CID (3.9L) BD240 International	1959-1962	15
A120	264 CID (4.3L) BD264 International	1957-1958	25	B-140 Series	266 CID (4.4L) V266 International	1959-1963	27
A130	240 CID (3.9L) BD240 International	1957-1958	15	B-150 Series	240 CID (3.9L) BD240 International	1959-1962	15
A130	264 CID (4.3L) BD264 International	1957-1958	25	B-150 Series	266 CID (4.4L) V266 International	1959-1963	27
A-140 Series	240 CID (3.9L) BD240 International	1957-1959	15	B-153	264 CID (4.3L) BD264 International	1959-1962	25
A-150 Series	240 CID (3.9L) BD240 International	1957-1959	15	B-153	266 CID (4.4L) V266 International	1959-1963	27
A-153	264 CID (4.3L) BD264 International	1957-1959	25	B-160 Series	264 CID (4.3L) BD264 International	1959-1962	25
A-160 Series	264 CID (4.3L) BD264 International	1957-1959	25	B-160 Series	301 CID (4.9L) D301 International Diesel	1960-1963	30
A-163	264 CID (4.3L) BD264 International	1957-1959	25	B-160 Series	304 CID (5.0L) V304 International	1959-1963	31
A-173	282 CID (4.6L) BD282 International	1957-1959	29	B-163	264 CID (4.3L) BD264 International	1959-1962	25
A-183	308 CID (5.0L) BD308 International	1957-1959	33	B-163	304 CID (5.0L) V304 International	1959-1962	31
AB120	220 CID (3.6L) BG220 International	1963-1965	9	B-173	282 CID (4.6L) BD282 International	1959-1962	29
AB120	220 CID (3.6L) BD220 International	1957-1962	8	B-173	304 CID (5.0L) V304 International	1959-1962	31
AB120	240 CID (3.9L) BD240 International	1957-1962	15	B-183	308 CID (5.0L) BD308 International	1959-1962	33
AB120	241 CID (3.9L) BG241 International	1963-1965	21	B-183	345 CID (5.6L) V345 International	1959-1962	34
AM80	240 CID (3.9L) BD240 International	1957-1962	15	Binder	345 CID (5.6L) V345 International	1977-1978	34
AM120	220 CID (3.6L) BG220 International	1963-1965	9	C5	133 CID (2.2L) FK Waukesha	1936-1937	2
AM120	220 CID (3.6L) BD220 International	1957-1962	8	C100	240 CID (3.9L) BD240 International	1961-1962	15
AM120	240 CID (3.9L) BD240 International	1957-1962	15	C100	266 CID (4.4L) V266 International	1961-1962	27
AM120	241 CID (3.9L) BG241 International	1963-1965	21	C110	240 CID (3.9L) BD240 International	1961-1962	15
AM130	220 CID (3.6L) BG220 International	1963-1965	9	C110	266 CID (4.4L) V266 International	1961-1962	27
AM130	220 CID (3.6L) BD220 International	1957-1962	8	C120	240 CID (3.9L) BD240 International	1961-1962	15
AM130	240 CID (3.9L) BD240 International	1957-1962	15	C120	266 CID (4.4L) V266 International	1961-1962	27
AM130	241 CID (3.9L) BG241 International	1963-1965	21	C130	240 CID (3.9L) BD240 International	1961-1962	15
AM170	265 CID (4.3L) BG265 International	1964-1966	26	C130	266 CID (4.4L) V266 International	1961-1962	27
B100	220 CID (3.6L) BD220 International	1959-1960	8	C405L	406 CID (6.7L) RD406 International	1956-1957	43
B100	266 CID (4.4L) V266 International	1959-1960	27	C405L	450 CID (7.4L) RED450 International	1956-1957	50
B110	240 CID (3.9L) BD240 International	1959-1960	15	C405L	501 CID (8.2L) RD501 International	1956-1957	54
B110	264 CID (4.3L) BD264 International	1959-1960	25	C900	152 CID (2.5L) Comanche Four International	1964	4
B110	266 CID (4.4L) V266 International	1959-1960	27	C1000	241 CID (3.9L) BG241 International	1963-1964	21

Navistar/International

Model Index (cont.)

Model	Engine	Year	Block	Model	Engine	Year	Block
C1000	266 CID (4.4L) V266 International	1963-1964	27	CO1600	240 CID (3.9L) SD240 International	1953-1955	17
C1000	304 CID (5.0L) V304 International	1964	32	CO1600	240 CID (3.9L) SD240 International	1950-1969	16
C1100	241 CID (3.9L) BG241 International	1963-1964	21	CO1600	264 CID (4.3L) BD264 International	1955-1969	25
C1100	266 CID (4.4L) V266 International	1963-1964	27	CO1600	265 CID (4.3L) BG265 International	1955-1969	26
C1100	304 CID (5.0L) V304 International	1964	32	CO1600	266 CID (4.4L) V266 International	1970-1971	27
C1100	304 CID (5.0L) V304 International	1964	31	CO1600	304 CID (5.0L) V304 International	1970-1971	32
C1200	241 CID (3.9L) BG241 International	1963-1964	21	CO1600	304 CID (5.0L) V304 International	1970-1971	31
C1200	266 CID (4.4L) V266 International	1963-1964	27	CO1600	345 CID (5.6L) V345 International	1970-1971	34
C1200	304 CID (5.0L) V304 International	1964	32	CO1610B	345 CID (5.6L) V345LPG International	1982	35
C1200	304 CID (5.0L) V304 International	1964	31	CO1610B	345 CID (5.6L) V345 International	1975-1982	34
C1300	241 CID (3.9L) BG241 International	1963-1964	21	CO1610B	392 CID (6.4L) V392 International	1980-1982	38
C1300	266 CID (4.4L) V266 International	1963-1964	27	CO1650B	420 CID (6.9L) Navistar Diesel	1985-1986	44
C1300	304 CID (5.0L) V304 International	1964	32	CO1700	304 CID (5.0L) V304 International	1970-1971	32
C1300	304 CID (5.0L) V304 International	1964	31	CO1700	304 CID (5.0L) V304 International	1970-1971	31
CM75	152 CID (2.5L) Comanche Four International	1963-1965	4	CO1700	345 CID (5.6L) V345 International	1970-1971	34
CM75	220 CID (3.6L) BG220 International	1963-1965	9	CO1700	392 CID (6.4L) V392 International	1970-1971	38
CM80	152 CID (2.5L) Comanche Four International	1963-1965	4	CO1710B	345 CID (5.6L) V345LPG International	1982	35
CM80	220 CID (3.6L) BG220 International	1963-1965	9	CO1710B	345 CID (5.6L) V345 International	1982	34
CM110	152 CID (2.5L) Comanche Four International	1963-1965	4	CO1710B	392 CID (6.4L) V392 International	1982	38
CM110	220 CID (3.6L) BG220 International	1963-1965	9	CO1710B	404 CID (6.6L) MV404 International	1975-1981	42
CM112	152 CID (2.5L) Comanche Four International	1963	4	CO1800	345 CID (5.6L) V345 International	1970-1971	34
CO190	406 CID (6.7L) RD406 International	1955-1972	43	CO1800	392 CID (6.4L) V392 International	1970-1971	38
CO190	450 CID (7.4L) RD450 International	1955-1972	49	CO1810B	392 CID (6.4L) V392 International	1982	38
CO190	501 CID (8.2L) RD501 International	1955-1968	54	CO1810B	404 CID (6.6L) MV404 International	1975-1981	42
CO200 SERIES	406 CID (6.7L) RD406 International	1955-1972	43	CO1810B	446 CID (7.3L) MV446 International	1975-1981	47
CO200 SERIES	450 CID (7.4L) RD450 International	1955-1972	49	CO1910A	401 CID (6.6L) VS401 International	1970-1972	41
CO200 SERIES	501 CID (8.2L) RD501LPG International	1955-1972	55	CO1910B	478 CID (7.8L) VS478 International	1975-1976	53
CO200 SERIES	501 CID (8.2L) RD501 International	1955-1972	54	CO1910B	537 CID (8.8L) VS537 International	1977-1981	57
CO220	372 CID (6.1L) RD372 International	1955-1968	37	CO1910B	549 CID (9.0L) VS549 International	1975-1976	61
CO220	501 CID (8.2L) RD501 International	1962-1972	54	COF220 Series	501 CID (8.2L) RD501 International	1955-1962	54
CO225 Series	372 CID (6.1L) RD372 International	1955-1957	37	COT195	406 CID (6.7L) RD406 International	1964-1968	43
CO225 Series	406 CID (6.7L) RD406 International	1955-1957	43	COT195	450 CID (7.4L) RD450 International	1964-1968	49
CO225 Series	450 CID (7.4L) RD450 International	1955-1957	49	COT195	501 CID (8.2L) RD501 International	1964-1968	54
CO225 Series	501 CID (8.2L) RD501 International	1955-1957	54	D2 Series	175 CID (2.9L) GRD175/HD174 International	1938-1941	6
CO1600	240 CID (3.9L) BD240 International	1955-1962	15	D5 Series	133 CID (2.2L) FC Waukesha	1937-1940	1
				D30 Series	233 CID (3.8L) HD232 International	1937-1941	14

LIGHT TRUCK

Navistar/International

Model Index (cont.)

Model	Engine	Year	Block	Model	Engine	Year	Block
D35 Series	241 CID (3.9L) FAB International	1937-1941	18	K6 Series	250 CID (4.1L) BLD250 International	1941-1947	22
D40 Series	259 CID (4.2L) FAB International	1937-1941	24	K8 Series	450 CID (7.4L) RED450 International	1944-1947	50
D60 Series	361 CID (5.9L) FBB361 International	1937-1941	36	K8 Series	450 CID (7.4L) FBC450 International	1941-1943	48
D900	152 CID (2.5L) Comanche Four International	1965	4	K10 Series	450 CID (7.4L) RED450 International	1944-1947	50
D1000	241 CID (3.9L) BG241 International	1965	21	K10 Series	450 CID (7.4L) FBC450 International	1941-1943	48
D1000	266 CID (4.4L) V266 International	1965	27	K11 Series	450 CID (7.4L) FBC450 International	1941-1943	48
D1100	241 CID (3.9L) BG241 International	1965	20	KB-5 Series	233 CID (3.8L) GRD233 International	1947-1949	13
D1100	241 CID (3.9L) BG241 International	1965	21	KB-6 Series	250 CID (4.1L) BLD250 International	1947-1949	22
D1100	266 CID (4.4L) V266 International	1965	27	KBR10 Series	450 CID (7.4L) RED450 International	1947-1949	50
D1100	304 CID (5.0L) V304 International	1965	32	KBR11 Series	450 CID (7.4L) RED450 International	1947-1949	50
D1100	304 CID (5.0L) V304 International	1965	31	KBS10 Series	450 CID (7.4L) RED450 International	1947-1949	50
D1200	241 CID (3.9L) BG241 International	1965	21	KBS11 Series	450 CID (7.4L) RED450 International	1947-1949	50
D1200	266 CID (4.4L) V266 International	1965	27	KR10 Series	450 CID (7.4L) RED450 International	1944-1947	50
D1200	304 CID (5.0L) V304 International	1965	32	KR10 Series	450 CID (7.4L) FBC450 International	1941-1943	48
D1200	304 CID (5.0L) V304 International	1965	31	KR-8 Series	450 CID (7.4L) RED450 International	1944-1947	50
D1300	241 CID (3.9L) BG241 International	1965	21	KR-8 Series	450 CID (7.4L) FBC450 International	1941-1943	48
D1300	266 CID (4.4L) V266 International	1965	27	KS8 Series	450 CID (7.4L) RED450 International	1944-1947	50
F1800	304 CID (5.0L) V304 International	1964-1974	32	KS8 Series	450 CID (7.4L) FBC450 International	1941-1943	48
F1800	304 CID (5.0L) V304 International	1973-1974	31	KS10 Series	450 CID (7.4L) RED450 International	1944-1947	50
F1800	308 CID (5.0L) BD308 International	1964-1975	33	KS10 Series	450 CID (7.4L) FBC450 International	1941-1943	48
F1800	345 CID (5.6L) V345 International	1964-1974	34	KS11 Series	450 CID (7.4L) RED450 International	1944-1947	50
F1800	392 CID (6.4L) V392 International	1970-1974	38	L11	220 CID (3.6L) SD220 International	1950-1952	10
F1800	404 CID (6.6L) MV404 International	1975-1978	42	L12	220 CID (3.6L) SD220 International	1950-1952	10
F1800	446 CID (7.3L) MV446 International	1975-1978	47	L15	220 CID (3.6L) SD220 International	1950-1952	10
FC402L	406 CID (6.7L) RD406 International	1957-1962	43	L153	220 CID (3.6L) SD220 International	1950-1952	10
FC402L	450 CID (7.4L) RD450 International	1957-1962	49	L1856	372 CID (6.1L) RD372 International	1952-1953	37
FC402L	501 CID (8.2L) RD501 International	1957-1962	54	L1856	406 CID (6.7L) RD406 International	1952-1953	43
FC405L	406 CID (6.7L) RD406 International	1957-1962	43	L-160 Series	240 CID (3.9L) SD240 International	1949-1952	16
FC405L	450 CID (7.4L) RD450 International	1957-1962	49	LB14	220 CID (3.6L) SD220 International	1951-1952	10
FC405L	501 CID (8.2L) RD501 International	1957-1962	54	LB-140	240 CID (3.9L) SD240 International	1950-1952	16
K1 Series	175 CID (2.9L) GRD175/HD174 International	1941-1947	6	LF-190 Series	372 CID (6.1L) RD372 International	1949-1952	37
K2 Series	175 CID (2.9L) GRD175/HD174 International	1941-1947	6	LM12	220 CID (3.6L) SD220 International	1950-1952	10
K3 Series	175 CID (2.9L) GRD175/HD174 International	1941-1947	6	LM15	220 CID (3.6L) SD220 International	1950-1952	10
K4 Series	175 CID (2.9L) GRD175/HD174 International	1941-1947	6	M700	152 CID (2.5L) 4-152 International	1967	3
K5 Series	233 CID (3.8L) GRD233 International	1941-1947	13	M700	152 CID (2.5L) Turbo III International	1966	5
K6 Series	241 CID (3.9L) FAC International	1941-1947	19	M700	152 CID (2.5L) Comanche Four International	1966-1967	4

Navistar/International

Model Index (cont.)

Model	Engine	Year	Block	Model	Engine	Year	Block
M700	220 CID (3.6L) BG220 International	1966-1967	9	R1853 Series	406 CID (6.7L) RD406 International	1957-1963	43
M700	241 CID (3.9L) BG241 International	1966-1967	21	R1853 Series	450 CID (7.4L) RD450 International	1957-1963	49
M800	152 CID (2.5L) 4-152 International	1967-1968	3	R1853 Series	501 CID (8.2L) RD501 International	1957-1963	54
M800	152 CID (2.5L) Turbo III International	1966	5	R1856	372 CID (6.1L) RD372 International	1954-1962	37
M800	152 CID (2.5L) Comanche Four International	1966-1967	4	R1856	406 CID (6.7L) RD406 International	1954-1962	43
M800	220 CID (3.6L) BG220 International	1966-1968	9	R1856	450 CID (7.4L) RD450 International	1957-1962	49
M800	241 CID (3.9L) BG241 International	1966-1968	21	R1856	501 CID (8.2L) RD501 International	1957-1962	54
M1100	152 CID (2.5L) 4-152 International	1967-1968	3	R-140	220 CID (3.6L) SD220 International	1953-1954	11
M1100	152 CID (2.5L) Turbo III International	1966	5	R-140	220 CID (3.6L) SD220 International	1953-1955	10
M1100	152 CID (2.5L) Comanche Four International	1966-1967	4	R-140	240 CID (3.9L) SD240 International	1953-1955	17
M1100	241 CID (3.9L) BG241 International	1966-1970	21	R-140	240 CID (3.9L) SD240 International	1953-1955	16
M1200	220 CID (3.6L) BG220 International	1968	9	R-150 Series	220 CID (3.6L) SD220 International	1953-1954	11
M1200	241 CID (3.9L) BG241 International	1968-1970	21	R-150 Series	220 CID (3.6L) SD220 International	1953-1955	10
M1200	266 CID (4.4L) V266 International	1968-1970	27	R-160 Series	240 CID (3.9L) SD240 International	1953-1955	16
M1200	304 CID (5.0L) V304 International	1968-1971	32	RA120	220 CID (3.6L) SD220 International	1953-1955	10
M1210	345 CID (5.6L) V345 International	1975	34	RC-160 Series	240 CID (3.9L) SD240 International	1953-1955	17
M1210	392 CID (6.4L) V392 International	1975	38	RC-160 Series	240 CID (3.9L) SD240 International	1953-1955	16
M1700	265 CID (4.3L) BG265 International	1965	26	RC-190 Series	372 CID (6.1L) RD372 International	1953-1954	37
MA1200	220 CID (3.6L) BG220 International	1968	9	RF200	372 CID (6.1L) RD372 International	1953-1962	37
MA1200	241 CID (3.9L) BG241 International	1968-1970	21	RF-190 Series	372 CID (6.1L) RD372 International	1953-1968	37
MA1200	266 CID (4.4L) V266 International	1968-1970	27	RM120	220 CID (3.6L) SD220 International	1953-1955	10
MA1200	304 CID (5.0L) V304 International	1968-1970	32	S100	220 CID (3.6L) SD220 International	1956-1957	10
MC1700	265 CID (4.3L) BG265 International	1965	26	S110	240 CID (3.9L) BD240 International	1956-1957	15
MS1200	258 CID (4.2L) American Motors Co.	1973-1974	23	S120	220 CID (3.6L) SD220 International	1956-1957	10
MS1200	304 CID (5.0L) V304 International	1973-1974	32	S130	240 CID (3.9L) BD240 International	1956-1957	15
MS1200	392 CID (6.4L) V392 International	1973-1974	38	S-140	240 CID (3.9L) BD240 International	1955-1956	15
R100	220 CID (3.6L) SD220 International	1953-1955	10	S-140	264 CID (4.3L) BD264 International	1955-1956	25
R110	220 CID (3.6L) SD220 International	1953-1955	10	S-150 Series	240 CID (3.9L) BD240 International	1955-1956	15
R120	220 CID (3.6L) SD220 International	1953-1955	10	S-150 Series	264 CID (4.3L) BD264 International	1955-1956	25
R130	220 CID (3.6L) SD220 International	1953-1955	10	S-153	240 CID (3.9L) BD240 International	1955-1956	15
R185	406 CID (6.7L) RD406 International	1957-1968	43	S-160 Series	264 CID (4.3L) BD264 International	1955-1956	25
R185	450 CID (7.4L) RD450 International	1957-1968	49	S-163	264 CID (4.3L) BD264 International	1955-1956	25
R185	501 CID (8.2L) RD501 International	1965-1968	54	S-173	269 CID (4.4L) BLD269 International	1955-1956	28
R190	406 CID (6.7L) RD406 International	1953-1968	43	SA120	220 CID (3.6L) SD220 International	1956-1957	10
R200	406 CID (6.7L) RD406 International	1957-1968	43	SM120	220 CID (3.6L) SD220 International	1956-1957	10
R1853 Series	372 CID (6.1L) RD372 International	1957-1963	37	SM130	220 CID (3.6L) SD220 International	1956-1957	10

LIGHT TRUCK

Navistar/International

Model Index (cont.)

Model	Engine	Year	Block	Model	Engine	Year	Block
Scout	152 CID (2.5L) Turbo III International	1965-1967	5	Travelall 1110	345 CID (5.6L) V345 International	1972-1973	34
Scout	152 CID (2.5L) Comanche Four International	1961-1964	4	Travelall 1110	392 CID (6.4L) V392 International	1972-1973	38
Scout	196 CID (3.2L) 4-196 International	1966-1970	7	Travelall 1210	258 CID (4.2L) American Motors Co.	1972-1973	23
Scout	232 CID (3.8L) PT6 International	1969-1970	12	Travelall 1210	304 CID (5.0L) V304 International	1972-1973	32
Scout	266 CID (4.4L) V266 International	1966-1968	27	Travelall 1210	345 CID (5.6L) V345 International	1972-1973	34
Scout	304 CID (5.0L) V304 International	1969-1970	31	Travelall 1210	392 CID (6.4L) V392 International	1972-1973	38
Scout	345 CID (5.6L) V345 International	1971	34	V190	401 CID (6.6L) V401 International	1956-1971	40
Scout II	196 CID (3.2L) 4-196 International	1971-1974	7	V190	461 CID (7.6L) V461 International	1956-1964	51
Scout II	232 CID (3.8L) PT6 International	1972	12	V190	478 CID (7.8L) V478 International	1965-1971	52
Scout II	258 CID (4.2L) American Motors Co.	1972-1974	23	V190	549 CID (9.0L) V549 International	1956-1971	60
Scout II	304 CID (5.0L) V304 International	1971-1974	31	V200	401 CID (6.6L) V401 International	1956-1971	40
Scout II	345 CID (5.6L) V345 International	1971-1974	34	V200	461 CID (7.6L) V461 International	1956-1964	51
Scout XLC	196 CID (3.2L) 4-196 International	1975-1980	7	V200	478 CID (7.8L) V478 International	1965-1971	52
Scout XLC	304 CID (5.0L) V304 International	1975-1980	31	V200	549 CID (9.0L) FTV549 International	1970-1971	58
Scout XLC	345 CID (5.6L) V345 International	1975-1980	34	V200	549 CID (9.0L) V549 International	1956-1971	60
Travelall 100	258 CID (4.2L) American Motors Co.	1974	23	V220	461 CID (7.6L) V461 International	1956-1964	51
Travelall 100	345 CID (5.6L) V345 International	1974	34	V220	478 CID (7.8L) V478 International	1965-1968	52
Travelall 100	392 CID (6.4L) V392 International	1974	38	V220	549 CID (9.0L) FTV549 International	1970-1971	58
Travelall 100	400 CID (6.6L) V400 International	1974	39	V220	549 CID (9.0L) V549 International	1956-1968	60
Travelall 150	345 CID (5.6L) V345 International	1975	34	VCO190	401 CID (6.6L) V401 International	1956-1972	40
Travelall 150	392 CID (6.4L) V392 International	1975	38	VCO190	461 CID (7.6L) V461 International	1956-1964	51
Travelall 200	258 CID (4.2L) American Motors Co.	1974	23	VCO190	478 CID (7.8L) V478 International	1965-1972	52
Travelall 200	345 CID (5.6L) V345 International	1974	34	VCO190	549 CID (9.0L) FTV549 International	1970-1972	58
Travelall 200	392 CID (6.4L) V392 International	1974-1975	38	VCO200	401 CID (6.6L) V401 International	1956-1972	40
Travelall 200	400 CID (6.6L) V400 International	1974-1975	39	VCO200	461 CID (7.6L) V461 International	1956-1964	51
Travelall 1010	258 CID (4.2L) American Motors Co.	1972-1973	23	VCO200	478 CID (7.8L) V478 International	1965-1972	52
Travelall 1010	304 CID (5.0L) V304 International	1972-1973	32	VCO200	549 CID (9.0L) FTV549 International	1970-1972	58
Travelall 1010	345 CID (5.6L) V345 International	1972-1973	34	VCO200	549 CID (9.0L) V549 International	1956-1972	60
Travelall 1010	392 CID (6.4L) V392 International	1972-1973	38	VCO220	461 CID (7.6L) V461 International	1962-1964	51
Travelall 1110	258 CID (4.2L) American Motors Co.	1972-1973	23	VCO220	478 CID (7.8L) V478 International	1965-1972	52
Travelall 1110	304 CID (5.0L) V304 International	1972-1973	32	VCO220	549 CID (9.0L) V549 International	1962-1972	60

1 133 CID (2.2L) FC Waukesha 4 Cyl, 3.250in./82.6mm (1937-1940) 1

Part	Year	VIN	Model/Application	Part Number	Qty.
------	------	-----	-------------------	-------------	------

ENGINE GASKETS

Cylinder Head Gasket	1937-1940		Nitroseal	1342G	1
Oil Pan Set	1937-1940		Cork Rubber	OS30427	1

LIGHT TRUCK

Navistar/International

2 133 CID (2.2L) FK Waukesha 4 Cyl, 3.250in./82.6mm (1936-1937) 2

Part	Year	VIN	Model/Application	Part Number	Qty.
ENGINE GASKETS					
Cylinder Head Gasket	1936-1937			Nitroseal 1342G	1
Oil Pan Set	1936-1937			Cork Rubber OS30427	1

3 152 CID (2.5L) 4-152 International 4 Cyl, 3.875in./98.4mm (1967-1968) 3

Part	Year	VIN	Model/Application	Part Number	Qty.
ENGINE GASKETS					
Head Set	1967-1968			HS3175BX	1
Full Set	1967-1968			FS3175BX	1
Cylinder Head Gasket	1967-1968			VR2000 3175	1
Valve Cover Set	1967-1968			Cork Rubber VS38410X	1
Valve Stem Seal, Exh.	1967-1968			B45229	4
Valve Stem Seal, Int.	1967-1968			B45229	4
Manifold Set, Exhaust	1967-1968			MS15094X	1
Manifold Set, Intake	1967-1968		From Serial Number 109457	MS15082X	1
			Thru Serial Number 109457	MS15107X	1
Oil Pan Set	1967-1968			Cork Rubber OS30765	1
Rear Main Seal	1967-1968			46802	1
Rear Main Seal Set	1967-1968			Rubber JV724	1
Timing Cover Set	1967-1968			JV825	1
Timing Cover Seal	1967-1968			49745	1
			(Contains Sleeve)	SS49745	1

MISCELLANEOUS GASKETS

Air Cleaner Mount Gasket	1967-1968		1 Barrel Carburetor	G25936	1
Exhaust Pipe Gasket	1967-1968		(Ring Type 'B'), Pipe To Manifold	F7202	1
Fuel Pump Gasket	1967-1968			D27094	1
Push Rod Cover Set	1967-1968			PS38292	1
Water Pump Mount Gasket	1967-1968			K27896	1

4 152 CID (2.5L) Comanche Four International 4 Cyl, 3.875in./98.4mm (1961-1967) 4

Part	Year	VIN	Model/Application	Part Number	Qty.
ENGINE GASKETS					
Head Set	1961-1967			HS3175BX	1
Full Set	1961-1967			FS3175BX	1
Cylinder Head Gasket	1961-1967			VR2000 3175	1
Valve Cover Set	1961-1967			Cork Rubber VS38410X	1
Valve Stem Seal, Exh.	1961-1967			B45229	4
Valve Stem Seal, Int.	1961-1967			B45229	4
Manifold Set, Exhaust	1961-1967			MS15094X	1
Manifold Set, Intake	1961-1967		From Serial Number 109457	MS15082X	1
			Thru Serial Number 109457	MS15107X	1
Oil Pan Set	1961-1967			Cork Rubber OS30765	1
Rear Main Seal	1961-1967			46802	1
Rear Main Seal Set	1961-1967			Rubber JV724	1
Timing Cover Set	1961-1967			JV825	1
Timing Cover Seal	1961-1967			49745	1
			(Contains Sleeve)	SS49745	1

MISCELLANEOUS GASKETS

Air Cleaner Mount Gasket	1961-1967		1 Barrel Carburetor	G25936	1
Exhaust Pipe Gasket	1961-1967		(Ring Type 'B'), Pipe To Manifold	F7202	1
Fuel Pump Gasket	1961-1967			D27094	1
Push Rod Cover Set	1961-1967			PS38292	1
Water Pump Mount Gasket	1961-1967			K27896	1

5 152 CID (2.5L) Turbo III International 4 Cyl, 3.875in./98.4mm (1965-1967) 5

Part	Year	VIN	Model/Application	Part Number	Qty.
ENGINE GASKETS					
Head Set	1965-1967			HS3175BX	1
Full Set	1965-1967			FS3175BX	1
Cylinder Head Gasket	1965-1967		VR2000	3175	1
Valve Cover Set	1965-1967		Cork Rubber	VS38410X	1
Valve Stem Seal, Exh.	1965-1967			B45229	4
Valve Stem Seal, Int.	1965-1967			B45229	4
Manifold Set, Exhaust	1965-1967			MS15094X	1
Manifold Set, Intake	1965-1967		From Serial Number 109457	MS15082X	1
			Thru Serial Number 109457	MS15107X	1
Oil Pan Set	1965-1967		Cork Rubber	OS30765	1
Rear Main Seal	1965-1967			46802	1
Rear Main Seal Set	1965-1967		Rubber	JV724	1
Timing Cover Set	1965-1967			JV825	1
Timing Cover Seal	1965-1967			49745	1
			(Contains Sleeve)	SS49745	1

MISCELLANEOUS GASKETS

Air Cleaner Mount Gasket	1965-1967		1 Barrel Carburetor	G25936	1
Exhaust Pipe Gasket	1965-1967		(Ring Type 'B'), Pipe To Manifold	F7202	1
Fuel Pump Gasket	1965-1967			D27094	1
Push Rod Cover Set	1965-1967			PS38292	1
Water Pump Mount Gasket	1965-1967			K27896	1

6 175 CID (2.9L) GRD175/HD174 International 6 Cyl, 3.000in./76.2mm (1938-1942) 6

Part	Year	VIN	Model/Application	Part Number	Qty.
ENGINE GASKETS					
Oil Pan Set	1938-1942		Cork Rubber	OS30414	1
MISCELLANEOUS GASKETS					
Fuel Pump Bowl Gasket	1938-1942			D34545	1
Water Outlet Gasket	1938-1942			C24672	1

7 196 CID (3.2L) 4-196 International 4 Cyl, 4.125in./104.8mm (1966-1980) 7

Part	Year	VIN	Model/Application	Part Number	Qty.
ENGINE GASKETS					
Head Set	1975-1980		Scout XLC	HS3885VX	1
	1971-1974		Scout II, (Exhaust Pipe Gasket Not Included)	HS3832W	1
	1966-1971		Scout, (Exhaust Pipe Gasket Not Included)	HS3832W	1
Lower Set	1975-1980		Scout XLC, (Requires Head Set To Make Full Set)	CS3885VX	1
	1971-1974		Scout II, (Requires Head Set To Make Full Set)	CS3885VX	1
	1966-1971		Scout, (Requires Head Set To Make Full Set)	CS3885VX	1
Cylinder Head Gasket	1975-1980		Scout XLC VR2000	3885VC	1
	1971-1974		Scout II Solicor	3832	1
	1966-1971		Scout Solicor	3832	1
Valve Cover Set	1975-1980		Scout XLC Cork Rubber	VS38410X	1
	1971-1974		Scout II Cork Rubber	VS38410X	1
	1966-1971		Scout Cork Rubber	VS38410X	1
Valve Stem Seal, Exh.	1975-1980		Scout XLC	B45229	4
	1971-1974		Scout II	B45229	4
	1966-1971		Scout	B45229	4
Valve Stem Seal, Int.	1975-1980		Scout XLC	B45229	4
	1971-1974		Scout II	B45229	4
	1966-1971		Scout	B45229	4
Manifold Set, Exhaust	1975-1980		Scout XLC	MS15094X	1
	1971-1974		Scout II	MS15094X	1

Navistar/International

7 196 CID (3.2L) 4-196 International 4 Cyl, 4.125in./104.8mm (1966-1980) **7**
 (cont.) (cont.)

Part Year VIN Model/Application Part Number Qty.

ENGINE GASKETS (cont.)

Manifold Set, Exhaust (cont.)	1966-1971		Scout	MS15094X	1
Manifold Set, Intake	1975-1980		Scout XLC	MS15081Y	1
	1971-1974		Scout II	MS15081W	1
	1966-1971		Scout	MS15081W	1
Oil Pan Set	1975-1980		Scout XLC	<i>Cork Rubber</i> OS30765	1
	1971-1974		Scout II	<i>Cork Rubber</i> OS30765	1
	1966-1971		Scout	<i>Cork Rubber</i> OS30765	1
Rear Main Seal	1975-1980		Scout XLC	46802	1
	1971-1974		Scout II	46802	1
	1966-1971		Scout	46802	1
Rear Main Seal Set	1975-1980		Scout XLC	<i>Rubber</i> JV724	1
	1971-1974		Scout II	<i>Rubber</i> JV724	1
	1966-1971		Scout	<i>Rubber</i> JV724	1
Timing Cover Set	1975-1980		Scout XLC	JV825	1
	1971-1974		Scout II	JV825	1
	1966-1971		Scout	JV825	1
Timing Cover Seal	1975-1980		Scout XLC	49745	1
			Scout XLC, (Contains Sleeve)	SS49745	1
	1971-1974		Scout II	49745	1
			Scout II, (Contains Sleeve)	SS49745	1
	1966-1971		Scout	49745	1
		Scout, (Contains Sleeve)	SS49745	1	

MISCELLANEOUS GASKETS

Carb. Mount Gasket	1975-1980		Scout XLC, Thru Chassis Serial Number G465766	G26639	1
	1971-1974		Scout II, Thru Chassis Serial Number G465766	G26639	1
	1966-1971		Scout, Thru Chassis Serial Number G465766	G26639	1
Push Rod Cover Set	1975-1980		Scout XLC	PS38318	1
	1971-1974		Scout II	PS38318	1
	1966-1971		Scout	PS38318	1
Water Pump Mount Gasket	1975-1980		Scout XLC	K27896	1
	1971-1974		Scout II	K27896	1
	1966-1971		Scout	K27896	1

8 220 CID (3.6L) BD220 International 6 Cyl, 3.563in./90.5mm (1957-1962) **8**

Part Year VIN Model/Application Part Number Qty.

ENGINE GASKETS

Head Set	1957-1962		Except Tilt Valve Engine	HS1960	1
			Tilt Valve Engine	HS3153W	1
Lower Set	1957-1962		(Requires Head Set To Make Full Set)	CS3153	1
Cylinder Head Gasket	1957-1962		Except Tilt Valve Engine	<i>Nitroseal</i> 1960	1
			Tilt Valve Engine	3153	1
Valve Cover Set	1957-1962		Except Tilt Valve Engine	<i>Cork Rubber</i> VS39681	1
			Tilt Valve Engine	<i>Cork Rubber</i> VS39723	1
Valve Stem Seal, Exh.	1957-1962		(O-Ring Type)	B45229	6
			(Shedder Type)	B45356	6
Valve Stem Seal, Int.	1957-1962		(O-Ring Type)	B45229	6
			(Shedder Type)	B45356	6
Manifold Set, Int. & Exh.	1957-1962			MS16022	1
Oil Pan Set	1957-1962			<i>Cork Rubber</i> OS31569	1
Rear Main Seal Set	1957-1962			JV713	1
Timing Cover Set	1957-1962			JV792	1

8 220 CID (3.6L) BD220 International 6 Cyl, 3.563in./90.5mm (1957-1962) **8**
(cont.) (cont.)

Part	Year	VIN	Model/Application	Part Number	Qty.
MISCELLANEOUS GASKETS					
Air Cleaner Mount Gasket	1957-1962		1 Barrel Carburetor	G25936	1
Fuel Pump Bowl Gasket	1957-1962			D34545	1
Fuel Pump Gasket	1957-1962			D27094	1
Push Rod Cover Set	1957-1962			PS39682	1
Water Outlet Gasket	1957-1962			C25487	1

9 220 CID (3.6L) BG220 International 6 Cyl, 3.563in./90.5mm (1963-1968) **9**

Part	Year	VIN	Model/Application	Part Number	Qty.
ENGINE GASKETS					
Head Set	1963-1968		Except Tilt Valve Engine	HS1960	1
			Tilt Valve Engine	HS3153W	1
Lower Set	1963-1968		(Requires Head Set To Make Full Set)	CS3153	1
Cylinder Head Gasket	1963-1968		Except Tilt Valve Engine <i>Nitroseal</i>	1960	1
			Tilt Valve Engine	3153	1
Valve Cover Set	1963-1968		Except Tilt Valve Engine <i>Cork Rubber</i>	VS39681	1
			Tilt Valve Engine <i>Cork Rubber</i>	VS39723	1
Valve Stem Seal, Exh.	1963-1968		(O-Ring Type)	B45229	6
			(Shedder Type)	B45356	6
Valve Stem Seal, Int.	1963-1968		(O-Ring Type)	B45229	6
			(Shedder Type)	B45356	6
Manifold Set, Int. & Exh.	1963-1968			MS16022	1
Oil Pan Set	1963-1968		<i>Cork Rubber</i>	OS31569	1
Rear Main Seal Set	1963-1968			JV713	1
Timing Cover Set	1963-1968			JV792	1
MISCELLANEOUS GASKETS					
Fuel Pump Gasket	1963-1968			D27094	1
Push Rod Cover Set	1963-1968			PS39682	1
Water Outlet Gasket	1963-1968			C25487	1

10 220 CID (3.6L) SD220 International 6 Cyl, 3.563in./90.5mm (1950-1957) **10**

Part	Year	VIN	Model/Application	Part Number	Qty.
ENGINE GASKETS					
Head Set	1950-1957		Except Tilt Valve Engine	HS1960	1
			Tilt Valve Engine	HS3153W	1
Lower Set	1950-1957		(Requires Head Set To Make Full Set)	CS3153	1
Cylinder Head Gasket	1950-1957		Except Tilt Valve Engine <i>Nitroseal</i>	1960	1
			Tilt Valve Engine	3153	1
Valve Cover Set	1950-1957		Except Tilt Valve Engine <i>Cork Rubber</i>	VS39681	1
			Tilt Valve Engine <i>Cork Rubber</i>	VS39723	1
Valve Stem Seal, Exh.	1950-1957		(O-Ring Type)	B45229	6
			(Shedder Type)	B45356	6
Valve Stem Seal, Int.	1950-1957		(O-Ring Type)	B45229	6
			(Shedder Type)	B45356	6
Manifold Set, Int. & Exh.	1950-1957			MS16022	1
Oil Pan Set	1950-1957		<i>Cork Rubber</i>	OS31569	1
Rear Main Seal Set	1950-1957			JV713	1
Timing Cover Set	1950-1957			JV792	1
MISCELLANEOUS GASKETS					
Air Cleaner Mount Gasket	1950-1957		1 Barrel Carburetor	G25936	1

Navistar/International

10 220 CID (3.6L) SD220 International 6 Cyl, 3.563in./90.5mm (1950-1957) **10**
 (cont.) (cont.)

Part	Year	VIN	Model/Application	Part Number	Qty.
MISCELLANEOUS GASKETS (cont.)					
Fuel Pump Bowl Gasket	1950-1957			D34545	1
Fuel Pump Gasket	1950-1957			D27094	1
Push Rod Cover Set	1950-1957			PS39682	1
Water Outlet Gasket	1950-1957			C25487	1

11 220 CID (3.6L) SD220 International LPG 6 Cyl, 3.563in./90.5mm (1953-1954) **11**

Part	Year	VIN	Model/Application	Part Number	Qty.
ENGINE GASKETS					
Head Set	1953-1954		Except Tilt Valve Engine	HS1960	1
			Tilt Valve Engine	HS3153W	1
Lower Set	1953-1954		(Requires Head Set To Make Full Set)	CS3153	1
Cylinder Head Gasket	1953-1954		Except Tilt Valve Engine <i>Nitroseal</i>	1960	1
			Tilt Valve Engine	3153	1
Valve Cover Set	1953-1954		Except Tilt Valve Engine <i>Cork Rubber</i>	VS39681	1
			Tilt Valve Engine <i>Cork Rubber</i>	VS39723	1
Valve Stem Seal, Exh.	1953-1954		(O-Ring Type)	B45229	6
			(Shedder Type)	B45356	6
Valve Stem Seal, Int.	1953-1954		(O-Ring Type)	B45229	6
			(Shedder Type)	B45356	6
Manifold Set, Int. & Exh.	1953-1954			MS16022	1
Oil Pan Set	1953-1954		<i>Cork Rubber</i>	OS31569	1
Rear Main Seal Set	1953-1954			JV713	1
Timing Cover Set	1953-1954			JV792	1

MISCELLANEOUS GASKETS

Air Cleaner Mount Gasket	1953-1954		1 Barrel Carburetor	G25936	1
Fuel Pump Bowl Gasket	1953-1954			D34545	1
Fuel Pump Gasket	1953-1954			D27094	1
Push Rod Cover Set	1953-1954			PS39682	1
Water Outlet Gasket	1953-1954			C25487	1

12 232 CID (3.8L) PT6 International 6 Cyl, 3.750in./95.3mm (1969-1972) **12**

Part	Year	VIN	Model/Application	Part Number	Qty.
ENGINE GASKETS					
Head Set	1969-1972		(Exhaust Pipe Gasket Not Included)	HS1199VC	1
Full Set	1969-1972		(Exhaust Pipe Gasket Not Included)	FS1199VC	1
Engine Kit Gasket Set	1969-1971			95-3020VR	1
Cylinder Head Gasket	1969-1972		<i>VR2000</i>	1199	1
Valve Cover Set	1969-1972		<i>Cork Rubber</i>	VS39695	1
			<i>High Temperature Cork Rubber</i>	VS39695H	1
Valve Stem Seal, Exh.	1969-1972			B45323	6
Valve Stem Seal, Int.	1969-1972			B45323	6
Manifold Set, Int. & Exh.	1969-1972			MS15510	1
Oil Pan Set	1969-1972		<i>Cork Rubber</i>	OS30990	1
Rear Main Seal Set	1969-1972			JV1611	1
Timing Cover Set	1969-1972			JV878	1
			(Contains Repair Sleeve)	JV1130	1
Timing Cover Seal	1969-1972			46134	1
Harmonic Balancer Repair Sleeve	1969-1972		Use With Part Number A504 <i>Nickel Plated Formed Steel, .013" Thickness</i>	A221	1

LIGHT TRUCK

12 232 CID (3.8L) PT6 International 6 Cyl, 3.750in./95.3mm (1969-1972) **12**
(cont.) (cont.)

Part	Year	VIN	Model/Application	Part Number	Qty.
MISCELLANEOUS GASKETS					
Air Cleaner Mount Gasket	1969-1972		1 Barrel Carburetor	G26540	1
Carb. Mount Gasket	1969-1972		1 Barrel Carburetor	G26639	2
Exhaust Pipe Gasket	1969-1972		(Ring Type 'D'), Pipe To Manifold	F7171	1
Fuel Pump Gasket	1969-1972			D27094	1
Water Outlet Gasket	1969-1972			C24003	1
Water Pump Mount Gasket	1969-1972			K27110	1

13 233 CID (3.8L) GRD233 International 6 Cyl, 3.313in./84.2mm (1941-1949) **13**

Part	Year	VIN	Model/Application	Part Number	Qty.
ENGINE GASKETS					
Oil Pan Set	1941-1949			Cork Rubber OS30414	1
MISCELLANEOUS GASKETS					
Fuel Pump Bowl Gasket	1941-1949			D34545	1
Water Outlet Gasket	1941-1949			C24672	1

14 233 CID (3.8L) HD232 International 6 Cyl, 3.313in./84.2mm (1937-1941) **14**

Part	Year	VIN	Model/Application	Part Number	Qty.
ENGINE GASKETS					
Oil Pan Set	1937-1941			Cork Rubber OS30414	1
MISCELLANEOUS GASKETS					
Fuel Pump Bowl Gasket	1937-1941			D34545	1
Water Outlet Gasket	1937-1941			C24672	1

15 240 CID (3.9L) BD240 International 6 Cyl, 3.563in./90.5mm (1955-1962) **15**

Part	Year	VIN	Model/Application	Part Number	Qty.
ENGINE GASKETS					
Head Set	1955-1962		Except Tilt Valve Engine	HS1960	1
			Tilt Valve Engine	HS3153W	1
Lower Set	1955-1962		(Requires Head Set To Make Full Set)	CS3153	1
Cylinder Head Gasket	1955-1962		Except Tilt Valve Engine	Nitroseal 1960	1
			Tilt Valve Engine	3153	1
Valve Cover Set	1955-1962		Except Tilt Valve Engine	Cork Rubber VS39681	1
			Tilt Valve Engine	Cork Rubber VS39723	1
Valve Stem Seal, Exh.	1955-1962		(O-Ring Type)	B45229	6
			(Shedder Type)	B45323	6
Valve Stem Seal, Int.	1955-1962		(O-Ring Type)	B45229	6
			(Shedder Type)	B45323	6
Manifold Set, Int. & Exh.	1955-1962			MS16022	1
Oil Pan Set	1955-1962			Cork Rubber OS31569	1
Rear Main Seal Set	1955-1962			JV713	1
Timing Cover Set	1955-1962			JV792	1
MISCELLANEOUS GASKETS					
Air Cleaner Mount Gasket	1962			G25936	1
	1957-1962		1 Barrel Carburetor	G25936	1
	1955-1962			G25936	1
	1955-1960		1 Barrel Carburetor	G25936	1
Fuel Pump Bowl Gasket	1955-1962			D34545	1

Navistar/International

15	240 CID (3.9L) BD240 International 6 Cyl, 3.563in./90.5mm (1955-1962)	15
(cont.)		(cont.)

Part	Year	VIN	Model/Application	Part Number	Qty.
MISCELLANEOUS GASKETS (cont.)					
Fuel Pump Gasket	1955-1962			D27094	1
Push Rod Cover Set	1955-1962			PS39682	1
Water Outlet Gasket	1955-1962			C25487	1

16	240 CID (3.9L) SD240 International 6 Cyl, 3.563in./90.5mm (1950-1969)	16
-----------	--	-----------

Part	Year	VIN	Model/Application	Part Number	Qty.
ENGINE GASKETS					
Head Set	1950-1969		Except Tilt Valve Engine	HS1960	1
			Tilt Valve Engine	HS3153W	1
Lower Set	1950-1969		(Requires Head Set To Make Full Set)	CS3153	1
Cylinder Head Gasket	1950-1969		Except Tilt Valve Engine <i>Nitroseal</i>	1960	1
			Tilt Valve Engine	3153	1
Valve Cover Set	1950-1969		Except Tilt Valve Engine <i>Cork Rubber</i>	VS39681	1
			Tilt Valve Engine <i>Cork Rubber</i>	VS39723	1
Valve Stem Seal, Exh.	1950-1969		(O-Ring Type)	B45229	6
			(Shedder Type)	B45323	6
Valve Stem Seal, Int.	1950-1969		(O-Ring Type)	B45229	6
			(Shedder Type)	B45323	6
Manifold Set, Int. & Exh.	1950-1969			MS16022	1
Oil Pan Set	1950-1969		<i>Cork Rubber</i>	OS31569	1
Rear Main Seal Set	1950-1969			JV713	1
Timing Cover Set	1950-1969			JV792	1

MISCELLANEOUS GASKETS

Air Cleaner Mount Gasket	1950-1969			G25936	1
	1953-1955		1 Barrel Carburetor	G25936	1
	1950-1955			G25936	1
	1950-1952		1 Barrel Carburetor	G25936	1
Fuel Pump Bowl Gasket	1950-1969			D34545	1
Fuel Pump Gasket	1950-1969			D27094	1
Push Rod Cover Set	1950-1969			PS39682	1
Water Outlet Gasket	1950-1969			C25487	1

17	240 CID (3.9L) SD240 International LPG 6 Cyl, 3.563in./90.5mm (1953-1955)	17
-----------	--	-----------

Part	Year	VIN	Model/Application	Part Number	Qty.
ENGINE GASKETS					
Head Set	1953-1955		Except Tilt Valve Engine	HS1960	1
			Tilt Valve Engine	HS3153W	1
Lower Set	1953-1955		(Requires Head Set To Make Full Set)	CS3153	1
Cylinder Head Gasket	1953-1955		Except Tilt Valve Engine <i>Nitroseal</i>	1960	1
			Tilt Valve Engine	3153	1
Valve Cover Set	1953-1955		Except Tilt Valve Engine <i>Cork Rubber</i>	VS39681	1
			Tilt Valve Engine <i>Cork Rubber</i>	VS39723	1
Valve Stem Seal, Exh.	1953-1955		(O-Ring Type)	B45229	6
			(Shedder Type)	B45323	6
Valve Stem Seal, Int.	1953-1955		(O-Ring Type)	B45229	6
			(Shedder Type)	B45323	6
Manifold Set, Int. & Exh.	1953-1955			MS16022	1
Oil Pan Set	1953-1955		<i>Cork Rubber</i>	OS31569	1
Rear Main Seal Set	1953-1955			JV713	1
Timing Cover Set	1953-1955			JV792	1

LIGHT TRUCK

17 240 CID (3.9L) SD240 International LPG 6 Cyl, 3.563in./90.5mm (1953-1955) **17**
(cont.) (cont.)

Part	Year	VIN	Model/Application	Part Number	Qty.
MISCELLANEOUS GASKETS					
Air Cleaner Mount Gasket	1953-1955			G25936	1
			1 Barrel Carburetor	G25936	1
Fuel Pump Bowl Gasket	1953-1955			D34545	1
Fuel Pump Gasket	1953-1955			D27094	1
Push Rod Cover Set	1953-1955			PS39682	1
Water Outlet Gasket	1953-1955			C25487	1

18 241 CID (3.9L) FAB International 6 Cyl, 3.375in./85.7mm (1937-1941) **18**

Part	Year	VIN	Model/Application	Part Number	Qty.
ENGINE GASKETS					
Valve Cover Set	1937-1941			Cork Rubber VS39644	1
Valve Stem Seal, Exh.	1937-1941			B45229	6
Valve Stem Seal, Int.	1937-1941			B45229	6
Manifold Set, Int. & Exh.	1937-1941		From Serial Number 2401	MS16017	1
Oil Pan Set	1937-1941			Cork Rubber OS30972	1
Rear Main Seal Set	1937-1941			JV714	1
Timing Cover Set	1937-1941		From Serial Number 2401	JV830	1
Timing Cover Seal	1937-1941			49618	1

MISCELLANEOUS GASKETS					
Air Cleaner Mount Gasket	1937-1941		1 Barrel Carburetor	G25936	1

19 241 CID (3.9L) FAC International 6 Cyl, 3.375in./85.7mm (1941-1947) **19**

Part	Year	VIN	Model/Application	Part Number	Qty.
ENGINE GASKETS					
Valve Cover Set	1941-1947			Cork Rubber VS39644	1
Valve Stem Seal, Exh.	1941-1947			B45229	6
Valve Stem Seal, Int.	1941-1947			B45229	6
Manifold Set, Int. & Exh.	1941-1947		From Serial Number 2401	MS16017	1
Oil Pan Set	1941-1947			Cork Rubber OS30972	1
Rear Main Seal Set	1941-1947			JV714	1
Timing Cover Set	1941-1947		From Serial Number 2401	JV830	1
Timing Cover Seal	1941-1947			49618	1

MISCELLANEOUS GASKETS					
Air Cleaner Mount Gasket	1941-1947		1 Barrel Carburetor	G25936	1

20 241 CID (3.9L) BG241 International 6 Cyl, 3.563in./90.5mm (1965-1966) **20**

Part	Year	VIN	Model/Application	Part Number	Qty.
ENGINE GASKETS					
Head Set	1965-1966		Except Tilt Valve Engine	HS1960	1
			Tilt Valve Engine	HS3153W	1
Lower Set	1965-1966		(Requires Head Set To Make Full Set)	CS3153	1
Cylinder Head Gasket	1965-1966		Except Tilt Valve Engine	Nitroseal 1960	1
			Tilt Valve Engine	3153	1
Valve Cover Set	1965-1966		Except Tilt Valve Engine	Cork Rubber VS39681	1
			Tilt Valve Engine	Cork Rubber VS39723	1
Manifold Set, Int. & Exh.	1965-1966			MS16022	1
Oil Pan Set	1965-1966			Cork Rubber OS31569	1
Rear Main Seal Set	1965-1966			JV713	1

Navistar/International

20 <small>(cont.)</small>	241 CID (3.9L) BG241 International 6 Cyl, 3.563in./90.5mm (1965-1966)	20 <small>(cont.)</small>
-------------------------------------	--	-------------------------------------

Part	Year	VIN	Model/Application	Part Number	Qty.
------	------	-----	-------------------	-------------	------

ENGINE GASKETS (cont.)

Timing Cover Set	1965-1966			JV792	1
------------------	-----------	--	--	-------	---

MISCELLANEOUS GASKETS

Fuel Pump Gasket	1965-1966			D27094	1
Push Rod Cover Set	1965-1966			PS39682	1
Water Outlet Gasket	1965-1966			C25487	1

21	241 CID (3.9L) BG241 International LPG 6 Cyl, 3.563in./90.5mm (1963-1969)	21
-----------	--	-----------

Part	Year	VIN	Model/Application	Part Number	Qty.
------	------	-----	-------------------	-------------	------

ENGINE GASKETS

Head Set	1963-1969		Except Tilt Valve Engine	HS1960	1
			Tilt Valve Engine	HS3153W	1
Lower Set	1963-1969		(Requires Head Set To Make Full Set)	CS3153	1
Cylinder Head Gasket	1963-1969		Except Tilt Valve Engine	<i>Nitroseal</i> 1960	1
			Tilt Valve Engine	3153	1
Valve Cover Set	1963-1969		Except Tilt Valve Engine	<i>Cork Rubber</i> VS39681	1
			Tilt Valve Engine	<i>Cork Rubber</i> VS39723	1
Manifold Set, Int. & Exh.	1963-1969			MS16022	1
Oil Pan Set	1963-1969			<i>Cork Rubber</i> OS31569	1
Rear Main Seal Set	1963-1969			JV713	1
Timing Cover Set	1963-1969			JV792	1

MISCELLANEOUS GASKETS

Fuel Pump Gasket	1963-1969			D27094	1
Push Rod Cover Set	1963-1969			PS39682	1
Water Outlet Gasket	1963-1969			C25487	1

22	250 CID (4.1L) BLD250 International 6 Cyl, 3.438in./87.3mm (1941-1949)	22
-----------	---	-----------

Part	Year	VIN	Model/Application	Part Number	Qty.
------	------	-----	-------------------	-------------	------

ENGINE GASKETS

Valve Cover Set	1941-1949			<i>Cork Rubber</i> VS39644	1
Valve Stem Seal, Exh.	1941-1949			B45229	6
Valve Stem Seal, Int.	1941-1949			B45229	6
Manifold Set, Int. & Exh.	1941-1949			MS16017	1
Oil Pan Set	1941-1949			<i>Cork Rubber</i> OS30972	1
Rear Main Seal Set	1941-1949			JV714	1
Timing Cover Set	1941-1949			JV830	1
Timing Cover Seal	1941-1949			49618	1

MISCELLANEOUS GASKETS

Air Cleaner Mount Gasket	1947-1949		1 Barrel Carburetor	G25936	1
	1941-1947			G25936	1
Fuel Pump Bowl Gasket	1941-1949			D34545	1

23	258 CID (4.2L) American Motors Co. 6 Cyl, 3.750in./95.3mm (1972-1974)	23
-----------	--	-----------

Part	Year	VIN	Model/Application	Part Number	Qty.
------	------	-----	-------------------	-------------	------

ENGINE GASKETS

Head Set	1972-1974		(Exhaust Pipe Gasket Not Included)	HS1199VC	1
Full Set	1972-1974		(Exhaust Pipe Gasket Not Included)	FS1199VC	1
Engine Kit Gasket Set	1972-1974			95-3020VR	1
Cylinder Head Gasket	1972-1974			<i>VR2000</i> 1199	1
Valve Cover Set	1972-1974			<i>Cork Rubber</i> VS39695	1
				<i>High Temperature Cork Rubber</i> VS39695H	1

LIGHT TRUCK

23 258 CID (4.2L) American Motors Co. 6 Cyl, 3.750in./95.3mm (1972-1974) **23**
 (cont.) (cont.)

Part Year VIN Model/Application Part Number Qty.

ENGINE GASKETS (cont.)

Valve Stem Seal, Exh.	1972-1974			B45323	6
Valve Stem Seal, Int.	1972-1974			B45323	6
Manifold Set, Int. & Exh.	1972-1974			MS15510	1
Oil Pan Set	1972-1974		Cork Rubber	OS30990	1
Rear Main Seal Set	1972-1974			JV1611	1
Timing Cover Set	1972-1974			JV878	1
				(Contains Repair Sleeve)	JV1130
Timing Cover Seal	1972-1974			46134	1
Harmonic Balancer Repair Sleeve	1972-1974		Use With Part Number A504 Nickel Plated Formed Steel, .013" Thickness	A221	1

MISCELLANEOUS GASKETS

Air Cleaner Mount Gasket	1972-1974		1 Barrel Carburetor	G26540	1
Carb. Mount Gasket	1972-1974		1 Barrel Carburetor	G26639	2
Exhaust Pipe Gasket	1972-1974		(Ring Type 'D'), Pipe To Manifold	F7171	1
Fuel Pump Gasket	1972-1974			D27094	1
Water Outlet Gasket	1972-1974			C24003	1
Water Pump Mount Gasket	1972-1974			K27110	1

24 259 CID (4.2L) FAB International 6 Cyl, 3.500in./88.9mm (1939-1940) **24**

Part Year VIN Model/Application Part Number Qty.

ENGINE GASKETS

Valve Cover Set	1939-1940			Cork Rubber VS39644	1
Valve Stem Seal, Exh.	1939-1940			B45229	6
Valve Stem Seal, Int.	1939-1940			B45229	6
Manifold Set, Int. & Exh.	1939-1940		From Serial Number 3301	MS16017	1
Oil Pan Set	1939-1940			Cork Rubber OS30972	1
Rear Main Seal Set	1939-1940			JV714	1
Timing Cover Set	1939-1940			JV830	1
Timing Cover Seal	1939-1940			49618	1

MISCELLANEOUS GASKETS

Air Cleaner Mount Gasket	1939-1940		1 Barrel Carburetor	G25936	1
--------------------------	-----------	--	---------------------	--------	---

25 264 CID (4.3L) BD264 International 6 Cyl, 3.688in./93.7mm (1955-1968) **25**

Part Year VIN Model/Application Part Number Qty.

ENGINE GASKETS

Head Set	1955-1968		Except Tilt Valve Engine	HS1960	1
			Tilt Valve Engine	HS3153W	1
Lower Set	1955-1968		(Requires Head Set To Make Full Set)	CS3153	1
Cylinder Head Gasket	1955-1968		Except Tilt Valve Engine	Nitroseal 1960	1
			Tilt Valve Engine	3153	1
Valve Cover Set	1955-1968		Except Tilt Valve Engine	Cork Rubber VS39681	1
			Tilt Valve Engine	Cork Rubber VS39723	1
Valve Stem Seal, Exh.	1955-1968			B45356	6
Valve Stem Seal, Int.	1955-1968			B45356	6
Manifold Set, Int. & Exh.	1955-1968			MS16022	1
Oil Pan Set	1955-1968			Cork Rubber OS31569	1
Rear Main Seal Set	1955-1968			JV713	1
Timing Cover Set	1955-1968			JV792	1

LIGHT TRUCK

Navistar/International

25	264 CID (4.3L) BD264 International 6 Cyl, 3.688in./93.7mm (1955-1968)	25
(cont.)		(cont.)

Part	Year	VIN	Model/Application	Part Number	Qty.
MISCELLANEOUS GASKETS					
Air Cleaner Mount Gasket	1955-1968			G25936	1
	1955-1962		1 Barrel Carburetor	G25936	1
Fuel Pump Bowl Gasket	1955-1968			D34545	1
Fuel Pump Gasket	1955-1968			D27094	1
Push Rod Cover Set	1955-1968			PS39682	1
Water Outlet Gasket	1955-1968			C25487	1

26	265 CID (4.3L) BG265 International 6 Cyl, 3.688in./93.7mm (1955-1968)	26
-----------	--	-----------

Part	Year	VIN	Model/Application	Part Number	Qty.
ENGINE GASKETS					
Head Set	1955-1968		Except Tilt Valve Engine	HS1960	1
			Tilt Valve Engine	HS3153W	1
Lower Set	1955-1968		(Requires Head Set To Make Full Set)	CS3153	1
Cylinder Head Gasket	1955-1968		Except Tilt Valve Engine	Nitroseal 1960	1
			Tilt Valve Engine	3153	1
Valve Cover Set	1955-1968		Except Tilt Valve Engine	Cork Rubber VS39681	1
			Tilt Valve Engine	Cork Rubber VS39723	1
Manifold Set, Int. & Exh.	1955-1968			MS16022	1
Oil Pan Set	1955-1968			Cork Rubber OS31569	1
Rear Main Seal Set	1955-1968			JV713	1
Timing Cover Set	1955-1968			JV792	1

MISCELLANEOUS GASKETS					
Fuel Pump Gasket	1955-1968			D27094	1
Push Rod Cover Set	1955-1968			PS39682	1
Water Outlet Gasket	1955-1968			C25487	1

27	266 CID (4.4L) V266 International V8 Cyl, 3.625in./92.1mm (1959-1972)	27
-----------	--	-----------

Part	Year	VIN	Model/Application	Part Number	Qty.
ENGINE GASKETS					
Head Set	1959-1972		(Exhaust Pipe Gasket Not Included)	HS3175	1
Lower Set	1959-1972		(Requires Head Set To Make Full Set)	CS3175	1
Engine Kit Gasket Set	1961-1972			95-3002VR	1
Cylinder Head Gasket	1959-1972			VR2000 3175	2
Valve Cover Set	1959-1972			Cork Rubber VS38410	1
Valve Stem Seal, Exh.	1959-1972			B45229	8
Valve Stem Seal, Int.	1959-1972			B45229	8
Manifold Set, Exhaust	1959-1972			MS15094	1
Manifold Set, Intake	1959-1972			MS15082	1
Oil Pan Set	1959-1972			Cork Rubber OS30765	1
Rear Main Seal	1959-1972			46802	1
Rear Main Seal Set	1959-1972			Rubber JV724	1
Timing Cover Set	1959-1972			JV825	1
Timing Cover Seal	1959-1972			49745	1
			(Contains Sleeve)	SS49745	1

MISCELLANEOUS GASKETS					
Air Cleaner Mount Gasket	1959-1972		2 Barrel Carburetor	G27098	1
Carb. Mount Gasket	1959-1972		2 Barrel Carburetor	G30709	1
Exhaust Pipe Gasket	1959-1972		(Ring Type 'B'), Pipe To Manifold	F7202	1
Fuel Pump Gasket	1959-1972			D27094	1
Push Rod Cover Set	1959-1972			PS36468	1

LIGHT TRUCK

27 266 CID (4.4L) V266 International V8 Cyl, 3.625in./92.1mm (1959-1972) **27**
(cont.) (cont.)

Part Year VIN Model/Application Part Number Qty.

MISCELLANEOUS GASKETS (cont.)

Therm. Housing Gasket	1959-1972			C26472	1
Water Outlet Gasket	1959-1972			C26472	2
Water Pump Mount Gasket	1959-1972			K27896	1

28 269 CID (4.4L) BLD269 International 6 Cyl, 3.563in./90.5mm (1955-1956) **28**

Part Year VIN Model/Application Part Number Qty.

ENGINE GASKETS

Head Set	1955-1956		From Serial Number 64774	HS3031	1
Full Set	1955-1956		From Serial Number 64774	FS3031	1
Cylinder Head Gasket	1955-1956		From Serial Number 64774	3031	1
Valve Cover Set	1955-1956		<i>Cork Rubber</i>	VS39644	1
Valve Stem Seal, Exh.	1955-1956			B45229	6
Valve Stem Seal, Int.	1955-1956			B45229	6
Manifold Set, Int. & Exh.	1955-1956			MS16017	1
Oil Pan Set	1955-1956		<i>Cork Rubber</i>	OS30972	1
Rear Main Seal Set	1955-1956			JV714	1
Timing Cover Set	1955-1956			JV830	1
Timing Cover Seal	1955-1956			49618	1

MISCELLANEOUS GASKETS

Air Cleaner Mount Gasket	1955-1956		1 Barrel Carburetor	G25936	1
--------------------------	-----------	--	---------------------	--------	---

29 282 CID (4.6L) BD282 International 6 Cyl, 3.8125in./96.8mm (1957-1962) **29**

Part Year VIN Model/Application Part Number Qty.

ENGINE GASKETS

Head Set	1957-1962			HS3031	1
Full Set	1957-1962			FS3031	1
Cylinder Head Gasket	1957-1962			3031	1
Valve Cover Set	1957-1962		<i>Cork Rubber</i>	VS39644	1
Valve Stem Seal, Exh.	1957-1962			B45229	6
Valve Stem Seal, Int.	1957-1962			B45229	6
Manifold Set, Int. & Exh.	1957-1962			MS16017	1
Oil Pan Set	1957-1962		<i>Cork Rubber</i>	OS30972	1
Rear Main Seal Set	1957-1962			JV714	1
Timing Cover Set	1957-1962			JV830	1
Timing Cover Seal	1957-1962			49618	1

MISCELLANEOUS GASKETS

Air Cleaner Mount Gasket	1957-1962		1 Barrel Carburetor	G25936	1
--------------------------	-----------	--	---------------------	--------	---

30 301 CID (4.9L) D301 International Diesel 6 Cyl, 3.813in./96.9mm (1960-1969) **30**

Part Year VIN Model/Application Part Number Qty.

ENGINE GASKETS

Head Set	1960-1969			HS3843	1
Full Set	1960-1969			FS3843	1
Cylinder Head Gasket	1960-1969		<i>VR2000</i>	3843	1
Valve Cover Set	1960-1969			VS18848	1
Oil Pan Set	1960-1969		<i>Cork Rubber</i>	OS31569	1
Rear Main Seal	1960-1969			47816	1
Timing Cover Seal	1960-1969			49276	2

Navistar/International

30 <small>(cont.)</small>	301 CID (4.9L) D301 International Diesel 6 Cyl, 3.813in./96.9mm (1960-1969)	30 <small>(cont.)</small>
-------------------------------------	--	-------------------------------------

Part	Year	VIN	Model/Application	Part Number	Qty.
MISCELLANEOUS GASKETS					
Push Rod Cover Set	1960-1969			PS39682	1

31	304 CID (5.0L) V304 International V8 Cyl, 3.875in./98.4mm (1959-1980)	31
-----------	--	-----------

Part	Year	VIN	Model/Application	Part Number	Qty.
ENGINE GASKETS					
Head Set	1959-1980		(Exhaust Pipe Gasket Not Included)	HS3175	1
Lower Set	1959-1980		(Requires Head Set To Make Full Set)	CS3175	1
Engine Kit Gasket Set	1961-1980			95-3002VR	1
Cylinder Head Gasket	1959-1980		<i>VR2000</i>	3175	2
Valve Cover Set	1959-1980		<i>Cork Rubber</i>	VS38410	1
Valve Stem Seal, Exh.	1959-1980			B45229	8
Valve Stem Seal, Int.	1959-1980			B45229	8
Manifold Set, Exhaust	1959-1980			MS15094	1
Manifold Set, Intake	1959-1980			MS15082	1
Oil Pan Set	1959-1980		<i>Cork Rubber</i>	OS30765	1
Rear Main Seal	1959-1980			46802	1
Rear Main Seal Set	1959-1980		<i>Rubber</i>	JV724	1
Crank Repair Sleeve	1959-1980		Use With Part Number A506, Rear <i>Nickel Plated Formed Steel, .013" Thickness</i>	A336	1
Timing Cover Set	1959-1980			JV825	1
Timing Cover Seal	1959-1980			49745	1
			(Contains Sleeve)	SS49745	1

MISCELLANEOUS GASKETS

Air Cleaner Mount Gasket	1959-1980		2 Barrel Carburetor	G27098	1
Exhaust Pipe Gasket	1959-1980		(Ring Type 'B'), Pipe To Manifold	F7202	2
Fuel Pump Gasket	1959-1980			D27094	1
Push Rod Cover Set	1959-1980			PS36468	1
Therm. Housing Gasket	1959-1980			C26472	1
Water Outlet Gasket	1959-1980			C26472	2
Water Pump Mount Gasket	1959-1980			K27896	1

32	304 CID (5.0L) V304 International LPG V8 Cyl, 3.875in./98.4mm (1964-1975)	32
-----------	--	-----------

Part	Year	VIN	Model/Application	Part Number	Qty.
ENGINE GASKETS					
Head Set	1964-1975		(Exhaust Pipe Gasket Not Included)	HS3175	1
Lower Set	1964-1975		(Requires Head Set To Make Full Set)	CS3175	1
Engine Kit Gasket Set	1964-1975			95-3002VR	1
Cylinder Head Gasket	1964-1975		<i>VR2000</i>	3175	2
Valve Cover Set	1964-1975		<i>Cork Rubber</i>	VS38410	1
Valve Stem Seal, Exh.	1964-1975			B45229	8
Valve Stem Seal, Int.	1964-1975			B45229	8
Manifold Set, Exhaust	1964-1975			MS15094	1
Manifold Set, Intake	1964-1975			MS15082	1
Oil Pan Set	1964-1975		<i>Cork Rubber</i>	OS30765	1
Rear Main Seal	1964-1975			46802	1
Rear Main Seal Set	1964-1975		<i>Rubber</i>	JV724	1
Crank Repair Sleeve	1964-1975		Use With Part Number A506, Rear <i>Nickel Plated Formed Steel, .013" Thickness</i>	A336	1
Timing Cover Set	1964-1975			JV825	1
Timing Cover Seal	1964-1975			49745	1
			(Contains Sleeve)	SS49745	1

LIGHT TRUCK

32 (cont.)	304 CID (5.0L) V304 International LPG V8 Cyl, 3.875in./98.4mm (1964-1975)					32 (cont.)
----------------------	--	--	--	--	--	----------------------

Part	Year	VIN	Model/Application	Part Number	Qty.
------	------	-----	-------------------	-------------	------

MISCELLANEOUS GASKETS

Air Cleaner Mount Gasket	1964-1975		2 Barrel Carburetor	G27098	1
Exhaust Pipe Gasket	1964-1975		(Ring Type 'B'), Pipe To Manifold	F7202	2
Fuel Pump Gasket	1964-1975			D27094	1
Push Rod Cover Set	1964-1975			PS36468	1
Therm. Housing Gasket	1964-1975			C26472	1
Water Outlet Gasket	1964-1975			C26472	2
Water Pump Mount Gasket	1964-1975			K27896	1

33	308 CID (5.0L) BD308 International 6 Cyl, 3.813in./96.9mm (1957-1971)					33
-----------	--	--	--	--	--	-----------

Part	Year	VIN	Model/Application	Part Number	Qty.
------	------	-----	-------------------	-------------	------

ENGINE GASKETS

Head Set	1957-1971			HS3031	1
Full Set	1957-1971			FS3031	1
Cylinder Head Gasket	1957-1971			3031	1
Valve Cover Set	1957-1971		Cork Rubber	VS39644	1
Valve Stem Seal, Exh.	1957-1971			B45229	6
Valve Stem Seal, Int.	1957-1971			B45229	6
Manifold Set, Int. & Exh.	1957-1971			MS16017	1
Oil Pan Set	1957-1971		Cork Rubber	OS30972	1
Rear Main Seal Set	1957-1971			JV714	1
Timing Cover Set	1957-1971			JV830	1
Timing Cover Seal	1957-1971			49618	1

MISCELLANEOUS GASKETS

Air Cleaner Mount Gasket	1970-1971		1 Barrel Carburetor	G25936	1
	1964-1971			G25936	1
	1962-1971		1 Barrel Carburetor	G25936	1
				G25936	1
	1957-1971		1 Barrel Carburetor	G25936	1

34	345 CID (5.6L) V345 International V8 Cyl, 3.875in./98.4mm (1959-1982)					34
-----------	--	--	--	--	--	-----------

Part	Year	VIN	Model/Application	Part Number	Qty.
------	------	-----	-------------------	-------------	------

ENGINE GASKETS

Head Set	1959-1982		(Exhaust Pipe Gasket Not Included, Intake Manifold Gasket Not Included)	HS3175Y	1
	1975		(Exhaust Pipe Gasket Not Included)	HS3175	1
Lower Set	1959-1982		(Requires Head Set To Make Full Set)	CS3175	1
Engine Kit Gasket Set	1968-1980			95-3002VR	1
Cylinder Head Gasket	1959-1982		VR2000	3175	2
Valve Cover Set	1959-1982		Cork Rubber	VS38410	1
Valve Stem Seal, Exh.	1959-1982			B45229	8
Valve Stem Seal, Int.	1959-1982			B45229	8
Manifold Set, Exhaust	1959-1982			MS15094	1
Manifold Set, Intake	1959-1982			MS15081	1
	1975			MS15082	1
Oil Pan Set	1959-1982		Cork Rubber	OS30765	1
Rear Main Seal	1959-1982			46802	1
Rear Main Seal Set	1959-1982		Rubber	JV724	1
Crank Repair Sleeve	1959-1982		Use With Part Number A506, Rear Nickel Plated Formed Steel, .013" Thickness	A336	1
Timing Cover Set	1959-1982			JV825	1
Timing Cover Seal	1959-1982			49745	1

Navistar/International

34 345 CID (5.6L) V345 International V8 Cyl, 3.875in./98.4mm (1959-1982) **34**
 (cont.) (cont.)

Part Year VIN Model/Application Part Number Qty.

ENGINE GASKETS (cont.)

Timing Cover Seal (cont.)	1959-1982		(Contains Sleeve)	SS49745	1
---------------------------	-----------	--	-------------------	---------	---

MISCELLANEOUS GASKETS

Air Cleaner Mount Gasket	1970-1982		2 Barrel Carburetor	G27098	1
Carb. Mount Gasket	1959-1982		2 Barrel Carburetor	G30709	1
Exhaust Pipe Gasket	1959-1982		(Ring Type 'B'), Pipe To Manifold	F7202	2
Fuel Pump Gasket	1959-1982			D27094	1
Push Rod Cover Set	1959-1982			PS38998	1
Therm. Housing Gasket	1959-1982			C26472	1
Water Outlet Gasket	1959-1982			C26472	2
Water Pump Mount Gasket	1959-1982			K27896	1

35 345 CID (5.6L) V345LPG International LPG V8 Cyl, 3.875in./98.4mm (1962-1982) **35**

Part Year VIN Model/Application Part Number Qty.

ENGINE GASKETS

Head Set	1982		(Exhaust Pipe Gasket Not Included, Intake Manifold Gasket Not Included)	HS3175Y	1
	1962-1978		(Exhaust Pipe Gasket Not Included, Intake Manifold Gasket Not Included)	HS3175Y	1
Lower Set	1982		(Requires Head Set To Make Full Set)	CS3175	1
	1962-1978		(Requires Head Set To Make Full Set)	CS3175	1
Cylinder Head Gasket	1982		VR2000	3175	2
	1962-1978		VR2000	3175	2
Valve Cover Set	1982		Cork Rubber	VS38410	1
	1962-1978		Cork Rubber	VS38410	1
Valve Stem Seal, Exh.	1982			B45229	8
	1962-1978			B45229	8
Valve Stem Seal, Int.	1982			B45229	8
	1962-1978			B45229	8
Manifold Set, Exhaust	1982			MS15094	1
	1962-1978			MS15094	1
Manifold Set, Intake	1982			MS15108	1
	1962-1978			MS15108	1
Oil Pan Set	1982		Cork Rubber	OS30765	1
	1962-1978		Cork Rubber	OS30765	1
Rear Main Seal	1982			46802	1
	1962-1978			46802	1
Rear Main Seal Set	1982		Rubber	JV724	1
	1962-1978		Rubber	JV724	1
Crank Repair Sleeve	1982		Use With Part Number A506, Rear Nickel Plated Formed Steel, .013" Thickness	A336	1
	1962-1978		Use With Part Number A506, Rear Nickel Plated Formed Steel, .013" Thickness	A336	1
Timing Cover Set	1982			JV825	1
	1962-1978			JV825	1
Timing Cover Seal	1982			49745	1
		(Contains Sleeve)	SS49745	1	
	1962-1978		(Contains Sleeve)	SS49745	1

MISCELLANEOUS GASKETS

Air Cleaner Mount Gasket	1982		2 Barrel Carburetor	G27098	1
	1962-1978		2 Barrel Carburetor	G27098	1
Carb. Mount Gasket	1982		2 Barrel Carburetor	G30709	1

LIGHT TRUCK

35 345 CID (5.6L) V345LPG International LPG V8 Cyl, 3.875in./98.4mm (1962-1982) **35**
 (cont.) (cont.)

Part	Year	VIN	Model/Application	Part Number	Qty.
MISCELLANEOUS GASKETS (cont.)					
Carb. Mount Gasket (cont.)	1962-1978		2 Barrel Carburetor	G30709	1
Exhaust Pipe Gasket	1982		(Ring Type 'B'), Pipe To Manifold	F7202	2
	1962-1978		(Ring Type 'B'), Pipe To Manifold	F7202	2
Fuel Pump Gasket	1982			D27094	1
	1962-1978			D27094	1
Push Rod Cover Set	1982			PS38998	1
	1962-1978			PS38998	1
Therm. Housing Gasket	1982			C26472	1
	1962-1978			C26472	1
Water Outlet Gasket	1982			C26472	2
	1962-1978			C26472	2
Water Pump Mount Gasket	1982			K27896	1
	1962-1978			K27896	1

36 361 CID (5.9L) FBB361 International 6 Cyl, 4.125in./104.8mm (1937-1941) **36**

Part	Year	VIN	Model/Application	Part Number	Qty.
ENGINE GASKETS					
Valve Cover Set	1937-1941		Cork Rubber	VS39661T	1
Oil Pan Set	1937-1941		Cork Rubber	OS31100T	1
Timing Cover Set	1937-1941			JV828	1
Timing Cover Seal	1937-1941			49618	1

MISCELLANEOUS GASKETS					
Push Rod Cover Set	1937-1941			PS39519	1
Water Outlet Gasket	1937-1941			C25487	1

37 372 CID (6.1L) RD372 International 6 Cyl, 4.375in./111.1mm (1950-1968) **37**

Part	Year	VIN	Model/Application	Part Number	Qty.
ENGINE GASKETS					
Head Set	1959-1968			HS3205	1
	1958		Thru Serial Number 128919	HS3081	1
			From Serial Number 128919	HS3205	1
	1950-1957			HS3081	1
Lower Set	1950-1968		(Requires Head Set To Make Full Set)	CS3205	1
Cylinder Head Gasket	1959-1968		Nitroseal	3205	1
	1958		From Serial Number 128919	Nitroseal	3205
Valve Cover Set	1950-1968		Cork Rubber	VS39661T	1
Valve Stem Seal, Exh.	1950-1968			B45229	6
Valve Stem Seal, Int.	1952-1968			B45229	6
Manifold Set, Int. & Exh.	1950-1968			MS15039	1
Oil Pan Set	1950-1968		Cork Rubber	OS31100T	1
Rear Main Seal Set	1950-1968			JV726	1
Timing Cover Set	1950-1968			JV828	1
Timing Cover Seal	1950-1968			49618	1

MISCELLANEOUS GASKETS					
Push Rod Cover Set	1950-1968			PS39519	1
Water Outlet Gasket	1950-1968			C25487	1

Navistar/International

38 392 CID (6.4L) V392 International V8 Cyl, 4.125in./104.8mm (1969-1982)

38

Part	Year	VIN	Model/Application	Part Number	Qty.
ENGINE GASKETS					
Head Set	1974-1982		Improved Cooling	HS3885VC	1
	1973-1974		From Serial Number 1013196, Improved Cooling	HS3885VC	1
	1973		Except Improved Cooling, Thru Serial Number 1013196	HS3832X	1
	1969-1972		Except Improved Cooling	HS3832X	1
Lower Set	1969-1982		(Requires Head Set To Make Full Set)	CS3175	1
Engine Kit Gasket Set	1969-1980		Except Improved Cooling, Thru Serial Number 1013196	95-3003VR	1
			From Serial Number 1013196, Improved Cooling	95-3035VR	1
Cylinder Head Gasket	1974-1982		Improved Cooling <i>VR2000</i>	3885VC	2
	1973-1974		From Serial Number 1013196, Improved Cooling <i>VR2000</i>	3885VC	2
	1973		Except Improved Cooling, Thru Serial Number 1013196 <i>Solicor</i>	3832	2
	1969-1972		Except Improved Cooling <i>Solicor</i>	3832	2
Valve Cover Set	1969-1982		<i>Cork Rubber</i>	VS38410	1
Valve Stem Seal, Exh.	1969-1982			B45229	8
Valve Stem Seal, Int.	1969-1982			B45229	8
Manifold Set, Exhaust	1969-1982			MS15094	1
Manifold Set, Intake	1974-1982		Improved Cooling	MS15081X	1
	1973-1974		From Serial Number 1013196, Improved Cooling	MS15081X	1
	1973		Except Improved Cooling, Thru Serial Number 1013196	MS15081	1
	1969-1972		Except Improved Cooling	MS15081	1
Oil Pan Set	1969-1982		<i>Cork Rubber</i>	OS30765	1
Rear Main Seal	1969-1982			46802	1
Rear Main Seal Set	1969-1982		<i>Rubber</i>	JV724	1
Crank Repair Sleeve	1969-1982		Use With Part Number A506, Rear <i>Nickel Plated Formed Steel, .013" Thickness</i>	A336	1
Timing Cover Set	1969-1982			JV825	1
Timing Cover Seal	1969-1982			49745	1
			(Contains Sleeve)	SS49745	1

MISCELLANEOUS GASKETS

Air Cleaner Mount Gasket	1982		2 Barrel Carburetor	G27098	1
	1969-1974		2 Barrel Carburetor	G27098	1
Exhaust Pipe Gasket	1969-1982		(Ring Type 'B'), Pipe To Manifold <i>2.658" Outside Diameter</i>	F7202	2
			(Ring Type 'B'), Pipe To Manifold <i>2.790" Outside Diameter</i>	F7452	2
Fuel Pump Gasket	1969-1982			D27094	1
Push Rod Cover Set	1969-1982			PS38998	1
Therm. Housing Gasket	1969-1982			C26472	1
Water Outlet Gasket	1969-1982			C26472	2
Water Pump Mount Gasket	1969-1982			K27896	1

39 400 CID (6.6L) V400 International V8 Cyl, 4.165in./105.8mm (1974-1975)

39

Part	Year	VIN	Model/Application	Part Number	Qty.
ENGINE GASKETS					
Head Set	1974		(Exhaust Pipe Gasket Not Included, Intake Manifold Gasket Not Included)	HS3467	1
Full Set	1974		(Exhaust Pipe Gasket Not Included, Intake Manifold Gasket Not Included)	FS3467	1
Engine Kit Gasket Set	1974-1975		(Intake Manifold Gasket Not Included), Use With Part Number MS15922	95-3339VR	1
Cylinder Head Gasket	1974		<i>VR2000</i>	3467	2
Valve Cover Set	1974		<i>Cork Rubber</i>	VS28317	1
Valve Stem Seal, Exh.	1974			B45298	8
Valve Stem Seal, Int.	1974			B45298	8
Manifold Set, Exhaust	1974			MS14143	1
Manifold Set, Intake	1974			MS15922	1
Oil Pan Set	1974		<i>Cork Rubber</i>	OS30538	1

39 400 CID (6.6L) V400 International V8 Cyl, 4.165in./105.8mm (1974-1975) **39**
(cont.) (cont.)

Part	Year	VIN	Model/Application	Part Number	Qty.
ENGINE GASKETS (cont.)					
Rear Main Seal Set	1974			JV638	1
Timing Cover Set	1974		(Repair Sleeve Not Included)	JV870	1
Timing Cover Seal	1974			Rubber 46843	1
Harmonic Balancer Repair Sleeve	1974		Use With Part Number A500 Nickel Plated Formed Steel, .013" Thickness	A222	1

MISCELLANEOUS GASKETS					
Air Cleaner Mount Gasket	1974		2 Barrel Carburetor	G27098	1
Exhaust Pipe Gasket	1974		(Ring Type 'B'), Pipe To Manifold	F7201	2
Fuel Pump Gasket	1974			D27094	1
Water Outlet Gasket	1974			C24111	1
Water Pump Mount Gasket	1974			K14740	1

40 401 CID (6.6L) V401 International V8 Cyl, 4.125in./104.8mm (1956-1972) **40**

Part	Year	VIN	Model/Application	Part Number	Qty.
ENGINE GASKETS					
Head Set	1956-1972			HS3109W	1
Lower Set	1956-1972		(Requires Head Set To Make Full Set)	CS3108	1
Valve Cover Set	1956-1972			Cork Rubber VS39742F	1
Valve Stem Seal, Exh.	1956-1972		Before Serial Number 139494	B45377	8
Valve Stem Seal, Int.	1956-1972		From Serial Number 139494	B45229	8
Manifold Set, Exhaust	1956-1972			MS14093	2
Manifold Set, Intake	1956-1972			MS7303	1
Oil Pan Set	1956-1972			Cork Rubber OS31571	1
Rear Main Seal Set	1956-1972			JV697	1
Timing Cover Set	1956-1972			JV829	1
Timing Cover Seal	1956-1972			49745	1
			(Contains Sleeve)	SS49745	1

MISCELLANEOUS GASKETS					
Exhaust Pipe Gasket	1956-1972		(Ring Type 'A'), Crossover Pipe To Manifold	F9999	2
Fuel Pump Gasket	1956-1972			D27094	1
Push Rod Cover Set	1956-1972			PS38272	1
Water Outlet Gasket	1956-1972			C25487	4

41 401 CID (6.6L) VS401 International V8 Cyl, 4.125in./104.8mm (1968-1974) **41**

Part	Year	VIN	Model/Application	Part Number	Qty.
ENGINE GASKETS					
Head Set	1968-1974			HS3109W	1
Lower Set	1968-1974		(Requires Head Set To Make Full Set)	CS3108	1
Valve Cover Set	1968-1974			Cork Rubber VS39742F	1
Valve Stem Seal, Exh.	1968-1974		From Serial Number 139494	B45229	8
			Before Serial Number 139494	B45377	8
Valve Stem Seal, Int.	1968-1974			B45229	8
Manifold Set, Exhaust	1968-1974			MS14093	2
Manifold Set, Intake	1968-1974			MS7303	1
Oil Pan Set	1968-1974			Cork Rubber OS31571	1
Rear Main Seal Set	1968-1974			JV697	1
Timing Cover Set	1968-1974			JV829	1
Timing Cover Seal	1968-1974			49745	1
			(Contains Sleeve)	SS49745	1

MISCELLANEOUS GASKETS					
Fuel Pump Gasket	1968-1974			D27094	1

LIGHT TRUCK

Navistar/International

41	401 CID (6.6L) VS401 International V8 Cyl, 4.125in./104.8mm (1968-1974)	41
(cont.)		(cont.)

Part	Year	VIN	Model/Application	Part Number	Qty.
------	------	-----	-------------------	-------------	------

MISCELLANEOUS GASKETS (cont.)

Push Rod Cover Set	1968-1974			PS38272	1
Water Outlet Gasket	1968-1974			C25487	4

42	404 CID (6.6L) MV404 International V8 Cyl, 4.125in./104.8mm (1975-1982)	42
-----------	--	-----------

Part	Year	VIN	Model/Application	Part Number	Qty.
------	------	-----	-------------------	-------------	------

ENGINE GASKETS

Head Set	1975-1982		(Intake Manifold Gasket Not Included)	HS3521	1	
Lower Set	1975-1982		(Requires Head Set To Make Full Set)	CS3521W	1	
Cylinder Head Gasket	1975-1982		<i>VR2000</i>	3521	2	
Valve Cover Set	1975-1982		<i>Cork Rubber</i>	VS39765	1	
Valve Stem Seal, Exh.	1975-1982			B45690	8	
Valve Stem Seal, Int.	1975-1982			B45690	8	
Manifold Set, Exhaust	1975-1982			MS15094Y	1	
Manifold Set, Intake	1975-1982			MS15939	1	
Oil Pan Set	1975-1982		Liquid Propane Gas	MS15939BF	1	
			Original Equipment Uses RTV	<i>Silicone</i>	JV6	1
			(Optional)	<i>Cork Rubber</i>	OS32052	1
Rear Main Seal	1975-1982			46802	1	
Rear Main Seal Set	1975-1982			JV622	1	
Timing Cover Set	1975-1982			JV888	1	
Timing Cover Seal	1975-1982			49450	1	

MISCELLANEOUS GASKETS

Fuel Pump Gasket	1975-1982			D27094	1
------------------	-----------	--	--	--------	---

43	406 CID (6.7L) RD406 International 6 Cyl, 4.375in./111.1mm (1952-1974)	43
-----------	---	-----------

Part	Year	VIN	Model/Application	Part Number	Qty.
------	------	-----	-------------------	-------------	------

ENGINE GASKETS

Head Set	1962-1974			HS3205	1
	1969-1972		From Serial Number 128412	HS3205	1
	1959-1972			HS3205	1
	1958-1963		From Serial Number 128412	HS3205	1
	1959-1962			HS3205	1
	1957-1958		Thru Serial Number 128412	HS3081	1
	1952-1957			HS3081	1
Lower Set	1952-1974		(Requires Head Set To Make Full Set)	CS3205	1
Cylinder Head Gasket	1962-1974		<i>Nitroseal</i>	3205	1
	1958-1972		From Serial Number 128412	<i>Nitroseal</i>	3205
	1964-1971		<i>Nitroseal</i>	3205	1
Valve Cover Set	1952-1974		<i>Cork Rubber</i>	VS39661T	1
Valve Stem Seal, Exh.	1952-1974			B45229	6
Valve Stem Seal, Int.	1952-1974			B45229	6
Manifold Set, Int. & Exh.	1952-1974			MS15039	1
Oil Pan Set	1952-1974		<i>Cork Rubber</i>	OS31100T	1
Rear Main Seal Set	1952-1974			JV726	1
Timing Cover Set	1952-1974			JV828	1
Timing Cover Seal	1952-1974			49618	1

MISCELLANEOUS GASKETS

Push Rod Cover Set	1952-1974			PS39519	1
Water Outlet Gasket	1952-1974			C25487	1

LIGHT TRUCK

44 420 CID (6.9L) Navistar Diesel V8 Cyl, 4.000in./101.6mm (1983-1987) 44

Part	Year	VIN	Model/Application	Part Number	Qty.
ENGINE GASKETS					
Head Set	1983-1987		(Intake Manifold Gasket Not Included)	HS3789	1
Full Set	1983-1987		(Intake Manifold Gasket Not Included)	FS3789	1
Engine Kit Gasket Set	1983-1987		(Intake Manifold Gasket Not Included), Use With Part Number MS15968	95-3337VR	1
Cylinder Head Gasket	1983-1987		Nitroseal	3789G	2
Cyl. Head Bolt Set	1983-1987			GS33347	2
Valve Cover Set	1983-1987		Cork Rubber	VS39471	1
			Victo-Tech	VS50214	1
Valve Stem Seal, Exh.	1983-1987		(Oil Shield Type)	B45607	8
Valve Stem Seal, Int.	1983-1987		(Positive Type)	B45560	8
			(Oil Shield Type)	B45607	8
Manifold Set, Exhaust	1983-1987		(One Piece Per Head Design Gasket) VR2000	MS15369	1
Manifold Set, Intake	1983-1987			MS15968	1
Oil Pan Set	1983-1987		Cork Rubber	OS32053	1
Rear Main Seal Set	1983-1987			JV547	1
Crank Repair Sleeve	1983-1987		Use With Part Number A506, Rear Nickel Plated Formed Steel, .013" Thickness	A336	1
Timing Cover Set	1983-1987			JV1019	1

MISCELLANEOUS GASKETS

Exhaust Pipe Gasket	1983-1986		(Flange Type), Pipe To Converter	F14145	1
Fuel Pump Gasket	1983-1987			D27094	1
			Tuff-Cork	D27094TC	1
Water Outlet Gasket	1983-1987		Left	C24550	1
			Right	C24551	1
Water Pump Mount Gasket	1983-1987			K27163	1

45 444 CID (7.3L) Indirect Injection International Diesel V8 Cyl, 4.110in./104.4mm (1988-1994) 45

Part	Year	VIN	Model/Application	Part Number	Qty.
ENGINE GASKETS					
Head Set	1988-1992		(Intake Manifold Gasket Not Included)	HS5869	1
Full Set	1988-1992		(Intake Manifold Gasket Not Included)	FS5869	1
Engine Kit Gasket Set	1988-1994		(Intake Manifold Gasket Not Included), Use With Part Number MS15968	95-3299VR	1
Cylinder Head Gasket	1988-1992		Nitroseal	5869G	2
Cyl. Head Bolt Set	1988-1992			GS33348	2
Valve Cover Set	1988-1992		Cork Rubber	VS39471	1
			Victo-Tech	VS50214	1
Valve Stem Seal, Exh.	1988-1992			B45662	8
Valve Stem Seal, Int.	1988-1992		(Positive Type)	B45560	8
Manifold Set, Exhaust	1988-1994		(Multi Piece Per Head Design Gasket) Beaded Steel	MS15369A	1
	1988-1992		(One Piece Per Head Design Gasket) VR2000	MS15369	1
Manifold Set, Intake	1988-1992			MS15968	1
Oil Pan Set	1988-1992		Cork Rubber	OS32053	1
Rear Main Seal Set	1988-1992			JV547	1
Timing Cover Set	1988-1992			JV1019	1
MISCELLANEOUS GASKETS					
Fuel Pump Gasket	1988-1992			D27094	1
			Tuff-Cork	D27094TC	1
Water Outlet Gasket	1988-1992		Left	C24550	1
			Right	C24551	1
Water Pump Mount Gasket	1988-1992			K27163	1

Navistar/International

46 444 CID (7.3L) T444E (Power Stroke) International Diesel V8 Cyl, 4.110in./104.4mm (1994-2001) 46

Part	Year	VIN	Model/Application	Part Number	Qty.
ENGINE GASKETS					
Head Set	1995-1999		To Be Replaced By HS54204A	HS54204	1
Lower Set	1997-2001			CS54204-4	1
	1996			CS54204-3	1
	1995			CS54204-2	1
				Nitroseal 54204	2
Cylinder Head Gasket	1995			54204	2
Cyl. Head Bolt Set	1994-2001			GS33379	2
Valve Stem Seal, Exh.	1995-2001			B45897	8
Valve Stem Seal, Int.	1995-2001			B45897	8
Manifold Set, Exhaust	1995-2000		Nitroseal	MS16314	1
Rear Main Seal	1994-2001			67628	1

47 446 CID (7.3L) MV446 International V8 Cyl, 4.125in./104.8mm (1975-1981) 47

Part	Year	VIN	Model/Application	Part Number	Qty.
ENGINE GASKETS					
Head Set	1975-1981		(Intake Manifold Gasket Not Included)	HS3521	1
Lower Set	1975-1981		(Requires Head Set To Make Full Set)	CS3521W	1
Cylinder Head Gasket	1975-1981		VR2000	3521	2
Valve Cover Set	1975-1981		Cork Rubber	VS39765	1
Valve Stem Seal, Exh.	1975-1981			B45690	8
Valve Stem Seal, Int.	1975-1981			B45690	8
Manifold Set, Exhaust	1975-1981			MS15094Y	1
			Liquid Propane Gas	MS15939BF	1
Manifold Set, Intake	1975-1981			MS15939	1
			Liquid Propane Gas	MS15939BF	1
Oil Pan Set	1975-1981		Original Equipment Uses RTV	JV6	1
			(Optional) Silicone Cork Rubber	OS32052	1
Rear Main Seal	1975-1981			46802	1
Rear Main Seal Set	1975-1981			JV622	1
Timing Cover Set	1975-1981			JV888	1
Timing Cover Seal	1975-1981			49450	1

MISCELLANEOUS GASKETS

Fuel Pump Gasket	1975-1981			D27094	1
------------------	-----------	--	--	--------	---

48 450 CID (7.4L) FBC450 International 6 Cyl, 4.375in./111.1mm (1941-1943) 48

Part	Year	VIN	Model/Application	Part Number	Qty.
ENGINE GASKETS					
Valve Cover Set	1941-1943		Cork Rubber	VS39661T	1
Oil Pan Set	1941-1943		Cork Rubber	OS31100T	1
Timing Cover Set	1941-1943			JV828	1
Timing Cover Seal	1941-1943			49618	1

MISCELLANEOUS GASKETS

Push Rod Cover Set	1941-1943			PS39519	1
Water Outlet Gasket	1941-1943			C25487	1

49 450 CID (7.4L) RD450 International 6 Cyl, 4.375in./111.1mm (1955-1974) 49

Part	Year	VIN	Model/Application	Part Number	Qty.
ENGINE GASKETS					
Head Set	1959-1974			HS3205	1
	1958		From Serial Number 128412	HS3205	1
	1957-1958		Thru Serial Number 128412	HS3081	1
	1955-1956			HS3081	1
Lower Set	1955-1974		(Requires Head Set To Make Full Set)	CS3205	1
Cylinder Head Gasket	1959-1974		Nitroseal	3205	1

49 450 CID (7.4L) RD450 International 6 Cyl, 4.375in./111.1mm (1955-1974) **49**
(cont.) (cont.)

Part Year VIN Model/Application Part Number Qty.

ENGINE GASKETS (cont.)

Cylinder Head Gasket (cont.)	1958		From Serial Number 128412		
Valve Cover Set	1955-1974			Nitroseal Cork Rubber	3205 VS39661T
Valve Stem Seal, Exh.	1955-1974				B45229
Valve Stem Seal, Int.	1955-1974				B45229
Manifold Set, Int. & Exh.	1955-1974				MS15039
Oil Pan Set	1955-1974			Cork Rubber	OS31100T
Rear Main Seal Set	1955-1974				JV726
Timing Cover Set	1955-1974				JV828
Timing Cover Seal	1955-1974				49618

MISCELLANEOUS GASKETS

Push Rod Cover Set	1955-1974				PS39519
Water Outlet Gasket	1955-1974				C25487

50 450 CID (7.4L) RED450 International 6 Cyl, 4.375in./111.1mm (1944-1957) **50**

Part Year VIN Model/Application Part Number Qty.

ENGINE GASKETS

Head Set	1956-1957				HS1619Y
	1944-1949				HS1619Y
Lower Set	1956-1957		(Requires Head Set To Make Full Set)		CS3205
	1944-1949		(Requires Head Set To Make Full Set)		CS3205
Valve Cover Set	1956-1957			Cork Rubber	VS39661T
	1944-1949			Cork Rubber	VS39661T
Valve Stem Seal, Exh.	1956-1957				B45229
	1944-1949				B45229
Valve Stem Seal, Int.	1956-1957				B45229
	1944-1949				B45229
Manifold Set, Int. & Exh.	1956-1957				MS15039
	1944-1949				MS15039
Oil Pan Set	1956-1957			Cork Rubber	OS31100T
	1944-1949			Cork Rubber	OS31100T
Rear Main Seal Set	1956-1957				JV726
	1944-1949				JV726
Timing Cover Set	1956-1957				JV828
	1944-1949				JV828
Timing Cover Seal	1956-1957				49618
	1944-1949				49618

MISCELLANEOUS GASKETS

Push Rod Cover Set	1956-1957				PS39519
	1944-1949				PS39519
Water Outlet Gasket	1956-1957				C25487
	1944-1949				C25487

51 461 CID (7.6L) V461 International V8 Cyl, 4.125in./104.8mm (1956-1964) **51**

Part Year VIN Model/Application Part Number Qty.

ENGINE GASKETS

Head Set	1956-1964		(Valve Stem Seals Not Included)		HS3108W
Lower Set	1956-1964		(Requires Head Set To Make Full Set)		CS3108
Cylinder Head Gasket	1956-1964				3108
Valve Cover Set	1956-1964			Cork Rubber	VS39742F
Valve Stem Seal, Exh.	1956-1964		From Serial Number 139494		B45229
			Before Serial Number 139494		B45377
Valve Stem Seal, Int.	1956-1964		From Serial Number 139494		B45229

LIGHT TRUCK

Navistar/International

51	461 CID (7.6L) V461 International V8 Cyl, 4.125in./104.8mm (1956-1964)	51
(cont.)		(cont.)

Part	Year	VIN	Model/Application	Part Number	Qty.
ENGINE GASKETS (cont.)					
Valve Stem Seal, Int. (cont.)	1956-1964		Before Serial Number 139494	B45377	8
Manifold Set, Exhaust	1956-1964			MS14093	2
Manifold Set, Intake	1956-1964			MS7303	1
Oil Pan Set	1956-1964		<i>Cork Rubber</i>	OS31571	1
Rear Main Seal Set	1956-1964			JV697	1
Timing Cover Set	1956-1964			JV829	1

MISCELLANEOUS GASKETS					
Carb. Mount Gasket	1956-1964		2 Barrel Carburetor	G30709	1
Exhaust Pipe Gasket	1956-1964		(Ring Type 'A'), Crossover Pipe To Manifold, Pipe To Manifold	F9999	2
Fuel Pump Gasket	1956-1964			D27094	1
Push Rod Cover Set	1956-1964			PS38272	1

52	478 CID (7.8L) V478 International V8 Cyl, 4.500in./114.3mm (1965-1972)	52
-----------	---	-----------

Part	Year	VIN	Model/Application	Part Number	Qty.
------	------	-----	-------------------	-------------	------

ENGINE GASKETS					
Head Set	1965-1972		(Valve Stem Seals Not Included)	HS3108W	1
Lower Set	1965-1972		(Requires Head Set To Make Full Set)	CS3108	1
Cylinder Head Gasket	1965-1972			3108	2
Valve Cover Set	1965-1972		<i>Cork Rubber</i>	VS39742F	1
Valve Stem Seal, Exh.	1965-1972		From Serial Number 139494	B45229	8
			Before Serial Number 139494	B45377	8
Valve Stem Seal, Int.	1965-1972		From Serial Number 139494	B45229	8
			Before Serial Number 139494	B45377	8
Manifold Set, Exhaust	1965-1972			MS14093	2
Manifold Set, Intake	1965-1972			MS7303	1
Oil Pan Set	1965-1972		<i>Cork Rubber</i>	OS31571	1
Rear Main Seal Set	1965-1972			JV697	1
Timing Cover Set	1965-1972			JV829	1
Timing Cover Seal	1965-1972			49745	1
			(Contains Sleeve)	SS49745	1

MISCELLANEOUS GASKETS					
Carb. Mount Gasket	1965-1972		2 Barrel Carburetor	G30709	1
Exhaust Pipe Gasket	1965-1972		(Ring Type 'A'), Crossover Pipe To Manifold, Pipe To Manifold	F9999	2
Fuel Pump Gasket	1965-1972			D27094	1
Push Rod Cover Set	1965-1972			PS38272	1

53	478 CID (7.8L) VS478 International V8 Cyl, 4.500in./114.3mm (1968-1977)	53
-----------	--	-----------

Part	Year	VIN	Model/Application	Part Number	Qty.
------	------	-----	-------------------	-------------	------

ENGINE GASKETS					
Head Set	1968-1977		(Valve Stem Seals Not Included)	HS3108W	1
Lower Set	1968-1977		(Requires Head Set To Make Full Set)	CS3108	1
Cylinder Head Gasket	1968-1977			3108	2
Valve Cover Set	1968-1977		<i>Cork Rubber</i>	VS39742F	1
Valve Stem Seal, Exh.	1968-1977		From Serial Number 139494	B45229	8
			Before Serial Number 139494	B45377	8
Valve Stem Seal, Int.	1968-1977		From Serial Number 139494	B45229	8
			Before Serial Number 139494	B45377	8
Manifold Set, Exhaust	1968-1977			MS14093	2
Manifold Set, Intake	1968-1977			MS7303	1
Oil Pan Set	1968-1977		<i>Cork Rubber</i>	OS31571	1
Rear Main Seal Set	1968-1977			JV697	1
Timing Cover Set	1968-1977			JV829	1

53 478 CID (7.8L) VS478 International V8 Cyl, 4.500in./114.3mm (1968-1977) **53**
(cont.) (cont.)

Part Year VIN Model/Application Part Number Qty.

ENGINE GASKETS (cont.)

Timing Cover Seal	1968-1977			49745	1
			(Contains Sleeve)	SS49745	1

MISCELLANEOUS GASKETS

Carb. Mount Gasket	1968-1977		2 Barrel Carburetor	G30709	1
Exhaust Pipe Gasket	1968-1977		(Ring Type 'A'), Crossover Pipe To Manifold, Pipe To Manifold	F9999	2
Fuel Pump Gasket	1968-1977			D27094	1
Push Rod Cover Set	1968-1977			PS38272	1

54 501 CID (8.2L) RD501 International 6 Cyl, 4.500in./114.3mm (1955-1974) **54**

Part Year VIN Model/Application Part Number Qty.

ENGINE GASKETS

Head Set	1962-1974			HS3205	1
	1958-1972		From Serial Number 128412	HS3205	1
	1964-1968			HS3205	1
	1955-1958		Thru Serial Number 128412	HS3081	1
	1955-1957			HS3081	1
Lower Set	1955-1974		(Requires Head Set To Make Full Set)	CS3205	1
Cylinder Head Gasket	1962-1974			Nitroseal 3205	1
	1958-1972		From Serial Number 128412	Nitroseal 3205	1
	1964-1968			Nitroseal 3205	1
Valve Cover Set	1955-1974			Cork Rubber VS39661T	1
Valve Stem Seal, Exh.	1955-1974			B45229	6
Valve Stem Seal, Int.	1955-1974			B45229	6
Manifold Set, Int. & Exh.	1955-1974			MS15039	1
Oil Pan Set	1955-1974			Cork Rubber OS31100T	1
Rear Main Seal Set	1955-1974			JV725	1
Timing Cover Set	1955-1974			JV828	1
Timing Cover Seal	1955-1974			49618	1

MISCELLANEOUS GASKETS

Carb. Mount Gasket	1955-1974		4 Barrel Carburetor	G30709	1
	1955-1968			G30709	1
Push Rod Cover Set	1955-1974			PS39519	1
Water Outlet Gasket	1955-1974			C25487	1

55 501 CID (8.2L) RD501LPG International LPG 6 Cyl, 4.500in./114.3mm (1955-1972) **55**

Part Year VIN Model/Application Part Number Qty.

ENGINE GASKETS

Head Set	1958-1972		From Serial Number 128412	HS3205	1
	1958		Thru Serial Number 128412	HS3081	1
	1955-1957			HS3081	1
Lower Set	1955-1972		(Requires Head Set To Make Full Set)	CS3205	1
Cylinder Head Gasket	1958-1972		From Serial Number 128412	Nitroseal 3205	1
Valve Cover Set	1955-1972			Cork Rubber VS39661T	1
Valve Stem Seal, Exh.	1955-1972			B45229	6
Valve Stem Seal, Int.	1955-1972			B45229	6
Manifold Set, Int. & Exh.	1955-1972			MS15039	1
Oil Pan Set	1955-1972			Cork Rubber OS31100T	1
Rear Main Seal Set	1955-1972			JV725	1
Timing Cover Set	1955-1972			JV828	1
Timing Cover Seal	1955-1972			49618	1

Navistar/International

55	501 CID (8.2L) RD501LPG International LPG 6 Cyl, 4.500in./114.3mm (1955-1972)	55
(cont.)		(cont.)

Part	Year	VIN	Model/Application	Part Number	Qty.
MISCELLANEOUS GASKETS					
Carb. Mount Gasket	1955-1972		2 Barrel Carburetor	G30709	1
Push Rod Cover Set	1955-1972			PS39519	1
Water Outlet Gasket	1955-1972			C25487	1

56	537 CID (8.8L) V537 International V8 Cyl, 4.625in./117.5mm (1978-1981)	56
-----------	---	-----------

Part	Year	VIN	Model/Application	Part Number	Qty.
ENGINE GASKETS					
Lower Set	1978-1981		(Requires Head Set To Make Full Set)	CS3807W	1
Valve Cover Set	1978-1981		<i>Cork Rubber</i>	VS39757	1
Manifold Set, Exhaust	1978-1981			MS15525	1
Manifold Set, Intake	1978-1981			MS15297	1
			Liquid Propane Gas	MS15297BF	1
Oil Pan Set	1978-1981		<i>Cork Rubber</i>	OS31571	1
Rear Main Seal	1978-1981			SS61197	1
Timing Cover Gasket	1978-1981			T30646	1
Timing Cover Seal	1978-1981			49745	1
			(Contains Sleeve)	SS49745	1

MISCELLANEOUS GASKETS					
Fuel Pump Gasket	1978-1981			D27094	1
Push Rod Cover Set	1978-1981			PS38272	1

57	537 CID (8.8L) VS537 International V8 Cyl, 4.625in./117.5mm (1975-1981)	57
-----------	--	-----------

Part	Year	VIN	Model/Application	Part Number	Qty.
ENGINE GASKETS					
Lower Set	1975-1981		(Requires Head Set To Make Full Set)	CS3807W	1
Valve Cover Set	1975-1981		<i>Cork Rubber</i>	VS39757	1
Manifold Set, Exhaust	1975-1981			MS15525	1
Manifold Set, Intake	1975-1981			MS15297	1
Oil Pan Set	1975-1981		<i>Cork Rubber</i>	OS31571	1
Rear Main Seal	1975-1981			SS61197	1
Timing Cover Gasket	1975-1981			T30646	1
Timing Cover Seal	1975-1981			49745	1
			(Contains Sleeve)	SS49745	1

MISCELLANEOUS GASKETS					
Fuel Pump Gasket	1975-1981			D27094	1
Push Rod Cover Set	1975-1981			PS38272	1

58	549 CID (9.0L) FTV549 International V8 Cyl, 4.500in./114.3mm (1970-1972)	58
-----------	---	-----------

Part	Year	VIN	Model/Application	Part Number	Qty.
ENGINE GASKETS					
Head Set	1970-1972		(Valve Stem Seals Not Included)	HS3108W	1
Lower Set	1970-1972		(Requires Head Set To Make Full Set)	CS3108	1
Cylinder Head Gasket	1970-1972			3108	2
Valve Cover Set	1970-1972		<i>Cork Rubber</i>	VS39742F	1
Valve Stem Seal, Exh.	1970-1972		From Serial Number 139494	B45229	8
			Before Serial Number 139494	B45377	8
Valve Stem Seal, Int.	1970-1972		From Serial Number 139494	B45229	8
			Before Serial Number 139494	B45377	8
Manifold Set, Exhaust	1970-1972			MS14093	2
Manifold Set, Intake	1970-1972			MS7303	1
Oil Pan Set	1970-1972		<i>Cork Rubber</i>	OS31571	1
Rear Main Seal Set	1970-1972			JV697	1
Timing Cover Set	1970-1972			JV829	1

LIGHT TRUCK

58 549 CID (9.0L) FTV549 International V8 Cyl, 4.500in./114.3mm (1970-1972) **58**
(cont.) (cont.)

Part Year VIN Model/Application Part Number Qty.

ENGINE GASKETS (cont.)

Timing Cover Seal	1970-1972			49745	1
			(Contains Sleeve)	SS49745	1

MISCELLANEOUS GASKETS

Carb. Mount Gasket	1970-1972		4 Barrel Carburetor	G30709	1
Exhaust Pipe Gasket	1970-1972		(Ring Type 'A'), Crossover Pipe To Manifold, Pipe To Manifold	F9999	2
Fuel Pump Gasket	1970-1972			D27094	1
Push Rod Cover Set	1970-1972			PS38272	1

59 549 CID (9.0L) FTVS549 International V8 Cyl, 4.500in./114.3mm (1970-1975) **59**

Part Year VIN Model/Application Part Number Qty.

ENGINE GASKETS

Head Set	1970-1975		(Valve Stem Seals Not Included)	HS3108W	1
Lower Set	1970-1975		(Requires Head Set To Make Full Set)	CS3108	1
Cylinder Head Gasket	1970-1975			3108	2
Valve Cover Set	1970-1975		<i>Cork Rubber</i>	VS39742F	1
Valve Stem Seal, Exh.	1970-1975		From Serial Number 139494	B45229	8
			Before Serial Number 139494	B45377	8
Valve Stem Seal, Int.	1970-1975		From Serial Number 139494	B45229	8
			Before Serial Number 139494	B45377	8
Manifold Set, Exhaust	1970-1975			MS14093	2
Manifold Set, Intake	1970-1975			MS7303	1
Oil Pan Set	1970-1975		<i>Cork Rubber</i>	OS31571	1
Rear Main Seal Set	1970-1975			JV697	1
Timing Cover Set	1970-1975			JV829	1
Timing Cover Seal	1970-1975			49745	1
			(Contains Sleeve)	SS49745	1

MISCELLANEOUS GASKETS

Carb. Mount Gasket	1970-1975		4 Barrel Carburetor	G30709	1
Exhaust Pipe Gasket	1970-1975		(Ring Type 'A'), Crossover Pipe To Manifold, Pipe To Manifold	F9999	2
Fuel Pump Gasket	1970-1975			D27094	1
Push Rod Cover Set	1970-1975			PS38272	1

60 549 CID (9.0L) V549 International V8 Cyl, 4.500in./114.3mm (1956-1972) **60**

Part Year VIN Model/Application Part Number Qty.

ENGINE GASKETS

Head Set	1956-1972		(Valve Stem Seals Not Included)	HS3108W	1
Lower Set	1956-1972		(Requires Head Set To Make Full Set)	CS3108	1
Cylinder Head Gasket	1956-1972			3108	2
Valve Cover Set	1956-1972		<i>Cork Rubber</i>	VS39742F	1
Valve Stem Seal, Exh.	1956-1972		From Serial Number 139494	B45229	8
			Before Serial Number 139494	B45377	8
Valve Stem Seal, Int.	1956-1972		From Serial Number 139494	B45229	8
			Before Serial Number 139494	B45377	8
Manifold Set, Exhaust	1956-1972			MS14093	2
Manifold Set, Intake	1956-1972			MS7303	1
Oil Pan Set	1956-1972		<i>Cork Rubber</i>	OS31571	1
Rear Main Seal Set	1956-1972			JV697	1
Timing Cover Set	1956-1972			JV829	1
Timing Cover Seal	1956-1972			49745	1
			(Contains Sleeve)	SS49745	1

MISCELLANEOUS GASKETS

Carb. Mount Gasket	1956-1972		4 Barrel Carburetor	G30709	1
--------------------	-----------	--	---------------------	--------	---

Navistar/International

60 549 CID (9.0L) V549 International V8 Cyl, 4.500in./114.3mm (1956-1972) **60**
(cont.) (cont.)

Part	Year	VIN	Model/Application	Part Number	Qty.
MISCELLANEOUS GASKETS (cont.)					
Carb. Mount Gasket (cont.)	1956-1968			G30709	1
Exhaust Pipe Gasket	1956-1972		(Ring Type 'A'), Crossover Pipe To Manifold	F9999	2
			(Ring Type 'A'), Pipe To Manifold	F9999	2
	1970-1971		(Ring Type 'A'), Crossover Pipe To Manifold, Pipe To Manifold	F9999	2
Fuel Pump Gasket	1956-1972			D27094	1
Push Rod Cover Set	1956-1972			PS38272	1

61 549 CID (9.0L) VS49 International V8 Cyl, 4.500in./114.3mm (1968-1978) **61**

Part	Year	VIN	Model/Application	Part Number	Qty.
ENGINE GASKETS					
Head Set	1968-1978		(Valve Stem Seals Not Included)	HS3108W	1
Lower Set	1968-1978		(Requires Head Set To Make Full Set)	CS3108	1
Cylinder Head Gasket	1968-1978			3108	2
Valve Cover Set	1968-1978		<i>Cork Rubber</i>	VS39742F	1
Valve Stem Seal, Exh.	1968-1978		From Serial Number 139494	B45229	8
			Before Serial Number 139494	B45377	8
Valve Stem Seal, Int.	1968-1978		From Serial Number 139494	B45229	8
			Before Serial Number 139494	B45377	8
Manifold Set, Exhaust	1968-1978			MS14093	2
Manifold Set, Intake	1968-1978			MS7303	1
Oil Pan Set	1968-1978		<i>Cork Rubber</i>	OS31571	1
Rear Main Seal Set	1968-1978			JV697	1
Timing Cover Set	1968-1978			JV829	1
Timing Cover Seal	1968-1978			49745	1
			(Contains Sleeve)	SS49745	1

MISCELLANEOUS GASKETS					
Carb. Mount Gasket	1968-1978		4 Barrel Carburetor	G30709	1
Exhaust Pipe Gasket	1968-1978		(Ring Type 'A'), Crossover Pipe To Manifold	F9999	2
			(Ring Type 'A'), Pipe To Manifold	F9999	2
	1975-1976		(Ring Type 'A'), Crossover Pipe To Manifold, Pipe To Manifold	F9999	2
	1969-1972		(Ring Type 'A'), Crossover Pipe To Manifold, Pipe To Manifold	F9999	2
Fuel Pump Gasket	1968-1978			D27094	1
Push Rod Cover Set	1968-1978			PS38272	1

Nissan Truck

Engine Index

Engine	Year	Block	Engine	Year	Block
1299CC (1.3L) J13 Nissan	1965-1969	1	2389CC (2.4L) KA24E SOHC Nissan	1989-1997	9
1595CC (1.6L) L16 Nissan	1969-1973	2	2389CC (2.4L) Z24/Z24i Nissan	1983-1989	10
1770CC (1.8L) L18 Nissan	1974	3	2488CC (2.5L) SD25 OHV Nissan Diesel	1983-1985	11
1952CC (2.0L) L20B Nissan	1975-1980	4	2960CC (3.0L) VG30 SOHC Nissan	1986-1989	12
1952CC (2.0L) Z20 Nissan	1983-1985	5	2960CC (3.0L) VG30E SOHC Nissan	1990-1998	13
2164CC (2.2L) SD22 OHV Nissan Diesel	1981-1983	6	2960CC (3.0L) VG30i SOHC Nissan	1987-1989	14
2187CC (2.2L) Z22 SOHC Nissan	1981-1983	7	3275CC (3.3L) VG33E SOHC Nissan	1996-2002	15
2389CC (2.4L) KA24DE DOHC Nissan	1998-2001	8	3275CC (3.3L) VG33ER SOHC Nissan	2001-2002	16

Model Index

Model	Engine	Year	Block	Model	Engine	Year	Block
520	1299CC (1.3L) J13 Nissan	1965-1968	1	620	1952CC (2.0L) L20B Nissan	1975-1979	4
521	1299CC (1.3L) J13 Nissan	1968-1969	1	720	1952CC (2.0L) Z20 Nissan	1983-1985	5
521	1595CC (1.6L) L16 Nissan	1969-1972	2	720	1952CC (2.0L) L20B Nissan	1980	4
620	1595CC (1.6L) L16 Nissan	1972-1973	2	720	2164CC (2.2L) SD22 OHV Nissan Diesel	1981-1983	6
620	1770CC (1.8L) L18 Nissan	1974	3				

Model Index (cont.)

Model	Engine	Year	Block	Model	Engine	Year	Block
720	2187CC (2.2L) Z22 SOHC Nissan	1981-1983	7	Pathfinder	2389CC (2.4L) Z24/Z24i Nissan	1987-1989	10
720	2389CC (2.4L) Z24/Z24i Nissan	1983-1986	10	Pathfinder	2960CC (3.0L) VG30E SOHC Nissan	1990-1995	13
720	2488CC (2.5L) SD25 OHV Nissan Diesel	1983-1986	11	Pathfinder	2960CC (3.0L) VG30i SOHC Nissan	1987-1989	14
Axxess	2389CC (2.4L) KA24E SOHC Nissan	1989-1992	9	Pathfinder	3275CC (3.3L) VG33E SOHC Nissan	1996-2000	15
D21	2389CC (2.4L) KA24E SOHC Nissan	1990-1997	9	Quest	2960CC (3.0L) VG30E SOHC Nissan	1993-1998	13
D21	2389CC (2.4L) Z24/Z24i Nissan	1986-1989	10	Quest	3275CC (3.3L) VG33E SOHC Nissan	1999-2002	15
D21	2960CC (3.0L) VG30E SOHC Nissan	1990-1996	13	Van	2389CC (2.4L) Z24/Z24i Nissan	1986-1989	10
D21	2960CC (3.0L) VG30 SOHC Nissan	1986-1989	12	Xterra	2389CC (2.4L) KA24DE DOHC Nissan	2000-2004	8
Frontier	2389CC (2.4L) KA24DE DOHC Nissan	1998-2004	8	Xterra	3275CC (3.3L) VG33ER SOHC Nissan	2002-2004	16
Frontier	3275CC (3.3L) VG33ER SOHC Nissan	2001-2004	16	Xterra	3275CC (3.3L) VG33E SOHC Nissan	2000-2004	15
Frontier	3275CC (3.3L) VG33E SOHC Nissan	1999-2004	15				

1 1299CC (1.3L) J13 Nissan 4 Cyl, 2.874in./73mm (1965-1969) 1

Part	Year	VIN	Model/Application	Part Number	Qty.
------	------	-----	-------------------	-------------	------

ENGINE GASKETS

Head Set	1965-1969			HS3597	1
Full Set	1965-1969			FS3597	1
Cylinder Head Gasket	1965-1969		VR2000	3597	1
Valve Cover Set	1965-1969		Cork Rubber	VS30016	1
Manifold Set, Int. & Exh.	1965-1969			MS15233	1
Oil Pan Set	1965-1969		Cork Rubber	OS30054	1
Rear Main Seal Set	1965-1969			JV639	1
Timing Cover Gasket	1965-1969			T20131	1
Timing Cover Seal	1965-1969			66533	1

MISCELLANEOUS GASKETS

Exhaust Pipe Gasket	1965-1969		(Flange Type), Pipe To Manifold	F14601	1
Water Outlet Gasket	1965-1969			C24093	1

2 1595CC (1.6L) L16 Nissan 4 Cyl, 3.268in./83mm (1969-1973) 2

Part	Year	VIN	Model/Application	Part Number	Qty.
------	------	-----	-------------------	-------------	------

ENGINE GASKETS

Head Set	1969-1973			HS3603	1
Full Set	1969-1973			FS3603	1
Engine Kit Gasket Set	1969-1973			95-3354VR	1
Cylinder Head Gasket	1969-1973		VR2000	3603	1
Sealing Compound	1969-1973		(4 Ounce Brush Top Can)	JV66B	1
			(12 Ounce Spray Can)	JV66S	1
Valve Cover Set	1969-1973		Cork Rubber	VS30015	1
Valve Stem Seal, Exh.	1969-1973			B20183	4
Valve Stem Seal, Int.	1969-1973			B20183	4
Manifold Set, Int. & Exh.	1969-1973			MS15241	1
Oil Pan Set	1969-1973		Cork Rubber	OS30051	1
Rear Main Seal Set	1969-1973			JV637	1
Timing Cover Set	1969-1973			JV916	1
Timing Cover Seal	1969-1973			47658	1

MISCELLANEOUS GASKETS

E.G.R. Gasket	1969-1973			G26315	1
Exhaust Pipe Gasket	1969-1973		(Flange Type), Pipe To Manifold	F14599	1

Nissan Truck

2 (cont.)	1595CC (1.6L) L16 Nissan 4 Cyl, 3.268in./83mm (1969-1973)				2 (cont.)
---------------------	--	--	--	--	---------------------

Part	Year	VIN	Model/Application	Part Number	Qty.
MISCELLANEOUS GASKETS (cont.)					
Fuel Pump Gasket	1969-1973			D24076	2
Water Outlet Gasket	1969-1973		(2 Holes) Victopac	C20115	1
Water Pump Mount Gasket	1969-1973			K26081	1

3	1770CC (1.8L) L18 Nissan 4 Cyl, 3.346in./85mm (1974)				3
----------	---	--	--	--	----------

Part	Year	VIN	Model/Application	Part Number	Qty.
ENGINE GASKETS					
Head Set	1974			HS3603	1
Full Set	1974			FS3603	1
Engine Kit Gasket Set	1974			95-3354VR	1
Cylinder Head Gasket	1974		VR2000	3603	1
Sealing Compound	1974		(4 Ounce Brush Top Can)	JV66B	1
			(12 Ounce Spray Can)	JV66S	1
Valve Cover Set	1974		Cork Rubber	VS30015	1
Valve Stem Seal, Exh.	1974			B20183	4
Valve Stem Seal, Int.	1974			B20183	4
Manifold Set, Int. & Exh.	1974			MS15241	1
Oil Pan Set	1974		Cork Rubber	OS30051	1
Rear Main Seal Set	1974			JV637	1
Timing Cover Set	1974			JV916	1
Timing Cover Seal	1974			47658	1

MISCELLANEOUS GASKETS					
E.G.R. Gasket	1974			G26315	1
Exhaust Pipe Gasket	1974		(Flange Type), Pipe To Manifold	F14599	1
Fuel Pump Gasket	1974			D24076	2
Water Outlet Gasket	1974		(2 Holes) Victopac	C20115	1
Water Pump Mount Gasket	1974			K26081	1

4	1952CC (2.0L) L20B Nissan 4 Cyl, 3.346in./85mm (1975-1980)				4
----------	---	--	--	--	----------

Part	Year	VIN	Model/Application	Part Number	Qty.
ENGINE GASKETS					
Head Set	1977-1980			HS3603W	1
	1975-1976			HS3603Y	1
Full Set	1977-1980			FS3603W	1
	1975-1976			FS3603Y	1
Engine Kit Gasket Set	1978-1980			95-3079VR	1
	1975-1977			95-3354VR	1
Cylinder Head Gasket	1975-1980		VR2000	3603	1
Sealing Compound	1975-1980		(4 Ounce Brush Top Can)	JV66B	1
			(12 Ounce Spray Can)	JV66S	1
Valve Cover Set	1975-1980		Cork Rubber	VS30015	1
Valve Stem Seal, Exh.	1975-1980			B20183	4
Valve Stem Seal, Int.	1975-1980			B20183	4
Manifold Set, Int. & Exh.	1977-1980		Round Ports	MS15284	1
	1975-1976		Rectangular Ports	MS15580	1
Oil Pan Set	1975-1980		Cork Rubber	OS30051	1
Rear Main Seal Set	1975-1980			JV637	1
Timing Cover Set	1975-1980			JV916	1
Timing Cover Seal	1975-1980			47658	1

MISCELLANEOUS GASKETS					
Carb. Mount Gasket	1978-1980		2 Barrel Carburetor	G31154	1

4 1952CC (2.0L) L20B Nissan 4 Cyl, 3.346in./85mm (1975-1980) **4**
(cont.) (cont.)

Part	Year	VIN	Model/Application	Part Number	Qty.
MISCELLANEOUS GASKETS (cont.)					
E.G.R. Gasket	1975-1980			G26315	1
Exhaust Pipe Gasket	1975-1980		(Flange Type), Catalytic Converter To Exhaust Pipe, Pipe To Manifold	F20188	2
Fuel Pump Gasket	1975-1980			D24076	2
Oil Pump Inlet Tube	1975-1980			B45711	2
Oil Pump Mounting Gasket	1975-1980			B45694	1
Water Inlet Gasket	1975-1980			C26075	1
Water Outlet Gasket	1975-1980		(2 Holes)	Victopac C20115	1
			(3 Holes)	C24179	1
Water Pump Mount Gasket	1975-1980			K26081	1

5 1952CC (2.0L) Z20 Nissan 4 Cyl, 3.346in./85mm (1983-1985) **5**

Part	Year	VIN	Model/Application	Part Number	Qty.
ENGINE GASKETS					
Head Set	1983-1985			HS3691Y	1
Full Set	1983-1985			FS3691Y	1
Cylinder Head Gasket	1983-1985		VR2000	3691	1
Valve Cover Set	1983-1985		(Contains Valve Cover End Plug) Victo-Tech	VS38371	1
Valve Stem Seal, Exh.	1983-1985			B20183	4
Valve Stem Seal, Int.	1983-1985			B20183	4
Manifold Set, Exhaust	1983-1985			MS12275	1
Manifold Set, Intake	1983-1985		(Contains Plenum Chamber Gasket)	MS15322	1
Oil Pan Set	1983-1985		Cork Rubber	OS30051	1
Rear Main Seal Set	1983-1985			JV637	1
Timing Cover Set	1983-1985			JV916	1
Timing Cover Seal	1983-1985			47658	1

MISCELLANEOUS GASKETS					
E.G.R. Gasket	1983-1985			G26315	1
Exhaust Pipe Gasket	1983-1985		(Flange Type), Pipe To Manifold	F10047	1
Oil Pump Inlet Tube	1983-1985			B45711	1
Oil Pump Mounting Gasket	1983-1985			B45694	1
Valve Cover End Plug	1983-1985			B45488	2
Water Outlet Gasket	1983-1985		(2 Holes) Victopac	C20115	1
Water Pump Mount Gasket	1983-1985			K26081	1

6 2164CC (2.2L) SD22 OHV Nissan Diesel 4 Cyl, 3.268in./83mm (1981-1983) **6**

Part	Year	VIN	Model/Application	Part Number	Qty.
ENGINE GASKETS					
Head Set	1981-1983			HS3734	1
Full Set	1981-1983			FS3734	1
Cylinder Head Gasket	1981-1983		Steel	3734	1
Valve Cover Set	1981-1983		(Contains Valve Cover Washers) Victo-Tech	VS38394	1
Valve Stem Seal, Exh.	1981-1983			B45458	4
Valve Stem Seal, Int.	1981-1983			B45458	4
Manifold Set, Int. & Exh.	1981-1983			MS15345	1
Oil Pan Set	1981-1983		Cork Rubber	OS30583	1
Rear Main Seal Set	1981-1983			JV515	1
Timing Cover Set	1981-1983			JV965	1

MISCELLANEOUS GASKETS					
E.G.R. Gasket	1981-1983		To Be Replaced By G30705	G26191	5

Nissan Truck

6	2164CC (2.2L) SD22 OHV Nissan Diesel 4 Cyl, 3.268in./83mm (1981-1983)	6
(cont.)		(cont.)

Part	Year	VIN	Model/Application	Part Number	Qty.
MISCELLANEOUS GASKETS (cont.)					
E.G.R. Gasket (cont.)	1981-1983			G30705	5
Therm. Housing Gasket	1981-1983			C24170	1
Water Outlet Gasket	1981-1983			C24093	1
Water Pump Mount Gasket	1981-1983		Pump To Block	K27349	1
				K27376	1

7	2187CC (2.2L) Z22 SOHC Nissan 4 Cyl, 3.425in./87mm (1981-1983)	7
----------	---	----------

Part	Year	VIN	Model/Application	Part Number	Qty.
ENGINE GASKETS					
Head Set	1981-1983			HS3724	1
Full Set	1981-1983			FS3724	1
Engine Kit Gasket Set	1981-1982			95-3240VR	1
Cylinder Head Gasket	1981-1983		<i>VR2000</i>	3724	1
Valve Cover Set	1981-1983		(Contains Valve Cover End Plug) <i>Cork Rubber</i>	VS20344	1
Valve Stem Seal, Exh.	1981-1983			B20183	4
Valve Stem Seal, Int.	1981-1983			B20183	4
Manifold Set, Exhaust	1981-1983			MS12275	1
Manifold Set, Intake	1981-1983			MS15322	1
Oil Pan Set	1981-1983		<i>Cork Rubber</i>	OS30051	1
Rear Main Seal Set	1981-1983			JV637	1
Timing Cover Set	1981-1983			JV916	1
Timing Cover Seal	1981-1983			47658	1

MISCELLANEOUS GASKETS					
E.G.R. Gasket	1981-1983		720	G26315	1
Exhaust Pipe Gasket	1981-1983		(Flange Type), Pipe To Manifold	F10047	1
Fuel Pump Gasket	1981-1983			D24076	2
Oil Pump Inlet Tube	1981-1983			B45711	1
Oil Pump Mounting Gasket	1981-1983			B45694	1
Valve Cover End Plug	1981-1983			B45488	2
Water Outlet Gasket	1981-1983		(2 Holes) <i>Victopac</i>	C20115	1
Water Pump Mount Gasket	1981-1983			K26081	1

8	2389CC (2.4L) KA24DE DOHC Nissan 4 Cyl, 3.504in./89mm (1998-2001)	8
----------	--	----------

Part	Year	VIN	Model/Application	Part Number	Qty.
ENGINE GASKETS					
Lower Set	1998			CS5742	1
Valve Stem Seal, Exh.	1998-2001			B45475	8
Valve Stem Seal, Int.	1998-2001			B45475	8
Rear Main Seal	1998-2001		<i>Rubber</i>	67123	1

MISCELLANEOUS GASKETS					
Exhaust Pipe Gasket	1998-2000		Frontier, 4 Wheel Drive, (Flange Type), Center Pipe To Muffler <i>Metal</i>	F7480	1
	1998-1999		Frontier, 4 Wheel Drive, Federal Emission, (Flange Type), Catalytic Converter To Exhaust Pipe <i>Metal</i>	F7480	2

9	2389CC (2.4L) KA24E SOHC Nissan 4 Cyl, 3.504in./89mm (1989-1997)	9
----------	---	----------

Part	Year	VIN	Model/Application	Part Number	Qty.
ENGINE GASKETS					
Head Set	1993-1994		D21, California Intake Manifold Gasket Not Included, (Requires RTV)	HS5863W	1
	1990-1992		D21, (Requires RTV)	HS5863W	1

9 2389CC (2.4L) KA24E SOHC Nissan 4 Cyl, 3.504in./89mm (1989-1997) **9**
(cont.) (cont.)

Part	Year	VIN	Model/Application	Part Number	Qty.
ENGINE GASKETS (cont.)					
Head Set (cont.)	1989-1992		Axxess, (Requires RTV)	HS5863	1
Full Set	1993-1994		D21, California Intake Manifold Gasket Not Included, (Requires RTV)	FS5863W	1
	1990-1992		D21, (Requires RTV)	FS5863W	1
	1989-1992		Axxess, (Requires RTV)	FS5863	1
Engine Kit Gasket Set	1990-1995			95-3241VR	1
Cylinder Head Gasket	1989-1997		Nitroseal	5863	1
Cyl. Head Spacer Shim	1990-1994		Requires Sealing Compound Steel	5863S	1
Sealing Compound	1990-1995		(4 Ounce Brush Top Can)	JV66B	1
			(12 Ounce Spray Can)	JV66S	1
Valve Cover Set	1990-1994		D21, (Contains Camshaft Semi Circular Plug) Victo-Tech	VS50101	1
	1989-1992		Axxess, (Contains Camshaft Semi Circular Plug) Victo-Tech	VS50100	1
Valve Stem Seal, Exh.	1989-1994			B20183	4
Valve Stem Seal, Int.	1990-1994			B45475	8
Manifold Set, Exhaust	1990-1994			MS15661	1
Manifold Set, Intake	1993-1994		D21, California	MS16196	1
			D21, Except California	MS16197	1
	1990-1992		D21	MS16197	1
Plenum Chamber Gasket	1990-1994		D21	MS14766	1
Oil Pan Set	1989-1994		Original Equipment Uses RTV Silicone	JV6	1
Rear Main Seal	1990-1994		Rubber	67123	1
Timing Cover Set	1990-1995			JV5004	1
Timing Cover Seal	1990-1994		(Requires RTV)	67122	1

MISCELLANEOUS GASKETS

Cam. Semi-Circular Plug	1989-1994			B45849	2
E.G.R. Gasket	1990-1994		D21	G20610	2
	1989-1992		Axxess	G26315	1
Exhaust Pipe Gasket	1989-1994		(Ring Type 'A'), Pipe To Manifold	F7281	2
			(Flange Type), Catalytic Converter To Exhaust Pipe Metal	F7480	2
Oil Pump Inlet Tube	1989-1994		(O-Ring Type)	B45693	1
Oil Pump Mounting Gasket	1989-1994			B45694	1
Throttle Body Gasket	1990-1997		D21	G33301	1
	1989-1992		Axxess	G31093	1
Water Outlet Gasket	1989-1994		Original Equipment Uses RTV Silicone	JV6	1
Water Pump Mount Gasket	1990-1994		D21	K31231	1
	1989-1992		Axxess	K31296	1

10 2389CC (2.4L) Z24/Z24i Nissan 4 Cyl, 3.504in./89mm (1983-1989) **10**

Part	Year	VIN	Model/Application	Part Number	Qty.
ENGINE GASKETS					
Head Set	1987-1989		D21, Pathfinder	HS3767	1
			Van, Valve Cover Gasket Required	HS3767	1
	1983-1986			HS3767	1
Lower Set	1983-1989			CS3767	1
Engine Kit Gasket Set	1983-1989			95-3242VR	1
Cylinder Head Gasket	1983-1989			3767	1
Cyl. Head Spacer Shim	1983-1989		Requires Sealing Compound Steel	3767S	1
Sealing Compound	1983-1989		(4 Ounce Brush Top Can)	JV66B	1
			(12 Ounce Spray Can)	JV66S	1

Nissan Truck

10 (cont.)	2389CC (2.4L) Z24/Z24i Nissan 4 Cyl, 3.504in./89mm (1983-1989)				10 (cont.)
----------------------	---	--	--	--	----------------------

Part	Year	VIN	Model/Application	Part Number	Qty.
ENGINE GASKETS (cont.)					
Valve Cover Set	1987-1989		Van, (Contains Valve Cover End Plug, Contains Valve Cover End Plugs) <i>Cork Rubber</i>	VS20344	1
			Pathfinder <i>Victo-Tech</i>	VS38371	1
	1986-1989		D21 <i>Victo-Tech</i>	VS38371	1
	1986		Van <i>Victo-Tech</i>	VS38371	1
	1983-1986		720 <i>Victo-Tech</i>	VS38371	1
Valve Stem Seal, Exh.	1983-1989			B20183	4
Valve Stem Seal, Int.	1983-1989			B20183	4
Manifold Set, Exhaust	1983-1989			MS12275	1
Manifold Set, Intake	1983-1989			MS15361	1
Oil Pan Set	1983-1989		<i>Cork Rubber</i>	OS30051	1
Rear Main Seal Set	1983-1989			JV637	1
Timing Cover Set	1983-1989			JV999	1

MISCELLANEOUS GASKETS

Carb. Mount Gasket	1984-1985		2 Barrel Carburetor, Upper	GS33161	1
	1983-1985		2 Barrel Carburetor, Carburetor Base	G33261	1
	1983		2 Barrel Carburetor, Upper	GS33156	1
E.G.R. Gasket	1987-1989		Pathfinder	G20610	2
	1986-1989		D21, Van	G20610	2
	1983-1986		720	G20610	2
Exhaust Pipe Gasket	1983-1989		(Flange Type), Pipe To Manifold	F10047	1
Valve Cover End Plug	1983-1989			B45488	2
Water Outlet Gasket	1983-1989		(2 Holes) <i>Victopac</i>	C20115	1
Water Pump Mount Gasket	1983-1989			K26081	1

11	2488CC (2.5L) SD25 OHV Nissan Diesel 4 Cyl, 3.504in./89mm (1983-1985)				11
-----------	--	--	--	--	-----------

Part	Year	VIN	Model/Application	Part Number	Qty.
ENGINE GASKETS					
Head Set	1983-1985		Air Conditioning Requires Additional Head Gasket	HS4831	1
Full Set	1983-1985		Air Conditioning Requires Additional Head Gasket	FS4831	1
Cylinder Head Gasket	1983-1985		Except Air Conditioning	4831	1
			Air Conditioning	4832	1
Valve Cover Set	1983-1985		(Contains Valve Cover Washers) <i>Victo-Tech</i>	VS38394	1
Valve Stem Seal, Exh.	1983-1985			B45545	4
Valve Stem Seal, Int.	1983-1985			B45545	4
Manifold Set, Int. & Exh.	1983-1985			MS15375	1
Oil Pan Set	1983-1985		<i>Cork Rubber</i>	OS30607	1
Rear Main Seal Set	1983-1985			JV542	1
Timing Cover Set	1983-1985			JV1010	1

MISCELLANEOUS GASKETS

E.G.R. Gasket	1983-1985		To Be Replaced By G30705	G26191	5
				G30705	5
Therm. Housing Gasket	1983-1985			C24170	1
Water Outlet Gasket	1983-1985			C24218	1
Water Pump Mount Gasket	1983-1985			K27349	1

12	2960CC (3.0L) VG30 SOHC Nissan V6 Cyl, 3.425in./87mm (1986-1989)				12
-----------	---	--	--	--	-----------

Part	Year	VIN	Model/Application	Part Number	Qty.
ENGINE GASKETS					
Head Set	1988-1989		D21	HS5826W	1
	1987		D21, Thru 3/87	HS5758	1

12 (cont.)	2960CC (3.0L) VG30 SOHC Nissan V6 Cyl, 3.425in./87mm (1986-1989)	12 (cont.)
----------------------	---	----------------------

Part	Year	VIN	Model/Application	Part Number	Qty.
ENGINE GASKETS (cont.)					
Head Set (cont.)	1987		D21, From 4/87	HS5826W	1
	1986		D21	HS5758	1
Full Set	1988-1989		D21	FS5826W	1
	1987		D21, Thru 3/87	FS5758	1
			D21, From 4/87	FS5826W	1
	1986		D21	FS5758	1
Engine Kit Gasket Set	1986-1987			95-3358VR	1
Cylinder Head Gasket	1988-1989		D21	<i>Nitroseal</i> 5826	2
	1987		D21, Thru 3/87	<i>Nitroseal</i> 5758	2
			D21, From 4/87	<i>Nitroseal</i> 5826	2
	1986		D21	<i>Nitroseal</i> 5758	2
Cyl. Head Spacer Shim	1988-1989		D21, Requires Sealing Compound	<i>Steel</i> 5826S	2
	1987		D21, Requires Sealing Compound, Thru 3/87	<i>Steel</i> 5758S	2
			D21, From 4/87, Requires Sealing Compound	<i>Steel</i> 5826S	2
	1986		D21, Requires Sealing Compound	<i>Steel</i> 5758S	2
Sealing Compound	1986-1989		(4 Ounce Brush Top Can)	JV66B	1
			(12 Ounce Spray Can)	JV66S	1
Valve Cover Set	1986-1989		D21	<i>Victo-Tech</i> VS38376	1
Valve Stem Seal, Exh.	1986-1989		D21	B20183	6
Valve Stem Seal, Int.	1986-1989		D21	B45475	6
Manifold Set, Exhaust	1986-1989		D21	MS15363W	1
Manifold Set, Intake	1986-1989		D21	MS15362W	1
Oil Pan Set	1988-1989		D21	<i>Victo-Tech</i> OS32080	1
	1987		D21, Thru 3/87, (Requires Timing Cover Set)	<i>Victo-Tech</i> OS30606	1
			D21, From 4/87	<i>Victo-Tech</i> OS32080	1
	1986		D21, (Requires Timing Cover Set)	<i>Victo-Tech</i> OS30606	1
Rear Main Seal Set	1986-1989		D21	JV538	1
Timing Cover Set	1988-1989		D21	JV1103	1
	1987		D21, Thru 3/87, (Requires RTV)	JV1004	1
			D21, From 4/87	JV1103	1
	1986		D21, (Requires RTV)	JV1004	1
Timing Cover Seal	1986-1989		D21	66881	1
MISCELLANEOUS GASKETS					
Camshaft Seal	1986-1989		D21	66864	2
E.G.R. Gasket	1986-1989		D21	G20610	2
Exhaust Pipe Gasket	1986-1989		D21, (Flange Type), Pipe To Manifold	F7434	1
			D21, (Flange Type), Catalytic Converter To Exhaust Pipe	<i>Metal</i> F7480	2
Oil Pump Inlet Tube	1986-1989		D21, (O-Ring Type)	B45693	1
Oil Pump Mounting Gasket	1986-1989			H45692	1
Therm. Housing Gasket	1986-1989		D21	C24212	1
Water Outlet Gasket	1986-1989		D21	C24211	1
Water Pump Mount Gasket	1988-1989		D21	K30738	1
	1987		D21, 2 Wheel Drive, Thru 3/87	K27661	1
			D21, 4 Wheel Drive, Thru 3/87	K30738	1
			D21, From 4/87	K30738	1
	1986		D21, 2 Wheel Drive	K27661	1
			D21, 4 Wheel Drive	K30738	1

Nissan Truck

13 2960CC (3.0L) VG30E SOHC Nissan V6 Cyl, 3.425in./87mm (1990-1998)

13

Part	Year	VIN	Model/Application	Part Number	Qty.
ENGINE GASKETS					
Head Set	1993-1996		Quest	HS5826	1
	1990-1994		D21, Pathfinder	HS5826Y	1
Full Set	1993-1995		Quest	FS5826	1
	1990-1994		D21, Pathfinder	FS5826Y	1
Cylinder Head Gasket	1993-1998			<i>Nitroseal</i> 5826	2
	1990-1996		D21	<i>Nitroseal</i> 5826	2
	1990-1995		Pathfinder	<i>Nitroseal</i> 5826	2
Cyl. Head Spacer Shim	1993		Quest, Requires Sealing Compound	<i>Steel</i> 5826S	2
	1990-1993		D21, Pathfinder, Requires Sealing Compound	<i>Steel</i> 5826S	2
Sealing Compound	1990-1993		(4 Ounce Brush Top Can)	JV66B	1
			(12 Ounce Spray Can)	JV66S	1
Valve Cover Set	1993-1998		Quest	<i>Victo-Tech</i> VS38376	1
	1990-1996		D21	<i>Victo-Tech</i> VS38376	1
	1990-1995		Pathfinder	<i>Victo-Tech</i> VS38376	1
Valve Stem Seal, Exh.	1993-1998		Quest	B20183	6
	1990-1995		D21, Pathfinder	B20183	6
Valve Stem Seal, Int.	1993-1998		Quest	B45475	6
	1990-1995		D21, Pathfinder	B45475	6
Manifold Set, Exhaust	1993-1998		Quest	MS15364	1
	1990-1996		D21	MS15363W	1
	1990-1995		Pathfinder	MS15363W	1
Manifold Set, Intake	1993-1996		Quest	MS15362W	1
	1990-1994		D21, Pathfinder	MS15362W	1
Oil Pan Set	1993-1998		Quest	<i>Victo-Tech</i> OS32080	1
	1990-1995		D21, Pathfinder	<i>Victo-Tech</i> OS32080	1
Rear Main Seal Set	1993-1998		Quest	JV538	1
	1990-1995		D21, Pathfinder	JV538	1
Timing Cover Set	1990-1995			JV1107	1
Timing Cover Seal	1990-1995			66881	1
MISCELLANEOUS GASKETS					
Camshaft Seal	1990-1998			66864	2
E.G.R. Gasket	1990-1998			G20610	2
Exhaust Pipe Gasket	1994-1996		D21, Manifold To Exhaust Pipe	F7282	2
	1993-1996		D21, (Flange Type), Catalytic Converter, Crossover Pipe To Intermediate Pipe, Intermediate Pipe To Muffler	<i>Metal</i> F7480	4
			Pathfinder, Manifold To Exhaust Pipe	F7282	2
	1993-1995		Pathfinder, (Flange Type), Catalytic Converter, Crossover Pipe To Intermediate Pipe, Intermediate Pipe To Muffler	<i>Metal</i> F7480	4
		1993		D21, Pathfinder, (Flange Type), Manifold To Exhaust Pipe	F7434
			Quest, (Ring Type 'A'), Manifold To Exhaust Pipe	F7479	2
			Quest, (Flange Type), Catalytic Converter	<i>Metal</i> F7480	2
	1990-1992		(Flange Type), Manifold To Exhaust Pipe	F7434	2
		(Flange Type), Catalytic Converter, Crossover Pipe To Intermediate Pipe, Intermediate Pipe To Muffler	<i>Metal</i> F7480	4	
Oil Pump Inlet Tube	1993-1998		(O-Ring Type)	B45693	1
	1990-1993		D21, Pathfinder, (O-Ring Type)	B45693	1
Oil Pump Mounting Gasket	1990-1998			H45692	1
Therm. Housing Gasket	1990-1992		D21, Pathfinder	C31225	1
Throttle Body Gasket	1993-1995			G30801	1
Water Outlet Gasket	1993		Quest, Original Equipment Uses RTV	<i>Silicone</i> JV6	1
	1990-1992		D21, Pathfinder	C24211	1
Water Pump Mount Gasket	1990-1996			K30738	1
	1993		Quest, Original Equipment Uses RTV	<i>Silicone</i> JV6	1

LIGHT TRUCK

14 2960CC (3.0L) VG30i SOHC Nissan V6 Cyl, 3.425in./87mm (1987-1989)

14

Part	Year	VIN	Model/Application	Part Number	Qty.	
ENGINE GASKETS						
Head Set	1988-1989			HS5826W	1	
	1987		Thru 3/87	HS5758	1	
				From 4/87	HS5826W	1
Full Set	1988-1989			FS5826W	1	
	1987		Thru 3/87	FS5758	1	
				From 4/87	FS5826W	1
Cylinder Head Gasket	1988-1989		<i>Nitroseal</i>	5826	2	
	1987		Thru 3/87	<i>Nitroseal</i>	5758	2
				From 4/87	<i>Nitroseal</i>	5826
Cyl. Head Spacer Shim	1988-1989		Requires Sealing Compound	<i>Steel</i>	5826S	2
			Requires Sealing Compound, Thru 3/87	<i>Steel</i>	5758S	2
	1987		From 4/87, Requires Sealing Compound	<i>Steel</i>	5826S	2
Sealing Compound	1987-1989		(4 Ounce Brush Top Can)	JV66B	1	
			(12 Ounce Spray Can)	JV66S	1	
Valve Cover Set	1987-1989		<i>Victo-Tech</i>	VS38376	1	
Valve Stem Seal, Exh.	1987-1989			B20183	6	
Valve Stem Seal, Int.	1987-1989			B45475	6	
Manifold Set, Exhaust	1987-1989			MS15363W	1	
Manifold Set, Intake	1987-1989			MS15362W	1	
Oil Pan Set	1988-1989			<i>Victo-Tech</i>	OS32080	1
	1987		Thru 3/87, (Requires Timing Cover Set)	<i>Victo-Tech</i>	OS30606	1
				From 4/87	<i>Victo-Tech</i>	OS32080
Rear Main Seal Set	1987-1989			JV538	1	
Timing Cover Set	1988-1989			JV1103	1	
	1987		Thru 3/87, (Requires RTV)	JV1004	1	
				From 4/87	JV1103	1
Timing Cover Seal	1987-1989			66881	1	

MISCELLANEOUS GASKETS

Camshaft Seal	1987-1989			66864	2	
E.G.R. Gasket	1987-1989			G20610	2	
Exhaust Pipe Gasket	1987-1989		(Flange Type), Pipe To Manifold	F7434	1	
			(Flange Type), Catalytic Converter To Exhaust Pipe	<i>Metal</i> F7480	2	
Oil Pump Inlet Tube	1987-1989		(O-Ring Type)	B45693	1	
Oil Pump Mounting Gasket	1987-1989			H45692	1	
Therm. Housing Gasket	1987-1989			C24212	1	
Water Outlet Gasket	1987-1989			C24211	1	
Water Pump Mount Gasket	1988-1989			K30738	1	
	1987		2 Wheel Drive, Thru 3/87	K27661	1	
				4 Wheel Drive, Thru 3/87	K30738	1
				From 4/87	K30738	1

15 3275CC (3.3L) VG33E SOHC Nissan V6 Cyl, 3.602in./91.5mm (1996-2002)

15

Part	Year	VIN	Model/Application	Part Number	Qty.
ENGINE GASKETS					
Valve Cover Set	1996-2000			VS38376	1
Plenum Chamber Gasket	1996-2000			MS15494	1
MISCELLANEOUS GASKETS					
Valve Stem Seal, Exh.	1999-2002			B45475	6
Valve Stem Seal, Int.	1996-2000			B20183	6
Camshaft Seal	1996-2002			66864	2
E.G.R. Gasket	1996-2000			G20610	1
Exhaust Pipe Gasket	1996-2002		Manifold To Exhaust Pipe	F7281	2

Nissan Truck

15 (cont.)	3275CC (3.3L) VG33E SOHC Nissan V6 Cyl, 3.602in./91.5mm (1996-2002)	15 (cont.)
----------------------	--	----------------------

Part	Year	VIN	Model/Application	Part Number	Qty.
------	------	-----	-------------------	-------------	------

MISCELLANEOUS GASKETS (cont.)

Exhaust Pipe Gasket (cont.)	1996-2002		(Flange Type), Front Pipe To Front Intermediate Pipe	<i>Metal</i> F7480	2
	1996-2000		Muffler To Resonator	F7282	1

16	3275CC (3.3L) VG33ER SOHC Nissan V6 Cyl, 3.602in./91.5mm (2001-2002)	16
-----------	---	-----------

Part	Year	VIN	Model/Application	Part Number	Qty.
------	------	-----	-------------------	-------------	------

MISCELLANEOUS GASKETS

Valve Stem Seal, Exh.	2001-2002			B45475	6
Camshaft Seal	2001-2002			66864	2
Exhaust Pipe Gasket	2001-2002		Manifold To Exhaust Pipe	F7281	2

Studebaker Truck

Engine Index

Engine	Year	Block	Engine	Year	Block
170 CID (2.8L) L-Head Studebaker	1941-1954	1	259 CID (4.2L) OHV Studebaker	1955-1964	3
224 CID (3.7L) OHV Studebaker	1955-1956	2	289 CID (4.7L) OHV Studebaker	1957-1964	4

Model Index

Model	Engine	Year	Block	Model	Engine	Year	Block
2E7	224 CID (3.7L) OHV Studebaker	1956	2	4E13 Deluxe	289 CID (4.7L) OHV Studebaker	1959	4
2E12	224 CID (3.7L) OHV Studebaker	1956	2	4E28	259 CID (4.2L) OHV Studebaker	1959	3
2E13	259 CID (4.2L) OHV Studebaker	1956	3	4E28	289 CID (4.7L) OHV Studebaker	1959	4
Transtar	259 CID (4.2L) OHV Studebaker			Transtar	289 CID (4.7L) OHV Studebaker		
2E28	259 CID (4.2L) OHV Studebaker	1956	3	4E40 Deluxe	289 CID (4.7L) OHV Studebaker	1959	4
2E38	259 CID (4.2L) OHV Studebaker	1956	3	5E7 Champ	259 CID (4.2L) OHV Studebaker	1960	3
2R5	170 CID (2.8L) L-Head Studebaker	1949-1953	1	5E7 Champ	289 CID (4.7L) OHV Studebaker	1960	4
2R10	170 CID (2.8L) L-Head Studebaker	1949-1953	1	5E12 Champ	259 CID (4.2L) OHV Studebaker	1960	3
2R15	170 CID (2.8L) L-Head Studebaker	1949-1953	1	5E12 Champ	289 CID (4.7L) OHV Studebaker	1960	4
3E7	259 CID (4.2L) OHV Studebaker	1957-1958	3	5E13	259 CID (4.2L) OHV Studebaker	1960	3
3E12	259 CID (4.2L) OHV Studebaker	1957-1958	3	5E13	289 CID (4.7L) OHV Studebaker	1960	4
3E13	259 CID (4.2L) OHV Studebaker	1957-1958	3	Transtar	289 CID (4.7L) OHV Studebaker		
3E28	259 CID (4.2L) OHV Studebaker	1957-1958	3	5E28	259 CID (4.2L) OHV Studebaker	1960	3
Transtar	259 CID (4.2L) OHV Studebaker			Transtar	289 CID (4.7L) OHV Studebaker		
3E38	259 CID (4.2L) OHV Studebaker	1957-1958	3	5E28	289 CID (4.7L) OHV Studebaker	1960	4
3E40	289 CID (4.7L) OHV Studebaker	1957-1958	4	5E40	289 CID (4.7L) OHV Studebaker	1960	4
Transtar	289 CID (4.7L) OHV Studebaker			6E7 Champ	259 CID (4.2L) OHV Studebaker	1961	3
3R5	170 CID (2.8L) L-Head Studebaker	1954	1	6E7 Champ	289 CID (4.7L) OHV Studebaker	1961	4
3R10	170 CID (2.8L) L-Head Studebaker	1954	1	6E12 Champ	259 CID (4.2L) OHV Studebaker	1961	3
4E2	259 CID (4.2L) OHV Studebaker	1959	3	6E12 Champ	289 CID (4.7L) OHV Studebaker	1961	4
Scotsman	259 CID (4.2L) OHV Studebaker			6E13	259 CID (4.2L) OHV Studebaker	1961	3
4E7 Deluxe	259 CID (4.2L) OHV Studebaker	1959	3	Transtar	259 CID (4.2L) OHV Studebaker		
4E7 Deluxe	289 CID (4.7L) OHV Studebaker	1959	4	6E13	289 CID (4.7L) OHV Studebaker	1961	4
4E12 Deluxe	259 CID (4.2L) OHV Studebaker	1959	3	Transtar	289 CID (4.7L) OHV Studebaker		
4E12 Deluxe	289 CID (4.7L) OHV Studebaker	1959	4	6E28	259 CID (4.2L) OHV Studebaker	1961	3
4E13 Deluxe	259 CID (4.2L) OHV Studebaker	1959	3	Transtar	259 CID (4.2L) OHV Studebaker		
				6E28	289 CID (4.7L) OHV Studebaker	1961	4
				Transtar	289 CID (4.7L) OHV Studebaker		
				6E40	289 CID (4.7L) OHV Studebaker	1961	4
				Transtar	289 CID (4.7L) OHV Studebaker		

LIGHT TRUCK

Studebaker Truck

Model Index (cont.)

Model	Engine	Year	Block	Model	Engine	Year	Block
7E7 Champ	259 CID (4.2L) OHV Studebaker	1962	3	8E13	259 CID (4.2L) OHV Studebaker	1963-1964	3
7E7 Champ	289 CID (4.7L) OHV Studebaker	1962	4	8E13	289 CID (4.7L) OHV Studebaker	1963-1964	4
7E12 Champ	259 CID (4.2L) OHV Studebaker	1962	3	8E28	259 CID (4.2L) OHV Studebaker	1963-1964	3
7E12 Champ	289 CID (4.7L) OHV Studebaker	1962	4	8E28	289 CID (4.7L) OHV Studebaker	1963-1964	4
7E13	259 CID (4.2L) OHV Transtar	1962	3	8E40	289 CID (4.7L) OHV Studebaker	1963-1964	4
7E13	289 CID (4.7L) OHV Transtar	1962	4	E7	224 CID (3.7L) OHV Studebaker	1955	2
7E28	259 CID (4.2L) OHV Transtar	1962	3	E12	224 CID (3.7L) OHV Studebaker	1955	2
7E28	289 CID (4.7L) OHV Transtar	1962	4	E13	224 CID (3.7L) OHV Studebaker	1955	2
7E40	289 CID (4.7L) OHV Studebaker	1962	4	E28	259 CID (4.2L) OHV Studebaker	1955	3
8E7 Champ	259 CID (4.2L) OHV Studebaker	1963-1964	3	E38	259 CID (4.2L) OHV Studebaker	1955	3
8E7 Champ	289 CID (4.7L) OHV Studebaker	1963-1964	4	M5	170 CID (2.8L) L-Head Studebaker	1941-1942	1
8E12 Champ	259 CID (4.2L) OHV Studebaker	1963-1964	3	Coupe- Express			
8E12 Champ	289 CID (4.7L) OHV Studebaker	1963-1964	4				

1	170 CID (2.8L) L-Head Studebaker 6 Cyl, 3.000in./76.2mm (1941-1954)	1
----------	--	----------

Part	Year	VIN	Model/Application	Part Number	Qty.	
ENGINE GASKETS						
Cylinder Head Gasket	1946-1954			VR2000	1060	1
	1941-1942			VR2000	1060	1
Manifold Set, Int. & Exh.	1946-1954				MS15032Y	1
	1941-1942				MS15032Y	1

MISCELLANEOUS GASKETS						
Exhaust Pipe Gasket	1946-1954		(Flange Type), Pipe To Manifold		F17802	1
	1941-1942		(Flange Type), Pipe To Manifold		F17802	1
Fuel Pump Bowl Gasket	1946-1953				D35288	1
	1941-1942				D35288	1
Fuel Pump Gasket	1946-1954				D27094	1
	1941-1942				D27094	1

2	224 CID (3.7L) OHV Studebaker V8 Cyl, 3.563in./90.5mm (1955-1956)	2
----------	--	----------

Part	Year	VIN	Model/Application	Part Number	Qty.
ENGINE GASKETS					
Valve Stem Seal, Exh.	1955-1956		Early 1955	B45233	8
			Except Early 1955	B45264	8
Valve Stem Seal, Int.	1955-1956		Early 1955	B45233	8
			Except Early 1955	B45264	8

MISCELLANEOUS GASKETS					
Air Cleaner Mount Gasket	1956		4 Barrel Carburetor	G26410	1
	1955-1956		2 Barrel Carburetor	G25936	1
Exhaust Pipe Gasket	1955-1956		(Flange Type), Pipe To Manifold	F5436AK	3
Fuel Pump Bowl Gasket	1955			D35288	1
Fuel Pump Gasket	1955-1956			D27094	1

LIGHT TRUCK

Studebaker Truck

3 259 CID (4.2L) OHV Studebaker V8 Cyl, 3.563in./90.5mm (1955-1964) 3

Part	Year	VIN	Model/Application	Part Number	Qty.
ENGINE GASKETS					
Valve Stem Seal, Exh.	1955-1963			B45233	8
Valve Stem Seal, Int.	1955-1963			B45233	8
MISCELLANEOUS GASKETS					
Air Cleaner Mount Gasket	1955-1964		2 Barrel Carburetor	G25936	1
			4 Barrel Carburetor	G26410	1
Exhaust Pipe Gasket	1961-1964		Except Early 1960, (Flange Type), Pipe To Manifold	F5436AK	3
	1960		Except Early 1960, Except Late 1960, (Flange Type), Pipe To Manifold	F5436AK	3
	1955-1959		Except Late 1960, (Flange Type), Pipe To Manifold	F5436AK	3
Fuel Pump Bowl Gasket	1955-1964			D35288	1
Fuel Pump Gasket	1955-1964			D27094	1
Water Outlet Gasket	1960-1964		Except Early 1960	C24109	1

4 289 CID (4.7L) OHV Studebaker V8 Cyl, 3.563in./90.5mm (1957-1964) 4

Part	Year	VIN	Model/Application	Part Number	Qty.
ENGINE GASKETS					
Valve Stem Seal, Exh.	1957-1963			B45233	8
Valve Stem Seal, Int.	1957-1963			B45233	8
MISCELLANEOUS GASKETS					
Air Cleaner Mount Gasket	1957-1964		2 Barrel Carburetor	G25936	1
			4 Barrel Carburetor	G26410	1
Exhaust Pipe Gasket	1961-1964		(Flange Type), Pipe To Manifold	F5436AK	3
	1960		Except Early 1960, Except Late 1960, (Flange Type), Pipe To Manifold	F5436AK	3
	1957-1959		(Flange Type), Pipe To Manifold	F5436AK	3
Fuel Pump Gasket	1957-1964			D27094	1
Water Outlet Gasket	1960-1964		Except Early 1960	C24109	1

Subaru Truck

Engine Index

Engine	Year	Block	Engine	Year	Block
1595CC (1.6L) EA71 Subaru	1976-1980	1	1781CC (1.8L) EA81T Turbo Subaru	1983-1984	3
1781CC (1.8L) EA81 OHV Subaru	1981-1988	2			

Model Index

Model	Engine	Year	Block	Model	Engine	Year	Block
Brat	1595CC (1.6L) EA71 Subaru	1976-1980	1	Brat	1781CC (1.8L) EA81T Turbo Subaru	1983-1984	3
Brat	1781CC (1.8L) EA81 OHV Subaru	1981-1988	2				

1 1595CC (1.6L) EA71 Subaru 4 Cyl, 3.622in./92mm (1976-1980) 1

Part	Year	VIN	Model/Application	Part Number	Qty.
ENGINE GASKETS					
Head Set	1980			HS3708	1
	1976-1979			HS3656	1
Full Set	1980			FS3708	1
	1976-1979		(Water Pump Mounting Gasket Not Included)	FS3656	1
Cylinder Head Gasket	1976-1980		VR2000	3708	2
Valve Cover Set	1976-1980		(Contains Valve Cover Washers) Cork Rubber	VS30235	1
Valve Stem Seal, Exh.	1976-1980			B45434	4
Valve Stem Seal, Int.	1976-1980			B45434	4
Manifold Set, Intake	1976-1980			MS15279	1
Oil Pan Set	1976-1980		Cork Rubber	OS30304	1
Rear Main Seal	1976-1980		Rubber	66704	1

1 (cont.)	1595CC (1.6L) EA71 Subaru 4 Cyl, 3.622in./92mm (1976-1980)					1 (cont.)
---------------------	---	--	--	--	--	---------------------

Part	Year	VIN	Model/Application	Part Number	Qty.
------	------	-----	-------------------	-------------	------

ENGINE GASKETS (cont.)

Timing Cover Seal	1976-1980			66701	1
-------------------	-----------	--	--	-------	---

MISCELLANEOUS GASKETS

Carb. Mount Gasket	1978-1980		2 Barrel Carburetor	G30800	2
E.G.R. Gasket	1976-1980			G26315	1
Exhaust Pipe Gasket	1976-1980		(Flange Type), Pipe To Manifold	F12284	2
			(Flange Type), Pre-Muffler	F20239	2
Water Outlet Gasket	1976-1980			C20238	1
Water Pump Mount Gasket	1976-1980			K20203	1

2	1781CC (1.8L) EA81 OHV Subaru 4 Cyl, 3.622in./92mm (1981-1988)					2
----------	---	--	--	--	--	----------

Part	Year	VIN	Model/Application	Part Number	Qty.
------	------	-----	-------------------	-------------	------

ENGINE GASKETS

Head Set	1981-1988			HS3709	1
Full Set	1981-1988			FS3709	1
Cylinder Head Gasket	1981-1988		VR2000	3709	2
Valve Cover Set	1981-1988		(Contains Valve Cover Washers) Cork Rubber	VS39796	1
Valve Stem Seal, Exh.	1981-1988			B45434	4
Valve Stem Seal, Int.	1981-1988			B45434	4
Manifold Set, Intake	1981-1988			MS15279	1
Oil Pan Set	1981-1988		Cork Rubber	OS30575	1
Rear Main Seal	1981-1988		Rubber	66853	1
Timing Cover Seal	1981-1988			66852	1

MISCELLANEOUS GASKETS

Carb. Mount Gasket	1981-1988		2 Barrel Carburetor	G30800	2
E.G.R. Gasket	1981-1988			G26315	1
Exhaust Pipe Gasket	1981-1988		(Flange Type), Pipe To Manifold	F12284	2
			(Flange Type), Pre-Muffler	F20239	2
Oil Pump Mounting Gasket	1981-1988			B45721	1
Water Outlet Gasket	1981-1988			C20238	1
Water Pump Mount Gasket	1981-1988			K20203	1

3	1781CC (1.8L) EA81T Turbo Subaru 4 Cyl, 3.622in./92mm (1983-1984)					3
----------	--	--	--	--	--	----------

Part	Year	VIN	Model/Application	Part Number	Qty.
------	------	-----	-------------------	-------------	------

ENGINE GASKETS

Full Set	1983-1984			FS3785	1
Cylinder Head Gasket	1983-1984		Nitroseal	3785	2
Valve Cover Set	1983-1984		(Contains Valve Cover Washers) Cork Rubber	VS39796	1
Valve Stem Seal, Exh.	1983-1984		Turbocharged	B45434	4
Valve Stem Seal, Int.	1983-1984		Turbocharged	B45434	4
Manifold Set, Intake	1983-1984			MS15279	1
Oil Pan Set	1983-1984		Cork Rubber	OS30575	1
Rear Main Seal	1983-1984		Rubber	66853	1
Timing Cover Seal	1983-1984			66852	1

MISCELLANEOUS GASKETS

E.G.R. Gasket	1983-1984		Turbocharged	G26315	1
Exhaust Pipe Gasket	1983-1984		Turbocharged, (Flange Type), Exhaust Pipe To Muffler	F7429	1
			(Flange Type), Turbocharged, Pipe To Manifold	F12284	2
			(Flange Type), Turbocharged, Pre-Muffler	F20239	2
Oil Pump Mounting Gasket	1983-1984		Turbocharged	B45721	1
Water Outlet Gasket	1983-1984		Turbocharged	C20238	1

Subaru Truck

3 (cont.)	1781CC (1.8L) EA81T Turbo Subaru 4 Cyl, 3.622in./92mm (1983-1984)				3 (cont.)
---------------------	--	--	--	--	---------------------

Part	Year	VIN	Model/Application	Part Number	Qty.
MISCELLANEOUS GASKETS (cont.)					
Water Pump Mount Gasket	1983-1984		Turbocharged	K20203	1

Suzuki Truck

Engine Index

Engine	Year	Block	Engine	Year	Block
1298CC (1.3L) G13BA SOHC Suzuki	1989-1995	1	1590CC (1.6L) G16KC (8 Valve) Suzuki	1989-1995	4
1298CC (1.3L) SOHC Suzuki	1990-1991	2	1590CC (1.6L) G16KV (16 Valve) Suzuki	1992-1997	5
1324CC (1.3L) G13A Suzuki	1986-1989	3			

Model Index

Model	Engine	Year	Block	Model	Engine	Year	Block
Samurai	1298CC (1.3L) SOHC Suzuki	1990-1991	2	Sidekick	1590CC (1.6L) G16KV (16 Valve) Suzuki	1992-1998	5
Samurai	1298CC (1.3L) G13BA SOHC Suzuki	1990-1995	1	Sidekick	1590CC (1.6L) G16KC (8 Valve) Suzuki	1989-1995	4
Samurai	1324CC (1.3L) G13A Suzuki	1986-1989	3				
Sidekick	1298CC (1.3L) G13BA SOHC Suzuki	1989	1				

1	1298CC (1.3L) G13BA SOHC Suzuki 4 Cyl, 2.913in./74mm (1989-1995)				1
----------	---	--	--	--	----------

Part	Year	VIN	Model/Application	Part Number	Qty.
------	------	-----	-------------------	-------------	------

ENGINE GASKETS

Head Set	1989-1995		(Throttle Body Gasket Not Included, Intake Manifold Gasket Not Included)	HS5759	1
Full Set	1989-1995		(Oil Pan Gasket Not Included, Throttle Body Gasket Not Included, Intake Manifold Gasket Not Included)	FS5759	1
Cylinder Head Gasket	1989-1995		<i>Nitroseal</i>	5759	1
Valve Cover Set	1989-1995		(Contains Valve Cover Washers) <i>Cork Rubber</i>	VS50042	1
Valve Stem Seal, Exh.	1989-1995			B45590	4
Valve Stem Seal, Int.	1989-1995			B45590	4
Manifold Set, Exhaust	1989-1995			MS15435	1
Manifold Set, Intake	1989-1995			MS15640	1
	1989		To Be Replaced By MS15640	MS15434	1
Oil Pan Set	1989-1995		<i>Cork Rubber</i>	OS32089	1
Rear Main Seal Set	1989-1995			JV561	1
Timing Cover Set	1989-1995			JV1047	1
				JV5009	1

MISCELLANEOUS GASKETS

Camshaft Seal	1989-1995			66982	1
E.G.R. Gasket	1989-1995			G30785	1
Exhaust Pipe Gasket	1989-1995		(Ring Type 'F'), Pipe To Manifold	F7437	1
Fuel Pump Gasket	1989			D30783	1
Throttle Body Gasket	1990-1995			G31095	1
Water Outlet Gasket	1989-1995			C30645	1
Water Pump Mount Gasket	1989-1995			K30640	1

2	1298CC (1.3L) SOHC Suzuki 4 Cyl, 2.913in./74mm (1990-1991)				2
----------	---	--	--	--	----------

Part	Year	VIN	Model/Application	Part Number	Qty.
------	------	-----	-------------------	-------------	------

ENGINE GASKETS

Head Set	1990-1991		(Oil Pan Gasket Not Included, Throttle Body Gasket Not Included, Intake Manifold Gasket Not Included)	HS5759	1
Full Set	1990-1991		(Oil Pan Gasket Not Included, Throttle Body Gasket Not Included, Intake Manifold Gasket Not Included)	FS5759	1
Cylinder Head Gasket	1990-1991		<i>Nitroseal</i>	5759	1
Valve Cover Set	1990-1991		(Contains Valve Cover Washers) <i>Cork Rubber</i>	VS50042	1
Valve Stem Seal, Exh.	1990-1991			B45590	4

2 (cont.)	1298CC (1.3L) SOHC Suzuki 4 Cyl, 2.913in./74mm (1990-1991)				2 (cont.)
---------------------	---	--	--	--	---------------------

<i>Part</i>	<i>Year</i>	<i>VIN</i>	<i>Model/Application</i>	<i>Part Number</i>	<i>Qty.</i>
ENGINE GASKETS (cont.)					
Valve Stem Seal, Int.	1990-1991			B45590	4
Manifold Set, Exhaust	1990-1991			MS15435	1
Manifold Set, Intake	1990-1991			MS15640	1
Oil Pan Set	1990-1991		<i>Cork Rubber</i>	OS32089	1
Rear Main Seal Set	1990-1991			JV561	1
Timing Cover Set	1990-1991			JV1047	1
				JV5009	1

MISCELLANEOUS GASKETS

Camshaft Seal	1990-1991			66982	1
E.G.R. Gasket	1990-1991			G30785	1
Exhaust Pipe Gasket	1990-1991		(Ring Type 'F'), Pipe To Manifold	F7437	1
Throttle Body Gasket	1990-1991			G31095	1
Water Outlet Gasket	1990-1991			C30645	1
Water Pump Mount Gasket	1990-1991			K30640	1

3	1324CC (1.3L) G13A Suzuki 4 Cyl, 2.913in./74mm (1986-1989)				3
----------	---	--	--	--	----------

<i>Part</i>	<i>Year</i>	<i>VIN</i>	<i>Model/Application</i>	<i>Part Number</i>	<i>Qty.</i>
ENGINE GASKETS					
Head Set	1986-1989			HS5759	1
Full Set	1986-1989		(Oil Pan Gasket Not Included)	FS5759	1
Cylinder Head Gasket	1986-1989		<i>Nitroseal</i>	5759	1
Valve Cover Set	1986-1989		(Contains Valve Cover Washers) <i>Cork Rubber</i>	VS50042	1
Valve Stem Seal, Exh.	1986-1989			B45590	4
Valve Stem Seal, Int.	1986-1989			B45590	4
Manifold Set, Exhaust	1986-1989			MS15435	1
Manifold Set, Intake	1986-1989		To Be Replaced By MS15640	MS15434	1
				MS15640	1
Oil Pan Set	1986-1989		<i>Cork Rubber</i>	OS32089	1
Rear Main Seal Set	1986-1989			JV561	1
Timing Cover Set	1986-1989			JV1047	1
				JV5009	1

MISCELLANEOUS GASKETS

Camshaft Seal	1986-1989			66982	1
Carb. Mount Gasket	1986-1989		2 Barrel Carburetor	G30784	2
E.G.R. Gasket	1986-1989			G30785	1
Exhaust Pipe Gasket	1986-1989		(Ring Type 'F'), Pipe To Manifold	F7437	1
Fuel Pump Gasket	1986-1989			D30783	1
Water Outlet Gasket	1986-1989			C30645	1
Water Pump Mount Gasket	1986-1989			K30640	1

4	1590CC (1.6L) G16KC (8 Valve) Suzuki 4 Cyl, 2.953in./75mm (1989-1995)				4
----------	--	--	--	--	----------

<i>Part</i>	<i>Year</i>	<i>VIN</i>	<i>Model/Application</i>	<i>Part Number</i>	<i>Qty.</i>
ENGINE GASKETS					
Head Set	1989-1992		(Head Bolts Not Included, Exhaust Manifold Gasket Not Included)	HS5866	1
			(Contains Head Bolts, Exhaust Manifold Gasket Not Included)	HS5866WB	1
Full Set	1989-1992		(Oil Pan Gasket Not Included, Exhaust Manifold Gasket Not Included)	FS5866	1
Cylinder Head Gasket	1989-1992		<i>VR2000</i>	5866	1
Valve Cover Set	1989-1992		(Contains Valve Cover Washers) <i>Cork Rubber</i>	VS50042	1
Valve Stem Seal, Exh.	1989-1992			B45590	4
Valve Stem Seal, Int.	1989-1992			B45590	4

Suzuki Truck

4 (cont.)	1590CC (1.6L) G16KC (8 Valve) Suzuki 4 Cyl, 2.953in./75mm (1989-1995)				4 (cont.)
---------------------	--	--	--	--	---------------------

Part	Year	VIN	Model/Application	Part Number	Qty.
ENGINE GASKETS (cont.)					
Manifold Set, Exhaust	1989-1992			MS15629	1
Manifold Set, Intake	1989-1992			MS15628	1
Oil Pan Set	1989-1992		<i>Cork Rubber</i>	OS32089	1
Rear Main Seal Set	1989-1992			JV594	1
Timing Cover Set	1989-1992		(Camshaft Seal Not Included)	JV1110	1
				JV5009	1

MISCELLANEOUS GASKETS					
Camshaft Seal	1989-1992			66982	1
E.G.R. Gasket	1989-1992			G30785	1
Exhaust Pipe Gasket	1989-1992		(Ring Type 'F'), Exhaust Pipe To Muffler	F7437	1
			(Flange Type), Pipe To Manifold	F7483	1
Thermostat O-Ring	1992-1995			C31505	1
Throttle Body Gasket	1989-1992			G31095	2
Water Outlet Gasket	1989-1995			C30645	1
	1989-1992		(O-Ring Type)	C31514	1
Water Pump Mount Gasket	1989-1992			K30640	1

5	1590CC (1.6L) G16KV (16 Valve) Suzuki 4 Cyl, 2.953in./75mm (1992-1997)				5
----------	---	--	--	--	----------

Part	Year	VIN	Model/Application	Part Number	Qty.
ENGINE GASKETS					
Cylinder Head Gasket	1992		<i>VR2000</i>	5866	1
Valve Cover Set	1992		(Contains Valve Cover Washers) <i>Cork Rubber</i>	VS50042	1
Valve Stem Seal, Exh.	1992			B45590	8
Valve Stem Seal, Int.	1992			B45590	8
Manifold Set, Exhaust	1992			MS15629	1
Manifold Set, Intake	1992			MS15628	1
Oil Pan Set	1992		<i>Cork Rubber</i>	OS32089	1
Rear Main Seal Set	1992			JV594	1
Timing Cover Set	1992		(Camshaft Seal Not Included)	JV1110	1
				JV5009	1

MISCELLANEOUS GASKETS					
Camshaft Seal	1992			66982	1
E.G.R. Gasket	1992			G30785	1
Exhaust Pipe Gasket	1992		(Ring Type 'F'), Exhaust Pipe To Muffler	F7437	1
			(Flange Type), Pipe To Manifold	F7483	1
Thermostat O-Ring	1992-1997			C31505	1
Throttle Body Gasket	1992			G31095	2
Water Outlet Gasket	1992-1995			C30645	1
	1992		(O-Ring Type)	C31514	1
Water Pump Mount Gasket	1992			K30640	1

Toyota Truck

Engine Index

Engine	Year	Block	Engine	Year	Block
1858CC (1.9L) 8RC SOHC Toyota	1968-1971	1	2366CC (2.4L) 22RE SOHC Toyota	1989-1995	11
1897CC (1.9L) 3RB OHV Toyota	1968-1970	2	2366CC (2.4L) 22REC SOHC Toyota	1984-1990	12
1897CC (1.9L) 3RC OHV Toyota	1968-1970	3	2366CC (2.4L) 22RTEC SOHC Toyota	1985-1988	13
1968CC (2.0L) 18RC SOHC Toyota	1972-1975	4	2438CC (2.4L) 2RZFE DOHC Toyota	1995-2001	14
1998CC (2.0L) 3SFE DOHC Toyota	1996-2000	5	2438CC (2.4L) 2TZFE DOHC Toyota	1990-1996	15
1998CC (2.0L) 3YEC OHV Toyota	1984-1985	6	2438CC (2.4L) 2TZFZE DOHC Toyota	1994-1996	16
2188CC (2.2L) L SOHC Toyota Diesel	1981-1983	7	2446CC (2.4L) 2L SOHC Toyota Diesel	1984-1985	17
2189CC (2.2L) 20R SOHC Toyota	1975-1980	8	2446CC (2.4L) 2LT SOHC Toyota Diesel	1985-1987	18
2237CC (2.2L) 4YEC OHV Toyota	1986-1990	9	2694CC (2.7L) 3RZFE DOHC Toyota	1994-2000	19
2366CC (2.4L) 22R SOHC Toyota	1981-1990	10	2958CC (3.0L) 3VZE SOHC Toyota	1988-1995	20

Toyota Truck

Engine Index (cont.)

Engine	Year	Block
2995CC (3.0L) 1MZFE DOHC Toyota	1998-2003	21
3378CC (3.4L) 5VZFE DOHC Toyota	1995-2003	22
3878CC (3.9L) F Toyota	1968-1975	23

Engine	Year	Block
3956CC (4.0L) 3FE OHV Toyota	1988-1992	24
4230CC (4.2L) 2F OHV Toyota	1975-1987	25

Model Index

Model	Engine	Year	Block
4 Runner	2366CC (2.4L) 22RE SOHC Toyota	1989-1995	11
4 Runner	2366CC (2.4L) 22RTEC SOHC Toyota	1986-1988	13
4 Runner	2366CC (2.4L) 22REC SOHC Toyota	1985-1990	12
4 Runner	2366CC (2.4L) 22R SOHC Toyota	1984	10
4 Runner	2694CC (2.7L) 3RZFE DOHC Toyota	1996-2000	19
4 Runner	2958CC (3.0L) 3VZE SOHC Toyota	1988-1995	20
4 Runner	3378CC (3.4L) 5VZFE DOHC Toyota	1996-2002	22
Highlander	2995CC (3.0L) 1MZFE DOHC Toyota	2001-2003	21
Hilux	1858CC (1.9L) 8RC SOHC Toyota	1968-1971	1
Hilux	1897CC (1.9L) 3RC OHV Toyota	1968-1970	3
Hilux	1968CC (2.0L) 18RC SOHC Toyota	1972-1975	4
Land Cruiser	3878CC (3.9L) F Toyota	1968-1975	23
Land Cruiser	3956CC (4.0L) 3FE OHV Toyota	1988-1992	24
Land Cruiser	4230CC (4.2L) 2F OHV Toyota	1975-1987	25
Pickup	2188CC (2.2L) L SOHC Diesel Toyota	1981-1983	7
Pickup	2189CC (2.2L) 20R SOHC Toyota	1975-1980	8
Pickup	2366CC (2.4L) 22RE SOHC Toyota	1989-1995	11
Pickup	2366CC (2.4L) 22RTEC SOHC Toyota	1985-1988	13
Pickup	2366CC (2.4L) 22REC SOHC Toyota	1984-1988	12
Pickup	2366CC (2.4L) 22R SOHC Toyota	1981-1990	10

Model	Engine	Year	Block
Pickup	2446CC (2.4L) 2LT SOHC Toyota Diesel	1985-1987	18
Pickup	2446CC (2.4L) 2L SOHC Toyota Diesel	1984-1987	17
Pickup	2958CC (3.0L) 3VZE SOHC Toyota	1988-1995	20
Previa	2438CC (2.4L) 2TZFE DOHC Toyota	1994-1997	16
Previa	2438CC (2.4L) 2TZFE DOHC Toyota	1990-1996	15
Rav 4	1998CC (2.0L) 3SFE DOHC Toyota	1996-2000	5
Sienna	2995CC (3.0L) 1MZFE DOHC Toyota	1998-2003	21
Stout	1897CC (1.9L) 3RB OHV Toyota	1965-1970	2
Stout	1897CC (1.9L) 3RC OHV Toyota	1968-1970	3
T100	2694CC (2.7L) 3RZFE DOHC Toyota	1994-1998	19
T100	2958CC (3.0L) 3VZE SOHC Toyota	1993-1995	20
T100	3378CC (3.4L) 5VZFE DOHC Toyota	1995-1998	22
Tacoma	2438CC (2.4L) 2RZFE DOHC Toyota	1995-2004	14
Tacoma	2694CC (2.7L) 3RZFE DOHC Toyota	1995-2004	19
Tacoma	3378CC (3.4L) 5VZFE DOHC Toyota	1995-2004	22
Tundra	3378CC (3.4L) 5VZFE DOHC Toyota	2000-2004	22
Van	1998CC (2.0L) 3YEC OHV Toyota	1984-1985	6
Van	2237CC (2.2L) 4YEC OHV Toyota	1986-1990	9

1 1858CC (1.9L) 8RC SOHC Toyota 4 Cyl, 3.386in./86mm (1968-1971) 1

Part	Year	VIN	Model/Application	Part Number	Qty.
------	------	-----	-------------------	-------------	------

ENGINE GASKETS

Head Set	1968-1971			HS3588	1
Full Set	1968-1971			FS3588	1
Cylinder Head Gasket	1968-1971		VR2000	3588	1
Valve Cover Set	1968-1971		(Valve Cover End Plug May Require Replacement) Cork Rubber	VS30007	1
Valve Stem Seal, Exh.	1968-1971			B20211	4
Valve Stem Seal, Int.	1968-1971			B20211	4
Manifold Set, Int. & Exh.	1968-1971			MS15231	1
Oil Pan Set	1968-1971		Cork Rubber	OS30042	1
Rear Main Seal Set	1968-1971			JV635	1
Timing Cover Set	1968-1971			JV911	1

MISCELLANEOUS GASKETS

Exhaust Pipe Gasket	1968-1971		(Flange Type), Pipe To Manifold	F14593	1
Fuel Pump Gasket	1968-1971			D20187	2
			(Spacer)	D31189	1
Valve Cover End Plug	1968-1971		(Half Round)	B45466	2
Water Outlet Gasket	1968-1971			C26085	1

Toyota Truck

1 (cont.)	1858CC (1.9L) 8RC SOHC Toyota 4 Cyl, 3.386in./86mm (1968-1971)					1 (cont.)
---------------------	---	--	--	--	--	---------------------

Part	Year	VIN	Model/Application	Part Number	Qty.
------	------	-----	-------------------	-------------	------

MISCELLANEOUS GASKETS (cont.)

Water Pump Cover Gasket	1968-1971			K30730	1
-------------------------	-----------	--	--	--------	---

2	1897CC (1.9L) 3RB OHV Toyota 4 Cyl, 3.465in./88mm (1968-1970)					2
----------	--	--	--	--	--	----------

Part	Year	VIN	Model/Application	Part Number	Qty.
------	------	-----	-------------------	-------------	------

ENGINE GASKETS

Head Set	1968-1970			HS3581	1
Full Set	1968-1970			FS3581	1
Cylinder Head Gasket	1968-1970		VR2000	3581	1
Valve Cover Set	1968-1970		Victo-Tech	VS30005	1
Manifold Set, Int. & Exh.	1968-1970			MS15340	1
Oil Pan Set	1968-1970		Cork Rubber	OS30041	1
Rear Main Seal Set	1968-1970			JV632	1
Timing Cover Seal	1968-1970			66859	1

MISCELLANEOUS GASKETS

Exhaust Pipe Gasket	1968-1970		(Ring Type 'A'), Pipe To Manifold	F14592	1
---------------------	-----------	--	-----------------------------------	--------	---

3	1897CC (1.9L) 3RC OHV Toyota 4 Cyl, 3.465in./88mm (1968-1970)					3
----------	--	--	--	--	--	----------

Part	Year	VIN	Model/Application	Part Number	Qty.
------	------	-----	-------------------	-------------	------

ENGINE GASKETS

Head Set	1968-1970			HS3581	1
Full Set	1968-1970			FS3581	1
Cylinder Head Gasket	1968-1970		VR2000	3581	1
Valve Cover Set	1968-1970		Victo-Tech	VS30005	1
Manifold Set, Int. & Exh.	1968-1970			MS15340	1
Oil Pan Set	1968-1970		Cork Rubber	OS30041	1
Rear Main Seal Set	1968-1970			JV632	1
Timing Cover Seal	1968-1970			66859	1

MISCELLANEOUS GASKETS

Exhaust Pipe Gasket	1968-1970		(Ring Type 'A'), Pipe To Manifold	F14592	1
Water Pump Mount Gasket	1968-1970			K27631	1

4	1968CC (2.0L) 18RC SOHC Toyota 4 Cyl, 3.484in./88.5mm (1972-1975)					4
----------	--	--	--	--	--	----------

Part	Year	VIN	Model/Application	Part Number	Qty.
------	------	-----	-------------------	-------------	------

ENGINE GASKETS

Head Set	1972-1975			HS3588	1
Full Set	1972-1975			FS3588	1
Cylinder Head Gasket	1972-1975		VR2000	3588	1
Valve Cover Set	1972-1975		(Valve Cover End Plug May Require Replacement) Cork Rubber	VS30007	1
Valve Stem Seal, Exh.	1972-1975			B20211	4
Valve Stem Seal, Int.	1972-1975			B20211	4
Manifold Set, Int. & Exh.	1972-1975			MS15231	1
Oil Pan Set	1972-1975		Cork Rubber	OS30042	1
Rear Main Seal Set	1972-1975			JV635	1
Timing Cover Set	1972-1975			JV911	1

MISCELLANEOUS GASKETS

Exhaust Pipe Gasket	1972-1975		(Flange Type), Front	F14593	1
			(Ring Type 'A'), Center	F14596	1
Fuel Pump Gasket	1972-1975			D20187	2

LIGHT TRUCK

4	1968CC (2.0L) 18RC SOHC Toyota 4 Cyl, 3.484in./88.5mm (1972-1975)	4
(cont.)		(cont.)

Part	Year	VIN	Model/Application	Part Number	Qty.
MISCELLANEOUS GASKETS (cont.)					
Fuel Pump Gasket (cont.)	1972-1975		(Spacer)	D31189	1
Valve Cover End Plug	1972-1975		(Half Round)	B45466	2
Water Outlet Gasket	1972-1975			C26085	1
Water Pump Cover Gasket	1972-1975			K30730	1

5	1998CC (2.0L) 3SFE DOHC Toyota 4 Cyl, 3.386in./86mm (1996-2000)	5
----------	--	----------

Part	Year	VIN	Model/Application	Part Number	Qty.
------	------	-----	-------------------	-------------	------

ENGINE GASKETS					
Head Set	1998-2000		Requires Throttle Body Gasket, (Contains Multi-layered Steel Head Gasket)	HS4920B	1
	1997		From 9/97, Requires Throttle Body Gasket, (Contains Multi-layered Steel Head Gasket)	HS4920B	1
			Thru 9/97, (Contains Multi-layered Steel Head Gasket)	HS4920B	1
	1996		(Contains Multi-layered Steel Head Gasket)	HS4920B	1
Cylinder Head Gasket	1999-2000		<i>Multi-Layered Steel</i>	4920S	1
	1996-1997		<i>Multi-Layered Steel</i>	4920S	1
	1996		<i>Nitroseal</i>	4920	1
Cyl. Head Bolt Set	1999-2000			GS33355	1
	1996-1997			GS33355	1
Valve Cover Set	1999-2000		(Contains Spark Plug Tube Seals)	VS50059	1
	1996-1997		(Contains Spark Plug Tube Seals)	VS50059	1
Valve Stem Seal, Exh.	1999-2000			B45549	8
	1996-1997			B45549	8
Valve Stem Seal, Int.	1999-2000			B45549	8
	1997			B45549	8
Manifold Set, Exhaust	1999-2000		<i>Multi-Layered Steel</i>	MS16509	1
	1996-1997		<i>Multi-Layered Steel</i>	MS16509	1
Manifold Set, Intake	1999-2000			MS16056	1
	1996-1997			MS16056	1
Oil Pan Set	1999-2000		<i>Cork Rubber</i>	OS30597	1
	1996-1997		<i>Cork Rubber</i>	OS30597	1
Rear Main Seal Set	1999-2000			JV530	1
	1996-1997			JV530	1

MISCELLANEOUS GASKETS					
Camshaft Seal	1999-2000			66905	1
	1996-1997			66905	1
Dist. Mounting Gasket	1997		Thru 9/97	72217	1
	1996			72217	1
Exhaust Pipe Gasket	1998-2000		Pipe To Manifold	F7572	1
	1997		2 Wheel Drive, Thru 9/97, Thru Serial Numbers SXA15-0008485, SXA16-0018679, And SXA16-7025008, (Ring Type 'A'), Exhaust Manifold To Converter	F7454	1
			4 Wheel Drive, Thru 9/97, Thru Serial Numbers SXA10-0170454, SXA11-0154875 And SXA11-7074879, (Ring Type 'A'), Exhaust Manifold To Converter	F7454	1
			2 Wheel Drive, 4 Wheel Drive, From 9/97, From Serial Numbers SXA10-0170454, SXA11-0154875, And SXA11-7074879, From Serial Numbers SXA15-0008485, SXA16-0018679, And SXA16-7025008, Pipe To Manifold	F7572	1
			2 Wheel Drive, Thru 9/97, Thru Serial Numbers SXA15-0008485, SXA16-0018679, And SXA16-7025008, Pipe To Manifold	F14594	1
			4 Wheel Drive, Thru 9/97, Thru Serial Numbers SXA10-0170454, SXA11-0154875 And SXA11-7074879, Pipe To Manifold	F14594	1
1996		(Ring Type 'A'), Pipe To Manifold	F7454	1	

Toyota Truck

5 (cont.)	1998CC (2.0L) 3SFE DOHC Toyota 4 Cyl, 3.386in./86mm (1996-2000)	5 (cont.)
---------------------	--	---------------------

Part	Year	VIN	Model/Application	Part Number	Qty.
MISCELLANEOUS GASKETS (cont.)					
Exhaust Pipe Gasket (cont.)	1996		Pipe To Manifold	F14594	1
Fuel Inj. O-Ring	1999-2000			B45744	8
	1996-1997			B45744	8
Fuel Injection Seal	1999-2000		(Grommet), Injector To Fuel Rail	B45854	4
	1996-1997		(Grommet), Injector To Fuel Rail	B45854	4
Therm. Housing Gasket	1999-2000			C24184	1
	1996-1997			C24184	1
Throttle Body Gasket	1997		2 Wheel Drive, Thru 9/97, Thru Serial Numbers SXA15-0008485, SXA16-0018679, And SXA16-7025008	G31008	1
			4 Wheel Drive, Thru 9/97, Thru Serial Numbers SXA10-0170454, SXA11-0154875 And SXA11-7074879	G31008	1
	1996			G31008	1
Water By-Pass Gasket	1999-2000		(O-Ring Type)	B45772	1
	1996-1997		(O-Ring Type)	B45772	1
Water Outlet Gasket	1999-2000			C30632	1
	1996-1997			C30632	1

6	1998CC (2.0L) 3YEC OHV Toyota 4 Cyl, 3.386in./86mm (1984-1985)	6
----------	---	----------

Part	Year	VIN	Model/Application	Part Number	Qty.
ENGINE GASKETS					
Head Set	1984-1985			HS3795	1
Full Set	1984-1985		(Oil Pan Gasket Not Included)	FS3795	1
Cylinder Head Gasket	1984-1985		<i>Nitroseal</i>	3795	1
Valve Cover Set	1984-1985		(Contains Valve Cover Washers, Contains Spark Plug Tube Seals) <i>Victo-Tech</i>	VS38433	1
Valve Stem Seal, Exh.	1984-1985			B20219	4
Valve Stem Seal, Int.	1984-1985			B20219	4
Plenum Chamber Gasket	1984-1985			MS12360	1
Manifold Set, Int. & Exh.	1984-1985		(Contains Plenum Chamber Gasket)	MS15384	1
Oil Pan Set	1984-1985		<i>Cork Rubber</i>	OS30044	1
Rear Main Seal Set	1984-1985			JV543	1
Timing Cover Set	1984-1985			JV1014	1

MISCELLANEOUS GASKETS

E.G.R. Gasket	1984-1985			G26354	1
Exhaust Pipe Gasket	1984-1985		(Flange Type), Pipe To Manifold	F7273	1
			(Ring Type 'A'), Catalytic Converter, Front	F7461	1
			(Ring Type 'A'), Catalytic Converter, Rear	F20252	1
Fuel Inj. O-Ring	1984-1985			B45744	4
Spark Plug Tube Seal	1984-1985			B45479	4
Throttle Body Gasket	1984-1985			G30962	1
Water Outlet Hsg. Gasket	1984-1985			C24219	1
Water Pipe O-Ring	1984-1985		<i>Victo-Tech</i>	C24184	1
Water Pump Mount Gasket	1984-1985			K27664	1

7	2188CC (2.2L) L SOHC Toyota Diesel 4 Cyl, 3.543in./90mm (1981-1983)	7
----------	--	----------

Part	Year	VIN	Model/Application	Part Number	Qty.
ENGINE GASKETS					
Head Set	1981-1983			HS3744	1
Full Set	1981-1983			FS3744	1
Cylinder Head Gasket	1981-1983			3744	1

LIGHT TRUCK

7 2188CC (2.2L) L SOHC Toyota Diesel 4 Cyl, 3.543in./90mm (1981-1983) **7**
(cont.) (cont.)

Part Year VIN Model/Application Part Number Qty.

ENGINE GASKETS (cont.)

Valve Cover Set	1981-1983		(Contains Valve Cover Washers) <i>Victo-Tech</i>	VS38348	1
Valve Stem Seal, Exh.	1981-1983			B45485	4
Valve Stem Seal, Int.	1981-1983			B45485	4
Manifold Set, Exhaust	1981-1983			MS15349	1
Manifold Set, Intake	1981-1983			MS15348	1
Oil Pan Set	1981-1983		<i>Cork Rubber</i>	OS30594	1
Rear Main Seal Set	1981-1983			JV522	1
Timing Cover Set	1981-1983			JV978	1

MISCELLANEOUS GASKETS

Exhaust Pipe Gasket	1981-1983		(Ring Type 'A'), Pipe To Manifold	F14592	1
Water Outlet Gasket	1981-1983			C26085	1
Water Pump Mount Gasket	1981-1983			K27248	1

8 2189CC (2.2L) 20R SOHC Toyota 4 Cyl, 3.484in./88.5mm (1975-1980) **8**

Part Year VIN Model/Application Part Number Qty.

ENGINE GASKETS

Head Set	1975-1980			HS3592X	1
Full Set	1975-1980			FS3592X	1
Engine Kit Gasket Set	1975-1980			95-3126VR	1
Cylinder Head Gasket	1975-1980		<i>Nitroseal</i>	3592	1
Valve Cover Set	1975-1980		(Contains Valve Cover Washers, Contains Valve Cover End Plugs) <i>Victo-Tech</i>	VS30011	1
Valve Stem Seal, Exh.	1975-1980			B20219	4
Valve Stem Seal, Int.	1975-1980			B20219	4
Manifold Set, Exhaust	1975-1980			MS15282A	1
Manifold Set, Intake	1975-1980			MS15266	1
Oil Pan Set	1975-1980		<i>Cork Rubber</i>	OS30047	1
Rear Main Seal Set	1975-1980			JV501	1
Crank Repair Sleeve	1975-1980		Use With Part Number A512 <i>Nickel Plated Formed Steel, .013" Thickness</i>	A346	1
Timing Cover Set	1975-1980			JV912	1
Timing Cover Seal	1975-1980			66514	1
Harmonic Balancer Repair Sleeve	1975-1980		Use With Part Number A504 <i>Nickel Plated Formed Steel, .013" Thickness</i>	A233	1

MISCELLANEOUS GASKETS

Carb. Mount Gasket	1975-1980		2 Barrel Carburetor	G30698	2
E.G.R. Gasket	1975-1980			G20364	1
Exhaust Pipe Gasket	1979-1980		(Ring Type 'A'), Front	F14594	1
			(Ring Type 'A'), Rear	F20252	1
			(Ring Type 'A'), Pipe To Manifold, Rear	F20252	1
	1975-1980		(Ring Type 'A'), Pipe To Manifold	F20252	1
	1975-1978		California, (Ring Type 'A'), Rear	F14592	1
Fuel Pump Gasket	1975-1980			D20187	2
			(Spacer)	D31189	1
Oil Pump Inlet Tube	1975-1980			B45715	1
Oil Pump Mounting Gasket	1975-1980			B45698	1
Valve Cover End Plug	1975-1980		(Half Round)	B45468	2
Valve Cover Washer	1975-1980			B45486	4
Water Outlet Gasket	1975-1980			C26085	1
Water Pump Mount Gasket	1975-1980			K27381	1

LIGHT TRUCK

Toyota Truck

9 2237CC (2.2L) 4YEC OHV Toyota 4 Cyl, 3.583in./91mm (1986-1990) **9**

Part	Year	VIN	Model/Application	Part Number	Qty.
ENGINE GASKETS					
Head Set	1986-1990			HS5708	1
Full Set	1986-1990		(Oil Pan Gasket Not Included)	FS5708	1
Cylinder Head Gasket	1986-1990		<i>Nitroseal</i>	5708	1
Valve Cover Set	1986-1990		(Contains Valve Cover Washers, Contains Spark Plug Tube Seals) <i>Victo-Tech</i>	VS38433	1
Valve Stem Seal, Exh.	1986-1990			B20219	4
Valve Stem Seal, Int.	1986-1990			B20219	4
Plenum Chamber Gasket	1986-1990			MS12364	1
Manifold Set, Int. & Exh.	1986-1990			MS15585	1
Oil Pan Set	1986-1990		<i>Cork Rubber</i>	OS30044	1
Rear Main Seal Set	1986-1990			JV543	1
Timing Cover Set	1986-1990			JV1014	1

MISCELLANEOUS GASKETS					
E.G.R. Gasket	1986-1989			G26354	1
Exhaust Pipe Gasket	1986-1990		(Flange Type), Pipe To Manifold	F7273	1
			(Ring Type 'A'), Catalytic Converter To Exhaust Pipe, Front	F7461	1
			(Ring Type 'A'), Catalytic Converter To Exhaust Pipe, Rear	F20252	1
Injector Nozzle O-Ring	1986-1990			B45744	4
Spark Plug Tube Seal	1986-1990			B45479	4
Throttle Body Gasket	1986-1990			G30962	1
Water Outlet Gasket	1986-1990		(O-Ring Type) <i>Victo-Tech</i>	C24184	1
Water Outlet Hsg. Gasket	1986-1990			C24219	1
Water Pump Mount Gasket	1986-1990			K27664	1

10 2366CC (2.4L) 22R SOHC Toyota 4 Cyl, 3.622in./92mm (1981-1990) **10**

Part	Year	VIN	Model/Application	Part Number	Qty.
ENGINE GASKETS					
Head Set	1985-1990			HS5707C	1
	1983-1984			HS5707B	1
	1981-1982		To Be Replaced By HS5707A	HS3705	1
				HS5707A	1
Lower Set	1981-1984		(Requires Head Set To Make Full Set)	CS5707A	1
Engine Kit Gasket Set	1985-1990			95-3428VR	1
	1983-1984			95-3427VR	1
	1981-1982		(Exhaust Manifold Gasket Not Included), Use With Part Number MS15282A	95-3427VR	1
Cylinder Head Gasket	1981-1990		(Original Style Flange) <i>Nitroseal</i>	5707	1
			(New Style Flange)	54355	1
Cyl. Head Spacer Shim	1981-1990		Requires Sealing Compound <i>Steel</i>	5707S	1
Sealing Compound	1981-1990		(4 Ounce Brush Top Can)	JV66B	1
			(12 Ounce Spray Can)	JV66S	1
Valve Cover Set	1985-1990		(Contains Valve Cover Washers, Contains Valve Cover End Plugs) <i>Victo-Tech</i>	VS50012	1
	1981-1984		(Contains Valve Cover Washers, Contains Valve Cover End Plugs) <i>Victo-Tech</i>	VS30011	1
Valve Stem Seal, Exh.	1989-1990			B45679	4
	1981-1988			B20219	4
Valve Stem Seal, Int.	1989-1990			B45679	4
	1981-1988			B20219	4
Manifold Set, Exhaust	1985-1990			MS16242	1
	1983-1984			MS16241	1
	1981-1982			MS15282A	1
Manifold Set, Intake	1981-1990		(Contains Plenum Chamber Gasket)	MS16240	1

10 2366CC (2.4L) 22R SOHC Toyota 4 Cyl, 3.622in./92mm (1981-1990) **10**
(cont.) (cont.)

Part Year VIN Model/Application Part Number Qty.

ENGINE GASKETS (cont.)

Manifold Set, Intake (cont.)	1981-1984		To Be Replaced By MS16240	MS15578	1
Plenum Chamber Gasket	1984-1990			MS12358	1
Oil Pan Set	1981-1990		<i>Cork Rubber</i>	OS30047	1
Rear Main Seal Set	1981-1990			JV501	1
Crank Repair Sleeve	1981-1990		Use With Part Number A512, Rear <i>Nickel Plated Formed Steel, .013" Thickness</i>	A346	1
Timing Cover Set	1985-1990			JV1021	1
	1981-1984			JV912	1
Harmonic Balancer Repair Sleeve	1981-1990		Use With Part Number A504 <i>Nickel Plated Formed Steel, .013" Thickness</i>	A233	1

MISCELLANEOUS GASKETS

Carb. Mount Heater Gasket	1983-1990			G30700	1
E.G.R. Gasket	1989-1990		Cooler	G31487	1
	1982-1990		Inlet	G20364	1
Exhaust Pipe Gasket	1983-1990		Pickup, (Ring Type 'A'), Pipe To Manifold	F14596	2
	1986-1988		Pickup, 4 Wheel Drive, California, (Ring Type 'A'), Front	F7461	1
			Pickup, 2 Wheel Drive, California, (Ring Type 'A'), Catalytic Converter, Front	F14594	1
			Pickup, California, (Ring Type 'A'), Catalytic Converter, Rear	F20252	1
			Pickup, Except California, (Ring Type 'A'), Catalytic Converter, Front	F20252	1
			Except California, (Ring Type 'A'), Catalytic Converter, Front	F20252	1
	1984		4 Runner, (Ring Type 'A'), Pipe To Manifold	F14596	2
1981-1982		Pickup, (Ring Type 'A'), Pipe To Manifold	F20252	1	
Fuel Pump Gasket	1981-1990			D20187	2
	1981-1988		(Spacer)	D31189	1
Injector Nozzle O-Ring	1981-1990			B45744	4
Oil Pump Inlet Tube	1981-1990			B45715	1
Oil Pump Mounting Gasket	1981-1990			B45698	1
Throttle Body Gasket	1989-1990			G31142	1
	1984-1988			G30958	1
Turbo Gasket Set	1985-1988			GS33074	1
Valve Cover End Plug	1981-1988		(Half Round)	B45468	2
Valve Cover Washer Seal	1985-1990			B45555	4
	1981-1984			B45486	4
Water Outlet Gasket	1983-1990		(O-Ring Type) <i>Victo-Tech</i>	C26118	1
	1981-1982			C26085	1
Water Pump Mount Gasket	1985-1990			K31563	1
	1981-1984			K27381	1

11 2366CC (2.4L) 22RE SOHC Toyota 4 Cyl, 3.622in./92mm (1989-1995) **11**

Part Year VIN Model/Application Part Number Qty.

ENGINE GASKETS

Head Set	1989-1995			HS5707C	1
Lower Set	1989-1995		(Requires Head Set To Make Full Set)	CS5707B	1
Engine Kit Gasket Set	1989-1995			95-3428VR	1
Cylinder Head Gasket	1989-1995		(Original Style Flange) <i>Nitroseal</i>	5707	1
			(New Style Flange)	54355	1
Cyl. Head Spacer Shim	1989-1995		Requires Sealing Compound <i>Steel</i>	5707S	1
Sealing Compound	1989-1995		(4 Ounce Brush Top Can)	JV66B	1
			(12 Ounce Spray Can)	JV66S	1

LIGHT TRUCK

Toyota Truck

11 (cont.)	2366CC (2.4L) 22RE SOHC Toyota 4 Cyl, 3.622in./92mm (1989-1995)				11 (cont.)
----------------------	--	--	--	--	----------------------

Part	Year	VIN	Model/Application	Part Number	Qty.
------	------	-----	-------------------	-------------	------

ENGINE GASKETS (cont.)

Valve Cover Set	1989-1995		(Contains Valve Cover Washers, Contains Valve Cover End Plugs) <i>Victo-Tech</i>	VS50012	1
Valve Stem Seal, Exh.	1989-1992			B45679	4
Valve Stem Seal, Int.	1989-1992			B45679	4
Manifold Set, Exhaust	1989-1995			MS16242	1
Manifold Set, Intake	1989-1995		(Contains Plenum Chamber Gasket)	MS16240	1
Plenum Chamber Gasket	1989-1992			MS12358	1
Oil Pan Set	1989-1995		<i>Cork Rubber</i>	OS30047	1
Rear Main Seal Set	1989-1995			JV501	1
Crank Repair Sleeve	1989-1995		Use With Part Number A512 <i>Nickel Plated Formed Steel, .013" Thickness</i>	A346	1
Timing Cover Set	1989-1995			JV1021	1
Timing Cover Seal	1989-1995			66514	1
Harmonic Balancer Repair Sleeve	1989-1995		Use With Part Number A504 <i>Nickel Plated Formed Steel, .013" Thickness</i>	A233	1

MISCELLANEOUS GASKETS

Carb. Mount Heater Gasket	1989-1990			G30700	1
E.G.R. Gasket	1989-1995		Cooler	G31487	1
	1989-1992		Inlet	G31143	1
Exhaust Pipe Gasket	1989-1995		4 Wheel Drive, (Ring Type 'A'), Catalytic Converter To Exhaust Pipe, Front	F7461	1
			2 Wheel Drive, (Ring Type 'A'), Catalytic Converter To Exhaust Pipe, Front	F14592	1
			(Ring Type 'A'), Pipe To Manifold	F14596	2
			(Ring Type 'A'), Catalytic Converter To Exhaust Pipe, Rear	F20252	1
Injector Nozzle O-Ring	1989-1995			B45744	4
Oil Pump Inlet Tube	1989-1992			B45715	1
Oil Pump Mounting Gasket	1989-1995			B45698	1
Throttle Body Gasket	1989-1992			G31142	1
Valve Cover Washer Seal	1989-1995			B45555	4
Water Outlet Gasket	1989-1995		(O-Ring Type) <i>Victo-Tech</i>	C26118	1
Water Pump Mount Gasket	1989-1995			K31563	1

12	2366CC (2.4L) 22REC SOHC Toyota 4 Cyl, 3.622in./92mm (1984-1990)				12
-----------	---	--	--	--	-----------

Part	Year	VIN	Model/Application	Part Number	Qty.
------	------	-----	-------------------	-------------	------

ENGINE GASKETS

Head Set	1985-1990			HS5707C	1
	1984			HS5707B	1
Lower Set	1985-1990		(Requires Head Set To Make Full Set)	CS5707B	1
	1984		(Requires Head Set To Make Full Set)	CS5707A	1
Engine Kit Gasket Set	1985-1990			95-3428VR	1
	1984-1988			95-3427VR	1
Cylinder Head Gasket	1984-1990		(Original Style Flange) <i>Nitroseal</i>	5707	1
			(New Style Flange)	54355	1
Cyl. Head Spacer Shim	1984-1990		Requires Sealing Compound <i>Steel</i>	5707S	1
Sealing Compound	1984-1990		(4 Ounce Brush Top Can)	JV66B	1
			(12 Ounce Spray Can)	JV66S	1
Valve Cover Set	1985-1990		(Contains Valve Cover Washers, Contains Valve Cover End Plugs) <i>Victo-Tech</i>	VS50012	1
	1984		(Contains Valve Cover Washers, Contains Valve Cover End Plugs) <i>Victo-Tech</i>	VS30011	1
Valve Stem Seal, Exh.	1984-1990			B20219	4

12 2366CC (2.4L) 22REC SOHC Toyota 4 Cyl, 3.622in./92mm (1984-1990) **12**
(cont.) (cont.)

Part	Year	VIN	Model/Application	Part Number	Qty.
ENGINE GASKETS (cont.)					
Valve Stem Seal, Int.	1984-1990			B20219	4
Manifold Set, Exhaust	1985-1990			MS16242	1
	1984			MS16241	1
Manifold Set, Intake	1984-1990		(Contains Plenum Chamber Gasket)	MS16240	1
Plenum Chamber Gasket	1984-1990			MS12358	1
Oil Pan Set	1984-1990		Cork Rubber	OS30047	1
Rear Main Seal Set	1984-1990			JV501	1
Crank Repair Sleeve	1984-1990		Use With Part Number A512	A346	1
			Nickel Plated Formed Steel, .013" Thickness		
Timing Cover Set	1985-1990			JV1021	1
	1984			JV912	1
Timing Cover Seal	1984-1990			66514	1
Harmonic Balancer Repair Sleeve	1984-1990		Use With Part Number A504	A233	1
			Nickel Plated Formed Steel, .013" Thickness		

MISCELLANEOUS GASKETS

Carb. Mount Heater Gasket	1984-1990			G30700	1
E.G.R. Gasket	1989-1990		Cooler	G31487	1
	1984-1990		Inlet	G30703	1
Exhaust Pipe Gasket	1984-1990		4 Wheel Drive, (Ring Type 'A'), Catalytic Converter To Exhaust Pipe, Front	F7461	1
			2 Wheel Drive, (Ring Type 'A'), Catalytic Converter To Exhaust Pipe, Front	F14592	1
			(Ring Type 'A'), Pipe To Manifold	F14596	2
			(Ring Type 'A'), Catalytic Converter To Exhaust Pipe, Rear	F20252	1
Injector Nozzle O-Ring	1984-1990			B45744	4
Oil Pump Inlet Tube	1984-1990			B45715	1
Oil Pump Mounting Gasket	1985-1990			B45698	1
Throttle Body Gasket	1989-1990			G31142	1
	1984-1988			G30958	1
Valve Cover End Plug	1984-1990		(Half Round)	B45468	2
Valve Cover Washer Seal	1985-1990			B45555	4
Water Outlet Gasket	1984-1990		(O-Ring Type) Victo-Tech	C26118	1
Water Pump Mount Gasket	1985-1990			K31563	1
	1984			K27381	1

13 2366CC (2.4L) 22RTEC SOHC Toyota 4 Cyl, 3.622in./92mm (1985-1988) **13**

Part	Year	VIN	Model/Application	Part Number	Qty.
ENGINE GASKETS					
Head Set	1985-1988			HS5707D	1
Lower Set	1985-1988		(Requires Head Set To Make Full Set)	CS5707B	1
Cylinder Head Gasket	1986-1988		(Original Style Flange) Nitroseal	5707	1
	1985-1988		(New Style Flange)	54355	1
Cyl. Head Spacer Shim	1985-1988		Requires Sealing Compound Steel	5707S	1
Sealing Compound	1985-1988		(4 Ounce Brush Top Can)	JV66B	1
			(12 Ounce Spray Can)	JV66S	1
Valve Cover Set	1985-1988		(Contains Valve Cover Washers, Contains Valve Cover End Plugs) Victo-Tech	VS50012	1
Valve Stem Seal, Exh.	1985-1988		Turbocharged	B20219	4
Valve Stem Seal, Int.	1985-1988		Turbocharged	B20219	4
Manifold Set, Exhaust	1985-1988			MS15584	1
Manifold Set, Intake	1985-1988		(Contains Plenum Chamber Gasket)	MS16240	1
Oil Pan Set	1985-1988		Cork Rubber	OS30047	1

LIGHT TRUCK

Toyota Truck

13 (cont.)	2366CC (2.4L) 22RTEC SOHC Toyota 4 Cyl, 3.622in./92mm (1985-1988)				13 (cont.)
----------------------	--	--	--	--	----------------------

Part	Year	VIN	Model/Application	Part Number	Qty.
------	------	-----	-------------------	-------------	------

ENGINE GASKETS (cont.)

Rear Main Seal Set	1985-1988			JV501	1
Crank Repair Sleeve	1985-1988		Use With Part Number A512 <i>Nickel Plated Formed Steel, .013" Thickness</i>	A346	1
Timing Cover Set	1985-1988			JV1021	1
Timing Cover Seal	1985-1988			66514	1
Harmonic Balancer Repair Sleeve	1985-1988		Use With Part Number A504 <i>Nickel Plated Formed Steel, .013" Thickness</i>	A233	1

MISCELLANEOUS GASKETS

Carb. Mount Heater Gasket	1985-1988		Turbocharged	G30700	1
E.G.R. Gasket	1985-1988		Turbocharged	G30703	1
Exhaust Pipe Gasket	1985-1988		(Ring Type 'A'), Turbocharged, Pipe To Manifold	F10039	1
Valve Cover End Plug	1985-1988		(Half Round), Turbocharged	B45468	2
Valve Cover Washer Seal	1985-1988		Turbocharged	B45555	4
Water Outlet Gasket	1985-1988		(O-Ring Type), Turbocharged <i>Victo-Tech</i>	C26118	1
Water Pump Mount Gasket	1985-1988		Turbocharged	K31563	1

14	2438CC (2.4L) 2RZFE DOHC Toyota 4 Cyl, 3.740in./95mm (1995-2001)				14
-----------	---	--	--	--	-----------

Part	Year	VIN	Model/Application	Part Number	Qty.
------	------	-----	-------------------	-------------	------

ENGINE GASKETS

Head Set	2000		California Intake Manifold Gasket Not Included	HS54173A	1
	1995-1999			HS54173A	1
Lower Set	1995-2000			CS54173A	1
Cylinder Head Gasket	1995-2001		<i>Nitroseal</i>	54173G	1
Valve Cover Set	1995-2001		(Contains Spark Plug Tube Seals, Valve Cover Grommets Not Included) <i>Victo-Tech</i>	VS50272	1
Valve Stem Seal, Int.	1995-2001			B45549	8
Manifold Set, Exhaust	1995-2001		<i>Steel</i>	MS16270	1
Manifold Set, Intake	2001			MS16271	1
	2000		California Intake Manifold Gasket Not Included <i>Victo-Plate</i>	MS16269	1
			California	MS16271	1
	1995-1999		<i>Victo-Plate</i>	MS16269	1
Oil Pan Set	1995-1996		Crankcase Cover <i>Cork Rubber</i>	OS32106	1
Rear Main Seal Set	1995-2000			JV598	1
Timing Cover Set	1995-2000		<i>Victo-Plate</i>	JV5007	1

MISCELLANEOUS GASKETS

Exhaust Pipe Gasket	2001		(Ring Type 'A'), Pipe To Manifold	F14592	1
	2000		Federal Emission, Thru 9/00, Catalytic Converter To Exhaust Pipe, Catalytic Converter To Front Exhaust Pipe	F7461	2
			California, (Ring Type 'A'), Pipe To Manifold	F14592	1
			Except California, (Ring Type 'A'), Pipe To Manifold	F14592	2
	1998-1999		Federal Emission, Catalytic Converter To Exhaust Pipe, Catalytic Converter To Front Exhaust Pipe	F7461	2
	1995-1999		(Ring Type 'A'), Pipe To Manifold	F14592	2
	1995-1997		Catalytic Converter To Exhaust Pipe, Catalytic Converter To Front Exhaust Pipe	F7461	2
Fuel Inj. O-Ring	1995-2001			B45744	4
Fuel Injection Seal	1995-2000		(Grommet), Injector To Fuel Rail	B45854	4
Fuel Reg. O-Ring	1995-2001			B45744	1
Spark Plug Tube Seal	1995-2000			B45778	4
Therm. Housing Gasket	1995-2001		<i>Victo-Plate</i>	C31572	1
Thermostat O-Ring	1995-2000			C31090	1
Valve Cover Grommet	1995-2001			B45809	10
Water Pump Gasket	1995-2001		<i>Victo-Plate</i>	K31571	1

LIGHT TRUCK

15 2438CC (2.4L) 2TZFE DOHC Toyota 4 Cyl, 3.740in./95mm (1990-1996) 15

Part	Year	VIN	Model/Application	Part Number	Qty.
ENGINE GASKETS					
Head Set	1990-1995			HS5890	1
Full Set	1990-1995		(Oil Pan Gasket Not Included)	FS5890	1
Cylinder Head Gasket	1990-1995			Nitroseal 5890	1
Valve Cover Set	1990-1996		(Contains Spark Plug Tube Seals)	Victo-Tech VS50141	1
Valve Stem Seal, Exh.	1990-1995			B45549	8
Valve Stem Seal, Int.	1990-1995			B45657	8
Manifold Set, Exhaust	1990-1996			MS15685	1
Manifold Set, Intake	1990-1996			MS15682	1
Oil Pan Set	1990-1996		Crankcase Cover	Cork Rubber OS32106	1
			Sump	Cork Rubber OS32107	1
Rear Main Seal Set	1990-1996			JV598	1
Timing Cover Set	1990-1996			JV1123	1

MISCELLANEOUS GASKETS					
E.G.R. Gasket	1990-1995		Valve	G31168	1
			Inlet	G31169	1
Injector Nozzle O-Ring	1990-1995			B45744	4
Therm. Housing Gasket	1990-1996			C31165	1
Thermostat O-Ring	1990-1996		(O-Ring Type)	Victo-Tech C31090	1
Throttle Body Gasket	1990-1995			G31167	1
Valve Cover Washer Seal	1995-1996			B45809	10
Water Pump Mount Gasket	1990-1996			K31166	1

16 2438CC (2.4L) 2TZFE DOHC Toyota 4 Cyl, 3.740in./95mm (1994-1996) 16

Part	Year	VIN	Model/Application	Part Number	Qty.
ENGINE GASKETS					
Head Set	1994-1995			HS5890	1
Full Set	1994-1995		(Oil Pan Gasket Not Included)	FS5890	1
Cylinder Head Gasket	1994-1995			Nitroseal 5890	1
Valve Cover Set	1994-1996		(Contains Spark Plug Tube Seals)	Victo-Tech VS50141	1
Manifold Set, Exhaust	1994-1996			MS15685	1
Manifold Set, Intake	1994-1996			MS15682	1
Oil Pan Set	1994-1996		Crankcase Cover	Cork Rubber OS32106	1
			Sump	Cork Rubber OS32107	1
Rear Main Seal Set	1994-1996			JV598	1
Timing Cover Set	1994-1996			JV1123	1

MISCELLANEOUS GASKETS					
E.G.R. Gasket	1994-1995		Previa, Supercharged, Valve	G31168	1
			Previa, Supercharged, Inlet	G31169	1
Exhaust Pipe Gasket	1994-1996		Previa, (Ring Type 'A'), Supercharged, Catalytic Converter To Exhaust Pipe, Front	F7459	1
			Previa, (Ring Type 'A'), Supercharged, Catalytic Converter To Exhaust Pipe, Rear	F7460	1
Injector Nozzle O-Ring	1994-1995		Previa, Supercharged	B45744	4
Therm. Housing Gasket	1994-1996		Previa, Supercharged	C31165	1
Thermostat O-Ring	1994-1996		Previa, (O-Ring Type), Supercharged	Victo-Tech C31090	1
Throttle Body Gasket	1994-1995		Previa, Supercharged	G31167	1
Valve Cover Washer Seal	1995-1996		Previa, Supercharged	B45809	10
Water Pump Mount Gasket	1994-1996		Previa, Supercharged	K31166	1

Toyota Truck

17 2446CC (2.4L) 2L SOHC Toyota Diesel 4 Cyl, 3.622in./92mm (1984-1985)

17

Part	Year	VIN	Model/Application	Part Number	Qty.
ENGINE GASKETS					
Valve Cover Set	1984-1985		(Contains Valve Cover Washers) <i>Victo-Tech</i>	VS38348	1
Valve Stem Seal, Exh.	1984-1985			B45485	4
Valve Stem Seal, Int.	1984-1985			B45485	4
Manifold Set, Exhaust	1984-1985			MS15381	1
Manifold Set, Intake	1984-1985			MS15348	1
Oil Pan Set	1984-1985		<i>Cork Rubber</i>	OS30594	1
Rear Main Seal Set	1984-1985			JV522	1
Timing Cover Set	1984-1985			JV1013	1

MISCELLANEOUS GASKETS

E.G.R. Gasket	1984-1985			G30705	1
Exhaust Pipe Gasket	1984-1985		(Ring Type 'A'), Pipe To Manifold	F14592	1
Therm. Housing Gasket	1984-1985			C24194	1
Water Outlet Gasket	1984-1985			C24193	1
Water Pump Mount Gasket	1984-1985			K27248	1

18 2446CC (2.4L) 2LT SOHC Toyota Diesel 4 Cyl, 3.622in./92mm (1985-1987)

18

Part	Year	VIN	Model/Application	Part Number	Qty.
ENGINE GASKETS					
Valve Cover Set	1985-1987		(Contains Valve Cover Washers) <i>Victo-Tech</i>	VS38348	1
Valve Stem Seal, Exh.	1985			B45485	4
Valve Stem Seal, Int.	1985			B45485	4
Manifold Set, Intake	1985			MS15348	1
Oil Pan Set	1985-1987		<i>Cork Rubber</i>	OS30594	1
Rear Main Seal Set	1985-1987			JV522	1
Timing Cover Set	1985-1987			JV1013	1

MISCELLANEOUS GASKETS

E.G.R. Gasket	1985			G30705	1
Exhaust Pipe Gasket	1985-1987		(Ring Type 'A'), Pipe To Manifold	F14594	1
Therm. Housing Gasket	1987			C24194	1
Thermostat O-Ring	1985		<i>Victo-Tech</i>	C26118	1
Water Outlet Gasket	1987			C24193	1
Water Pump Mount Gasket	1985-1987			K27248	1

19 2694CC (2.7L) 3RZFE DOHC Toyota 4 Cyl, 3.740in./95mm (1994-2000)

19

Part	Year	VIN	Model/Application	Part Number	Qty.
ENGINE GASKETS					
Head Set	2000		California Intake Manifold Gasket Not Included	HS54173A	1
	1994-1999			HS54173A	1
Lower Set	1994-2000			CS54173B	1
Cylinder Head Gasket	1994-2000		<i>Nitroseal</i>	54173G	1
Valve Cover Set	1994-2000		(Contains Spark Plug Tube Seals, Valve Cover Grommets Not Included) <i>Victo-Tech</i>	VS50272	1
Valve Stem Seal, Exh.	1994-2000			B45882	8
Valve Stem Seal, Int.	1997-2000			B45549	8
Manifold Set, Exhaust	1994-2000		<i>Steel</i>	MS16270	1
Manifold Set, Intake	2000		California Intake Manifold Gasket Not Included <i>Victo-Plate</i>	MS16269	1
			California <i>Victo-Plate</i>	MS16271	1
	1994-1999		<i>Victo-Plate</i>	MS16269	1
Oil Pan Set	1994-2000		<i>Cork Rubber</i>	OS32106	1
Rear Main Seal Set	1994-2000			JV598	1
Timing Cover Set	1994-2000		<i>Victo-Plate</i>	JV5008	1

LIGHT TRUCK

19 2694CC (2.7L) 3RZFE DOHC Toyota 4 Cyl, 3.740in./95mm (1994-2000) **19**
 (cont.) (cont.)

Part	Year	VIN	Model/Application	Part Number	Qty.
MISCELLANEOUS GASKETS					
Exhaust Pipe Gasket	1994-2000			F14592	2
Spark Plug Tube Seal	1994-2000			B45778	4
Therm. Housing Gasket	1994-2000		Victo-Plate	C31572	1
Thermostat O-Ring	1994-2000		Victo-Tech	C31090	1
Valve Cover Grommet	1994-2000			B45809	10
Water Pump Gasket	1994-2000		Victo-Plate	K31571	1

20 2958CC (3.0L) 3VZE SOHC Toyota V6 Cyl, 3.445in./87.5mm (1988-1995) **20**

Part	Year	VIN	Model/Application	Part Number	Qty.
ENGINE GASKETS					
Head Set	1988-1995		(Exhaust Manifold Gasket Not Included)	HS54185	1
Lower Set	1988-1995			CS54185	1
Full Set	1988-1995		(Exhaust Manifold Gasket Not Included)	FS54185	1
Engine Kit Gasket Set	1988-1995			95-3454VR	1
Cylinder Head Gasket	1988-1995		Right	Nitroseal 54185	1
			Left	Nitroseal 54186	1
Cyl. Head Bolt Set	1988-1995			GS33369	1
Cyl. Head Washer Set	1992-1995			GS33354	2
	1991		From 6/91	GS33354	2
Cyl. Head Spacer Shim	1988-1995		Requires Sealing Compound, Right	Steel 5806S	1
			Requires Sealing Compound, Left	Steel 5807S	1
Sealing Compound	1988-1995		(4 Ounce Brush Top Can)	JV66B	1
			(12 Ounce Spray Can)	JV66S	1
Valve Cover Set	1988-1995		Victo-Tech	VS50064	1
Valve Stem Seal, Exh.	1988-1995			B20219	6
Valve Stem Seal, Int.	1988-1995			B20219	6
Manifold Set, Exhaust	1988-1995		Right	MS15474	1
			Left	MS15475	1
Manifold Set, Intake	1988-1995		(Contains Plenum Chamber Gasket)	MS15473	1
Plenum Chamber Gasket	1988-1995		4 Runner, Pickup	MS15476	1
Oil Pan Set	1988-1995			OS32231	1
Rear Main Seal Set	1988-1995			JV570	1
Timing Cover Set	1988-1995		(Contains Dust Seals)	JV1070	1
			(Dust Seals Not Included)	JV1145	1
Timing Cover Seal	1988-1995			67010	1
MISCELLANEOUS GASKETS					
Cam. Circular Plug	1988-1995			B45855	1
Camshaft Seal Set	1988-1995			JV1102	1
E.G.R. Gasket	1988-1995		Valve Adapter	G31035	1
			Inlet	G31036	1
Exhaust Pipe Gasket	1988-1995		(Ring Type 'A'), Pipe To Manifold	F7461	1
			(Ring Type 'A'), Catalytic Converter To Exhaust Pipe, Front	F14594	1
			(Ring Type 'A'), Catalytic Converter To Exhaust Pipe, Rear	F20252	1
	1988-1991		Crossover Pipe	F7463	1
Injector Nozzle O-Ring	1988-1995			B45744	4
Thermostat O-Ring	1988-1995		Victo-Tech	C26118	1
Throttle Body Gasket	1988-1995		4 Runner, Pickup	G31033	1
Water By-Pass Gasket	1988-1995			C31504	1
Water Pump Mount Gasket	1988-1995			K31218	1

LIGHT TRUCK

Toyota Truck

21 2995CC (3.0L) 1MZFE DOHC Toyota V6 Cyl, 3.445in./87.5mm (1998-2003)

21

Part	Year	VIN	Model/Application	Part Number	Qty.
ENGINE GASKETS					
Head Set	2003		Highlander, Thru 4/03	HS54339	1
	2001-2002		Highlander	HS54339	1
	2000		Sienna	HS54336	1
	1998-1999		Sienna	HS54339	1
Lower Set	1998-2003			CS54339	1
Cylinder Head Gasket	2003		Highlander, Thru 4/03, Left <i>Multi-Layered Steel</i>	54338	1
			Highlander, Thru 4/03, Right <i>Multi-Layered Steel</i>	54339	1
	2001-2002		Highlander, Left <i>Multi-Layered Steel</i>	54338	1
			Highlander, Right <i>Multi-Layered Steel</i>	54339	1
	2000		Sienna, Left <i>Multi-Layered Steel</i>	54336	1
			Sienna, Right <i>Multi-Layered Steel</i>	54337	1
	1998-1999		Sienna, Left <i>Multi-Layered Steel</i>	54338	1
			Sienna, Right <i>Multi-Layered Steel</i>	54339	1
Valve Cover Set	1998-2003		(Contains Spark Plug Tube Seals)	VS50291	1
Manifold Gasket, Exh.	1998-2003		<i>Multi-Layered Steel</i>	MS16344	1
Manifold Gasket, Int.	1998-2003			MS16348	1
Plenum Chamber Gasket	1998-2003			MS16073	1
Oil Pan Set	1998-2003		<i>Cork Rubber</i>	OS32237	1
Rear Main Seal Set	1998-2003			JV1655	1
Timing Cover Set	1998-2003			JV1145	1
Timing Cover Seal	1998-2003			67010	1

MISCELLANEOUS GASKETS

Camshaft Seal	1998-2003			66905	2
Camshaft Seal Set	1998-2003			JV5023	1
Exhaust Pipe Gasket	2001-2003		Highlander, (Ring Type 'A'), Converter To Exhaust Pipe	F20252	1
	1998-2003		Pipe To Manifold	F7572	2
Fuel Inj. O-Ring	1998-2003			B45744	4
Fuel Injection Seal	1998-2003		(Grommet), Injector To Fuel Rail	B45854	2
Thermostat O-Ring	1998-2003		<i>Victo-Tech</i>	C31090	1
Throttle Body Gasket	1998-2003			G31624	1
Water Pump Gasket	1998-2003			K31626	1

22 3378CC (3.4L) 5VZFE DOHC Toyota V6 Cyl, 3.681in./93.5mm (1995-2003)

22

Part	Year	VIN	Model/Application	Part Number	Qty.
ENGINE GASKETS					
Head Set	1995-2000		<i>Multi-Layered Steel</i>	HS54137	1
Lower Set	1995-2000			CS54137	1
Cylinder Head Gasket	1995-2003		(Contains Left And Right Bank) <i>Multi-Layered Steel</i>	54137	1
Cyl. Head Bolt Set	1995-2003			GS33353	2
Cyl. Head Washer Set	1995-2003			GS33354	2
Valve Cover Set	1995-2003		(Contains Spark Plug Tube Seals) <i>Victo-Tech</i>	VS50158	1
Valve Stem Seal, Exh.	1995-2003			B45882	12
Valve Stem Seal, Int.	1995-2003			B45549	12
Manifold Set, Exhaust	1995-2003		<i>Multi-Layered Steel</i>	MS16263	1
Manifold Set, Intake	1995-2003		(Contains Plenum Chamber Gasket) <i>Multi-Layered Steel</i>	MS16262	1
Oil Pan Set	1995-2000		<i>Cork Rubber</i>	OS32188	1
Rear Main Seal	1995-2003			JV570	1
Rear Main Seal Set	1995-2000			JV1645	1
Timing Cover Set	1995-2000			JV1145	1
Timing Cover Seal	1995-2003			67010	1

MISCELLANEOUS GASKETS

Camshaft Seal Set	1995-2001		(Contains Camshaft Circular Plugs)	JV5024	1
E.G.R. Gasket	1995-1996		Valve	G31036	1
Exhaust Pipe Gasket	1998-2001		Catalytic Converter To Center Pipe	F7460	1
	1995-1998		Exhaust Pipe To Converter	F7572	2

22 (cont.)	3378CC (3.4L) 5VZFE DOHC Toyota V6 Cyl, 3.681in./93.5mm (1995-2003)	22 (cont.)
----------------------	--	----------------------

Part	Year	VIN	Model/Application	Part Number	Qty.
MISCELLANEOUS GASKETS (cont.)					
Fuel Inj. O-Ring	1995-1998			B45744	12
Fuel Injection Seal	1995-1998		(Grommet), Injector To Fuel Rail	B45854	6
Fuel Reg. O-Ring	1995-1998			B45744	1
Therm. Housing Gasket	1995-1996			C31165	1
Thermostat O-Ring	1995-2003		<i>Victo-Tech</i>	C31090	1
Water Pump Mount Gasket	1995-2000			K31564	1

23	3878CC (3.9L) F Toyota 6 Cyl, 3.543in./90mm (1968-1975)	23
-----------	--	-----------

Part	Year	VIN	Model/Application	Part Number	Qty.
ENGINE GASKETS					
Head Set	1974-1975			HS3943	1
	1968-1973			HS3942	1
Full Set	1974-1975			FS3943	1
	1968-1973			FS3942	1
Cylinder Head Gasket	1974-1975		<i>VR2000</i>	3943	1
	1968-1973		<i>VR2000</i>	3942	1
Valve Cover Set	1968-1975		<i>Cork Rubber</i>	VS30010	1
Valve Stem Seal, Exh.	1968-1975			B20217	6
Valve Stem Seal, Int.	1968-1975			B20217	6
Manifold Set, Int. & Exh.	1968-1975			MS16222	1
Oil Pan Set	1968-1975		<i>Cork Rubber</i>	OS32196	1
Rear Main Seal Set	1968-1975			JV636	1
Timing Cover Set	1968-1975			JV913	1

MISCELLANEOUS GASKETS

Exhaust Pipe Gasket	1968-1975		(Ring Type 'A'), Pipe To Manifold	F14594	1
Push Rod Cover Set	1968-1975			PS30147	1
Therm. Housing Gasket	1968-1975			C26090	1
Thermostat O-Ring	1968-1975		<i>Victo-Tech</i>	C26093	1
Water Outlet Gasket	1968-1975			C31580	1

24	3956CC (4.0L) 3FE OHV Toyota 6 Cyl, 3.701in./94mm (1988-1992)	24
-----------	--	-----------

Part	Year	VIN	Model/Application	Part Number	Qty.
ENGINE GASKETS					
Cylinder Head Gasket	1988-1992		<i>VR2000</i>	3944	1
Valve Cover Set	1988-1992		(Contains Valve Cover Washers) <i>Victo-Tech</i>	VS50232	1
Valve Stem Seal, Exh.	1988-1992			B45457	6
Valve Stem Seal, Int.	1988-1992			B45457	6
Plenum Chamber Gasket	1988-1992			MS16114	1
Manifold Set, Int. & Exh.	1988-1992			MS16113	1
Oil Pan Set	1988-1992		<i>Cork Rubber</i>	OS32196	1
Rear Main Seal Set	1988-1992			JV1644	1
Timing Cover Set	1988-1992			JV913	1

MISCELLANEOUS GASKETS

E.G.R. Gasket	1988-1992		Inlet	G31551	1
Exhaust Pipe Gasket	1988-1992		(Ring Type 'A'), Pipe To Manifold	F14592	1
			(Ring Type 'A'), Catalytic Converter To Exhaust Pipe	F20252	1
Fuel Pump Gasket	1988-1992			D20187	2
			(Spacer)	D31189	1
Injector Nozzle O-Ring	1988-1992			B45744	4

Toyota Truck

24 (cont.)	3956CC (4.0L) 3FE OHV Toyota 6 Cyl, 3.701in./94mm (1988-1992)	24 (cont.)
----------------------	--	----------------------

Part	Year	VIN	Model/Application	Part Number	Qty.
MISCELLANEOUS GASKETS (cont.)					
Push Rod Cover Set	1988-1992			PS50255	1
Therm. Housing Gasket	1988-1992			C31549	1
Thermostat O-Ring	1988-1992			C31557	1
Throttle Body Gasket	1988-1992			G31550	1
Water Outlet Gasket	1988-1992			C24094	1
Water Pump Mount Gasket	1988-1992			K31548	1

25	4230CC (4.2L) 2F OHV Toyota 6 Cyl, 3.701in./94mm (1975-1987)	25
-----------	---	-----------

Part	Year	VIN	Model/Application	Part Number	Qty.
ENGINE GASKETS					
Head Set	1981-1987			HS3944W	1
	1975-1980			HS3944	1
Full Set	1981-1987			FS3944W	1
	1975-1980			FS3944	1
Cylinder Head Gasket	1975-1987		VR2000	3944	1
Valve Cover Set	1981-1987		Victo-Tech	VS39795	1
	1975-1980		Cork Rubber	VS30109	1
Valve Stem Seal, Exh.	1981-1987			B45457	6
	1975-1980			B20218	6
Valve Stem Seal, Int.	1981-1987			B45457	6
	1975-1980			B20218	6
Manifold Set, Int. & Exh.	1975-1987			MS16716	1
Oil Pan Set	1975-1987		Cork Rubber	OS32196	1
Rear Main Seal Set	1975-1987			JV636	1
Timing Cover Set	1975-1987			JV913	1

MISCELLANEOUS GASKETS					
E.G.R. Gasket	1981-1983		Exhaust Manifold To EGR Inlet Pipe	G24670	1
			Intake Manifold Inlet	G24671	1
Exhaust Pipe Gasket	1975-1987		(Ring Type 'A'), Pipe To Manifold	F20257	1
Fuel Pump Gasket	1975-1987			D20187	2
			(Spacer)	D31189	2
Push Rod Cover Set	1975-1987			PS30147	1
Therm. Housing Gasket	1975-1980			C26090	1
Thermostat O-Ring	1975-1980		Victo-Tech	C26093	1
Water Outlet Gasket	1981-1987			C24094	1
	1975-1980			C31580	1
Water Pump Mount Gasket	1975-1987			K27377	1

Volkswagen Truck

Engine Index

Engine	Year	Block	Engine	Year	Block
1192CC (1.2L) 40 Horsepower Volkswagen	1961-1964	1	1679CC (1.7L) CB Volkswagen	1972-1974	9
1471CC (1.5L) CK Volkswagen Diesel	1980	2	1715CC (1.7L) EN Volkswagen	1981-1983	10
1493CC (1.5L) 50 B.H.P./HO Volkswagen	1963-1967	3	1715CC (1.7L) JF Volkswagen	1982	11
1584CC (1.6L) B Volkswagen	1968-1971	4	1795CC (1.8L) ED Volkswagen	1974-1975	12
1588CC (1.6L) CR Volkswagen Diesel	1981-1983	5	1915CC (1.9L) DH Volkswagen	1983-1985	13
1588CC (1.6L) CS Volkswagen Diesel	1982-1984	6	1970CC (2.0L) BHP/GD/GE Volkswagen	1976-1979	14
1588CC (1.6L) JK Volkswagen Diesel	1984	7	1970CC (2.0L) CV Volkswagen	1980-1983	15
1588CC (1.6L) EJ Volkswagen	1980	8	2109CC (2.1L) MV Volkswagen	1986-1991	16

LIGHT TRUCK

Model Index

Model	Engine	Year	Block	Model	Engine	Year	Block
Rabbit	1471CC (1.5L) CK Volkswagen Diesel	1980	2	Type 2 (Transporter)	1679CC (1.7L) CB Volkswagen	1972-1974	9
Rabbit	1588CC (1.6L) JK Volkswagen Diesel	1984	7	Type 2 (Transporter)	1795CC (1.8L) ED Volkswagen	1974-1975	12
Rabbit	1588CC (1.6L) CR Volkswagen Diesel	1981-1983	5	Type 2 (Transporter)	1970CC (2.0L) BHP/GD/GE Volkswagen	1976-1979	14
Rabbit	1588CC (1.6L) EJ Volkswagen	1980	8	Vanagon	1588CC (1.6L) CS Volkswagen Diesel	1982-1984	6
Rabbit	1715CC (1.7L) JF Volkswagen	1982	11	Vanagon	1915CC (1.9L) DH Volkswagen	1983-1985	13
Rabbit	1715CC (1.7L) EN Volkswagen	1981-1984	10	Vanagon	1970CC (2.0L) CV Volkswagen	1980-1983	15
Type 2 (Transporter)	1192CC (1.2L) 40 Horsepower Volkswagen	1960-1964	1	Vanagon	2109CC (2.1L) MV Volkswagen	1986-1991	16
Type 2 (Transporter)	1493CC (1.5L) 50 B.H.P./HO Volkswagen	1963-1967	3				
Type 2 (Transporter)	1584CC (1.6L) B Volkswagen	1968-1979	4				

1 1192CC (1.2L) 40 Horsepower Volkswagen 4 Cyl, 3.031in./77mm (1961-1964) 1

Part	Year	VIN	Model/Application	Part Number	Qty.
------	------	-----	-------------------	-------------	------

ENGINE GASKETS

Valve Cover Set	1961-1964			Cork Rubber	VS30003	1
Valve Stem Seal, Exh.	1961-1964				B45429	4
Valve Stem Seal, Int.	1961-1964				B45429	4
Rear Main Seal Set	1961-1964			Rubber	JV629	1

MISCELLANEOUS GASKETS

Carb. Mount Gasket	1961		1 Barrel Carburetor		G20102	1
Exhaust Pipe Gasket	1961-1964		(Ring Type 'C'), Muffler To Tailpipe		F7274	1
			(Flange Type), Pipe To Manifold		F14591	1
Oil Cooler Mount Grommet	1961-1964				H20095	1
Oil Cooler Sealing Kit	1961-1964				OS30099	1
Oil Strainer Gasket Set	1961-1964				OS20098	1
Push Rod Tube Seal	1961-1964				B45427	16

2 1471CC (1.5L) CK Volkswagen Diesel 4 Cyl, 3.012in./76.5mm (1980) 2

Part	Year	VIN	Model/Application	Part Number	Qty.
------	------	-----	-------------------	-------------	------

ENGINE GASKETS

Head Set	1980		(Head Gasket Not Included, Thickness Is Identified By Groove In Edge Of Gasket, Replacement Gasket Must Be Of Same Thickness As One Removed)		HS3664W	1
Full Set	1980		(Head Gasket Not Included, Thickness Is Identified By Groove In Edge Of Gasket, Replacement Gasket Must Be Of Same Thickness As One Removed)		FS3664W	1
Cylinder Head Gasket	1980		(3 Grooves)	1.4mm Thickness	3664	1
			(5 Grooves)	1.6mm Thickness	3665	1
			(4 Grooves)	1.5mm Thickness	3669	1
Valve Cover Set	1980		(Contains Valve Cover End Plug)	Cork Rubber	VS30024	1
			(Contains Valve Cover End Plug)	Tuff-Cork	VS30024TC	1
Valve Stem Seal, Exh.	1980			Teflon	B45423	4
				Fluoroelastomer	B45546	4
Valve Stem Seal, Int.	1980			Teflon	B45423	4
				Fluoroelastomer	B45546	4
Manifold Set, Exhaust	1980		To Be Replaced By MS12375		MS10030W	1
Manifold Set, Intake	1980				MS12278	1
Oil Pan Set	1980			Victo-Tech	OS20056	1
Rear Main Seal Set	1980				JV567	1
Timing Cover Set	1980				JV982	1

MISCELLANEOUS GASKETS

Camshaft Seal	1980				66960	1
Exhaust Pipe Gasket	1980		(Flange Type), Pipe To Manifold		F20331	1
Intermediate Shaft Set	1980				JV983	1
Water Outlet Gasket	1980			Victo-Tech	C20119	1

Volkswagen Truck

2 (cont.)	1471CC (1.5L) CK Volkswagen Diesel 4 Cyl, 3.012in./76.5mm (1980)					2 (cont.)
---------------------	---	--	--	--	--	---------------------

Part	Year	VIN	Model/Application	Part Number	Qty.
MISCELLANEOUS GASKETS (cont.)					
Water Pump Hsg. O-Ring	1980		(O-Ring Type), Pump To Block <i>Victo-Tech</i>	C20119	1
Water Pump Mount Gasket	1980			K20118	1

3	1493CC (1.5L) 50 B.H.P./HO Volkswagen 4 Cyl, 3.366in./85.5mm (1963-1967)					3
----------	---	--	--	--	--	----------

Part	Year	VIN	Model/Application	Part Number	Qty.
ENGINE GASKETS					
Full Set	1963-1967			FS3574	1
Valve Cover Set	1963-1967		<i>Cork Rubber</i>	VS30003	1
Valve Stem Seal, Exh.	1963-1967			B45429	4
Valve Stem Seal, Int.	1963-1967			B45429	4
Manifold Set, Exhaust	1963-1967			F14591	4
Manifold Set, Intake	1963-1967			MS10099	1
Rear Main Seal Set	1963-1967		<i>Rubber</i>	JV629	1

Part	Year	VIN	Model/Application	Part Number	Qty.
MISCELLANEOUS GASKETS					
Cylinder Base Gasket	1963-1967			3578	4
Exhaust Pipe Gasket	1963-1967		(Ring Type 'C'), Muffler To Tailpipe	F7274	1
			(Flange Type), Pipe To Manifold	F14591	1
Oil Cooler Mount Grommet	1963-1967			H20095	1
Oil Cooler Sealing Kit	1963-1967			OS30099	1
Oil Strainer Gasket Set	1963-1967			OS20098	1
Push Rod Tube Seal	1963-1967			B45427	16

4	1584CC (1.6L) B Volkswagen 4 Cyl, 3.366in./85.5mm (1968-1971)					4
----------	--	--	--	--	--	----------

Part	Year	VIN	Model/Application	Part Number	Qty.
ENGINE GASKETS					
Full Set	1968-1971			FS3574	1
Valve Cover Set	1968-1971		<i>Cork Rubber</i>	VS30003	1
Valve Stem Seal, Exh.	1968-1971			B45429	4
Valve Stem Seal, Int.	1968-1971			B45429	4
Manifold Set, Exhaust	1968-1971			F14591	4
Manifold Set, Intake	1968-1971			MS10099	1
Rear Main Seal Set	1968-1971		<i>Rubber</i>	JV629	1

Part	Year	VIN	Model/Application	Part Number	Qty.
MISCELLANEOUS GASKETS					
Cylinder Base Gasket	1968-1971			3578	4
E.G.R. Gasket	1968-1971			G20270	1
Exhaust Pipe Gasket	1968-1971		(Ring Type 'C'), Muffler To Tailpipe	F7274	1
			(Flange Type), Pipe To Manifold	F14591	1
Oil Cooler Mount Grommet	1971			B45793	4
	1968-1970			H20095	1
Oil Cooler Sealing Kit	1968-1971			OS30099	1
Oil Strainer Gasket Set	1968-1971			OS20098	1
Push Rod Tube Seal	1968-1971			B45427	16

5	1588CC (1.6L) CR Volkswagen Diesel 4 Cyl, 3.012in./76.5mm (1981-1983)					5
----------	--	--	--	--	--	----------

Part	Year	VIN	Model/Application	Part Number	Qty.
ENGINE GASKETS					
Head Set	1981-1983		(Head Gasket Not Included, Thickness Is Identified By Groove In Edge Of Gasket, Replacement Gasket Must Be Of Same Thickness As One Removed)	HS3664W	1

LIGHT TRUCK

5 (cont.)	1588CC (1.6L) CR Volkswagen Diesel 4 Cyl, 3.012in./76.5mm (1981-1983)				5 (cont.)
---------------------	--	--	--	--	---------------------

<i>Part</i>	<i>Year</i>	<i>VIN</i>	<i>Model/Application</i>	<i>Part Number</i>	<i>Qty.</i>
ENGINE GASKETS (cont.)					
Full Set	1981-1983		(Head Gasket Not Included, Thickness Is Identified By Groove In Edge Of Gasket, Replacement Gasket Must Be Of Same Thickness As One Removed)	FS3664W	1
Cylinder Head Gasket	1981-1983		11.5mm Head Bolt Diameter, (1 Groove) <i>1.4mm Thickness</i>	3728	1
			11.5mm Head Bolt Diameter, (2 Grooves) <i>1.5mm Thickness</i>	3729	1
			11.5mm Head Bolt Diameter, (3 Grooves) <i>1.6mm Thickness</i>	3730	1
			12.5mm Head Bolt Diameter, (2 Grooves) <i>1.5mm Thickness</i>	3765	1
			12.5mm Head Bolt Diameter, (3 Grooves) <i>1.6mm Thickness</i>	3766	1
			12.5mm Head Bolt Diameter, (1 Groove) <i>1.4mm Thickness</i>	5763	1
Valve Cover Set	1981-1983		(Contains Valve Cover End Plug) <i>Cork Rubber</i>	VS30024	1
			(Contains Valve Cover End Plug) <i>Tuff-Cork</i>	VS30024TC	1
Valve Stem Seal, Exh.	1981-1983		<i>Teflon</i>	B45423	4
			<i>Fluoroelastomer</i>	B45546	4
Valve Stem Seal, Int.	1981-1983		<i>Teflon</i>	B45423	4
			<i>Fluoroelastomer</i>	B45546	4
Manifold Set, Exhaust	1981-1983		To Be Replaced By MS12375	MS10030W	1
Manifold Set, Intake	1981-1983			MS12278	1
Oil Pan Set	1981-1983			<i>Victo-Tech</i> OS20056	1
Rear Main Seal Set	1981-1983			JV567	1
Timing Cover Set	1981-1983			JV982	1

MISCELLANEOUS GASKETS

Camshaft Seal	1981-1983			66960	1
Exhaust Pipe Gasket	1982-1983		(Flange Type), Pipe To Manifold	F7426	1
	1981		(Flange Type), Pipe To Manifold	F14604	1
Intermediate Shaft Set	1981-1983			JV983	1
Water Outlet Gasket	1981-1983			<i>Victo-Tech</i> C20119	1
Water Pump Hsg. O-Ring	1981-1983		(O-Ring Type), Pump To Block	<i>Victo-Tech</i> C20119	1
Water Pump Mount Gasket	1981-1983			K20118	1

6	1588CC (1.6L) CS Volkswagen Diesel 4 Cyl, 3.012in./76.5mm (1982-1984)				6
----------	--	--	--	--	----------

<i>Part</i>	<i>Year</i>	<i>VIN</i>	<i>Model/Application</i>	<i>Part Number</i>	<i>Qty.</i>
ENGINE GASKETS					
Head Set	1982-1984		(Head Gasket Not Included, Thickness Is Identified By Groove In Edge Of Gasket, Replacement Gasket Must Be Of Same Thickness As One Removed)	HS3664W	1
Full Set	1982-1984		(Head Gasket Not Included, Thickness Is Identified By Groove In Edge Of Gasket, Replacement Gasket Must Be Of Same Thickness As One Removed)	FS3664W	1
Cylinder Head Gasket	1982-1984		11.5mm Head Bolt Diameter, (1 Groove) <i>1.4mm Thickness</i>	3728	1
			11.5mm Head Bolt Diameter, (2 Grooves) <i>1.5mm Thickness</i>	3729	1
			11.5mm Head Bolt Diameter, (3 Grooves) <i>1.6mm Thickness</i>	3730	1
			12.5mm Head Bolt Diameter, (2 Grooves) <i>1.5mm Thickness</i>	3765	1
			12.5mm Head Bolt Diameter, (3 Grooves) <i>1.6mm Thickness</i>	3766	1
			12.5mm Head Bolt Diameter, (1 Groove) <i>1.4mm Thickness</i>	5763	1
Valve Cover Set	1982-1984		(Contains Valve Cover End Plug) <i>Cork Rubber</i>	VS30024	1
			(Contains Valve Cover End Plug) <i>Tuff-Cork</i>	VS30024TC	1
Valve Stem Seal, Exh.	1982-1984		<i>Teflon</i>	B45423	4
			<i>Fluoroelastomer</i>	B45546	4
Valve Stem Seal, Int.	1982-1984			<i>Teflon</i> B45423	4

Volkswagen Truck

6 (cont.)	1588CC (1.6L) CS Volkswagen Diesel 4 Cyl, 3.012in./76.5mm (1982-1984)				6 (cont.)
---------------------	--	--	--	--	---------------------

Part	Year	VIN	Model/Application	Part Number	Qty.
ENGINE GASKETS (cont.)					
Valve Stem Seal, Int. (cont.)	1982-1984		<i>Fluoroelastomer</i>	B45546	4
Manifold Set, Exhaust	1982-1984		To Be Replaced By MS12375	MS10030W	1
Manifold Set, Intake	1982-1984			MS12278	1
Oil Pan Set	1982-1984		<i>Victo-Tech</i>	OS20056	1
Rear Main Seal Set	1982-1984			JV567	1
Timing Cover Set	1982-1984			JV982	1

MISCELLANEOUS GASKETS					
Camshaft Seal	1982-1984			66960	1
Exhaust Pipe Gasket	1982-1984		(Flange Type), Pipe To Manifold	F7426	1
Intermediate Shaft Set	1982-1984			JV983	1
Water Outlet Gasket	1982-1984		<i>Victo-Tech</i>	C20119	1
Water Pump Hsg. O-Ring	1982-1984		(O-Ring Type), Pump To Block style="text-align: right;"> <i>Victo-Tech</i>	C20119	1
Water Pump Mount Gasket	1982-1984			K20118	1

7	1588CC (1.6L) JK Volkswagen Diesel 4 Cyl, 3.012in./76.5mm (1984)				7
----------	---	--	--	--	----------

Part	Year	VIN	Model/Application	Part Number	Qty.
ENGINE GASKETS					
Head Set	1984		(Head Gasket Not Included, Thickness Is Identified By Groove In Edge Of Gasket, Replacement Gasket Must Be Of Same Thickness As One Removed)	HS3664W	1
Full Set	1984		(Head Gasket Not Included, Thickness Is Identified By Groove In Edge Of Gasket, Replacement Gasket Must Be Of Same Thickness As One Removed)	FS3664W	1
Cylinder Head Gasket	1984		11.5mm Head Bolt Diameter, (1 Groove) <i>1.4mm Thickness</i>	3728	1
			11.5mm Head Bolt Diameter, (2 Grooves) <i>1.5mm Thickness</i>	3729	1
			11.5mm Head Bolt Diameter, (3 Grooves) <i>1.6mm Thickness</i>	3730	1
			12.5mm Head Bolt Diameter, (2 Grooves) <i>1.5mm Thickness</i>	3765	1
			12.5mm Head Bolt Diameter, (3 Grooves) <i>1.6mm Thickness</i>	3766	1
			12.5mm Head Bolt Diameter, (1 Groove) <i>1.4mm Thickness</i>	5763	1
			Valve Cover Set	1984	
			(Contains Valve Cover End Plug) <i>Tuff-Cork</i>	VS30024TC	1
Valve Stem Seal, Exh.	1984		Rabbit <i>Teflon</i>	B45423	4
			Rabbit <i>Fluoroelastomer</i>	B45546	4
Valve Stem Seal, Int.	1984		Rabbit <i>Teflon</i>	B45423	4
			Rabbit <i>Fluoroelastomer</i>	B45546	4
Manifold Set, Exhaust	1984		To Be Replaced By MS12375	MS10030W	1
Manifold Set, Intake	1984			MS12278	1
Oil Pan Set	1984		<i>Victo-Tech</i>	OS20056	1
Rear Main Seal Set	1984			JV567	1
Timing Cover Set	1984			JV982	1

MISCELLANEOUS GASKETS					
Camshaft Seal	1984		Rabbit	66960	1
Exhaust Pipe Gasket	1984		Rabbit, (Flange Type), Pipe To Manifold	F7426	1
Intermediate Shaft Set	1984		Rabbit	JV983	1
Water Outlet Gasket	1984		Rabbit <i>Victo-Tech</i>	C20119	1
Water Pump Hsg. O-Ring	1984		Rabbit, (O-Ring Type), Pump To Block style="text-align: right;"> <i>Victo-Tech</i>	C20119	1
Water Pump Mount Gasket	1984		Rabbit	K20118	1

LIGHT TRUCK

8 1588CC (1.6L) EJ Volkswagen 4 Cyl, 3.130in./79.5mm (1980) 8

Part	Year	VIN	Model/Application	Part Number	Qty.
ENGINE GASKETS					
Head Set	1980			HS3609	1
Full Set	1980			FS3609	1
Engine Kit Gasket Set	1980			95-3095VR	1
Cylinder Head Gasket	1980		VR2000	3609	1
Cyl. Head Spacer Shim	1980		Requires Sealing Compound		
				Steel 3609S	1
Sealing Compound	1980		(4 Ounce Brush Top Can)	JV66B	1
			(12 Ounce Spray Can)	JV66S	1
Valve Cover Set	1980		(Contains Valve Cover End Plug) Cork Rubber	VS30024	1
			(Contains Valve Cover End Plug) Tuff-Cork	VS30024TC	1
Valve Stem Seal, Exh.	1980		Rabbit Teflon	B45423	4
			Rabbit Fluoroelastomer	B45546	4
Valve Stem Seal, Int.	1980		Rabbit Teflon	B45423	4
			Rabbit Fluoroelastomer	B45546	4
Manifold Set, Exhaust	1980		To Be Replaced By MS12375	MS10030W	1
Manifold Set, Intake	1980			MS12278	1
Oil Pan Set	1980			Victo-Tech OS20056	1
Rear Main Seal Set	1980		Rabbit	JV644	1
Timing Cover Set	1980			JV982	1

MISCELLANEOUS GASKETS

Camshaft Seal	1980		Rabbit	66960	1
Exhaust Pipe Gasket	1980		Rabbit, (Flange Type), Pipe To Manifold	F14603	1
			Rabbit, (Flange Type), Center, Pipe To Manifold	F14604	1
Fuel Pump Gasket	1980		Rabbit	D24097	2
Intermediate Shaft Set	1980		Rabbit	JV983	1
Water Outlet Gasket	1980		Rabbit	Victo-Tech C20119	1
Water Pump Hsg. O-Ring	1980		Rabbit, (O-Ring Type), Pump To Block	Victo-Tech C20119	1
Water Pump Mount Gasket	1980		Rabbit	K20118	1

9 1679CC (1.7L) CB Volkswagen 4 Cyl, 3.543in./90mm (1972-1974) 9

Part	Year	VIN	Model/Application	Part Number	Qty.
ENGINE GASKETS					
Full Set	1972-1974		(Valve Stem Seals Not Included)	FS3579	1
Valve Cover Set	1972-1974			Cork Rubber VS30004	1
Valve Stem Seal, Exh.	1972-1974			B45429	4
Valve Stem Seal, Int.	1972-1974			B45429	4
Rear Main Seal	1972-1974			Rubber 66941	1
Timing Cover Set	1972-1974			JV631	1

MISCELLANEOUS GASKETS

E.G.R. Gasket	1972-1974			G20270	1
Exhaust Pipe Gasket	1972-1974		(Flange Type), Heat Exchanger To Muffler, Pipe To Manifold	F20331	2
Oil Cooler Mount Grommet	1972-1974			B45793	4
Oil Cooler Sealing Kit	1972-1974			OS30099	1
Oil Strainer Gasket Set	1972-1974			OS20100	1
Push Rod Tube Seal	1972-1974		21.3mm	B45430	16
			25.1mm	B45431	16

10 1715CC (1.7L) EN Volkswagen 4 Cyl, 3.130in./79.5mm (1981-1983) 10

Part	Year	VIN	Model/Application	Part Number	Qty.
ENGINE GASKETS					
Head Set	1981-1983			HS3609	1
Full Set	1981-1983			FS3609	1
Engine Kit Gasket Set	1981-1983			95-3095VR	1

Volkswagen Truck

10 (cont.)	1715CC (1.7L) EN Volkswagen 4 Cyl, 3.130in./79.5mm (1981-1983)					10 (cont.)
----------------------	---	--	--	--	--	----------------------

Part	Year	VIN	Model/Application	Part Number	Qty.
ENGINE GASKETS (cont.)					
Cylinder Head Gasket	1981-1983		VR2000	3609	1
Cyl. Head Spacer Shim	1981-1983		Requires Sealing Compound Steel	3609S	1
Sealing Compound	1981-1983		(4 Ounce Brush Top Can)	JV66B	1
			(12 Ounce Spray Can)	JV66S	1
Valve Cover Set	1981-1983		(Contains Valve Cover End Plug) Cork Rubber	VS30024	1
			(Contains Valve Cover End Plug) Tuff-Cork	VS30024TC	1
Valve Stem Seal, Exh.	1981-1983		Teflon	B45423	4
			Fluoroelastomer	B45546	4
Valve Stem Seal, Int.	1981-1983		Teflon	B45423	4
			Fluoroelastomer	B45546	4
Manifold Set, Exhaust	1981-1983		To Be Replaced By MS12375	MS10030W	1
Manifold Set, Intake	1981-1983			MS12278	1
Oil Pan Set	1981-1983		Victo-Tech	OS20056	1
Rear Main Seal Set	1981-1983			JV644	1
Timing Cover Set	1981-1983			JV982	1

MISCELLANEOUS GASKETS

Camshaft Seal	1981-1983			66960	1
Exhaust Pipe Gasket	1981-1983		(Flange Type), Pipe To Manifold	F14603	1
			(Flange Type), Pipe To Center	F14604	1
Fuel Pump Gasket	1981-1983			D24097	2
Intermediate Shaft Set	1981-1983			JV983	1
Water Outlet Gasket	1981-1983		Victo-Tech	C20119	1
Water Pump Hsg. O-Ring	1981-1983		(O-Ring Type), Pump To Block Victo-Tech	C20119	1
Water Pump Mount Gasket	1981-1983			K20118	1

11	1715CC (1.7L) JF Volkswagen 4 Cyl, 3.130in./79.5mm (1982)					11
-----------	--	--	--	--	--	-----------

Part	Year	VIN	Model/Application	Part Number	Qty.
ENGINE GASKETS					
Head Set	1982			HS3609	1
Full Set	1982			FS3609	1
Engine Kit Gasket Set	1982			95-3095VR	1
Cylinder Head Gasket	1982		VR2000	3609	1
Cyl. Head Spacer Shim	1982		Requires Sealing Compound Steel	3609S	1
Sealing Compound	1982		(4 Ounce Brush Top Can)	JV66B	1
			(12 Ounce Spray Can)	JV66S	1
Valve Cover Set	1982		(Contains Valve Cover End Plug) Cork Rubber	VS30024	1
			(Contains Valve Cover End Plug) Tuff-Cork	VS30024TC	1
Valve Stem Seal, Exh.	1982		Teflon	B45423	4
			Fluoroelastomer	B45546	4
Valve Stem Seal, Int.	1982		Teflon	B45423	4
			Fluoroelastomer	B45546	4
Manifold Set, Exhaust	1982		To Be Replaced By MS12375	MS10030W	1
Manifold Set, Intake	1982			MS12278	1
Oil Pan Set	1982		Victo-Tech	OS20056	1
Rear Main Seal Set	1982			JV644	1
Timing Cover Set	1982			JV982	1

MISCELLANEOUS GASKETS

Camshaft Seal	1982			66960	1
Exhaust Pipe Gasket	1982		(Flange Type), Pipe To Manifold	F14603	1
			(Flange Type), Pipe To Center	F14604	1
Fuel Pump Gasket	1982			D24097	2
Intermediate Shaft Set	1982			JV983	1

11	1715CC (1.7L) JF Volkswagen 4 Cyl, 3.130in./79.5mm (1982)	11
(cont.)		(cont.)

Part	Year	VIN	Model/Application	Part Number	Qty.
MISCELLANEOUS GASKETS (cont.)					
Water Outlet Gasket	1982		<i>Victo-Tech</i>	C20119	1
Water Pump Hsg. O-Ring	1982		(O-Ring Type), Pump To Block style="text-align:right;"> <i>Victo-Tech</i>	C20119	1
Water Pump Mount Gasket	1982			K20118	1

12	1795CC (1.8L) ED Volkswagen 4 Cyl, 3.661in./93mm (1974-1975)	12
-----------	---	-----------

Part	Year	VIN	Model/Application	Part Number	Qty.
ENGINE GASKETS					
Full Set	1974-1975		(Valve Stem Seals Not Included)	FS3575	1
Valve Cover Set	1974-1975		<i>Cork Rubber</i>	VS30004	1
Valve Stem Seal, Exh.	1974-1975			B45429	4
Valve Stem Seal, Int.	1974-1975			B45429	4
Manifold Gasket, Exh.	1974-1975		(Flange Type)	F14604	3
Rear Main Seal	1974-1975		<i>Rubber</i>	66941	1
Timing Cover Set	1974-1975			JV631	1

MISCELLANEOUS GASKETS					
E.G.R. Gasket	1974-1975			G20270	1
Exhaust Pipe Gasket	1974-1975		(Flange Type), Pipe To Manifold	F12327	1
			(Flange Type), Muffler To Tailpipe	F20327	1
			(Flange Type), Heat Exchanger To Muffler	F20331	1
Oil Cooler Mount Grommet	1974-1975			B45793	4
Oil Cooler Sealing Kit	1974-1975			OS30099	1
Oil Strainer Gasket Set	1974-1975			OS20100	1
Push Rod Tube Seal	1974-1975		21.3mm	B45430	16
			25.1mm	B45431	16

13	1915CC (1.9L) DH Volkswagen 4 Cyl, 3.701in./94mm (1983-1985)	13
-----------	---	-----------

Part	Year	VIN	Model/Application	Part Number	Qty.
ENGINE GASKETS					
Full Set	1983-1985		From Chassis Serial Number 24-0-062766	FS4835	1
Valve Cover Set	1983-1985		From Chassis Serial Number 24-0-062766 style="text-align:right;"> <i>Cork Rubber</i>	VS30003	1
Valve Stem Seal, Exh.	1983-1985		From Chassis Serial Number 24-0-062766 style="text-align:right;"> <i>Teflon</i>	B45423	4
			From Chassis Serial Number 24-0-062766 style="text-align:right;"> <i>Fluoroelastomer</i>	B45546	4
Valve Stem Seal, Int.	1983-1985		From Chassis Serial Number 24-0-062766 style="text-align:right;"> <i>Teflon</i>	B45423	4
			From Chassis Serial Number 24-0-062766 style="text-align:right;"> <i>Fluoroelastomer</i>	B45546	4
Rear Main Seal	1983-1985		From Chassis Serial Number 24-0-062766 style="text-align:right;"> <i>Rubber</i>	66941	1
Timing Cover Seal	1983-1985		From Chassis Serial Number 24-0-062766	66942	1

MISCELLANEOUS GASKETS					
Exhaust Pipe Gasket	1983-1985		From Chassis Serial Number 24-0-062766, (Flange Type), Pipe To Manifold	F20331	1
Push Rod Tube Seal	1983-1985		From Chassis Serial Number 24-0-062766, Top	B45427	8
			From Chassis Serial Number 24-0-062766, Bottom	B45542	8

14	1970CC (2.0L) BHP/GD/GE Volkswagen 4 Cyl, 3.701in./94mm (1976-1979)	14
-----------	--	-----------

Part	Year	VIN	Model/Application	Part Number	Qty.
ENGINE GASKETS					
Full Set	1976-1979		(Valve Stem Seals Not Included)	FS3575	1
Valve Cover Set	1976-1979		<i>Cork Rubber</i>	VS30004	1
Valve Stem Seal, Exh.	1976-1979			B45429	4
Valve Stem Seal, Int.	1976-1979			B45429	4

LIGHT TRUCK

Volkswagen Truck

14 <small>(cont.)</small>	1970CC (2.0L) BHP/GD/GE Volkswagen 4 Cyl, 3.701in./94mm (1976-1979)	14 <small>(cont.)</small>
-------------------------------------	--	-------------------------------------

Part	Year	VIN	Model/Application	Part Number	Qty.
------	------	-----	-------------------	-------------	------

ENGINE GASKETS (cont.)

Manifold Gasket, Exh.	1976-1979		(Flange Type)	F14604	3	
Rear Main Seal	1976-1979			<i>Rubber</i>	66941	1
Timing Cover Set	1976-1979			JV631	1	

MISCELLANEOUS GASKETS

E.G.R. Gasket	1976-1979			G20270	1
Exhaust Pipe Gasket	1976-1979		(Flange Type), Pipe To Manifold	F12327	1
			(Flange Type), Muffler To Tailpipe	F20327	1
			(Flange Type), Heat Exchanger To Muffler	F20331	1
Oil Cooler Mount Grommet	1976-1979			B45793	4
Oil Cooler Sealing Kit	1976-1977			OS30099	1
Oil Strainer Gasket Set	1976-1979			OS20100	1
Push Rod Tube Seal	1976-1979		21.3mm	B45430	16
			25.1mm	B45431	16

15	1970CC (2.0L) CV Volkswagen 4 Cyl, 3.701in./94mm (1980-1983)	15
-----------	---	-----------

Part	Year	VIN	Model/Application	Part Number	Qty.
------	------	-----	-------------------	-------------	------

ENGINE GASKETS

Full Set	1980-1983		Thru Chassis Serial Number 24-0-051580	FS4834	1	
Valve Cover Set	1980-1983		Thru Chassis Serial Number 24-0-051580	<i>Cork Rubber</i>	VS30004	1
Rear Main Seal	1980-1983		Thru Chassis Serial Number 24-0-051580	<i>Rubber</i>	66941	1
Timing Cover Set	1980-1983		Thru Chassis Serial Number 24-0-051580	JV631	1	

MISCELLANEOUS GASKETS

E.G.R. Gasket	1980-1982		Thru Chassis Serial Number 24-0-051580	G20270	1
Exhaust Pipe Gasket	1980-1983		Thru Chassis Serial Number 24-0-051580, (Flange Type), Pipe To Manifold	F20331	1
Oil Cooler Mount Grommet	1980-1983		Thru Chassis Serial Number 24-0-051580	B45793	4
Oil Strainer Gasket Set	1980-1981		Thru Chassis Serial Number 24-0-051580	OS20100	1

16	2109CC (2.1L) MV Volkswagen 4 Cyl, 3.701in./94mm (1986-1991)	16
-----------	---	-----------

Part	Year	VIN	Model/Application	Part Number	Qty.
------	------	-----	-------------------	-------------	------

ENGINE GASKETS

Full Set	1986-1991			FS4835	1	
Valve Cover Set	1986-1991			<i>Cork Rubber</i>	VS30003	1
Valve Stem Seal, Exh.	1986-1991			<i>Teflon</i>	B45423	4
				<i>Fluoroelastomer</i>	B45546	4
Valve Stem Seal, Int.	1986-1991			<i>Teflon</i>	B45423	4
				<i>Fluoroelastomer</i>	B45546	4
Rear Main Seal	1986-1991			<i>Rubber</i>	66941	1
Timing Cover Seal	1986-1991			66942	1	

MISCELLANEOUS GASKETS

Exhaust Pipe Gasket	1986-1991		(Flange Type), Pipe To Manifold	F20331	1
Push Rod Tube Seal	1986-1991		Top	B45427	8
			Bottom	B45542	8

LIGHT TRUCK

Engine Index

Engine	Year	Block
334 CID (5.5L) TD60 Volvo Diesel		1

Model Index

Model	Engine	Year	Block	Model	Engine	Year	Block
F611	334 CID (5.5L) TD60 Volvo Diesel		1	F614	334 CID (5.5L) TD60 Volvo Diesel		1
F613	334 CID (5.5L) TD60 Volvo Diesel		1				

1	334 CID (5.5L) TD60 Volvo Diesel 6 Cyl, 3.875in./98.4mm						1
----------	--	--	--	--	--	--	----------

Part	Year	VIN	Model/Application	Part Number	Qty.
------	------	-----	-------------------	-------------	------

ENGINE GASKETS

Head Set				HS3695	1
Full Set				FS3695	1

Winnebago

Engine Index

Engine	Year	Block
2068CC (2.1L) J8S Renault Diesel	1985-1989	1

Model Index

Model	Engine	Year	Block
Motor Home	2068CC (2.1L) J8S Renault Diesel	1984-1989	1

1	2068CC (2.1L) J8S Renault Diesel 4 Cyl, in./mm (1985-1989)						1
----------	---	--	--	--	--	--	----------

Part	Year	VIN	Model/Application	Part Number	Qty.
------	------	-----	-------------------	-------------	------

ENGINE GASKETS

Cylinder Head Gasket	1985-1989		Piston Stand Out Under .96mm, (Choice Of Thickness Will Depend On Piston Stand-Out From Cylinder Liner) <i>1.6mm Thickness</i>	5724	1
			Piston Stand Out From .96mm To 1.04mm <i>1.70mm Thickness</i>	5725	1
			Piston Stand Out Over 1.04mm <i>1.8mm Thickness</i>	5726	1
Valve Cover Set	1985-1989		<i>Cork Rubber</i>	VS50031	1
Oil Pan Set	1985-1989		<i>Cork Rubber</i>	OS32040	1
Timing Cover Seal	1985-1989			48063	1

Dodge Truck

Axle Shaft Gaskets

<i>Model & Application</i>	<i>Part No.</i>	<i>Qty.</i>	<i>Model & Application</i>	<i>Part No.</i>	<i>Qty.</i>
1 TON			RAM CB300		
Axle Shaft Gasket			Axle Shaft Gasket		
1941-1956, Rear Axle	J26288	4	1979-1980, 5500, 5800 Pound Axle, Screw Mount, Rear Axle	J26347	2
3/4 TON			1979-1980, Except 5500, 5800 Pound Axle, Rear Axle	J27966	2
Axle Shaft Gasket			RAM CB350		
1941-1956, Rear Axle	J26288	4	Axle Shaft Gasket		
A100			1981, 5500, 5800 Pound Axle, Screw Mount, Rear Axle	J26347	2
Axle Shaft Gasket			1981, Except 5500, 5800 Pound Axle, Rear Axle	J27966	2
1969-1970, Inner, Rear Axle	J27961	1	RAM D100		
1969-1970, Outer, Rear Axle	J27962	1	Axle Shaft Gasket		
DAKOTA			1981-1989, 5500, 5800 Pound Axle, Screw Mount, Rear Axle	J26347	2
Axle Shaft Gasket			1981-1989, Dana 60, 70 Axle, Except 5500, 5800 Pound Axle, Rear Axle	J27966	2
1989, 5500, 5800 Pound Axle, Screw Mount, Rear Axle	J26347	2	1969-1973, Inner, Rear Axle	J27961	1
1989, Dana 60, 70 Axle, Except 5500, 5800 Pound Axle, Rear Axle	J27966	2	1969-1973, Outer, Rear Axle	J27962	1
M300			RAM D150		
Axle Shaft Gasket			Axle Shaft Gasket		
1977-1980, Except 5500, 5800 Pound Axle, Rear Axle	J27966	2	1981-1990, 5500, 5800 Pound Axle, Screw Mount, Rear Axle	J26347	2
1976-1980, 5500, 5800 Pound Axle, Screw Mount, Rear Axle	J26347	2	1981-1990, Dana 60, 70 Axle, Except 5500, 5800 Pound Axle, Rear Axle	J27966	2
1976, 5500 Pound Axle, Stud Mount, Rear Axle	J27966	2	1969-1973, Inner, Rear Axle	J27961	1
1963-1968, Rear Axle	J26288	4	1969-1973, Outer, Rear Axle	J27962	1
MBH300			RAM D200		
Axle Shaft Gasket			Axle Shaft Gasket		
1974, Rear Axle	J27966	2	1979-1980, Except 5500, 5800 Pound Axle, Rear Axle	J27966	2
P200			1976-1980, 5500, 5800 Pound Axle, Screw Mount, Rear Axle	J26347	2
Axle Shaft Gasket			1976, 5500 Pound Axle, Stud Mount, Rear Axle	J27966	2
1972-1974, Rear Axle	J27966	2	1957-1968, Rear Axle	J26288	4
1961-1968, Rear Axle	J26288	4	RAM D250		
P300			Axle Shaft Gasket		
Axle Shaft Gasket			1981-1990, 5500, 5800 Pound Axle, Screw Mount, Rear Axle	J26347	2
1976-1977, 5500, 5800 Pound Axle, Screw Mount, Rear Axle	J26347	2	1981-1990, Except 5500, 5800 Pound Axle, Rear Axle	J27966	2
1976, 5500 Pound Axle, Stud Mount, Rear Axle	J27966	2	RAM D300		
1957-1968, Rear Axle	J26288	4	Axle Shaft Gasket		
POWER RAM W250			1979-1980, Except 5500, 5800 Pound Axle, Rear Axle	J27966	2
Axle Shaft Gasket			1976-1980, 5500, 5800 Pound Axle, Screw Mount, Rear Axle	J26347	2
1981-1988, 5500, 5800 Pound Axle, Screw Mount, Rear Axle	J26347	2	1976, 5500 Pound Axle, Stud Mount, Rear Axle	J27966	2
1981-1988, Except 5500, 5800 Pound Axle, Rear Axle	J27966	2	1961-1968, Rear Axle	J26288	4
POWER RAM W350			RAM D350		
Axle Shaft Gasket			Axle Shaft Gasket		
1981-1988, 5500, 5800 Pound Axle, Screw Mount, Rear Axle	J26347	2	1981-1990, 5500, 5800 Pound Axle, Screw Mount, Rear Axle	J26347	2
1981-1988, Except 5500, 5800 Pound Axle, Rear Axle	J27966	2	1981-1990, Except 5500, 5800 Pound Axle, Rear Axle	J27966	2
POWER WAGON			RAM MB300		
Axle Shaft Gasket			Axle Shaft Gasket		
1947-1957, Rear Axle	J26288	4	1979-1980, 5500, 5800 Pound Axle, Screw Mount, Rear Axle	J26347	2
RM300					
Axle Shaft Gasket					
1973-1974, Rear Axle	J27966	2			

LIGHT TRUCK

Axle Shaft Gaskets (cont.)

<i>Model & Application</i>	<i>Part No.</i>	<i>Qty.</i>	<i>Model & Application</i>	<i>Part No.</i>	<i>Qty.</i>
RAM MB300 (cont.)			RAM W100 (cont.)		
Axle Shaft Gasket (cont.)			Axle Shaft Gasket (cont.)		
1979-1980, Except 5500, 5800 Pound Axle, Rear Axle	J27966	2	1981-1989, Dana 60, 70 Axle, Except 5500, 5800 Pound Axle, Rear Axle	J27966	2
RAM MBH350			1969-1973, Inner, Rear Axle	J27961	1
Axle Shaft Gasket			1969-1973, Outer, Rear Axle	J27962	1
1981, 5500, 5800 Pound Axle, Screw Mount, Rear Axle	J26347	2	RAM W150		
1981, Except 5500, 5800 Pound Axle, Rear Axle	J27966	2	Axle Shaft Gasket		
RAM MBL300			1981-1990, 5500, 5800 Pound Axle, Screw Mount, Rear Axle	J26347	2
Axle Shaft Gasket			1981-1990, Dana 60, 70 Axle, Except 5500, 5800 Pound Axle, Rear Axle	J27966	2
1976-1978, 5500, 5800 Pound Axle, Screw Mount, Rear Axle	J26347	2	RAM W200		
1976, 5500 Pound Axle, Stud Mount, Rear Axle	J27966	2	Axle Shaft Gasket		
RAM MBL350			1979-1980, Except 5500, 5800 Pound Axle, Rear Axle	J27966	2
Axle Shaft Gasket			1976-1980, 5500, 5800 Pound Axle, Screw Mount, Rear Axle	J26347	2
1981, 5500, 5800 Pound Axle, Screw Mount, Rear Axle	J26347	2	1976, 5500 Pound Axle, Stud Mount, Rear Axle	J27966	2
1981, Except 5500, 5800 Pound Axle, Rear Axle	J27966	2	1957-1968, Rear Axle	J26288	4
RAM RD200			RAM W250		
Axle Shaft Gasket			Axle Shaft Gasket		
1976-1978, 5500, 5800 Pound Axle, Screw Mount, Rear Axle	J26347	2	1983-1990, 5500, 5800 Pound Axle, Screw Mount, Rear Axle	J26347	2
1976, 5500 Pound Axle, Stud Mount, Rear Axle	J27966	2	1983-1990, Except 5500, 5800 Pound Axle, Rear Axle	J27966	2
RAM VAN B100			RAM W300		
Axle Shaft Gasket			Axle Shaft Gasket		
1972-1973, Inner, Rear Axle	J27961	1	1979-1980, Except 5500, 5800 Pound Axle, Rear Axle	J27966	2
1972-1973, Outer, Rear Axle	J27962	1	1976-1980, 5500, 5800 Pound Axle, Screw Mount, Rear Axle	J26347	2
RAM VAN B150			1976, 5500 Pound Axle, Stud Mount, Rear Axle	J27966	2
Axle Shaft Gasket			1957-1968, Rear Axle	J26288	4
1981-1990, 5500, 5800 Pound Axle, Screw Mount, Rear Axle	J26347	2	RAM W350		
RAM VAN B200			Axle Shaft Gasket		
Axle Shaft Gasket			1983-1990, 5500, 5800 Pound Axle, Screw Mount, Rear Axle	J26347	2
1976-1980, 5500, 5800 Pound Axle, Screw Mount, Rear Axle	J26347	2	1983-1990, Except 5500, 5800 Pound Axle, Rear Axle	J27966	2
RAM VAN B250			RAM WAGON B100		
Axle Shaft Gasket			Axle Shaft Gasket		
1981-1990, 5500, 5800 Pound Axle, Screw Mount, Rear Axle	J26347	2	1971, Inner, Rear Axle	J27961	1
RAM VAN B300			1971, Outer, Rear Axle	J27962	1
Axle Shaft Gasket			RAM WAGON B150		
1976-1980, 5500, 5800 Pound Axle, Screw Mount, Rear Axle	J26347	2	Axle Shaft Gasket		
RAM VAN B350			1981-1990, 5500, 5800 Pound Axle, Screw Mount, Rear Axle	J26347	2
Axle Shaft Gasket			RAM WAGON B200		
1981-1990, 5500, 5800 Pound Axle, Screw Mount, Rear Axle	J26347	2	Axle Shaft Gasket		
RAM W100			1976-1980, 5500, 5800 Pound Axle, Screw Mount, Rear Axle	J26347	2
Axle Shaft Gasket			RAM WAGON B250		
1981-1989, 5500, 5800 Pound Axle, Screw Mount, Rear Axle	J26347	2	Axle Shaft Gasket		
			1981-1990, 5500, 5800 Pound Axle, Screw Mount, Rear Axle	J26347	2

Dodge Truck (cont.)

Axle Shaft Gaskets (cont.)

<i>Model & Application</i>	<i>Part No.</i>	<i>Qty.</i>	<i>Model & Application</i>	<i>Part No.</i>	<i>Qty.</i>
RAM WAGON B300			SPORTSMAN WAGON B350		
Axle Shaft Gasket			Axle Shaft Gasket		
1976-1980, 5500, 5800 Pound Axle, Screw Mount, Rear Axle	J26347	2	1981, 5500, 5800 Pound Axle, Screw Mount, Rear Axle	J26347	2
RAM WAGON B350			VOYAGER PB200		
Axle Shaft Gasket			Axle Shaft Gasket		
1982-1990, 5500, 5800 Pound Axle, Screw Mount, Rear Axle	J26347	2	1979-1980, Except 5500, 5800 Pound Axle, Rear Axle	J27966	2
RAMCHARGER AD100			1976-1980, 5500, 5800 Pound Axle, Screw Mount, Rear Axle		
Axle Shaft Gasket			J26347 2		
1988, 5500, 5800 Pound Axle, Screw Mount, Rear Axle	J26347	2	1976, 5500 Pound Axle, Stud Mount, Rear Axle		
1988, Dana 60, 70 Axle, Except 5500, 5800 Pound Axle, Rear Axle	J27966	2	J27966 2		
RAMCHARGER AD150			VOYAGER PB250		
Axle Shaft Gasket			Axle Shaft Gasket		
1984-1990, 5500, 5800 Pound Axle, Screw Mount, Rear Axle	J26347	2	1981-1983, 5500, 5800 Pound Axle, Screw Mount, Rear Axle		
1984-1990, Dana 60, 70 Axle, Except 5500, 5800 Pound Axle, Rear Axle	J27966	2	1981-1983, Except 5500, 5800 Pound Axle, Rear Axle		
RAMCHARGER AW100			J27966 2		
Axle Shaft Gasket			VOYAGER PB300		
1988, 5500, 5800 Pound Axle, Screw Mount, Rear Axle	J26347	2	Axle Shaft Gasket		
1988, Dana 60, 70 Axle, Except 5500, 5800 Pound Axle, Rear Axle	J27966	2	1979-1980, Except 5500, 5800 Pound Axle, Rear Axle		
RAMCHARGER AW150			J27966 2		
Axle Shaft Gasket			VOYAGER PB350		
1984-1990, 5500, 5800 Pound Axle, Screw Mount, Rear Axle	J26347	2	Axle Shaft Gasket		
1984-1990, Dana 60, 70 Axle, Except 5500, 5800 Pound Axle, Rear Axle	J27966	2	1981-1983, 5500, 5800 Pound Axle, Screw Mount, Rear Axle		
SPORTSMAN WAGON B150			J27966 2		
Axle Shaft Gasket			W300M		
1981, 5500, 5800 Pound Axle, Screw Mount, Rear Axle	J26347	2	Axle Shaft Gasket		
SPORTSMAN WAGON B250			1958-1959, Rear Axle		
Axle Shaft Gasket			J26288 4		
1981, 5500, 5800 Pound Axle, Screw Mount, Rear Axle	J26347	2	WM300		
SPORTSMAN WAGON B250			Axle Shaft Gasket		
Axle Shaft Gasket			1960-1968, Rear Axle		
1981, 5500, 5800 Pound Axle, Screw Mount, Rear Axle	J26347	2	J26288 4		

Differential Housing Cover Gaskets

<i>Model & Application</i>	<i>Part No.</i>	<i>Qty.</i>	<i>Model & Application</i>	<i>Part No.</i>	<i>Qty.</i>
A100			DAKOTA (cont.)		
Axle Hsg Cover Gasket			Axle Hsg Cover Gasket (cont.)		
1969-1970, 8-3/8" Ring Gear, Rear Axle	P18564	1	1989, 9-1/4" Ring Gear, Rear Axle, Tuff-Cork		
1969-1970, 8-3/8" Ring Gear, Rear Axle, Tuff-Cork	P18564TC	1	1989, Dana 60, 70 Axle, Rear Axle		
1963-1968, Rear Axle	P18562	1	1989, Dana 60, 70 Axle, Rear Axle, Tuff-Cork		
1963-1968, Rear Axle, Tuff-Cork	P18562TC	1	1987-1988, 7-1/4" Ring Gear, Rear Axle		
ARROW			Diff. Carrier Gasket		
Diff. Carrier Gasket			1987-1990, 7-1/4" Ring Gear, Chrysler Axle, Front Axle		
1979-1982, Rear Axle	P27682	1	P38157 1		
DAKOTA			M300		
Axle Hsg Cover Gasket			Axle Hsg Cover Gasket		
1989, 9-1/4" Ring Gear, Rear Axle	P29352	1	1975-1980, 8-3/8" Ring Gear, Rear Axle		
			P18564 1		

LIGHT TRUCK

Differential Housing Cover Gaskets (cont.)

Model & Application	Part No.	Qty.	Model & Application	Part No.	Qty.
M300 (cont.)			P200 (cont.)		
Axle Hsg Cover Gasket (cont.)			Diff. Carrier Gasket (cont.)		
1975-1980, 8-3/8" Ring Gear, Rear Axle, Tuff-Cork	P18564TC	1	1969-1971, 8-3/4" Ring Gear, Rear Axle, Tuff-Cork	P27930TC	1
1975-1980, 9-1/4" Ring Gear, Rear Axle	P29352	1	P300		
1975-1980, 9-1/4" Ring Gear, Rear Axle, Tuff-Cork	P29352TC	1	Axle Hsg Cover Gasket		
1975-1980, Dana 60, 70 Axle, Rear Axle	P18562	1	1969-1977, 8-3/8" Ring Gear, Rear Axle	P18564	1
1975-1980, Dana 60, 70 Axle, Rear Axle, Tuff-Cork	P18562TC	1	1969-1977, 8-3/8" Ring Gear, Rear Axle, Tuff-Cork	P18564TC	1
1969-1972, 8-3/8" Ring Gear, Rear Axle	P18564	1	1969-1977, 9-1/4" Ring Gear, Rear Axle	P29352	1
1969-1972, 8-3/8" Ring Gear, Rear Axle, Tuff-Cork	P18564TC	1	1969-1977, 9-1/4" Ring Gear, Rear Axle, Tuff-Cork	P29352TC	1
1969-1972, 9-1/4" Ring Gear, Rear Axle	P29352	1	1969-1977, Dana 60, 70 Axle, Rear Axle	P18562	1
1969-1972, 9-1/4" Ring Gear, Rear Axle, Tuff-Cork	P29352TC	1	1969-1977, Dana 60, 70 Axle, Rear Axle, Tuff-Cork	P18562TC	1
1969-1972, Dana 60, 70 Axle, Rear Axle	P18562	1	Diff. Carrier Gasket		
Diff. Carrier Gasket			1969-1977, 8-3/4" Ring Gear, Rear Axle		
1975-1977, 8-3/4" Ring Gear, Rear Axle	P27930	1	1969-1977, 8-3/4" Ring Gear, Rear Axle, Tuff-Cork	P27930TC	1
1975-1977, 8-3/4" Ring Gear, Rear Axle, Tuff-Cork	P27930TC	1	POWER RAM 50		
1969-1972, 8-3/4" Ring Gear, Rear Axle	P27930	1	Diff. Carrier Gasket		
1969-1972, 8-3/4" Ring Gear, Rear Axle, Tuff-Cork	P27930TC	1	1986-1990, Front Axle		
MBH300			1986, Rear Axle		
Axle Hsg Cover Gasket			1982-1983, Rear Axle		
1974, 8-3/8" Ring Gear, Rear Axle	P18564	1	1982-1983, Front Axle		
1974, 8-3/8" Ring Gear, Rear Axle, Tuff-Cork	P18564TC	1	POWER RAM W250		
1974, 9-1/4" Ring Gear, Rear Axle	P29352	1	Axle Hsg Cover Gasket		
1974, 9-1/4" Ring Gear, Rear Axle, Tuff-Cork	P29352TC	1	1986-1988, Dana 44 Axle, Front Axle		
1974, Dana 60, 70 Axle, Rear Axle	P18562	1	1986-1988, Dana 44 Axle, 10 Bolt Holes, Front Axle, Tuff-Cork		
1974, Dana 60, 70 Axle, Rear Axle, Tuff-Cork	P18562TC	1	1986-1988, Dana 60, 70 Axle, Rear Axle, Tuff-Cork		
Diff. Carrier Gasket			1984-1988, Dana 60 Axle, Tuff-Cork		
1974, 8-3/4" Ring Gear, Rear Axle	P27930	1	1981-1988, 8-1/4" Ring Gear, 8-3/8" Ring Gear, Rear Axle		
1974, 8-3/4" Ring Gear, Rear Axle, Tuff-Cork	P27930TC	1	1981-1988, 8-1/4" Ring Gear, 8-3/8" Ring Gear, Rear Axle, Tuff-Cork		
P100			1981-1988, 9-1/4" Ring Gear, Rear Axle		
Axle Hsg Cover Gasket			1981-1988, 9-1/4" Ring Gear, Rear Axle, Tuff-Cork		
1963-1965, Rear Axle	P18562	1	1981-1988, Dana 60 Axle, Front Axle		
1963-1965, Rear Axle, Tuff-Cork	P18562TC	1	1981-1984, 3500, 3850, 4000 Pound Axle, Front Axle		
Diff. Carrier Gasket			1981-1984, 3500, 3850, 4000 Pound Axle, 10 Bolt Holes, Front Axle, Tuff-Cork		
1963-1965, 8-3/4" Ring Gear, Rear Axle	P27930	1	1981-1983, Dana 60, 70 Axle, Rear Axle, Tuff-Cork		
1963-1965, 8-3/4" Ring Gear, Rear Axle, Tuff-Cork	P27930TC	1	POWER RAM W350		
P200			Axle Hsg Cover Gasket		
Axle Hsg Cover Gasket			1982-1988, 8-3/8" Ring Gear, Rear Axle		
1972-1974, 8-3/8" Ring Gear, Rear Axle	P18564	1	1982-1988, 8-3/8" Ring Gear, Rear Axle, Tuff-Cork		
1972-1974, 8-3/8" Ring Gear, Rear Axle, Tuff-Cork	P18564TC	1	1981-1988, Front Axle		
1972-1974, 9-1/4" Ring Gear, Rear Axle	P29352	1	1981-1988, Front Axle, Tuff-Cork		
1972-1974, 9-1/4" Ring Gear, Rear Axle, Tuff-Cork	P29352TC	1	1981-1983, 9-1/4" Ring Gear, Rear Axle		
1972-1974, Dana 60 Axle, Rear Axle	P18562	1	1981-1983, 9-1/4" Ring Gear, Rear Axle, Tuff-Cork		
1972-1974, Dana 60 Axle, Rear Axle, Tuff-Cork	P18562TC	1	RM300		
1969-1971, Dana 60, 70 Axle, Rear Axle	P18562	1	Axle Hsg Cover Gasket		
1969-1971, Dana 60, 70 Axle, Rear Axle, Tuff-Cork	P18562TC	1	1973-1974, 8-3/8" Ring Gear, Rear Axle, Tuff-Cork		
1963-1968, Rear Axle	P18562	1	1973-1974, 9-1/4" Ring Gear, Rear Axle		
1963-1968, Rear Axle, Tuff-Cork	P18562TC	1	1973-1974, 9-1/4" Ring Gear, Rear Axle, Tuff-Cork		
Diff. Carrier Gasket			1969-1971, 8-3/4" Ring Gear		
1969-1971, 8-3/4" Ring Gear	P27930	1			

Dodge Truck (cont.)

Differential Housing Cover Gaskets (cont.)

<i>Model & Application</i>	<i>Part No.</i>	<i>Qty.</i>	<i>Model & Application</i>	<i>Part No.</i>	<i>Qty.</i>
RM300 (cont.)			RAM CB350		
Axle Hsg Cover Gasket (cont.)			Axle Hsg Cover Gasket		
1973-1974, Dana 60, 70 Axle, Rear Axle	P18562	1	1981, 9-1/4" Ring Gear, Rear Axle	P29352	1
1973-1974, Dana 60, 70 Axle, Rear Axle, Tuff-Cork	P18562TC	1	1981, 9-1/4" Ring Gear, Rear Axle, Tuff-Cork	P29352TC	1
Diff. Carrier Gasket			1981, Dana 60, 70 Axle, Rear Axle		
1973-1974, 8-3/4" Ring Gear, Rear Axle	P27930	1	1981, Dana 60, 70 Axle, Rear Axle, Tuff-Cork	P18562TC	1
1973-1974, 8-3/4" Ring Gear, Rear Axle, Tuff-Cork	P27930TC	1			
RAIDER			RAM D100		
Diff. Carrier Gasket			Axle Hsg Cover Gasket		
1987-1989, Front Axle	P38147	1	1978-1989, Dana 60, 70 Axle, Rear Axle	P18562	1
			1978-1989, Dana 60, 70 Axle, Rear Axle, Tuff-Cork	P18562TC	1
RAM 1500			1974-1989, 9-1/4" Ring Gear, Rear Axle		
Axle Hsg Cover Gasket			1974-1989, 9-1/4" Ring Gear, Rear Axle, Tuff-Cork		
1994-1996, Dana 44 Axle, Front Axle	P27768T	1	P29352TC		
1994-1996, Dana 44 Axle, 10 Bolt Holes, Front Axle, Tuff-Cork	P27768TC	1	1969-1977, 8-3/8" Ring Gear, Rear Axle		
			P18564		
			1969-1977, 8-3/8" Ring Gear, Rear Axle, Tuff-Cork		
			P18564TC		
			1963-1968, Rear Axle		
			P18562		
			1963-1968, Rear Axle, Tuff-Cork		
			P18562TC		
			Diff. Carrier Gasket		
			1963-1977, 8-3/4" Ring Gear, Rear Axle		
			1963-1977, 8-3/4" Ring Gear, Rear Axle, Tuff-Cork		
			P27930		
			P27930TC		
RAM 2500			RAM D150		
Axle Hsg Cover Gasket			Axle Hsg Cover Gasket		
1994-1996, Dana 44 Axle, Front Axle	P27768T	1	1978-1990, 8-1/4" Ring Gear, 8-3/8" Ring Gear, Rear Axle	P18564	1
1994-1996, Dana 44 Axle, 10 Bolt Holes, Front Axle, Tuff-Cork	P27768TC	1	1978-1990, 8-1/4" Ring Gear, 8-3/8" Ring Gear, Rear Axle, Tuff-Cork	P18564TC	1
			1978-1990, Dana 60, 70 Axle, Rear Axle		
			P18562		
			1978-1990, Dana 60, 70 Axle, Rear Axle, Tuff-Cork		
			P18562TC		
			1974-1990, 9-1/4" Ring Gear, Rear Axle		
			P29352		
			1974-1990, 9-1/4" Ring Gear, Rear Axle, Tuff-Cork		
			P29352TC		
			1974-1977, 8-3/8" Ring Gear, Rear Axle		
			P18564		
			1974-1977, 8-3/8" Ring Gear, Rear Axle, Tuff-Cork		
			P18564TC		
			Diff. Carrier Gasket		
			1974-1977, 8-3/4" Ring Gear, Rear Axle		
			1974-1977, 8-3/4" Ring Gear, Rear Axle, Tuff-Cork		
			P27930		
			P27930TC		
RAM 2500HD			RAM D200		
Axle Hsg Cover Gasket			Axle Hsg Cover Gasket		
1994-1996, Dana 60 Axle, Front Axle	P18562	1	1972-1977, 8-3/8" Ring Gear, Rear Axle	P18564	1
1994-1996, Dana 60 Axle, Front Axle, Tuff-Cork	P18562TC	1	1972-1977, 8-3/8" Ring Gear, Rear Axle, Tuff-Cork	P18564TC	1
			1972-1977, 9-1/4" Ring Gear, Rear Axle		
			P29352		
			1972-1977, 9-1/4" Ring Gear, Rear Axle, Tuff-Cork		
			P29352TC		
			1969-1980, Dana 60, 70 Axle, Rear Axle, Tuff-Cork		
			P18562TC		
			1969-1971, Dana 60, 70 Axle, Rear Axle		
			P18562		
			1963-1968, Rear Axle		
			P18562		
			1963-1968, Rear Axle, Tuff-Cork		
			P18562TC		
			Diff. Carrier Gasket		
			1969-1971, 8-3/4" Ring Gear, Rear Axle		
			1969-1971, 8-3/4" Ring Gear, Rear Axle, Tuff-Cork		
			P27930		
			P27930TC		
RAM 3500					
Axle Hsg Cover Gasket					
1994-1996, Dana 60 Axle, Front Axle	P18562	1			
1994-1996, Dana 60 Axle, Front Axle, Tuff-Cork	P18562TC	1			
RAM 50					
Diff. Carrier Gasket					
1982-1986, Rear Axle	P27682	1			
RAM CB300					
Axle Hsg Cover Gasket					
1979-1980, 8-3/8" Ring Gear, Rear Axle	P18564	1			
1979-1980, 8-3/8" Ring Gear, Rear Axle, Tuff-Cork	P18564TC	1			
1979-1980, 9-1/4" Ring Gear, Rear Axle	P29352	1			
1979-1980, 9-1/4" Ring Gear, Rear Axle, Tuff-Cork	P29352TC	1			
1979-1980, Dana 60, 70 Axle, Rear Axle	P18562	1			
1979-1980, Dana 60, 70 Axle, Rear Axle, Tuff-Cork	P18562TC	1			
1972-1973, 8-3/8" Ring Gear, Rear Axle	P18564	1			
1972-1973, 8-3/8" Ring Gear, Rear Axle, Tuff-Cork	P18564TC	1			
1972-1973, 9-1/4" Ring Gear, Rear Axle	P29352	1			
1972-1973, 9-1/4" Ring Gear, Rear Axle, Tuff-Cork	P29352TC	1			
1972-1973, Dana 60, 70 Axle, Rear Axle	P18562	1			
1972-1973, Dana 60, 70 Axle, Rear Axle, Tuff-Cork	P18562TC	1			
Diff. Carrier Gasket					
1972-1973, 8-3/4" Ring Gear, Rear Axle	P27930	1			
1972-1973, 8-3/4" Ring Gear, Rear Axle, Tuff-Cork	P27930TC	1			

LIGHT TRUCK

Differential Housing Cover Gaskets (cont.)

Model & Application	Part No.	Qty.	Model & Application	Part No.	Qty.
RAM D250			RAM MBL300		
Axle Hsg Cover Gasket			Axle Hsg Cover Gasket		
1981-1990, 8-1/4" Ring Gear, 8-3/8" Ring Gear, Rear Axle	P18564	1	1974-1978, 8-3/8" Ring Gear, Rear Axle	P18564	1
1981-1990, 8-1/4" Ring Gear, 8-3/8" Ring Gear, Rear Axle, Tuff-Cork	P18564TC	1	1974-1978, 8-3/8" Ring Gear, Rear Axle, Tuff-Cork	P18564TC	1
1981-1990, 9-1/4" Ring Gear, Rear Axle	P29352	1	1974-1978, 9-1/4" Ring Gear, Rear Axle	P29352	1
1981-1990, 9-1/4" Ring Gear, Rear Axle, Tuff-Cork	P29352TC	1	1974-1978, 9-1/4" Ring Gear, Rear Axle, Tuff-Cork	P29352TC	1
1981-1990, Dana 60, 70 Axle, Rear Axle	P18562	1	1974-1978, Dana 60, 70 Axle, Rear Axle	P18562	1
1981-1990, Dana 60, 70 Axle, Rear Axle, Tuff-Cork	P18562TC	1	1974-1978, Dana 60, 70 Axle, Rear Axle, Tuff-Cork	P18562TC	1
RAM D300			Diff. Carrier Gasket		
Axle Hsg Cover Gasket			1974-1977, 8-3/4" Ring Gear, Rear Axle		
1969-1980, Dana 60, 70 Axle, Rear Axle	P18562	1	1974-1977, 8-3/4" Ring Gear, Rear Axle, Tuff-Cork	P27930TC	1
1969-1980, Dana 60, 70 Axle, Rear Axle, Tuff-Cork	P18562TC	1	RAM MBL350		
1969-1978, 8-3/8" Ring Gear, Rear Axle	P18564	1	Axle Hsg Cover Gasket		
1969-1978, 8-3/8" Ring Gear, Rear Axle, Tuff-Cork	P18564TC	1	1981, 9-1/4" Ring Gear, Rear Axle		
1969-1978, 9-1/4" Ring Gear, Rear Axle	P29352	1	1981, 9-1/4" Ring Gear, Rear Axle, Tuff-Cork		
1969-1978, 9-1/4" Ring Gear, Rear Axle, Tuff-Cork	P29352TC	1	1981, Dana 60, 70 Axle, Rear Axle		
Diff. Carrier Gasket			1981, Dana 60, 70 Axle, Rear Axle, Tuff-Cork		
1969-1977, 8-3/4" Ring Gear, Rear Axle	P27930	1 P18562TC 1		
1969-1977, 8-3/4" Ring Gear, Rear Axle, Tuff-Cork	P27930TC	1	RAM RD200		
RAM D350			Axle Hsg Cover Gasket		
Axle Hsg Cover Gasket			1978, Dana 60, 70 Axle, Rear Axle, Tuff-Cork		
1981-1990, 8-3/8" Ring Gear, Rear Axle	P18564	1 P18562TC 1		
1981-1990, 8-3/8" Ring Gear, Rear Axle, Tuff-Cork	P18564TC	1	1974-1977, 8-3/8" Ring Gear, Rear Axle		
1981-1990, 9-1/4" Ring Gear, Rear Axle	P29352	1 P18564 1		
1981-1990, 9-1/4" Ring Gear, Rear Axle, Tuff-Cork	P29352TC	1	1974-1977, 8-3/8" Ring Gear, Rear Axle, Tuff-Cork		
1981-1990, Dana 60, 70 Axle, Rear Axle	P18562	1 P18564TC 1		
1981-1990, Dana 60, 70 Axle, Rear Axle, Tuff-Cork	P18562TC	1	1974-1977, 9-1/4" Ring Gear, Rear Axle		
RAM D50		 P29352 1		
Diff. Carrier Gasket			1974-1977, 9-1/4" Ring Gear, Rear Axle, Tuff-Cork		
1979-1981, Rear Axle	P27682	1 P29352TC 1		
RAM MB300			1974-1977, Dana 60 Axle, Rear Axle		
Axle Hsg Cover Gasket		 P18562 1		
1979-1980, 8-3/8" Ring Gear, Rear Axle	P18564	1	1974-1977, Dana 60 Axle, Rear Axle, Tuff-Cork		
1979-1980, 8-3/8" Ring Gear, Rear Axle, Tuff-Cork	P18564TC	1 P18562TC 1		
1979-1980, 9-1/4" Ring Gear, Rear Axle	P29352	1	RAM VAN B100		
1979-1980, 9-1/4" Ring Gear, Rear Axle, Tuff-Cork	P29352TC	1	Axle Hsg Cover Gasket		
1979-1980, Dana 60, 70 Axle, Rear Axle	P18562	1	1974-1980, 9-1/4" Ring Gear, Rear Axle		
1979-1980, Dana 60, 70 Axle, Rear Axle, Tuff-Cork	P18562TC	1 P29352 1		
RAM MBH350			1974-1980, 9-1/4" Ring Gear, Rear Axle, Tuff-Cork		
Axle Hsg Cover Gasket		 P29352TC 1		
1981, 9-1/4" Ring Gear, Rear Axle	P29352	1	1972-1977, 8-3/8" Ring Gear, Rear Axle		
1981, 9-1/4" Ring Gear, Rear Axle, Tuff-Cork	P29352TC	1 P18564 1		
1981, Dana 60, 70 Axle, Rear Axle	P18562	1	1972-1977, 8-3/8" Ring Gear, Rear Axle, Tuff-Cork		
1981, Dana 60, 70 Axle, Rear Axle, Tuff-Cork	P18562TC	1 P18564TC 1		
RAM VAN B150			Diff. Carrier Gasket		
Axle Hsg Cover Gasket			1972-1977, 8-3/4" Ring Gear, Rear Axle		
1981-1990, 8-1/4" Ring Gear, 8-3/8" Ring Gear, Rear Axle	P18564	1	1972-1977, 8-3/4" Ring Gear, Rear Axle, Tuff-Cork		
1981-1990, 8-1/4" Ring Gear, 8-3/8" Ring Gear, Rear Axle, Tuff-Cork	P18564TC	1 P27930TC 1		
1981-1990, 9-1/4" Ring Gear, Rear Axle	P29352	1	RAM VAN B200		
1981-1990, 9-1/4" Ring Gear, Rear Axle, Tuff-Cork	P29352TC	1	Axle Hsg Cover Gasket		
RAM VAN B200			1972-1977, 9-1/4" Ring Gear, Rear Axle		
Axle Hsg Cover Gasket		 P29352 1		
1972-1977, 9-1/4" Ring Gear, Rear Axle, Tuff-Cork	P29352TC	1	1972-1977, 9-1/4" Ring Gear, Rear Axle, Tuff-Cork		
1971, 8-3/8" Ring Gear, Rear Axle	P18564	1 P29352TC 1		

Dodge Truck (cont.)

Differential Housing Cover Gaskets (cont.)

<i>Model & Application</i>	<i>Part No.</i>	<i>Qty.</i>	<i>Model & Application</i>	<i>Part No.</i>	<i>Qty.</i>
RAM VAN B200 (cont.)			RAM W100 (cont.)		
Axle Hsg Cover Gasket (cont.)			Diff. Carrier Gasket (cont.)		
1971, 8-3/8" Ring Gear, Rear Axle, Tuff-Cork	P18564TC	1	1963-1977, 8-3/4" Ring Gear, Rear Axle, Tuff-Cork	P27930TC	1
Diff. Carrier Gasket			RAM W150		
1971, 8-3/4" Ring Gear, Rear Axle	P27930	1	Axle Hsg Cover Gasket		
1971, 8-3/4" Ring Gear, Rear Axle, Tuff-Cork	P27930TC	1	1981-1983, 8-1/4" Ring Gear, 8-3/8" Ring Gear, Rear Axle		
RAM VAN B250			P18564		
Axle Hsg Cover Gasket			1981-1983, 8-1/4" Ring Gear, 8-3/8" Ring Gear, Rear Axle, Tuff-Cork		
1981-1990, 8-1/4" Ring Gear, 8-3/8" Ring Gear, Rear Axle	P18564	1	P18564TC		
1981-1990, 8-1/4" Ring Gear, 8-3/8" Ring Gear, Rear Axle, Tuff-Cork	P18564TC	1	1978-1993, Front Axle		
1981-1990, 9-1/4" Ring Gear, Rear Axle	P29352	1	P27768T		
1981-1990, 9-1/4" Ring Gear, Rear Axle, Tuff-Cork	P29352TC	1	1978-1993, 10 Bolt Holes, Front Axle, Tuff-Cork		
RAM VAN B300			P27768TC		
Axle Hsg Cover Gasket			1978-1990, 9-1/4" Ring Gear, Rear Axle		
1979, Rear Axle, Tuff-Cork	P18564TC	1	P29352		
1971-1980, 8-3/8" Ring Gear, Rear Axle	P18564	1	1978-1990, 9-1/4" Ring Gear, Rear Axle, Tuff-Cork		
1971-1980, 8-3/8" Ring Gear, Rear Axle, Tuff-Cork	P18564TC	1	P29352TC		
1971-1980, 9-1/4" Ring Gear, Rear Axle	P29352	1	RAM W200		
1971-1980, 9-1/4" Ring Gear, Rear Axle, Tuff-Cork	P29352TC	1	Axle Hsg Cover Gasket		
Diff. Carrier Gasket			1972-1980, 3500, 3850, 4000 Pound Axle, Front Axle		
1971-1977, 8-3/4" Ring Gear, Rear Axle	P27930	1	P27768T		
1971-1977, 8-3/4" Ring Gear, Rear Axle, Tuff-Cork	P27930TC	1	1972-1980, 3500, 3850, 4000 Pound Axle, 10 Bolt Holes, Front Axle, Tuff-Cork		
RAM VAN B350			P27768TC		
Axle Hsg Cover Gasket			1972-1980, 4500 Pound Axle, Front Axle		
1981-1990, 8-1/4" Ring Gear, 8-3/8" Ring Gear, Rear Axle	P18564	1	P18562		
1981-1990, 8-1/4" Ring Gear, 8-3/8" Ring Gear, Rear Axle, Tuff-Cork	P18564TC	1	1972-1980, 4500 Pound Axle, Front Axle, Tuff-Cork		
1981-1990, 9-1/4" Ring Gear, Rear Axle	P29352	1	P18562TC		
1981-1990, 9-1/4" Ring Gear, Rear Axle, Tuff-Cork	P29352TC	1	1972-1980, 9-1/4" Ring Gear, Rear Axle		
RAM W100			P29352TC		
Axle Hsg Cover Gasket			1972-1977, 8-3/8" Ring Gear, Rear Axle, Tuff-Cork		
1981-1989, Front Axle	P27768T	1	P18564TC		
1981-1989, 10 Bolt Holes, Front Axle, Tuff-Cork	P27768TC	1	1963-1971, Dana 60, 70 Axle, Rear Axle		
1981-1989, 9-1/4" Ring Gear, Rear Axle	P29352	1	P18562		
1981-1989, 9-1/4" Ring Gear, Rear Axle, Tuff-Cork	P29352TC	1	1963-1971, Dana 60, 70 Axle, Rear Axle, Tuff-Cork		
1981-1989, Dana 60, 70 Axle, Rear Axle	P18562	1	P18562TC		
1981-1989, Dana 60, 70 Axle, Rear Axle, Tuff-Cork	P18562TC	1	Diff. Carrier Gasket		
1974-1977, 9-1/4" Ring Gear, Rear Axle	P29352	1	1969-1971, 8-3/4" Ring Gear, Rear Axle		
1974-1977, 9-1/4" Ring Gear, Rear Axle, Tuff-Cork	P29352TC	1	P27930		
1969-1977, 8-3/8" Ring Gear, Rear Axle	P18564	1	1969-1971, 8-3/4" Ring Gear, Rear Axle, Tuff-Cork		
1969-1977, 8-3/8" Ring Gear, Rear Axle, Tuff-Cork	P18564TC	1	P27930TC		
1963-1973, Front Axle	P27768T	1	RAM W250		
1963-1973, 10 Bolt Holes, Front Axle, Tuff-Cork	P27768TC	1	Axle Hsg Cover Gasket		
1963-1968, Rear Axle	P18562	1	1983-1993, Dana 44 Axle, Front Axle		
1963-1968, Rear Axle, Tuff-Cork	P18562TC	1	P27768T		
Diff. Carrier Gasket			1983-1993, Dana 44 Axle, 10 Bolt Holes, Front Axle, Tuff-Cork		
1963-1977, 8-3/4" Ring Gear, Rear Axle	P27930	1	P27768TC		
LIGHT TRUCK			1983-1993, Dana 60 Axle, Front Axle		
			P18562		
			1983-1993, Dana 60 Axle, Front Axle, Tuff-Cork		
			P18562TC		
			1983-1990, 8-1/4" Ring Gear, 8-3/8" Ring Gear, Rear Axle		
			P18564		
			1983-1990, 8-1/4" Ring Gear, 8-3/8" Ring Gear, Rear Axle, Tuff-Cork		
			P18564TC		
			1983-1990, 9-1/4" Ring Gear, Rear Axle		
			P29352		
			1983-1990, 9-1/4" Ring Gear, Rear Axle, Tuff-Cork		
			P29352TC		
			1983-1990, Dana 60, 70 Axle, Rear Axle		
			P18562		
			1983-1990, Dana 60, 70 Axle, Rear Axle, Tuff-Cork		
			P18562TC		
			RAM W300		
			Axle Hsg Cover Gasket		
			1969-1980, 9-1/4" Ring Gear, Rear Axle		
			P29352		
			1969-1980, 9-1/4" Ring Gear, Rear Axle, Tuff-Cork		
			P29352TC		
			1969-1978, 8-3/8" Ring Gear, Rear Axle		
			P18564		

Differential Housing Cover Gaskets (cont.)

Model & Application	Part No.	Qty.	Model & Application	Part No.	Qty.
RAM W300 (cont.)			RAM WAGON B200 (cont.)		
Axle Hsg Cover Gasket (cont.)			Diff. Carrier Gasket (cont.)		
1969-1978, 8-3/8" Ring Gear, Rear Axle, Tuff-Cork	P18564TC	1	1971, 8-3/4" Ring Gear, Rear Axle, Tuff-Cork	P27930TC	1
1967-1980, Dana 60, 70 Axle, Rear Axle, Tuff-Cork	P18562TC	1	RAM WAGON B250		
1963-1980, Front Axle	P18562	1	Axle Hsg Cover Gasket		
1963-1980, Front Axle, Tuff-Cork	P18562TC	1	1981-1990, 8-1/4" Ring Gear, 8-3/8" Ring Gear, Rear Axle	P18564	1
1963-1969, Dana 60, 70 Axle, Tuff-Cork	P18562TC	1	1981-1990, 8-1/4" Ring Gear, 8-3/8" Ring Gear, Rear Axle, Tuff-Cork	P18564TC	1
Diff. Carrier Gasket			1981-1990, 9-1/4" Ring Gear, Rear Axle	P29352	1
1969-1977, 8-3/4" Ring Gear, Rear Axle	P27930	1	1981-1990, 9-1/4" Ring Gear, Rear Axle, Tuff-Cork	P29352TC	1
1969-1977, 8-3/4" Ring Gear, Rear Axle, Tuff-Cork	P27930TC	1	RAM WAGON B300		
RAM W350			Axle Hsg Cover Gasket		
Axle Hsg Cover Gasket			1971-1980, 8-3/8" Ring Gear, Rear Axle	P18564	1
1983-1993, Front Axle	P18562	1	1971-1980, 8-3/8" Ring Gear, Rear Axle, Tuff-Cork	P18564TC	1
1983-1993, Front Axle, Tuff-Cork	P18562TC	1	1971-1980, 9-1/4" Ring Gear, Rear Axle	P29352	1
1983-1990, 8-3/8" Ring Gear, Rear Axle	P18564	1	1971-1980, 9-1/4" Ring Gear, Rear Axle, Tuff-Cork	P29352TC	1
1983-1990, 8-3/8" Ring Gear, Rear Axle, Tuff-Cork	P18564TC	1	Diff. Carrier Gasket		
1983-1990, 9-1/4" Ring Gear, Rear Axle	P29352	1	1971-1977, 8-3/4" Ring Gear, Rear Axle	P27930	1
1983-1990, 9-1/4" Ring Gear, Rear Axle, Tuff-Cork	P29352TC	1	1971-1977, 8-3/4" Ring Gear, Rear Axle, Tuff-Cork	P27930TC	1
1983-1990, Dana 60, 70 Axle, Rear Axle	P18562	1	RAM WAGON B350		
1983-1990, Dana 60, 70 Axle, Rear Axle, Tuff-Cork	P18562TC	1	Axle Hsg Cover Gasket		
RAM WAGON B100			1982-1990, 8-3/8" Ring Gear, Rear Axle	P18564	1
Axle Hsg Cover Gasket			1982-1990, 8-3/8" Ring Gear, Rear Axle, Tuff-Cork	P18564TC	1
1974-1979, 9-1/4" Ring Gear, Rear Axle	P29352	1	1982-1990, 9-1/4" Ring Gear, Rear Axle	P29352	1
1974-1979, 9-1/4" Ring Gear, Rear Axle, Tuff-Cork	P29352TC	1	1982-1990, 9-1/4" Ring Gear, Rear Axle, Tuff-Cork	P29352TC	1
1974-1977, 8-3/8" Ring Gear, Rear Axle	P18564	1	RAMCHARGER AD100		
1974-1977, 8-3/8" Ring Gear, Rear Axle, Tuff-Cork	P18564TC	1	Axle Hsg Cover Gasket		
1971, 8-3/8" Ring Gear, Rear Axle	P18564	1	1988, 9-1/4" Ring Gear, Rear Axle	P29352	1
1971, 8-3/8" Ring Gear, Rear Axle, Tuff-Cork	P18564TC	1	1988, 9-1/4" Ring Gear, Rear Axle, Tuff-Cork	P29352TC	1
Diff. Carrier Gasket			1988, Dana 60, 70 Axle, Rear Axle	P18562	1
1974-1977, 8-3/4" Ring Gear, Rear Axle	P27930	1	1988, Dana 60, 70 Axle, Rear Axle, Tuff-Cork	P18562TC	1
1974-1977, 8-3/4" Ring Gear, Rear Axle, Tuff-Cork	P27930TC	1	1978-1981, Dana 60, 70 Axle, Rear Axle	P18562	1
1971, 8-3/4" Ring Gear, Rear Axle	P27930	1	1978-1981, Dana 60, 70 Axle, Rear Axle, Tuff-Cork	P18562TC	1
1971, 8-3/4" Ring Gear, Rear Axle, Tuff-Cork	P27930TC	1	1974-1981, 9-1/4" Ring Gear, Rear Axle	P29352	1
RAM WAGON B150			1974-1981, 9-1/4" Ring Gear, Rear Axle, Tuff-Cork	P29352TC	1
Axle Hsg Cover Gasket			1974-1977, 8-3/8" Ring Gear, Rear Axle	P18564	1
1981-1990, 8-1/4" Ring Gear, 8-3/8" Ring Gear, Rear Axle	P18564	1	1974-1977, 8-3/8" Ring Gear, Rear Axle, Tuff-Cork	P18564TC	1
1981-1990, 8-1/4" Ring Gear, 8-3/8" Ring Gear, Rear Axle, Tuff-Cork	P18564TC	1	Diff. Carrier Gasket		
1981-1990, 9-1/4" Ring Gear, Rear Axle	P29352	1	1974-1977, 8-3/4" Ring Gear, Rear Axle	P27930	1
1981-1990, 9-1/4" Ring Gear, Rear Axle, Tuff-Cork	P29352TC	1	1974-1977, 8-3/4" Ring Gear, Rear Axle, Tuff-Cork	P27930TC	1
RAM WAGON B200			RAMCHARGER AD150		
Axle Hsg Cover Gasket			Axle Hsg Cover Gasket		
1972-1977, 8-3/8" Ring Gear, Rear Axle	P18564	1	1982-1990, 8-1/4" Ring Gear, 8-3/8" Ring Gear, Rear Axle	P18564	1
1972-1977, 8-3/8" Ring Gear, Rear Axle, Tuff-Cork	P18564TC	1	1982-1990, 8-1/4" Ring Gear, 8-3/8" Ring Gear, Rear Axle, Tuff-Cork	P18564TC	1
1972-1977, 9-1/4" Ring Gear, Rear Axle	P29352	1	1982-1990, 9-1/4" Ring Gear, Rear Axle	P29352	1
1972-1977, 9-1/4" Ring Gear, Rear Axle, Tuff-Cork	P29352TC	1	1982-1990, 9-1/4" Ring Gear, Rear Axle, Tuff-Cork	P29352TC	1
Diff. Carrier Gasket			Diff. Carrier Gasket		
1971, 8-3/4" Ring Gear, Rear Axle	P27930	1	1974-1977, 8-3/4" Ring Gear, Rear Axle	P27930	1
			1974-1977, 8-3/4" Ring Gear, Rear Axle, Tuff-Cork	P27930TC	1

Dodge Truck (cont.)

Differential Housing Cover Gaskets (cont.)

<i>Model & Application</i>	<i>Part No.</i>	<i>Qty.</i>	<i>Model & Application</i>	<i>Part No.</i>	<i>Qty.</i>
RAMCHARGER AD150 (cont.)			SPORTSMAN WAGON B350		
Axle Hsg Cover Gasket (cont.)			Axle Hsg Cover Gasket		
1982-1990, Dana 60, 70 Axle, Rear Axle	P18562	1	1981, 8-3/8" Ring Gear, Rear Axle	P18564	1
1982-1990, Dana 60, 70 Axle, Rear Axle, Tuff-Cork	P18562TC	1	1981, 8-3/8" Ring Gear, Rear Axle, Tuff-Cork	P18564TC	1
RAMCHARGER AW100			1981, 9-1/4" Ring Gear, Rear Axle		
Axle Hsg Cover Gasket			1981, 9-1/4" Ring Gear, Rear Axle, Tuff-Cork		
1988, Front Axle	P27768T	1		P29352	1
1988, 10 Bolt Holes, Front Axle, Tuff-Cork	P27768TC	1		P29352TC	1
1988, 9-1/4" Ring Gear, Rear Axle	P29352	1	TRAILDUSTER		
1988, 9-1/4" Ring Gear, Rear Axle, Tuff-Cork	P29352TC	1	Axle Hsg Cover Gasket		
1988, Dana 60, 70 Axle, Rear Axle	P18562	1	1978-1981, Dana 60, 70 Axle, Rear Axle		
1988, Dana 60, 70 Axle, Rear Axle, Tuff-Cork	P18562TC	1	1978-1981, Dana 60, 70 Axle, Rear Axle, Tuff-Cork		
1978-1981, Dana 60, 70 Axle, Rear Axle	P18562	1	1974-1981, Front Axle		
1978-1981, Dana 60, 70 Axle, Rear Axle, Tuff-Cork	P18562TC	1	1974-1981, 10 Bolt Holes, Front Axle, Tuff-Cork		
1974-1981, Front Axle	P27768T	1	1974-1981, 9-1/4" Ring Gear, Rear Axle		
1974-1981, 10 Bolt Holes, Front Axle, Tuff-Cork	P27768TC	1	1974-1981, 9-1/4" Ring Gear, Rear Axle, Tuff-Cork		
1974-1981, 9-1/4" Ring Gear, Rear Axle	P29352	1	1974-1981, 9-1/4" Ring Gear, Rear Axle, Tuff-Cork		
1974-1981, 9-1/4" Ring Gear, Rear Axle, Tuff-Cork	P29352TC	1	1974-1977, 8-3/8" Ring Gear, Rear Axle		
1974-1977, 8-3/8" Ring Gear, Rear Axle	P18564	1	1974-1977, 8-3/8" Ring Gear, Rear Axle, Tuff-Cork		
1974-1977, 8-3/8" Ring Gear, Rear Axle, Tuff-Cork	P18564TC	1	Diff. Carrier Gasket		
Diff. Carrier Gasket			1974-1977, 8-3/4" Ring Gear, Rear Axle		
1974-1977, 8-3/4" Ring Gear, Rear Axle	P27930	1	1974-1977, 8-3/4" Ring Gear, Rear Axle, Tuff-Cork		
1974-1977, 8-3/4" Ring Gear, Rear Axle, Tuff-Cork	P27930TC	1	VOYAGER PB100		
RAMCHARGER AW150			Axle Hsg Cover Gasket		
Axle Hsg Cover Gasket			1978-1980, Dana 60, 70 Axle, Rear Axle		
1982-1993, Front Axle	P27768T	1	1978-1980, Dana 60, 70 Axle, Rear Axle, Tuff-Cork		
1982-1993, 10 Bolt Holes, Front Axle, Tuff-Cork	P27768TC	1	1974-1980, 9-1/4" Ring Gear, Rear Axle		
1982-1990, 8-1/4" Ring Gear, 8-3/8" Ring Gear, Rear Axle	P18564	1	1974-1980, 9-1/4" Ring Gear, Rear Axle, Tuff-Cork		
1982-1990, 8-1/4" Ring Gear, 8-3/8" Ring Gear, Rear Axle, Tuff-Cork	P18564TC	1	1974-1977, 8-3/8" Ring Gear, Rear Axle		
1982-1990, 9-1/4" Ring Gear, Rear Axle	P29352	1	1974-1977, 8-3/8" Ring Gear, Rear Axle, Tuff-Cork		
1982-1990, 9-1/4" Ring Gear, Rear Axle, Tuff-Cork	P29352TC	1	Diff. Carrier Gasket		
1982-1990, Dana 60, 70 Axle, Rear Axle	P18562	1	1974-1977, 8-3/4" Ring Gear, Rear Axle		
1982-1990, Dana 60, 70 Axle, Rear Axle, Tuff-Cork	P18562TC	1	1974-1977, 8-3/4" Ring Gear, Rear Axle, Tuff-Cork		
SPORTSMAN WAGON B150			VOYAGER PB150		
Axle Hsg Cover Gasket			Axle Hsg Cover Gasket		
1981, 8-1/4" Ring Gear, 8-3/8" Ring Gear, Rear Axle	P18564	1	1981-1983, 8-1/4" Ring Gear, 8-3/8" Ring Gear, Rear Axle		
1981, 8-1/4" Ring Gear, 8-3/8" Ring Gear, Rear Axle, Tuff-Cork	P18564TC	1	1981-1983, 8-1/4" Ring Gear, 8-3/8" Ring Gear, Rear Axle, Tuff-Cork		
1981, 9-1/4" Ring Gear, Rear Axle	P29352	1	1981-1983, 9-1/4" Ring Gear, Rear Axle		
1981, 9-1/4" Ring Gear, Rear Axle, Tuff-Cork	P29352TC	1	1981-1983, 9-1/4" Ring Gear, Rear Axle, Tuff-Cork		
SPORTSMAN WAGON B250			1981-1983, Dana 60, 70 Axle, Rear Axle		
Axle Hsg Cover Gasket			1981-1983, Dana 60, 70 Axle, Rear Axle, Tuff-Cork		
1981, 8-1/4" Ring Gear, 8-3/8" Ring Gear, Rear Axle	P18564	1	VOYAGER PB200		
1981, 8-1/4" Ring Gear, 8-3/8" Ring Gear, Rear Axle, Tuff-Cork	P18564TC	1	Axle Hsg Cover Gasket		
1981, 9-1/4" Ring Gear, Rear Axle	P29352	1	1974-1980, Dana 60, 70 Axle, Rear Axle		
1981, 9-1/4" Ring Gear, Rear Axle, Tuff-Cork	P29352TC	1	1974-1980, Dana 60, 70 Axle, Rear Axle, Tuff-Cork		

LIGHT TRUCK

Differential Housing Cover Gaskets (cont.)

Model & Application	Part No.	Qty.	Model & Application	Part No.	Qty.
VOYAGER PB250			VOYAGER PB300 (cont.)		
Axle Hsg Cover Gasket			Diff. Carrier Gasket		
1981-1983, 8-1/4" Ring Gear, 8-3/8" Ring Gear, Rear Axle	P18564	1	1974-1977, 8-3/4" Ring Gear, Rear Axle	P27930	1
1981-1983, 8-1/4" Ring Gear, 8-3/8" Ring Gear, Rear Axle, Tuff-Cork	P18564TC	1	1974-1977, 8-3/4" Ring Gear, Rear Axle, Tuff-Cork	P27930TC	1
1981-1983, 9-1/4" Ring Gear, Rear Axle	P29352	1	VOYAGER PB350		
1981-1983, 9-1/4" Ring Gear, Rear Axle, Tuff-Cork	P29352TC	1	Axle Hsg Cover Gasket		
1981-1983, Dana 60, 70 Axle, Rear Axle	P18562	1	1981-1983, 8-3/8" Ring Gear, Rear Axle	P18564	1
1981-1983, Dana 60, 70 Axle, Rear Axle, Tuff-Cork	P18562TC	1	1981-1983, 8-3/8" Ring Gear, Rear Axle, Tuff-Cork	P18564TC	1
VOYAGER PB300			1981-1983, 9-1/4" Ring Gear, Rear Axle	P29352	1
Axle Hsg Cover Gasket			1981-1983, 9-1/4" Ring Gear, Rear Axle, Tuff-Cork	P29352TC	1
1974-1980, 8-3/8" Ring Gear, Rear Axle	P18564	1	1981-1983, Dana 60, 70 Axle, Rear Axle	P18562	1
1974-1980, 8-3/8" Ring Gear, Rear Axle, Tuff-Cork	P18564TC	1	1981-1983, Dana 60, 70 Axle, Rear Axle, Tuff-Cork	P18562TC	1
1974-1980, 9-1/4" Ring Gear, Rear Axle	P29352	1	WM300		
1974-1980, 9-1/4" Ring Gear, Rear Axle, Tuff-Cork	P29352TC	1	Axle Hsg Cover Gasket		
1974-1980, Dana 60, 70 Axle, Rear Axle	P18562	1	1963-1968, Front Axle	P18562	1
1974-1980, Dana 60, 70 Axle, Rear Axle, Tuff-Cork	P18562TC	1	1963-1968, Front Axle, Tuff-Cork	P18562TC	1

Transmission Gaskets

Model & Application	Part No.	Qty.	Model & Application	Part No.	Qty.
1 TON			1/2 TON (cont.)		
Elec. Shift Cover Gasket			P.T.O. Mounting Gasket (cont.)		
1940-1956, 10 Bolt, Eaton 2 Speed Axle	H36328	1	1942-1943, .020" Thickness, 8 Bolt, Chelsea Power Take Off	H26208	1
1940-1956, 11 Bolt, Eaton 2 Speed Axle	H36329	1	3/4 TON		
P.T.O. Cover Gasket			Elec. Shift Cover Gasket		
1940-1956, 6 Bolt, Chelsea Power Take Off	H36080	1	1940-1956, 10 Bolt, Eaton 2 Speed Axle	H36328	1
1940-1956, 8 Bolt, Chelsea Power Take Off	H36124	1	1940-1956, 11 Bolt, Eaton 2 Speed Axle	H36329	1
P.T.O. Mounting Gasket			P.T.O. Cover Gasket		
1940-1956, .010" Thickness, 6 Bolt, Chelsea Power Take Off	H26205	1	1940-1956, 6 Bolt, Chelsea Power Take Off	H36080	1
1940-1956, .010" Thickness, 8 Bolt, Chelsea Power Take Off	H26207	1	1940-1956, 8 Bolt, Chelsea Power Take Off	H36124	1
1940-1956, .020" Thickness, 6 Bolt, Chelsea Power Take Off	H26206	1	P.T.O. Mounting Gasket		
1940-1956, .020" Thickness, 8 Bolt, Chelsea Power Take Off	H26208	1	1940-1956, .010" Thickness, 6 Bolt, Chelsea Power Take Off	H26205	1
1/2 TON			1940-1956, .010" Thickness, 8 Bolt, Chelsea Power Take Off	H26207	1
Elec. Shift Cover Gasket			1940-1956, .020" Thickness, 6 Bolt, Chelsea Power Take Off	H26206	1
1946-1956, 10 Bolt, Eaton 2 Speed Axle	H36328	1	1940-1956, .020" Thickness, 8 Bolt, Chelsea Power Take Off	H26208	1
1946-1956, 11 Bolt, Eaton 2 Speed Axle	H36329	1	Transmission Pan Gasket		
1942-1943, 10 Bolt, Eaton 2 Speed Axle	H36328	1	1990, A518 Automatic Overdrive Transmission, A727 Automatic Transmission	W39003	1
P.T.O. Cover Gasket			A100		
1946-1956, 6 Bolt, Chelsea Power Take Off	H36080	1	Elec. Shift Cover Gasket		
1946-1956, 8 Bolt, Chelsea Power Take Off	H36124	1	1963-1970, 10 Bolt, Eaton 2 Speed Axle	H36328	1
1942-1943, 6 Bolt, Chelsea Power Take Off	H36080	1	1963-1970, 11 Bolt, Eaton 2 Speed Axle	H36329	1
1942-1943, 8 Bolt, Chelsea Power Take Off	H36124	1	P.T.O. Cover Gasket		
P.T.O. Mounting Gasket			1963-1970, 6 Bolt, Chelsea Power Take Off	H36080	1
1946-1956, .010" Thickness, 6 Bolt, Chelsea Power Take Off	H26205	1	1963-1970, 8 Bolt, Chelsea Power Take Off	H36124	1
1946-1956, .010" Thickness, 8 Bolt, Chelsea Power Take Off	H26207	1	P.T.O. Mounting Gasket		
1946-1956, .020" Thickness, 6 Bolt, Chelsea Power Take Off	H26206	1	1963-1970, .010" Thickness, 6 Bolt, Chelsea Power Take Off	H26205	1
1946-1956, .020" Thickness, 8 Bolt, Chelsea Power Take Off	H26208	1			
1942-1943, .010" Thickness, 8 Bolt, Chelsea Power Take Off	H26207	1			

Dodge Truck (cont.)

Transmission Gaskets (cont.)

<i>Model & Application</i>	<i>Part No.</i>	<i>Qty.</i>	<i>Model & Application</i>	<i>Part No.</i>	<i>Qty.</i>
A100 (cont.)			DAKOTA (cont.)		
P.T.O. Mounting Gasket (cont.)			P.T.O. Mounting Gasket (cont.)		
1963-1970, .010" Thickness, 8 Bolt, Chelsea Power Take Off	H26207	1	1987-1989, .020" Thickness, 6 Bolt, Chelsea Power Take Off	H26206	1
1963-1970, .020" Thickness, 6 Bolt, Chelsea Power Take Off	H26206	1	Transmission Pan Gasket		
1963-1970, .020" Thickness, 8 Bolt, Chelsea Power Take Off	H26208	1	1998-2001, 46RE Automatic Overdrive Transmission	W39003	1
Transmission Gasket Set			1998-2001, 46RE Automatic Overdrive Transmission, Tuff-Cork	W39003TC	1
1969-1970, 435, 445 Transmission	TS26390X	1	1997-2001, 42RE Automatic Overdrive Transmission	W38031	1
Transmission Pan Gasket			1997-1999, 44RE Automatic Overdrive Transmission	W38031	1
1963-1970	W39003	1	1994-1996, 42RH Automatic Overdrive Transmission	W38031	1
1963-1970, Tuff-Cork	W39003TC	1	1994-1996, 46RH Automatic Overdrive Transmission	W39003	1
ARROW			1994-1996, 46RH Automatic Overdrive Transmission, Tuff-Cork	W39003TC	1
Elec. Shift Cover Gasket			1990-1993, A500 Automatic Overdrive Transmission, A998 Automatic Transmission	W38031	1
1979-1982, 10 Bolt, Eaton 2 Speed Axle	H36328	1	1990-1993, A518 Automatic Overdrive Transmission, A727 Automatic Transmission	W39003	1
1979-1982, 11 Bolt, Eaton 2 Speed Axle	H36329	1	1990-1993, A518 Automatic Overdrive Transmission, A727 Automatic Transmission, Tuff-Cork	W39003TC	1
P.T.O. Cover Gasket			1989, A727 Automatic Transmission	W39003	1
1979-1982, 6 Bolt, Chelsea Power Take Off	H36080	1	1989, A727 Automatic Transmission, Tuff-Cork	W39003TC	1
1979-1982, 8 Bolt, Chelsea Power Take Off	H36124	1	1987-1989, A904 Automatic Transmission, A998 Automatic Transmission, A999 Automatic Transmission	W38031	1
P.T.O. Mounting Gasket			DURANGO		
1979-1982, .010" Thickness, 6 Bolt, Chelsea Power Take Off	H26205	1	Elec. Shift Cover Gasket		
1979-1982, .010" Thickness, 8 Bolt, Chelsea Power Take Off	H26207	1	1998, 10 Bolt, Eaton 2 Speed Axle	H36328	1
1979-1982, .020" Thickness, 6 Bolt, Chelsea Power Take Off	H26206	1	1998, 11 Bolt, Eaton 2 Speed Axle	H36329	1
1979-1982, .020" Thickness, 8 Bolt, Chelsea Power Take Off	H26208	1	P.T.O. Cover Gasket		
CARAVAN			1998, 6 Bolt, Chelsea Power Take Off	H36080	1
Transaxle Diff. Cvr Gasket			1998, 8 Bolt, Chelsea Power Take Off	H36124	1
1989-1991, A413 Transaxle, A670 Transaxle, Tuff-Cork	W37731TC	1	P.T.O. Mounting Gasket		
1989-1991, A604 Transaxle, Tuff-Cork	W39376TC	1	1998, .010" Thickness, 6 Bolt, Chelsea Power Take Off	H26205	1
1984-1988, Tuff-Cork	W37731TC	1	1998, .010" Thickness, 8 Bolt, Chelsea Power Take Off	H26207	1
Transaxle End Cvr. Gasket			1998, .020" Thickness, 6 Bolt, Chelsea Power Take Off	H26206	1
1989-1991, A604 Transaxle, Rear, Tuff-Cork	W39377TC	1	1998, .020" Thickness, 8 Bolt, Chelsea Power Take Off	H26208	1
1984-1986, Rear, Tuff-Cork	W37347TC	1	Transmission Pan Gasket		
Transaxle Pan Gasket			1998-2001, 46RE Automatic Overdrive Transmission	W39003	1
1989-1991, A413 Transaxle, A670 Transaxle, Tuff-Cork	W38795TC	1	1998-2001, 46RE Automatic Overdrive Transmission, Tuff-Cork	W39003TC	1
1989-1991, A604 Transaxle, Tuff-Cork	W39375TC	1	1998-2000, 44RE Automatic Overdrive Transmission	W38031	1
1984-1988, Tuff-Cork	W38795TC	1	1998-1999, 42RE Automatic Overdrive Transmission	W38031	1
DAKOTA			GRAND CARAVAN		
Elec. Shift Cover Gasket			Transaxle Diff. Cvr Gasket		
1992-1998, 11 Bolt, Eaton 2 Speed Axle	H36329	1	1989-1991, A413 Transaxle, A670 Transaxle, Tuff-Cork	W37731TC	1
1987-1998, 10 Bolt, Eaton 2 Speed Axle	H36328	1	1989-1991, A604 Transaxle, Tuff-Cork	W39376TC	1
1987-1989, 11 Bolt, Eaton 2 Speed Axle	H36329	1	1987-1988, Tuff-Cork	W37731TC	1
P.T.O. Cover Gasket					
1987-1998, 6 Bolt, Chelsea Power Take Off	H36080	1			
1987-1998, 8 Bolt, Chelsea Power Take Off	H36124	1			
P.T.O. Mounting Gasket					
1992-1998, .010" Thickness, 6 Bolt, Chelsea Power Take Off	H26205	1			
1992-1998, .020" Thickness, 6 Bolt, Chelsea Power Take Off	H26206	1			
1987-1998, .010" Thickness, 8 Bolt, Chelsea Power Take Off	H26207	1			
1987-1998, .020" Thickness, 8 Bolt, Chelsea Power Take Off	H26208	1			
1987-1989, .010" Thickness, 6 Bolt, Chelsea Power Take Off	H26205	1			

LIGHT TRUCK

Transmission Gaskets (cont.)

<i>Model & Application</i>	<i>Part No.</i>	<i>Qty.</i>	<i>Model & Application</i>	<i>Part No.</i>	<i>Qty.</i>
GRAND CARAVAN (cont.)			MBH300 (cont.)		
Transaxle End Cvr. Gasket			P.T.O. Mounting Gasket		
1989-1991, A604 Transaxle, Rear, Tuff-Cork	.W39377TC	1	1974, .010" Thickness, 6 Bolt, Chelsea Power Take Off	H26205	1
Transaxle Pan Gasket			1974, .010" Thickness, 8 Bolt, Chelsea Power Take Off	H26207	1
1989-1991, A413 Transaxle, A670 Transaxle, Tuff-CorkW38795TC	1	1974, .020" Thickness, 6 Bolt, Chelsea Power Take Off	H26206	1
1989-1991, A604 Transaxle, Tuff-CorkW39375TC	1	1974, .020" Thickness, 8 Bolt, Chelsea Power Take Off	H26208	1
1987-1988, Tuff-CorkW38795TC	1	Transmission Gasket Set		
GRAND VOYAGER			1974, 435, 445 Transmission	TS26390X	1
Transaxle Diff. Cvr Gasket			Transmission Pan Gasket		
1989-1991, A413 Transaxle, A670 Transaxle, Tuff-CorkW37731TC	1	1974, A727 Automatic Transmission	W39003	1
1989-1991, A604 Transaxle, Tuff-CorkW39376TC	1	1974, A727 Automatic Transmission, Tuff-Cork	W39003TC	1
1987-1988, Tuff-CorkW37731TC	1	1974, A904 Automatic Transmission, A998 Automatic Transmission, A999 Automatic Transmission	W38031	1
Transaxle End Cvr. Gasket			MINI RAM		
1989-1991, A604 Transaxle, Rear, Tuff-Cork	.W39377TC	1	Transaxle Diff. Cvr Gasket		
Transaxle Pan Gasket			1984-1988, Tuff-Cork	W37731TC	1
1989-1991, A413 Transaxle, A670 Transaxle, Tuff-CorkW38795TC	1	Transaxle End Cvr. Gasket		
1989-1991, A604 Transaxle, Tuff-CorkW39375TC	1	1984-1986, Rear, Tuff-Cork	W37347TC	1
1987-1988, Tuff-CorkW38795TC	1	Transaxle Pan Gasket		
M300			1984-1988, Tuff-Cork	W38795TC	1
Elec. Shift Cover Gasket			P100		
1975-1980, 10 Bolt, Eaton 2 Speed Axle	H36328	1	Elec. Shift Cover Gasket		
1975-1980, 11 Bolt, Eaton 2 Speed Axle	H36329	1	1962-1965, 10 Bolt, Eaton 2 Speed Axle	H36328	1
1963-1972, 10 Bolt, Eaton 2 Speed Axle	H36328	1	1962-1965, 11 Bolt, Eaton 2 Speed Axle	H36329	1
P.T.O. Cover Gasket			P.T.O. Cover Gasket		
1975-1980, 6 Bolt, Chelsea Power Take Off	H36080	1	1962-1965, 6 Bolt, Chelsea Power Take Off	H36080	1
1975-1980, 8 Bolt, Chelsea Power Take Off	H36124	1	1962-1965, 8 Bolt, Chelsea Power Take Off	H36124	1
1963-1972, 6 Bolt, Chelsea Power Take Off	H36080	1	P.T.O. Mounting Gasket		
1963-1972, 8 Bolt, Chelsea Power Take Off	H36124	1	1962-1965, .010" Thickness, 6 Bolt, Chelsea Power Take Off	H26205	1
P.T.O. Mounting Gasket			1975-1980, .010" Thickness, 8 Bolt, Chelsea Power Take Off	H26207	1
1975-1980, .010" Thickness, 8 Bolt, Chelsea Power Take Off	H26207	1	1975-1980, .020" Thickness, 6 Bolt, Chelsea Power Take Off	H26206	1
1975-1980, .020" Thickness, 6 Bolt, Chelsea Power Take Off	H26206	1	1975-1980, .020" Thickness, 8 Bolt, Chelsea Power Take Off	H26208	1
1975-1980, .020" Thickness, 8 Bolt, Chelsea Power Take Off	H26208	1	1963-1972, .010" Thickness, 8 Bolt, Chelsea Power Take Off	H26207	1
1963-1972, .010" Thickness, 8 Bolt, Chelsea Power Take Off	H26207	1	1963-1972, .020" Thickness, 8 Bolt, Chelsea Power Take Off	H26208	1
1963-1972, .020" Thickness, 8 Bolt, Chelsea Power Take Off	H26208	1	Transmission Gasket Set		
Transmission Gasket Set			1965, Ford 3 Speed Transmission	TS27817X	1
1975-1980, 435, 445 Transmission	TS26390X	1	1962, Ford 3 Speed Transmission	TS27051W	1
Transmission Pan Gasket			Transmission Pan Gasket		
1975-1980, A727 Automatic Transmission	W39003	1	1964-1965, Automatic 3 Speed Transmission, Dual Range	W37953	1
1975-1980, A727 Automatic Transmission, Tuff-Cork	W39003TC	1	1963-1965	W39003	1
1975-1980, A904 Automatic Transmission, A998 Automatic Transmission, A999 Automatic Transmission	W38031	1	1963-1965, Tuff-Cork	W39003TC	1
1963-1972	W39003	1	P200		
1963-1972, Tuff-Cork	W39003TC	1	Elec. Shift Cover Gasket		
MBH300			1961-1974, 10 Bolt, Eaton 2 Speed Axle	H36328	1
Elec. Shift Cover Gasket			1961-1974, 11 Bolt, Eaton 2 Speed Axle	H36329	1
1974, 10 Bolt, Eaton 2 Speed Axle	H36328	1	P.T.O. Cover Gasket		
1974, 11 Bolt, Eaton 2 Speed Axle	H36329	1	1961-1974, 6 Bolt, Chelsea Power Take Off	H36080	1
P.T.O. Cover Gasket			1961-1974, 8 Bolt, Chelsea Power Take Off	H36124	1
1974, 6 Bolt, Chelsea Power Take Off	H36080	1	P.T.O. Mounting Gasket		
1974, 8 Bolt, Chelsea Power Take Off	H36124	1	1961-1974, .010" Thickness, 6 Bolt, Chelsea Power Take Off	H26205	1
			1961-1974, .010" Thickness, 8 Bolt, Chelsea Power Take Off	H26207	1

Dodge Truck (cont.)

Transmission Gaskets (cont.)

<i>Model & Application</i>	<i>Part No.</i>	<i>Qty.</i>	<i>Model & Application</i>	<i>Part No.</i>	<i>Qty.</i>
P200 (cont.)			POWER RAM W250 (cont.)		
P.T.O. Mounting Gasket (cont.)			Transmission Gasket Set		
1961-1974, .020" Thickness, 6 Bolt, Chelsea Power Take Off	H26206	1	1981-1983, 435, 445 Transmission	TS26390X	1
1961-1974, .020" Thickness, 8 Bolt, Chelsea Power Take Off	H26208	1	Transmission Pan Gasket		
Transmission Gasket Set			1981-1988, A727 Automatic Transmission	W39003	1
1973-1974, A390 Transmission	TS29047	1	1981-1988, A727 Automatic Transmission, Tuff-Cork	W39003TC	1
1969-1974, 435, 445 Transmission	TS26390X	1	1981-1988, A904 Automatic Transmission, A998 Automatic Transmission, A999 Automatic Transmission	W38031	1
Transmission Pan Gasket			POWER RAM W350		
1974, A904 Automatic Transmission, A998 Automatic Transmission, A999 Automatic Transmission	W38031	1	Elec. Shift Cover Gasket		
1961-1974, A727 Automatic Transmission	W39003	1	1981-1988, 10 Bolt, Eaton 2 Speed Axle	H36328	1
1961-1974, A727 Automatic Transmission, Tuff-Cork	W39003TC	1	1981-1988, 11 Bolt, Eaton 2 Speed Axle	H36329	1
P300			P.T.O. Cover Gasket		
Elec. Shift Cover Gasket			1981-1988, 6 Bolt, Chelsea Power Take Off	H36080	1
1957-1977, 10 Bolt, Eaton 2 Speed Axle	H36328	1	1981-1988, 8 Bolt, Chelsea Power Take Off	H36124	1
1957-1977, 11 Bolt, Eaton 2 Speed Axle	H36329	1	P.T.O. Mounting Gasket		
P.T.O. Cover Gasket			1981-1988, .010" Thickness, 6 Bolt, Chelsea Power Take Off	H26205	1
1957-1977, 6 Bolt, Chelsea Power Take Off	H36080	1	1981-1988, .010" Thickness, 8 Bolt, Chelsea Power Take Off	H26207	1
1957-1977, 8 Bolt, Chelsea Power Take Off	H36124	1	1981-1988, .020" Thickness, 6 Bolt, Chelsea Power Take Off	H26206	1
P.T.O. Mounting Gasket			Transmission Gasket Set		
1957-1977, .010" Thickness, 6 Bolt, Chelsea Power Take Off	H26205	1	1981-1983, 435, 445 Transmission	TS26390X	1
1957-1977, .010" Thickness, 8 Bolt, Chelsea Power Take Off	H26207	1	Transmission Pan Gasket		
1957-1977, .020" Thickness, 6 Bolt, Chelsea Power Take Off	H26206	1	1981-1988, A727 Automatic Transmission	W39003	1
1957-1977, .020" Thickness, 8 Bolt, Chelsea Power Take Off	H26208	1	1981-1988, A727 Automatic Transmission, Tuff-Cork	W39003TC	1
Transmission Gasket Set			1981-1988, A904 Automatic Transmission, A998 Automatic Transmission, A999 Automatic Transmission	W38031	1
1973-1977, A390 Transmission	TS29047	1	POWER WAGON		
1969-1977, 435, 445 Transmission	TS26390X	1	Elec. Shift Cover Gasket		
Transmission Pan Gasket			1947-1957, 10 Bolt, Eaton 2 Speed Axle	H36328	1
1974-1977, A904 Automatic Transmission, A998 Automatic Transmission, A999 Automatic Transmission	W38031	1	1947-1957, 11 Bolt, Eaton 2 Speed Axle	H36329	1
1963-1974, A727 Automatic Transmission	W39003	1	P.T.O. Cover Gasket		
1959-1977, A727 Automatic Transmission, Tuff-Cork	W39003TC	1	1947-1957, 6 Bolt, Chelsea Power Take Off	H36080	1
POWER RAM 50			1947-1957, 8 Bolt, Chelsea Power Take Off	H36124	1
Transmission Pan Gasket			P.T.O. Mounting Gasket		
1987-1990	W39372	1	1947-1957, .010" Thickness, 6 Bolt, Chelsea Power Take Off	H26205	1
1986	W39081	1	1947-1957, .020" Thickness, 6 Bolt, Chelsea Power Take Off	H26206	1
1982-1983	W39081	1	RM300		
POWER RAM W250			Elec. Shift Cover Gasket		
Elec. Shift Cover Gasket			1973-1974, 10 Bolt, Eaton 2 Speed Axle	H36328	1
1981-1988, 10 Bolt, Eaton 2 Speed Axle	H36328	1	1973-1974, 11 Bolt, Eaton 2 Speed Axle	H36329	1
1981-1988, 11 Bolt, Eaton 2 Speed Axle	H36329	1	P.T.O. Cover Gasket		
P.T.O. Cover Gasket			1973-1974, 6 Bolt, Chelsea Power Take Off	H36080	1
1981-1988, 6 Bolt, Chelsea Power Take Off	H36080	1	1973-1974, 8 Bolt, Chelsea Power Take Off	H36124	1
1981-1988, 8 Bolt, Chelsea Power Take Off	H36124	1	P.T.O. Mounting Gasket		
P.T.O. Mounting Gasket			1973-1974, .010" Thickness, 6 Bolt, Chelsea Power Take Off	H26205	1
1981-1988, .010" Thickness, 6 Bolt, Chelsea Power Take Off	H26205	1	1973-1974, .020" Thickness, 6 Bolt, Chelsea Power Take Off	H26206	1
1981-1988, .010" Thickness, 8 Bolt, Chelsea Power Take Off	H26207	1	Transmission Gasket Set		
1981-1988, .020" Thickness, 6 Bolt, Chelsea Power Take Off	H26206	1	1973-1974, 435, 445 Transmission	TS26390X	1
1981-1988, .020" Thickness, 8 Bolt, Chelsea Power Take Off	H26208	1			

LIGHT TRUCK

Transmission Gaskets (cont.)

<i>Model & Application</i>	<i>Part No.</i>	<i>Qty.</i>	<i>Model & Application</i>	<i>Part No.</i>	<i>Qty.</i>
RM300 (cont.)			RAM 2500 HEAVY DUTY (cont.)		
Transmission Pan Gasket			Transmission Pan Gasket (cont.)		
1974, A904 Automatic Transmission, A998 Automatic Transmission, A999 Automatic Transmission	W38031	1	2003, 46RE Automatic Overdrive Transmission, 47RE Automatic Overdrive Transmission, Tuff-Cork	W39003TC	1
1973-1974, A727 Automatic Transmission	W39003	1			
1973-1974, A727 Automatic Transmission, Tuff-Cork	W39003TC	1			
RAIDER			RAM 2500HD		
Transmission Pan Gasket			Elec. Shift Cover Gasket		
1987-1989	W39372	1	1994-1998, 10 Bolt, Eaton 2 Speed Axle	H36328	1
			1994-1998, 11 Bolt, Eaton 2 Speed Axle	H36329	1
RAM 1500			P.T.O. Cover Gasket		
Elec. Shift Cover Gasket			1994-1998, 6 Bolt, Chelsea Power Take Off		
1994-1998, 10 Bolt, Eaton 2 Speed Axle	H36328	1	1994-1998, 8 Bolt, Chelsea Power Take Off	H36124	1
1994-1998, 11 Bolt, Eaton 2 Speed Axle	H36329	1			
P.T.O. Cover Gasket			P.T.O. Mounting Gasket		
1994-1998, 6 Bolt, Chelsea Power Take Off	H36080	1	1994-1998, .010" Thickness, 6 Bolt, Chelsea Power Take Off	H26205	1
1994-1998, 8 Bolt, Chelsea Power Take Off	H36124	1	1994-1998, .020" Thickness, 6 Bolt, Chelsea Power Take Off	H26206	1
			1994-1996, .010" Thickness, 8 Bolt, Chelsea Power Take Off	H26207	1
P.T.O. Mounting Gasket			Transmission Pan Gasket		
1994-1998, .010" Thickness, 6 Bolt, Chelsea Power Take Off	H26205	1	2002, 46RE Automatic Overdrive Transmission, 47RE Automatic Overdrive Transmission	W39003	1
1994-1998, .020" Thickness, 6 Bolt, Chelsea Power Take Off	H26206	1	2002, 46RE Automatic Overdrive Transmission, 47RE Automatic Overdrive Transmission, Tuff-Cork	W39003TC	1
1994-1996, .010" Thickness, 8 Bolt, Chelsea Power Take Off	H26207	1	1994-2002, 46RE Automatic Overdrive Transmission, 46RH Automatic Overdrive Transmission, 47RE Automatic Overdrive Transmission	W39003	1
Transmission Pan Gasket			1994-2002, 46RE Automatic Overdrive Transmission, 46RH Automatic Overdrive Transmission, 47RE Automatic Overdrive Transmission, Tuff-Cork		
1997-2001, 42RE Automatic Overdrive Transmission	W38031	1			
1997-2001, 46RE Automatic Overdrive Transmission	W39003	1			
1997-2001, 46RE Automatic Overdrive Transmission, Tuff-Cork	W39003TC	1			
1994-1996, 42RH Automatic Overdrive Transmission	W38031	1			
1994-1996, 46RH Automatic Overdrive Transmission	W39003	1			
1994-1996, 46RH Automatic Overdrive Transmission, Tuff-Cork	W39003TC	1			
RAM 2500			RAM 3500		
Elec. Shift Cover Gasket			Elec. Shift Cover Gasket		
1994-1996, 10 Bolt, Eaton 2 Speed Axle	H36328	1	1994-1997, 10 Bolt, Eaton 2 Speed Axle	H36328	1
1994-1996, 11 Bolt, Eaton 2 Speed Axle	H36329	1	1994-1997, 11 Bolt, Eaton 2 Speed Axle	H36329	1
P.T.O. Cover Gasket			P.T.O. Cover Gasket		
1994-1996, 6 Bolt, Chelsea Power Take Off	H36080	1	1994-1997, 6 Bolt, Chelsea Power Take Off	H36080	1
1994-1996, 8 Bolt, Chelsea Power Take Off	H36124	1	1994-1997, 8 Bolt, Chelsea Power Take Off	H36124	1
P.T.O. Mounting Gasket			P.T.O. Mounting Gasket		
1994-1996, .010" Thickness, 6 Bolt, Chelsea Power Take Off	H26205	1	1994-1997, .010" Thickness, 6 Bolt, Chelsea Power Take Off	H26205	1
1994-1996, .010" Thickness, 8 Bolt, Chelsea Power Take Off	H26207	1	1994-1997, .010" Thickness, 8 Bolt, Chelsea Power Take Off	H26207	1
1994-1996, .020" Thickness, 6 Bolt, Chelsea Power Take Off	H26206	1	1994-1997, .020" Thickness, 6 Bolt, Chelsea Power Take Off	H26206	1
Transmission Pan Gasket			Transmission Pan Gasket		
1994-1996, 46RH Automatic Overdrive Transmission	W39003	1	2002, 46RE Automatic Overdrive Transmission, 47RE Automatic Overdrive Transmission	W39003	1
1994-1996, 46RH Automatic Overdrive Transmission, Tuff-Cork	W39003TC	1	2002, 46RE Automatic Overdrive Transmission, 47RE Automatic Overdrive Transmission, Tuff-Cork	W39003TC	1
			1994-2002, 46RE Automatic Overdrive Transmission, 46RH Automatic Overdrive Transmission, 47RE Automatic Overdrive Transmission	W39003	1
			1994-2002, 46RE Automatic Overdrive Transmission, 46RH Automatic Overdrive Transmission, 47RE Automatic Overdrive Transmission, Tuff-Cork	W39003TC	1
RAM 2500 HEAVY DUTY			Transmission Pan Gasket		
Transmission Pan Gasket			2003, 46RE Automatic Overdrive Transmission, 47RE Automatic Overdrive Transmission		
2003, 46RE Automatic Overdrive Transmission, 47RE Automatic Overdrive Transmission	W39003	1			

Dodge Truck (cont.)

Transmission Gaskets (cont.)

<i>Model & Application</i>	<i>Part No.</i>	<i>Qty.</i>	<i>Model & Application</i>	<i>Part No.</i>	<i>Qty.</i>
RAM 3500 HEAVY DUTY			RAM CB350 (cont.)		
Transmission Pan Gasket			Transmission Pan Gasket		
2003, 46RE Automatic Overdrive			1981, A727 Automatic Transmission	W39003	1
Transmission, 47RE Automatic Overdrive			1981, A727 Automatic Transmission,		
Transmission	W39003	1	Tuff-Cork	W39003TC	1
2003, 46RE Automatic Overdrive			1981, A904 Automatic Transmission, A998		
Transmission, 47RE Automatic Overdrive			Automatic Transmission, A999 Automatic		
Transmission, Tuff-Cork	W39003TC	1	Transmission	W38031	1
RAM 50			RAM D100		
Transmission Pan Gasket			Elec. Shift Cover Gasket		
1987-1990	W39372	1	1957-1989, 10 Bolt, Eaton 2 Speed Axle	H36328	1
1982-1986	W39081	1	1957-1989, 11 Bolt, Eaton 2 Speed Axle	H36329	1
RAM CB300			P.T.O. Cover Gasket		
Elec. Shift Cover Gasket			1957-1989, 6 Bolt, Chelsea Power Take Off		
1979-1980, 10 Bolt, Eaton 2 Speed Axle	H36328	1	1957-1989, 8 Bolt, Chelsea Power Take Off	H36124	1
1979-1980, 11 Bolt, Eaton 2 Speed Axle	H36329	1	P.T.O. Mounting Gasket		
1972-1973, 10 Bolt, Eaton 2 Speed Axle	H36328	1	1959-1989, .010" Thickness, 8 Bolt,		
1972-1973, 11 Bolt, Eaton 2 Speed Axle	H36329	1	Chelsea Power Take Off		
P.T.O. Cover Gasket				
1979-1980, 6 Bolt, Chelsea Power Take Off	H36080	1	Chelsea Power Take Off		
1979-1980, 8 Bolt, Chelsea Power Take Off	H36124	1		
1972-1973, 6 Bolt, Chelsea Power Take Off	H36080	1	1957-1989, .010" Thickness, 6 Bolt,		
1972-1973, 8 Bolt, Chelsea Power Take Off	H36124	1	Chelsea Power Take Off		
P.T.O. Mounting Gasket				
1979-1980, .010" Thickness, 6 Bolt,			Transmission Gasket Set		
Chelsea Power Take Off			1973-1980, A390 Transmission		
.			1969-1980, 435, 445 Transmission		
1979-1980, .020" Thickness, 6 Bolt,			Transmission Pan Gasket		
Chelsea Power Take Off			1987-1989, A904 Automatic Transmission,		
.			A998 Automatic Transmission, A999		
1979, .010" Thickness, 8 Bolt, Chelsea			Automatic Transmission		
Power Take Off		
.			1983-1989, A727 Automatic Transmission		
1972-1973, .010" Thickness, 6 Bolt,			1981-1986, A904 Automatic Transmission		
Chelsea Power Take Off			1974-1980, A904 Automatic Transmission,		
.			A998 Automatic Transmission, A999		
1972-1973, .010" Thickness, 8 Bolt,			Automatic Transmission		
Chelsea Power Take Off		
.			1963-1980, A727 Automatic Transmission		
1972-1973, .020" Thickness, 6 Bolt,			1959-1989, A727 Automatic Transmission,		
Chelsea Power Take Off			Tuff-Cork		
.		
Transmission Gasket Set			RAM D150		
1979-1980, 435, 445 Transmission			Elec. Shift Cover Gasket		
.			1974-1993, 10 Bolt, Eaton 2 Speed Axle		
1973, A390 Transmission			1974-1993, 11 Bolt, Eaton 2 Speed Axle		
.		
1972-1973, 435, 445 Transmission			P.T.O. Cover Gasket		
.			1974-1993, 6 Bolt, Chelsea Power Take Off		
Transmission Pan Gasket			1974-1993, 8 Bolt, Chelsea Power Take Off		
1979-1980, A727 Automatic Transmission		
.			P.T.O. Mounting Gasket		
1979-1980, A727 Automatic Transmission,			1974-1993, .010" Thickness, 6 Bolt,		
Tuff-Cork			Chelsea Power Take Off		
.		
1979-1980, A904 Automatic Transmission,			1974-1993, .010" Thickness, 8 Bolt,		
A998 Automatic Transmission, A999			Chelsea Power Take Off		
Automatic Transmission		
.			1974-1993, .020" Thickness, 6 Bolt,		
1972-1973			Chelsea Power Take Off		
.		
1972-1973, A727 Automatic Transmission,			1974-1993, .020" Thickness, 8 Bolt,		
Tuff-Cork			Chelsea Power Take Off		
.		
RAM CB350			Transmission Gasket Set		
Elec. Shift Cover Gasket			1978-1980, A390 Transmission		
1981, 10 Bolt, Eaton 2 Speed Axle			1974-1983, 435, 445 Transmission		
.			Transmission Pan Gasket		
1981, 11 Bolt, Eaton 2 Speed Axle			1990-1993, A500 Automatic Overdrive		
.			Transmission, A998 Automatic		
P.T.O. Cover Gasket			Transmission, A999 Automatic		
1981, 6 Bolt, Chelsea Power Take Off			Transmission		
1981, 8 Bolt, Chelsea Power Take Off		
P.T.O. Mounting Gasket				
1981, .010" Thickness, 6 Bolt, Chelsea					
Power Take Off					
.					
1981, .020" Thickness, 6 Bolt, Chelsea					
Power Take Off					
.					
Transmission Gasket Set					
1981, 435, 445 Transmission					
.					

LIGHT TRUCK

Transmission Gaskets (cont.)

<i>Model & Application</i>	<i>Part No.</i>	<i>Qty.</i>	<i>Model & Application</i>	<i>Part No.</i>	<i>Qty.</i>
RAM D150 (cont.)			RAM D250 (cont.)		
Transmission Pan Gasket (cont.)			Transmission Pan Gasket (cont.)		
1990-1993, A518 Automatic Overdrive Transmission, A727 Automatic Transmission	W39003	1	1990-1993, A518 Automatic Overdrive Transmission, A727 Automatic Transmission	W39003	1
1990-1993, A518 Automatic Overdrive Transmission, A727 Automatic Transmission, Tuff-Cork	W39003TC	1	1990-1993, A518 Automatic Overdrive Transmission, A727 Automatic Transmission, Tuff-Cork	W39003TC	1
1974-1989, A727 Automatic Transmission	W39003	1	1981-1989, A727 Automatic Transmission	W39003	1
1974-1989, A727 Automatic Transmission, Tuff-Cork	W39003TC	1	1981-1989, A727 Automatic Transmission, Tuff-Cork	W39003TC	1
1974-1989, A904 Automatic Transmission, A998 Automatic Transmission, A999 Automatic Transmission	W38031	1	1981-1989, A904 Automatic Transmission, A998 Automatic Transmission, A999 Automatic Transmission	W38031	1
RAM D200			RAM D300		
Elec. Shift Cover Gasket			Elec. Shift Cover Gasket		
1957-1980, 10 Bolt, Eaton 2 Speed Axle	H36328	1	1961-1980, 10 Bolt, Eaton 2 Speed Axle	H36328	1
1957-1980, 11 Bolt, Eaton 2 Speed Axle	H36329	1	1961-1980, 11 Bolt, Eaton 2 Speed Axle	H36329	1
P.T.O. Cover Gasket			P.T.O. Cover Gasket		
1957-1980, 6 Bolt, Chelsea Power Take Off	H36080	1	1961-1980, 6 Bolt, Chelsea Power Take Off	H36080	1
1957-1980, 8 Bolt, Chelsea Power Take Off	H36124	1	1961-1980, 8 Bolt, Chelsea Power Take Off	H36124	1
P.T.O. Mounting Gasket			P.T.O. Mounting Gasket		
1959-1980, .010" Thickness, 8 Bolt, Chelsea Power Take Off	H26207	1	1961-1980, .010" Thickness, 6 Bolt, Chelsea Power Take Off	H26205	1
1959-1980, .020" Thickness, 8 Bolt, Chelsea Power Take Off	H26208	1	1961-1980, .010" Thickness, 8 Bolt, Chelsea Power Take Off	H26207	1
1957-1980, .010" Thickness, 6 Bolt, Chelsea Power Take Off	H26205	1	1961-1980, .020" Thickness, 6 Bolt, Chelsea Power Take Off	H26206	1
1957-1980, .020" Thickness, 6 Bolt, Chelsea Power Take Off	H26206	1	Transmission Gasket Set		
Transmission Gasket Set			1969-1980, 435, 445 Transmission		
1978-1980, A390 Transmission	TS29047	1	Transmission Pan Gasket		
1969-1980, 435, 445 Transmission	TS26390X	1	1974-1980, A904 Automatic Transmission, A998 Automatic Transmission, A999 Automatic Transmission		
Transmission Pan Gasket			1963-1980, A727 Automatic Transmission		
1974-1980, A904 Automatic Transmission, A998 Automatic Transmission, A999 Automatic Transmission	W38031	1	1961-1980, A727 Automatic Transmission, Tuff-Cork		
1959-1980, A727 Automatic Transmission	W39003	1	RAM D350		
1959-1980, A727 Automatic Transmission, Tuff-Cork	W39003TC	1	Elec. Shift Cover Gasket		
RAM D250			1981-1993, 10 Bolt, Eaton 2 Speed Axle		
Elec. Shift Cover Gasket			1981-1993, 11 Bolt, Eaton 2 Speed Axle		
1981-1993, 10 Bolt, Eaton 2 Speed Axle	H36328	1	P.T.O. Cover Gasket		
1981-1993, 11 Bolt, Eaton 2 Speed Axle	H36329	1	1981-1993, 6 Bolt, Chelsea Power Take Off		
P.T.O. Cover Gasket			1981-1993, 8 Bolt, Chelsea Power Take Off		
1981-1993, 6 Bolt, Chelsea Power Take Off	H36080	1	P.T.O. Mounting Gasket		
1981-1993, 8 Bolt, Chelsea Power Take Off	H36124	1	1981-1993, .010" Thickness, 6 Bolt, Chelsea Power Take Off		
P.T.O. Mounting Gasket			1981-1993, .010" Thickness, 8 Bolt, Chelsea Power Take Off		
1981-1993, .010" Thickness, 6 Bolt, Chelsea Power Take Off	H26205	1	1981-1993, .020" Thickness, 6 Bolt, Chelsea Power Take Off		
1981-1993, .010" Thickness, 8 Bolt, Chelsea Power Take Off	H26207	1	1981-1993, .020" Thickness, 8 Bolt, Chelsea Power Take Off		
1981-1993, .020" Thickness, 6 Bolt, Chelsea Power Take Off	H26206	1	Transmission Gasket Set		
1981-1993, .020" Thickness, 8 Bolt, Chelsea Power Take Off	H26208	1	1981-1983, 435, 445 Transmission		
Transmission Gasket Set			Transmission Pan Gasket		
1981-1983, 435, 445 Transmission	TS26390X	1	1990-1993, A500 Automatic Overdrive Transmission, A998 Automatic Transmission		
Transmission Pan Gasket			1990-1993, A518 Automatic Overdrive Transmission, A727 Automatic Transmission		
1990-1993, A500 Automatic Overdrive Transmission, A998 Automatic Transmission, A999 Automatic Transmission	W38031	1	1990-1993, A518 Automatic Overdrive Transmission		
1990-1993, A518 Automatic Overdrive Transmission, A727 Automatic Transmission	W39003	1			

Dodge Truck (cont.)

Transmission Gaskets (cont.)

<i>Model & Application</i>	<i>Part No.</i>	<i>Qty.</i>	<i>Model & Application</i>	<i>Part No.</i>	<i>Qty.</i>
RAM D350 (cont.)			RAM MBL300 (cont.)		
Transmission Pan Gasket (cont.)			P.T.O. Cover Gasket (cont.)		
1990-1993, A518 Automatic Overdrive Transmission, A727 Automatic Transmission, Tuff-Cork	W39003TC	1	1974-1978, 8 Bolt, Chelsea Power Take Off	H36124	1
1981-1989, A727 Automatic Transmission	W39003	1	P.T.O. Mounting Gasket		
1981-1989, A727 Automatic Transmission, Tuff-Cork	W39003TC	1	1974-1978, .010" Thickness, 6 Bolt, Chelsea Power Take Off	H26205	1
1981-1989, A904 Automatic Transmission, A998 Automatic Transmission, A999 Automatic Transmission	W38031	1	1974-1978, .020" Thickness, 6 Bolt, Chelsea Power Take Off	H26206	1
RAM D50			Transmission Gasket Set		
Transmission Pan Gasket			1974-1978, 435, 445 Transmission		
1979, A904 Automatic Transmission	W38031	1	Transmission Pan Gasket		
RAM MB300			1974-1978, A727 Automatic Transmission		
Elec. Shift Cover Gasket			1974-1978, A727 Automatic Transmission, Tuff-Cork		
1979-1980, 10 Bolt, Eaton 2 Speed Axle	H36328	1	1974-1978, A904 Automatic Transmission, A998 Automatic Transmission, A999 Automatic Transmission		
1979-1980, 11 Bolt, Eaton 2 Speed Axle	H36329	1	W38031		
P.T.O. Cover Gasket			RAM MBL350		
1979-1980, 6 Bolt, Chelsea Power Take Off	H36080	1	Elec. Shift Cover Gasket		
1979-1980, 8 Bolt, Chelsea Power Take Off	H36124	1	1981, 10 Bolt, Eaton 2 Speed Axle		
P.T.O. Mounting Gasket			1981, 11 Bolt, Eaton 2 Speed Axle		
1979-1980, .010" Thickness, 6 Bolt, Chelsea Power Take Off	H26205	1	P.T.O. Cover Gasket		
1979-1980, .020" Thickness, 6 Bolt, Chelsea Power Take Off	H26206	1	1981, 6 Bolt, Chelsea Power Take Off		
Transmission Gasket Set			1981, 8 Bolt, Chelsea Power Take Off		
1979-1980, 435, 445 Transmission	TS26390X	1	P.T.O. Mounting Gasket		
Transmission Pan Gasket			1981, .010" Thickness, 6 Bolt, Chelsea Power Take Off		
1979-1980, A727 Automatic Transmission	W39003	1	1981, .020" Thickness, 6 Bolt, Chelsea Power Take Off		
1979-1980, A727 Automatic Transmission, Tuff-Cork	W39003TC	1	Transmission Gasket Set		
1979-1980, A904 Automatic Transmission, A998 Automatic Transmission, A999 Automatic Transmission	W38031	1	1981, 435, 445 Transmission		
RAM MBH350			Transmission Pan Gasket		
Elec. Shift Cover Gasket			1981, A727 Automatic Transmission		
1981, 10 Bolt, Eaton 2 Speed Axle	H36328	1	1981, A727 Automatic Transmission, Tuff-Cork		
1981, 11 Bolt, Eaton 2 Speed Axle	H36329	1	1981, A904 Automatic Transmission, A998 Automatic Transmission, A999 Automatic Transmission		
P.T.O. Cover Gasket			RAM RD200		
1981, 6 Bolt, Chelsea Power Take Off	H36080	1	Elec. Shift Cover Gasket		
1981, 8 Bolt, Chelsea Power Take Off	H36124	1	1974-1978, 10 Bolt, Eaton 2 Speed Axle		
P.T.O. Mounting Gasket			1974-1978, 11 Bolt, Eaton 2 Speed Axle		
1981, .010" Thickness, 6 Bolt, Chelsea Power Take Off	H26205	1	P.T.O. Cover Gasket		
1981, .020" Thickness, 6 Bolt, Chelsea Power Take Off	H26206	1	1974-1978, 6 Bolt, Chelsea Power Take Off		
Transmission Gasket Set			1974-1978, 8 Bolt, Chelsea Power Take Off		
1981, 435, 445 Transmission	TS26390X	1	P.T.O. Mounting Gasket		
Transmission Pan Gasket			1974-1978, .010" Thickness, 6 Bolt, Chelsea Power Take Off		
1981, A727 Automatic Transmission	W39003	1	1974-1978, .010" Thickness, 8 Bolt, Chelsea Power Take Off		
1981, A727 Automatic Transmission, Tuff-Cork	W39003TC	1	1974-1978, .020" Thickness, 6 Bolt, Chelsea Power Take Off		
1981, A904 Automatic Transmission, A998 Automatic Transmission, A999 Automatic Transmission	W38031	1	Transmission Gasket Set		
RAM MBL300			1974-1978, 435, 445 Transmission		
Elec. Shift Cover Gasket			Transmission Pan Gasket		
1974-1978, 10 Bolt, Eaton 2 Speed Axle	H36328	1	1974-1978, A727 Automatic Transmission		
1974-1978, 11 Bolt, Eaton 2 Speed Axle	H36329	1	1974-1978, A727 Automatic Transmission, Tuff-Cork		
P.T.O. Cover Gasket			1974-1978, A904 Automatic Transmission, A998 Automatic Transmission, A999 Automatic Transmission		
1974-1978, 6 Bolt, Chelsea Power Take Off	H36080	1	W38031		

LIGHT TRUCK

Transmission Gaskets (cont.)

<i>Model & Application</i>	<i>Part No.</i>	<i>Qty.</i>	<i>Model & Application</i>	<i>Part No.</i>	<i>Qty.</i>
RAM VAN 1500			RAM VAN 3500 (cont.)		
P.T.O. Cover Gasket			P.T.O. Mounting Gasket		
1994-1998, 6 Bolt, Chelsea Power Take Off	H36080	1	1994-1998, .010" Thickness, 6 Bolt, Chelsea Power Take Off	H26205	1
1994-1998, 8 Bolt, Chelsea Power Take Off	H36124	1	1994-1998, .010" Thickness, 8 Bolt, Chelsea Power Take Off	H26207	1
P.T.O. Mounting Gasket			1994-1998, .020" Thickness, 6 Bolt, Chelsea Power Take Off		
1994-1998, .010" Thickness, 6 Bolt, Chelsea Power Take Off	H26205	1		H26206	1
1994-1998, .010" Thickness, 8 Bolt, Chelsea Power Take Off	H26207	1	Transmission Pan Gasket		
1994-1998, .020" Thickness, 6 Bolt, Chelsea Power Take Off	H26206	1	1997-2001, 46RE Automatic Overdrive Transmission		
Transmission Pan Gasket			1997-2001, 46RE Automatic Overdrive Transmission, Tuff-Cork		
1997-2001, 46RE Automatic Overdrive Transmission	W39003	1	1997-1999, 36RH Automatic Transmission, 46RE Automatic Overdrive Transmission		
1997-2001, 46RE Automatic Overdrive Transmission, Tuff-Cork	W39003TC	1	1997-1999, 36RH Automatic Transmission, 46RE Automatic Overdrive Transmission, Tuff-Cork		
1997-1999, 36RH Automatic Transmission, 46RE Automatic Overdrive Transmission	W39003	1	1994-1996, 36RH Automatic Transmission, 46RH Automatic Overdrive Transmission		
1997-1999, 36RH Automatic Transmission, 46RE Automatic Overdrive Transmission, Tuff-Cork	W39003TC	1	1994-1996, 36RH Automatic Transmission, 46RH Automatic Overdrive Transmission, Tuff-Cork		
1994-2001, 32RH Automatic Transmission	W38031	1			
1994-1996, 36RH Automatic Transmission, 46RH Automatic Overdrive Transmission	W39003	1	RAM VAN B100		
1994-1996, 36RH Automatic Transmission, 46RH Automatic Overdrive Transmission, Tuff-Cork	W39003TC	1	P.T.O. Cover Gasket		
1994-2001, 32RH Automatic Transmission	W38031	1	1972-1980, 6 Bolt, Chelsea Power Take Off		
1994-1996, 36RH Automatic Transmission, 46RH Automatic Overdrive Transmission	W39003	1	1972-1980, 8 Bolt, Chelsea Power Take Off		
1994-1996, 36RH Automatic Transmission, 46RH Automatic Overdrive Transmission, Tuff-Cork	W39003TC	1			
			P.T.O. Mounting Gasket		
RAM VAN 2500			1972-1980, .010" Thickness, 6 Bolt, Chelsea Power Take Off		
Elec. Shift Cover Gasket			1972-1980, .010" Thickness, 8 Bolt, Chelsea Power Take Off		
1994-1998, 10 Bolt, Eaton 2 Speed Axle	H36328	1	1972-1980, .020" Thickness, 6 Bolt, Chelsea Power Take Off		
1994-1998, 11 Bolt, Eaton 2 Speed Axle	H36329	1			
P.T.O. Cover Gasket			Transmission Gasket Set		
1994-1998, 6 Bolt, Chelsea Power Take Off	H36080	1	1978-1980, A390 Transmission		
1994-1998, 8 Bolt, Chelsea Power Take Off	H36124	1	1972-1980, 435, 445 Transmission		
P.T.O. Mounting Gasket			Transmission Pan Gasket		
1994-1998, .010" Thickness, 6 Bolt, Chelsea Power Take Off	H26205	1	1974-1980, A904 Automatic Transmission, A998 Automatic Transmission, A999 Automatic Transmission		
1994-1998, .010" Thickness, 8 Bolt, Chelsea Power Take Off	H26207	1	1972-1980, A727 Automatic Transmission		
1994-1998, .020" Thickness, 6 Bolt, Chelsea Power Take Off	H26206	1	1972-1980, A727 Automatic Transmission, Tuff-Cork		
Transmission Pan Gasket					
1997-2001, 46RE Automatic Overdrive Transmission	W39003	1	RAM VAN B150		
1997-2001, 46RE Automatic Overdrive Transmission, Tuff-Cork	W39003TC	1	Elec. Shift Cover Gasket		
1997-1999, 36RH Automatic Transmission, 46RE Automatic Overdrive Transmission	W39003	1	1992-1993, 10 Bolt, Eaton 2 Speed Axle		
1997-1999, 36RH Automatic Transmission, 46RE Automatic Overdrive Transmission, Tuff-Cork	W39003TC	1	1992-1993, 11 Bolt, Eaton 2 Speed Axle		
1994-1996, 32RH Automatic Transmission	W38031	1	1981, 10 Bolt, Eaton 2 Speed Axle		
1994-1996, 36RH Automatic Transmission, 46RH Automatic Overdrive Transmission	W39003	1	1981, 11 Bolt, Eaton 2 Speed Axle		
1994-1996, 36RH Automatic Transmission, 46RH Automatic Overdrive Transmission, Tuff-Cork	W39003TC	1			
			P.T.O. Cover Gasket		
RAM VAN 3500			1981-1993, 6 Bolt, Chelsea Power Take Off		
Elec. Shift Cover Gasket			1981-1993, 8 Bolt, Chelsea Power Take Off		
1994-1998, 10 Bolt, Eaton 2 Speed Axle	H36328	1	P.T.O. Mounting Gasket		
1994-1998, 11 Bolt, Eaton 2 Speed Axle	H36329	1	1981-1993, .010" Thickness, 6 Bolt, Chelsea Power Take Off		
P.T.O. Cover Gasket			1981-1993, .010" Thickness, 8 Bolt, Chelsea Power Take Off		
1994-1998, 6 Bolt, Chelsea Power Take Off	H36080	1	1981-1993, .020" Thickness, 6 Bolt, Chelsea Power Take Off		
1994-1998, 8 Bolt, Chelsea Power Take Off	H36124	1	1981-1993, .020" Thickness, 8 Bolt, Chelsea Power Take Off		
			Transmission Gasket Set		
			1981-1983, 435, 445 Transmission		

Transmission Gaskets (cont.)

<i>Model & Application</i>	<i>Part No.</i>	<i>Qty.</i>	<i>Model & Application</i>	<i>Part No.</i>	<i>Qty.</i>
RAM VAN B350 (cont.)			RAM W150 (cont.)		
Transmission Pan Gasket (cont.)			P.T.O. Mounting Gasket		
1989-1993, A518 Automatic Overdrive Transmission, A727 Automatic Transmission	W39003	1	1978-1993, .010" Thickness, 6 Bolt, Chelsea Power Take Off	H26205	1
1989-1993, A518 Automatic Overdrive Transmission, A727 Automatic Transmission, Tuff-Cork	W39003TC	1	1978-1993, .010" Thickness, 8 Bolt, Chelsea Power Take Off	H26207	1
1981-1989, A727 Automatic Transmission	W39003	1	1978-1993, .020" Thickness, 6 Bolt, Chelsea Power Take Off	H26206	1
1981-1989, A727 Automatic Transmission, Tuff-Cork	W39003TC	1	1978-1993, .020" Thickness, 8 Bolt, Chelsea Power Take Off	H26208	1
1981-1989, A904 Automatic Transmission, A998 Automatic Transmission, A999 Automatic Transmission	W38031	1	Transmission Gasket Set		
			1978-1983, 435, 445 Transmission	TS26390X	1
			1978-1980, A390 Transmission	TS29047	1
RAM W100			Transmission Pan Gasket		
Elec. Shift Cover Gasket			1990-1993, A500 Automatic Overdrive Transmission, A998 Automatic Transmission, A999 Automatic Transmission		
1981-1989, 10 Bolt, Eaton 2 Speed Axle	H36328	1		W38031	1
1981-1989, 11 Bolt, Eaton 2 Speed Axle	H36329	1	1990-1993, A518 Automatic Overdrive Transmission, A727 Automatic Transmission		
1957-1973, 10 Bolt, Eaton 2 Speed Axle	H36328	1		W39003	1
1957-1973, 11 Bolt, Eaton 2 Speed Axle	H36329	1	1990-1993, A518 Automatic Overdrive Transmission, A727 Automatic Transmission, Tuff-Cork		
P.T.O. Cover Gasket				W39003TC	1
1981-1989, 6 Bolt, Chelsea Power Take Off	H36080	1	1978-1989, A727 Automatic Transmission		
1981-1989, 8 Bolt, Chelsea Power Take Off	H36124	1		W39003	1
1957-1973, 6 Bolt, Chelsea Power Take Off	H36080	1	1978-1989, A727 Automatic Transmission, Tuff-Cork		
1957-1973, 8 Bolt, Chelsea Power Take Off	H36124	1		W39003TC	1
P.T.O. Mounting Gasket			1978-1989, A904 Automatic Transmission, A998 Automatic Transmission, A999 Automatic Transmission		
1981-1989, .010" Thickness, 6 Bolt, Chelsea Power Take Off	H26205	1		W38031	1
1981-1989, .010" Thickness, 8 Bolt, Chelsea Power Take Off	H26207	1	RAM W200		
1981-1989, .020" Thickness, 6 Bolt, Chelsea Power Take Off	H26206	1	Elec. Shift Cover Gasket		
1981-1989, .020" Thickness, 8 Bolt, Chelsea Power Take Off	H26208	1	1957-1980, 10 Bolt, Eaton 2 Speed Axle	H36328	1
1959-1973, .010" Thickness, 8 Bolt, Chelsea Power Take Off	H26207	1	1957-1980, 11 Bolt, Eaton 2 Speed Axle	H36329	1
1959-1973, .020" Thickness, 8 Bolt, Chelsea Power Take Off	H26208	1	P.T.O. Cover Gasket		
1957-1973, .010" Thickness, 6 Bolt, Chelsea Power Take Off	H26205	1	1957-1980, 6 Bolt, Chelsea Power Take Off	H36080	1
1957-1973, .020" Thickness, 6 Bolt, Chelsea Power Take Off	H26206	1	1957-1980, 8 Bolt, Chelsea Power Take Off	H36124	1
Transmission Gasket Set			P.T.O. Mounting Gasket		
1973, A390 Transmission	TS29047	1	1959-1980, .010" Thickness, 8 Bolt, Chelsea Power Take Off	H26207	1
1969-1973, 435, 445 Transmission	TS26390X	1	1957-1980, .010" Thickness, 6 Bolt, Chelsea Power Take Off	H26205	1
Transmission Pan Gasket			1957-1980, .020" Thickness, 6 Bolt, Chelsea Power Take Off	H26206	1
1987-1989, A904 Automatic Transmission, A998 Automatic Transmission, A999 Automatic Transmission	W38031	1	Transmission Gasket Set		
1984-1989, A727 Automatic Transmission	W39003	1	1978, A390 Transmission	TS29047	1
1981-1989, A727 Automatic Transmission, Tuff-Cork	W39003TC	1	1969-1980, 435, 445 Transmission	TS26390X	1
1981-1986, A904 Automatic Transmission	W38031	1	Transmission Pan Gasket		
1963-1973, A727 Automatic Transmission	W39003	1	1974-1980, A904 Automatic Transmission, A998 Automatic Transmission, A999 Automatic Transmission		
1959-1973, A727 Automatic Transmission, Tuff-Cork	W39003TC	1		W38031	1
			1963-1980, A727 Automatic Transmission	W39003	1
			1959-1980, A727 Automatic Transmission, Tuff-Cork	W39003TC	1
RAM W150			RAM W250		
Elec. Shift Cover Gasket			Elec. Shift Cover Gasket		
1978-1993, 10 Bolt, Eaton 2 Speed Axle	H36328	1	1983-1993, 10 Bolt, Eaton 2 Speed Axle	H36328	1
1978-1993, 11 Bolt, Eaton 2 Speed Axle	H36329	1	1983-1993, 11 Bolt, Eaton 2 Speed Axle	H36329	1
P.T.O. Cover Gasket			P.T.O. Cover Gasket		
1978-1993, 6 Bolt, Chelsea Power Take Off	H36080	1	1983-1993, 6 Bolt, Chelsea Power Take Off	H36080	1
1978-1993, 8 Bolt, Chelsea Power Take Off	H36124	1	1983-1993, 8 Bolt, Chelsea Power Take Off	H36124	1
P.T.O. Mounting Gasket			P.T.O. Mounting Gasket		
			1988-1993, .020" Thickness, 8 Bolt, Chelsea Power Take Off	H26208	1

Dodge Truck (cont.)

Transmission Gaskets (cont.)

<i>Model & Application</i>	<i>Part No.</i>	<i>Qty.</i>	<i>Model & Application</i>	<i>Part No.</i>	<i>Qty.</i>
RAM W250 (cont.)			RAM W350 (cont.)		
P.T.O. Mounting Gasket (cont.)			P.T.O. Mounting Gasket (cont.)		
1983-1993, .010" Thickness, 6 Bolt, Chelsea Power Take Off	H26205	1	1983-1993, .020" Thickness, 6 Bolt, Chelsea Power Take Off	H26206	1
1983-1993, .010" Thickness, 8 Bolt, Chelsea Power Take Off	H26207	1	1983-1993, .020" Thickness, 8 Bolt, Chelsea Power Take Off	H26208	1
1983-1993, .020" Thickness, 6 Bolt, Chelsea Power Take Off	H26206	1	Transmission Gasket Set		
1983, .020" Thickness, 8 Bolt, Chelsea Power Take Off	H26208	1	1983, 435, 445 Transmission	TS26390X	1
Transmission Gasket Set			Transmission Pan Gasket		
1983, 435, 445 Transmission	TS26390X	1	1990-1993, A500 Automatic Overdrive Transmission, A998 Automatic Transmission, A999 Automatic Transmission	W38031	1
Transmission Pan Gasket			1990-1993, A518 Automatic Overdrive Transmission, A727 Automatic Transmission	W39003	1
1990-1993, A500 Automatic Overdrive Transmission, A998 Automatic Transmission, A999 Automatic Transmission	W38031	1	1990-1993, A518 Automatic Overdrive Transmission, A727 Automatic Transmission, Tuff-Cork	W39003TC	1
1990-1993, A518 Automatic Overdrive Transmission, A727 Automatic Transmission	W39003	1	1983-1989, A727 Automatic Transmission	W39003	1
1990-1993, A518 Automatic Overdrive Transmission, A727 Automatic Transmission, Tuff-Cork	W39003TC	1	1983-1989, A727 Automatic Transmission, Tuff-Cork	W39003TC	1
1983-1989, A727 Automatic Transmission	W39003	1	1983-1989, A904 Automatic Transmission, A998 Automatic Transmission, A999 Automatic Transmission	W38031	1
1983-1989, A727 Automatic Transmission, Tuff-Cork	W39003TC	1	RAM WAGON 1500		
1983-1989, A904 Automatic Transmission, A998 Automatic Transmission, A999 Automatic Transmission	W38031	1	Elec. Shift Cover Gasket		
RAM W300			1994-1998, 10 Bolt, Eaton 2 Speed Axle	H36328	1
Elec. Shift Cover Gasket			1994-1998, 11 Bolt, Eaton 2 Speed Axle	H36329	1
1957-1980, 10 Bolt, Eaton 2 Speed Axle	H36328	1	P.T.O. Cover Gasket		
1957-1980, 11 Bolt, Eaton 2 Speed Axle	H36329	1	1994-1998, 6 Bolt, Chelsea Power Take Off	H36080	1
P.T.O. Cover Gasket			1994-1998, 8 Bolt, Chelsea Power Take Off	H36124	1
1957-1980, 6 Bolt, Chelsea Power Take Off	H36080	1	P.T.O. Mounting Gasket		
1957-1980, 8 Bolt, Chelsea Power Take Off	H36124	1	1994-1998, .010" Thickness, 6 Bolt, Chelsea Power Take Off	H26205	1
P.T.O. Mounting Gasket			1994-1998, .010" Thickness, 8 Bolt, Chelsea Power Take Off	H26207	1
1959-1980, .010" Thickness, 8 Bolt, Chelsea Power Take Off	H26207	1	1994-1998, .020" Thickness, 6 Bolt, Chelsea Power Take Off	H26206	1
1957-1980, .010" Thickness, 6 Bolt, Chelsea Power Take Off	H26205	1	Transmission Pan Gasket		
1957-1980, .020" Thickness, 6 Bolt, Chelsea Power Take Off	H26206	1	2000-2001, 46RE Automatic Overdrive Transmission	W39003	1
Transmission Gasket Set			2000-2001, 46RE Automatic Overdrive Transmission, Tuff-Cork	W39003TC	1
1969-1980, 435, 445 Transmission	TS26390X	1	1997-1999, 36RH Automatic Transmission, 46RE Automatic Overdrive Transmission	W39003	1
Transmission Pan Gasket			1997-1999, 36RH Automatic Transmission, 46RE Automatic Overdrive Transmission, Tuff-Cork	W39003TC	1
1974-1980, A904 Automatic Transmission, A998 Automatic Transmission, A999 Automatic Transmission	W38031	1	1994-2001, 32RH Automatic Transmission	W38031	1
1963-1980, A727 Automatic Transmission	W39003	1	1994-1996, 36RH Automatic Transmission, 46RH Automatic Overdrive Transmission	W39003	1
1959-1980, A727 Automatic Transmission, Tuff-Cork	W39003TC	1	1994-1996, 36RH Automatic Transmission, 46RH Automatic Overdrive Transmission, Tuff-Cork	W39003TC	1
RAM W350			RAM WAGON 2500		
Elec. Shift Cover Gasket			Elec. Shift Cover Gasket		
1983-1993, 10 Bolt, Eaton 2 Speed Axle	H36328	1	1994-1998, 10 Bolt, Eaton 2 Speed Axle	H36328	1
1983-1993, 11 Bolt, Eaton 2 Speed Axle	H36329	1	1994-1998, 11 Bolt, Eaton 2 Speed Axle	H36329	1
P.T.O. Cover Gasket			P.T.O. Cover Gasket		
1983-1993, 6 Bolt, Chelsea Power Take Off	H36080	1	1994-1998, 6 Bolt, Chelsea Power Take Off	H36080	1
1983-1993, 8 Bolt, Chelsea Power Take Off	H36124	1	1994-1998, 8 Bolt, Chelsea Power Take Off	H36124	1
P.T.O. Mounting Gasket			P.T.O. Mounting Gasket		
1983-1993, .010" Thickness, 6 Bolt, Chelsea Power Take Off	H26205	1	1994-1998, .010" Thickness, 6 Bolt, Chelsea Power Take Off	H26205	1
1983-1993, .010" Thickness, 8 Bolt, Chelsea Power Take Off	H26207	1			

LIGHT TRUCK

Transmission Gaskets (cont.)

<i>Model & Application</i>	<i>Part No.</i>	<i>Qty.</i>	<i>Model & Application</i>	<i>Part No.</i>	<i>Qty.</i>
RAM WAGON 2500 (cont.)			RAM WAGON B100 (cont.)		
P.T.O. Mounting Gasket (cont.)			P.T.O. Mounting Gasket (cont.)		
1994-1998, .010" Thickness, 8 Bolt, Chelsea Power Take Off	H26207	1	1974-1979, .010" Thickness, 8 Bolt, Chelsea Power Take Off	H26207	1
1994-1998, .020" Thickness, 6 Bolt, Chelsea Power Take Off	H26206	1	1974-1979, .020" Thickness, 6 Bolt, Chelsea Power Take Off	H26206	1
Transmission Pan Gasket			Transmission Pan Gasket		
1997-2001, 46RE Automatic Overdrive Transmission.	W39003	1	1971, .010" Thickness, 6 Bolt, Chelsea Power Take Off.	H26205	1
1997-2001, 46RE Automatic Overdrive Transmission, Tuff-Cork.	W39003TC	1	1971, .010" Thickness, 8 Bolt, Chelsea Power Take Off.	H26207	1
1997-1999, 36RH Automatic Transmission, 46RE Automatic Overdrive Transmission.	W39003	1	1971, .020" Thickness, 6 Bolt, Chelsea Power Take Off.	H26206	1
1997-1999, 36RH Automatic Transmission, 46RE Automatic Overdrive Transmission, Tuff-Cork	W39003TC	1	Transmission Gasket Set		
1994-1996, 32RH Automatic Transmission	W38031	1	1978-1979, A390 Transmission	TS29047	1
1994-1996, 36RH Automatic Transmission, 46RH Automatic Overdrive Transmission	W39003	1	1974-1979, 435, 445 Transmission	TS26390X	1
1994-1996, 36RH Automatic Transmission, 46RH Automatic Overdrive Transmission, Tuff-Cork	W39003TC	1	1971, 435, 445 Transmission	TS26390X	1
RAM WAGON 3500			Transmission Pan Gasket		
Elec. Shift Cover Gasket			1974-1979, A727 Automatic Transmission		
1994-1998, 10 Bolt, Eaton 2 Speed Axle	H36328	1	1974-1979, A727 Automatic Transmission, Tuff-Cork	W39003TC	1
1994-1998, 11 Bolt, Eaton 2 Speed Axle	H36329	1	1974-1979, A904 Automatic Transmission, A998 Automatic Transmission, A999 Automatic Transmission		
P.T.O. Cover Gasket			1971		
1994-1998, 6 Bolt, Chelsea Power Take Off	H36080	1	1971, Tuff-Cork		
1994-1998, 8 Bolt, Chelsea Power Take Off	H36124	1	RAM WAGON B150		
P.T.O. Mounting Gasket			Elec. Shift Cover Gasket		
1994-1998, .010" Thickness, 6 Bolt, Chelsea Power Take Off	H26205	1	1981-1993, 10 Bolt, Eaton 2 Speed Axle	H36328	1
1994-1998, .010" Thickness, 8 Bolt, Chelsea Power Take Off	H26207	1	1981-1993, 11 Bolt, Eaton 2 Speed Axle	H36329	1
1994-1998, .020" Thickness, 6 Bolt, Chelsea Power Take Off	H26206	1	P.T.O. Cover Gasket		
Transmission Pan Gasket			1981-1993, 6 Bolt, Chelsea Power Take Off		
1997-2001, 46RE Automatic Overdrive Transmission.	W39003	1	1981-1993, 8 Bolt, Chelsea Power Take Off	H36124	1
1997-2001, 46RE Automatic Overdrive Transmission, Tuff-Cork.	W39003TC	1	P.T.O. Mounting Gasket		
1997-1999, 36RH Automatic Transmission, 46RE Automatic Overdrive Transmission.	W39003	1	1981-1993, .010" Thickness, 6 Bolt, Chelsea Power Take Off	H26205	1
1997-1999, 36RH Automatic Transmission, 46RE Automatic Overdrive Transmission, Tuff-Cork	W39003TC	1	1981-1993, .010" Thickness, 8 Bolt, Chelsea Power Take Off	H26207	1
1994-1996, 36RH Automatic Transmission, 46RH Automatic Overdrive Transmission	W39003	1	1981-1993, .020" Thickness, 6 Bolt, Chelsea Power Take Off	H26206	1
1994-1996, 36RH Automatic Transmission, 46RH Automatic Overdrive Transmission, Tuff-Cork	W39003TC	1	1981-1993, .020" Thickness, 8 Bolt, Chelsea Power Take Off	H26208	1
RAM WAGON B100			Transmission Gasket Set		
Elec. Shift Cover Gasket			1983, 435, 445 Transmission		
1974-1979, 10 Bolt, Eaton 2 Speed Axle	H36328	1	Transmission Pan Gasket		
1974-1979, 11 Bolt, Eaton 2 Speed Axle	H36329	1	1990-1993, A500 Automatic Overdrive Transmission, A998 Automatic Transmission, A999 Automatic Transmission.		
1971, 10 Bolt, Eaton 2 Speed Axle	H36328	1	1990-1993, A518 Automatic Overdrive Transmission, A727 Automatic Transmission.		
1971, 11 Bolt, Eaton 2 Speed Axle	H36329	1	1990-1993, A518 Automatic Overdrive Transmission, A727 Automatic Transmission, Tuff-Cork.		
P.T.O. Cover Gasket			1983-1989, A727 Automatic Transmission		
1974-1979, 6 Bolt, Chelsea Power Take Off	H36080	1	1983-1989, A727 Automatic Transmission, Tuff-Cork	W39003TC	1
1974-1979, 8 Bolt, Chelsea Power Take Off	H36124	1	1983-1989, A904 Automatic Transmission, A998 Automatic Transmission, A999 Automatic Transmission	W39003	1
1971, 6 Bolt, Chelsea Power Take Off	H36080	1	RAM WAGON B200		
1971, 8 Bolt, Chelsea Power Take Off	H36124	1	Elec. Shift Cover Gasket		
P.T.O. Mounting Gasket			1971-1980, 10 Bolt, Eaton 2 Speed Axle		
1974-1979, .010" Thickness, 6 Bolt, Chelsea Power Take Off	H26205	1	1971-1980, 11 Bolt, Eaton 2 Speed Axle	H36329	1

Dodge Truck (cont.)

Transmission Gaskets (cont.)

<i>Model & Application</i>	<i>Part No.</i>	<i>Qty.</i>	<i>Model & Application</i>	<i>Part No.</i>	<i>Qty.</i>
RAM WAGON B200 (cont.)			RAM WAGON B300 (cont.)		
P.T.O. Cover Gasket			P.T.O. Mounting Gasket		
1971-1980, 6 Bolt, Chelsea Power Take Off	H36080	1	1971-1980, .010" Thickness, 6 Bolt, Chelsea Power Take Off	H26205	1
1971-1980, 8 Bolt, Chelsea Power Take Off	H36124	1	1971-1980, .020" Thickness, 6 Bolt, Chelsea Power Take Off	H26206	1
P.T.O. Mounting Gasket			1971-1980, .020" Thickness, 8 Bolt, Chelsea Power Take Off	H26208	1
1971-1980, .010" Thickness, 6 Bolt, Chelsea Power Take Off	H26205	1	Transmission Gasket Set		
1971-1980, .010" Thickness, 8 Bolt, Chelsea Power Take Off	H26207	1	1973, A390 Transmission	TS29047	1
1971-1980, .020" Thickness, 6 Bolt, Chelsea Power Take Off	H26206	1	1971-1980, 435, 445 Transmission	TS26390X	1
Transmission Gasket Set			Transmission Pan Gasket		
1978, A390 Transmission	TS29047	1	1974-1980, A727 Automatic Transmission, Tuff-Cork	W39003TC	1
1971-1980, 435, 445 Transmission	TS26390X	1	1974-1980, A904 Automatic Transmission, A998 Automatic Transmission, A999 Automatic Transmission	W38031	1
Transmission Pan Gasket			1973-1980, A727 Automatic Transmission	W39003	1
1974-1980, A904 Automatic Transmission, A998 Automatic Transmission, A999 Automatic Transmission	W38031	1	1971-1973	W39003	1
1971-1980, A727 Automatic Transmission	W39003	1	1971-1973, Tuff-Cork	W39003TC	1
1971-1980, A727 Automatic Transmission, Tuff-Cork	W39003TC	1	RAM WAGON B350		
RAM WAGON B250			Elec. Shift Cover Gasket		
Elec. Shift Cover Gasket			1982-1993, 10 Bolt, Eaton 2 Speed Axle	H36328	1
1981-1993, 10 Bolt, Eaton 2 Speed Axle	H36328	1	1982-1993, 11 Bolt, Eaton 2 Speed Axle	H36329	1
1981-1993, 11 Bolt, Eaton 2 Speed Axle	H36329	1	P.T.O. Cover Gasket		
P.T.O. Cover Gasket			1982-1993, 6 Bolt, Chelsea Power Take Off	H36080	1
1981-1993, 6 Bolt, Chelsea Power Take Off	H36080	1	1982-1993, 8 Bolt, Chelsea Power Take Off	H36124	1
1981-1993, 8 Bolt, Chelsea Power Take Off	H36124	1	P.T.O. Mounting Gasket		
P.T.O. Mounting Gasket			1982-1993, .010" Thickness, 6 Bolt, Chelsea Power Take Off	H26205	1
1981-1993, .010" Thickness, 6 Bolt, Chelsea Power Take Off	H26205	1	1982-1993, .010" Thickness, 8 Bolt, Chelsea Power Take Off	H26207	1
1981-1993, .010" Thickness, 8 Bolt, Chelsea Power Take Off	H26207	1	1982-1993, .020" Thickness, 6 Bolt, Chelsea Power Take Off	H26206	1
1981-1993, .020" Thickness, 6 Bolt, Chelsea Power Take Off	H26206	1	1982-1993, .020" Thickness, 8 Bolt, Chelsea Power Take Off	H26208	1
1981-1993, .020" Thickness, 8 Bolt, Chelsea Power Take Off	H26208	1	Transmission Gasket Set		
Transmission Gasket Set			1982-1983, 435, 445 Transmission	TS26390X	1
1982-1983, 435, 445 Transmission	TS26390X	1	Transmission Pan Gasket		
Transmission Pan Gasket			1990-1993, A500 Automatic Overdrive Transmission, A998 Automatic Transmission, A999 Automatic Transmission	W38031	1
1990-1993, A500 Automatic Overdrive Transmission, A998 Automatic Transmission, A999 Automatic Transmission	W38031	1	1990-1993, A518 Automatic Overdrive Transmission, A727 Automatic Transmission	W39003	1
1990-1993, A518 Automatic Overdrive Transmission, A727 Automatic Transmission	W39003	1	1990-1993, A518 Automatic Overdrive Transmission, A727 Automatic Transmission, Tuff-Cork	W39003TC	1
1990-1993, A518 Automatic Overdrive Transmission, A727 Automatic Transmission, Tuff-Cork	W39003TC	1	1982-1989, A727 Automatic Transmission	W39003	1
1982-1989, A727 Automatic Transmission	W39003	1	1982-1989, A727 Automatic Transmission, Tuff-Cork	W39003TC	1
1982-1989, A727 Automatic Transmission, Tuff-Cork	W39003TC	1	1982-1989, A904 Automatic Transmission, A998 Automatic Transmission, A999 Automatic Transmission	W38031	1
1982-1989, A904 Automatic Transmission, A998 Automatic Transmission, A999 Automatic Transmission	W38031	1	RAMCHARGER AD100		
RAM WAGON B300			Elec. Shift Cover Gasket		
Elec. Shift Cover Gasket			1988, 10 Bolt, Eaton 2 Speed Axle	H36328	1
1971-1980, 10 Bolt, Eaton 2 Speed Axle	H36328	1	1988, 11 Bolt, Eaton 2 Speed Axle	H36329	1
1971-1980, 11 Bolt, Eaton 2 Speed Axle	H36329	1	1974-1981, 10 Bolt, Eaton 2 Speed Axle	H36328	1
P.T.O. Cover Gasket			1974-1981, 11 Bolt, Eaton 2 Speed Axle	H36329	1
1971-1980, 6 Bolt, Chelsea Power Take Off	H36080	1	P.T.O. Cover Gasket		
1971-1980, 8 Bolt, Chelsea Power Take Off	H36124	1	1988, 6 Bolt, Chelsea Power Take Off	H36080	1
			1988, 8 Bolt, Chelsea Power Take Off	H36124	1
			1974-1981, 6 Bolt, Chelsea Power Take Off	H36080	1

LIGHT TRUCK

Transmission Gaskets (cont.)

<i>Model & Application</i>	<i>Part No.</i>	<i>Qty.</i>	<i>Model & Application</i>	<i>Part No.</i>	<i>Qty.</i>
RAMCHARGER AD100 (cont.)			RAMCHARGER AD150 (cont.)		
P.T.O. Cover Gasket (cont.)			Transmission Pan Gasket (cont.)		
1974-1981, 8 Bolt, Chelsea Power Take Off . . .	H36124	1	1982-1989, A727 Automatic Transmission, Tuff-Cork	W39003TC	1
P.T.O. Mounting Gasket			1982-1989, A904 Automatic Transmission, A998 Automatic Transmission, A999 Automatic Transmission	W38031	1
1988, .010" Thickness, 6 Bolt, Chelsea Power Take Off	H26205	1	RAMCHARGER AW100		
1988, .010" Thickness, 8 Bolt, Chelsea Power Take Off	H26207	1	Elec. Shift Cover Gasket		
1988, .020" Thickness, 6 Bolt, Chelsea Power Take Off	H26206	1	1988, 10 Bolt, Eaton 2 Speed Axle	H36328	1
1988, .020" Thickness, 8 Bolt, Chelsea Power Take Off	H26208	1	1988, 11 Bolt, Eaton 2 Speed Axle	H36329	1
1974-1981, .010" Thickness, 6 Bolt, Chelsea Power Take Off	H26205	1	1974-1981, 10 Bolt, Eaton 2 Speed Axle	H36328	1
1974-1981, .010" Thickness, 8 Bolt, Chelsea Power Take Off	H26207	1	1974-1981, 11 Bolt, Eaton 2 Speed Axle	H36329	1
1974-1981, .020" Thickness, 6 Bolt, Chelsea Power Take Off	H26206	1	P.T.O. Cover Gasket		
1974-1981, .020" Thickness, 8 Bolt, Chelsea Power Take Off	H26208	1	1988, 6 Bolt, Chelsea Power Take Off	H36080	1
Transmission Gasket Set			1988, 8 Bolt, Chelsea Power Take Off	H36124	1
1978-1979, A390 Transmission	TS29047	1	1974-1981, 6 Bolt, Chelsea Power Take Off	H36080	1
1974-1981, 435, 445 Transmission	TS26390X	1	1974-1981, 8 Bolt, Chelsea Power Take Off	H36124	1
Transmission Pan Gasket			P.T.O. Mounting Gasket		
1988, A727 Automatic Transmission	W39003	1	1988, .010" Thickness, 6 Bolt, Chelsea Power Take Off	H26205	1
1988, A727 Automatic Transmission, Tuff-Cork	W39003TC	1	1988, .010" Thickness, 8 Bolt, Chelsea Power Take Off	H26207	1
1988, A904 Automatic Transmission, A998 Automatic Transmission, A999 Automatic Transmission	W38031	1	1988, .020" Thickness, 6 Bolt, Chelsea Power Take Off	H26206	1
1974-1981, A727 Automatic Transmission	W39003	1	1988, .020" Thickness, 8 Bolt, Chelsea Power Take Off	H26208	1
1974-1981, A727 Automatic Transmission, Tuff-Cork	W39003TC	1	1974-1981, .010" Thickness, 6 Bolt, Chelsea Power Take Off	H26205	1
1974-1981, A904 Automatic Transmission, A998 Automatic Transmission, A999 Automatic Transmission	W38031	1	1974-1981, .010" Thickness, 8 Bolt, Chelsea Power Take Off	H26207	1
RAMCHARGER AD150			1974-1981, .020" Thickness, 6 Bolt, Chelsea Power Take Off	H26206	1
Elec. Shift Cover Gasket			1974-1981, .020" Thickness, 8 Bolt, Chelsea Power Take Off	H26208	1
1982-1993, 10 Bolt, Eaton 2 Speed Axle	H36328	1	Transmission Gasket Set		
1982-1993, 11 Bolt, Eaton 2 Speed Axle	H36329	1	1978-1980, A390 Transmission	TS29047	1
P.T.O. Cover Gasket			1974-1981, 435, 445 Transmission	TS26390X	1
1982-1993, 6 Bolt, Chelsea Power Take Off	H36080	1	Transmission Pan Gasket		
1982-1993, 8 Bolt, Chelsea Power Take Off	H36124	1	1988, A727 Automatic Transmission	W39003	1
P.T.O. Mounting Gasket			1988, A727 Automatic Transmission, Tuff-Cork	W39003TC	1
1982-1993, .010" Thickness, 6 Bolt, Chelsea Power Take Off	H26205	1	1988, A904 Automatic Transmission, A998 Automatic Transmission, A999 Automatic Transmission	W38031	1
1982-1993, .010" Thickness, 8 Bolt, Chelsea Power Take Off	H26207	1	1974-1981, A727 Automatic Transmission	W39003	1
1982-1993, .020" Thickness, 6 Bolt, Chelsea Power Take Off	H26206	1	1974-1981, A727 Automatic Transmission, Tuff-Cork	W39003TC	1
1982-1993, .020" Thickness, 8 Bolt, Chelsea Power Take Off	H26208	1	1974-1981, A904 Automatic Transmission, A998 Automatic Transmission, A999 Automatic Transmission	W38031	1
Transmission Gasket Set			RAMCHARGER AW150		
1982-1983, 435, 445 Transmission	TS26390X	1	Elec. Shift Cover Gasket		
Transmission Pan Gasket			1982-1993, 10 Bolt, Eaton 2 Speed Axle	H36328	1
1990-1993, A500 Automatic Overdrive Transmission, A998 Automatic Transmission, A999 Automatic Transmission	W38031	1	1982-1993, 11 Bolt, Eaton 2 Speed Axle	H36329	1
1990-1993, A518 Automatic Overdrive Transmission, A727 Automatic Transmission	W39003	1	P.T.O. Cover Gasket		
1990-1993, A518 Automatic Overdrive Transmission, Tuff-Cork	W39003TC	1	1982-1993, 6 Bolt, Chelsea Power Take Off	H36080	1
1982-1989, A727 Automatic Transmission	W39003	1	1982-1993, 8 Bolt, Chelsea Power Take Off	H36124	1
			P.T.O. Mounting Gasket		
			1982-1993, .010" Thickness, 6 Bolt, Chelsea Power Take Off	H26205	1
			1982-1993, .010" Thickness, 8 Bolt, Chelsea Power Take Off	H26207	1
			1982-1993, .020" Thickness, 6 Bolt, Chelsea Power Take Off	H26206	1
			Chelsea Power Take Off	H26206	1

Transmission Gaskets (cont.)

<i>Model & Application</i>	<i>Part No.</i>	<i>Qty.</i>	<i>Model & Application</i>	<i>Part No.</i>	<i>Qty.</i>
TOWN & COUNTRY (cont.)			VOYAGER PB150 (cont.)		
Transaxle Pan Gasket			Transmission Pan Gasket (cont.)		
1990-1991, A413 Transaxle, A670			1981-1983, A727 Automatic Transmission,		
Transaxle, Tuff-Cork	W38795TC	1	Tuff-Cork	W39003TC	1
1990-1991, A604 Transaxle, Tuff-Cork	W39375TC	1	1981-1983, A904 Automatic Transmission,		
			A998 Automatic Transmission, A999		
			Automatic Transmission	W38031	1
TRAILDUSTER			VOYAGER PB200		
Elec. Shift Cover Gasket			Transmission Gasket Set		
1974-1981, 10 Bolt, Eaton 2 Speed Axle	H36328	1	1978-1980, A390 Transmission	TS29047	1
1974-1981, 11 Bolt, Eaton 2 Speed Axle	H36329	1	1974-1980, 435, 445 Transmission	TS26390X	1
P.T.O. Cover Gasket			1974, A390 Transmission	TS29047	1
1974-1981, 6 Bolt, Chelsea Power Take Off	H36080	1	Transmission Pan Gasket		
1974-1981, 8 Bolt, Chelsea Power Take Off	H36124	1	1979-1980, A904 Automatic Transmission	W38031	1
P.T.O. Mounting Gasket			1974-1980, A727 Automatic Transmission	W39003	1
1974-1981, .010" Thickness, 6 Bolt,			1974-1980, A727 Automatic Transmission,		
Chelsea Power Take Off	H26205	1	Tuff-Cork	W39003TC	1
1974-1981, .010" Thickness, 8 Bolt,			1974-1980, A904 Automatic Transmission,		
Chelsea Power Take Off	H26207	1	A998 Automatic Transmission, A999		
1974-1981, .020" Thickness, 6 Bolt,			Automatic Transmission	W38031	1
Chelsea Power Take Off	H26206	1	VOYAGER PB250		
1974-1981, .020" Thickness, 8 Bolt,			Transmission Gasket Set		
Chelsea Power Take Off	H26208	1	1981-1983, 435, 445 Transmission	TS26390X	1
Transmission Gasket Set			Transmission Pan Gasket		
1974-1981, 435, 445 Transmission	TS26390X	1	1981-1983, A727 Automatic Transmission	W39003	1
1974-1980, A390 Transmission	TS29047	1	1981-1983, A727 Automatic Transmission,		
Transmission Pan Gasket			Tuff-Cork	W39003TC	1
1974-1981, A727 Automatic Transmission	W39003	1	1981-1983, A904 Automatic Transmission,		
1974-1981, A727 Automatic Transmission,			A998 Automatic Transmission, A999		
Tuff-Cork	W39003TC	1	Automatic Transmission	W38031	1
1974-1981, A904 Automatic Transmission,			VOYAGER PB300		
A998 Automatic Transmission, A999			Transmission Gasket Set		
Automatic Transmission	W38031	1	1979-1980, A390 Transmission	TS29047	1
VOYAGER			1974-1980, 435, 445 Transmission	TS26390X	1
Transaxle Diff. Cvr Gasket			1974, A390 Transmission	TS29047	1
1989-1991, A413 Transaxle, A670			Transmission Pan Gasket		
Transaxle, Tuff-Cork	W37731TC	1	1974-1980, A727 Automatic Transmission	W39003	1
1989-1991, A604 Transaxle, Tuff-Cork	W39376TC	1	1974-1980, A727 Automatic Transmission,		
1984-1988, Tuff-Cork	W37731TC	1	Tuff-Cork	W39003TC	1
Transaxle End Cvr. Gasket			1974-1980, A904 Automatic Transmission,		
1989-1991, A604 Transaxle, Rear, Tuff-Cork	W39377TC	1	A998 Automatic Transmission, A999		
1984-1986, Rear, Tuff-Cork	W37347TC	1	Automatic Transmission	W38031	1
Transaxle Pan Gasket			VOYAGER PB350		
1989-1991, A413 Transaxle, A670			Transmission Gasket Set		
Transaxle, Tuff-Cork	W38795TC	1	1981-1983, 435, 445 Transmission	TS26390X	1
1989-1991, A604 Transaxle, Tuff-Cork	W39375TC	1	Transmission Pan Gasket		
1984-1988, Tuff-Cork	W38795TC	1	1981-1983, A727 Automatic Transmission	W39003	1
VOYAGER PB100			1981-1983, A727 Automatic Transmission,		
Transmission Gasket Set			Tuff-Cork	W39003TC	1
1978-1980, A390 Transmission	TS29047	1	1981-1983, A904 Automatic Transmission,		
1974-1980, 435, 445 Transmission	TS26390X	1	A998 Automatic Transmission, A999		
Transmission Pan Gasket			Automatic Transmission	W38031	1
1979-1980, A904 Automatic Transmission	W38031	1	W300M		
1974-1980, A727 Automatic Transmission	W39003	1	Elec. Shift Cover Gasket		
1974-1980, A727 Automatic Transmission,			1958-1959, 10 Bolt, Eaton 2 Speed Axle	H36328	1
Tuff-Cork	W39003TC	1	1958-1959, 11 Bolt, Eaton 2 Speed Axle	H36329	1
1974-1980, A904 Automatic Transmission,			P.T.O. Cover Gasket		
A998 Automatic Transmission, A999			1958-1959, 6 Bolt, Chelsea Power Take Off	H36080	1
Automatic Transmission	W38031	1	1958-1959, 8 Bolt, Chelsea Power Take Off	H36124	1
VOYAGER PB150			P.T.O. Mounting Gasket		
Transmission Gasket Set			1958-1959, .010" Thickness, 6 Bolt,		
1981-1983, 435, 445 Transmission	TS26390X	1	Chelsea Power Take Off	H26205	1
Transmission Pan Gasket			1958-1959, .020" Thickness, 6 Bolt,		
1981-1983, A727 Automatic Transmission	W39003	1	Chelsea Power Take Off	H26206	1

Dodge Truck (cont.)

Transmission Gaskets (cont.)

<i>Model & Application</i>	<i>Part No.</i>	<i>Qty.</i>	<i>Model & Application</i>	<i>Part No.</i>	<i>Qty.</i>
W300M (cont.)			WM300 (cont.)		
P.T.O. Mounting Gasket (cont.)			P.T.O. Mounting Gasket		
1958-1959, .020" Thickness, 8 Bolt, Chelsea Power Take Off	H26208	1	1960-1968, .010" Thickness, 6 Bolt, Chelsea Power Take Off	H26205	1
WM300			1960-1968, .020" Thickness, 6 Bolt, Chelsea Power Take Off	H26206	1
Elec. Shift Cover Gasket			1960-1968, .020" Thickness, 8 Bolt, Chelsea Power Take Off	H26208	1
1960-1968, 10 Bolt, Eaton 2 Speed Axle	H36328	1	Transmission Pan Gasket		
1960-1968, 11 Bolt, Eaton 2 Speed Axle	H36329	1	1963-1968	W39003	1
P.T.O. Cover Gasket			1963-1968, Tuff-Cork	W39003TC	1
1960-1968, 6 Bolt, Chelsea Power Take Off	H36080	1			
1960-1968, 8 Bolt, Chelsea Power Take Off	H36124	1			

Ford Truck

Axle Shaft Gaskets

<i>Model & Application</i>	<i>Part No.</i>	<i>Qty.</i>	<i>Model & Application</i>	<i>Part No.</i>	<i>Qty.</i>
BRONCO			ECONOLINE E150		
Brake Backing Plate			Brake Backing Plate		
1980-1992, Rear Axle	J26108	2	1975-1992, Rear Axle	J26102	2
1974-1979, Rear Axle	J26115	2	ECONOLINE E200		
1973-1974, 3300 Pound Axle, Rear Axle	J26115	2	Brake Backing Plate		
1973, 2700 Pound Axle, Rear Axle	J26095	2	1973-1974, Rear Axle	J26115	2
1970-1973, 2700 Pound Axle, From Serial Number G50, 001, Rear Axle	J26095	2	1970-1972, Before Serial Number G50, 001, Rear Axle	J26638	2
1970-1972, 3300 Pound Axle, From Serial Number G50, 001, Rear Axle	J26115	2	1970-1972, From Serial Number G50, 001, Rear Axle	J26115	2
1966-1970, 2700 Pound Axle, Before Serial Number G50, 001, Rear Axle	J26568	2	1969, Rear Axle	J26638	2
1966-1970, 3300 Pound Axle, Before Serial Number G50, 001, Rear Axle	J26638	2	ECONOLINE E250		
Wheel Brg. Ret. Gasket			Brake Backing Plate		
1966-1968, Rear Wheel	J26374	2	1990-1992, 4 Bolt Holes, Rear Axle	J26102	2
CLUB WAGON E150			1975-1992, 8 Bolt Holes, Rear Axle	J26212	2
Brake Backing Plate			ECONOLINE E300		
1987, Rear Axle	J26102	2	Brake Backing Plate		
CLUB WAGON E250			1970-1974, Rear Axle	J26027	2
Brake Backing Plate			1969, Rear Axle	J26253	2
1987, Rear Axle	J26212	2	ECONOLINE E350		
CLUB WAGON E350			Brake Backing Plate		
Brake Backing Plate			1990-1992, 4 Bolt Holes, Rear Axle	J26102	2
1987, 8 Bolt Holes, Rear Axle	J26212	2	1975-1992, 8 Bolt Holes, Rear Axle	J26212	2
COURIER			F100		
Wheel Brg. Ret. Gasket			Brake Backing Plate		
1972-1982, Rear Wheel	J27351	2	1980-1983, 2800 Pound Axle, Rear Axle	J26102	2
ECONOLINE E100			1980-1983, 3750 Pound Axle, Rear Axle	J26108	2
Brake Backing Plate			1973-1979, Rear Axle	J26115	2
1980-1983, Rear Axle, 17/32" Bolt Holes	J26115	2	1970-1972, Before Serial Number G50, 001, Rear Axle	J26638	2
1974-1983, Rear Axle, 13/32" Bolt Holes	J26102	2	1970-1972, From Serial Number G50, 001, Rear Axle	J26115	2
1970-1973, From Serial Number G50, 001, Rear Axle	J26095	2	1969-1970, Before Serial Number G50, 001, Except Dana Locking Axle 60-3, Rear Axle	J26638	2
1969-1970, Before Serial Number G50, 001, Rear Axle	J26568	2	1966-1969, Except Dana Locking Axle 60-3, Rear Axle	J26638	2
1964-1967, Before Serial Number G50, 001, Rear Axle	J26568	2	1961-1965, Rear Axle	J26638	2
Wheel Brg. Ret. Gasket			Wheel Brg. Ret. Gasket		
1966-1967, Rear Wheel	J26374	2	1961-1967, Rear Wheel	J26640	4

LIGHT TRUCK

Axle Shaft Gaskets (cont.)

<i>Model & Application</i>	<i>Part No.</i>	<i>Qty.</i>	<i>Model & Application</i>	<i>Part No.</i>	<i>Qty.</i>
F150			P100		
Brake Backing Plate			Brake Backing Plate		
1980-1992, 2800 Pound Axle, Rear Axle	J26102	2	1966-1967, Except Dana Locking Axle 60-3, Rear Axle	J26638	2
1980-1992, 3750 Pound Axle, Rear Axle	J26108	2	1961-1965, Rear Axle	J26638	2
1975-1979, Rear Axle	J26115	2	Wheel Brg. Ret. Gasket		
F250			1961-1967, Rear Wheel		
Axle Shaft Gasket			J26640		
1979-1990, Rear Axle	J26212	2	P350		
1970-1978, Rear Axle	J26027	2	Axle Shaft Gasket		
1957-1969, Rear Axle	J26253	2	1970-1977, Rear Axle		
F350			1957-1969, Rear Axle		
Axle Shaft Gasket			J26027		
1979-1992, Rear Axle	J26212	2	J26253		
1970-1978, Rear Axle	J26027	2	RANGER		
1957-1969, 8 Bolt Holes, Rear Axle, 3-25/64" Inside Diameter	J26253	2	Wheel Brg. Ret. Gasket		
M450			1983-1984, Rear Wheel		
Axle Shaft Gasket			J26245		
1973-1976, Rear Axle	J26758	2			

Differential Housing Cover Gaskets

<i>Model & Application</i>	<i>Part No.</i>	<i>Qty.</i>	<i>Model & Application</i>	<i>Part No.</i>	<i>Qty.</i>
AEROSTAR			BRONCO II		
Axle Hsg Cover Gasket			Axle Hsg Cover Gasket		
1986-1997, 7-1/8" Ring Gear, Dana 30 Axle, Rear Axle, Tuff-Cork	P38152TC	1	1984, Ford WFC, WGX Axles, Rear Axle, Tuff-Cork	P27609TC	1
1986-1997, Ford WDA, WFB Axles, Rear Axle, Tuff-Cork	P27608TC	1	CLUB WAGON E100		
Diff. Carrier Gasket			Axle Hsg Cover Gasket		
1986-1997, Ford WAA, WFJ Axles, Rear Axle, Tuff-Cork	P38154TC	1	1963-1969, 2300 Pound Axle, Rear Axle		
BRONCO			1962, Rear Axle		
Axle Hsg Cover Gasket			P27799		
1987-1996, Ford WDR, WFL Axles, Rear Axle, Tuff-Cork	P27608TC	1	1962, Rear Axle		
1987, Ford WAC, WFC Axles, Rear Axle, Tuff-Cork	P38151TC	1	P27799		
1983-1986, Ford WAC, WFC Axles, Ford WFM, WGX Axles, Rear Axle, Tuff-Cork	P38151TC	1	Diff. Carrier Gasket		
1978-1996, Front Axle	P27768T	1	1975-1983, Rear Axle		
1978-1996, 10 Bolt Holes, Front Axle, Tuff-Cork	P27768TC	1	1975-1983, Rear Axle, Tuff-Cork		
1971-1977, Dana 44 Axle, From Serial Number K20, 001, Front Axle	P27768T	1	1963-1974, 2700 Pound Axle, 3050 Pound Axle, Rear Axle		
1971-1977, Dana 44 Axle, From Serial Number K20, 001, 10 Bolt Holes, Front Axle, Tuff-Cork	P27768TC	1	1963-1974, 2700 Pound Axle, 3050 Pound Axle, Rear Axle, Tuff-Cork		
1966-1971, Dana 30 Axle, Thru Serial Number K20, 001, Front Axle	P27603	1	P27929		
Diff. Carrier Gasket			P27929TC		
1988-1996, Ford WAC, WFM Axles, Rear Axle, Tuff-Cork	P38154TC	1	CLUB WAGON E150		
1983-1986, Ford WDM, WFE Axles, Rear Axle	P27994	1	Axle Hsg Cover Gasket		
1983-1986, Ford WDM, WFE Axles, Rear Axle, Tuff-Cork	P27994TC	1	1988-1997, Rear Axle, Tuff-Cork		
1975-1982, Rear Axle	P27994	1	Diff. Carrier Gasket		
1975-1982, Rear Axle, Tuff-Cork	P27994TC	1	1981-1987, 9" Ring Gear, Ford WEV, WFT Axles, Rear Axle		
1966-1974, Rear Axle	P27929	1	1981-1987, 9" Ring Gear, Ford WEV, WFT Axles, Rear Axle, Tuff-Cork		
1966-1974, Rear Axle, Tuff-Cork	P27929TC	1	1975-1980, Rear Axle		
CLUB WAGON E200			1975-1980, Rear Axle, Tuff-Cork		
Diff. Carrier Gasket			P27994TC		
1969-1974, Rear Axle	P27929	1	CLUB WAGON E250		
1969-1974, Rear Axle, Tuff-Cork	P27929TC	1	Axle Hsg Cover Gasket		
CLUB WAGON E250			1991, Dana 60-1 Axle, Rear Axle		
Diff. Carrier Gasket			1990, Ford WEC Axle, Rear Axle, Tuff-Cork		
1969-1974, Rear Axle	P27929	1	1989, Dana 60, 61 Axle, Rear Axle, Tuff-Cork		
1969-1974, Rear Axle, Tuff-Cork	P27929TC	1	P38162TC		
CLUB WAGON E250					
Axle Hsg Cover Gasket					
1991, Dana 60-1 Axle, Rear Axle	P18562	1			
1990, Ford WEC Axle, Rear Axle, Tuff-Cork	P27608TC	1			
1989, Dana 60, 61 Axle, Rear Axle, Tuff-Cork	P38162TC	1			

LIGHT TRUCK

Ford Truck (cont.)

Differential Housing Cover Gaskets (cont.)

<i>Model & Application</i>	<i>Part No.</i>	<i>Qty.</i>	<i>Model & Application</i>	<i>Part No.</i>	<i>Qty.</i>
CLUB WAGON E250 (cont.)			ECONOLINE E150 (cont.)		
Axle Hsg Cover Gasket (cont.)			Axle Hsg Cover Gasket (cont.)		
1988-1989, Ford WEC, WFS Axles, Rear Axle, Tuff-Cork	P27608TC	1	1987, Ford WDR, WFL Axles, Rear Axle, Tuff-Cork	P27608TC	1
1983-1988, Spicer Axle, Rear Axle	P18562	1	Diff. Carrier Gasket		
1983-1988, Spicer Axle, Rear Axle, Tuff-Cork	P18562TC	1	1981-1987, 9" Ring Gear, Ford WEV, WFT Axles, Rear Axle	P27994	1
1983-1987, Ford WDR, WEC, WFL, WFS Axles, Rear Axle, Tuff-Cork	P27608TC	1	1981-1987, 9" Ring Gear, Ford WEV, WFT Axles, Rear Axle, Tuff-Cork	P27994TC	1
1975-1982, Rear Axle	P18562	1	1975-1980, Rear Axle	P27994	1
1975-1982, Rear Axle, Tuff-Cork	P18562TC	1	1975-1980, Rear Axle, Tuff-Cork	P27994TC	1
CLUB WAGON E300			ECONOLINE E200		
Axle Hsg Cover Gasket			Diff. Carrier Gasket		
1969-1974, Rear Axle	P18562	1	1969-1974, Rear Axle	P27929	1
1969-1974, Rear Axle, Tuff-Cork	P18562TC	1	1969-1974, Rear Axle, Tuff-Cork	P27929TC	1
CLUB WAGON E350			ECONOLINE E250		
Axle Hsg Cover Gasket			Axle Hsg Cover Gasket		
1991-1997, Dana 60, 70 Axle, Rear Axle	P18562	1	1991-1997, Dana 60-1 Axle, Rear Axle	P18562	1
1989, Dana 60, 61 Axle, Rear Axle, Tuff-Cork	P38162TC	1	1990, Ford WEC Axle, Rear Axle, Tuff-Cork	P27608TC	1
1984-1988, Rear Axle	P18562	1	1989, Dana 60, 61 Axle, Rear Axle, Tuff-Cork	P38162TC	1
1984-1988, Rear Axle, Tuff-Cork	P18562TC	1	1988-1989, Ford WEC, WFS Axles, Rear Axle, Tuff-Cork	P27608TC	1
E100 PICKUP			1983-1988, Spicer Axle, Rear Axle		
Axle Hsg Cover Gasket			1983-1988, Spicer Axle, Rear Axle, Tuff-Cork		
1963-1967, 2300 Pound Axle, Rear Axle	P27799	1	1983-1987, Ford WDR, WEC, WFL, WFS Axles, Rear Axle, Tuff-Cork	P27608TC	1
1961-1962, Rear Axle	P27799	1	1975-1982, Rear Axle	P18562	1
Diff. Carrier Gasket			1975-1982, Rear Axle, Tuff-Cork		
1963-1967, 2700 Pound Axle, 3050 Pound Axle, Rear Axle	P27929	1	ECONOLINE E300		
1963-1967, 2700 Pound Axle, 3050 Pound Axle, Rear Axle, Tuff-Cork	P27929TC	1	Axle Hsg Cover Gasket		
E100 STATION BUS			1969-1974, Rear Axle		
Axle Hsg Cover Gasket			1969-1974, Rear Axle, Tuff-Cork		
1963-1965, 2300 Pound Axle, Rear Axle	P27799	1	ECONOLINE E350		
1961-1962, Rear Axle	P27799	1	Axle Hsg Cover Gasket		
Diff. Carrier Gasket			1991-1996, Dana 60, 70 Axle, Rear Axle		
1963-1965, 2700 Pound Axle, 3050 Pound Axle, Rear Axle	P27929	1	1989, Dana 60, 61 Axle, Rear Axle, Tuff-Cork	P38162TC	1
1963-1965, 2700 Pound Axle, 3050 Pound Axle, Rear Axle, Tuff-Cork	P27929TC	1	1975-1988, Spicer Axle, Rear Axle	P18562	1
ECONOLINE E100			1975-1988, Spicer Axle, Rear Axle, Tuff-Cork		
Axle Hsg Cover Gasket			1983-1987, Ford WDR, WFL Axles, Rear Axle, Tuff-Cork		
1969, 2300 Pound Axle, Rear Axle	P27799	1	1980-1983, Dana 44 Axle, Front Axle	P27768T	1
1963-1967, 2300 Pound Axle, Rear Axle	P27799	1	1980-1983, Dana 44 Axle, 10 Bolt Holes, Front Axle, Tuff-Cork	P27768TC	1
1961-1962, Rear Axle	P27799	1	1971, Dana 44 Axle, Front Axle	P27768T	1
Diff. Carrier Gasket			1971, Dana 44 Axle, 10 Bolt Holes, Front Axle, Tuff-Cork		
1975-1983, Rear Axle	P27994	1	1970-1979, Dana 44 Axle, Front Axle, Rear Axle	P27768T	1
1975-1983, Rear Axle, Tuff-Cork	P27994TC	1	1970-1979, Dana 44 Axle, 10 Bolt Holes, Front Axle, Rear Axle, Tuff-Cork	P27768TC	1
1970-1974, Rear Axle	P27929	1	1970-1976, Dana 44 Axle, Front Axle	P27768T	1
1970-1974, Rear Axle, Tuff-Cork	P27929TC	1	EXPLORER		
1969, 2700 Pound Axle, 3050 Pound Axle, Rear Axle	P27929	1	Axle Hsg Cover Gasket		
1969, 2700 Pound Axle, 3050 Pound Axle, Rear Axle, Tuff-Cork	P27929TC	1	1991-1997, Ford WDB, WFH Axles, Rear Axle, Tuff-Cork		
1963-1967, 2700 Pound Axle, 3050 Pound Axle, Rear Axle	P27929	1 P27608TC 1		
1963-1967, 2700 Pound Axle, 3050 Pound Axle, Rear Axle, Tuff-Cork	P27929TC	1	F100		
ECONOLINE E150			Axle Hsg Cover Gasket		
Axle Hsg Cover Gasket			1983, Ford WDR, WFL Axles, Rear Axle, Tuff-Cork		
1988-1997, Rear Axle, Tuff-Cork	P27608TC	1	1980-1983, Dana 44 Axle, Front Axle	P27768T	1

LIGHT TRUCK

Differential Housing Cover Gaskets (cont.)

Model & Application	Part No.	Qty.	Model & Application	Part No.	Qty.
F100 (cont.)			F250 (cont.)		
Axle Hsg Cover Gasket (cont.)			Axle Hsg Cover Gasket (cont.)		
1970-1976, Dana 44 Axle, 10 Bolt Holes, Front Axle, Tuff-Cork	P27768TC	1	1973-1977, Dana 44 Axle, Front Axle	P27768T	1
1957-1982, Dana 44 Axle, Front Axle, Rear Axle.	P27768T	1	1973-1977, Dana 44 Axle, 10 Bolt Holes, Front Axle, Tuff-Cork	P27768TC	1
1957-1982, Dana 44 Axle, 10 Bolt Holes, Front Axle, Rear Axle, Tuff-Cork	P27768TC	1	1968-1971, Dana 50, 60 Axle, Rear Axle	P18562	1
1957-1969, Dana 60 Axle, Rear Axle	P18562	1	1968-1971, Dana 50, 60 Axle, Rear Axle, Tuff-Cork	P18562TC	1
1957-1969, Dana 60 Axle, Rear Axle, Tuff-Cork	P18562TC	1	1965-1981, Dana 50, 60 Axle, Front Axle, Rear Axle, Tuff-Cork	P18562TC	1
1953-1964, Dana 44 Axle, Rear Axle	P27768T	1	1965-1979, Dana 50, 60 Axle, Front Axle, Rear Axle	P18562	1
1953-1958, Dana 44 Axle, 10 Bolt Holes, Rear Axle, Tuff-Cork	P27768TC	1	1957-1971, Dana 50, 60 Axle, Rear Axle	P18562	1
			1957-1971, Dana 50, 60 Axle, Rear Axle, Tuff-Cork	P18562TC	1
Diff. Carrier Gasket			Diff. Carrier Gasket		
1980-1983, Ford WDM, WFE Axles, Rear Axle	P27994	1	1988-1995, 12 Bolt Holes, Ford WDD, WDR, WDS, WFA, WFD, WFL Axles, Rear Axle, Tuff-Cork	P38155TC	1
1980-1983, Ford WDM, WFE Axles, Rear Axle, Tuff-Cork	P27994TC	1			
1975-1979, Ford Axle, Rear Axle	P27994	1	F350		
1975-1979, Ford Axle, Rear Axle, Tuff-Cork	P27994TC	1	Axle Hsg Cover Gasket		
1970-1974, Rear Axle	P27929	1	1980-1989, Dana 60, 70 Axle, Rear Axle	P18562	1
1970-1974, Rear Axle, Tuff-Cork	P27929TC	1	1980-1989, Dana 60, 70 Axle, Rear Axle, Tuff-Cork	P18562TC	1
1957-1969, Ford Axle, Rear Axle	P27929	1	1979, Dana 60 Axle, Front Axle, Rear Axle	P18562	1
1957-1969, Ford Axle, Rear Axle, Tuff-Cork	P27929TC	1	1979, Dana 60 Axle, Front Axle, Rear Axle, Tuff-Cork	P18562TC	1
F150			M450		
Axle Hsg Cover Gasket			Diff. Carrier Gasket		
1993-1996, Front Axle	P27768T	1	1985-1997, 12 Bolt Holes, Ford WDD, WFD Axles, Rear Axle, Tuff-Cork	P38155TC	1
1985-1992, Spicer Axle, Front Axle	P27768T	1			
1983-1996, Ford WDR, WFL Axles, Rear Axle, Tuff-Cork	P27608TC	1	P100		
1980-1996, Spicer Axle, 10 Bolt Holes, Front Axle, Tuff-Cork	P27768TC	1	Axle Hsg Cover Gasket		
1980-1988, Front Axle	P27768T	1	1957-1967, Dana 44 Axle, Rear Axle	P27768T	1
1975-1981, Spicer Axle, Front Axle, Rear Axle.	P27768T	1	1957-1967, Dana 44 Axle, 10 Bolt Holes, Rear Axle, Tuff-Cork	P27768TC	1
1975-1981, Spicer Axle, 10 Bolt Holes, Front Axle, Rear Axle, Tuff-Cork	P27768TC	1	1957-1967, Dana 60 Axle, Rear Axle	P18562	1
1975-1976, Front Axle	P27768T	1	1957-1967, Dana 60 Axle, Rear Axle, Tuff-Cork	P18562TC	1
1975-1976, Spicer Axle, 10 Bolt Holes, Front Axle, Tuff-Cork	P27768TC	1			
Diff. Carrier Gasket			Diff. Carrier Gasket		
1982-1986, Ford WDM, WFE Axles, Rear Axle	P27994	1	1963-1965, 8-3/4" Ring Gear, Rear Axle, Tuff-Cork	P27930TC	1
1982-1986, Ford WDM, WFE Axles, Rear Axle, Tuff-Cork	P27994TC	1	1957-1967, Ford Axle, Rear Axle	P27929	1
1975-1981, Ford Axle, Rear Axle	P27994	1	1957-1967, Ford Axle, Rear Axle, Tuff-Cork	P27929TC	1
1975-1981, Ford Axle, Rear Axle, Tuff-Cork	P27994TC	1			
F250			P350		
Axle Hsg Cover Gasket			Axle Hsg Cover Gasket		
1988-1992, Dana 44 Axle, Front Axle	P27768T	1	1970-1976, Rear Axle	P18562	1
1988-1992, Dana 44 Axle, 10 Bolt Holes, Front Axle, Tuff-Cork	P27768TC	1	1970-1976, Rear Axle, Tuff-Cork	P18562TC	1
1988-1992, Ford Axle, Rear Axle, Tuff-Cork	P27608TC	1	1964-1969, Dana 60 Axle, Rear Axle	P18562	1
1983-1987, Ford WDD, WDF, WDR, WFL, WDS, WFS Axles, Ford WDR, WEC, WFL, WFS Axles, Rear Axle, Tuff-Cork	P27608TC	1	1964-1969, Dana 60 Axle, Rear Axle, Tuff-Cork	P18562TC	1
1983, Ford WDD, WDF, WDR, WFL, WDS, WFS Axles, Ford WDR, WEC, WFL, WFS Axles.	P27608TC	1	1964-1969, Dana 70 Axle, Rear Axle	P27768T	1
1982-1987, Dana 60, 61 Axle, Dana 70 Axle, Rear Axle.	P18562	1	1964-1969, Dana 70 Axle, 10 Bolt Holes, Rear Axle, Tuff-Cork	P27768TC	1
1982-1987, Dana 60, 61 Axle, Dana 70 Axle, Rear Axle, Tuff-Cork	P18562TC	1			
1980-1981, Dana 50, 60 Axle, Rear Axle	P18562	1			
1980-1981, Dana 50, 60 Axle, Rear Axle, Tuff-Cork	P18562TC	1			

Ford Truck (cont.)

Differential Housing Cover Gaskets (cont.)

<i>Model & Application</i>	<i>Part No.</i>	<i>Qty.</i>	<i>Model & Application</i>	<i>Part No.</i>	<i>Qty.</i>
P350 (cont.)			RANGER (cont.)		
Axle Hsg Cover Gasket (cont.)			Diff. Carrier Gasket (cont.)		
1959-1963, Spicer Axle, Rear Axle	P18562	1	1988-1990, Ford WAC, WDC, WFM Axles, Rear Axle, Tuff-Cork	P38154TC	1
1959-1963, Spicer Axle, Rear Axle, Tuff-Cork	P18562TC	1	SUPER WAGON E150		
RANCHERO			Diff. Carrier Gasket		
Diff. Carrier Gasket			1981-1983, 9" Ring Gear, Ford WEV, WFT Axles, Rear Axle		
1975-1977	P27994	1	P27994	1
1975-1977, Tuff-Cork	P27994TC	1	1981-1983, 9" Ring Gear, Ford WEV, WFT Axles, Rear Axle, Tuff-Cork	P27994TC	1
1969-1974, 8" Gear, 10 Bolt Holes, 9-3/4" X 10-15/16"	P27807	1	1978-1980, Rear Axle	P27994	1
1969-1974, 9" Gear, 10 Bolt Holes, 10-3/4" X 11-5/8"	P27929	1	1978-1980, Rear Axle, Tuff-Cork	P27994TC	1
1969-1974, 9" Gear, 10 Bolt Holes, Tuff-Cork, 10-3/4" X 11-5/8"	P27929TC	1	SUPER WAGON E250		
RANGER			Axle Hsg Cover Gasket		
Axle Hsg Cover Gasket			1983, Ford WDR, WEC, WFL, WFS Axles, Rear Axle, Tuff-Cork		
1988-1997, Ford WDC, WFG Axles, Ford WDR, WFL Axles, Rear Axle, Tuff-Cork	P27608TC	1	P27608TC	1
1983-1987, Ford WDR, WFC, WFL, WGG, WGX Axles, Rear Axle, Tuff-Cork	P27609TC	1	1983, Spicer Axle, Rear Axle	P18562	1
Diff. Carrier Gasket			1983, Spicer Axle, Rear Axle, Tuff-Cork	P18562TC	1
1990-1997, Ford WAC, WFM Axles, Rear Axle, Tuff-Cork	P38154TC	1	1978-1980, Rear Axle	P18562	1
1990-1993, Ford WAC, WDC, WFM Axles, Ford WAC, WFM Axles, Rear Axle, Tuff-Cork	P38154TC	1	1978-1980, Rear Axle, Tuff-Cork	P18562TC	1
RANGER			SUPER WAGON E350		
Axle Hsg Cover Gasket			Axle Hsg Cover Gasket		
1988-1997, Ford WDC, WFG Axles, Ford WDR, WFL Axles, Rear Axle, Tuff-Cork	P27608TC	1	1978-1983, Rear Axle	P18562	1
1983-1987, Ford WDR, WFC, WFL, WGG, WGX Axles, Rear Axle, Tuff-Cork	P27609TC	1	1978-1983, Rear Axle, Tuff-Cork	P18562TC	1
Diff. Carrier Gasket			SUPER WAGON E350		
1990-1997, Ford WAC, WFM Axles, Rear Axle, Tuff-Cork	P38154TC	1	Axle Hsg Cover Gasket		
1990-1993, Ford WAC, WDC, WFM Axles, Ford WAC, WFM Axles, Rear Axle, Tuff-Cork	P38154TC	1	1978-1983, Rear Axle	P18562	1
RANGER			1978-1983, Rear Axle, Tuff-Cork	P18562TC	1

Transmission Gaskets

<i>Model & Application</i>	<i>Part No.</i>	<i>Qty.</i>	<i>Model & Application</i>	<i>Part No.</i>	<i>Qty.</i>
AEROSTAR			BRONCO (cont.)		
Transmission Gasket Set			Transmission Pan Gasket (cont.)		
1986-1989, Ford 3 Speed Transmission	TS27817X	1	1982-1986, C5 Automatic Transmission, Dual Range	W39349	1
Transmission Pan Gasket			1982-1986, C5 Automatic Transmission, Dual Range, Tuff-Cork	W39349TC	1
1993-1997, AODEW Transmission	W39141	1	1981-1993, F10D Automatic Overdrive Transmission	W38430	1
1989-1997, E4OD Transmission	W38158	1	1973-1978, Cruise-O-Matic Transmission	W38987	1
1986-1997, A4LD Automatic Transmission, Tuff-Cork	W38144TC	1	1970-1981, C4 Automatic Transmission, Dual Range	W39349	1
1986-1993, F10D Automatic Overdrive Transmission	W38430	1	1970-1981, C4 Automatic Transmission, Dual Range, Tuff-Cork	W39349TC	1
BRONCO			1969-1996, C6 Automatic Transmission, Dual Range	W39346	1
Transfer Case Gasket Set			1969-1996, C6 Automatic Transmission, Dual Range, Tuff-Cork	W39346TC	1
1978-1979, Full Time 4 Wheel Drive	TS27292	1	1968-1969, Automatic 3 Speed Transmission, Dual Range	W37953	1
1978-1979, Part Time 4 Wheel Drive	TS27275	1	1966-1972, Cruise-O-Matic Transmission	W38986	1
1966-1977	TS27313	1	1966, Cruise-O-Matic Transmission, 13 Bolt Holes	W38987	1
Transmission Gasket Set			BRONCO II		
1979-1985, Borg Warner T18 4 Speed Transmission, Borg Warner T19 4 Speed Transmission	TS27246	1	Transmission Gasket Set		
1979-1985, Except RTS Transmission, Ford 4 Speed Overdrive Transmission	TS27996	1	1984-1989, Ford 3 Speed Transmission	TS27817X	1
1969-1989, Borg Warner 3 Speed Transmission	TS27545Y	1	1984-1985, Except RTS Transmission, Ford 4 Speed Overdrive Transmission	TS27996	1
1969-1988, New Process 4 Speed Transmission, New Process 435 Transmission	TS27576Y	1	Transmission Pan Gasket		
1966-1989, Ford 3 Speed Transmission	TS27817X	1	1989-1990, E4OD Transmission	W38158	1
Transmission Pan Gasket			1985-1990, A4LD Automatic Transmission, Tuff-Cork	W38144TC	1
1993-1996, AODEW Transmission	W39141	1	1984-1990, F10D Automatic Overdrive Transmission	W38430	1
1989-1996, E4OD Transmission	W38158	1	BRONCO II		
1985-1996, A4LD Automatic Transmission, Tuff-Cork	W38144TC	1	Transmission Gasket Set		
Transmission Pan Gasket			1984-1989, Ford 3 Speed Transmission		
1989-1990, E4OD Transmission	W38158	1	1984-1985, Except RTS Transmission, Ford 4 Speed Overdrive Transmission	TS27996	1
1985-1990, A4LD Automatic Transmission, Tuff-Cork	W38144TC	1	Transmission Pan Gasket		
1984-1990, F10D Automatic Overdrive Transmission	W38430	1	1989-1990, E4OD Transmission	W38158	1

LIGHT TRUCK

Transmission Gaskets (cont.)

<i>Model & Application</i>	<i>Part No.</i>	<i>Qty.</i>	<i>Model & Application</i>	<i>Part No.</i>	<i>Qty.</i>
BRONCO II (cont.)			CLUB WAGON E150 (cont.)		
Transmission Pan Gasket (cont.)			Transmission Pan Gasket		
1984-1986, C5 Automatic Transmission, Dual Range.	W39349	1	1993-1997, AODEW Transmission	W39141	1
1984-1986, C5 Automatic Transmission, Dual Range, Tuff-Cork.	W39349TC	1	1989-1997, E4OD Transmission	W38158	1
1984, C3 Automatic Transmission, Dual Range.	W37978	1	1985-1997, A4LD Automatic Transmission, Tuff-Cork	W38144TC	1
CLUB WAGON E100			1982-1986, C5 Automatic Transmission, Dual Range.	W39349	1
Transmission Gasket Set			1982-1986, C5 Automatic Transmission, Dual Range, Tuff-Cork.	W39349TC	1
1979-1983, Borg Warner T18 4 Speed Transmission, Borg Warner T19 4 Speed Transmission	TS27246	1	1981-1993, F10D Automatic Overdrive Transmission.	W38430	1
1979-1983, Except RTS Transmission, Ford 4 Speed Overdrive Transmission.	TS27996	1	1980-1982, C4 Automatic Transmission, C5 Automatic Transmission, Dual Range.	W39349	1
1973-1983, New Process 4 Speed Transmission, New Process 435 Transmission	TS27576Y	1	1980-1982, C4 Automatic Transmission, C5 Automatic Transmission, Dual Range, Tuff-Cork	W39349TC	1
1965-1983, Borg Warner 3 Speed Transmission	TS27545Y	1	1975-1996, C6 Automatic Transmission, Dual Range.	W39346	1
1965-1966, Borg Warner 4 Speed Transmission	TS27576	1	1975-1996, C6 Automatic Transmission, Dual Range, Tuff-Cork.	W39346TC	1
1963-1983, Ford 3 Speed Transmission	TS27817X	1	1975-1981, C4 Automatic Transmission, Dual Range.	W39349	1
1962, Ford 3 Speed Transmission	TS27051W	1	1975-1981, C4 Automatic Transmission, Dual Range, Tuff-Cork.	W39349TC	1
Transmission Pan Gasket			1975-1978, Cruise-O-Matic Transmission	W38987	1
1983, C5 Automatic Transmission, Dual Range.	W39349	1	CLUB WAGON E200		
1983, C5 Automatic Transmission, Dual Range, Tuff-Cork.	W39349TC	1	Transmission Gasket Set		
1981-1983, F10D Automatic Overdrive Transmission.	W38430	1	1969-1974, Borg Warner 3 Speed Transmission	TS27545Y	1
1980-1982, C4 Automatic Transmission, C5 Automatic Transmission, Dual Range.	W39349	1	1969-1974, Ford 3 Speed Transmission	TS27817X	1
1980-1982, C4 Automatic Transmission, C5 Automatic Transmission, Dual Range, Tuff-Cork	W39349TC	1	1969-1974, New Process 4 Speed Transmission, New Process 435 Transmission	TS27576Y	1
1973-1983, C6 Automatic Transmission, Dual Range.	W39346	1	Transmission Pan Gasket		
1973-1983, C6 Automatic Transmission, Dual Range, Tuff-Cork.	W39346TC	1	1973-1974, Cruise-O-Matic Transmission	W38987	1
1973-1978, Cruise-O-Matic Transmission	W38987	1	1970-1974, C4 Automatic Transmission, Dual Range.	W39349	1
1970-1981, C4 Automatic Transmission, Dual Range.	W39349	1	1970-1974, C4 Automatic Transmission, Dual Range, Tuff-Cork.	W39349TC	1
1970-1981, C4 Automatic Transmission, Dual Range, Tuff-Cork.	W39349TC	1	1969-1974, C6 Automatic Transmission, Dual Range.	W39346	1
1965-1972, Cruise-O-Matic Transmission, 14 Bolt Holes.	W38986	1	1969-1974, C6 Automatic Transmission, Dual Range, Tuff-Cork.	W39346TC	1
1965-1966, Cruise-O-Matic Transmission, 13 Bolt Holes.	W38987	1	1969-1972, Cruise-O-Matic Transmission	W38986	1
1964-1969, Automatic 3 Speed Transmission, Dual Range.	W37953	1	1969, Automatic 3 Speed Transmission, Dual Range.	W37953	1
1964-1967, Automatic 3 Speed Transmission, Dual Range.	W37954	1	CLUB WAGON E250		
CLUB WAGON E150			Transmission Gasket Set		
Transmission Gasket Set			1979-1985, Borg Warner T18 4 Speed Transmission, Borg Warner T19 4 Speed Transmission	TS27246	1
1979-1985, Borg Warner T18 4 Speed Transmission, Borg Warner T19 4 Speed Transmission	TS27246	1	1979-1985, Except RTS Transmission, Ford 4 Speed Overdrive Transmission.	TS27996	1
1979-1985, Except RTS Transmission, Ford 4 Speed Overdrive Transmission.	TS27996	1	1975-1989, Borg Warner 3 Speed Transmission	TS27545Y	1
1975-1989, Borg Warner 3 Speed Transmission	TS27545Y	1	1975-1989, Ford 3 Speed Transmission	TS27817X	1
1975-1989, Ford 3 Speed Transmission	TS27817X	1	1975-1988, New Process 4 Speed Transmission, New Process 435 Transmission	TS27576Y	1
1975-1988, New Process 4 Speed Transmission, New Process 435 Transmission	TS27576Y	1	Transmission Pan Gasket		
			1989-1991, E4OD Transmission	W38158	1
			1985-1991, A4LD Automatic Transmission, Tuff-Cork	W38144TC	1
			1982-1986, C5 Automatic Transmission, Dual Range.	W39349	1

Ford Truck (cont.)

Transmission Gaskets (cont.)

<i>Model & Application</i>	<i>Part No.</i>	<i>Qty.</i>	<i>Model & Application</i>	<i>Part No.</i>	<i>Qty.</i>
CLUB WAGON E250 (cont.)			CLUB WAGON E350 (cont.)		
Transmission Pan Gasket (cont.)			Transmission Pan Gasket (cont.)		
1982-1986, C5 Automatic Transmission, Dual Range, Tuff-Cork.	W39349TC	1	1984-1986, C5 Automatic Transmission, Dual Range, Tuff-Cork.	W39349TC	1
1981-1991, F10D Automatic Overdrive Transmission.	W38430	1	COURIER		
1980-1982, C4 Automatic Transmission, C5 Automatic Transmission, Dual Range.	W39349	1	Transmission Gasket Set		
1980-1982, C4 Automatic Transmission, C5 Automatic Transmission, Dual Range, Tuff-Cork	W39349TC	1	1972-1982, 4 Speed Transmission		
1975-1991, C6 Automatic Transmission, Dual Range.	W39346	1	Transmission Pan Gasket		
1975-1991, C6 Automatic Transmission, Dual Range, Tuff-Cork.	W39346TC	1	1977-1982, Automatic Transmission		
1975-1981, C4 Automatic Transmission, Dual Range.	W39349	1	E100 PICKUP		
1975-1981, C4 Automatic Transmission, Dual Range, Tuff-Cork.	W39349TC	1	Transmission Gasket Set		
1975-1978, Cruise-O-Matic Transmission	W38987	1	1967, Borg Warner 3 Speed Transmission		
CLUB WAGON E300			1963-1967, Ford 3 Speed Transmission		
Transmission Gasket Set			1961-1962, Ford 3 Speed Transmission		
1969-1974, Borg Warner 3 Speed Transmission	TS27545Y	1	Transmission Pan Gasket		
1969-1974, Ford 3 Speed Transmission	TS27817X	1	1967, Automatic 3 Speed Transmission, Dual Range.		
1969-1974, New Process 4 Speed Transmission, New Process 435 Transmission	TS27576Y	1	1967, Cruise-O-Matic Transmission		
Transmission Pan Gasket			1964-1967, Automatic 3 Speed Transmission, Dual Range.		
1973-1974, Cruise-O-Matic Transmission	W38987	1	1964, Automatic 3 Speed Transmission, Dual Range.		
1970-1974, C4 Automatic Transmission, Dual Range.	W39349	1	1961, Ford-O-Matic Transmission		
1970-1974, C4 Automatic Transmission, Dual Range, Tuff-Cork.	W39349TC	1	E100 STATION BUS		
1969-1974, C6 Automatic Transmission, Dual Range.	W39346	1	Transmission Gasket Set		
1969-1974, C6 Automatic Transmission, Dual Range, Tuff-Cork.	W39346TC	1	1963-1965, Ford 3 Speed Transmission		
1969-1972, Cruise-O-Matic Transmission	W38986	1	1961-1962, Ford 3 Speed Transmission		
1969, Automatic 3 Speed Transmission, Dual Range.	W37953	1	Transmission Pan Gasket		
CLUB WAGON E350			1964-1965, Automatic 3 Speed Transmission, Dual Range.		
Transmission Gasket Set			1964, Automatic 3 Speed Transmission, Dual Range.		
1984-1989, Borg Warner 3 Speed Transmission	TS27545Y	1	1961, Ford-O-Matic Transmission		
1984-1989, Ford 3 Speed Transmission	TS27817X	1	ECONOLINE E100		
1984-1988, New Process 4 Speed Transmission, New Process 435 Transmission	TS27576Y	1	Transmission Gasket Set		
1984-1985, Borg Warner T18 4 Speed Transmission, Borg Warner T19 4 Speed Transmission	TS27246	1	1979-1983, Borg Warner T18 4 Speed Transmission, Borg Warner T19 4 Speed Transmission		
1984-1985, Except RTS Transmission, Ford 4 Speed Overdrive Transmission.	TS27996	1	1979-1983, Except RTS Transmission, Ford 4 Speed Overdrive Transmission.		
Transmission Pan Gasket			1973-1983, New Process 4 Speed Transmission, New Process 435 Transmission		
1993-1996, AODEW Transmission	W39141	1	1969-1983, Borg Warner 3 Speed Transmission		
1989-1996, E4OD Transmission	W38158	1	1969-1983, Ford 3 Speed Transmission		
1985-1996, A4LD Automatic Transmission, Tuff-Cork	W38144TC	1	1967, Borg Warner 3 Speed Transmission		
1984-1996, C6 Automatic Transmission, Dual Range.	W39346	1	1963-1967, Ford 3 Speed Transmission		
1984-1996, C6 Automatic Transmission, Dual Range, Tuff-Cork.	W39346TC	1	1961-1962, Ford 3 Speed Transmission		
1984-1993, F10D Automatic Overdrive Transmission.	W38430	1	Transmission Pan Gasket		
1984-1986, C5 Automatic Transmission, Dual Range.	W39349	1	1983, C5 Automatic Transmission, Dual Range.		
CLUB WAGON E350 (cont.)			1983, C5 Automatic Transmission, Dual Range, Tuff-Cork.		
Transmission Pan Gasket (cont.)			1981-1983, F10D Automatic Overdrive Transmission.		
1982-1986, C5 Automatic Transmission, Dual Range, Tuff-Cork.	W39349TC	1	1980-1982, C4 Automatic Transmission, C5 Automatic Transmission, Dual Range.		
1981-1991, F10D Automatic Overdrive Transmission.	W38430	1	1980-1982, C4 Automatic Transmission, C5 Automatic Transmission, Dual Range, Tuff-Cork		
1980-1982, C4 Automatic Transmission, C5 Automatic Transmission, Dual Range.	W39349	1	1973-1983, C6 Automatic Transmission, Dual Range.		
1980-1982, C4 Automatic Transmission, C5 Automatic Transmission, Dual Range, Tuff-Cork	W39349TC	1			
1975-1991, C6 Automatic Transmission, Dual Range.	W39346	1			
1975-1991, C6 Automatic Transmission, Dual Range, Tuff-Cork.	W39346TC	1			
1975-1981, C4 Automatic Transmission, Dual Range.	W39349	1			
1975-1981, C4 Automatic Transmission, Dual Range, Tuff-Cork.	W39349TC	1			
1975-1978, Cruise-O-Matic Transmission	W38987	1			

LIGHT TRUCK

Transmission Gaskets (cont.)

<i>Model & Application</i>	<i>Part No.</i>	<i>Qty.</i>	<i>Model & Application</i>	<i>Part No.</i>	<i>Qty.</i>
ECONOLINE E100 (cont.)			ECONOLINE E200 (cont.)		
Transmission Pan Gasket (cont.)			Transmission Pan Gasket		
1973-1983, C6 Automatic Transmission, Dual Range, Tuff-Cork.	W39346TC	1	1973-1974, Cruise-O-Matic Transmission	W38987	1
1973-1978, Cruise-O-Matic Transmission	W38987	1	1970-1974, C4 Automatic Transmission, Dual Range.	W39349	1
1970-1981, C4 Automatic Transmission, Dual Range.	W39349	1	1970-1974, C4 Automatic Transmission, Dual Range, Tuff-Cork.	W39349TC	1
1970-1981, C4 Automatic Transmission, Dual Range, Tuff-Cork.	W39349TC	1	1969-1974, C6 Automatic Transmission, Dual Range.	W39346	1
1969-1972, Cruise-O-Matic Transmission	W38986	1	1969-1974, C6 Automatic Transmission, Dual Range, Tuff-Cork.	W39346TC	1
1969, Automatic 3 Speed Transmission, Dual Range.	W37953	1	1969-1972, Cruise-O-Matic Transmission	W38986	1
1967, Automatic 3 Speed Transmission, Dual Range.	W37953	1	1969, Automatic 3 Speed Transmission, Dual Range.	W37953	1
1967, Cruise-O-Matic Transmission	W38986	1	ECONOLINE E250		
1964-1967, Automatic 3 Speed Transmission, Dual Range.	W37954	1	Transmission Gasket Set		
1964, Automatic 3 Speed Transmission, Dual Range.	W37953	1	1979-1985, Borg Warner T18 4 Speed Transmission, Borg Warner T19 4 Speed Transmission	TS27246	1
1961, Ford-O-Matic Transmission	W38987	1	1979-1985, Except RTS Transmission, Ford 4 Speed Overdrive Transmission.	TS27996	1
ECONOLINE E150			1975-1989, Borg Warner 3 Speed Transmission	TS27545Y	1
Transmission Gasket Set			1975-1989, Ford 3 Speed Transmission	TS27817X	1
1979-1985, Borg Warner T18 4 Speed Transmission, Borg Warner T19 4 Speed Transmission	TS27246	1	1975-1988, New Process 4 Speed Transmission, New Process 435 Transmission	TS27576Y	1
1979-1985, Except RTS Transmission, Ford 4 Speed Overdrive Transmission.	TS27996	1	Transmission Pan Gasket		
1975-1989, Borg Warner 3 Speed Transmission	TS27545Y	1	1993-1997, AODEW Transmission	W39141	1
1975-1989, Ford 3 Speed Transmission	TS27817X	1	1989-1997, E4OD Transmission	W38158	1
1975-1988, New Process 4 Speed Transmission, New Process 435 Transmission	TS27576Y	1	1985-1997, A4LD Automatic Transmission, Tuff-Cork	W38144TC	1
Transmission Pan Gasket			1983-1986, C5 Automatic Transmission, Dual Range.	W39349	1
1993-1997, AODEW Transmission	W39141	1	1983-1986, C5 Automatic Transmission, Dual Range, Tuff-Cork.	W39349TC	1
1989-1997, E4OD Transmission	W38158	1	1981-1993, F10D Automatic Overdrive Transmission.	W38430	1
1985-1997, A4LD Automatic Transmission, Tuff-Cork	W38144TC	1	1980-1982, C4 Automatic Transmission, C5 Automatic Transmission, Dual Range.	W39349	1
1983-1986, C5 Automatic Transmission, Dual Range.	W39349	1	1980-1982, C4 Automatic Transmission, C5 Automatic Transmission, Dual Range, Tuff-Cork	W39349TC	1
1983-1986, C5 Automatic Transmission, Dual Range, Tuff-Cork.	W39349TC	1	1975-1997, C6 Automatic Transmission, Dual Range.	W39346	1
1981-1993, F10D Automatic Overdrive Transmission.	W38430	1	1975-1997, C6 Automatic Transmission, Dual Range, Tuff-Cork.	W39346TC	1
1980-1982, C4 Automatic Transmission, C5 Automatic Transmission, Dual Range.	W39349	1	1975-1981, C4 Automatic Transmission, Dual Range.	W39349	1
1980-1982, C4 Automatic Transmission, C5 Automatic Transmission, Dual Range, Tuff-Cork	W39349TC	1	1975-1981, C4 Automatic Transmission, Dual Range, Tuff-Cork.	W39349TC	1
1975-1996, C6 Automatic Transmission, Dual Range.	W39346	1	1975-1978, Cruise-O-Matic Transmission	W38987	1
1975-1996, C6 Automatic Transmission, Dual Range, Tuff-Cork.	W39346TC	1	ECONOLINE E300		
1975-1981, C4 Automatic Transmission, Dual Range.	W39349	1	Transmission Gasket Set		
1975-1981, C4 Automatic Transmission, Dual Range, Tuff-Cork.	W39349TC	1	1969-1974, Borg Warner 3 Speed Transmission	TS27545Y	1
1975-1978, Cruise-O-Matic Transmission	W38987	1	1969-1974, Ford 3 Speed Transmission	TS27817X	1
ECONOLINE E200			1969-1974, New Process 4 Speed Transmission, New Process 435 Transmission	TS27576Y	1
Transmission Gasket Set			Transmission Pan Gasket		
1969-1974, Borg Warner 3 Speed Transmission	TS27545Y	1	1973-1974, Cruise-O-Matic Transmission	W38987	1
1969-1974, Ford 3 Speed Transmission	TS27817X	1	1970-1974, C4 Automatic Transmission, Dual Range.	W39349	1
1969-1974, New Process 4 Speed Transmission, New Process 435 Transmission	TS27576Y	1	1970-1974, C4 Automatic Transmission, Dual Range, Tuff-Cork.	W39349TC	1

Ford Truck (cont.)

Transmission Gaskets (cont.)

Model & Application	Part No.	Qty.	Model & Application	Part No.	Qty.
ECONOLINE E300 (cont.)			F100 (cont.)		
Transmission Pan Gasket (cont.)			Transfer Case Gasket Set (cont.)		
1969-1974, C6 Automatic Transmission, Dual Range.	W39346	1	1973-1979, New Process 205, 205F	TS27275	1
1969-1974, C6 Automatic Transmission, Dual Range, Tuff-Cork.	W39346TC	1	1973-1979, Spicer 21 TC	TS27305	1
1969-1972, Cruise-O-Matic Transmission	W38986	1	1966-1972	TS27305	1
1969, Automatic 3 Speed Transmission, Dual Range.	W37953	1	1959-1965	TS27360	1
ECONOLINE E350			Transmission Gasket Set		
Transmission Gasket Set			1979-1983, Borg Warner T18 4 Speed Transmission, Borg Warner T19 4 Speed Transmission		
1979-1985, Borg Warner T18 4 Speed Transmission, Borg Warner T19 4 Speed Transmission	TS27246	1	1979-1983, Except RTS Transmission, Ford 4 Speed Overdrive Transmission.	TS27996	1
1979-1985, Except RTS Transmission, Ford 4 Speed Overdrive Transmission.	TS27996	1	1965-1983, Borg Warner 3 Speed Transmission	TS27545Y	1
1975-1989, Borg Warner 3 Speed Transmission	TS27545Y	1	1965-1983, New Process 4 Speed Transmission, New Process 435 Transmission	TS27576Y	1
1975-1989, Ford 3 Speed Transmission	TS27817X	1	1965-1966, Borg Warner 4 Speed Transmission	TS27576	1
1975-1988, New Process 4 Speed Transmission, New Process 435 Transmission	TS27576Y	1	1963-1983, Ford 3 Speed Transmission	TS27817X	1
Transmission Pan Gasket			1961-1962, Ford 3 Speed Transmission		
1993-1996, AODEW Transmission	W39141	1	1960, Except Transmission Number C0TR7004-A-C, Ford 3 Speed Transmission	TS27051W	1
1989-1996, E4OD Transmission	W38158	1	1955-1956, 4 Speed Transmission, Heavy Duty Transmission	TS27545Y	1
1985-1996, A4LD Automatic Transmission, Tuff-Cork	W38144TC	1	1955-1956, 4 Speed Transmission, Light Duty Transmission	TS27576	1
1983-1986, C5 Automatic Transmission, Dual Range.	W39349	1	1953-1959, Ford 3 Speed Transmission	TS27051W	1
1983-1986, C5 Automatic Transmission, Dual Range, Tuff-Cork.	W39349TC	1	1953-1954, 4 Speed Transmission	TS27576	1
1981-1993, F10D Automatic Overdrive Transmission.	W38430	1	Transmission Pan Gasket		
1980-1982, C4 Automatic Transmission, C5 Automatic Transmission, Dual Range.	W39349	1	1982-1983, C5 Automatic Transmission, Dual Range, Tuff-Cork.		
1980-1982, C4 Automatic Transmission, C5 Automatic Transmission, Dual Range, Tuff-Cork	W39349TC	1	1981-1983, F10D Automatic Overdrive Transmission.		
1975-1996, C6 Automatic Transmission, Dual Range.	W39346	1	1981-1982, C4 Automatic Transmission, C5 Automatic Transmission, Dual Range.		
1975-1996, C6 Automatic Transmission, Dual Range, Tuff-Cork.	W39346TC	1	1981-1982, C4 Automatic Transmission, C5 Automatic Transmission, Dual Range, Tuff-Cork		
1975-1981, C4 Automatic Transmission, Dual Range.	W39349	1	1981, C4 Automatic Transmission, Dual Range.		
1975-1981, C4 Automatic Transmission, Dual Range, Tuff-Cork.	W39349TC	1	1981, C4 Automatic Transmission, Dual Range, Tuff-Cork.		
1975-1978, Cruise-O-Matic Transmission	W38987	1	1980-1982, C4 Automatic Transmission, C5 Automatic Transmission, Dual Range.		
EXPLORER			1980-1982, C4 Automatic Transmission, C5 Automatic Transmission, Dual Range, Tuff-Cork		
Transmission Pan Gasket			1973-1978, Cruise-O-Matic Transmission		
1996-1997, C6 Automatic Transmission, Dual Range.	W39346	1	1970-1981, C4 Automatic Transmission, Dual Range.		
1996-1997, C6 Automatic Transmission, Dual Range, Tuff-Cork.	W39346TC	1	1970-1981, C4 Automatic Transmission, Dual Range, Tuff-Cork.		
1993-1997, AODEW Transmission	W39141	1	1968-1983, C6 Automatic Transmission, Dual Range.		
1991-1997, A4LD Automatic Transmission, Tuff-Cork	W38144TC	1	1968-1983, C6 Automatic Transmission, Dual Range, Tuff-Cork.		
1991-1997, E4OD Transmission	W38158	1	1965-1972, Cruise-O-Matic Transmission, 14 Bolt Holes.		
1991-1993, F10D Automatic Overdrive Transmission.	W38430	1	1964-1969, Automatic 3 Speed Transmission, Dual Range.		
F1			1959-1966, Cruise-O-Matic Transmission, 13 Bolt Holes.		
Transmission Gasket Set			1957-1964, Cruise-O-Matic Transmission, Ford-O-Matic Transmission.		
1948-1952, Except Spur Gear	TS27576	1	1953-1961, Ford-O-Matic Transmission		
F100					
Transfer Case Gasket Set					
1973-1979, New Process 203, 203F	TS27292	1			

LIGHT TRUCK

Transmission Gaskets (cont.)

<i>Model & Application</i>	<i>Part No.</i>	<i>Qty.</i>	<i>Model & Application</i>	<i>Part No.</i>	<i>Qty.</i>
F150			F250 (cont.)		
Transfer Case Gasket Set			Transmission Gasket Set (cont.)		
1975-1979, New Process 203, 203F	TS27292	1	1955-1956, 4 Speed Transmission, Light Duty Transmission	TS27576	1
1975-1979, New Process 205, 205F	TS27275	1	1953-1958, Ford 3 Speed Transmission	TS27051W	1
1975-1979, Spicer 21 TC	TS27305	1	1953-1954, 4 Speed Transmission	TS27576	1
Transmission Gasket Set			Transmission Pan Gasket		
1979-1985, Borg Warner T18 4 Speed Transmission, Borg Warner T19 4 Speed Transmission	TS27246	1	1993-1997, AODEW Transmission	W39141	1
1979-1985, Except RTS Transmission, Ford 4 Speed Overdrive Transmission	TS27996	1	1989-1997, E4OD Transmission	W38158	1
1975-1989, Borg Warner 3 Speed Transmission	TS27545Y	1	1985-1997, A4LD Automatic Transmission, Tuff-Cork	W38144TC	1
1975-1989, Ford 3 Speed Transmission	TS27817X	1	1982-1986, C5 Automatic Transmission, Dual Range	W39349	1
1975-1988, New Process 4 Speed Transmission, New Process 435 Transmission	TS27576Y	1	1982-1986, C5 Automatic Transmission, Dual Range, Tuff-Cork	W39349TC	1
Transmission Pan Gasket			1981-1993, F10D Automatic Overdrive Transmission		
1993-1996, AODEW Transmission	W39141	1	1980-1982, C4 Automatic Transmission, C5 Automatic Transmission, Dual Range		
1989-1996, E4OD Transmission	W38158	1	1980-1982, C4 Automatic Transmission, C5 Automatic Transmission, Dual Range, Tuff-Cork		
1985-1996, A4LD Automatic Transmission, Tuff-Cork	W38144TC	1	1973-1978, Cruise-O-Matic Transmission		
1982-1986, C5 Automatic Transmission, Dual Range	W39349	1	1970-1981, C4 Automatic Transmission, Dual Range		
1982-1986, C5 Automatic Transmission, Dual Range, Tuff-Cork	W39349TC	1	1970-1981, C4 Automatic Transmission, Dual Range, Tuff-Cork		
1981-1993, F10D Automatic Overdrive Transmission	W38430	1	1968-1997, C6 Automatic Transmission, Dual Range		
1975-1996, C6 Automatic Transmission, Dual Range	W39346	1	1968-1997, C6 Automatic Transmission, Dual Range, Tuff-Cork		
1975-1996, C6 Automatic Transmission, Dual Range, Tuff-Cork	W39346TC	1	1965-1972, Cruise-O-Matic Transmission, 14 Bolt Holes		
1975-1981, C4 Automatic Transmission, Dual Range	W39349	1	1964-1969, Automatic 3 Speed Transmission, Dual Range		
1975-1981, C4 Automatic Transmission, Dual Range, Tuff-Cork	W39349TC	1	1959-1966, Cruise-O-Matic Transmission, 13 Bolt Holes		
1975-1978, Cruise-O-Matic Transmission	W38987	1	1957-1964, Cruise-O-Matic Transmission, Ford-O-Matic Transmission		
F2			1953-1961, Ford-O-Matic Transmission		
Transmission Gasket Set			F3		
1948-1952, Except Spur Gear	TS27576	1	Transmission Gasket Set		
F250			1948-1952, Except Spur Gear		
Transfer Case Gasket Set			TS27576 1		
1973-1979, New Process 203, 203F	TS27292	1	F350		
1973-1979, New Process 205, 205F	TS27275	1	Transfer Case Gasket Set		
1973-1979, Spicer 21 TC	TS27305	1	1973-1979, New Process 203, 203F		
1959-1972	TS27360	1	1973-1979, New Process 205, 205F		
Transmission Gasket Set			1973-1979, Spicer 21 TC		
1979-1985, Borg Warner T18 4 Speed Transmission, Borg Warner T19 4 Speed Transmission	TS27246	1	1959-1965		
1979-1985, Except RTS Transmission, Ford 4 Speed Overdrive Transmission	TS27996	1	TS27360 1		
1965-1989, Borg Warner 3 Speed Transmission	TS27545Y	1	Transmission Gasket Set		
1965-1988, New Process 4 Speed Transmission, New Process 435 Transmission	TS27576Y	1	1979-1985, Borg Warner T18 4 Speed Transmission, Borg Warner T19 4 Speed Transmission		
1965-1966, Borg Warner 4 Speed Transmission	TS27576	1	1979-1985, Except RTS Transmission, Ford 4 Speed Overdrive Transmission		
1963-1989, Ford 3 Speed Transmission	TS27817X	1	1965-1989, Borg Warner 3 Speed Transmission		
1961-1962, Ford 3 Speed Transmission	TS27051W	1	1965-1988, New Process 4 Speed Transmission, New Process 435 Transmission		
1960, Except Transmission Number C0TR7004-A-C, Ford 3 Speed Transmission	TS27051W	1	1965-1966, Borg Warner 4 Speed Transmission		
1955-1956, 4 Speed Transmission, Heavy Duty Transmission	TS27545Y	1	1963-1989, Ford 3 Speed Transmission		
			1961-1962, Ford 3 Speed Transmission		
			1960, Except Transmission Number C0TR7004-A-C, Ford 3 Speed Transmission		
			TS27051W 1		

LIGHT TRUCK

Ford Truck (cont.)

Transmission Gaskets (cont.)

Model & Application	Part No.	Qty.	Model & Application	Part No.	Qty.
F350 (cont.)			P100 (cont.)		
Transmission Gasket Set (cont.)			P.T.O. Mounting Gasket (cont.)		
1955-1956, 4 Speed Transmission, Heavy Duty Transmission	TS27545Y	1	1961-1967, .020" Thickness, 8 Bolt, Chelsea Power Take Off	H26208	1
1955-1956, 4 Speed Transmission, Light Duty Transmission	TS27576	1	Transmission Gasket Set		
1953-1958, Ford 3 Speed Transmission	TS27051W	1	1967, New Process 4 Speed Transmission, New Process 435 Transmission	TS27576Y	1
1953-1954, 4 Speed Transmission	TS27576	1	1965-1967, Borg Warner 3 Speed Transmission	TS27545Y	1
Transmission Pan Gasket			1965-1966, Borg Warner 4 Speed Transmission	TS27576	1
1993-1997, AODEW Transmission	W39141	1	1963-1967, Ford 3 Speed Transmission	TS27817X	1
1989-1997, E4OD Transmission	W38158	1	1961-1962, Ford 3 Speed Transmission	TS27051W	1
1985-1997, A4LD Automatic Transmission, Tuff-Cork	W38144TC	1	1960-1962, Except Transmission Number C0TR7004-A-C, Ford 3 Speed Transmission	TS27051W	1
1982-1986, C5 Automatic Transmission, Dual Range	W39349	1	Transmission Pan Gasket		
1982-1986, C5 Automatic Transmission, Dual Range, Tuff-Cork	W39349TC	1	1965-1967, Cruise-O-Matic Transmission, 14 Bolt Holes	W38986	1
1981-1993, F10D Automatic Overdrive Transmission	W38430	1	1965-1966, Cruise-O-Matic Transmission, 13 Bolt Holes	W38987	1
1980-1982, C4 Automatic Transmission, C5 Automatic Transmission, Dual Range	W39349	1	1964-1967, Automatic 3 Speed Transmission, Dual Range	W37953	1
1980-1982, C4 Automatic Transmission, C5 Automatic Transmission, Dual Range, Tuff-Cork	W39349TC	1	1960-1961, Ford-O-Matic Transmission	W38987	1
1973-1978, Cruise-O-Matic Transmission	W38987	1	1957-1964, Cruise-O-Matic Transmission, Ford-O-Matic Transmission.	W38987	1
1970-1981, C4 Automatic Transmission, Dual Range	W39349	1	P350		
1970-1981, C4 Automatic Transmission, Dual Range, Tuff-Cork	W39349TC	1	Transmission Gasket Set		
1968-1997, C6 Automatic Transmission, Dual Range	W39346	1	1967-1977, New Process 4 Speed Transmission, New Process 435 Transmission	TS27576Y	1
1968-1997, C6 Automatic Transmission, Dual Range, Tuff-Cork	W39346TC	1	1965-1977, Borg Warner 3 Speed Transmission	TS27545Y	1
1965-1972, Cruise-O-Matic Transmission, 14 Bolt Holes	W38986	1	1965-1966, Borg Warner 4 Speed Transmission	TS27576	1
1964-1969, Automatic 3 Speed Transmission, Dual Range	W37953	1	1963-1977, Ford 3 Speed Transmission	TS27817X	1
1959-1966, Cruise-O-Matic Transmission, 13 Bolt Holes	W38987	1	1961-1962, Ford 3 Speed Transmission	TS27051W	1
1957-1964, Cruise-O-Matic Transmission, Ford-O-Matic Transmission.	W38987	1	1960, Except Transmission Number C0TR7004-A-C, Ford 3 Speed Transmission	TS27051W	1
1953-1961, Ford-O-Matic Transmission	W38987	1	1956-1958, Ford 3 Speed Transmission	TS27051W	1
FALCON			1955-1956, 4 Speed Transmission, Heavy Duty Transmission	TS27545Y	1
Transmission Gasket Set			1955-1956, 4 Speed Transmission, Light Duty Transmission	TS27576	1
1964-1965, 4 Speed Transmission	TS27831	1	1953-1954, 4 Speed Transmission	TS27576	1
1964, 3 Speed Transmission, Except Heavy Duty	TS26399	1	1953, Ford 3 Speed Transmission	TS27051W	1
1964, 3 Speed Transmission, Heavy Duty	TS27075W	1	Transmission Pan Gasket		
Transmission Pan Gasket			1965-1972, Cruise-O-Matic Transmission	W38986	1
1965, Cruise-O-Matic FX, FMX Transmission	W38987	1	1959-1966, Cruise-O-Matic Transmission, 13 Bolt Holes	W38987	1
P100			1959-1964, Cruise-O-Matic Transmission, Ford-O-Matic Transmission.	W38987	1
Elec. Shift Cover Gasket			1953-1961, Ford-O-Matic Transmission	W38987	1
1961-1967, 10 Bolt, Eaton 2 Speed Axle	H36328	1	RANCHERO		
1961-1967, 11 Bolt, Eaton 2 Speed Axle	H36329	1	Transmission Gasket Set		
P.T.O. Cover Gasket			1979, Borg Warner T18 4 Speed Transmission, Borg Warner T19 4 Speed Transmission	TS27246	1
1961-1967, 6 Bolt, Chelsea Power Take Off	H36080	1	1979, Except RTS Transmission, Ford 4 Speed Overdrive Transmission	TS27996	1
1961-1967, 8 Bolt, Chelsea Power Take Off	H36124	1	1968-1979, Borg Warner 3 Speed Transmission	TS27545Y	1
P.T.O. Mounting Gasket			1968-1979, New Process 4 Speed Transmission, New Process 435 Transmission	TS27576Y	1
1961-1967, .010" Thickness, 6 Bolt, Chelsea Power Take Off	H26205	1			
1961-1967, .010" Thickness, 8 Bolt, Chelsea Power Take Off	H26207	1			
1961-1967, .020" Thickness, 6 Bolt, Chelsea Power Take Off	H26206	1			

LIGHT TRUCK

Transmission Gaskets (cont.)

<i>Model & Application</i>	<i>Part No.</i>	<i>Qty.</i>	<i>Model & Application</i>	<i>Part No.</i>	<i>Qty.</i>
RANCHERO (cont.)			SUPER WAGON E150 (cont.)		
Transmission Gasket Set (cont.)			Transmission Pan Gasket (cont.)		
1966-1979, Ford 3 Speed Transmission	TS27817X	1	1978-1981, C4 Automatic Transmission, Dual Range.	W39349	1
Transmission Pan Gasket			1978-1981, C4 Automatic Transmission, Dual Range, Tuff-Cork.	W39349TC	1
1973-1978, Cruise-O-Matic Transmission	W38987	1	1978, Cruise-O-Matic Transmission	W38987	1
1969-1979, C4 Automatic Transmission, Dual Range.	W39349	1	SUPER WAGON E250		
1969-1979, C4 Automatic Transmission, Dual Range, Tuff-Cork.	W39349TC	1	Transmission Gasket Set		
1969, Cruise-O-Matic Transmission	W38987	1	1983, Borg Warner 3 Speed Transmission	TS27545Y	1
1968-1979, C6 Automatic Transmission, Dual Range.	W39346	1	1983, Borg Warner T18 4 Speed Transmission, Borg Warner T19 4 Speed Transmission	TS27246	1
1968-1979, C6 Automatic Transmission, Dual Range, Tuff-Cork.	W39346TC	1	1983, Except RTS Transmission, Ford 4 Speed Overdrive Transmission.	TS27996	1
1968-1969, Automatic 3 Speed Transmission, Dual Range.	W37953	1	1983, Ford 3 Speed Transmission	TS27817X	1
1966-1972, Cruise-O-Matic Transmission	W38986	1	1983, New Process 4 Speed Transmission, New Process 435 Transmission	TS27576Y	1
1966, Cruise-O-Matic Transmission, 13 Bolt Holes	W38987	1	1979-1980, Borg Warner T18 4 Speed Transmission, Borg Warner T19 4 Speed Transmission	TS27246	1
RANGER			1979-1980, Except RTS Transmission, Ford 4 Speed Overdrive Transmission.	TS27996	1
Transmission Gasket Set			1978-1980, Borg Warner 3 Speed Transmission	TS27545Y	1
1983-1989, Ford 3 Speed Transmission	TS27817X	1	1978-1980, Ford 3 Speed Transmission	TS27817X	1
1983-1985, Except RTS Transmission, Ford 4 Speed Overdrive Transmission.	TS27996	1	1978-1980, New Process 4 Speed Transmission, New Process 435 Transmission	TS27576Y	1
Transmission Pan Gasket			Transmission Pan Gasket		
1993-1997, AODEW Transmission	W39141	1	1983, C5 Automatic Transmission, Dual Range.	W39349	1
1989-1997, E4OD Transmission	W38158	1	1983, C5 Automatic Transmission, Dual Range, Tuff-Cork.	W39349TC	1
1985-1997, A4LD Automatic Transmission, Tuff-Cork	W38144TC	1	1983, C6 Automatic Transmission, Dual Range.	W39346	1
1983-1993, F10D Automatic Overdrive Transmission.	W38430	1	1983, C6 Automatic Transmission, Dual Range, Tuff-Cork.	W39346TC	1
1983-1986, C5 Automatic Transmission, Dual Range.	W39349	1	1983, F10D Automatic Overdrive Transmission.	W38430	1
1983-1986, C5 Automatic Transmission, Dual Range, Tuff-Cork.	W39349TC	1	1978-1980, C4 Automatic Transmission, Dual Range.	W39349	1
1983-1984, C3 Automatic Transmission, Dual Range.	W37978	1	1978-1980, C4 Automatic Transmission, Dual Range, Tuff-Cork.	W39349TC	1
SUPER WAGON E150			1978-1980, C6 Automatic Transmission, Dual Range.	W39346	1
Transmission Gasket Set			1978-1980, C6 Automatic Transmission, Dual Range, Tuff-Cork.	W39346TC	1
1979-1983, Borg Warner T18 4 Speed Transmission, Borg Warner T19 4 Speed Transmission	TS27246	1	1978, Cruise-O-Matic Transmission	W38987	1
1979-1983, Except RTS Transmission, Ford 4 Speed Overdrive Transmission.	TS27996	1	SUPER WAGON E350		
1978-1983, Borg Warner 3 Speed Transmission	TS27545Y	1	Transmission Gasket Set		
1978-1983, Ford 3 Speed Transmission	TS27817X	1	1979-1983, Borg Warner T18 4 Speed Transmission, Borg Warner T19 4 Speed Transmission	TS27246	1
1978-1983, New Process 4 Speed Transmission, New Process 435 Transmission	TS27576Y	1	1979-1983, Except RTS Transmission, Ford 4 Speed Overdrive Transmission.	TS27996	1
Transmission Pan Gasket			1978-1983, Borg Warner 3 Speed Transmission	TS27545Y	1
1982-1983, C5 Automatic Transmission, Dual Range.	W39349	1	1978-1983, Ford 3 Speed Transmission	TS27817X	1
1982-1983, C5 Automatic Transmission, Dual Range, Tuff-Cork.	W39349TC	1	1978-1983, New Process 4 Speed Transmission, New Process 435 Transmission	TS27576Y	1
1981-1983, F10D Automatic Overdrive Transmission.	W38430	1	Transmission Pan Gasket		
1980-1982, C4 Automatic Transmission, C5 Automatic Transmission, Dual Range.	W39349	1	1982-1983, C5 Automatic Transmission, Dual Range.	W39349	1
1980-1982, C4 Automatic Transmission, C5 Automatic Transmission, Dual Range, Tuff-Cork	W39349TC	1	1982-1983, C5 Automatic Transmission, Dual Range, Tuff-Cork.	W39349TC	1
1978-1983, C6 Automatic Transmission, Dual Range.	W39346	1	LIGHT TRUCK		
1978-1983, C6 Automatic Transmission, Dual Range, Tuff-Cork.	W39346TC	1			

Ford Truck (cont.)

Transmission Gaskets (cont.)

<i>Model & Application</i>	<i>Part No.</i>	<i>Qty.</i>	<i>Model & Application</i>	<i>Part No.</i>	<i>Qty.</i>
SUPER WAGON E350 (cont.)			SUPER WAGON E350 (cont.)		
Transmission Pan Gasket (cont.)			Transmission Pan Gasket (cont.)		
1981-1983, F10D Automatic Overdrive Transmission.	W38430	1	1978, Cruise-O-Matic Transmission	W38987	1
1980-1982, C4 Automatic Transmission, C5 Automatic Transmission, Dual Range.	W39349	1	VILLAGER		
1980-1982, C4 Automatic Transmission, C5 Automatic Transmission, Dual Range, Tuff-Cork	W39349TC	1	Transmission Pan Gasket		
1978-1983, C6 Automatic Transmission, Dual Range.	W39346	1	1993-1997, 4F20E Automatic Overdrive Transmission.		
1978-1983, C6 Automatic Transmission, Dual Range, Tuff-Cork.	W39346TC	1	W39380 1		
1978-1981, C4 Automatic Transmission, Dual Range.	W39349	1	WINDSTAR		
1978-1981, C4 Automatic Transmission, Dual Range, Tuff-Cork.	W39349TC	1	Transmission Pan Gasket		
			1995-1997, A4LD Automatic Transmission, Tuff-Cork		
			W38144TC 1		
			1995-1997, AODEW Transmission		
			W39141 1		
			1995-1997, E4OD Transmission		
			W38158 1		

General Motors Truck

Axle Shaft Gaskets

<i>Model & Application</i>	<i>Part No.</i>	<i>Qty.</i>	<i>Model & Application</i>	<i>Part No.</i>	<i>Qty.</i>
250			C20 SUBURBAN		
Brake Backing Plate			Axle Shaft Gasket		
1947-1959, Rear Axle	J17829	2	1979-1986, 10-1/2" Ring Gear, Rear Axle	J17829	2
2500			Brake Backing Plate		
Brake Backing Plate			1967-1970, Except Dana Axle, Rear Axle		
1965-1966, Except Dana Axle, Rear Axle	J17829	2	J17829 2		
1960-1964, Rear Axle	J17829	2	C2500		
300 SERIES			Axle Shaft Gasket		
Brake Backing Plate			1988-1990, Rear Axle		
1947, Except 11000 Pound Axle, Rear Axle	J17829	2	J17829 2		
3100			C2500 SUBURBAN(GMC)		
Brake Backing Plate			Axle Shaft Gasket		
1947-1959, Except 11000 Pound Axle, Rear Axle.	J17829	2	1979-1986, 10-1/2" Ring Gear, Rear Axle		
3200			J17829 2		
Brake Backing Plate			Brake Backing Plate		
1955-1959, Except 11000 Pound Axle, Rear Axle.	J17829	2	1967-1970, Except Dana Axle, Rear Axle		
3600			J17829 2		
Brake Backing Plate			C2500(GMC)		
1947-1959, Except 11000 Pound Axle, Rear Axle.	J17829	2	Axle Shaft Gasket		
3800			1988-1990, 10-1/2" Ring Gear, Rear Axle		
Brake Backing Plate			J17829 2		
1947-1959, Except 11000 Pound Axle, Rear Axle.	J17829	2	1979-1986, 10-1/2" Ring Gear, Rear Axle		
C20			J17829 2		
Axle Shaft Gasket			Brake Backing Plate		
1979-1986, 10-1/2" Ring Gear, Rear Axle	J17829	2	1967-1970, Except Dana Axle, Rear Axle		
Brake Backing Plate			J17829 2		
1965-1970, Except Dana Axle, Rear Axle	J17829	2	C30		
1960-1964	J17829	2	Axle Shaft Gasket		
			1978-1986, 10-1/2" Ring Gear, Rear Axle		
			J17829 2		
			Brake Backing Plate		
			1970-1972, Except 1100 Pound Axle, Rear Axle.		
			J17829 2		
			1960-1972, Except 11000 Pound Axle, Rear Axle.		
			J17829 2		
			C3500		
			Axle Shaft Gasket		
			1988-1990, 10-1/2" Ring Gear, Rear Axle		
			J17829 2		
			C3500(GMC)		
			Axle Shaft Gasket		
			1988-1990, 10-1/2" Ring Gear, Rear Axle		
			J17829 2		
			1978-1986, 10-1/2" Ring Gear, Rear Axle		
			J17829 2		

LIGHT TRUCK

General Motors Truck (cont.)

Axle Shaft Gaskets (cont.)

<i>Model & Application</i>	<i>Part No.</i>	<i>Qty.</i>	<i>Model & Application</i>	<i>Part No.</i>	<i>Qty.</i>
C3500(GMC) (cont.)			K3500(GMC)		
Brake Backing Plate			Axle Shaft Gasket		
1967-1972, Except 11000 Pound Axle, Rear Axle.			1988-1990, 10-1/2" Ring Gear, Rear Axle		
	J17829	2		J17829	2
			1978-1986, 10-1/2" Ring Gear, Rear Axle		
				J17829	2
G20			P20		
Axle Shaft Gasket			Axle Shaft Gasket		
1979-1990, 10-1/2" Ring Gear, Rear Axle			1979-1989, 10-1/2" Ring Gear, Rear Axle		
	J17829	2		J17829	2
Brake Backing Plate			Brake Backing Plate		
1967-1970, Except Dana Axle, Rear Axle			1971-1972, Rear Axle		
	J17829	2		J17829	2
			1965-1971, Except Dana Axle, Rear Axle		
				J17829	2
			1960-1964, Rear Axle		
				J17829	2
G2500(GMC)			P2500(GMC)		
Axle Shaft Gasket			Axle Shaft Gasket		
1979-1990, 10-1/2" Ring Gear, Rear Axle			1979-1989, 10-1/2" Ring Gear, Rear Axle		
	J17829	2		J17829	2
Brake Backing Plate			Brake Backing Plate		
1967-1970, Except Dana Axle, Rear Axle			1965-1970, Except Dana Axle, Rear Axle		
	J17829	2		J17829	2
G30			P30		
Axle Shaft Gasket			Axle Shaft Gasket		
1978-1990, 10-1/2" Ring Gear, Rear Axle			1978-1990, 10-1/2" Ring Gear, Rear Axle		
	J17829	2		J17829	2
Brake Backing Plate			Brake Backing Plate		
1971-1972, Except 11000 Pound Axle, Rear Axle.			1960-1972, Except 11000 Pound Axle, Rear Axle.		
	J17829	2		J17829	2
G3500(GMC)			P3500(GMC)		
Axle Shaft Gasket			Axle Shaft Gasket		
1978-1990, 10-1/2" Ring Gear, Rear Axle			1978-1990, 10-1/2" Ring Gear, Rear Axle		
	J17829	2		J17829	2
Brake Backing Plate			Brake Backing Plate		
1971-1972, Except 11000 Pound Axle, Rear Axle.			1967-1972, Except 11000 Pound Axle, Rear Axle.		
	J17829	2		J17829	2
K20			PB2500		
Axle Shaft Gasket			Brake Backing Plate		
1979-1986, 10-1/2" Ring Gear, Rear Axle			1965-1966, Except Dana Axle, Rear Axle		
	J17829	2		J17829	2
Brake Backing Plate			1963-1964, Rear Axle		
1965-1970, Except Dana Axle, Rear Axle				J17829	2
	J17829	2		J17829	2
				J17829	2
K20 SUBURBAN			PM250		
Brake Backing Plate			Brake Backing Plate		
1967-1970, Except Dana Axle, Rear Axle			1951-1959, Rear Axle		
	J17829	2		J17829	2
K2500			R20		
Axle Shaft Gasket			Axle Shaft Gasket		
1988-1990, 10-1/2" Ring Gear, Rear Axle			1987-1988, 10-1/2" Ring Gear, Rear Axle		
	J17829	2		J17829	2
K2500 SUBURBAN(GMC)			R20 SUBURBAN		
Axle Shaft Gasket			Axle Shaft Gasket		
1979-1986, 10-1/2" Ring Gear, Rear Axle			1987-1988, 10-1/2" Ring Gear, Rear Axle		
	J17829	2		J17829	2
Brake Backing Plate			R2500		
1967-1970, Except Dana Axle, Rear Axle			Axle Shaft Gasket		
	J17829	2	1989, 10-1/2" Ring Gear, Rear Axle		
				J17829	2
K2500(GMC)			R2500 SUBURBAN		
Axle Shaft Gasket			Axle Shaft Gasket		
1988-1990, 10-1/2" Ring Gear, Rear Axle			1989-1990, 10-1/2" Ring Gear, Rear Axle		
	J17829	2		J17829	2
1979-1986, 10-1/2" Ring Gear, Rear Axle			R2500 SUBURBAN (GMC)		
	J17829	2	Axle Shaft Gasket		
Brake Backing Plate			1987-1990, 10-1/2" Ring Gear, Rear Axle		
1967-1970, Except Dana Axle, Rear Axle				J17829	2
	J17829	2	R2500(GMC)		
K30			Axle Shaft Gasket		
Axle Shaft Gasket			1987-1989, 10-1/2" Ring Gear, Rear Axle		
1978-1986, 10-1/2" Ring Gear, Rear Axle				J17829	2
	J17829	2	R2500(GMC)		
K3500			Axle Shaft Gasket		
Axle Shaft Gasket			1987-1989, 10-1/2" Ring Gear, Rear Axle		
1988-1990, 10-1/2" Ring Gear, Rear Axle				J17829	2
	J17829	2			

LIGHT TRUCK

General Motors Truck (cont.)

Differential Housing Cover Gaskets (cont.)

<i>Model & Application</i>	<i>Part No.</i>	<i>Qty.</i>	<i>Model & Application</i>	<i>Part No.</i>	<i>Qty.</i>
AVALANCHE 1500			BRAVADA (cont.)		
Axle Hsg Cover Gasket			Axle Hsg Cover Gasket (cont.)		
2002, 8-1/2" Ring Gear, 8-5/8" Ring Gear, 10 Bolt Holes, Rear Axle	P27857	1	1996-2001, 8-1/2" Ring Gear, 8-5/8" Ring Gear, 10 Bolt Holes, Rear Axle.	P27857	1
2002, 8-1/2" Ring Gear, 8-5/8" Ring Gear, 10 Bolt Holes, Rear Axle, Tuff-Cork	P27857TC	1	1996-2001, 8-1/2" Ring Gear, 8-5/8" Ring Gear, 10 Bolt Holes, Rear Axle, Tuff-Cork.	P27857TC	1
BLAZER			1994, 7-5/8" Ring Gear, Rear Axle		
Axle Hsg Cover Gasket			P27872 1		
1996-2002, 8-1/2" Ring Gear, 8-5/8" Ring Gear, 10 Bolt Holes, Rear Axle.	P27857	1	1994, 8-1/2" Ring Gear, 10 Bolt Holes, Rear Axle	P27857	1
1996-2002, 8-1/2" Ring Gear, 8-5/8" Ring Gear, 10 Bolt Holes, Rear Axle, Tuff-Cork.	P27857TC	1	1994, 8-1/2" Ring Gear, 10 Bolt Holes, Rear Axle, Tuff-Cork	P27857TC	1
1995-2003, 7-5/8" Ring Gear, Rear Axle	P27872	1	1992-1993, Rear Axle	P27872	1
1995, 8-1/2" Ring Gear, 10 Bolt Holes, Rear Axle	P27857	1	C10		
1995, 8-1/2" Ring Gear, 10 Bolt Holes, Rear Axle, Tuff-Cork	P27857TC	1	Axle Hsg Cover Gasket		
1992-1994, 9-1/2" Ring Gear, Rear Axle, Tuff-Cork.	P29139TC	1	1979-1982, Except Posi-Trac, 10 Bolt Holes, Rear Axle.		
1983-1994, 10 Bolt Holes, Rear Axle	P27857	1	1979-1982, Except Posi-Trac, 10 Bolt Holes, Rear Axle, Tuff-Cork.		
1983-1994, 10 Bolt Holes, Rear Axle, Tuff-Cork.	P27857TC	1	1971-1982, 12 Bolt Holes, Posi-Trac, Rear Axle		
1982, Except Posi-Trac, 10 Bolt Holes, Rear Axle	P27857	1	1971-1982, 12 Bolt Holes, Posi-Trac, Rear Axle, Tuff-Cork		
1982, Except Posi-Trac, 10 Bolt Holes, Rear Axle, Tuff-Cork	P27857TC	1	1964-1970, Leaf Spring Suspension, Rear Axle.		
1979-1982, Except Posi-Trac, 10 Bolt Holes	P27857	1	1964-1970, Leaf Spring Suspension, 10 Bolt Holes, Rear Axle, Tuff-Cork.		
1979-1982, Except Posi-Trac, 10 Bolt Holes, Rear Axle	P27857	1	1963-1970, Except Leaf Springs, Rear Axle		
1979-1982, Except Posi-Trac, 10 Bolt Holes, Tuff-Cork.	P27857TC	1	1963-1970, Except Leaf Springs, Rear Axle, Tuff-Cork.		
1979-1982, Except Posi-Trac, 10 Bolt Holes, Rear Axle, Tuff-Cork.	P27857TC	1	Diff. Carrier Gasket		
1977-1990, General Motors Axle, Front Axle	P27990	1	1960-1963		
1973-1982, 12 Bolt Holes, Posi-Trac, Rear Axle	P27940	1	C10 SUBURBAN		
1973-1982, 12 Bolt Holes, Posi-Trac, Rear Axle, Tuff-Cork	P27940TC	1	Axle Hsg Cover Gasket		
1969-1972, 12 Bolt Holes, Except Leaf Springs, Rear Axle.	P27940	1	1979-1982, Except Posi-Trac, 10 Bolt Holes, Rear Axle.		
1969-1972, 12 Bolt Holes, Except Leaf Springs.	P27940	1	1979-1982, Except Posi-Trac, 10 Bolt Holes, Rear Axle, Tuff-Cork.		
1969-1972, 12 Bolt Holes, Except Leaf Springs, Rear Axle.	P27940	1	1971-1982, 12 Bolt Holes, Posi-Trac, Rear Axle		
1969-1972, 12 Bolt Holes, Except Leaf Springs, Rear Axle, Tuff-Cork.	P27940TC	1	1971-1982, 12 Bolt Holes, Posi-Trac, Rear Axle, Tuff-Cork		
1969-1972, 12 Bolt Holes, Except Leaf Springs, Tuff-Cork	P27940TC	1	1964-1970, Leaf Spring Suspension, Rear Axle.		
1969-1972, 12 Bolt Holes, Except Leaf Springs, Rear Axle, Tuff-Cork.	P27940TC	1	1964-1970, Leaf Spring Suspension, 10 Bolt Holes, Rear Axle, Tuff-Cork.		
1969-1972, General Motors Axle, Front Axle	P39130	1	1963-1970, Except Leaf Springs, Rear Axle		
1969-1970, Leaf Spring Suspension, Rear Axle.	P27768T	1	1963-1970, Except Leaf Springs, Rear Axle, Tuff-Cork.		
1969-1970, Leaf Spring Suspension, 10 Bolt Holes, Rear Axle, Tuff-Cork	P27768TC	1	Diff. Carrier Gasket		
BLAZER XTREME			1960-1963		
Axle Hsg Cover Gasket			C1500		
2002-2003, 7-5/8" Ring Gear, Rear Axle	P27872	1	Axle Hsg Cover Gasket		
2002, 8-1/2" Ring Gear, 8-5/8" Ring Gear, 10 Bolt Holes, Rear Axle	P27857	1	1996-1999, 8-1/2" Ring Gear, 8-5/8" Ring Gear, 10 Bolt Holes, Rear Axle.		
2002, 8-1/2" Ring Gear, 8-5/8" Ring Gear, 10 Bolt Holes, Rear Axle, Tuff-Cork	P27857TC	1	1996-1999, 8-1/2" Ring Gear, 8-5/8" Ring Gear, 10 Bolt Holes, Rear Axle, Tuff-Cork.		
BRAVADA			1991-1996, 9-1/2" Ring Gear, Rear Axle, Tuff-Cork.		
Axle Hsg Cover Gasket			P29139TC 1		
1996-2001, 7-5/8" Ring Gear, Rear Axle	P27872	1	C1500 SUBURBAN		
Axle Hsg Cover Gasket			Axle Hsg Cover Gasket		
1996-1999, 8-1/2" Ring Gear, 8-5/8" Ring Gear, 10 Bolt Holes, Rear Axle.	P27857	1	1996-1999, 8-1/2" Ring Gear, 8-5/8" Ring Gear, 10 Bolt Holes, Rear Axle.		
1996-1999, 8-1/2" Ring Gear, 8-5/8" Ring Gear, 10 Bolt Holes, Rear Axle, Tuff-Cork.	P27857TC	1	1996-1999, 8-1/2" Ring Gear, 8-5/8" Ring Gear, 10 Bolt Holes, Rear Axle, Tuff-Cork.		

LIGHT TRUCK

General Motors Truck (cont.)

Differential Housing Cover Gaskets (cont.)

Model & Application	Part No.	Qty.	Model & Application	Part No.	Qty.
C1500 SUBURBAN (cont.)			C20 SUBURBAN		
Axle Hsg Cover Gasket (cont.)			Axle Hsg Cover Gasket		
1992-1996, 9-1/2" Ring Gear, Rear Axle, Tuff-Cork	P29139TC	1	1984-1986, 10-1/2" Ring Gear, Rear Axle	P28128	1
C1500 SUBURBAN(GMC)			1984-1986, 8-1/2" Ring Gear, 10 Bolt Holes, Rear Axle	P27857	1
Axle Hsg Cover Gasket			1984-1986, 8-1/2" Ring Gear, 10 Bolt Holes, Rear Axle, Tuff-Cork	P27857TC	1
1996, 8-1/2" Ring Gear, 8-5/8" Ring Gear, 10 Bolt Holes, Rear Axle	P27857	1	1984-1986, 9-1/2" Ring Gear, Rear Axle, Tuff-Cork	P29139TC	1
1996, 8-1/2" Ring Gear, 8-5/8" Ring Gear, 10 Bolt Holes, Rear Axle, Tuff-Cork	P27857TC	1	1973-1983, Rear Axle	P28128	1
1992-1996, 9-1/2" Ring Gear, Rear Axle, Tuff-Cork	P29139TC	1	1967-1968, Dana Axle, Rear Axle	P18562	1
1983-1986, 10 Bolt Holes, Rear Axle	P27857	1	1967-1968, Dana Axle, Rear Axle, Tuff-Cork	P18562TC	1
1983-1986, 10 Bolt Holes, Rear Axle, Tuff-Cork	P27857TC	1	1967-1968, Except Dana Axle, Rear Axle	P39130	1
1973-1978, Rear Axle, Tuff-Cork	P27940TC	1	Diff. Carrier Gasket		
1971-1978, Rear Axle	P27940	1	1967-1972	P29129	1
1967-1970, Except Leaf Springs, Rear Axle	P27940	1	C2500		
1967-1970, Except Leaf Springs, Rear Axle, Tuff-Cork	P27940TC	1	Axle Hsg Cover Gasket		
1967-1970, Leaf Spring Suspension, Rear Axle	P27768T	1	1988-1996, 10-1/2" Ring Gear, Rear Axle	P28128	1
1967-1970, Leaf Spring Suspension, 10 Bolt Holes, Rear Axle, Tuff-Cork	P27768TC	1	1988-1996, 8-1/2" Ring Gear, 10 Bolt Holes, Rear Axle	P27857	1
C1500(GMC)			1988-1996, 8-1/2" Ring Gear, 10 Bolt Holes, Rear Axle, Tuff-Cork	P27857TC	1
Axle Hsg Cover Gasket			1988-1996, 9-1/2" Ring Gear, Rear Axle, Tuff-Cork	P29139TC	1
1996-1999, 8-1/2" Ring Gear, 8-5/8" Ring Gear, 10 Bolt Holes, Rear Axle	P27857	1	C2500 SUBURBAN		
1996-1999, 8-1/2" Ring Gear, 8-5/8" Ring Gear, 10 Bolt Holes, Rear Axle, Tuff-Cork	P27857TC	1	Axle Hsg Cover Gasket		
1991-1996, 9-1/2" Ring Gear, Rear Axle, Tuff-Cork	P29139TC	1	1992-1996, 10-1/2" Ring Gear, Rear Axle	P28128	1
1988-1990, 10 Bolt Holes, Rear Axle	P27857	1	1992-1996, 8-1/2" Ring Gear, 10 Bolt Holes, Rear Axle	P27857	1
1988-1990, 10 Bolt Holes, Rear Axle, Tuff-Cork	P27857TC	1	1992-1996, 8-1/2" Ring Gear, 10 Bolt Holes, Rear Axle, Tuff-Cork	P27857TC	1
1983-1986, 10 Bolt Holes, Rear Axle	P27857	1	1992-1996, 9-1/2" Ring Gear, Rear Axle, Tuff-Cork	P29139TC	1
1983-1986, 10 Bolt Holes, Rear Axle, Tuff-Cork	P27857TC	1	C2500 SUBURBAN(GMC)		
1971-1978, Rear Axle	P27940	1	Axle Hsg Cover Gasket		
1971-1978, Rear Axle, Tuff-Cork	P27940TC	1	1992-1996, 10-1/2" Ring Gear, Rear Axle	P28128	1
1967-1970, Except Leaf Springs, Rear Axle	P27940	1	1992-1996, 8-1/2" Ring Gear, 10 Bolt Holes, Rear Axle	P27857	1
1967-1970, Except Leaf Springs, Rear Axle, Tuff-Cork	P27940TC	1	1992-1996, 8-1/2" Ring Gear, 10 Bolt Holes, Rear Axle, Tuff-Cork	P27857TC	1
1967-1970, Leaf Spring Suspension, Rear Axle	P27768T	1	1992-1996, 9-1/2" Ring Gear, Rear Axle, Tuff-Cork	P29139TC	1
1967-1970, Leaf Spring Suspension, 10 Bolt Holes, Rear Axle, Tuff-Cork	P27768TC	1	1984-1986, 10-1/2" Ring Gear, Rear Axle	P28128	1
C20			1984-1986, 8-1/2" Ring Gear, 10 Bolt Holes, Rear Axle	P27857	1
Axle Hsg Cover Gasket			1984-1986, 8-1/2" Ring Gear, 10 Bolt Holes, Rear Axle, Tuff-Cork	P27857TC	1
1984-1986, 10-1/2" Ring Gear, Rear Axle	P28128	1	1984-1986, 9-1/2" Ring Gear, Rear Axle, Tuff-Cork	P29139TC	1
1984-1986, 8-1/2" Ring Gear, 10 Bolt Holes, Rear Axle	P27857	1	1973-1983, Rear Axle	P28128	1
1984-1986, 8-1/2" Ring Gear, 10 Bolt Holes, Rear Axle, Tuff-Cork	P27857TC	1	1967-1968, Dana Axle, Rear Axle	P18562	1
1984-1986, 9-1/2" Ring Gear, Rear Axle, Tuff-Cork	P29139TC	1	1967-1968, Dana Axle, Rear Axle, Tuff-Cork	P18562TC	1
1973-1983, Rear Axle	P28128	1	1967-1968, Except Dana Axle, Rear Axle	P39130	1
1965-1968, Dana Axle, Rear Axle	P18562	1	Diff. Carrier Gasket		
1965-1968, Dana Axle, Rear Axle, Tuff-Cork	P18562TC	1	1967-1972	P29129	1
1965-1968, Except Dana Axle, Rear Axle	P39130	1	C2500(GMC)		
1960-1964, Rear Axle	P39130	1	Axle Hsg Cover Gasket		
Diff. Carrier Gasket			1988-1996, 10-1/2" Ring Gear, Rear Axle	P28128	1
1960-1972	P29129	1	1988-1996, 8-1/2" Ring Gear, 10 Bolt Holes, Rear Axle	P27857	1
			1988-1996, 8-1/2" Ring Gear, 10 Bolt Holes, Rear Axle, Tuff-Cork	P27857TC	1
			1988-1996, 9-1/2" Ring Gear, Rear Axle, Tuff-Cork	P29139TC	1

LIGHT TRUCK

General Motors Truck (cont.)

Differential Housing Cover Gaskets (cont.)

<i>Model & Application</i>	<i>Part No.</i>	<i>Qty.</i>	<i>Model & Application</i>	<i>Part No.</i>	<i>Qty.</i>
C2500(GMC) (cont.)			C3500(GMC) (cont.)		
Axle Hsg Cover Gasket (cont.)			Axle Hsg Cover Gasket (cont.)		
1984-1986, 10-1/2" Ring Gear, Rear Axle	P28128	1	1981-1986, Except 11000 Pound Axle, Except 14000 Pound Axle, Except Dana Axle, Rear Axle	P28128	1
1984-1986, 8-1/2" Ring Gear, 10 Bolt Holes, Rear Axle	P27857	1	1973-1986, 11000 Pound Axle, 14000 Pound Axle, Dana Axle, Rear Axle	P18562	1
1984-1986, 8-1/2" Ring Gear, 10 Bolt Holes, Rear Axle, Tuff-Cork	P27857TC	1	1973-1986, 11000 Pound Axle, 14000 Pound Axle, Dana Axle, Rear Axle, Tuff-Cork	P18562TC	1
1984-1986, 9-1/2" Ring Gear, Rear Axle, Tuff-Cork	P29139TC	1	1973-1981, Except 11000 Pound Axle, Except 14000 Pound Axle, Rear Axle	P28128	1
1973-1983, Rear Axle	P28128	1	1967-1972, Except 11000 Pound Axle, Rear Axle	P39130	1
1967-1968, Dana Axle, Rear Axle	P18562	1			
1967-1968, Dana Axle, Rear Axle, Tuff-Cork	P18562TC	1			
1967-1968, Except Dana Axle, Rear Axle	P39130	1			
Diff. Carrier Gasket			Diff. Carrier Gasket		
1967-1972	P29129	1	1967-1981, 11000 Pound Axle	P29248	1
			1967-1972, Except 11000 Pound Axle	P29129	1
C30			CLASSIC SIERRA 1500		
Axle Hsg Cover Gasket			Axle Hsg Cover Gasket		
1982-1986, Dana Axle, Rear Axle	P18562	1	1999, 8-1/2" Ring Gear, 8-5/8" Ring Gear, 10 Bolt Holes, Rear Axle	P27857	1
1982-1986, Dana Axle, Rear Axle, Tuff-Cork	P18562TC	1	1999, 8-1/2" Ring Gear, 8-5/8" Ring Gear, 10 Bolt Holes, Rear Axle, Tuff-Cork	P27857TC	1
1982-1986, Except Dana Axle, Rear Axle	P28128	1			
1981-1986, 11000 Pound Axle, 14000 Pound Axle, Dana Axle, Rear Axle	P18562	1			
1981-1986, 11000 Pound Axle, 14000 Pound Axle, Dana Axle, Rear Axle, Tuff-Cork	P18562TC	1			
1981-1986, Except 11000 Pound Axle, Except 14000 Pound Axle, Except Dana Axle, Rear Axle	P28128	1			
1973-1981, 11000 Pound Axle, 14000 Pound Axle, Rear Axle	P18562	1			
1973-1981, 11000 Pound Axle, 14000 Pound Axle, Rear Axle, Tuff-Cork	P18562TC	1			
1973-1981, Except 11000 Pound Axle, Except 14000 Pound Axle, Rear Axle	P28128	1			
1970-1972, Except 1100 Pound Axle, Rear Axle	P39130	1			
1960-1972, Except 11000 Pound Axle, Rear Axle	P39130	1			
1960-1966, 11000 Pound Axle, Rear Axle	P39156	1			
Diff. Carrier Gasket			EL CAMINO		
1970-1972	P29129	1	Diff. Hsg. Cover Gasket		
1967-1981, 11000 Pound Axle	P29248	1	1982-1987, 8-1/2" Ring Gear	P27857	1
1966-1972, Except 11000 Pound Axle	P29129	1	1982-1987, 8-1/2" Ring Gear, Tuff-Cork	P27857TC	1
1966	P29129	1	1976-1987, 7-1/2" Ring Gear, 7-5/8" Ring Gear	P27872	1
1965-1972, Except 11000 Pound Axle	P29129	1	1973-1975	P27857	1
1962-1966	P29129	1	1973-1975, Tuff-Cork	P27857TC	1
1960-1972, Except 11000 Pound Axle	P29129	1	1966-1972, 10 Bolt Holes, 10-5/16" X 10-3/4"	P27939	1
1960-1966	P29129	1	1966-1972, 12 Bolt Holes, 10-5/8" X 10-7/8"	P27944	1
			1966-1972, 12 Bolt Holes, Tuff-Cork, 10-5/8" X 10-7/8"	P27944TC	1
			1964-1966, 12 Bolt Holes, 10-5/8" X 10-7/8"	P27944	1
			1964-1966, 12 Bolt Holes, Tuff-Cork, 10-5/8" X 10-7/8"	P27944TC	1
			ENVOY		
			Axle Hsg Cover Gasket		
			1998-2001, 7-5/8" Ring Gear, Rear Axle	P27872	1
			1998-2001, 8-1/2" Ring Gear, 8-5/8" Ring Gear, 10 Bolt Holes, Rear Axle	P27857	1
			1998-2001, 8-1/2" Ring Gear, 8-5/8" Ring Gear, 10 Bolt Holes, Rear Axle, Tuff-Cork	P27857TC	1
			ESCALADE		
			Axle Hsg Cover Gasket		
			2002, 8-1/2" Ring Gear, 8-5/8" Ring Gear, 10 Bolt Holes, Rear Axle	P27857	1
			2002, 8-1/2" Ring Gear, 8-5/8" Ring Gear, 10 Bolt Holes, Rear Axle, Tuff-Cork	P27857TC	1
			1999-2000, 8-1/2" Ring Gear, 8-5/8" Ring Gear, 10 Bolt Holes, Rear Axle	P27857	1
			1999-2000, 8-1/2" Ring Gear, 8-5/8" Ring Gear, 10 Bolt Holes, Rear Axle, Tuff-Cork	P27857TC	1
			EXPRESS 1500		
			Axle Hsg Cover Gasket		
			1996-2002, 8-1/2" Ring Gear, 8-5/8" Ring Gear, 10 Bolt Holes, Rear Axle	P27857	1
			1996-2002, 8-1/2" Ring Gear, 8-5/8" Ring Gear, 10 Bolt Holes, Rear Axle, Tuff-Cork	P27857TC	1

LIGHT TRUCK

General Motors Truck (cont.)

Differential Housing Cover Gaskets (cont.)

Model & Application	Part No.	Qty.	Model & Application	Part No.	Qty.
EXPRESS 1500 (cont.)			G1500 (cont.)		
Axle Hsg Cover Gasket (cont.)			Axle Hsg Cover Gasket (cont.)		
1996, 9-1/2" Ring Gear, Rear Axle, Tuff-Cork	P29139TC	1	1996-1999, 8-1/2" Ring Gear, 8-5/8" Ring Gear, 10 Bolt Holes, Rear Axle, Tuff-Cork	P27857TC	1
EXPRESS 2500			1996, 9-1/2" Ring Gear, Rear Axle, Tuff-Cork	P29139TC	1
Axle Hsg Cover Gasket			G1500(GMC)		
1996-2001, 10-1/2" Ring Gear, Rear Axle	P28128	1	Axle Hsg Cover Gasket		
1996, 8-1/2" Ring Gear, 10 Bolt Holes, Rear Axle	P27857	1	1996-1999, 8-1/2" Ring Gear, 8-5/8" Ring Gear, 10 Bolt Holes, Rear Axle	P27857	1
1996, 8-1/2" Ring Gear, 10 Bolt Holes, Rear Axle, Tuff-Cork	P27857TC	1	1996-1999, 8-1/2" Ring Gear, 8-5/8" Ring Gear, 10 Bolt Holes, Rear Axle, Tuff-Cork	P27857TC	1
1996, 9-1/2" Ring Gear, Rear Axle, Tuff-Cork	P29139TC	1	1991-1996, 9-1/2" Ring Gear, Rear Axle, Tuff-Cork	P29139TC	1
EXPRESS 2500 EXT			1973-1978, Except Posi-Trac, 10 Bolt Holes, Rear Axle	P27857	1
Axle Hsg Cover Gasket			1973-1978, Except Posi-Trac, 10 Bolt Holes, Rear Axle, Tuff-Cork	P27857TC	1
1996-2001, 10-1/2" Ring Gear, Rear Axle	P28128	1	1973-1978, Posi-Trac, Rear Axle	P27940	1
1996, 8-1/2" Ring Gear, 10 Bolt Holes, Rear Axle	P27857	1	1973-1978, Posi-Trac, Rear Axle, Tuff-Cork	P27940TC	1
1996, 8-1/2" Ring Gear, 10 Bolt Holes, Rear Axle, Tuff-Cork	P27857TC	1	1967-1972, 2400 Pound Axle, 3.36 Ratio, Rear Axle	P27939	1
1996, 9-1/2" Ring Gear, Rear Axle, Tuff-Cork	P29139TC	1	1967-1972, 3000 Pound Axle, Except 3.08, 3.36 Ratio, Rear Axle	P27940	1
EXPRESS 3500			1967-1972, 3000 Pound Axle, Except 3.08, 3.36 Ratio, Rear Axle, Tuff-Cork	P27940TC	1
Axle Hsg Cover Gasket			G20		
1996, 10-1/2" Ring Gear, Rear Axle	P28128	1	Axle Hsg Cover Gasket		
1996, 9-1/2" Ring Gear, Rear Axle, Tuff-Cork	P29139TC	1	1984-1995, 10-1/2" Ring Gear, Rear Axle	P28128	1
EXPRESS 3500 EXT			1984-1995, 8-1/2" Ring Gear, 10 Bolt Holes, Rear Axle	P27857	1
Axle Hsg Cover Gasket			1984-1995, 8-1/2" Ring Gear, 10 Bolt Holes, Rear Axle, Tuff-Cork	P27857TC	1
1997-2002, 8-1/2" Ring Gear, 8-5/8" Ring Gear, 10 Bolt Holes, Rear Axle	P27857	1	1984-1995, 9-1/2" Ring Gear, Rear Axle, Tuff-Cork	P29139TC	1
1996, 10-1/2" Ring Gear, Rear Axle	P28128	1	1982-1983, 7500 Pound Axle, Rear Axle	P18562	1
1996, 9-1/2" Ring Gear, Rear Axle, Tuff-Cork	P29139TC	1	1982-1983, 7500 Pound Axle, Rear Axle, Tuff-Cork	P18562TC	1
G10			1979-1983, Except 7500 Pound Axle, Except Posi-Trac, 10 Bolt Holes, Rear Axle	P27857	1
Axle Hsg Cover Gasket			1979-1983, Except 7500 Pound Axle, Except Posi-Trac, 10 Bolt Holes, Rear Axle, Tuff-Cork	P27857TC	1
1991-1995, 9-1/2" Ring Gear, Rear Axle, Tuff-Cork	P29139TC	1	1967-1968, Rear Axle	P27940	1
1973-1982, Posi-Trac, Rear Axle	P27940	1	1967-1968, Rear Axle, Tuff-Cork	P27940TC	1
1973-1982, Posi-Trac, Rear Axle, Tuff-Cork	P27940TC	1	G2500		
1973-1978, Except Posi-Trac, 10 Bolt Holes, Rear Axle	P27857	1	Axle Hsg Cover Gasket		
1973-1978, Except Posi-Trac, 10 Bolt Holes, Rear Axle, Tuff-Cork	P27857TC	1	1996-1999, 10-1/2" Ring Gear, Rear Axle	P28128	1
1964-1971, 2400 Pound Axle, 3.36 Ratio, Rear Axle	P27939	1	1996, 8-1/2" Ring Gear, 10 Bolt Holes, Rear Axle	P27857	1
1964-1971, 3000 Pound Axle, Except 3.08, 3.36 Ratio, Rear Axle	P27940	1	1996, 8-1/2" Ring Gear, 10 Bolt Holes, Rear Axle, Tuff-Cork	P27857TC	1
1964-1971, 3000 Pound Axle, Except 3.08, 3.36 Ratio, Rear Axle, Tuff-Cork	P27940TC	1	1996, 9-1/2" Ring Gear, Rear Axle, Tuff-Cork	P29139TC	1
G1000			G2500(GMC)		
Axle Hsg Cover Gasket			Axle Hsg Cover Gasket		
1964-1966, 2400 Pound Axle, 3.36 Ratio, Rear Axle	P27939	1	1984-1999, 10-1/2" Ring Gear, Rear Axle	P28128	1
1964-1966, 3000 Pound Axle, Except 3.08, 3.36 Ratio, Rear Axle	P27940	1	1984-1996, 8-1/2" Ring Gear, 10 Bolt Holes, Rear Axle	P27857	1
1964-1966, 3000 Pound Axle, Except 3.08, 3.36 Ratio, Rear Axle, Tuff-Cork	P27940TC	1	1984-1996, 8-1/2" Ring Gear, 10 Bolt Holes, Rear Axle, Tuff-Cork	P27857TC	1
G1500			1984-1996, 9-1/2" Ring Gear, Rear Axle, Tuff-Cork	P29139TC	1
Axle Hsg Cover Gasket			G2500(GMC)		
1996-1999, 8-1/2" Ring Gear, 8-5/8" Ring Gear, 10 Bolt Holes, Rear Axle	P27857	1	Axle Hsg Cover Gasket		

LIGHT TRUCK

Differential Housing Cover Gaskets (cont.)

Model & Application	Part No.	Qty.	Model & Application	Part No.	Qty.
G2500(GMC) (cont.)			G3500(GMC) (cont.)		
Axle Hsg Cover Gasket (cont.)			Axle Hsg Cover Gasket (cont.)		
1983-1993, 8-1/2" Ring Gear, Except 7500 Pound Axle, 10 Bolt Holes, Rear Axle	P27857	1	1973-1981, 11000 Pound Axle, 14000 Pound Axle, Rear Axle	P18562	1
1983-1993, 8-1/2" Ring Gear, Except 7500 Pound Axle, 10 Bolt Holes, Rear Axle, Tuff-Cork	P27857TC	1	1973-1981, 11000 Pound Axle, 14000 Pound Axle, Rear Axle, Tuff-Cork	P18562TC	1
1982-1983, 7500 Pound Axle, Rear Axle	P18562	1	1973-1981, Except 11000 Pound Axle, Except 14000 Pound Axle, Rear Axle	P28128	1
1982-1983, 7500 Pound Axle, Rear Axle, Tuff-Cork	P18562TC	1	1971-1972, Except 11000 Pound Axle, Rear Axle	P39130	1
1982-1983, Except 7500 Pound Axle, 10 Bolt Holes, Rear Axle	P27857	1	Diff. Carrier Gasket		
1982-1983, Except 7500 Pound Axle, 10 Bolt Holes, Rear Axle, Tuff-Cork	P27857TC	1	1971-1981, 11000 Pound Axle	P29248	1
1981-1982, Except 7500 Pound Axle, Except Posi-Trac, 10 Bolt Holes, Rear Axle	P27857	1	1971-1972, Except 11000 Pound Axle	P29129	1
1981-1982, Except 7500 Pound Axle, Except Posi-Trac, 10 Bolt Holes, Rear Axle, Tuff-Cork	P27857TC	1	JIMMY		
1979-1981, Except Posi-Trac, 10 Bolt Holes, Rear Axle	P27857	1	Axle Hsg Cover Gasket		
1979-1981, Except Posi-Trac, 10 Bolt Holes, Rear Axle, Tuff-Cork	P27857TC	1	1996-2001, 8-1/2" Ring Gear, 8-5/8" Ring Gear, 10 Bolt Holes, Rear Axle	P27857	1
1967-1968, Rear Axle	P27940	1	1996-2001, 8-1/2" Ring Gear, 8-5/8" Ring Gear, 10 Bolt Holes, Rear Axle, Tuff-Cork	P27857TC	1
1967-1968, Rear Axle, Tuff-Cork	P27940TC	1	1995-2001, 7-5/8" Ring Gear, Rear Axle	P27872	1
G30			1995, 8-1/2" Ring Gear, 10 Bolt Holes, Rear Axle	P27857	1
Axle Hsg Cover Gasket			1995, 8-1/2" Ring Gear, 10 Bolt Holes, Rear Axle, Tuff-Cork	P27857TC	1
1991-1996, 10-1/2" Ring Gear, Rear Axle	P28128	1	1983-1991, 10 Bolt Holes, Rear Axle	P27857	1
1991-1996, 9-1/2" Ring Gear, Rear Axle, Tuff-Cork	P29139TC	1	1983-1991, 10 Bolt Holes, Rear Axle, Tuff-Cork	P27857TC	1
1982-1990, Dana Axle, Rear Axle	P18562	1	1977-1990, General Motors Axle, Front Axle	P27990	1
1982-1990, Dana Axle, Rear Axle, Tuff-Cork	P18562TC	1	1971-1982, Rear Axle	P27940	1
1982-1990, Except Dana Axle, Rear Axle	P28128	1	1971-1982, Rear Axle, Tuff-Cork	P27940TC	1
1981-1986, 11000 Pound Axle, 14000 Pound Axle, Dana Axle, Rear Axle	P18562	1	1971-1972, General Motors Axle, Front Axle	P39130	1
1981-1986, 11000 Pound Axle, 14000 Pound Axle, Dana Axle, Rear Axle, Tuff-Cork	P18562TC	1	K10		
1981-1986, Except 11000 Pound Axle, Except 14000 Pound Axle, Except Dana Axle, Rear Axle	P28128	1	Axle Hsg Cover Gasket		
1973-1981, 11000 Pound Axle, 14000 Pound Axle, Rear Axle	P18562	1	1983-1986, 10 Bolt Holes, Rear Axle	P27857	1
1973-1981, 11000 Pound Axle, 14000 Pound Axle, Rear Axle, Tuff-Cork	P18562TC	1	1983-1986, 10 Bolt Holes, Rear Axle, Tuff-Cork	P27857TC	1
1973-1981, Except 11000 Pound Axle, Except 14000 Pound Axle, Rear Axle	P28128	1	1977-1986, General Motors Axle, Front Axle	P27990	1
1971-1972, Except 11000 Pound Axle, Rear Axle	P39130	1	1971-1982, 12 Bolt Holes, Rear Axle	P27940	1
Diff. Carrier Gasket			1971-1982, 12 Bolt Holes, Rear Axle, Tuff-Cork	P27940TC	1
1971-1981, 11000 Pound Axle	P29248	1	1969-1970, 12 Bolt Holes, Except Leaf Springs	P27940	1
1971-1972, Except 11000 Pound Axle	P29129	1	1969-1970, 12 Bolt Holes, Except Leaf Springs, Rear Axle	P27940	1
G3500			1969-1970, 12 Bolt Holes, Except Leaf Springs, Tuff-Cork	P27940TC	1
Axle Hsg Cover Gasket			1969-1970, 12 Bolt Holes, Except Leaf Springs, Rear Axle, Tuff-Cork	P27940TC	1
1996, 10-1/2" Ring Gear, Rear Axle	P28128	1	1968-1969, 4 Speed Transmission, Rear Axle	P18562	1
1996, 9-1/2" Ring Gear, Rear Axle, Tuff-Cork	P29139TC	1	1968-1969, 4 Speed Transmission, Rear Axle, Tuff-Cork	P18562TC	1
G3500(GMC)			1966-1972, General Motors Axle, Front Axle	P39130	1
Axle Hsg Cover Gasket			1966-1970, Leaf Spring Suspension, Rear Axle	P27768T	1
1991-1996, 10-1/2" Ring Gear, Rear Axle	P28128	1	1966-1970, Leaf Spring Suspension, 10 Bolt Holes, Rear Axle, Tuff-Cork	P27768TC	1
1991-1996, 9-1/2" Ring Gear, Rear Axle, Tuff-Cork	P29139TC	1	1965, Rear Axle	P27940	1
1982-1990, Dana Axle, Rear Axle	P18562	1	1965, Rear Axle, Tuff-Cork	P27940TC	1
1982-1990, Dana Axle, Rear Axle, Tuff-Cork	P18562TC	1	1964-1970, 12 Bolt Holes, Except Leaf Springs, Rear Axle	P27940	1
1982-1990, Except Dana Axle, Rear Axle	P28128	1	1964-1970, 12 Bolt Holes, Except Leaf Springs, Rear Axle, Tuff-Cork	P27940TC	1
			1964-1965, Rear Axle	P27940	1
			1964-1965, Rear Axle, Tuff-Cork	P27940TC	1

LIGHT TRUCK

General Motors Truck (cont.)

Differential Housing Cover Gaskets (cont.)

Model & Application	Part No.	Qty.	Model & Application	Part No.	Qty.
K10 (cont.)			K1500 SUBURBAN (GMC)		
Diff. Carrier Gasket			Axle Hsg Cover Gasket		
1960-1963	P27848	1	1996-1999, 8-1/2" Ring Gear, 8-5/8" Ring Gear, 10 Bolt Holes, Rear Axle	P27857	1
K10 SUBURBAN			1996-1999, 8-1/2" Ring Gear, 8-5/8" Ring Gear, 10 Bolt Holes, Rear Axle, Tuff-Cork	P27857TC	1
Axle Hsg Cover Gasket			1992-1996, 8-1/2" Ring Gear, 10 Bolt Holes, Rear Axle	P27857	1
1983-1986, 10 Bolt Holes, Rear Axle	P27857	1	1992-1996, 8-1/2" Ring Gear, 10 Bolt Holes, Rear Axle, Tuff-Cork	P27857TC	1
1983-1986, 10 Bolt Holes, Rear Axle, Tuff-Cork	P27857TC	1	1983-1986, 8-1/2" Ring Gear, 10 Bolt Holes, Rear Axle	P27857	1
1977-1986, General Motors Axle, Front Axle	P27990	1	1983-1986, 8-1/2" Ring Gear, 10 Bolt Holes, Rear Axle, Tuff-Cork	P27857TC	1
1971-1982, 12 Bolt Holes, Rear Axle	P27940	1	1983-1986, 8-1/2" Ring Gear, 10 Bolt Holes, Rear Axle, Tuff-Cork	P27857TC	1
1971-1982, 12 Bolt Holes, Rear Axle, Tuff-Cork	P27940TC	1	1977-1986, General Motors Axle, Front Axle	P27990	1
1971-1972, 12 Bolt Holes	P27940	1	1971-1982, Rear Axle	P27940	1
1971-1972, 12 Bolt Holes, Tuff-Cork	P27940TC	1	1971-1982, Rear Axle, Tuff-Cork	P27940TC	1
1969-1970, 12 Bolt Holes, Except Leaf Springs	P27940	1	1968-1970, 4 Speed Transmission, Rear Axle	P18562	1
1969-1970, 12 Bolt Holes, Except Leaf Springs, Rear Axle	P27940	1	1968-1970, 4 Speed Transmission, Rear Axle, Tuff-Cork	P18562TC	1
1969-1970, 12 Bolt Holes, Except Leaf Springs, Tuff-Cork	P27940TC	1	1967-1972, General Motors Axle, Front Axle	P39130	1
1969-1970, 12 Bolt Holes, Except Leaf Springs, Rear Axle, Tuff-Cork	P27940TC	1	1967-1970, 12 Bolt Holes, Except Leaf Springs, Rear Axle	P27940	1
1968-1969, 4 Speed Transmission, Rear Axle	P18562	1	1967-1970, 12 Bolt Holes, Except Leaf Springs, Rear Axle, Tuff-Cork	P27940TC	1
1968-1969, 4 Speed Transmission, Rear Axle, Tuff-Cork	P18562TC	1	1967-1970, Leaf Spring Suspension, Rear Axle	P27768T	1
1966-1972, General Motors Axle, Front Axle	P39130	1	1967-1970, Leaf Spring Suspension, 10 Bolt Holes, Rear Axle, Tuff-Cork	P27768TC	1
1966-1970, Leaf Spring Suspension, Rear Axle	P27768T	1	K1500(GMC)		
1966-1970, Leaf Spring Suspension, 10 Bolt Holes, Rear Axle, Tuff-Cork	P27768TC	1	Axle Hsg Cover Gasket		
1965, Rear Axle	P27940	1	1996-1999, 8-1/2" Ring Gear, 8-5/8" Ring Gear, 10 Bolt Holes, Rear Axle	P27857	1
1965, Rear Axle, Tuff-Cork	P27940TC	1	1996-1999, 8-1/2" Ring Gear, 8-5/8" Ring Gear, 10 Bolt Holes, Rear Axle, Tuff-Cork	P27857TC	1
1964-1970, 12 Bolt Holes, Except Leaf Springs, Rear Axle	P27940	1	1996, 9-1/2" Ring Gear, Rear Axle, Tuff-Cork	P29139TC	1
1964-1970, 12 Bolt Holes, Except Leaf Springs, Rear Axle, Tuff-Cork	P27940TC	1	1988-1996, 8-1/2" Ring Gear, 10 Bolt Holes, Rear Axle	P27857	1
1964-1965, Rear Axle	P27940	1	1988-1996, 8-1/2" Ring Gear, 10 Bolt Holes, Rear Axle, Tuff-Cork	P27857TC	1
1964-1965, Rear Axle, Tuff-Cork	P27940TC	1	1988-1990, General Motors Axle, Front Axle	P27990	1
Diff. Carrier Gasket			1983-1986, 8-1/2" Ring Gear, 10 Bolt Holes, Rear Axle	P27857	1
1960-1963	P27848	1	1983-1986, 8-1/2" Ring Gear, 10 Bolt Holes, Rear Axle, Tuff-Cork	P27857TC	1
K1500			1988-1990, General Motors Axle, Front Axle	P27990	1
Axle Hsg Cover Gasket			1983-1986, 8-1/2" Ring Gear, 10 Bolt Holes, Rear Axle	P27857	1
1996-1999, 8-1/2" Ring Gear, 8-5/8" Ring Gear, 10 Bolt Holes, Rear Axle	P27857	1	1983-1986, 8-1/2" Ring Gear, 10 Bolt Holes, Rear Axle, Tuff-Cork	P27857TC	1
1996-1999, 8-1/2" Ring Gear, 8-5/8" Ring Gear, 10 Bolt Holes, Rear Axle, Tuff-Cork	P27857TC	1	1977-1986, General Motors Axle, Front Axle	P27990	1
1996, 9-1/2" Ring Gear, Rear Axle, Tuff-Cork	P29139TC	1	1971-1982, Rear Axle	P27940	1
1988-1996, 8-1/2" Ring Gear, 10 Bolt Holes, Rear Axle	P27857	1	1971-1982, Rear Axle, Tuff-Cork	P27940TC	1
1988-1996, 8-1/2" Ring Gear, 10 Bolt Holes, Rear Axle, Tuff-Cork	P27857TC	1	1968-1970, 4 Speed Transmission, Rear Axle	P18562	1
1988-1990, General Motors Axle, Front Axle	P27990	1	1968-1970, 4 Speed Transmission, Rear Axle, Tuff-Cork	P18562TC	1
K1500 SUBURBAN			1967-1972, General Motors Axle, Front Axle	P39130	1
Axle Hsg Cover Gasket			1967-1970, 12 Bolt Holes, Except Leaf Springs, Rear Axle	P27940	1
1996-1999, 8-1/2" Ring Gear, 8-5/8" Ring Gear, 10 Bolt Holes, Rear Axle	P27857	1	1967-1970, 12 Bolt Holes, Except Leaf Springs, Rear Axle, Tuff-Cork	P27940TC	1
1996-1999, 8-1/2" Ring Gear, 8-5/8" Ring Gear, 10 Bolt Holes, Rear Axle, Tuff-Cork	P27857TC	1	1967-1970, Leaf Spring Suspension, Rear Axle	P27768T	1
1992-1996, 8-1/2" Ring Gear, 10 Bolt Holes, Rear Axle	P27857	1	1967-1970, Leaf Spring Suspension, 10 Bolt Holes, Rear Axle, Tuff-Cork	P27768TC	1
1992-1996, 8-1/2" Ring Gear, 10 Bolt Holes, Rear Axle, Tuff-Cork	P27857TC	1	K20		
Diff. Carrier Gasket			Axle Hsg Cover Gasket		
1960-1963	P27848	1	1977-1986, General Motors Axle, Front Axle	P27990	1
			1973-1986, Rear Axle	P28128	1

LIGHT TRUCK

General Motors Truck (cont.)

Differential Housing Cover Gaskets (cont.)

Model & Application	Part No.	Qty.	Model & Application	Part No.	Qty.
K20 (cont.)			K2500(GMC) (cont.)		
Axle Hsg Cover Gasket (cont.)			Axle Hsg Cover Gasket (cont.)		
1966-1972, Front Axle	P39130	1	1967-1972, 10 Bolt Holes, Rear Axle, Tuff-Cork	P27768TC	1
1960-1972, Rear Axle	P27768T	1	1967-1972, Front Axle	P39130	1
1960-1972, 10 Bolt Holes, Rear Axle, Tuff-Cork	P27768TC	1	Diff. Carrier Gasket		
Diff. Carrier Gasket			1967-1972, Rear Axle	P29129	1
1960-1972	P29129	1	K30		
K20 SUBURBAN			Axle Hsg Cover Gasket		
Axle Hsg Cover Gasket			1982-1986, Except Dana Axle, Rear Axle		
1977-1986, General Motors Axle, Front Axle	P27990	1	1981-1986, Except 11000 Pound Axle, Except 14000 Pound Axle, Except Dana Axle, Rear Axle	P28128	1
1973-1986, Rear Axle	P28128	1	1977-1981, 11000 Pound Axle, 14000 Pound Axle, Rear Axle	P18562	1
1967-1972, Rear Axle	P27768T	1	1977-1981, 11000 Pound Axle, 14000 Pound Axle, Rear Axle, Tuff-Cork	P18562TC	1
1967-1972, 10 Bolt Holes, Rear Axle, Tuff-Cork	P27768TC	1	1977-1981, Except 11000 Pound Axle, Except 14000 Pound Axle, Rear Axle	P28128	1
1967-1972, Front Axle	P39130	1	K3500		
Diff. Carrier Gasket			Axle Hsg Cover Gasket		
1967-1972	P29129	1	1991-1996, 10-1/2" Ring Gear, Rear Axle		
K2500			1988-1990, Dana Axle, Rear Axle		
Axle Hsg Cover Gasket			1988-1990, Dana Axle, Rear Axle, Tuff-Cork		
1996, 10-1/2" Ring Gear, Rear Axle	P28128	1	1988-1990, Except Dana Axle, Rear Axle		
1996, 8-1/2" Ring Gear, 10 Bolt Holes, Rear Axle	P27857	1	K3500(GMC)		
1996, 8-1/2" Ring Gear, 10 Bolt Holes, Rear Axle, Tuff-Cork	P27857TC	1	Axle Hsg Cover Gasket		
1988-1996, Rear Axle	P28128	1	1991-1996, 10-1/2" Ring Gear, Rear Axle		
1988-1990, General Motors Axle, Front Axle	P27990	1	1988-1990, Except Dana Axle, Rear Axle		
K2500 SUBURBAN			1982-1986, Except Dana Axle, Rear Axle		
Axle Hsg Cover Gasket			1981-1986, Except 11000 Pound Axle, Except 14000 Pound Axle, Except Dana Axle, Rear Axle		
1996, 10-1/2" Ring Gear, Rear Axle	P28128	1	1977-1981, 11000 Pound Axle, 14000 Pound Axle, Rear Axle		
1996, 8-1/2" Ring Gear, 10 Bolt Holes, Rear Axle	P27857	1	1977-1981, 11000 Pound Axle, 14000 Pound Axle, Rear Axle, Tuff-Cork		
1996, 8-1/2" Ring Gear, 10 Bolt Holes, Rear Axle, Tuff-Cork	P27857TC	1	1977-1981, Except 11000 Pound Axle, Except 14000 Pound Axle, Rear Axle		
1992-1996, Rear Axle	P28128	1	LLV POSTAL VEHICLE		
K2500 SUBURBAN(GMC)			Axle Hsg Cover Gasket		
Axle Hsg Cover Gasket			1994-1995, 7-5/8" Ring Gear, Rear Axle		
1996, 10-1/2" Ring Gear, Rear Axle	P28128	1	1994-1995, 8-1/2" Ring Gear, 10 Bolt Holes, Rear Axle		
1996, 8-1/2" Ring Gear, 10 Bolt Holes, Rear Axle	P27857	1	1994-1995, 8-1/2" Ring Gear, 10 Bolt Holes, Rear Axle, Tuff-Cork		
1996, 8-1/2" Ring Gear, 10 Bolt Holes, Rear Axle, Tuff-Cork	P27857TC	1	1987-1993, Rear Axle		
1992-1996, Rear Axle	P28128	1	LUV		
1977-1986, General Motors Axle, Front Axle	P27990	1	Axle Hsg Cover Gasket		
1973-1986, Rear Axle	P28128	1	1979-1982, Front Axle		
1967-1972, Rear Axle	P27768T	1	1972-1982, Rear Axle		
1967-1972, 10 Bolt Holes, Rear Axle, Tuff-Cork	P27768TC	1	P10		
1967-1972, Front Axle	P39130	1	Axle Hsg Cover Gasket		
Diff. Carrier Gasket			1971-1978, Rear Axle		
1967-1972, Rear Axle	P29129	1	1971-1978, Rear Axle, Tuff-Cork		
K2500(GMC)			1964-1970, Leaf Spring Suspension, Rear Axle		
Axle Hsg Cover Gasket			1964-1970, Leaf Spring Suspension, 10 Bolt Holes, Rear Axle, Tuff-Cork		
1996, 10-1/2" Ring Gear, Rear Axle	P28128	1	1963-1970, Except Leaf Springs, Rear Axle		
1996, 8-1/2" Ring Gear, 10 Bolt Holes, Rear Axle	P27857	1	1963-1970, Except Leaf Springs, Rear Axle, Tuff-Cork		
1996, 8-1/2" Ring Gear, 10 Bolt Holes, Rear Axle, Tuff-Cork	P27857TC	1			
1988-1996, Rear Axle	P28128	1			
1988-1990, General Motors Axle, Front Axle	P27990	1			
1977-1986, General Motors Axle, Front Axle	P27990	1			
1973-1986, Rear Axle	P28128	1			
1967-1972, Rear Axle	P27768T	1			

General Motors Truck (cont.)

Differential Housing Cover Gaskets (cont.)

<i>Model & Application</i>	<i>Part No.</i>	<i>Qty.</i>	<i>Model & Application</i>	<i>Part No.</i>	<i>Qty.</i>
P10 (cont.)			P30		
Axle Hsg Cover Gasket (cont.)			Axle Hsg Cover Gasket		
1963, Rear Axle	P27940	1	1991-1999, 10-1/2" Ring Gear, Rear Axle	P28128	1
1963, Rear Axle, Tuff-Cork	P27940TC	1	1991-1996, 9-1/2" Ring Gear, Rear Axle, Tuff-Cork	P29139TC	1
Diff. Carrier Gasket			1982-1990, Dana Axle, Rear Axle		
1960-1963	P27848	1	1982-1990, Dana Axle, Rear Axle, Tuff-Cork	P18562	1
P1000			1982-1990, Except Dana Axle, Rear Axle		
Axle Hsg Cover Gasket			1973-1981, 11000 Pound Axle, 14000 Pound Axle, Rear Axle.		
1966, Except Leaf Springs, Rear Axle	P27940	1	1973-1981, 11000 Pound Axle, 14000 Pound Axle, Rear Axle, Tuff-Cork.	P18562TC	1
1966, Except Leaf Springs, Rear Axle, Tuff-Cork.	P27940TC	1	1973-1981, Except 11000 Pound Axle, Except 14000 Pound Axle, Rear Axle.	P28128	1
1964-1966, Leaf Spring Suspension, Rear Axle.	P27768T	1	1960-1972, Except 11000 Pound Axle, Rear Axle	P39130	1
1964-1966, Leaf Spring Suspension, 10 Bolt Holes, Rear Axle, Tuff-Cork	P27768TC	1	1960-1966, 11000 Pound Axle, Rear Axle	P39156	1
1963-1964, Except Leaf Springs, Rear Axle	P27940	1	Diff. Carrier Gasket		
1963-1964, Except Leaf Springs, Rear Axle, Tuff-Cork.	P27940TC	1	1967-1981, 11000 Pound Axle	P29248	1
P1500(GMC)			1963-1972, Except 11000 Pound Axle		
Axle Hsg Cover Gasket			1960-1962		
1971-1978, Rear Axle	P27940	1	P3500(GMC)		
1971-1978, Rear Axle, Tuff-Cork	P27940TC	1	Axle Hsg Cover Gasket		
1966-1970, Except Leaf Springs, Rear Axle	P27940	1	1991-1999, 10-1/2" Ring Gear, Rear Axle		
1966-1970, Except Leaf Springs, Rear Axle, Tuff-Cork.	P27940TC	1	1991-1996, 9-1/2" Ring Gear, Rear Axle, Tuff-Cork.		
1964-1970, Leaf Spring Suspension, Rear Axle.	P27768T	1	1990-1996, 10-1/2" Ring Gear, Except Dana Axle, Rear Axle		
1964-1970, Leaf Spring Suspension, 10 Bolt Holes, Rear Axle, Tuff-Cork	P27768TC	1	1982-1990, Dana Axle, Rear Axle		
1963-1964, Except Leaf Springs, Rear Axle	P27940	1	1982-1990, Dana Axle, Rear Axle, Tuff-Cork		
1963-1964, Except Leaf Springs, Rear Axle, Tuff-Cork.	P27940TC	1	1982-1990, Except Dana Axle, Rear Axle		
Diff. Carrier Gasket			1973-1981, 11000 Pound Axle, 14000 Pound Axle, Rear Axle.		
1963	P27848	1	1973-1981, 11000 Pound Axle, 14000 Pound Axle, Rear Axle, Tuff-Cork.		
P20			1973-1981, Except 11000 Pound Axle, Except 14000 Pound Axle, Rear Axle.		
Axle Hsg Cover Gasket			1967-1972, Except 11000 Pound Axle, Rear Axle		
1984-1989, 10-1/2" Ring Gear, Rear Axle	P28128	1	Diff. Carrier Gasket		
1984-1989, 8-1/2" Ring Gear, 10 Bolt Holes, Rear Axle.	P27857	1	1967-1981, 11000 Pound Axle		
1984-1989, 8-1/2" Ring Gear, 10 Bolt Holes, Rear Axle, Tuff-Cork	P27857TC	1	1967-1972, Except 11000 Pound Axle		
1984-1989, 9-1/2" Ring Gear, Rear Axle, Tuff-Cork.	P29139TC	1	PB2500		
1973-1983, Rear Axle	P28128	1	Axle Hsg Cover Gasket		
1960-1964, Rear Axle	P39130	1	1963-1964, Rear Axle		
Diff. Carrier Gasket			PM150		
1960-1972	P29129	1	Axle Hsg Cover Gasket		
P2500(GMC)			1958-1959, Except Posi-Trac, First Series		
Axle Hsg Cover Gasket			R10		
1984-1989, 10-1/2" Ring Gear, Rear Axle	P28128	1	Axle Hsg Cover Gasket		
1984-1989, 8-1/2" Ring Gear, 10 Bolt Holes, Rear Axle.	P27857	1	1987, 10 Bolt Holes, Rear Axle		
1984-1989, 8-1/2" Ring Gear, 10 Bolt Holes, Rear Axle, Tuff-Cork	P27857TC	1	1987, 10 Bolt Holes, Rear Axle, Tuff-Cork		
1984-1989, 9-1/2" Ring Gear, Rear Axle, Tuff-Cork.	P29139TC	1	R10 SUBURBAN		
1973-1983, Rear Axle	P28128	1	Axle Hsg Cover Gasket		
1963-1966, Rear Axle	P39130	1	1987-1988, 10 Bolt Holes, Rear Axle		
Diff. Carrier Gasket			1987-1988, 10 Bolt Holes, Rear Axle, Tuff-Cork.		
1963-1972	P29129	1	1987-1988, 10 Bolt Holes, Rear Axle, Tuff-Cork.		
			R1500 SUBURBAN		
			Axle Hsg Cover Gasket		
			1991, 9-1/2" Ring Gear, Rear Axle, Tuff-Cork.		
			1989-1990, 10 Bolt Holes, Rear Axle		

LIGHT TRUCK

General Motors Truck (cont.)

Differential Housing Cover Gaskets (cont.)

<i>Model & Application</i>	<i>Part No.</i>	<i>Qty.</i>	<i>Model & Application</i>	<i>Part No.</i>	<i>Qty.</i>
R1500 SUBURBAN (cont.)			R2500(GMC)		
Axle Hsg Cover Gasket (cont.)			Axle Hsg Cover Gasket		
1989-1990, 10 Bolt Holes, Rear Axle, Tuff-Cork	P27857TC	1	1987-1989, 10-1/2" Ring Gear, Rear Axle	P28128	1
R1500 SUBURBAN(GMC)			1987-1989, 8-1/2" Ring Gear, 10 Bolt Holes, Rear Axle	P27857	1
Axle Hsg Cover Gasket			1987-1989, 8-1/2" Ring Gear, 10 Bolt Holes, Rear Axle, Tuff-Cork	P27857TC	1
1991, 9-1/2" Ring Gear, Rear Axle, Tuff-Cork	P29139TC	1	1987-1989, 9-1/2" Ring Gear, Rear Axle, Tuff-Cork	P29139TC	1
1987-1990, 10 Bolt Holes, Rear Axle	P27857	1	R30		
1987-1990, 10 Bolt Holes, Rear Axle, Tuff-Cork	P27857TC	1	Axle Hsg Cover Gasket		
R1500(GMC)			1987-1988, Dana Axle, Rear Axle	P18562	1
Axle Hsg Cover Gasket			1987-1988, Dana Axle, Rear Axle, Tuff-Cork	P18562TC	1
1987, 10 Bolt Holes, Rear Axle	P27857	1	1987-1988, Except Dana Axle, Rear Axle	P28128	1
1987, 10 Bolt Holes, Rear Axle, Tuff-Cork	P27857TC	1	R3500		
R20			Axle Hsg Cover Gasket		
Axle Hsg Cover Gasket			1991, 10-1/2" Ring Gear, Rear Axle	P28128	1
1987-1988, 10-1/2" Ring Gear, Rear Axle	P28128	1	1991, 9-1/2" Ring Gear, Rear Axle, Tuff-Cork	P29139TC	1
1987-1988, 8-1/2" Ring Gear, 10 Bolt Holes, Rear Axle	P27857	1	1989-1990, Dana Axle, Rear Axle	P18562	1
1987-1988, 8-1/2" Ring Gear, 10 Bolt Holes, Rear Axle, Tuff-Cork	P27857TC	1	1989-1990, Dana Axle, Rear Axle, Tuff-Cork	P18562TC	1
1987-1988, 9-1/2" Ring Gear, Rear Axle, Tuff-Cork	P29139TC	1	1989-1990, Except Dana Axle, Rear Axle	P28128	1
R20 SUBURBAN			R3500(GMC)		
Axle Hsg Cover Gasket			Axle Hsg Cover Gasket		
1987-1988, 10-1/2" Ring Gear, Rear Axle	P28128	1	1991, 10-1/2" Ring Gear, Rear Axle	P28128	1
1987-1988, 8-1/2" Ring Gear, 10 Bolt Holes, Rear Axle	P27857	1	1991, 9-1/2" Ring Gear, Rear Axle, Tuff-Cork	P29139TC	1
1987-1988, 8-1/2" Ring Gear, 10 Bolt Holes, Rear Axle, Tuff-Cork	P27857TC	1	1987-1990, Dana Axle, Rear Axle	P18562	1
1987-1988, 9-1/2" Ring Gear, Rear Axle, Tuff-Cork	P29139TC	1	1987-1990, Dana Axle, Rear Axle, Tuff-Cork	P18562TC	1
R2500			1987-1990, Except Dana Axle, Rear Axle	P28128	1
Axle Hsg Cover Gasket			S10		
1989, 10-1/2" Ring Gear, Rear Axle	P28128	1	Axle Hsg Cover Gasket		
1989, 8-1/2" Ring Gear, 10 Bolt Holes, Rear Axle	P27857	1	1996-2002, 8-1/2" Ring Gear, 8-5/8" Ring Gear, 10 Bolt Holes, Rear Axle	P27857	1
1989, 8-1/2" Ring Gear, 10 Bolt Holes, Rear Axle, Tuff-Cork	P27857TC	1	1996-2002, 8-1/2" Ring Gear, 8-5/8" Ring Gear, 10 Bolt Holes, Rear Axle, Tuff-Cork	P27857TC	1
1989, 9-1/2" Ring Gear, Rear Axle, Tuff-Cork	P29139TC	1	1994-2003, 7-5/8" Ring Gear, Rear Axle	P27872	1
R2500 SUBURBAN			1994-1996, 8-1/2" Ring Gear, 10 Bolt Holes, Rear Axle	P27857	1
Axle Hsg Cover Gasket			1994-1996, 8-1/2" Ring Gear, 10 Bolt Holes, Rear Axle, Tuff-Cork	P27857TC	1
1989-1991, 10-1/2" Ring Gear, Rear Axle	P28128	1	1992-1993, Rear Axle	P27872	1
1989-1991, 8-1/2" Ring Gear, 10 Bolt Holes, Rear Axle	P27857	1	1988, Rear Axle	P27872	1
1989-1991, 8-1/2" Ring Gear, 10 Bolt Holes, Rear Axle, Tuff-Cork	P27857TC	1	1985-1994, 7-5/8" Ring Gear, Rear Axle	P27872	1
1989-1991, 9-1/2" Ring Gear, Rear Axle, Tuff-Cork	P29139TC	1	1982-1993, Rear Axle	P27872	1
R2500 SUBURBAN (GMC)			S15		
Axle Hsg Cover Gasket			Axle Hsg Cover Gasket		
1987-1991, 10-1/2" Ring Gear, Rear Axle	P28128	1	1994-1995, 7-5/8" Ring Gear	P27872	1
1987-1991, 8-1/2" Ring Gear, 10 Bolt Holes, Rear Axle	P27857	1	1994-1995, 8-1/2" Ring Gear, 10 Bolt Holes, Rear Axle	P27857	1
1987-1991, 8-1/2" Ring Gear, 10 Bolt Holes, Rear Axle, Tuff-Cork	P27857TC	1	1994-1995, 8-1/2" Ring Gear, 10 Bolt Holes, Rear Axle, Tuff-Cork	P27857TC	1
1987-1991, 9-1/2" Ring Gear, Rear Axle, Tuff-Cork	P29139TC	1	1992-1993, Rear Axle	P27872	1
SAFARI			1988-1995, 7-5/8" Ring Gear, Rear Axle	P27872	1
Axle Hsg Cover Gasket			1982-1990, Rear Axle	P27872	1
1985-2003, Rear Axle	P27872	1	SAFARI EXT		
SAFARI EXT			Axle Hsg Cover Gasket		
Axle Hsg Cover Gasket			1990-1994, Rear Axle	P27872	1
1990-1994, Rear Axle	P27872	1			

LIGHT TRUCK

General Motors Truck (cont.)

Differential Housing Cover Gaskets (cont.)

<i>Model & Application</i>	<i>Part No.</i>	<i>Qty.</i>	<i>Model & Application</i>	<i>Part No.</i>	<i>Qty.</i>
SAVANA 1500			SUBURBAN 1500		
Axle Hsg Cover Gasket			Axle Hsg Cover Gasket		
1996-2002, 8-1/2" Ring Gear, 8-5/8" Ring Gear, 10 Bolt Holes, Rear Axle.	P27857	1	2000-2002, 8-1/2" Ring Gear, 8-5/8" Ring Gear, 10 Bolt Holes, Rear Axle.	P27857	1
1996-2002, 8-1/2" Ring Gear, 8-5/8" Ring Gear, 10 Bolt Holes, Rear Axle, Tuff-Cork.	P27857TC	1	2000-2002, 8-1/2" Ring Gear, 8-5/8" Ring Gear, 10 Bolt Holes, Rear Axle, Tuff-Cork.	P27857TC	1
1996, 9-1/2" Ring Gear, Rear Axle, Tuff-Cork.	P29139TC	1			
SAVANA 2500			TAHOE		
Axle Hsg Cover Gasket			Axle Hsg Cover Gasket		
1996-2001, 10-1/2" Ring Gear, Rear Axle	P28128	1	1996-2002, 8-1/2" Ring Gear, 8-5/8" Ring Gear, 10 Bolt Holes, Rear Axle.	P27857	1
1996, 8-1/2" Ring Gear, 10 Bolt Holes, Rear Axle	P27857	1	1996-2002, 8-1/2" Ring Gear, 8-5/8" Ring Gear, 10 Bolt Holes, Rear Axle, Tuff-Cork.	P27857TC	1
1996, 8-1/2" Ring Gear, 10 Bolt Holes, Rear Axle, Tuff-Cork.	P27857TC	1	1995-1996, 8-1/2" Ring Gear, 10 Bolt Holes, Tuff-Cork.	P27857TC	1
1996, 9-1/2" Ring Gear, Rear Axle, Tuff-Cork.	P29139TC	1	1995-1996, 8-1/2" Ring Gear, 10 Bolt Holes, Tuff-Cork.	P27857TC	1
			1995-1996, 9-1/2" Ring Gear, Rear Axle, Tuff-Cork.	P29139TC	1
SAVANA 2500 EXT			V10		
Axle Hsg Cover Gasket			Axle Hsg Cover Gasket		
1996-2001, 10-1/2" Ring Gear, Rear Axle	P28128	1	1987, 10 Bolt Holes, Rear Axle	P27857	1
1996, 8-1/2" Ring Gear, 10 Bolt Holes, Rear Axle	P27857	1	1987, 10 Bolt Holes, Rear Axle, Tuff-Cork	P27857TC	1
1996, 8-1/2" Ring Gear, 10 Bolt Holes, Rear Axle, Tuff-Cork.	P27857TC	1	1987, General Motors Axle, Front Axle	P27990	1
1996, 9-1/2" Ring Gear, Rear Axle, Tuff-Cork.	P29139TC	1			
SAVANA 3500			V10 SUBURBAN		
Axle Hsg Cover Gasket			Axle Hsg Cover Gasket		
1996, 10-1/2" Ring Gear, Rear Axle	P28128	1	1987-1988, 10 Bolt Holes, Rear Axle	P27857	1
1996, 9-1/2" Ring Gear, Rear Axle, Tuff-Cork.	P29139TC	1	1987-1988, 10 Bolt Holes, Rear Axle, Tuff-Cork.	P27857TC	1
			1987-1988, General Motors Axle, Front Axle	P27990	1
SAVANA 3500 EXT			V1500 SUBURBAN		
Axle Hsg Cover Gasket			Axle Hsg Cover Gasket		
1996, 10-1/2" Ring Gear, Rear Axle	P28128	1	1989-1991, 10 Bolt Holes, Rear Axle	P27857	1
1996, 9-1/2" Ring Gear, Rear Axle, Tuff-Cork.	P29139TC	1	1989-1991, 10 Bolt Holes, Rear Axle, Tuff-Cork.	P27857TC	1
			1989-1990, General Motors Axle, Front Axle	P27990	1
SIERRA 1500			V1500 SUBURBAN(GMC)		
Axle Hsg Cover Gasket			Axle Hsg Cover Gasket		
1999-2002, 8-1/2" Ring Gear, 8-5/8" Ring Gear, 10 Bolt Holes, Rear Axle.	P27857	1	1987-1991, 10 Bolt Holes, Rear Axle	P27857	1
1999-2002, 8-1/2" Ring Gear, 8-5/8" Ring Gear, 10 Bolt Holes, Rear Axle, Tuff-Cork.	P27857TC	1	1987-1991, 10 Bolt Holes, Rear Axle, Tuff-Cork.	P27857TC	1
			1987-1990, General Motors Axle, Front Axle	P27990	1
SILVERADO 1500			V1500(GMC)		
Axle Hsg Cover Gasket			Axle Hsg Cover Gasket		
1999-2002, 8-1/2" Ring Gear, 8-5/8" Ring Gear, 10 Bolt Holes, Rear Axle.	P27857	1	1987, 10 Bolt Holes, Rear Axle	P27857	1
1999-2002, 8-1/2" Ring Gear, 8-5/8" Ring Gear, 10 Bolt Holes, Rear Axle, Tuff-Cork.	P27857TC	1	1987, 10 Bolt Holes, Rear Axle, Tuff-Cork	P27857TC	1
			1987, General Motors Axle, Front Axle	P27990	1
SONOMA			V20		
Axle Hsg Cover Gasket			Axle Hsg Cover Gasket		
1996-2003, 7-5/8" Ring Gear, Rear Axle	P27872	1	1987, Rear Axle	P28128	1
1996-2002, 8-1/2" Ring Gear, 8-5/8" Ring Gear, 10 Bolt Holes, Rear Axle.	P27857	1	1987, General Motors Axle, Front Axle	P27990	1
1996-2002, 8-1/2" Ring Gear, 8-5/8" Ring Gear, 10 Bolt Holes, Rear Axle, Tuff-Cork.	P27857TC	1			
1994-1995, 8-1/2" Ring Gear, 10 Bolt Holes, Rear Axle.	P27857	1	V20 SUBURBAN		
1994-1995, 8-1/2" Ring Gear, 10 Bolt Holes, Rear Axle, Tuff-Cork.	P27857TC	1	Axle Hsg Cover Gasket		
1992-1994, 7-5/8" Ring Gear, Rear Axle	P27872	1	1987-1988, Rear Axle	P28128	1
			1987-1988, General Motors Axle, Front Axle	P27990	1
			V2500 SUBURBAN		
			Axle Hsg Cover Gasket		
			1989-1991, Rear Axle	P28128	1
			1989-1990, General Motors Axle, Front Axle	P27990	1

LIGHT TRUCK

General Motors Truck (cont.)

Transmission Gaskets (cont.)

<i>Model & Application</i>	<i>Part No.</i>	<i>Qty.</i>	<i>Model & Application</i>	<i>Part No.</i>	<i>Qty.</i>
1500 (cont.)			3100 (cont.)		
Transmission Pan Gasket			Transmission Gasket Set (cont.)		
1965-1966, Turbo Hydra-Matic 400 M40 Transmission, Turbo Hydra-Matic 475 Transmission	W39341	1	1947-1953, 3 Speed Transmission	TS26250X	1
1965-1966, Turbo Hydra-Matic 400 M40 Transmission, Turbo Hydra-Matic 475 Transmission, Tuff-Cork	W39341TC	1	3200		
1963-1966, Powerglide Transmission	W39007	1	Transmission Gasket Set		
250			1955-1959, 3 Speed Transmission, Except Heavy Duty Transmission, Contains Seals		
Transmission Gasket Set			TS27011W		
1955-1959, 3 Speed Transmission, Except Heavy Duty Transmission, Contains Seals	TS27011W	1	1955-1959, 3 Speed Transmission, Except Heavy Duty Transmission, Seals Not Included		
1955-1959, 3 Speed Transmission, Except Heavy Duty Transmission, Seals Not Included	TS27061	1	1955-1959, 4 Speed Transmission		
1954, 3 Speed Transmission, Except Heavy Duty Transmission	TS26250X	1	3600		
1948-1959, 4 Speed Transmission	TS27520X	1	Transmission Gasket Set		
1947-1953, 3 Speed Transmission	TS26250X	1	1955-1959, 3 Speed Transmission, Except Heavy Duty Transmission, Contains Seals		
1939-1942, 3 Speed Transmission	TS26250X	1	1955-1959, 3 Speed Transmission, Except Heavy Duty Transmission, Seals Not Included		
2500			1954, 3 Speed Transmission, Except Heavy Duty Transmission		
Transmission Gasket Set			TS26250X		
1966, Muncie 4 Speed Transmission	TS27520X	1	1948-1959, 4 Speed Transmission		
1966, Overdrive Transmission, Saginaw 4 Speed Transmission	TS14737W	1	1947-1953, 3 Speed Transmission		
1960-1966, 3 Speed Transmission, Except Heavy Duty Transmission, Contains Seals	TS27011W	1	3800		
1960-1966, 3 Speed Transmission, Except Heavy Duty Transmission, Seals Not Included	TS27061	1	Transmission Gasket Set		
1960-1965, 4 Speed Transmission	TS27520X	1	1955-1959, 3 Speed Transmission, Except Heavy Duty Transmission, Contains Seals		
Transmission Pan Gasket			1955-1959, 3 Speed Transmission, Except Heavy Duty Transmission, Seals Not Included		
1966, Turbo Hydra-Matic 400 M40 Transmission, Turbo Hydra-Matic 475 Transmission	W39341	1	1954, 3 Speed Transmission, Except Heavy Duty Transmission		
1966, Turbo Hydra-Matic 400 M40 Transmission, Turbo Hydra-Matic 475 Transmission, Tuff-Cork	W39341TC	1	1948-1959, 4 Speed Transmission		
1963-1966, Powerglide Transmission	W39007	1	1947-1953, 3 Speed Transmission		
260 SERIES			ASTRO		
Transmission Gasket Set			Transmission Pan Gasket		
1947, 3 Speed Transmission	TS26250X	1	1996-2003, Turbo Hydra-Matic 4L60E M30 Transmission		
1941-1942, 3 Speed Transmission	TS26250X	1	1996-2003, Turbo Hydra-Matic 4L60E M30 Transmission, Tuff-Cork		
280 SERIES			1992-1995, Turbo Hydra-Matic 4L60E M30 Transmission, Turbo Hydra-Matic 700-R4 MD8 Transmission		
Transmission Gasket Set			W39365		
1950, 3 Speed Transmission	TS26250X	1	1992-1995, Turbo Hydra-Matic 4L60E M30 Transmission, Turbo Hydra-Matic 700-R4 MD8 Transmission, Tuff-Cork		
1947, 3 Speed Transmission	TS26250X	1	1991-1994, Turbo Hydra-Matic 4L80E MT1 Transmission		
300 SERIES			W39379		
Transmission Gasket Set			1985-1992, Turbo Hydra-Matic 700-R4 MD8 Transmission		
1947, 3 Speed Transmission	TS26250X	1	1985-1992, Turbo Hydra-Matic 700-R4 MD8 Transmission, Tuff-Cork		
1939-1942, 3 Speed Transmission	TS26250X	1	1985-1990, Turbo Hydra-Matic 400 M40 Transmission, Turbo Hydra-Matic 475 Transmission		
3100			W39341		
Transmission Gasket Set			1985-1990, Turbo Hydra-Matic 400 M40 Transmission, Turbo Hydra-Matic 475 Transmission, Tuff-Cork		
1955-1959, 3 Speed Transmission, Except Heavy Duty Transmission, Contains Seals	TS27011W	1	W39341TC		
1955-1959, 3 Speed Transmission, Except Heavy Duty Transmission, Seals Not Included	TS27061	1	ASTRO EXT		
1954, 3 Speed Transmission, Except Heavy Duty Transmission	TS26250X	1	Transmission Pan Gasket		
1948-1959, 4 Speed Transmission	TS27520X	1	1992-1993, Turbo Hydra-Matic 4L60E M30 Transmission, Turbo Hydra-Matic 700-R4 MD8 Transmission		

LIGHT TRUCK

General Motors Truck (cont.)

Transmission Gaskets (cont.)

<i>Model & Application</i>	<i>Part No.</i>	<i>Qty.</i>	<i>Model & Application</i>	<i>Part No.</i>	<i>Qty.</i>
ASTRO EXT (cont.)			BLAZER XTREME		
Transmission Pan Gasket (cont.)			Transmission Pan Gasket		
1992-1993, Turbo Hydra-Matic 4L60E M30 Transmission, Turbo Hydra-Matic 700-R4 MD8 Transmission, Tuff-Cork.	W39365TC	1	2002-2003, Turbo Hydra-Matic 4L60E M30 Transmission.	W39365	1
1991-1994, Turbo Hydra-Matic 4L80E MT1 Transmission.	W39379	1	2002-2003, Turbo Hydra-Matic 4L60E M30 Transmission, Tuff-Cork.	W39365TC	1
1990-1992, Turbo Hydra-Matic 700-R4 MD8 Transmission.	W39365	1	BRAVADA		
1990-1992, Turbo Hydra-Matic 700-R4 MD8 Transmission, Tuff-Cork.	W39365TC	1	Transmission Pan Gasket		
1990, Turbo Hydra-Matic 400 M40 Transmission, Turbo Hydra-Matic 475 Transmission.	W39341	1	1996-2001, Turbo Hydra-Matic 4L60E M30 Transmission.	W39365	1
1990, Turbo Hydra-Matic 400 M40 Transmission, Turbo Hydra-Matic 475 Transmission, Tuff-Cork.	W39341TC	1	1996-2001, Turbo Hydra-Matic 4L60E M30 Transmission, Tuff-Cork.	W39365TC	1
AVALANCHE 1500			1993-1994, Turbo Hydra-Matic 4L60E M30 Transmission.	W39365	1
Transmission Pan Gasket			1993-1994, Turbo Hydra-Matic 4L60E M30 Transmission, Tuff-Cork.	W39365TC	1
2002-2003, Turbo Hydra-Matic 4L60E M30 Transmission.	W39365	1	1992, Turbo Hydra-Matic 700-R4 MD8 Transmission.	W39365	1
2002-2003, Turbo Hydra-Matic 4L60E M30 Transmission, Tuff-Cork.	W39365TC	1	1992, Turbo Hydra-Matic 700-R4 MD8 Transmission, Tuff-Cork.	W39365TC	1
AVALANCHE 2500			C10		
Transmission Pan Gasket			P.T.O. Cover Gasket		
2002-2003, Turbo Hydra-Matic 4L80E MT1 Transmission.	W39379	1	1970-1972, 6 Bolt, Chelsea Power Take Off . . .	H36080	1
BLAZER			1970-1972, 8 Bolt, Chelsea Power Take Off . . .	H36124	1
Transfer Case Gasket Set			Transmission Gasket Set		
1973-1979, New Process 203	TS27292	1	1970-1981, Muncie 3 Speed Transmission . . .	TS27594	1
1969-1983, New Process 205	TS27275	1	1969-1981, Saginaw 3 Speed Transmission . .	TS14737W	1
Transmission Gasket Set			1969-1972, Except Overdrive Transmission, Muncie 3 Speed Transmission	TS27594	1
1973-1981, Muncie 3 Speed Transmission . . .	TS27594	1	1968-1986, Muncie 4 Speed Transmission . . .	TS27920Y	1
1969-1987, Muncie 4 Speed Transmission . . .	TS27920Y	1	1968-1969, Saginaw 4 Speed Transmission . .	TS14737W	1
1969-1981, Saginaw 3 Speed Transmission . .	TS14737W	1	1967-1969, Saginaw 3 Speed Transmission . .	TS14737W	1
1969-1972, Except Overdrive Transmission, Muncie 3 Speed Transmission	TS27594	1	1967-1968, Except Overdrive Transmission, Muncie 3 Speed Transmission, Contains Seals.	TS27011W	1
1969, Saginaw 4 Speed Transmission	TS14737W	1	1967-1968, Except Overdrive Transmission, Muncie 3 Speed Transmission, Seals Not Included.	TS27061	1
Transmission Pan Gasket			1966-1967, Muncie 4 Speed Transmission . . .	TS27520X	1
1993-2003, Turbo Hydra-Matic 4L60E M30 Transmission.	W39365	1	1966-1967, Overdrive Transmission	TS14737W	1
1993-2003, Turbo Hydra-Matic 4L60E M30 Transmission, Tuff-Cork.	W39365TC	1	1965-1968, 3 Speed Transmission, Except Heavy Duty Transmission, Except Overdrive Transmission, Muncie 3 Speed Transmission, Contains Seals	TS27011W	1
1991-1994, Turbo Hydra-Matic 4L80E MT1 Transmission.	W39379	1	1965-1968, 3 Speed Transmission, Except Heavy Duty Transmission, Except Overdrive Transmission, Muncie 3 Speed Transmission, Seals Not Included.	TS27061	1
1982-1992, Turbo Hydra-Matic 700-R4 MD8 Transmission.	W39365	1	1963-1967, 4 Speed Transmission, Muncie 4 Speed Transmission.	TS27520X	1
1982-1992, Turbo Hydra-Matic 700-R4 MD8 Transmission, Tuff-Cork.	W39365TC	1	1960-1966, 3 Speed Transmission, Except Heavy Duty Transmission, Contains Seals. . .	TS27011W	1
1982-1984, Turbo Hydra-Matic 200 M29, MV9 Transmission.	W39045	1	1960-1966, 3 Speed Transmission, Except Heavy Duty Transmission, Seals Not Included.	TS27061	1
1982-1984, Turbo Hydra-Matic 200 M29, MV9 Transmission, Tuff-Cork.	W39045TC	1	1960-1965, 4 Speed Transmission	TS27520X	1
1969-1990, Turbo Hydra-Matic 400 M40 Transmission, Turbo Hydra-Matic 475 Transmission.	W39341	1	Transmission Pan Gasket		
1969-1990, Turbo Hydra-Matic 400 M40 Transmission, Turbo Hydra-Matic 475 Transmission, Tuff-Cork.	W39341TC	1	1982-1986, Turbo Hydra-Matic 700-R4 MD8 Transmission.	W39365	1
1969-1971, Powerglide Transmission	W39007	1	1982-1986, Turbo Hydra-Matic 700-R4 MD8 Transmission, Tuff-Cork.	W39365TC	1
1969-1971, Turbo Hydra-Matic 350 M38, MV4 Transmission.	W39348	1	1982-1984, Turbo Hydra-Matic 200 M29, MV9 Transmission.	W39045	1
1969-1971, Turbo Hydra-Matic 350 M38, MV4 Transmission, Tuff-Cork.	W39348TC	1	1982-1984, Turbo Hydra-Matic 200 M29, MV9 Transmission, Tuff-Cork.	W39045TC	1

LIGHT TRUCK

General Motors Truck (cont.)

Transmission Gaskets (cont.)

<i>Model & Application</i>	<i>Part No.</i>	<i>Qty.</i>	<i>Model & Application</i>	<i>Part No.</i>	<i>Qty.</i>
C10 (cont.)			C10 SUBURBAN (cont.)		
Transmission Pan Gasket (cont.)			Transmission Pan Gasket (cont.)		
1969-1971, Turbo Hydra-Matic 350 M38, MV4 Transmission.	W39348	1	1963-1971, Powerglide Transmission	W39007	1
1969-1971, Turbo Hydra-Matic 350 M38, MV4 Transmission, Tuff-Cork.	W39348TC	1	C1500		
1965-1986, Turbo Hydra-Matic 400 M40 Transmission, Turbo Hydra-Matic 475 Transmission.	W39341	1	Transmission Pan Gasket		
1965-1986, Turbo Hydra-Matic 400 M40 Transmission, Turbo Hydra-Matic 475 Transmission, Tuff-Cork.	W39341TC	1	1993-1999, Turbo Hydra-Matic 4L60E M30 Transmission.	W39365	1
1963-1971, Powerglide Transmission	W39007	1	1993-1999, Turbo Hydra-Matic 4L60E M30 Transmission, Tuff-Cork.	W39365TC	1
C10 SUBURBAN			1991-1998, Turbo Hydra-Matic 4L80E MT1 Transmission.	W39379	1
P.T.O. Cover Gasket			1988-1992, Turbo Hydra-Matic 700-R4 MD8 Transmission.	W39365	1
1970-1972, 6 Bolt, Chelsea Power Take Off	H36080	1	1988-1992, Turbo Hydra-Matic 700-R4 MD8 Transmission, Tuff-Cork.	W39365TC	1
1970-1972, 8 Bolt, Chelsea Power Take Off	H36124	1	1988-1990, Turbo Hydra-Matic 400 M40 Transmission, Turbo Hydra-Matic 475 Transmission.	W39341	1
Transmission Gasket Set			1988-1990, Turbo Hydra-Matic 400 M40 Transmission, Turbo Hydra-Matic 475 Transmission, Tuff-Cork.	W39341TC	1
1970-1981, Muncie 3 Speed Transmission	TS27594	1	C1500 SUBURBAN		
1969-1981, Saginaw 3 Speed Transmission	TS14737W	1	Transmission Pan Gasket		
1969-1972, Except Overdrive Transmission, Muncie 3 Speed Transmission	TS27594	1	1993-1999, Turbo Hydra-Matic 4L60E M30 Transmission.	W39365	1
1968-1986, Muncie 4 Speed Transmission	TS27920Y	1	1993-1999, Turbo Hydra-Matic 4L60E M30 Transmission, Tuff-Cork.	W39365TC	1
1968-1969, Saginaw 4 Speed Transmission	TS14737W	1	1992-1999, Turbo Hydra-Matic 4L80E MT1 Transmission.	W39379	1
1967-1969, Saginaw 3 Speed Transmission	TS14737W	1	1992, Turbo Hydra-Matic 700-R4 MD8 Transmission.	W39365	1
1967-1968, Except Overdrive Transmission, Muncie 3 Speed Transmission, Contains Seals.	TS27011W	1	1992, Turbo Hydra-Matic 700-R4 MD8 Transmission, Tuff-Cork.	W39365TC	1
1967-1968, Except Overdrive Transmission, Muncie 3 Speed Transmission, Seals Not Included.	TS27061	1	C1500 SUBURBAN(GMC)		
1966-1967, Muncie 4 Speed Transmission	TS27520X	1	Transmission Gasket Set		
1966-1967, Overdrive Transmission	TS14737W	1	1970-1981, Muncie 3 Speed Transmission	TS27594	1
1965-1968, 3 Speed Transmission, Except Heavy Duty Transmission, Except Overdrive Transmission, Muncie 3 Speed Transmission, Contains Seals	TS27011W	1	1969-1972, Except Overdrive Transmission, Muncie 3 Speed Transmission	TS27594	1
1965-1968, 3 Speed Transmission, Except Heavy Duty Transmission, Except Overdrive Transmission, Muncie 3 Speed Transmission, Seals Not Included.	TS27061	1	1968-1986, Muncie 4 Speed Transmission	TS27920Y	1
1963-1967, 4 Speed Transmission, Muncie 4 Speed Transmission.	TS27520X	1	1968-1981, Saginaw 3 Speed Transmission	TS14737W	1
1960-1966, 3 Speed Transmission, Except Heavy Duty Transmission, Contains Seals.	TS27011W	1	1968-1969, Saginaw 4 Speed Transmission	TS14737W	1
1960-1966, 3 Speed Transmission, Except Heavy Duty Transmission, Seals Not Included.	TS27061	1	1967-1969, Saginaw 3 Speed Transmission	TS14737W	1
1960-1965, 4 Speed Transmission	TS27520X	1	1967-1968, Except Overdrive Transmission, Muncie 3 Speed Transmission, Contains Seals.	TS27011W	1
Transmission Pan Gasket			1967-1968, Except Overdrive Transmission, Muncie 3 Speed Transmission, Seals Not Included.	TS27061	1
1982-1986, Turbo Hydra-Matic 700-R4 MD8 Transmission.	W39365	1	1967, Muncie 4 Speed Transmission	TS27520X	1
1982-1986, Turbo Hydra-Matic 700-R4 MD8 Transmission, Tuff-Cork.	W39365TC	1	1967, Overdrive Transmission	TS14737W	1
1982-1984, Turbo Hydra-Matic 200 M29, MV9 Transmission.	W39045	1	Transmission Pan Gasket		
1982-1984, Turbo Hydra-Matic 200 M29, MV9 Transmission, Tuff-Cork.	W39045TC	1	1993-1999, Turbo Hydra-Matic 4L60E M30 Transmission.	W39365	1
1969-1971, Turbo Hydra-Matic 350 M38, MV4 Transmission.	W39348	1	1993-1999, Turbo Hydra-Matic 4L60E M30 Transmission, Tuff-Cork.	W39365TC	1
1969-1971, Turbo Hydra-Matic 350 M38, MV4 Transmission, Tuff-Cork.	W39348TC	1	1992-1999, Turbo Hydra-Matic 4L80E MT1 Transmission.	W39379	1
1965-1986, Turbo Hydra-Matic 400 M40 Transmission, Turbo Hydra-Matic 475 Transmission.	W39341	1	1992, Turbo Hydra-Matic 700-R4 MD8 Transmission.	W39365	1
1965-1986, Turbo Hydra-Matic 400 M40 Transmission, Turbo Hydra-Matic 475 Transmission, Tuff-Cork.	W39341TC	1	1992, Turbo Hydra-Matic 700-R4 MD8 Transmission, Tuff-Cork.	W39365TC	1
			1982-1986, Turbo Hydra-Matic 700-R4 MD8 Transmission.	W39365	1
			1982-1986, Turbo Hydra-Matic 700-R4 MD8 Transmission, Tuff-Cork.	W39365TC	1

LIGHT TRUCK

General Motors Truck (cont.)

Transmission Gaskets (cont.)					
Model & Application	Part No.	Qty.	Model & Application	Part No.	Qty.
C1500 SUBURBAN(GMC) (cont.)			C1500(GMC) (cont.)		
Transmission Pan Gasket (cont.)			Transmission Pan Gasket (cont.)		
1982-1984, Turbo Hydra-Matic 200 M29, MV9 Transmission.	W39045	1	1967-1986, Turbo Hydra-Matic 400 M40 Transmission, Turbo Hydra-Matic 475 Transmission, Tuff-Cork.	W39341TC	1
1982-1984, Turbo Hydra-Matic 200 M29, MV9 Transmission, Tuff-Cork.	W39045TC	1	1967-1971, Powerglide Transmission	W39007	1
1969-1971, Turbo Hydra-Matic 350 M38, MV4 Transmission.	W39348	1	C20		
1969-1971, Turbo Hydra-Matic 350 M38, MV4 Transmission, Tuff-Cork.	W39348TC	1	P.T.O. Cover Gasket		
1967-1986, Turbo Hydra-Matic 400 M40 Transmission, Turbo Hydra-Matic 475 Transmission.	W39341	1	1970-1972, 6 Bolt, Chelsea Power Take Off	H36080	1
1967-1986, Turbo Hydra-Matic 400 M40 Transmission, Turbo Hydra-Matic 475 Transmission, Tuff-Cork.	W39341TC	1	1970-1972, 8 Bolt, Chelsea Power Take Off	H36124	1
1967-1971, Powerglide Transmission	W39007	1	Transmission Gasket Set		
C1500(GMC)			1970-1981, Muncie 3 Speed Transmission		
Transmission Gasket Set			1969-1981, Saginaw 3 Speed Transmission		
1970-1981, Muncie 3 Speed Transmission	TS27594	1	1969-1972, Except Overdrive Transmission, Muncie 3 Speed Transmission	TS27594	1
1969-1972, Except Overdrive Transmission, Muncie 3 Speed Transmission	TS27594	1	1968-1986, Muncie 4 Speed Transmission	TS27920Y	1
1968-1986, Muncie 4 Speed Transmission	TS27920Y	1	1968-1969, Saginaw 4 Speed Transmission	TS14737W	1
1968-1981, Saginaw 3 Speed Transmission	TS14737W	1	1967-1969, Saginaw 3 Speed Transmission	TS14737W	1
1968-1969, Saginaw 4 Speed Transmission	TS14737W	1	1967-1968, Except Overdrive Transmission, Muncie 3 Speed Transmission, Contains Seals.	TS27011W	1
1967-1969, Saginaw 3 Speed Transmission	TS14737W	1	1967-1968, Except Overdrive Transmission, Muncie 3 Speed Transmission, Seals Not Included.	TS27061	1
1967-1968, Except Overdrive Transmission, Muncie 3 Speed Transmission, Contains Seals.	TS27011W	1	1967, Muncie 4 Speed Transmission	TS27520X	1
1967-1968, Except Overdrive Transmission, Muncie 3 Speed Transmission, Seals Not Included.	TS27061	1	1967, Overdrive Transmission	TS14737W	1
1967, Muncie 4 Speed Transmission	TS27520X	1	Transmission Pan Gasket		
1967, Overdrive Transmission	TS14737W	1	1993-1999, Turbo Hydra-Matic 4L60E M30 Transmission.		
Transmission Pan Gasket			1993-1999, Turbo Hydra-Matic 4L60E M30 Transmission, Tuff-Cork.		
1993-1999, Turbo Hydra-Matic 4L60E M30 Transmission.	W39365	1	1991-1997, Turbo Hydra-Matic 4L80E MT1 Transmission.	W39379	1
1993-1999, Turbo Hydra-Matic 4L60E M30 Transmission, Tuff-Cork.	W39365TC	1	1988-1992, Turbo Hydra-Matic 700-R4 MD8 Transmission.	W39365	1
1991-1997, Turbo Hydra-Matic 4L80E MT1 Transmission.	W39379	1	1988-1992, Turbo Hydra-Matic 700-R4 MD8 Transmission, Tuff-Cork.	W39365TC	1
1988-1992, Turbo Hydra-Matic 700-R4 MD8 Transmission.	W39365	1	1988-1990, Turbo Hydra-Matic 400 M40 Transmission, Turbo Hydra-Matic 475 Transmission.	W39341	1
1988-1992, Turbo Hydra-Matic 700-R4 MD8 Transmission, Tuff-Cork.	W39365TC	1	1988-1990, Turbo Hydra-Matic 400 M40 Transmission, Tuff-Cork.	W39341TC	1
1988-1990, Turbo Hydra-Matic 400 M40 Transmission, Turbo Hydra-Matic 475 Transmission.	W39341	1	1982-1986, Turbo Hydra-Matic 700-R4 MD8 Transmission.	W39365	1
1988-1990, Turbo Hydra-Matic 400 M40 Transmission, Tuff-Cork.	W39341TC	1	1982-1986, Turbo Hydra-Matic 700-R4 MD8 Transmission, Tuff-Cork.	W39365TC	1
1982-1986, Turbo Hydra-Matic 700-R4 MD8 Transmission.	W39365	1	1982-1984, Turbo Hydra-Matic 200 M29, MV9 Transmission.	W39045	1
1982-1986, Turbo Hydra-Matic 700-R4 MD8 Transmission, Tuff-Cork.	W39365TC	1	1982-1984, Turbo Hydra-Matic 200 M29, MV9 Transmission, Tuff-Cork.	W39045TC	1
1982-1984, Turbo Hydra-Matic 200 M29, MV9 Transmission.	W39045	1	1969-1971, Turbo Hydra-Matic 350 M38, MV4 Transmission.	W39348	1
1982-1984, Turbo Hydra-Matic 200 M29, MV9 Transmission, Tuff-Cork.	W39045TC	1	1969-1971, Turbo Hydra-Matic 350 M38, MV4 Transmission, Tuff-Cork.	W39348TC	1
1969-1971, Turbo Hydra-Matic 350 M38, MV4 Transmission.	W39348	1	1965-1986, Turbo Hydra-Matic 400 M40 Transmission, Turbo Hydra-Matic 475 Transmission.	W39341	1
1969-1971, Turbo Hydra-Matic 350 M38, MV4 Transmission, Tuff-Cork.	W39348TC	1	1965-1986, Turbo Hydra-Matic 400 M40 Transmission, Turbo Hydra-Matic 475 Transmission, Tuff-Cork.	W39341TC	1
1967-1986, Turbo Hydra-Matic 400 M40 Transmission, Turbo Hydra-Matic 475 Transmission.	W39341	1	1963-1971, Powerglide Transmission	W39007	1
1967-1986, Turbo Hydra-Matic 400 M40 Transmission, Turbo Hydra-Matic 475 Transmission, Tuff-Cork.	W39341TC	1	C20 SUBURBAN		
1967-1986, Turbo Hydra-Matic 400 M40 Transmission, Turbo Hydra-Matic 475 Transmission.	W39341	1	P.T.O. Cover Gasket		
C20 SUBURBAN			1970-1972, 6 Bolt, Chelsea Power Take Off		
P.T.O. Cover Gasket			1970-1972, 8 Bolt, Chelsea Power Take Off		
1970-1972, 6 Bolt, Chelsea Power Take Off			H36080		
1970-1972, 8 Bolt, Chelsea Power Take Off			H36124		

LIGHT TRUCK

General Motors Truck (cont.)

Transmission Gaskets (cont.)					
Model & Application	Part No.	Qty.	Model & Application	Part No.	Qty.
C2500(GMC) (cont.)			C30 (cont.)		
Transmission Pan Gasket (cont.)			Transmission Gasket Set (cont.)		
1993-1999, Turbo Hydra-Matic 4L60E M30 Transmission, Tuff-Cork	W39365TC	1	1966-1968, 3 Speed Transmission, Except Heavy Duty Transmission, Except Overdrive Transmission, Muncie 3 Speed Transmission, Seals Not Included	TS27061	1
1991-1999, Turbo Hydra-Matic 4L80E MT1 Transmission	W39379	1	1966-1967, Muncie 4 Speed Transmission	TS27520X	1
1988-1992, Turbo Hydra-Matic 700-R4 MD8 Transmission	W39365	1	1966-1967, Overdrive Transmission	TS14737W	1
1988-1992, Turbo Hydra-Matic 700-R4 MD8 Transmission, Tuff-Cork	W39365TC	1	1966, 3 Speed Transmission, Except Heavy Duty Transmission, Contains Seals	TS27011W	1
1988-1990, Turbo Hydra-Matic 400 M40 Transmission, Turbo Hydra-Matic 475 Transmission	W39341	1	1966, 3 Speed Transmission, Except Heavy Duty Transmission, Seals Not Included	TS27061	1
1988-1990, Turbo Hydra-Matic 400 M40 Transmission, Turbo Hydra-Matic 475 Transmission, Tuff-Cork	W39341TC	1	1966, Overdrive Transmission, Saginaw 4 Speed Transmission	TS14737W	1
1982-1986, Turbo Hydra-Matic 700-R4 MD8 Transmission	W39365	1	1965-1968, 3 Speed Transmission, Except Heavy Duty Transmission, Except Overdrive Transmission, Muncie 3 Speed Transmission, Contains Seals	TS27011W	1
1982-1986, Turbo Hydra-Matic 700-R4 MD8 Transmission, Tuff-Cork	W39365TC	1	1965-1968, 3 Speed Transmission, Except Heavy Duty Transmission, Except Overdrive Transmission, Muncie 3 Speed Transmission, Seals Not Included	TS27061	1
1982-1984, Turbo Hydra-Matic 200 M29, MV9 Transmission	W39045	1	1963-1967, 4 Speed Transmission, Muncie 4 Speed Transmission	TS27520X	1
1982-1984, Turbo Hydra-Matic 200 M29, MV9 Transmission, Tuff-Cork	W39045TC	1	1960-1966, 3 Speed Transmission, Except Heavy Duty Transmission, Contains Seals	TS27011W	1
1969-1971, Turbo Hydra-Matic 350 M38, MV4 Transmission	W39348	1	1960-1966, 3 Speed Transmission, Except Heavy Duty Transmission, Seals Not Included	TS27061	1
1969-1971, Turbo Hydra-Matic 350 M38, MV4 Transmission, Tuff-Cork	W39348TC	1	1960-1965, 4 Speed Transmission	TS27520X	1
1967-1986, Turbo Hydra-Matic 400 M40 Transmission, Turbo Hydra-Matic 475 Transmission	W39341	1	Transmission Pan Gasket		
1967-1986, Turbo Hydra-Matic 400 M40 Transmission, Turbo Hydra-Matic 475 Transmission, Tuff-Cork	W39341TC	1	1982-1986, Turbo Hydra-Matic 700-R4 MD8 Transmission	W39365	1
1967-1971, Powerglide Transmission	W39007	1	1982-1986, Turbo Hydra-Matic 700-R4 MD8 Transmission, Tuff-Cork	W39365TC	1
C30			1982-1984, Turbo Hydra-Matic 200 M29, MV9 Transmission	W39045	1
P.T.O. Cover Gasket			1982-1984, Turbo Hydra-Matic 200 M29, MV9 Transmission, Tuff-Cork	W39045TC	1
1961-1986, 6 Bolt, Chelsea Power Take Off	H36080	1	1969-1971, Turbo Hydra-Matic 350 M38, MV4 Transmission	W39348	1
1961-1986, 8 Bolt, Chelsea Power Take Off	H36124	1	1969-1971, Turbo Hydra-Matic 350 M38, MV4 Transmission, Tuff-Cork	W39348TC	1
P.T.O. Mounting Gasket			1965-1986, Turbo Hydra-Matic 400 M40 Transmission, Turbo Hydra-Matic 475 Transmission	W39341	1
1961-1986, .010" Thickness, 6 Bolt, Chelsea Power Take Off	H26205	1	1965-1986, Turbo Hydra-Matic 400 M40 Transmission, Turbo Hydra-Matic 475 Transmission, Tuff-Cork	W39341TC	1
1961-1986, .010" Thickness, 8 Bolt, Chelsea Power Take Off	H26207	1	1963-1971, Powerglide Transmission	W39007	1
1961-1986, .020" Thickness, 6 Bolt, Chelsea Power Take Off	H26206	1	C3500		
1961-1986, .020" Thickness, 8 Bolt, Chelsea Power Take Off	H26208	1	P.T.O. Cover Gasket		
Transmission Gasket Set			1988-1999, 6 Bolt, Chelsea Power Take Off	H36080	1
1970-1981, Muncie 3 Speed Transmission	TS27594	1	1988-1999, 8 Bolt, Chelsea Power Take Off	H36124	1
1969-1972, Except Overdrive Transmission, Muncie 3 Speed Transmission	TS27594	1	P.T.O. Mounting Gasket		
1968-1986, Muncie 4 Speed Transmission	TS27920Y	1	1988-1999, .010" Thickness, 6 Bolt, Chelsea Power Take Off	H26205	1
1968-1981, Saginaw 3 Speed Transmission	TS14737W	1	1988-1999, .010" Thickness, 8 Bolt, Chelsea Power Take Off	H26207	1
1968-1969, Saginaw 4 Speed Transmission	TS14737W	1	1988-1999, .020" Thickness, 6 Bolt, Chelsea Power Take Off	H26206	1
1967-1969, Saginaw 3 Speed Transmission	TS14737W	1	1988-1999, .020" Thickness, 8 Bolt, Chelsea Power Take Off	H26208	1
1967-1968, Except Overdrive Transmission, Muncie 3 Speed Transmission, Contains Seals	TS27011W	1	Transmission Pan Gasket		
1967-1968, Except Overdrive Transmission, Muncie 3 Speed Transmission, Seals Not Included	TS27061	1	1991-2000, Turbo Hydra-Matic 4L80E MT1 Transmission	W39379	1
1966-1968, 3 Speed Transmission, Except Heavy Duty Transmission, Except Overdrive Transmission, Muncie 3 Speed Transmission, Contains Seals	TS27011W	1			

LIGHT TRUCK

General Motors Truck (cont.)

Transmission Gaskets (cont.)

Model & Application	Part No.	Qty.	Model & Application	Part No.	Qty.
C3500 (cont.)			C3500(GMC) (cont.)		
Transmission Pan Gasket (cont.)			Transmission Pan Gasket (cont.)		
1988-1992, Turbo Hydra-Matic 700-R4 MD8 Transmission	W39365	1	1982-1986, Turbo Hydra-Matic 700-R4 MD8 Transmission	W39365	1
1988-1992, Turbo Hydra-Matic 700-R4 MD8 Transmission, Tuff-Cork	W39365TC	1	1982-1986, Turbo Hydra-Matic 700-R4 MD8 Transmission, Tuff-Cork	W39365TC	1
1988-1990, Turbo Hydra-Matic 400 M40 Transmission, Turbo Hydra-Matic 475 Transmission	W39341	1	1982-1984, Turbo Hydra-Matic 200 M29, MV9 Transmission	W39045	1
1988-1990, Turbo Hydra-Matic 400 M40 Transmission, Turbo Hydra-Matic 475 Transmission, Tuff-Cork	W39341TC	1	1982-1984, Turbo Hydra-Matic 200 M29, MV9 Transmission, Tuff-Cork	W39045TC	1
C3500(GMC)			1969-1971, Turbo Hydra-Matic 350 M38, MV4 Transmission		
P.T.O. Cover Gasket			1969-1971, Turbo Hydra-Matic 350 M38, MV4 Transmission, Tuff-Cork		
1988-1999, 6 Bolt, Chelsea Power Take Off	H36080	1	1967-1986, Turbo Hydra-Matic 400 M40 Transmission, Turbo Hydra-Matic 475 Transmission	W39341	1
1988-1999, 8 Bolt, Chelsea Power Take Off	H36124	1	1967-1986, Turbo Hydra-Matic 400 M40 Transmission, Turbo Hydra-Matic 475 Transmission, Tuff-Cork	W39341TC	1
1967-1986, 6 Bolt, Chelsea Power Take Off	H36080	1	1967-1971, Powerglide Transmission	W39007	1
1967-1986, 8 Bolt, Chelsea Power Take Off	H36124	1	C3500HD		
P.T.O. Mounting Gasket			Transmission Pan Gasket		
1988-1999, .010" Thickness, 6 Bolt, Chelsea Power Take Off	H26205	1	1999-2002, Turbo Hydra-Matic 4L80E MT1 Transmission	W39379	1
1988-1999, .010" Thickness, 8 Bolt, Chelsea Power Take Off	H26207	1	CABALLERO		
1988-1999, .020" Thickness, 6 Bolt, Chelsea Power Take Off	H26206	1	Transmission Gasket Set		
1988-1999, .020" Thickness, 8 Bolt, Chelsea Power Take Off	H26208	1	1978-1987, Muncie 4 Speed Transmission	TS27920Y	1
1967-1986, .010" Thickness, 6 Bolt, Chelsea Power Take Off	H26205	1	1978-1981, Muncie 3 Speed Transmission	TS27594	1
1967-1986, .010" Thickness, 8 Bolt, Chelsea Power Take Off	H26207	1	1978-1981, Saginaw 3 Speed Transmission	TS14737W	1
1967-1986, .020" Thickness, 6 Bolt, Chelsea Power Take Off	H26206	1	Transmission Pan Gasket		
1967-1986, .020" Thickness, 8 Bolt, Chelsea Power Take Off	H26208	1	1982-1987, Turbo Hydra-Matic 700-R4 MD8 Transmission	W39365	1
Transmission Gasket Set			1982-1987, Turbo Hydra-Matic 700-R4 MD8 Transmission, Tuff-Cork	W39365TC	1
1970-1981, Muncie 3 Speed Transmission	TS27594	1	1982-1984, Turbo Hydra-Matic 200 M29, MV9 Transmission	W39045	1
1969-1981, Saginaw 3 Speed Transmission	TS14737W	1	1982-1984, Turbo Hydra-Matic 200 M29, MV9 Transmission, Tuff-Cork	W39045TC	1
1969-1972, Except Overdrive Transmission, Muncie 3 Speed Transmission	TS27594	1	1978-1987, Turbo Hydra-Matic 400 M40 Transmission, Turbo Hydra-Matic 475 Transmission	W39341	1
1969, Saginaw 3 Speed Transmission, Saginaw 4 Speed Transmission	TS14737W	1	1978-1987, Turbo Hydra-Matic 400 M40 Transmission, Turbo Hydra-Matic 475 Transmission, Tuff-Cork	W39341TC	1
1968-1986, Muncie 4 Speed Transmission	TS27920Y	1	CLASSIC SIERRA 1500		
1968-1969, Saginaw 4 Speed Transmission	TS14737W	1	Transmission Pan Gasket		
1967-1969, Saginaw 3 Speed Transmission	TS14737W	1	1999, Turbo Hydra-Matic 4L60E M30 Transmission	W39365	1
1967-1968, Except Overdrive Transmission, Muncie 3 Speed Transmission, Contains Seals	TS27011W	1	1999, Turbo Hydra-Matic 4L60E M30 Transmission, Tuff-Cork	W39365TC	1
1967-1968, Except Overdrive Transmission, Muncie 3 Speed Transmission, Seals Not Included	TS27061	1	CLASSIC SIERRA 2500		
1967, Muncie 4 Speed Transmission	TS27520X	1	Transmission Pan Gasket		
1967, Overdrive Transmission	TS14737W	1	1997-2000, Turbo Hydra-Matic 4L60E M30 Transmission	W39365	1
Transmission Pan Gasket			1997-2000, Turbo Hydra-Matic 4L60E M30 Transmission, Tuff-Cork	W39365TC	1
1991-1999, Turbo Hydra-Matic 4L80E MT1 Transmission	W39379	1	1997-2000, Turbo Hydra-Matic 4L80E MT1 Transmission	W39379	1
1988-1992, Turbo Hydra-Matic 700-R4 MD8 Transmission	W39365	1	CLASSIC SIERRA 3500		
1988-1992, Turbo Hydra-Matic 700-R4 MD8 Transmission, Tuff-Cork	W39365TC	1	Transmission Pan Gasket		
1988-1990, Turbo Hydra-Matic 400 M40 Transmission, Turbo Hydra-Matic 475 Transmission	W39341	1	1999-2000, Turbo Hydra-Matic 4L80E MT1 Transmission	W39379	1
1988-1990, Turbo Hydra-Matic 400 M40 Transmission, Turbo Hydra-Matic 475 Transmission, Tuff-Cork	W39341TC	1			

LIGHT TRUCK

General Motors Truck (cont.)

Transmission Gaskets (cont.)					
Model & Application	Part No.	Qty.	Model & Application	Part No.	Qty.
CLASSIC SIERRA 3500HD			ENVOY (cont.)		
Transmission Pan Gasket			Transmission Pan Gasket (cont.)		
1999-2002, Turbo Hydra-Matic 4L80E MT1 Transmission.			1998-2001, Turbo Hydra-Matic 4L60E M30 Transmission, Tuff-Cork.		
	W39379	1		W39365TC	1
EL CAMINO			ENVOY XL		
Transmission Gasket Set			Transmission Pan Gasket		
1970-1981, Muncie 3 Speed Transmission . . .			2003, Turbo Hydra-Matic 4L60E M30 Transmission.		
	TS27594	1		W39365	1
1969, Except Overdrive Transmission, Muncie 3 Speed Transmission			2003, Turbo Hydra-Matic 4L60E M30 Transmission, Tuff-Cork.		
	TS27594	1		W39365TC	1
1968-1981, Saginaw 3 Speed Transmission . .			ESCALADE		
	TS14737W	1	Transmission Pan Gasket		
1968-1969, Except Overdrive Transmission, Muncie 3 Speed Transmission, Contains Seals.			2002-2003, Turbo Hydra-Matic 4L60E M30 Transmission.		
	TS27011W	1		W39365	1
1968-1969, Except Overdrive Transmission, Muncie 3 Speed Transmission, Seals Not Included.			2002-2003, Turbo Hydra-Matic 4L60E M30 Transmission, Tuff-Cork.		
	TS27061	1		W39365TC	1
1968-1969, Saginaw 4 Speed Transmission . .			2002-2003, Turbo Hydra-Matic 4L80E MT1 Transmission.		
	TS14737W	1		W39379	1
1967-1969, Saginaw 3 Speed Transmission . .			1999-2000, Turbo Hydra-Matic 4L60E M30 Transmission.		
	TS14737W	1		W39365	1
1966-1967, Muncie 4 Speed Transmission . . .			1999-2000, Turbo Hydra-Matic 4L60E M30 Transmission, Tuff-Cork.		
	TS27520X	1		W39365TC	1
1966-1967, Overdrive Transmission			ESCALADE ESV		
	TS14737W	1	Transmission Pan Gasket		
1966, Overdrive Transmission, Saginaw 4 Speed Transmission.			2003, Turbo Hydra-Matic 4L80E MT1 Transmission.		
	TS14737W	1		W39379	1
1964-1968, 3 Speed Transmission, Except Heavy Duty Transmission, Except Overdrive Transmission, Muncie 3 Speed Transmission, Contains Seals			ESCALADE EXT		
	TS27011W	1	Transmission Pan Gasket		
1964-1968, 3 Speed Transmission, Except Heavy Duty Transmission, Except Overdrive Transmission, Muncie 3 Speed Transmission, Seals Not Included.			2002-2003, Turbo Hydra-Matic 4L80E MT1 Transmission.		
	TS27061	1		W39379	1
1964-1967, 4 Speed Transmission, Muncie 4 Speed Transmission.			2002, Turbo Hydra-Matic 4L60E M30 Transmission.		
	TS27520X	1		W39365	1
1964-1966, 3 Speed Transmission, Except Heavy Duty Transmission, Contains Seals. . .			2002, Turbo Hydra-Matic 4L60E M30 Transmission, Tuff-Cork.		
	TS27011W	1		W39365TC	1
1964-1966, 3 Speed Transmission, Except Heavy Duty Transmission, Seals Not Included.			EXPRESS 1500		
	TS27061	1	Transmission Pan Gasket		
1959-1960, 3 Speed Transmission, Except Heavy Duty Transmission, Contains Seals. . .			1996-2003, Turbo Hydra-Matic 4L60E M30 Transmission.		
	TS27011W	1		W39365	1
1959-1960, 3 Speed Transmission, Except Heavy Duty Transmission, Seals Not Included.			1996-2003, Turbo Hydra-Matic 4L60E M30 Transmission, Tuff-Cork.		
	TS27061	1		W39365TC	1
1959-1960, 4 Speed Transmission			EXPRESS 2500		
	TS27520X	1	Transmission Pan Gasket		
Transmission Pan Gasket			1996-2003, Turbo Hydra-Matic 4L60E M30 Transmission.		
1982-1987, Turbo Hydra-Matic 700-R4 MD8 Transmission.			1996-2003, Turbo Hydra-Matic 4L60E M30 Transmission, Tuff-Cork.		
	W39365	1		W39365TC	1
1982-1987, Turbo Hydra-Matic 700-R4 MD8 Transmission, Tuff-Cork.			1996-2003, Turbo Hydra-Matic 4L80E MT1 Transmission.		
	W39365TC	1		W39379	1
1982-1984, Turbo Hydra-Matic 200 M29, MV9 Transmission.			EXPRESS 2500 EXT		
	W39045	1	Transmission Pan Gasket		
1982-1984, Turbo Hydra-Matic 200 M29, MV9 Transmission, Tuff-Cork.			1996-2003, Turbo Hydra-Matic 4L60E M30 Transmission.		
	W39045TC	1		W39365	1
1969-1971, Turbo Hydra-Matic 350 M38, MV4 Transmission.			1996-2003, Turbo Hydra-Matic 4L60E M30 Transmission, Tuff-Cork.		
	W39348	1		W39365TC	1
1969-1971, Turbo Hydra-Matic 350 M38, MV4 Transmission, Tuff-Cork.			1996-2003, Turbo Hydra-Matic 4L80E MT1 Transmission.		
	W39348TC	1		W39379	1
1965-1987, Turbo Hydra-Matic 400 M40 Transmission, Turbo Hydra-Matic 475 Transmission.			EXPRESS 3500		
	W39341	1	Transmission Pan Gasket		
1965-1987, Turbo Hydra-Matic 400 M40 Transmission, Turbo Hydra-Matic 475 Transmission, Tuff-Cork.			1996-2003, Turbo Hydra-Matic 4L60E M30 Transmission.		
	W39341TC	1		W39365	1
1964-1971, Powerglide Transmission			1996-2003, Turbo Hydra-Matic 4L60E M30 Transmission, Tuff-Cork.		
	W39007	1		W39365TC	1
ENVOY			1996-2003, Turbo Hydra-Matic 4L80E MT1 Transmission.		
Transmission Pan Gasket				W39379	1
1998-2001, Turbo Hydra-Matic 4L60E M30 Transmission.				W39379	1

LIGHT TRUCK

General Motors Truck (cont.)

Transmission Gaskets (cont.)

<i>Model & Application</i>	<i>Part No.</i>	<i>Qty.</i>	<i>Model & Application</i>	<i>Part No.</i>	<i>Qty.</i>
EXPRESS 3500 EXT			G1000 (cont.)		
Transmission Pan Gasket			Transmission Gasket Set (cont.)		
1996-2003, Turbo Hydra-Matic 4L80E MT1 Transmission	W39379	1	1966, Overdrive Transmission, Saginaw 4 Speed Transmission	TS14737W	1
G10			1964-1966, 3 Speed Transmission, Except Heavy Duty Transmission, Contains Seals . .	TS27011W	1
Transmission Gasket Set			1964-1966, 3 Speed Transmission, Except Heavy Duty Transmission, Seals Not Included	TS27061	1
1973-1981, Muncie 3 Speed Transmission . . .	TS27594	1	1964-1966, 4 Speed Transmission, Muncie 4 Speed Transmission	TS27520X	1
1969-1981, Saginaw 3 Speed Transmission . .	TS14737W	1	1964-1965, 4 Speed Transmission	TS27520X	1
1969-1972, Except Overdrive Transmission, Muncie 3 Speed Transmission	TS27594	1	Transmission Pan Gasket		
1968-1987, Muncie 4 Speed Transmission . . .	TS27920Y	1	1964-1966, Powerglide Transmission	W39007	1
1968-1969, Saginaw 4 Speed Transmission . .	TS14737W	1	G1500		
1968, Except Overdrive Transmission, Muncie 3 Speed Transmission, Contains Seals	TS27011W	1	Transmission Pan Gasket		
1968, Except Overdrive Transmission, Muncie 3 Speed Transmission, Seals Not Included	TS27061	1	1996-1999, Turbo Hydra-Matic 4L60E M30 Transmission	W39365	1
1967-1969, Saginaw 3 Speed Transmission . .	TS14737W	1	1996-1999, Turbo Hydra-Matic 4L60E M30 Transmission, Tuff-Cork	W39365TC	1
1966-1967, Muncie 4 Speed Transmission . . .	TS27520X	1	1996, Turbo Hydra-Matic 4L80E MT1 Transmission	W39379	1
1966-1967, Overdrive Transmission	TS14737W	1	G1500(GMC)		
1966, Overdrive Transmission, Saginaw 4 Speed Transmission	TS14737W	1	Transmission Gasket Set		
1964-1968, 3 Speed Transmission, Except Heavy Duty Transmission, Except Overdrive Transmission, Muncie 3 Speed Transmission, Contains Seals	TS27011W	1	1970-1981, Muncie 3 Speed Transmission . . .	TS27594	1
1964-1968, 3 Speed Transmission, Except Heavy Duty Transmission, Except Overdrive Transmission, Muncie 3 Speed Transmission, Seals Not Included	TS27061	1	1969-1972, Except Overdrive Transmission, Muncie 3 Speed Transmission	TS27594	1
1964-1967, 4 Speed Transmission, Muncie 4 Speed Transmission	TS27520X	1	1968-1987, Muncie 4 Speed Transmission . . .	TS27920Y	1
1964-1966, 3 Speed Transmission, Except Heavy Duty Transmission, Contains Seals . .	TS27011W	1	1968-1981, Saginaw 3 Speed Transmission . .	TS14737W	1
1964-1966, 3 Speed Transmission, Except Heavy Duty Transmission, Seals Not Included	TS27061	1	1968-1969, Saginaw 4 Speed Transmission . .	TS14737W	1
Transmission Pan Gasket			1967-1969, Saginaw 3 Speed Transmission . .	TS14737W	1
1993-1995, Turbo Hydra-Matic 4L60E M30 Transmission	W39365	1	1967-1968, Except Overdrive Transmission, Muncie 3 Speed Transmission, Contains Seals	TS27011W	1
1993-1995, Turbo Hydra-Matic 4L60E M30 Transmission, Tuff-Cork	W39365TC	1	1967-1968, Except Overdrive Transmission, Muncie 3 Speed Transmission, Seals Not Included	TS27061	1
1991-1995, Turbo Hydra-Matic 4L80E MT1 Transmission	W39379	1	1967, Muncie 4 Speed Transmission	TS27520X	1
1982-1992, Turbo Hydra-Matic 700-R4 MD8 Transmission	W39365	1	1967, Overdrive Transmission	TS14737W	1
1982-1992, Turbo Hydra-Matic 700-R4 MD8 Transmission, Tuff-Cork	W39365TC	1	Transmission Pan Gasket		
1982-1984, Turbo Hydra-Matic 200 M29, MV9 Transmission	W39045	1	1993-1999, Turbo Hydra-Matic 4L60E M30 Transmission	W39365	1
1982-1984, Turbo Hydra-Matic 200 M29, MV9 Transmission, Tuff-Cork	W39045TC	1	1993-1999, Turbo Hydra-Matic 4L60E M30 Transmission, Tuff-Cork	W39365TC	1
1969-1971, Turbo Hydra-Matic 350 M38, MV4 Transmission	W39348	1	1991-1996, Turbo Hydra-Matic 4L80E MT1 Transmission	W39379	1
1969-1971, Turbo Hydra-Matic 350 M38, MV4 Transmission, Tuff-Cork	W39348TC	1	1982-1992, Turbo Hydra-Matic 700-R4 MD8 Transmission	W39365	1
1965-1990, Turbo Hydra-Matic 400 M40 Transmission, Turbo Hydra-Matic 475 Transmission	W39341	1	1982-1992, Turbo Hydra-Matic 700-R4 MD8 Transmission, Tuff-Cork	W39365TC	1
1965-1990, Turbo Hydra-Matic 400 M40 Transmission, Turbo Hydra-Matic 475 Transmission, Tuff-Cork	W39341TC	1	1982-1984, Turbo Hydra-Matic 200 M29, MV9 Transmission	W39045	1
1964-1971, Powerglide Transmission	W39007	1	1982-1984, Turbo Hydra-Matic 200 M29, MV9 Transmission, Tuff-Cork	W39045TC	1
G1000			1969-1971, Turbo Hydra-Matic 350 M38, MV4 Transmission	W39348	1
Transmission Gasket Set			1969-1971, Turbo Hydra-Matic 350 M38, MV4 Transmission, Tuff-Cork	W39348TC	1
1966, Muncie 4 Speed Transmission	TS27520X	1	1967-1990, Turbo Hydra-Matic 400 M40 Transmission, Turbo Hydra-Matic 475 Transmission	W39341	1
			1967-1990, Turbo Hydra-Matic 400 M40 Transmission, Turbo Hydra-Matic 475 Transmission, Tuff-Cork	W39341TC	1
			1967-1971, Powerglide Transmission	W39007	1

LIGHT TRUCK

Transmission Gaskets (cont.)

<i>Model & Application</i>	<i>Part No.</i>	<i>Qty.</i>	<i>Model & Application</i>	<i>Part No.</i>	<i>Qty.</i>
G20			G2500(GMC) (cont.)		
Transmission Gasket Set			Transmission Gasket Set (cont.)		
1973-1981, Muncie 3 Speed Transmission . . .	TS27594	1	1967, Muncie 4 Speed Transmission	TS27520X	1
1969-1972, Except Overdrive Transmission, Muncie 3 Speed Transmission	TS27594	1	1967, Overdrive Transmission	TS14737W	1
1969, Saginaw 4 Speed Transmission	TS14737W	1	Transmission Pan Gasket		
1968-1987, Muncie 4 Speed Transmission . . .	TS27920Y	1	1993-1999, Turbo Hydra-Matic 4L60E M30 Transmission	W39365	1
1968-1981, Saginaw 3 Speed Transmission . .	TS14737W	1	1993-1999, Turbo Hydra-Matic 4L60E M30 Transmission, Tuff-Cork	W39365TC	1
1968-1969, Saginaw 4 Speed Transmission . .	TS14737W	1	1991-1999, Turbo Hydra-Matic 4L80E MT1 Transmission	W39379	1
1967-1969, Saginaw 3 Speed Transmission . .	TS14737W	1	1982-1992, Turbo Hydra-Matic 700-R4 MD8 Transmission	W39365	1
1967-1968, Except Overdrive Transmission, Muncie 3 Speed Transmission, Contains Seals	TS27011W	1	1982-1992, Turbo Hydra-Matic 700-R4 MD8 Transmission, Tuff-Cork	W39365TC	1
1967-1968, Except Overdrive Transmission, Muncie 3 Speed Transmission, Seals Not Included	TS27061	1	1982-1984, Turbo Hydra-Matic 200 M29, MV9 Transmission	W39045	1
1967, Muncie 4 Speed Transmission	TS27520X	1	1982-1984, Turbo Hydra-Matic 200 M29, MV9 Transmission, Tuff-Cork	W39045TC	1
1967, Overdrive Transmission	TS14737W	1	1969-1971, Turbo Hydra-Matic 350 M38, MV4 Transmission	W39348	1
Transmission Pan Gasket			1969-1971, Turbo Hydra-Matic 350 M38, MV4 Transmission, Tuff-Cork	W39348TC	1
1993-1995, Turbo Hydra-Matic 4L60E M30 Transmission	W39365	1	1967-1990, Turbo Hydra-Matic 400 M40 Transmission, Turbo Hydra-Matic 475 Transmission	W39341	1
1993-1995, Turbo Hydra-Matic 4L60E M30 Transmission, Tuff-Cork	W39365TC	1	1967-1990, Turbo Hydra-Matic 400 M40 Transmission, Turbo Hydra-Matic 475 Transmission, Tuff-Cork	W39341TC	1
1991-1995, Turbo Hydra-Matic 4L80E MT1 Transmission	W39379	1	1967-1971, Powerglide Transmission	W39007	1
1982-1992, Turbo Hydra-Matic 700-R4 MD8 Transmission	W39365	1	G30		
1982-1992, Turbo Hydra-Matic 700-R4 MD8 Transmission, Tuff-Cork	W39365TC	1	P.T.O. Cover Gasket		
1982-1984, Turbo Hydra-Matic 200 M29, MV9 Transmission	W39045	1	1971-1996, 6 Bolt, Chelsea Power Take Off . . .	H36080	1
1982-1984, Turbo Hydra-Matic 200 M29, MV9 Transmission, Tuff-Cork	W39045TC	1	1971-1996, 8 Bolt, Chelsea Power Take Off . . .	H36124	1
1969-1971, Turbo Hydra-Matic 350 M38, MV4 Transmission	W39348	1	P.T.O. Mounting Gasket		
1969-1971, Turbo Hydra-Matic 350 M38, MV4 Transmission, Tuff-Cork	W39348TC	1	1971-1996, .010" Thickness, 6 Bolt, Chelsea Power Take Off	H26205	1
1967-1990, Turbo Hydra-Matic 400 M40 Transmission, Turbo Hydra-Matic 475 Transmission	W39341	1	1971-1996, .010" Thickness, 8 Bolt, Chelsea Power Take Off	H26207	1
1967-1990, Turbo Hydra-Matic 400 M40 Transmission, Turbo Hydra-Matic 475 Transmission, Tuff-Cork	W39341TC	1	1971-1996, .020" Thickness, 6 Bolt, Chelsea Power Take Off	H26206	1
1967-1971, Powerglide Transmission	W39007	1	1971-1996, .020" Thickness, 8 Bolt, Chelsea Power Take Off	H26208	1
G2500			Transmission Gasket Set		
Transmission Pan Gasket			1971-1987, Muncie 4 Speed Transmission . . .	TS27920Y	1
1996-1999, Turbo Hydra-Matic 4L60E M30 Transmission	W39365	1	1971-1981, Muncie 3 Speed Transmission . . .	TS27594	1
1996-1999, Turbo Hydra-Matic 4L60E M30 Transmission, Tuff-Cork	W39365TC	1	1971-1981, Saginaw 3 Speed Transmission . .	TS14737W	1
1996-1999, Turbo Hydra-Matic 4L80E MT1 Transmission	W39379	1	Transmission Pan Gasket		
G2500(GMC)			1991-1996, Turbo Hydra-Matic 4L80E MT1 Transmission	W39379	1
Transmission Gasket Set			1982-1992, Turbo Hydra-Matic 700-R4 MD8 Transmission	W39365	1
1970-1981, Muncie 3 Speed Transmission . . .	TS27594	1	1982-1992, Turbo Hydra-Matic 700-R4 MD8 Transmission, Tuff-Cork	W39365TC	1
1969-1971, Except Overdrive Transmission, Muncie 3 Speed Transmission	TS27594	1	1982-1984, Turbo Hydra-Matic 200 M29, MV9 Transmission	W39045	1
1968-1987, Muncie 4 Speed Transmission . . .	TS27920Y	1	1982-1984, Turbo Hydra-Matic 200 M29, MV9 Transmission, Tuff-Cork	W39045TC	1
1968-1981, Saginaw 3 Speed Transmission . .	TS14737W	1	1971-1990, Turbo Hydra-Matic 400 M40 Transmission, Turbo Hydra-Matic 475 Transmission	W39341	1
1968-1969, Saginaw 4 Speed Transmission . .	TS14737W	1	1971-1990, Turbo Hydra-Matic 400 M40 Transmission, Turbo Hydra-Matic 475 Transmission, Tuff-Cork	W39341TC	1
1967-1969, Saginaw 3 Speed Transmission . .	TS14737W	1	1971, Powerglide Transmission	W39007	1
1967-1968, Except Overdrive Transmission, Muncie 3 Speed Transmission, Contains Seals	TS27011W	1	1971, Turbo Hydra-Matic 350 M38, MV4 Transmission	W39348	1
1967-1968, Except Overdrive Transmission, Muncie 3 Speed Transmission, Seals Not Included	TS27061	1			

LIGHT TRUCK

General Motors Truck (cont.)

Transmission Gaskets (cont.)

<i>Model & Application</i>	<i>Part No.</i>	<i>Qty.</i>	<i>Model & Application</i>	<i>Part No.</i>	<i>Qty.</i>
G30 (cont.)			JIMMY		
Transmission Pan Gasket (cont.)			Transfer Case Gasket Set		
1971, Turbo Hydra-Matic 350 M38, MV4 Transmission, Tuff-Cork.	W39348TC	1	1973-1979, New Process 203	TS27292	1
G3500			1971-1983, New Process 205	TS27275	1
P.T.O. Cover Gasket			Transmission Gasket Set		
1996-1999, 6 Bolt, Chelsea Power Take Off . . .	H36080	1	1971-1987, Muncie 4 Speed Transmission . . .	TS27920Y	1
1996-1999, 8 Bolt, Chelsea Power Take Off . . .	H36124	1	1971-1981, Muncie 3 Speed Transmission . . .	TS27594	1
P.T.O. Mounting Gasket			1971-1981, Saginaw 3 Speed Transmission . .	TS14737W	1
1996-1999, .010" Thickness, 6 Bolt, Chelsea Power Take Off	H26205	1	Transmission Pan Gasket		
1996-1999, .010" Thickness, 8 Bolt, Chelsea Power Take Off	H26207	1	1995-2001, Turbo Hydra-Matic 4L60E M30 Transmission.	W39365	1
1996-1999, .020" Thickness, 6 Bolt, Chelsea Power Take Off	H26206	1	1995-2001, Turbo Hydra-Matic 4L60E M30 Transmission, Tuff-Cork.	W39365TC	1
1996-1999, .020" Thickness, 8 Bolt, Chelsea Power Take Off	H26208	1	1991, Turbo Hydra-Matic 4L80E MT1 Transmission.	W39379	1
Transmission Pan Gasket			1982-1991, Turbo Hydra-Matic 700-R4 MD8 Transmission.	W39365	1
1996-1999, Turbo Hydra-Matic 4L80E MT1 Transmission.	W39379	1	1982-1991, Turbo Hydra-Matic 700-R4 MD8 Transmission, Tuff-Cork.	W39365TC	1
1996, Turbo Hydra-Matic 4L60E M30 Transmission.	W39365	1	1982-1984, Turbo Hydra-Matic 200 M29, MV9 Transmission.	W39045	1
1996, Turbo Hydra-Matic 4L60E M30 Transmission, Tuff-Cork.	W39365TC	1	1982-1984, Turbo Hydra-Matic 200 M29, MV9 Transmission, Tuff-Cork.	W39045TC	1
G3500(GMC)			1971-1990, Turbo Hydra-Matic 400 M40 Transmission, Turbo Hydra-Matic 475 Transmission.	W39341	1
P.T.O. Cover Gasket			1971-1990, Turbo Hydra-Matic 400 M40 Transmission, Turbo Hydra-Matic 475 Transmission, Tuff-Cork.	W39341TC	1
1971-1999, 6 Bolt, Chelsea Power Take Off . . .	H36080	1	1971, Powerglide Transmission	W39007	1
1971-1999, 8 Bolt, Chelsea Power Take Off . . .	H36124	1	1971, Turbo Hydra-Matic 350 M38, MV4 Transmission.	W39348	1
P.T.O. Mounting Gasket			1971, Turbo Hydra-Matic 350 M38, MV4 Transmission, Tuff-Cork.	W39348TC	1
1971-1999, .010" Thickness, 6 Bolt, Chelsea Power Take Off	H26205	1	K10		
1971-1999, .010" Thickness, 8 Bolt, Chelsea Power Take Off	H26207	1	Transfer Case Gasket Set		
1971-1999, .020" Thickness, 6 Bolt, Chelsea Power Take Off	H26206	1	1973-1979, New Process 203	TS27292	1
1971-1999, .020" Thickness, 8 Bolt, Chelsea Power Take Off	H26208	1	1969-1983, New Process 205	TS27275	1
Transmission Gasket Set			Transmission Gasket Set		
1971-1987, Muncie 4 Speed Transmission . . .	TS27920Y	1	1973-1981, Muncie 3 Speed Transmission . . .	TS27594	1
1971-1981, Muncie 3 Speed Transmission . . .	TS27594	1	1969-1981, Saginaw 3 Speed Transmission . .	TS14737W	1
1971-1981, Saginaw 3 Speed Transmission . .	TS14737W	1	1969-1972, Except Overdrive Transmission, Muncie 3 Speed Transmission	TS27594	1
Transmission Pan Gasket			1968-1986, Muncie 4 Speed Transmission . . .	TS27920Y	1
1991-1999, Turbo Hydra-Matic 4L80E MT1 Transmission.	W39379	1	1968-1969, Saginaw 4 Speed Transmission . .	TS14737W	1
1982-1992, Turbo Hydra-Matic 700-R4 MD8 Transmission.	W39365	1	1967-1969, Saginaw 3 Speed Transmission . .	TS14737W	1
1982-1992, Turbo Hydra-Matic 700-R4 MD8 Transmission, Tuff-Cork.	W39365TC	1	1967-1968, Except Overdrive Transmission, Muncie 3 Speed Transmission, Contains Seals.	TS27011W	1
1982-1984, Turbo Hydra-Matic 200 M29, MV9 Transmission.	W39045	1	1967-1968, Except Overdrive Transmission, Muncie 3 Speed Transmission, Seals Not Included.	TS27061	1
1982-1984, Turbo Hydra-Matic 200 M29, MV9 Transmission, Tuff-Cork.	W39045TC	1	1966-1967, Muncie 4 Speed Transmission . . .	TS27520X	1
1971-1990, Turbo Hydra-Matic 400 M40 Transmission, Turbo Hydra-Matic 475 Transmission.	W39341	1	1966-1967, Overdrive Transmission	TS14737W	1
1971-1990, Turbo Hydra-Matic 400 M40 Transmission, Turbo Hydra-Matic 475 Transmission, Tuff-Cork.	W39341TC	1	1965-1968, 3 Speed Transmission, Except Heavy Duty Transmission, Except Overdrive Transmission, Muncie 3 Speed Transmission, Contains Seals	TS27011W	1
1971, Powerglide Transmission	W39007	1	1965-1968, 3 Speed Transmission, Except Heavy Duty Transmission, Except Overdrive Transmission, Muncie 3 Speed Transmission, Seals Not Included.	TS27061	1
1971, Turbo Hydra-Matic 350 M38, MV4 Transmission.	W39348	1	1963-1967, 4 Speed Transmission, Muncie 4 Speed Transmission	TS27520X	1
1971, Turbo Hydra-Matic 350 M38, MV4 Transmission, Tuff-Cork.	W39348TC	1	1960-1966, 3 Speed Transmission, Except Heavy Duty Transmission, Contains Seals. . .	TS27011W	1

LIGHT TRUCK

General Motors Truck (cont.)

Transmission Gaskets (cont.)					
Model & Application	Part No.	Qty.	Model & Application	Part No.	Qty.
K10 (cont.)			K10 SUBURBAN (cont.)		
Transmission Gasket Set (cont.)			Transmission Pan Gasket (cont.)		
1960-1966, 3 Speed Transmission, Except Heavy Duty Transmission, Seals Not Included	TS27061	1	1982-1984, Turbo Hydra-Matic 200 M29, MV9 Transmission	W39045	1
1960-1965, 4 Speed Transmission	TS27520X	1	1982-1984, Turbo Hydra-Matic 200 M29, MV9 Transmission, Tuff-Cork	W39045TC	1
Transmission Pan Gasket			1969-1971, Turbo Hydra-Matic 350 M38, MV4 Transmission		
1982-1986, Turbo Hydra-Matic 700-R4 MD8 Transmission	W39365	1	1969-1971, Turbo Hydra-Matic 350 M38, MV4 Transmission, Tuff-Cork	W39348TC	1
1982-1986, Turbo Hydra-Matic 700-R4 MD8 Transmission, Tuff-Cork	W39365TC	1	1965-1986, Turbo Hydra-Matic 400 M40 Transmission, Turbo Hydra-Matic 475 Transmission	W39341	1
1982-1984, Turbo Hydra-Matic 200 M29, MV9 Transmission	W39045	1	1965-1986, Turbo Hydra-Matic 400 M40 Transmission, Turbo Hydra-Matic 475 Transmission, Tuff-Cork	W39341TC	1
1982-1984, Turbo Hydra-Matic 200 M29, MV9 Transmission, Tuff-Cork	W39045TC	1	1963-1971, Powerglide Transmission	W39007	1
1969-1971, Turbo Hydra-Matic 350 M38, MV4 Transmission	W39348	1	K1500		
1969-1971, Turbo Hydra-Matic 350 M38, MV4 Transmission, Tuff-Cork	W39348TC	1	Transmission Pan Gasket		
1965-1986, Turbo Hydra-Matic 400 M40 Transmission, Turbo Hydra-Matic 475 Transmission	W39341	1	1993-1999, Turbo Hydra-Matic 4L60E M30 Transmission	W39365	1
1965-1986, Turbo Hydra-Matic 400 M40 Transmission, Turbo Hydra-Matic 475 Transmission, Tuff-Cork	W39341TC	1	1993-1999, Turbo Hydra-Matic 4L60E M30 Transmission, Tuff-Cork	W39365TC	1
1963-1971, Powerglide Transmission	W39007	1	1991-1999, Turbo Hydra-Matic 4L80E MT1 Transmission	W39379	1
K10 SUBURBAN			1988-1992, Turbo Hydra-Matic 700-R4 MD8 Transmission		
Transfer Case Gasket Set			1988-1992, Turbo Hydra-Matic 700-R4 MD8 Transmission, Tuff-Cork		
1973-1979, New Process 203	TS27292	1	1988-1990, Turbo Hydra-Matic 400 M40 Transmission, Turbo Hydra-Matic 475 Transmission	W39341	1
1969-1983, New Process 205	TS27275	1	1988-1990, Turbo Hydra-Matic 400 M40 Transmission, Turbo Hydra-Matic 475 Transmission, Tuff-Cork	W39341TC	1
Transmission Gasket Set			K1500 SUBURBAN		
1973-1981, Muncie 3 Speed Transmission	TS27594	1	Transmission Pan Gasket		
1969-1981, Saginaw 3 Speed Transmission	TS14737W	1	1993-1999, Turbo Hydra-Matic 4L60E M30 Transmission	W39365	1
1969-1972, Except Overdrive Transmission, Muncie 3 Speed Transmission	TS27594	1	1993-1999, Turbo Hydra-Matic 4L60E M30 Transmission, Tuff-Cork	W39365TC	1
1968-1986, Muncie 4 Speed Transmission	TS27920Y	1	1992-1999, Turbo Hydra-Matic 4L80E MT1 Transmission	W39379	1
1968-1969, Saginaw 4 Speed Transmission	TS14737W	1	1992, Turbo Hydra-Matic 700-R4 MD8 Transmission	W39365	1
1967-1969, Saginaw 3 Speed Transmission	TS14737W	1	1992, Turbo Hydra-Matic 700-R4 MD8 Transmission, Tuff-Cork	W39365TC	1
1967-1968, Except Overdrive Transmission, Muncie 3 Speed Transmission, Contains Seals	TS27011W	1	K1500 SUBURBAN (GMC)		
1967-1968, Except Overdrive Transmission, Muncie 3 Speed Transmission, Seals Not Included	TS27061	1	Transfer Case Gasket Set		
1966-1967, Muncie 4 Speed Transmission	TS27520X	1	1973-1979, New Process 203	TS27292	1
1966-1967, Overdrive Transmission	TS14737W	1	1969-1983, New Process 205	TS27275	1
1965-1968, 3 Speed Transmission, Except Heavy Duty Transmission, Except Overdrive Transmission, Muncie 3 Speed Transmission, Contains Seals	TS27011W	1	Transmission Gasket Set		
1965-1968, 3 Speed Transmission, Except Heavy Duty Transmission, Except Overdrive Transmission, Muncie 3 Speed Transmission, Seals Not Included	TS27061	1	1970-1981, Muncie 3 Speed Transmission	TS27594	1
1963-1967, 4 Speed Transmission, Muncie 4 Speed Transmission	TS27520X	1	1969-1972, Except Overdrive Transmission, Muncie 3 Speed Transmission	TS27594	1
1960-1966, 3 Speed Transmission, Except Heavy Duty Transmission, Contains Seals	TS27011W	1	1968-1986, Muncie 4 Speed Transmission	TS27920Y	1
1960-1966, 3 Speed Transmission, Except Heavy Duty Transmission, Seals Not Included	TS27061	1	1968-1981, Saginaw 3 Speed Transmission	TS14737W	1
1960-1965, 4 Speed Transmission	TS27520X	1	1968-1969, Saginaw 4 Speed Transmission	TS14737W	1
Transmission Pan Gasket			1967-1969, Saginaw 3 Speed Transmission	TS14737W	1
1982-1986, Turbo Hydra-Matic 700-R4 MD8 Transmission	W39365	1	1967-1968, Except Overdrive Transmission, Muncie 3 Speed Transmission, Contains Seals	TS27011W	1
1982-1986, Turbo Hydra-Matic 700-R4 MD8 Transmission, Tuff-Cork	W39365TC	1	1967-1968, Except Overdrive Transmission, Muncie 3 Speed Transmission, Seals Not Included	TS27061	1
			1967, Muncie 4 Speed Transmission	TS27520X	1

LIGHT TRUCK

General Motors Truck (cont.)

Transmission Gaskets (cont.)

<i>Model & Application</i>	<i>Part No.</i>	<i>Qty.</i>	<i>Model & Application</i>	<i>Part No.</i>	<i>Qty.</i>
K1500 SUBURBAN (GMC) (cont.)			K1500(GMC) (cont.)		
Transmission Gasket Set (cont.)			Transmission Pan Gasket (cont.)		
1967, Overdrive Transmission	TS14737W	1	1988-1990, Turbo Hydra-Matic 400 M40 Transmission, Turbo Hydra-Matic 475	W39341TC	1
Transmission Pan Gasket			1982-1986, Turbo Hydra-Matic 700-R4 MD8 Transmission	W39365	1
1993-1999, Turbo Hydra-Matic 4L60E M30 Transmission	W39365	1	1982-1986, Turbo Hydra-Matic 700-R4 MD8 Transmission, Tuff-Cork	W39365TC	1
1993-1999, Turbo Hydra-Matic 4L60E M30 Transmission, Tuff-Cork	W39365TC	1	1982-1984, Turbo Hydra-Matic 200 M29, MV9 Transmission	W39045	1
1992-1999, Turbo Hydra-Matic 4L80E MT1 Transmission	W39379	1	1982-1984, Turbo Hydra-Matic 200 M29, MV9 Transmission, Tuff-Cork	W39045TC	1
1992, Turbo Hydra-Matic 700-R4 MD8 Transmission	W39365	1	1969-1971, Turbo Hydra-Matic 350 M38, MV4 Transmission	W39348	1
1992, Turbo Hydra-Matic 700-R4 MD8 Transmission, Tuff-Cork	W39365TC	1	1969-1971, Turbo Hydra-Matic 350 M38, MV4 Transmission, Tuff-Cork	W39348TC	1
1982-1986, Turbo Hydra-Matic 700-R4 MD8 Transmission	W39365	1	1967-1986, Turbo Hydra-Matic 400 M40 Transmission, Turbo Hydra-Matic 475	W39341TC	1
1982-1986, Turbo Hydra-Matic 700-R4 MD8 Transmission, Tuff-Cork	W39365TC	1	1967-1971, Powerglide Transmission	W39007	1
1982-1984, Turbo Hydra-Matic 200 M29, MV9 Transmission	W39045	1	K20		
1982-1984, Turbo Hydra-Matic 200 M29, MV9 Transmission, Tuff-Cork	W39045TC	1	Transfer Case Gasket Set		
1969-1971, Turbo Hydra-Matic 350 M38, MV4 Transmission	W39348	1	1973-1979, New Process 203	TS27292	1
1969-1971, Turbo Hydra-Matic 350 M38, MV4 Transmission, Tuff-Cork	W39348TC	1	1969-1983, New Process 205	TS27275	1
1967-1986, Turbo Hydra-Matic 400 M40 Transmission, Turbo Hydra-Matic 475	W39341TC	1	Transmission Gasket Set		
1967-1971, Powerglide Transmission	W39007	1	1973-1981, Muncie 3 Speed Transmission	TS27594	1
K1500(GMC)			1969-1981, Saginaw 3 Speed Transmission	TS14737W	1
Transfer Case Gasket Set			1969-1972, Except Overdrive Transmission, Muncie 3 Speed Transmission	TS27594	1
1973-1979, New Process 203	TS27292	1	1968-1986, Muncie 4 Speed Transmission	TS27920Y	1
1969-1983, New Process 205	TS27275	1	1968-1969, Saginaw 4 Speed Transmission	TS14737W	1
Transmission Gasket Set			1967-1969, Saginaw 3 Speed Transmission	TS14737W	1
1970-1981, Muncie 3 Speed Transmission	TS27594	1	1967-1968, Except Overdrive Transmission, Muncie 3 Speed Transmission, Contains Seals	TS27011W	1
1969-1972, Except Overdrive Transmission, Muncie 3 Speed Transmission	TS27594	1	1967-1968, Except Overdrive Transmission, Muncie 3 Speed Transmission, Seals Not Included	TS27061	1
1968-1986, Muncie 4 Speed Transmission	TS27920Y	1	1967, Muncie 4 Speed Transmission	TS27520X	1
1968-1981, Saginaw 3 Speed Transmission	TS14737W	1	1967, Overdrive Transmission	TS14737W	1
1968-1969, Saginaw 4 Speed Transmission	TS14737W	1	Transmission Pan Gasket		
1967-1969, Saginaw 3 Speed Transmission	TS14737W	1	1993-1999, Turbo Hydra-Matic 4L60E M30 Transmission	W39365	1
1967-1968, Except Overdrive Transmission, Muncie 3 Speed Transmission, Contains Seals	TS27011W	1	1993-1999, Turbo Hydra-Matic 4L60E M30 Transmission, Tuff-Cork	W39365TC	1
1967-1968, Except Overdrive Transmission, Muncie 3 Speed Transmission, Seals Not Included	TS27061	1	1991-1999, Turbo Hydra-Matic 4L80E MT1 Transmission	W39379	1
1967, Muncie 4 Speed Transmission	TS27520X	1	1988-1992, Turbo Hydra-Matic 700-R4 MD8 Transmission	W39365	1
1967, Overdrive Transmission	TS14737W	1	1988-1992, Turbo Hydra-Matic 700-R4 MD8 Transmission, Tuff-Cork	W39365TC	1
Transmission Pan Gasket			1988-1990, Turbo Hydra-Matic 400 M40 Transmission, Turbo Hydra-Matic 475	W39341	1
1993-1999, Turbo Hydra-Matic 4L60E M30 Transmission	W39365	1	Transmission Pan Gasket		
1993-1999, Turbo Hydra-Matic 4L60E M30 Transmission, Tuff-Cork	W39365TC	1	1982-1986, Turbo Hydra-Matic 700-R4 MD8 Transmission	W39365	1
1991-1999, Turbo Hydra-Matic 4L80E MT1 Transmission	W39379	1	1982-1986, Turbo Hydra-Matic 700-R4 MD8 Transmission, Tuff-Cork	W39365TC	1
1988-1992, Turbo Hydra-Matic 700-R4 MD8 Transmission	W39365	1	1982-1984, Turbo Hydra-Matic 200 M29, MV9 Transmission	W39045	1
1988-1992, Turbo Hydra-Matic 700-R4 MD8 Transmission, Tuff-Cork	W39365TC	1			
1988-1990, Turbo Hydra-Matic 400 M40 Transmission, Turbo Hydra-Matic 475	W39341	1			
1988-1990, Turbo Hydra-Matic 400 M40 Transmission	W39341	1			

LIGHT TRUCK

General Motors Truck (cont.)

Transmission Gaskets (cont.)					
<i>Model & Application</i>	<i>Part No.</i>	<i>Qty.</i>	<i>Model & Application</i>	<i>Part No.</i>	<i>Qty.</i>
K20 (cont.)			K2500 (cont.)		
Transmission Pan Gasket (cont.)			Transmission Pan Gasket (cont.)		
1982-1984, Turbo Hydra-Matic 200 M29, MV9 Transmission, Tuff-Cork.	W39045TC	1	1988-1990, Turbo Hydra-Matic 400 M40 Transmission, Turbo Hydra-Matic 475 Transmission.	W39341	1
1969-1971, Turbo Hydra-Matic 350 M38, MV4 Transmission.	W39348	1	1988-1990, Turbo Hydra-Matic 400 M40 Transmission, Turbo Hydra-Matic 475 Transmission, Tuff-Cork.	W39341TC	1
1969-1971, Turbo Hydra-Matic 350 M38, MV4 Transmission, Tuff-Cork.	W39348TC	1	K2500 SUBURBAN		
1965-1986, Turbo Hydra-Matic 400 M40 Transmission, Turbo Hydra-Matic 475 Transmission.	W39341	1	Transmission Pan Gasket		
1965-1986, Turbo Hydra-Matic 400 M40 Transmission, Turbo Hydra-Matic 475 Transmission, Tuff-Cork.	W39341TC	1	1993-1999, Turbo Hydra-Matic 4L60E M30 Transmission.	W39365	1
1963-1971, Powerglide Transmission	W39007	1	1993-1999, Turbo Hydra-Matic 4L60E M30 Transmission, Tuff-Cork.	W39365TC	1
K20 SUBURBAN			1992-1999, Turbo Hydra-Matic 4L80E MT1 Transmission.	W39379	1
Transfer Case Gasket Set			1992, Turbo Hydra-Matic 700-R4 MD8 Transmission.	W39365	1
1973-1979, New Process 203	TS27292	1	1992, Turbo Hydra-Matic 700-R4 MD8 Transmission, Tuff-Cork.	W39365TC	1
1969-1983, New Process 205	TS27275	1	K2500 SUBURBAN(GMC)		
Transmission Gasket Set			Transfer Case Gasket Set		
1973-1981, Muncie 3 Speed Transmission	TS27594	1	1973-1979, New Process 203	TS27292	1
1969-1981, Saginaw 3 Speed Transmission	TS14737W	1	1967-1983, New Process 205	TS27275	1
1969-1972, Except Overdrive Transmission, Muncie 3 Speed Transmission	TS27594	1	Transmission Gasket Set		
1968-1986, Muncie 4 Speed Transmission	TS27920Y	1	1970-1981, Muncie 3 Speed Transmission	TS27594	1
1968-1969, Saginaw 4 Speed Transmission	TS14737W	1	1968-1981, Saginaw 3 Speed Transmission	TS14737W	1
1967-1969, Saginaw 3 Speed Transmission	TS14737W	1	1968-1969, Saginaw 4 Speed Transmission	TS14737W	1
1967-1968, Except Overdrive Transmission, Muncie 3 Speed Transmission, Contains Seals.	TS27011W	1	1967-1986, Muncie 4 Speed Transmission	TS27920Y	1
1967-1968, Except Overdrive Transmission, Muncie 3 Speed Transmission, Seals Not Included.	TS27061	1	1967-1972, Except Overdrive Transmission, Muncie 3 Speed Transmission	TS27594	1
1967, Muncie 4 Speed Transmission	TS27520X	1	1967-1969, Except Overdrive Transmission, Muncie 3 Speed Transmission, Contains Seals.	TS27011W	1
1967, Overdrive Transmission	TS14737W	1	1967-1969, Except Overdrive Transmission, Muncie 3 Speed Transmission, Seals Not Included.	TS27061	1
Transmission Pan Gasket			1967-1969, Muncie 4 Speed Transmission	TS27520X	1
1982-1986, Turbo Hydra-Matic 700-R4 MD8 Transmission.	W39365	1	1967-1969, Saginaw 3 Speed Transmission	TS14737W	1
1982-1986, Turbo Hydra-Matic 700-R4 MD8 Transmission, Tuff-Cork.	W39365TC	1	1967, Overdrive Transmission	TS14737W	1
1982-1984, Turbo Hydra-Matic 200 M29, MV9 Transmission.	W39045	1	Transmission Pan Gasket		
1982-1984, Turbo Hydra-Matic 200 M29, MV9 Transmission, Tuff-Cork.	W39045TC	1	1993-1999, Turbo Hydra-Matic 4L60E M30 Transmission.	W39365	1
1969-1971, Turbo Hydra-Matic 350 M38, MV4 Transmission.	W39348	1	1993-1999, Turbo Hydra-Matic 4L60E M30 Transmission, Tuff-Cork.	W39365TC	1
1969-1971, Turbo Hydra-Matic 350 M38, MV4 Transmission, Tuff-Cork.	W39348TC	1	1992-1999, Turbo Hydra-Matic 4L80E MT1 Transmission.	W39379	1
1967-1986, Turbo Hydra-Matic 400 M40 Transmission, Turbo Hydra-Matic 475 Transmission.	W39341	1	1992, Turbo Hydra-Matic 700-R4 MD8 Transmission.	W39365	1
1967-1986, Turbo Hydra-Matic 400 M40 Transmission, Turbo Hydra-Matic 475 Transmission, Tuff-Cork.	W39341TC	1	1992, Turbo Hydra-Matic 700-R4 MD8 Transmission, Tuff-Cork.	W39365TC	1
1967-1971, Powerglide Transmission	W39007	1	1982-1986, Turbo Hydra-Matic 700-R4 MD8 Transmission.	W39365	1
K2500			1982-1986, Turbo Hydra-Matic 700-R4 MD8 Transmission, Tuff-Cork.	W39365TC	1
Transmission Pan Gasket			1982-1984, Turbo Hydra-Matic 200 M29, MV9 Transmission.	W39045	1
1993-2000, Turbo Hydra-Matic 4L60E M30 Transmission.	W39365	1	1982-1984, Turbo Hydra-Matic 200 M29, MV9 Transmission, Tuff-Cork.	W39045TC	1
1993-2000, Turbo Hydra-Matic 4L60E M30 Transmission, Tuff-Cork.	W39365TC	1	1967-1986, Turbo Hydra-Matic 400 M40 Transmission, Turbo Hydra-Matic 475 Transmission.	W39341	1
1991-2000, Turbo Hydra-Matic 4L80E MT1 Transmission.	W39379	1	1967-1986, Turbo Hydra-Matic 400 M40 Transmission, Turbo Hydra-Matic 475 Transmission, Tuff-Cork.	W39341TC	1
1988-1992, Turbo Hydra-Matic 700-R4 MD8 Transmission.	W39365	1	1967-1971, Powerglide Transmission	W39007	1
1988-1992, Turbo Hydra-Matic 700-R4 MD8 Transmission, Tuff-Cork.	W39365TC	1			

LIGHT TRUCK

General Motors Truck (cont.)

Transmission Gaskets (cont.)

<i>Model & Application</i>	<i>Part No.</i>	<i>Qty.</i>	<i>Model & Application</i>	<i>Part No.</i>	<i>Qty.</i>
K2500 SUBURBAN(GMC) (cont.)			K30 (cont.)		
Transmission Pan Gasket (cont.)			P.T.O. Mounting Gasket		
1967-1971, Turbo Hydra-Matic 350 M38, MV4 Transmission.	W39348	1	1977-1986, .010" Thickness, 6 Bolt, Chelsea Power Take Off	H26205	1
1967-1971, Turbo Hydra-Matic 350 M38, MV4 Transmission, Tuff-Cork.	W39348TC	1	1977-1986, .010" Thickness, 8 Bolt, Chelsea Power Take Off	H26207	1
K2500(GMC)			1977-1986, .020" Thickness, 6 Bolt, Chelsea Power Take Off	H26206	1
Transfer Case Gasket Set			1977-1986, .020" Thickness, 8 Bolt, Chelsea Power Take Off	H26208	1
1973-1979, New Process 203	TS27292	1	Transfer Case Gasket Set		
1969-1983, New Process 205	TS27275	1	1980-1983, New Process 205	TS27275	1
Transmission Gasket Set			1977-1979, New Process 203	TS27292	1
1970-1981, Muncie 3 Speed Transmission . . .	TS27594	1	Transmission Gasket Set		
1969-1972, Except Overdrive Transmission, Muncie 3 Speed Transmission	TS27594	1	1977-1986, Muncie 4 Speed Transmission . .	TS27920Y	1
1968-1986, Muncie 4 Speed Transmission . .	TS27920Y	1	1977-1981, Muncie 3 Speed Transmission . .	TS27594	1
1968-1981, Saginaw 3 Speed Transmission . .	TS14737W	1	1977-1981, Saginaw 3 Speed Transmission .	TS14737W	1
1968-1969, Saginaw 4 Speed Transmission .	TS14737W	1	Transmission Pan Gasket		
1967-1969, Saginaw 3 Speed Transmission .	TS14737W	1	1982-1986, Turbo Hydra-Matic 700-R4 MD8 Transmission.	W39365	1
1967-1968, Except Overdrive Transmission, Muncie 3 Speed Transmission, Contains Seals.	TS27011W	1	1982-1986, Turbo Hydra-Matic 700-R4 MD8 Transmission, Tuff-Cork.	W39365TC	1
1967-1968, Except Overdrive Transmission, Muncie 3 Speed Transmission, Seals Not Included.	TS27061	1	1982-1984, Turbo Hydra-Matic 200 M29, MV9 Transmission.	W39045	1
1967, Muncie 4 Speed Transmission	TS27520X	1	1982-1984, Turbo Hydra-Matic 200 M29, MV9 Transmission, Tuff-Cork.	W39045TC	1
1967, Overdrive Transmission	TS14737W	1	1977-1986, Turbo Hydra-Matic 400 M40 Transmission, Turbo Hydra-Matic 475 Transmission.	W39341	1
Transmission Pan Gasket			1977-1986, Turbo Hydra-Matic 400 M40 Transmission, Turbo Hydra-Matic 475 Transmission, Tuff-Cork.	W39341TC	1
1993-1999, Turbo Hydra-Matic 4L60E M30 Transmission.	W39365	1	K3500		
1993-1999, Turbo Hydra-Matic 4L60E M30 Transmission, Tuff-Cork.	W39365TC	1	P.T.O. Cover Gasket		
1991-1999, Turbo Hydra-Matic 4L80E MT1 Transmission.	W39379	1	1988-1999, 6 Bolt, Chelsea Power Take Off . . .	H36080	1
1988-1992, Turbo Hydra-Matic 700-R4 MD8 Transmission.	W39365	1	1988-1999, 8 Bolt, Chelsea Power Take Off . . .	H36124	1
1988-1992, Turbo Hydra-Matic 700-R4 MD8 Transmission, Tuff-Cork.	W39365TC	1	P.T.O. Mounting Gasket		
1988-1990, Turbo Hydra-Matic 400 M40 Transmission, Turbo Hydra-Matic 475 Transmission.	W39341	1	1988-1999, .010" Thickness, 6 Bolt, Chelsea Power Take Off	H26205	1
1988-1990, Turbo Hydra-Matic 400 M40 Transmission, Turbo Hydra-Matic 475 Transmission, Tuff-Cork.	W39341TC	1	1988-1999, .010" Thickness, 8 Bolt, Chelsea Power Take Off	H26207	1
1982-1986, Turbo Hydra-Matic 700-R4 MD8 Transmission.	W39365	1	1988-1999, .020" Thickness, 6 Bolt, Chelsea Power Take Off	H26206	1
1982-1986, Turbo Hydra-Matic 700-R4 MD8 Transmission, Tuff-Cork.	W39365TC	1	1988-1999, .020" Thickness, 8 Bolt, Chelsea Power Take Off	H26208	1
1982-1984, Turbo Hydra-Matic 200 M29, MV9 Transmission.	W39045	1	Transmission Pan Gasket		
1982-1984, Turbo Hydra-Matic 200 M29, MV9 Transmission, Tuff-Cork.	W39045TC	1	1991-2000, Turbo Hydra-Matic 4L80E MT1 Transmission.	W39379	1
1969-1971, Turbo Hydra-Matic 350 M38, MV4 Transmission.	W39348	1	1988-1992, Turbo Hydra-Matic 700-R4 MD8 Transmission.	W39365	1
1969-1971, Turbo Hydra-Matic 350 M38, MV4 Transmission, Tuff-Cork.	W39348TC	1	1988-1992, Turbo Hydra-Matic 700-R4 MD8 Transmission, Tuff-Cork.	W39365TC	1
1967-1986, Turbo Hydra-Matic 400 M40 Transmission, Turbo Hydra-Matic 475 Transmission.	W39341	1	1988-1990, Turbo Hydra-Matic 400 M40 Transmission, Turbo Hydra-Matic 475 Transmission.	W39341	1
1967-1986, Turbo Hydra-Matic 400 M40 Transmission, Turbo Hydra-Matic 475 Transmission, Tuff-Cork.	W39341TC	1	1988-1990, Turbo Hydra-Matic 400 M40 Transmission, Turbo Hydra-Matic 475 Transmission, Tuff-Cork.	W39341TC	1
1967-1971, Powerglide Transmission	W39007	1	K3500(GMC)		
K30			P.T.O. Cover Gasket		
P.T.O. Cover Gasket			1988-1999, 6 Bolt, Chelsea Power Take Off . . .	H36080	1
1977-1986, 6 Bolt, Chelsea Power Take Off . . .	H36080	1	1988-1999, 8 Bolt, Chelsea Power Take Off . . .	H36124	1
1977-1986, 8 Bolt, Chelsea Power Take Off . . .	H36124	1	1977-1986, 6 Bolt, Chelsea Power Take Off . . .	H36080	1
			1977-1986, 8 Bolt, Chelsea Power Take Off . . .	H36124	1

LIGHT TRUCK

Transmission Gaskets (cont.)

<i>Model & Application</i>	<i>Part No.</i>	<i>Qty.</i>	<i>Model & Application</i>	<i>Part No.</i>	<i>Qty.</i>
K3500(GMC) (cont.)			P10		
P.T.O. Mounting Gasket			Transmission Gasket Set		
1988-1999, .010" Thickness, 6 Bolt, Chelsea Power Take Off	H26205	1	1973-1981, Muncie 3 Speed Transmission	TS27594	1
1988-1999, .010" Thickness, 8 Bolt, Chelsea Power Take Off	H26207	1	1970-1981, Saginaw 3 Speed Transmission	TS14737W	1
1988-1999, .020" Thickness, 6 Bolt, Chelsea Power Take Off	H26206	1	1969-1972, Except Overdrive Transmission, Muncie 3 Speed Transmission	TS27594	1
1988-1999, .020" Thickness, 8 Bolt, Chelsea Power Take Off	H26208	1	1968-1982, Muncie 4 Speed Transmission	TS27920Y	1
1977-1986, .010" Thickness, 6 Bolt, Chelsea Power Take Off	H26205	1	1968-1969, Saginaw 4 Speed Transmission	TS14737W	1
1977-1986, .010" Thickness, 8 Bolt, Chelsea Power Take Off	H26207	1	1967-1969, Saginaw 3 Speed Transmission	TS14737W	1
1977-1986, .020" Thickness, 6 Bolt, Chelsea Power Take Off	H26206	1	1967-1968, Except Overdrive Transmission, Muncie 3 Speed Transmission, Contains Seals	TS27011W	1
1977-1986, .020" Thickness, 8 Bolt, Chelsea Power Take Off	H26208	1	1967-1968, Except Overdrive Transmission, Muncie 3 Speed Transmission, Seals Not Included	TS27061	1
Transfer Case Gasket Set			1966-1967, Muncie 4 Speed Transmission	TS27520X	1
1980-1983, New Process 205	TS27275	1	1966-1967, Overdrive Transmission	TS14737W	1
1977-1979, New Process 203	TS27292	1	1966, Overdrive Transmission, Saginaw 4 Speed Transmission	TS14737W	1
Transmission Gasket Set			1965-1968, 3 Speed Transmission, Except Heavy Duty Transmission, Except Overdrive Transmission, Muncie 3 Speed Transmission, Contains Seals	TS27011W	1
1977-1986, Muncie 4 Speed Transmission	TS27920Y	1	1965-1968, 3 Speed Transmission, Except Heavy Duty Transmission, Except Overdrive Transmission, Muncie 3 Speed Transmission, Seals Not Included	TS27061	1
1977-1981, Muncie 3 Speed Transmission	TS27594	1	1963-1967, 4 Speed Transmission, Muncie 4 Speed Transmission	TS27520X	1
1977-1981, Saginaw 3 Speed Transmission	TS14737W	1	1960-1966, 3 Speed Transmission, Except Heavy Duty Transmission, Contains Seals	TS27011W	1
Transmission Pan Gasket			1960-1966, 3 Speed Transmission, Except Heavy Duty Transmission, Seals Not Included	TS27061	1
1991-1999, Turbo Hydra-Matic 4L80E MT1 Transmission	W39379	1	1960-1965, 4 Speed Transmission	TS27520X	1
1988-1992, Turbo Hydra-Matic 700-R4 MD8 Transmission	W39365	1	Transmission Pan Gasket		
1988-1992, Turbo Hydra-Matic 700-R4 MD8 Transmission, Tuff-Cork	W39365TC	1	1969-1971, Turbo Hydra-Matic 350 M38, MV4 Transmission	W39348	1
1988-1990, Turbo Hydra-Matic 400 M40 Transmission, Turbo Hydra-Matic 475 Transmission	W39341	1	1969-1971, Turbo Hydra-Matic 350 M38, MV4 Transmission, Tuff-Cork	W39348TC	1
1988-1990, Turbo Hydra-Matic 400 M40 Transmission, Turbo Hydra-Matic 475 Transmission, Tuff-Cork	W39341TC	1	1965-1982, Turbo Hydra-Matic 400 M40 Transmission, Turbo Hydra-Matic 475 Transmission	W39341	1
1982-1986, Turbo Hydra-Matic 700-R4 MD8 Transmission	W39365	1	1965-1982, Turbo Hydra-Matic 400 M40 Transmission, Turbo Hydra-Matic 475 Transmission, Tuff-Cork	W39341TC	1
1982-1986, Turbo Hydra-Matic 700-R4 MD8 Transmission, Tuff-Cork	W39365TC	1	1963-1971, Powerglide Transmission	W39007	1
1982-1984, Turbo Hydra-Matic 200 M29, MV9 Transmission	W39045	1	P1000		
1982-1984, Turbo Hydra-Matic 200 M29, MV9 Transmission, Tuff-Cork	W39045TC	1	Transmission Gasket Set		
1977-1986, Turbo Hydra-Matic 400 M40 Transmission, Turbo Hydra-Matic 475 Transmission	W39341	1	1966, Muncie 4 Speed Transmission	TS27520X	1
1977-1986, Turbo Hydra-Matic 400 M40 Transmission, Turbo Hydra-Matic 475 Transmission, Tuff-Cork	W39341TC	1	1966, Overdrive Transmission, Saginaw 4 Speed Transmission	TS14737W	1
LLV POSTAL VEHICLE			1960-1966, 3 Speed Transmission, Except Heavy Duty Transmission, Contains Seals	TS27011W	1
Transmission Pan Gasket			1960-1966, 3 Speed Transmission, Except Heavy Duty Transmission, Seals Not Included	TS27061	1
1991-1993, Turbo Hydra-Matic 4L80E MT1 Transmission	W39379	1	1960-1965, 4 Speed Transmission	TS27520X	1
1987-1992, Turbo Hydra-Matic 700-R4 MD8 Transmission	W39365	1	Transmission Pan Gasket		
1987-1992, Turbo Hydra-Matic 700-R4 MD8 Transmission, Tuff-Cork	W39365TC	1	1966, Powerglide Transmission	W39007	1
LUMINA APV			P1500(GMC)		
Transmission Pan Gasket			Transmission Gasket Set		
1996, Turbo Hydra-Matic 4L80E MT1 Transmission	W39379	1	1970-1981, Muncie 3 Speed Transmission	TS27594	1
			1970-1981, Saginaw 3 Speed Transmission	TS14737W	1
			1969-1971, Except Overdrive Transmission, Muncie 3 Speed Transmission	TS27594	1

LIGHT TRUCK

General Motors Truck (cont.)

Transmission Gaskets (cont.)				
Model & Application	Part No.	Qty.	Model & Application	Part No. Qty.
P30			P3500(GMC) (cont.)	
P.T.O. Cover Gasket			Transmission Gasket Set (cont.)	
1961-1999, 6 Bolt, Chelsea Power Take Off . . .	H36080	1	1968-1969, Saginaw 4 Speed Transmission . . .	TS14737W 1
1961-1999, 8 Bolt, Chelsea Power Take Off . . .	H36124	1	1967-1969, Saginaw 3 Speed Transmission . . .	TS14737W 1
P.T.O. Mounting Gasket			1967-1968, Except Overdrive Transmission, Muncie 3 Speed Transmission, Contains Seals	TS27011W 1
1961-1999, .010" Thickness, 6 Bolt, Chelsea Power Take Off	H26205	1	1967-1968, Except Overdrive Transmission, Muncie 3 Speed Transmission, Seals Not Included	TS27061 1
1961-1999, .010" Thickness, 8 Bolt, Chelsea Power Take Off	H26207	1	1967, Muncie 4 Speed Transmission	TS27520X 1
1961-1999, .020" Thickness, 6 Bolt, Chelsea Power Take Off	H26206	1	1967, Overdrive Transmission	TS14737W 1
1961-1999, .020" Thickness, 8 Bolt, Chelsea Power Take Off	H26208	1	Transmission Pan Gasket	
Transmission Gasket Set			1991-1999, Turbo Hydra-Matic 4L80E MT1 Transmission	
1970-1981, Muncie 3 Speed Transmission . . .	TS27594	1 W39379 1	
1969-1981, Saginaw 3 Speed Transmission . .	TS14737W	1	PB1500	
1969-1972, Except Overdrive Transmission, Muncie 3 Speed Transmission	TS27594	1	Transmission Gasket Set	
1968-1987, Muncie 4 Speed Transmission . .	TS27920Y	1	1966, Overdrive Transmission, Saginaw 4 Speed Transmission	
1968-1969, Saginaw 4 Speed Transmission . .	TS14737W	1 TS14737W 1	
1967-1969, Saginaw 3 Speed Transmission . .	TS14737W	1	1963-1966, 3 Speed Transmission, Except Heavy Duty Transmission, Contains Seals . .	
1967-1968, Except Overdrive Transmission, Muncie 3 Speed Transmission, Contains Seals	TS27011W	1 TS27011W 1	
1967-1968, Except Overdrive Transmission, Muncie 3 Speed Transmission, Seals Not Included	TS27061	1	1963-1966, 3 Speed Transmission, Except Heavy Duty Transmission, Seals Not Included	
1966-1967, Muncie 4 Speed Transmission . .	TS27520X	1 TS27061 1	
1966-1967, Overdrive Transmission	TS14737W	1	1963-1966, 4 Speed Transmission, Muncie 4 Speed Transmission	
1965-1968, 3 Speed Transmission, Except Heavy Duty Transmission, Except Overdrive Transmission, Muncie 3 Speed Transmission, Contains Seals	TS27011W	1 TS27520X 1	
1965-1968, 3 Speed Transmission, Except Heavy Duty Transmission, Except Overdrive Transmission, Muncie 3 Speed Transmission, Seals Not Included	TS27061	1	Transmission Pan Gasket	
1963-1967, 4 Speed Transmission, Muncie 4 Speed Transmission	TS27520X	1	1963-1966, Powerglide Transmission	
1960-1966, 3 Speed Transmission, Except Heavy Duty Transmission, Contains Seals . .	TS27011W	1 W39007 1	
1960-1966, 3 Speed Transmission, Except Heavy Duty Transmission, Seals Not Included	TS27061	1	PB2500	
1960-1962, 4 Speed Transmission	TS27520X	1	Transmission Gasket Set	
Transmission Pan Gasket			1966, Overdrive Transmission, Saginaw 4 Speed Transmission	
1991-1999, Turbo Hydra-Matic 4L80E MT1 Transmission	W39379	1 TS14737W 1	
P3500(GMC)			1963-1966, 3 Speed Transmission, Except Heavy Duty Transmission, Contains Seals . .	
P.T.O. Cover Gasket		 TS27011W 1	
1967-1999, 6 Bolt, Chelsea Power Take Off . . .	H36080	1	1963-1966, 3 Speed Transmission, Except Heavy Duty Transmission, Seals Not Included	
1967-1999, 8 Bolt, Chelsea Power Take Off . . .	H36124	1 TS27061 1	
P.T.O. Mounting Gasket			1963-1966, 4 Speed Transmission, Muncie 4 Speed Transmission	
1967-1999, .010" Thickness, 6 Bolt, Chelsea Power Take Off	H26205	1 TS27520X 1	
1967-1999, .010" Thickness, 8 Bolt, Chelsea Power Take Off	H26207	1	PM150	
1967-1999, .020" Thickness, 6 Bolt, Chelsea Power Take Off	H26206	1	Transmission Gasket Set	
1967-1999, .020" Thickness, 8 Bolt, Chelsea Power Take Off	H26208	1	1955-1959, 3 Speed Transmission, Except Heavy Duty Transmission, Contains Seals . .	
Transmission Gasket Set		 TS27011W 1	
1970-1981, Muncie 3 Speed Transmission . . .	TS27594	1	1955-1959, 3 Speed Transmission, Except Heavy Duty Transmission, Seals Not Included	
1970-1981, Saginaw 3 Speed Transmission . .	TS14737W	1 TS27061 1	
1969-1972, Except Overdrive Transmission, Muncie 3 Speed Transmission	TS27594	1	1954, 3 Speed Transmission, Except Heavy Duty Transmission	
1968-1987, Muncie 4 Speed Transmission . .	TS27920Y	1 TS26250X 1	
			1951-1959, 4 Speed Transmission	
		 TS27520X 1	
			1951-1953, 3 Speed Transmission	
		 TS26250X 1	
			PM250	
			Transmission Gasket Set	
			1955-1959, 3 Speed Transmission, Except Heavy Duty Transmission, Contains Seals . .	
		 TS27011W 1	
			1955-1959, 3 Speed Transmission, Except Heavy Duty Transmission, Seals Not Included	
		 TS27061 1	
			1954, 3 Speed Transmission, Except Heavy Duty Transmission	
		 TS26250X 1	
			1951-1959, 4 Speed Transmission	
		 TS27520X 1	
			1951-1953, 3 Speed Transmission	
		 TS26250X 1	

LIGHT TRUCK

General Motors Truck (cont.)

Transmission Gaskets (cont.)

<i>Model & Application</i>	<i>Part No.</i>	<i>Qty.</i>	<i>Model & Application</i>	<i>Part No.</i>	<i>Qty.</i>
R10			R1500(GMC) (cont.)		
Transmission Gasket Set			Transmission Pan Gasket		
1987, Muncie 4 Speed Transmission	TS27920Y	1	1987, Turbo Hydra-Matic 400 M40 Transmission, Turbo Hydra-Matic 475 Transmission.	W39341	1
Transmission Pan Gasket			1987, Turbo Hydra-Matic 400 M40 Transmission, Turbo Hydra-Matic 475 Transmission, Tuff-Cork.	W39341TC	1
1987, Turbo Hydra-Matic 400 M40 Transmission, Turbo Hydra-Matic 475 Transmission.	W39341	1	1987, Turbo Hydra-Matic 700-R4 MD8 Transmission.	W39365	1
1987, Turbo Hydra-Matic 400 M40 Transmission, Turbo Hydra-Matic 475 Transmission, Tuff-Cork.	W39341TC	1	1987, Turbo Hydra-Matic 700-R4 MD8 Transmission, Tuff-Cork.	W39365TC	1
1987, Turbo Hydra-Matic 700-R4 MD8 Transmission.	W39365	1	R20		
1987, Turbo Hydra-Matic 700-R4 MD8 Transmission, Tuff-Cork.	W39365TC	1	Transmission Gasket Set		
R10 SUBURBAN			1987, Muncie 4 Speed Transmission		
Transmission Gasket Set			TS27920Y 1		
Transmission Pan Gasket			Transmission Pan Gasket		
1987-1988, Turbo Hydra-Matic 400 M40 Transmission, Turbo Hydra-Matic 475 Transmission.	W39341	1	1987-1988, Turbo Hydra-Matic 400 M40 Transmission, Turbo Hydra-Matic 475 Transmission.	W39341	1
1987-1988, Turbo Hydra-Matic 400 M40 Transmission, Turbo Hydra-Matic 475 Transmission, Tuff-Cork.	W39341TC	1	1987-1988, Turbo Hydra-Matic 400 M40 Transmission, Turbo Hydra-Matic 475 Transmission, Tuff-Cork.	W39341TC	1
1987-1988, Turbo Hydra-Matic 700-R4 MD8 Transmission.	W39365	1	1987-1988, Turbo Hydra-Matic 700-R4 MD8 Transmission.	W39365	1
1987-1988, Turbo Hydra-Matic 700-R4 MD8 Transmission.	W39365	1	1987-1988, Turbo Hydra-Matic 700-R4 MD8 Transmission, Tuff-Cork.	W39365TC	1
1987-1988, Turbo Hydra-Matic 700-R4 MD8 Transmission, Tuff-Cork.	W39365TC	1	R20 SUBURBAN		
R1500 SUBURBAN			Transmission Gasket Set		
Transmission Pan Gasket			1987, Muncie 4 Speed Transmission		
1991, Turbo Hydra-Matic 4L80E MT1 Transmission.	W39379	1	TS27920Y 1		
1989-1991, Turbo Hydra-Matic 700-R4 MD8 Transmission.	W39365	1	Transmission Pan Gasket		
1989-1991, Turbo Hydra-Matic 700-R4 MD8 Transmission, Tuff-Cork.	W39365TC	1	1987-1988, Turbo Hydra-Matic 400 M40 Transmission, Turbo Hydra-Matic 475 Transmission.	W39341	1
1989-1990, Turbo Hydra-Matic 400 M40 Transmission, Turbo Hydra-Matic 475 Transmission.	W39341	1	1987-1988, Turbo Hydra-Matic 400 M40 Transmission, Turbo Hydra-Matic 475 Transmission, Tuff-Cork.	W39341TC	1
1989-1990, Turbo Hydra-Matic 400 M40 Transmission, Turbo Hydra-Matic 475 Transmission, Tuff-Cork.	W39341TC	1	1987-1988, Turbo Hydra-Matic 700-R4 MD8 Transmission.	W39365	1
R1500 SUBURBAN(GMC)			1987-1988, Turbo Hydra-Matic 700-R4 MD8 Transmission, Tuff-Cork.	W39365TC	1
Transmission Gasket Set			R2500		
1987, Muncie 4 Speed Transmission	TS27920Y	1	Transmission Pan Gasket		
Transmission Pan Gasket			1989, Turbo Hydra-Matic 400 M40 Transmission, Turbo Hydra-Matic 475 Transmission.		
1991, Turbo Hydra-Matic 4L80E MT1 Transmission.	W39379	1	1989, Turbo Hydra-Matic 400 M40 Transmission, Turbo Hydra-Matic 475 Transmission, Tuff-Cork.	W39341TC	1
1987-1991, Turbo Hydra-Matic 700-R4 MD8 Transmission.	W39365	1	1989, Turbo Hydra-Matic 700-R4 MD8 Transmission.	W39365	1
1987-1991, Turbo Hydra-Matic 700-R4 MD8 Transmission, Tuff-Cork.	W39365TC	1	1989, Turbo Hydra-Matic 700-R4 MD8 Transmission, Tuff-Cork.	W39365TC	1
1987-1990, Turbo Hydra-Matic 400 M40 Transmission, Turbo Hydra-Matic 475 Transmission.	W39341	1	R2500 SUBURBAN		
1987-1990, Turbo Hydra-Matic 400 M40 Transmission, Turbo Hydra-Matic 475 Transmission, Tuff-Cork.	W39341TC	1	Transmission Pan Gasket		
R1500(GMC)			1991, Turbo Hydra-Matic 4L80E MT1 Transmission.		
Transmission Gasket Set				
1987, Muncie 4 Speed Transmission	TS27920Y	1	1989-1991, Turbo Hydra-Matic 700-R4 MD8 Transmission.	W39365	1
Transmission Pan Gasket			1989-1991, Turbo Hydra-Matic 700-R4 MD8 Transmission, Tuff-Cork.	W39365TC	1
1987, Turbo Hydra-Matic 400 M40 Transmission, Turbo Hydra-Matic 475 Transmission.	W39341	1	1989-1990, Turbo Hydra-Matic 400 M40 Transmission, Turbo Hydra-Matic 475 Transmission.	W39341	1
1987, Turbo Hydra-Matic 400 M40 Transmission, Turbo Hydra-Matic 475 Transmission, Tuff-Cork.	W39341TC	1	1989-1990, Turbo Hydra-Matic 400 M40 Transmission, Turbo Hydra-Matic 475 Transmission.	W39341	1
1987, Turbo Hydra-Matic 700-R4 MD8 Transmission.	W39365	1	1989-1990, Turbo Hydra-Matic 400 M40 Transmission, Turbo Hydra-Matic 475 Transmission.	W39341	1
1987, Turbo Hydra-Matic 700-R4 MD8 Transmission, Tuff-Cork.	W39365TC	1	1989-1990, Turbo Hydra-Matic 400 M40 Transmission, Turbo Hydra-Matic 475 Transmission.	W39341	1

LIGHT TRUCK

General Motors Truck (cont.)

Transmission Gaskets (cont.)					
Model & Application	Part No.	Qty.	Model & Application	Part No.	Qty.
R2500 SUBURBAN (cont.)			R3500		
Transmission Pan Gasket (cont.)			P.T.O. Cover Gasket		
1989-1990, Turbo Hydra-Matic 400 M40			1989-1991, 6 Bolt, Chelsea Power Take Off . . . H36080 1		
Transmission, Turbo Hydra-Matic 475			1989-1991, 8 Bolt, Chelsea Power Take Off . . . H36124 1		
Transmission, Tuff-Cork. W39341TC 1			P.T.O. Mounting Gasket		
R2500 SUBURBAN (GMC)			1989-1991, .010" Thickness, 6 Bolt,		
Transmission Gasket Set			Chelsea Power Take Off H26205 1		
1987, Muncie 4 Speed Transmission TS27920Y 1			1989-1991, .010" Thickness, 8 Bolt,		
Transmission Pan Gasket			Chelsea Power Take Off H26207 1		
1991, Turbo Hydra-Matic 4L80E MT1			1989-1991, .020" Thickness, 6 Bolt,		
Transmission. W39379 1			Chelsea Power Take Off H26206 1		
1987-1991, Turbo Hydra-Matic 700-R4 MD8			1989-1991, .020" Thickness, 8 Bolt,		
Transmission. W39365 1			Chelsea Power Take Off H26208 1		
1987-1991, Turbo Hydra-Matic 700-R4 MD8			Transmission Pan Gasket		
Transmission, Tuff-Cork. W39365TC 1			1991, Turbo Hydra-Matic 4L80E MT1		
1987-1990, Turbo Hydra-Matic 400 M40			Transmission. W39379 1		
Transmission, Turbo Hydra-Matic 475			1989-1991, Turbo Hydra-Matic 700-R4 MD8		
Transmission. W39341 1			Transmission. W39365 1		
1987-1990, Turbo Hydra-Matic 400 M40			1989-1991, Turbo Hydra-Matic 700-R4 MD8		
Transmission, Turbo Hydra-Matic 475			Transmission, Tuff-Cork. W39365TC 1		
Transmission, Tuff-Cork. W39341TC 1			1989-1990, Turbo Hydra-Matic 400 M40		
R2500(GMC)			Transmission, Turbo Hydra-Matic 475		
Transmission Gasket Set			Transmission. W39341 1		
1987, Muncie 4 Speed Transmission TS27920Y 1			1989-1990, Turbo Hydra-Matic 400 M40		
Transmission Pan Gasket			Transmission, Turbo Hydra-Matic 475		
1987-1989, Turbo Hydra-Matic 400 M40			Transmission, Tuff-Cork. W39341TC 1		
Transmission, Turbo Hydra-Matic 475			R3500(GMC)		
Transmission. W39341 1			P.T.O. Cover Gasket		
1987-1989, Turbo Hydra-Matic 400 M40			1987-1991, 6 Bolt, Chelsea Power Take Off . . . H36080 1		
Transmission, Turbo Hydra-Matic 475			1987-1991, 8 Bolt, Chelsea Power Take Off . . . H36124 1		
Transmission, Tuff-Cork. W39341TC 1			P.T.O. Mounting Gasket		
1987-1989, Turbo Hydra-Matic 700-R4 MD8			1987-1991, .010" Thickness, 6 Bolt,		
Transmission. W39365 1			Chelsea Power Take Off H26205 1		
1987-1989, Turbo Hydra-Matic 700-R4 MD8			1987-1991, .010" Thickness, 8 Bolt,		
Transmission, Tuff-Cork. W39365TC 1			Chelsea Power Take Off H26207 1		
R30			1987-1991, .020" Thickness, 6 Bolt,		
P.T.O. Cover Gasket			Chelsea Power Take Off H26206 1		
1987-1988, 6 Bolt, Chelsea Power Take Off . . . H36080 1			1987-1991, .020" Thickness, 8 Bolt,		
1987-1988, 8 Bolt, Chelsea Power Take Off . . . H36124 1			Chelsea Power Take Off H26208 1		
P.T.O. Mounting Gasket			Transmission Gasket Set		
1987-1988, .010" Thickness, 6 Bolt,			1987, Muncie 4 Speed Transmission TS27920Y 1		
Chelsea Power Take Off H26205 1			Transmission Pan Gasket		
1987-1988, .010" Thickness, 8 Bolt,			1991, Turbo Hydra-Matic 4L80E MT1		
Chelsea Power Take Off H26207 1			Transmission. W39379 1		
1987-1988, .020" Thickness, 6 Bolt,			1987-1991, Turbo Hydra-Matic 700-R4 MD8		
Chelsea Power Take Off H26206 1			Transmission. W39365 1		
1987-1988, .020" Thickness, 8 Bolt,			1987-1991, Turbo Hydra-Matic 700-R4 MD8		
Chelsea Power Take Off H26208 1			Transmission, Tuff-Cork. W39365TC 1		
Transmission Gasket Set			1987-1990, Turbo Hydra-Matic 400 M40		
1987, Muncie 4 Speed Transmission TS27920Y 1			Transmission, Turbo Hydra-Matic 475		
Transmission Pan Gasket			Transmission. W39341 1		
1987-1988, Turbo Hydra-Matic 400 M40			1987-1990, Turbo Hydra-Matic 400 M40		
Transmission, Turbo Hydra-Matic 475			Transmission, Turbo Hydra-Matic 475		
Transmission. W39341 1			Transmission, Tuff-Cork. W39341TC 1		
1987-1988, Turbo Hydra-Matic 700-R4 MD8			S10		
Transmission. W39365 1			Transmission Gasket Set		
1987-1988, Turbo Hydra-Matic 700-R4 MD8			1985-1987, Muncie 4 Speed Transmission . . TS27920Y 1		
Transmission, Tuff-Cork. W39365TC 1			Transmission Pan Gasket		
R3500(GMC)			1994-2003, Turbo Hydra-Matic 4L60E M30		
P.T.O. Cover Gasket			Transmission. W39365 1		
1987-1991, 6 Bolt, Chelsea Power Take Off . . . H36080 1			1994-2003, Turbo Hydra-Matic 4L60E M30		
1987-1991, 8 Bolt, Chelsea Power Take Off . . . H36124 1			Transmission, Tuff-Cork. W39365TC 1		
P.T.O. Mounting Gasket			1992-1995, Turbo Hydra-Matic 4L60E M30		
1987-1991, .010" Thickness, 6 Bolt,			Transmission, Turbo Hydra-Matic 700-R4		
Chelsea Power Take Off H26205 1			MD8 Transmission. W39365 1		
1987-1991, .010" Thickness, 8 Bolt,					
Chelsea Power Take Off H26207 1					
1987-1991, .020" Thickness, 6 Bolt,					
Chelsea Power Take Off H26206 1					
1987-1991, .020" Thickness, 8 Bolt,					
Chelsea Power Take Off H26208 1					

LIGHT TRUCK

General Motors Truck (cont.)

Transmission Gaskets (cont.)

<i>Model & Application</i>	<i>Part No.</i>	<i>Qty.</i>	<i>Model & Application</i>	<i>Part No.</i>	<i>Qty.</i>
S10 (cont.)			SAFARI (cont.)		
Transmission Pan Gasket (cont.)			Transmission Pan Gasket (cont.)		
1992-1995, Turbo Hydra-Matic 4L60E M30 Transmission, Turbo Hydra-Matic 700-R4 MD8 Transmission, Tuff-Cork.	W39365TC	1	1985-1990, Turbo Hydra-Matic 400 M40 Transmission, Turbo Hydra-Matic 475 Transmission.	W39341	1
1991-1995, Turbo Hydra-Matic 4L80E MT1 Transmission.	W39379	1	1985-1990, Turbo Hydra-Matic 400 M40 Transmission, Turbo Hydra-Matic 475 Transmission, Tuff-Cork.	W39341TC	1
1985-1990, Turbo Hydra-Matic 400 M40 Transmission, Turbo Hydra-Matic 475 Transmission.	W39341	1	SAFARI EXT		
1985-1990, Turbo Hydra-Matic 400 M40 Transmission, Turbo Hydra-Matic 475 Transmission, Tuff-Cork.	W39341TC	1	Transmission Pan Gasket		
1982-1992, Turbo Hydra-Matic 700-R4 MD8 Transmission.	W39365	1	1992-1993, Turbo Hydra-Matic 4L60E M30 Transmission, Turbo Hydra-Matic 700-R4 MD8 Transmission.	W39365	1
1982-1992, Turbo Hydra-Matic 700-R4 MD8 Transmission, Tuff-Cork.	W39365TC	1	1992-1993, Turbo Hydra-Matic 4L60E M30 Transmission, Turbo Hydra-Matic 700-R4 MD8 Transmission, Tuff-Cork.	W39365TC	1
1982-1984, Turbo Hydra-Matic 200 M29, MV9 Transmission.	W39045	1	1991-1994, Turbo Hydra-Matic 4L80E MT1 Transmission.	W39379	1
1982-1984, Turbo Hydra-Matic 200 M29, MV9 Transmission, Tuff-Cork.	W39045TC	1	1990-1992, Turbo Hydra-Matic 700-R4 MD8 Transmission.	W39365	1
S15			1990-1992, Turbo Hydra-Matic 700-R4 MD8 Transmission, Tuff-Cork.	W39365TC	1
Transmission Pan Gasket			1990-1992, Turbo Hydra-Matic 700-R4 MD8 Transmission, Tuff-Cork.	W39365TC	1
1992-1995, Turbo Hydra-Matic 4L60E M30 Transmission, Turbo Hydra-Matic 700-R4 MD8 Transmission.	W39365	1	1990, Turbo Hydra-Matic 400 M40 Transmission, Turbo Hydra-Matic 475 Transmission.	W39341	1
1992-1995, Turbo Hydra-Matic 4L60E M30 Transmission, Turbo Hydra-Matic 700-R4 MD8 Transmission, Tuff-Cork.	W39365TC	1	1990, Turbo Hydra-Matic 400 M40 Transmission, Turbo Hydra-Matic 475 Transmission, Tuff-Cork.	W39341TC	1
1991-1995, Turbo Hydra-Matic 4L80E MT1 Transmission.	W39379	1	SAVANA 1500		
1988-1990, Turbo Hydra-Matic 400 M40 Transmission, Turbo Hydra-Matic 475 Transmission.	W39341	1	Transmission Pan Gasket		
1988-1990, Turbo Hydra-Matic 400 M40 Transmission, Turbo Hydra-Matic 475 Transmission, Tuff-Cork.	W39341TC	1	1996-2003, Turbo Hydra-Matic 4L60E M30 Transmission.	W39365	1
1982-1992, Turbo Hydra-Matic 700-R4 MD8 Transmission.	W39365	1	1996-2003, Turbo Hydra-Matic 4L60E M30 Transmission, Tuff-Cork.	W39365TC	1
1982-1992, Turbo Hydra-Matic 700-R4 MD8 Transmission, Tuff-Cork.	W39365TC	1	SAVANA 2500		
1982-1984, Turbo Hydra-Matic 200 M29, MV9 Transmission.	W39045	1	Transmission Pan Gasket		
1982-1984, Turbo Hydra-Matic 200 M29, MV9 Transmission, Tuff-Cork.	W39045TC	1	1996-2003, Turbo Hydra-Matic 4L60E M30 Transmission.	W39365	1
SAFARI			1996-2003, Turbo Hydra-Matic 4L60E M30 Transmission, Tuff-Cork.	W39365TC	1
Transmission Gasket Set			1996-2003, Turbo Hydra-Matic 4L80E MT1 Transmission.	W39379	1
1985-1987, Muncie 4 Speed Transmission . . .	TS27920Y	1	SAVANA 2500 EXT		
Transmission Pan Gasket			Transmission Pan Gasket		
1996-2003, Turbo Hydra-Matic 4L60E M30 Transmission.	W39365	1	1996-2003, Turbo Hydra-Matic 4L60E M30 Transmission.	W39365	1
1996-2003, Turbo Hydra-Matic 4L60E M30 Transmission, Tuff-Cork.	W39365TC	1	1996-2003, Turbo Hydra-Matic 4L60E M30 Transmission, Tuff-Cork.	W39365TC	1
1992-1995, Turbo Hydra-Matic 4L60E M30 Transmission, Turbo Hydra-Matic 700-R4 MD8 Transmission.	W39365	1	1996-2003, Turbo Hydra-Matic 4L80E MT1 Transmission.	W39379	1
1992-1995, Turbo Hydra-Matic 4L60E M30 Transmission, Turbo Hydra-Matic 700-R4 MD8 Transmission, Tuff-Cork.	W39365TC	1	SAVANA 3500		
1991-1994, Turbo Hydra-Matic 4L80E MT1 Transmission.	W39379	1	Transmission Pan Gasket		
1985-1992, Turbo Hydra-Matic 700-R4 MD8 Transmission.	W39365	1	1996-2003, Turbo Hydra-Matic 4L80E MT1 Transmission.	W39379	1
1985-1992, Turbo Hydra-Matic 700-R4 MD8 Transmission, Tuff-Cork.	W39365TC	1	SAVANA 3500 EXT		
SAFARI 1500			Transmission Pan Gasket		
Transmission Pan Gasket			1996-2003, Turbo Hydra-Matic 4L60E M30 Transmission.	W39365	1
1999-2003, Turbo Hydra-Matic 4L60E M30 Transmission.	W39365	1	SAVANA 3500 EXT		

LIGHT TRUCK

Transmission Gaskets (cont.)				
Model & Application	Part No.	Qty.	Model & Application	Part No. Qty.
SIERRA 1500 (cont.)			SONOMA	
Transmission Pan Gasket (cont.)			Transmission Pan Gasket	
1999-2003, Turbo Hydra-Matic 4L60E M30 Transmission, Tuff-Cork.	W39365TC	1	1994-2003, Turbo Hydra-Matic 4L60E M30 Transmission.	W39365 1
SIERRA 1500HD			1994-2003, Turbo Hydra-Matic 4L60E M30 Transmission, Tuff-Cork.	W39365TC 1
Transmission Pan Gasket			1992-1995, Turbo Hydra-Matic 4L60E M30 Transmission, Turbo Hydra-Matic 700-R4 MD8 Transmission.	W39365 1
2002-2003, Turbo Hydra-Matic 4L80E MT1 Transmission.	W39379	1	1992-1995, Turbo Hydra-Matic 4L60E M30 Transmission, Turbo Hydra-Matic 700-R4 MD8 Transmission, Tuff-Cork.	W39365TC 1
SIERRA 2500			1991-1995, Turbo Hydra-Matic 4L80E MT1 Transmission.	W39379 1
Transmission Pan Gasket			1991-1992, Turbo Hydra-Matic 700-R4 MD8 Transmission.	W39365 1
1999-2003, Turbo Hydra-Matic 4L80E MT1 Transmission.	W39379	1	1991-1992, Turbo Hydra-Matic 700-R4 MD8 Transmission, Tuff-Cork.	W39365TC 1
1999-2000, Turbo Hydra-Matic 4L60E M30 Transmission.	W39365	1	SPRINT	
1999-2000, Turbo Hydra-Matic 4L60E M30 Transmission, Tuff-Cork.	W39365TC	1	Transmission Gasket Set	
SIERRA 2500HD			1971-1977, Muncie 3 Speed Transmission	
Transmission Pan Gasket			1971-1977, Saginaw 3 Speed Transmission	
2001-2003, Turbo Hydra-Matic 4L80E MT1 Transmission.	W39379	1	Transmission Pan Gasket	
SIERRA 3500			1971-1977, Turbo Hydra-Matic 400 M40 Transmission, Turbo Hydra-Matic 475 Transmission.	
Transmission Pan Gasket			1971-1977, Turbo Hydra-Matic 400 M40 Transmission, Turbo Hydra-Matic 475 Transmission, Tuff-Cork.	
2001-2003, Turbo Hydra-Matic 4L80E MT1 Transmission.	W39379	1	1971, Powerglide Transmission	
SIERRA DENALI			1971, Turbo Hydra-Matic 350 M38, MV4 Transmission.	
Transmission Pan Gasket			1971, Turbo Hydra-Matic 350 M38, MV4 Transmission, Tuff-Cork.	
2002-2003, Turbo Hydra-Matic 4L80E MT1 Transmission.	W39379	1	SUBURBAN 1500	
SILVERADO 1500			Transmission Pan Gasket	
Transmission Pan Gasket			2000-2003, Turbo Hydra-Matic 4L60E M30 Transmission.	
2003, Turbo Hydra-Matic 4L80E MT1 Transmission.	W39379	1	2000-2003, Turbo Hydra-Matic 4L60E M30 Transmission, Tuff-Cork.	
1999-2003, Turbo Hydra-Matic 4L60E M30 Transmission.	W39365	1	SUBURBAN 2500	
1999-2003, Turbo Hydra-Matic 4L60E M30 Transmission, Tuff-Cork.	W39365TC	1	Transmission Pan Gasket	
SILVERADO 1500HD			2000-2003, Turbo Hydra-Matic 4L80E MT1 Transmission.	
Transmission Pan Gasket			1995-1997	
2002-2003, Turbo Hydra-Matic 4L80E MT1 Transmission.	W39379	1	SUNRUNNER	
SILVERADO 2500			Transmission Pan Gasket	
Transmission Pan Gasket			1995-1997	
1999-2003, Turbo Hydra-Matic 4L80E MT1 Transmission.	W39379	1	SYCLONE	
1999-2001, Turbo Hydra-Matic 4L60E M30 Transmission.	W39365	1	Transmission Pan Gasket	
1999-2001, Turbo Hydra-Matic 4L60E M30 Transmission, Tuff-Cork.	W39365TC	1	1993, Turbo Hydra-Matic 4L60E M30 Transmission.	
SILVERADO 2500HD			1993, Turbo Hydra-Matic 4L60E M30 Transmission, Tuff-Cork.	
Transmission Pan Gasket			1991-1993, Turbo Hydra-Matic 4L80E MT1 Transmission.	
2001-2003, Turbo Hydra-Matic 4L80E MT1 Transmission.	W39379	1	TAHOE	
SILVERADO 3500			Transmission Pan Gasket	
Transmission Pan Gasket			1995-2003, Turbo Hydra-Matic 4L60E M30 Transmission.	
2001-2003, Turbo Hydra-Matic 4L80E MT1 Transmission.	W39379	1	1995-2003, Turbo Hydra-Matic 4L60E M30 Transmission, Tuff-Cork.	

LIGHT TRUCK

General Motors Truck (cont.)

Transmission Gaskets (cont.)

<i>Model & Application</i>	<i>Part No.</i>	<i>Qty.</i>	<i>Model & Application</i>	<i>Part No.</i>	<i>Qty.</i>
TAHOE (cont.)			V1500 SUBURBAN (cont.)		
Transmission Pan Gasket (cont.)			Transmission Pan Gasket (cont.)		
1995-1999, Turbo Hydra-Matic 4L80E MT1 Transmission	W39379	1	1989-1990, Turbo Hydra-Matic 400 M40 Transmission, Turbo Hydra-Matic 475 Transmission, Tuff-Cork	W39341TC	1
TRACKER			V1500 SUBURBAN(GMC)		
Transmission Pan Gasket			Transmission Gasket Set		
1994-1997	W39357	1	1987, Muncie 4 Speed Transmission	TS27920Y	1
1989-1995, Automatic Transmission	W39357	1	Transmission Pan Gasket		
TRAIL BLAZER EXT			1991, Turbo Hydra-Matic 4L80E MT1 Transmission		
Transmission Pan Gasket			1987-1991, Turbo Hydra-Matic 700-R4 MD8 Transmission		
2003, Turbo Hydra-Matic 4L60E M30 Transmission	W39365	1	1987-1991, Turbo Hydra-Matic 700-R4 MD8 Transmission, Tuff-Cork		
2003, Turbo Hydra-Matic 4L60E M30 Transmission, Tuff-Cork	W39365TC	1	1987-1990, Turbo Hydra-Matic 400 M40 Transmission, Turbo Hydra-Matic 475 Transmission		
TYPHOON			1987-1990, Turbo Hydra-Matic 400 M40 Transmission, Turbo Hydra-Matic 475 Transmission, Tuff-Cork		
Transmission Pan Gasket			1992-1993, Turbo Hydra-Matic 4L80E MT1 Transmission		
1993, Turbo Hydra-Matic 4L60E M30 Transmission	W39365	1	V1500(GMC)		
1993, Turbo Hydra-Matic 4L60E M30 Transmission, Tuff-Cork	W39365TC	1	Transmission Gasket Set		
1992-1993, Turbo Hydra-Matic 4L80E MT1 Transmission	W39379	1	1987, Muncie 4 Speed Transmission		
V10			1987, Muncie 4 Speed Transmission		
Transmission Gasket Set			Transmission Pan Gasket		
1987, Muncie 4 Speed Transmission	TS27920Y	1	1987, Turbo Hydra-Matic 400 M40 Transmission, Turbo Hydra-Matic 475 Transmission		
Transmission Pan Gasket			1987, Turbo Hydra-Matic 400 M40 Transmission, Turbo Hydra-Matic 475 Transmission, Tuff-Cork		
1987, Turbo Hydra-Matic 400 M40 Transmission, Turbo Hydra-Matic 475 Transmission	W39341	1	1987, Turbo Hydra-Matic 700-R4 MD8 Transmission		
1987, Turbo Hydra-Matic 400 M40 Transmission, Turbo Hydra-Matic 475 Transmission, Tuff-Cork	W39341TC	1	1987, Turbo Hydra-Matic 700-R4 MD8 Transmission, Tuff-Cork		
1987, Turbo Hydra-Matic 700-R4 MD8 Transmission	W39365	1	V20		
1987, Turbo Hydra-Matic 700-R4 MD8 Transmission, Tuff-Cork	W39365TC	1	Transmission Gasket Set		
V10 SUBURBAN			1987, Muncie 4 Speed Transmission		
Transmission Gasket Set			Transmission Pan Gasket		
1987, Muncie 4 Speed Transmission	TS27920Y	1	1987, Turbo Hydra-Matic 400 M40 Transmission, Turbo Hydra-Matic 475 Transmission		
Transmission Pan Gasket			1987, Turbo Hydra-Matic 400 M40 Transmission, Turbo Hydra-Matic 475 Transmission, Tuff-Cork		
1987-1988, Turbo Hydra-Matic 400 M40 Transmission, Turbo Hydra-Matic 475 Transmission	W39341	1	1987, Turbo Hydra-Matic 700-R4 MD8 Transmission		
1987-1988, Turbo Hydra-Matic 400 M40 Transmission, Turbo Hydra-Matic 475 Transmission, Tuff-Cork	W39341TC	1	1987, Turbo Hydra-Matic 700-R4 MD8 Transmission, Tuff-Cork		
1987-1988, Turbo Hydra-Matic 700-R4 MD8 Transmission	W39365	1	V20 SUBURBAN		
1987-1988, Turbo Hydra-Matic 700-R4 MD8 Transmission, Tuff-Cork	W39365TC	1	Transmission Gasket Set		
V1500 SUBURBAN			1987, Muncie 4 Speed Transmission		
Transmission Pan Gasket			Transmission Pan Gasket		
1991, Turbo Hydra-Matic 4L80E MT1 Transmission	W39379	1	1987-1988, Turbo Hydra-Matic 400 M40 Transmission, Turbo Hydra-Matic 475 Transmission		
1989-1991, Turbo Hydra-Matic 700-R4 MD8 Transmission	W39365	1	1987-1988, Turbo Hydra-Matic 400 M40 Transmission, Turbo Hydra-Matic 475 Transmission, Tuff-Cork		
1989-1991, Turbo Hydra-Matic 700-R4 MD8 Transmission, Tuff-Cork	W39365TC	1	1987-1988, Turbo Hydra-Matic 700-R4 MD8 Transmission		
1989-1990, Turbo Hydra-Matic 400 M40 Transmission, Turbo Hydra-Matic 475 Transmission	W39341	1	1987-1988, Turbo Hydra-Matic 700-R4 MD8 Transmission, Tuff-Cork		

LIGHT TRUCK

General Motors Truck (cont.)

Transmission Gaskets (cont.)					
Model & Application	Part No.	Qty.	Model & Application	Part No.	Qty.
V2500 SUBURBAN			V30 (cont.)		
Transmission Pan Gasket			Transmission Pan Gasket (cont.)		
1991, Turbo Hydra-Matic 4L80E MT1 Transmission	W39379	1	1987-1988, Turbo Hydra-Matic 400 M40 Transmission, Turbo Hydra-Matic 475 Transmission, Tuff-Cork	W39341TC	1
1989-1991, Turbo Hydra-Matic 700-R4 MD8 Transmission	W39365	1	1987-1988, Turbo Hydra-Matic 700-R4 MD8 Transmission	W39365	1
1989-1991, Turbo Hydra-Matic 700-R4 MD8 Transmission, Tuff-Cork	W39365TC	1	1987-1988, Turbo Hydra-Matic 700-R4 MD8 Transmission, Tuff-Cork	W39365TC	1
1989-1990, Turbo Hydra-Matic 400 M40 Transmission, Turbo Hydra-Matic 475 Transmission	W39341	1	V3500		
1989-1990, Turbo Hydra-Matic 400 M40 Transmission, Turbo Hydra-Matic 475 Transmission, Tuff-Cork	W39341TC	1	P.T.O. Cover Gasket		
V2500 SUBURBAN(GMC)			1989-1991, 6 Bolt, Chelsea Power Take Off		
Transmission Gasket Set			1989-1991, 8 Bolt, Chelsea Power Take Off		
1987, Muncie 4 Speed Transmission	TS27920Y	1	P.T.O. Mounting Gasket		
Transmission Pan Gasket			1989-1991, .010" Thickness, 6 Bolt, Chelsea Power Take Off		
1991, Turbo Hydra-Matic 4L80E MT1 Transmission	W39379	1	1989-1991, .010" Thickness, 8 Bolt, Chelsea Power Take Off		
1987-1991, Turbo Hydra-Matic 700-R4 MD8 Transmission	W39365	1	1989-1991, .020" Thickness, 6 Bolt, Chelsea Power Take Off		
1987-1991, Turbo Hydra-Matic 700-R4 MD8 Transmission, Tuff-Cork	W39365TC	1	1989-1991, .020" Thickness, 8 Bolt, Chelsea Power Take Off		
1987-1990, Turbo Hydra-Matic 400 M40 Transmission, Turbo Hydra-Matic 475 Transmission	W39341	1	Transmission Pan Gasket		
1987-1990, Turbo Hydra-Matic 400 M40 Transmission, Turbo Hydra-Matic 475 Transmission, Tuff-Cork	W39341TC	1	1991, Turbo Hydra-Matic 4L80E MT1 Transmission		
V2500(GMC)			1989-1991, Turbo Hydra-Matic 700-R4 MD8 Transmission		
Transmission Gasket Set			1989-1991, Turbo Hydra-Matic 700-R4 MD8 Transmission, Tuff-Cork		
1987, Muncie 4 Speed Transmission	TS27920Y	1	1989-1990, Turbo Hydra-Matic 400 M40 Transmission, Turbo Hydra-Matic 475 Transmission		
Transmission Pan Gasket			1989-1990, Turbo Hydra-Matic 400 M40 Transmission, Turbo Hydra-Matic 475 Transmission, Tuff-Cork		
1987, Turbo Hydra-Matic 400 M40 Transmission, Turbo Hydra-Matic 475 Transmission	W39341	1	V3500(GMC)		
1987, Turbo Hydra-Matic 400 M40 Transmission, Turbo Hydra-Matic 475 Transmission, Tuff-Cork	W39341TC	1	P.T.O. Cover Gasket		
1987, Turbo Hydra-Matic 700-R4 MD8 Transmission	W39365	1	1987-1991, 6 Bolt, Chelsea Power Take Off		
1987, Turbo Hydra-Matic 700-R4 MD8 Transmission, Tuff-Cork	W39365TC	1	1987-1991, 8 Bolt, Chelsea Power Take Off		
V30			P.T.O. Mounting Gasket		
P.T.O. Cover Gasket			1987-1991, .010" Thickness, 6 Bolt, Chelsea Power Take Off		
1987-1988, 6 Bolt, Chelsea Power Take Off	H36080	1	1987-1991, .010" Thickness, 8 Bolt, Chelsea Power Take Off		
1987-1988, 8 Bolt, Chelsea Power Take Off	H36124	1	1987-1991, .020" Thickness, 6 Bolt, Chelsea Power Take Off		
P.T.O. Mounting Gasket			1987-1991, .020" Thickness, 8 Bolt, Chelsea Power Take Off		
1987-1988, .010" Thickness, 6 Bolt, Chelsea Power Take Off	H26205	1	Transmission Gasket Set		
1987-1988, .010" Thickness, 8 Bolt, Chelsea Power Take Off	H26207	1	1987, Muncie 4 Speed Transmission		
1987-1988, .020" Thickness, 6 Bolt, Chelsea Power Take Off	H26206	1	Transmission Pan Gasket		
1987-1988, .020" Thickness, 8 Bolt, Chelsea Power Take Off	H26208	1	1991, Turbo Hydra-Matic 4L80E MT1 Transmission		
Transmission Gasket Set			1987-1991, Turbo Hydra-Matic 700-R4 MD8 Transmission		
1987, Muncie 4 Speed Transmission	TS27920Y	1	1987-1991, Turbo Hydra-Matic 700-R4 MD8 Transmission, Tuff-Cork		
Transmission Pan Gasket			1987-1990, Turbo Hydra-Matic 400 M40 Transmission, Turbo Hydra-Matic 475 Transmission		
1987-1988, Turbo Hydra-Matic 400 M40 Transmission, Turbo Hydra-Matic 475 Transmission	W39341	1	1987-1990, Turbo Hydra-Matic 400 M40 Transmission, Turbo Hydra-Matic 475 Transmission, Tuff-Cork		
1987-1988, Turbo Hydra-Matic 400 M40 Transmission, Turbo Hydra-Matic 475 Transmission, Tuff-Cork	W39341TC	1	V30 (cont.)		

LIGHT TRUCK

General Motors Truck (cont.)

Transmission Gaskets (cont.)						
Model & Application		Part No.	Qty.	Model & Application		
YUKON			YUKON XL 1500			
Transmission Pan Gasket			Transmission Pan Gasket			
1993-2003, Turbo Hydra-Matic 4L60E M30 Transmission.		W39365	1	2001-2003, Turbo Hydra-Matic 4L80E MT1 Transmission.		
1993-2003, Turbo Hydra-Matic 4L60E M30 Transmission, Tuff-Cork.		W39365TC	1	2000-2003, Turbo Hydra-Matic 4L60E M30 Transmission.		
1992-2003, Turbo Hydra-Matic 4L80E MT1 Transmission.		W39379	1	2000-2003, Turbo Hydra-Matic 4L60E M30 Transmission, Tuff-Cork.		
1992, Turbo Hydra-Matic 700-R4 MD8 Transmission.		W39365	1	YUKON XL 2500		
1992, Turbo Hydra-Matic 700-R4 MD8 Transmission, Tuff-Cork.		W39365TC	1	Transmission Pan Gasket		
YUKON 1500			2000-2003, Turbo Hydra-Matic 4L80E MT1 Transmission.			
Transmission Pan Gasket			Transmission.			
2003, Turbo Hydra-Matic 4L60E M30 Transmission.		W39365	1	2000-2003, Turbo Hydra-Matic 4L80E MT1 Transmission.		
2003, Turbo Hydra-Matic 4L60E M30 Transmission, Tuff-Cork.		W39365TC	1	Transmission.		

Hummer

Transmission Gaskets					
Model & Application		Part No.	Qty.	Model & Application	
H1			HMCO		
Transmission Pan Gasket			Transmission Pan Gasket		
2002, Turbo Hydra-Matic 4L80E MT1 Transmission.		W39379	1	1997-2001, Turbo Hydra-Matic 4L80E MT1 Transmission.	
H2			HMCS		
Transmission Pan Gasket			Transmission Pan Gasket		
2003, Turbo Hydra-Matic 4L80E MT1 Transmission.		W39379	1	1997-2001, Turbo Hydra-Matic 4L80E MT1 Transmission.	
HMC4			XLC2		
Transmission Pan Gasket			Transmission Pan Gasket		
1997-2001, Turbo Hydra-Matic 4L80E MT1 Transmission.		W39379	1	1997-2001, Turbo Hydra-Matic 4L80E MT1 Transmission.	

Isuzu Truck

Differential Housing Cover Gaskets						
Model & Application		Part No.	Qty.	Model & Application		
HOMBRE			HOMBRE (cont.)			
Axle Hsg Cover Gasket			Axle Hsg Cover Gasket (cont.)			
1996-2000, 7-5/8" Ring Gear, Rear Axle		P27872	1	1996-2000, 8-1/2" Ring Gear, 10 Bolt Holes, Rear Axle, Tuff-Cork.		
1996-2000, 8-1/2" Ring Gear, 10 Bolt Holes, Rear Axle.		P27857	1 P27857TC 1		
Transmission Gaskets						
Model & Application		Part No.	Qty.	Model & Application		
HOMBRE			HOMBRE (cont.)			
Transmission Pan Gasket			Transmission Pan Gasket (cont.)			
1996-2000, Turbo Hydra-Matic 4L60E M30 Transmission.		W39365	1	1996-2000, Turbo Hydra-Matic 4L60E M30 Transmission, Tuff-Cork.		
			 W39365TC 1		

LIGHT TRUCK

Differential Housing Cover Gaskets

Model & Application	Part No.	Qty.	Model & Application	Part No.	Qty.
4 X 2			475		
Axle Hsg Cover Gasket			Axle Hsg Cover Gasket		
1948-1950, Dana 20 Axle, No Bolt Holes, Rear Axle, 10" X 10-3/4"	P37830	1	1955-1956, Dana 20 Axle, No Bolt Holes, Rear Axle, 10" X 10-3/4"	P37830	1
1948-1950, Dana 20 Axle, Dana 44 Axle, 10 Bolt Holes, Front Axle, Rear Axle	P27768T	1	1955-1956, Dana 20 Axle, Dana 44 Axle, 10 Bolt Holes, Front Axle, Rear Axle	P27768T	1
1948-1950, Dana 27 Axle, Front Axle, Rear Axle	P27666	1	1955-1956, Dana 27 Axle, Front Axle, Rear Axle	P27666	1
1948-1950, Dana 30 Axle, Front Axle	P27603	1	1955-1956, Dana 30 Axle, Front Axle	P27603	1
1948-1950, Dana 35 Axle, Rear Axle	P27801	1	1955-1956, Dana 35 Axle, Rear Axle	P27801	1
1948-1950, Dana 44 Axle, 10 Bolt Holes, Front Axle, Rear Axle, Tuff-Cork	P27768TC	1	1955-1956, Dana 44 Axle, 10 Bolt Holes, Front Axle, Rear Axle, Tuff-Cork	P27768TC	1
1948-1950, Dana 53 Axle, Front Axle, Rear Axle	P27934	1	1955-1956, Dana 53 Axle, Front Axle, Rear Axle	P27934	1
1948-1950, Dana 60, 70 Axle, Rear Axle	P18562	1	1955-1956, Dana 60, 70 Axle, Rear Axle	P18562	1
1948-1950, Dana 60, 70 Axle, Rear Axle, Tuff-Cork	P18562TC	1	1955-1956, Dana 60, 70 Axle, Rear Axle, Tuff-Cork	P18562TC	1
4 X 4			6-230		
Axle Hsg Cover Gasket			Axle Hsg Cover Gasket		
1947-1950, Dana 20 Axle, No Bolt Holes, Rear Axle, 10" X 10-3/4"	P37830	1	1962-1965, Dana 20 Axle, No Bolt Holes, Rear Axle, 10" X 10-3/4"	P37830	1
1947-1950, Dana 20 Axle, Dana 44 Axle, 10 Bolt Holes, Front Axle, Rear Axle	P27768T	1	1962-1965, Dana 20 Axle, Dana 44 Axle, 10 Bolt Holes, Front Axle, Rear Axle	P27768T	1
1947-1950, Dana 27 Axle, Front Axle, Rear Axle	P27666	1	1962-1965, Dana 27 Axle, Front Axle, Rear Axle	P27666	1
1947-1950, Dana 30 Axle, Front Axle	P27603	1	1962-1965, Dana 30 Axle, Front Axle	P27603	1
1947-1950, Dana 35 Axle, Rear Axle	P27801	1	1962-1965, Dana 35 Axle, Rear Axle	P27801	1
1947-1950, Dana 44 Axle, 10 Bolt Holes, Front Axle, Rear Axle, Tuff-Cork	P27768TC	1	1962-1965, Dana 44 Axle, 10 Bolt Holes, Front Axle, Rear Axle, Tuff-Cork	P27768TC	1
1947-1950, Dana 53 Axle, Front Axle, Rear Axle	P27934	1	1962-1965, Dana 53 Axle, Front Axle, Rear Axle	P27934	1
1947-1950, Dana 60, 70 Axle, Rear Axle	P18562	1	1962-1965, Dana 60, 70 Axle, Rear Axle	P18562	1
1947-1950, Dana 60, 70 Axle, Rear Axle, Tuff-Cork	P18562TC	1	1962-1965, Dana 60, 70 Axle, Rear Axle, Tuff-Cork	P18562TC	1
454			654		
Axle Hsg Cover Gasket			Axle Hsg Cover Gasket		
1954, Dana 20 Axle, No Bolt Holes, Rear Axle, 10" X 10-3/4"	P37830	1	1954, Dana 20 Axle, No Bolt Holes, Rear Axle, 10" X 10-3/4"	P37830	1
1954, Dana 20 Axle, Dana 44 Axle, 10 Bolt Holes, Front Axle, Rear Axle	P27768T	1	1954, Dana 20 Axle, Dana 44 Axle, 10 Bolt Holes, Front Axle, Rear Axle	P27768T	1
1954, Dana 27 Axle, Front Axle, Rear Axle	P27666	1	1954, Dana 27 Axle, Front Axle, Rear Axle	P27666	1
1954, Dana 30 Axle, Front Axle	P27603	1	1954, Dana 30 Axle, Front Axle	P27603	1
1954, Dana 35 Axle, Rear Axle	P27801	1	1954, Dana 35 Axle, Rear Axle	P27801	1
1954, Dana 44 Axle, 10 Bolt Holes, Front Axle, Rear Axle, Tuff-Cork	P27768TC	1	1954, Dana 44 Axle, 10 Bolt Holes, Front Axle, Rear Axle, Tuff-Cork	P27768TC	1
1954, Dana 53 Axle, Front Axle, Rear Axle	P27934	1	1954, Dana 53 Axle, Front Axle, Rear Axle	P27934	1
1954, Dana 60, 70 Axle, Rear Axle	P18562	1	1954, Dana 60, 70 Axle, Rear Axle	P18562	1
1954, Dana 60, 70 Axle, Rear Axle, Tuff-Cork	P18562TC	1	1954, Dana 60, 70 Axle, Rear Axle, Tuff-Cork	P18562TC	1
473			CJ2A		
Axle Hsg Cover Gasket			Axle Hsg Cover Gasket		
1951-1952, Dana 20 Axle, No Bolt Holes, Rear Axle, 10" X 10-3/4"	P37830	1	1946-1949, Dana 20 Axle, No Bolt Holes, Rear Axle, 10" X 10-3/4"	P37830	1
1951-1952, Dana 20 Axle, Dana 44 Axle, 10 Bolt Holes, Front Axle, Rear Axle	P27768T	1			
1951-1952, Dana 27 Axle, Front Axle, Rear Axle	P27666	1			
1951-1952, Dana 30 Axle, Front Axle	P27603	1			
1951-1952, Dana 35 Axle, Rear Axle	P27801	1			
1951-1952, Dana 44 Axle, 10 Bolt Holes, Front Axle, Rear Axle, Tuff-Cork	P27768TC	1			
1951-1952, Dana 53 Axle, Front Axle, Rear Axle	P27934	1			
1951-1952, Dana 60, 70 Axle, Rear Axle	P18562	1			
1951-1952, Dana 60, 70 Axle, Rear Axle, Tuff-Cork	P18562TC	1			

Jeep (cont.)

Differential Housing Cover Gaskets (cont.)

Model & Application	Part No.	Qty.	Model & Application	Part No.	Qty.
CJ2A (cont.)			CJ5 (cont.)		
Axle Hsg Cover Gasket (cont.)			Axle Hsg Cover Gasket (cont.)		
1946-1949, Dana 20 Axle, Dana 44 Axle, 10 Bolt Holes, Front Axle, Rear Axle	P27768T	1	1955-1971, Dana 27 Axle, Front Axle, Rear Axle	P27666	1
1946-1949, Dana 27 Axle, Front Axle, Rear Axle	P27666	1	1955-1971, Dana 30 Axle, Front Axle	P27603	1
1946-1949, Dana 30 Axle, Front Axle	P27603	1	1955-1970, Dana 20 Axle, Dana 44 Axle, 10 Bolt Holes, Front Axle, Rear Axle	P27768T	1
1946-1949, Dana 35 Axle, Rear Axle	P27801	1	1955-1970, Dana 35 Axle, Rear Axle	P27801	1
1946-1949, Dana 44 Axle, 10 Bolt Holes, Front Axle, Rear Axle, Tuff-Cork	P27768TC	1	1955-1970, Dana 53 Axle, Front Axle, Rear Axle	P27934	1
1946-1949, Dana 53 Axle, Front Axle, Rear Axle	P27934	1	1955-1970, Dana 60, 70 Axle, Rear Axle	P18562	1
1946-1949, Dana 60, 70 Axle, Rear Axle	P18562	1	1955-1970, Dana 60, 70 Axle, Rear Axle, Tuff-Cork	P18562TC	1
1946-1949, Dana 60, 70 Axle, Rear Axle, Tuff-Cork	P18562TC	1	CJ5A		
CJ3A			Axle Hsg Cover Gasket		
Axle Hsg Cover Gasket			1964-1968, Dana 20 Axle, No Bolt Holes, Rear Axle, 10" X 10-3/4"		
1949-1953, Dana 20 Axle, No Bolt Holes, Rear Axle, 10" X 10-3/4"	P37830	1	1964-1968, Dana 20 Axle, Dana 44 Axle, 10 Bolt Holes, Front Axle, Rear Axle	P27768T	1
1949-1953, Dana 20 Axle, Dana 44 Axle, 10 Bolt Holes, Front Axle, Rear Axle	P27768T	1	1964-1968, Dana 27 Axle, Front Axle, Rear Axle	P27666	1
1949-1953, Dana 27 Axle, Front Axle, Rear Axle	P27666	1	1964-1968, Dana 30 Axle, Front Axle	P27603	1
1949-1953, Dana 30 Axle, Front Axle	P27603	1	1964-1968, Dana 35 Axle, Rear Axle	P27801	1
1949-1953, Dana 35 Axle, Rear Axle	P27801	1	1964-1968, Dana 44 Axle, 10 Bolt Holes, Front Axle, Rear Axle, Tuff-Cork	P27768TC	1
1949-1953, Dana 44 Axle, 10 Bolt Holes, Front Axle, Rear Axle, Tuff-Cork	P27768TC	1	1964-1968, Dana 53 Axle, Front Axle, Rear Axle	P27934	1
1949-1953, Dana 53 Axle, Front Axle, Rear Axle	P27934	1	1964-1968, Dana 60, 70 Axle, Rear Axle	P18562	1
1949-1953, Dana 60, 70 Axle, Rear Axle	P18562	1	1964-1968, Dana 60, 70 Axle, Rear Axle, Tuff-Cork	P18562TC	1
1949-1953, Dana 60, 70 Axle, Rear Axle, Tuff-Cork	P18562TC	1	CJ6		
CJ3B			Axle Hsg Cover Gasket		
Axle Hsg Cover Gasket			1972-1975, Dana 35 Axle, Rear Axle		
1953-1966, Dana 20 Axle, No Bolt Holes, Rear Axle, 10" X 10-3/4"	P37830	1	1972-1975, Dana 53 Axle, Front Axle, Rear Axle	P27934	1
1953-1966, Dana 20 Axle, Dana 44 Axle, 10 Bolt Holes, Front Axle, Rear Axle	P27768T	1	1972-1975, Dana 60, 70 Axle, Rear Axle	P18562	1
1953-1966, Dana 27 Axle, Front Axle, Rear Axle	P27666	1	1972-1975, Dana 60, 70 Axle, Rear Axle, Tuff-Cork	P18562TC	1
1953-1966, Dana 30 Axle, Front Axle	P27603	1	1971-1975, Dana 20 Axle, No Bolt Holes, Rear Axle, 10" X 10-3/4"	P37830	1
1953-1966, Dana 35 Axle, Rear Axle	P27801	1	1971-1975, Dana 44 Axle, 10 Bolt Holes, Front Axle, Rear Axle	P27768T	1
1953-1966, Dana 44 Axle, 10 Bolt Holes, Front Axle, Rear Axle, Tuff-Cork	P27768TC	1	1971-1975, Dana 44 Axle, 10 Bolt Holes, Front Axle, Rear Axle, Tuff-Cork	P27768TC	1
1953-1966, Dana 53 Axle, Front Axle, Rear Axle	P27934	1	1971, Dana 27 Axle, Front Axle, Rear Axle	P27666	1
1953-1966, Dana 60, 70 Axle, Rear Axle	P18562	1	1971, Dana 30 Axle, Front Axle	P27603	1
1953-1966, Dana 60, 70 Axle, Rear Axle, Tuff-Cork	P18562TC	1	1956-1968, Dana 20 Axle, No Bolt Holes, Rear Axle, 10" X 10-3/4"	P37830	1
CJ5			1956-1968, Dana 20 Axle, Dana 44 Axle, 10 Bolt Holes, Front Axle, Rear Axle	P27768T	1
Axle Hsg Cover Gasket			1956-1968, Dana 27 Axle, Front Axle, Rear Axle	P27666	1
1980-1983, Dana 30 Axle, Front Axle	P27603	1	1956-1968, Dana 30 Axle, Front Axle	P27603	1
1972-1983, Dana 35 Axle, Rear Axle	P27801	1	1956-1968, Dana 35 Axle, Rear Axle	P27801	1
1972-1981, Dana 60, 70 Axle, Rear Axle	P18562	1	1956-1968, Dana 44 Axle, 10 Bolt Holes, Front Axle, Rear Axle, Tuff-Cork	P27768TC	1
1972-1981, Dana 60, 70 Axle, Rear Axle, Tuff-Cork	P18562TC	1	1956-1968, Dana 53 Axle, Front Axle, Rear Axle	P27934	1
1972-1978, Dana 53 Axle, Front Axle, Rear Axle	P27934	1	1956-1968, Dana 60, 70 Axle, Rear Axle	P18562	1
1971-1983, Dana 44 Axle, 10 Bolt Holes, Front Axle, Rear Axle	P27768T	1	1956-1968, Dana 60, 70 Axle, Rear Axle, Tuff-Cork	P18562TC	1
1971, Dana 44 Axle, 10 Bolt Holes, Tuff-Cork	P27768TC	1	CJ6A		
1955-1983, Dana 20 Axle, No Bolt Holes, Rear Axle, 10" X 10-3/4"	P37830	1	Axle Hsg Cover Gasket		
1955-1983, Dana 44 Axle, 10 Bolt Holes, Front Axle, Rear Axle, Tuff-Cork	P27768TC	1	1964-1968, Dana 20 Axle, No Bolt Holes, Rear Axle, 10" X 10-3/4"		
		 P37830 1		

LIGHT TRUCK

Differential Housing Cover Gaskets (cont.)

Model & Application	Part No.	Qty.	Model & Application	Part No.	Qty.
CJ6A (cont.)			COMANCHE		
Axle Hsg Cover Gasket (cont.)			Axle Hsg Cover Gasket		
1964-1968, Dana 20 Axle, Dana 44 Axle, 10 Bolt Holes, Front Axle, Rear Axle	P27768T	1	1989-1990, Dana 44 Axle, 10 Bolt Holes, Tuff-Cork	P27768TC	1
1964-1968, Dana 27 Axle, Front Axle, Rear Axle	P27666	1	1986-1992, Dana 27 Axle, Front Axle, Rear Axle	P27666	1
1964-1968, Dana 30 Axle, Front Axle	P27603	1	1986-1992, Dana 30 Axle, Front Axle	P27603	1
1964-1968, Dana 35 Axle, Rear Axle	P27801	1	1986-1992, Dana 35 Axle, Rear Axle	P27801	1
1964-1968, Dana 44 Axle, 10 Bolt Holes, Front Axle, Rear Axle, Tuff-Cork	P27768TC	1	1986-1992, Dana 44 Axle, 10 Bolt Holes, Front Axle, Rear Axle	P27768T	1
1964-1968, Dana 53 Axle, Front Axle, Rear Axle	P27934	1	1986-1992, Dana 44 Axle, 10 Bolt Holes, Front Axle, Rear Axle, Tuff-Cork	P27768TC	1
1964-1968, Dana 60, 70 Axle, Rear Axle	P18562	1			
1964-1968, Dana 60, 70 Axle, Rear Axle, Tuff-Cork	P18562TC	1			
CJ7			DJ3A		
Axle Hsg Cover Gasket			Axle Hsg Cover Gasket		
1980-1986, Dana 30 Axle, Front Axle	P27603	1	1956-1966, Dana 20 Axle, No Bolt Holes, Rear Axle, 10" X 10-3/4"	P37830	1
1975-1986, Dana 20 Axle, No Bolt Holes, Rear Axle, 10" X 10-3/4"	P37830	1	1956-1966, Dana 20 Axle, Dana 44 Axle, 10 Bolt Holes, Rear Axle	P27768T	1
1975-1986, Dana 35 Axle, Rear Axle	P27801	1	1956-1966, Dana 27 Axle, Rear Axle	P27666	1
1975-1986, Dana 44 Axle, 10 Bolt Holes, Front Axle, Rear Axle	P27768T	1	1956-1966, Dana 35 Axle, Rear Axle	P27801	1
1975-1986, Dana 44 Axle, 10 Bolt Holes, Front Axle, Rear Axle, Tuff-Cork	P27768TC	1	1956-1966, Dana 44 Axle, 10 Bolt Holes, Rear Axle, Tuff-Cork	P27768TC	1
1975-1981, Dana 60, 70 Axle, Rear Axle	P18562	1	1956-1966, Dana 53 Axle, Rear Axle	P27934	1
1975-1981, Dana 60, 70 Axle, Rear Axle, Tuff-Cork	P18562TC	1	1956-1966, Dana 60, 70 Axle, Rear Axle	P18562	1
1975-1978, Dana 53 Axle, Front Axle, Rear Axle	P27934	1	1956-1966, Dana 60, 70 Axle, Rear Axle, Tuff-Cork	P18562TC	1
CJ8			DJ5		
Axle Hsg Cover Gasket			Axle Hsg Cover Gasket		
1981-1985, Dana 20 Axle, No Bolt Holes, Rear Axle, 10" X 10-3/4"	P37830	1	1972-1973, Dana 44 Axle, 10 Bolt Holes, Rear Axle, Tuff-Cork	P27768TC	1
1981-1985, Dana 30 Axle, Front Axle	P27603	1	1972-1973, Dana 53 Axle, Rear Axle	P27934	1
1981-1985, Dana 35 Axle, Rear Axle	P27801	1	1972-1973, Dana 60, 70 Axle, Rear Axle	P18562	1
1981-1985, Dana 44 Axle, 10 Bolt Holes, Front Axle, Rear Axle	P27768T	1	1972-1973, Dana 60, 70 Axle, Rear Axle, Tuff-Cork	P18562TC	1
1981-1985, Dana 44 Axle, 10 Bolt Holes, Front Axle, Rear Axle, Tuff-Cork	P27768TC	1	1971-1973, Dana 44 Axle, 10 Bolt Holes, Rear Axle	P27768T	1
1981-1985, Dana 60, 70 Axle, Rear Axle	P18562	1	1971, Dana 44 Axle, 10 Bolt Holes, Tuff-Cork	P27768TC	1
1981-1985, Dana 60, 70 Axle, Rear Axle, Tuff-Cork	P18562TC	1	1965-1973, Dana 20 Axle, No Bolt Holes, Rear Axle, 10" X 10-3/4"	P37830	1
			1965-1971, Dana 27 Axle, Rear Axle	P27666	1
			1965-1971, Dana 44 Axle, 10 Bolt Holes, Rear Axle, Tuff-Cork	P27768TC	1
			1965-1970, Dana 20 Axle, Dana 44 Axle, 10 Bolt Holes, Rear Axle	P27768T	1
			1965-1970, Dana 35 Axle, Rear Axle	P27801	1
			1965-1970, Dana 53 Axle, Rear Axle	P27934	1
			1965-1970, Dana 60, 70 Axle, Rear Axle	P18562	1
			1965-1970, Dana 60, 70 Axle, Rear Axle, Tuff-Cork	P18562TC	1
CHEROKEE			DJ6		
Axle Hsg Cover Gasket			Axle Hsg Cover Gasket		
1984-1998, Dana 30 Axle, Front Axle	P27603	1	1971, Dana 44 Axle, 10 Bolt Holes, Rear Axle	P27768T	1
1984-1996, Dana 27 Axle, Front Axle, Rear Axle	P27666	1	1971, Dana 44 Axle, 10 Bolt Holes, Tuff-Cork	P27768TC	1
1974-1998, Dana 35 Axle, Rear Axle	P27801	1	1965-1971, Dana 20 Axle, No Bolt Holes, Rear Axle, 10" X 10-3/4"	P37830	1
1974-1998, Dana 44 Axle, 10 Bolt Holes, Front Axle, Rear Axle	P27768T	1	1965-1971, Dana 27 Axle, Rear Axle	P27666	1
1974-1998, Dana 44 Axle, 10 Bolt Holes, Front Axle, Rear Axle, Tuff-Cork	P27768TC	1	1965-1971, Dana 44 Axle, 10 Bolt Holes, Rear Axle, Tuff-Cork	P27768TC	1
1974-1983, Dana 20 Axle, No Bolt Holes, Rear Axle, 10" X 10-3/4"	P37830	1	1965-1970, Dana 20 Axle, Dana 44 Axle, 10 Bolt Holes, Rear Axle	P27768T	1
1974-1983, Dana 60, 70 Axle, Rear Axle	P18562	1	1965-1970, Dana 35 Axle, Rear Axle	P27801	1
1974-1983, Dana 60, 70 Axle, Rear Axle, Tuff-Cork	P18562TC	1	1965-1970, Dana 53 Axle, Rear Axle	P27934	1
1974-1978, Dana 27 Axle, Front Axle, Rear Axle	P27666	1	1965-1970, Dana 60, 70 Axle, Rear Axle	P18562	1
1974-1978, Dana 53 Axle, Front Axle, Rear Axle	P27934	1			

LIGHT TRUCK

Jeep (cont.)

Differential Housing Cover Gaskets (cont.)

Model & Application	Part No.	Qty.	Model & Application	Part No.	Qty.
DJ6 (cont.)			FC170 HD (cont.)		
Axle Hsg Cover Gasket (cont.)			Axle Hsg Cover Gasket (cont.)		
1965-1970, Dana 60, 70 Axle, Rear Axle, Tuff-Cork	P18562TC	1	1963-1966, Dana 44 Axle, 10 Bolt Holes, Front Axle, Rear Axle, Tuff-Cork	P27768TC	1
F4-134			1963-1966, Dana 53 Axle, Front Axle, Rear Axle	P27934	1
Axle Hsg Cover Gasket			1963-1966, Dana 60, 70 Axle, Rear Axle	P18562	1
1957-1965, Dana 20 Axle, No Bolt Holes, Rear Axle, 10" X 10-3/4"	P37830	1	1963-1966, Dana 60, 70 Axle, Rear Axle, Tuff-Cork	P18562TC	1
1957-1965, Dana 20 Axle, Dana 44 Axle, 10 Bolt Holes, Front Axle, Rear Axle	P27768T	1	FJ3		
1957-1965, Dana 27 Axle, Front Axle, Rear Axle	P27666	1	Axle Hsg Cover Gasket		
1957-1965, Dana 30 Axle, Front Axle	P27603	1	1964, Dana 20 Axle, No Bolt Holes, Rear Axle, 10" X 10-3/4"	P37830	1
1957-1965, Dana 35 Axle, Rear Axle	P27801	1	1964, Dana 20 Axle, Dana 44 Axle, 10 Bolt Holes, Rear Axle	P27768T	1
1957-1965, Dana 44 Axle, 10 Bolt Holes, Front Axle, Rear Axle, Tuff-Cork	P27768TC	1	1964, Dana 27 Axle, Rear Axle	P27666	1
1957-1965, Dana 53 Axle, Front Axle, Rear Axle	P27934	1	1964, Dana 35 Axle, Rear Axle	P27801	1
1957-1965, Dana 60, 70 Axle, Rear Axle	P18562	1	1964, Dana 44 Axle, 10 Bolt Holes, Rear Axle, Tuff-Cork	P27768TC	1
1957-1965, Dana 60, 70 Axle, Rear Axle, Tuff-Cork	P18562TC	1	1964, Dana 53 Axle, Rear Axle	P27934	1
FC150			1964, Dana 60, 70 Axle, Rear Axle	P18562	1
Axle Hsg Cover Gasket			1964, Dana 60, 70 Axle, Rear Axle, Tuff-Cork	P18562TC	1
1957-1966, Dana 20 Axle, No Bolt Holes, Rear Axle, 10" X 10-3/4"	P37830	1	1961-1962, Dana 20 Axle, No Bolt Holes, Rear Axle, 10" X 10-3/4"	P37830	1
1957-1966, Dana 20 Axle, Dana 44 Axle, 10 Bolt Holes, Front Axle, Rear Axle	P27768T	1	1961-1962, Dana 20 Axle, Dana 44 Axle, 10 Bolt Holes, Rear Axle	P27768T	1
1957-1966, Dana 27 Axle, Front Axle, Rear Axle	P27666	1	1961-1962, Dana 27 Axle, Rear Axle	P27666	1
1957-1966, Dana 30 Axle, Front Axle	P27603	1	1961-1962, Dana 35 Axle, Rear Axle	P27801	1
1957-1966, Dana 35 Axle, Rear Axle	P27801	1	1961-1962, Dana 44 Axle, 10 Bolt Holes, Rear Axle, Tuff-Cork	P27768TC	1
1957-1966, Dana 44 Axle, 10 Bolt Holes, Front Axle, Rear Axle, Tuff-Cork	P27768TC	1	1961-1962, Dana 53 Axle, Rear Axle	P27934	1
1957-1966, Dana 53 Axle, Front Axle, Rear Axle	P27934	1	1961-1962, Dana 60, 70 Axle, Rear Axle	P18562	1
1957-1966, Dana 60, 70 Axle, Rear Axle	P18562	1	1961-1962, Dana 60, 70 Axle, Rear Axle, Tuff-Cork	P18562TC	1
1957-1966, Dana 60, 70 Axle, Rear Axle, Tuff-Cork	P18562TC	1	GLADIATOR		
FC170			Axle Hsg Cover Gasket		
Axle Hsg Cover Gasket			1971-1973, Dana 20 Axle, No Bolt Holes, Rear Axle, 10" X 10-3/4"	P37830	1
1957-1966, Dana 20 Axle, No Bolt Holes, Rear Axle, 10" X 10-3/4"	P37830	1	1971-1973, Dana 35 Axle, Rear Axle	P27801	1
1957-1966, Dana 20 Axle, Dana 44 Axle, 10 Bolt Holes, Front Axle, Rear Axle	P27768T	1	1965-1968, Dana 30 Axle, Front Axle	P27603	1
1957-1966, Dana 27 Axle, Front Axle, Rear Axle	P27666	1	1962-1973, Dana 44 Axle, 10 Bolt Holes, Front Axle, Rear Axle	P27768T	1
1957-1966, Dana 30 Axle, Front Axle	P27603	1	1962-1973, Dana 44 Axle, 10 Bolt Holes, Front Axle, Rear Axle, Tuff-Cork	P27768TC	1
1957-1966, Dana 35 Axle, Rear Axle	P27801	1	1962-1973, Dana 53 Axle, Front Axle, Rear Axle	P27934	1
1957-1966, Dana 44 Axle, 10 Bolt Holes, Front Axle, Rear Axle, Tuff-Cork	P27768TC	1	1962-1973, Dana 60, 70 Axle, Rear Axle	P18562	1
1957-1966, Dana 53 Axle, Front Axle, Rear Axle	P27934	1	1962-1973, Dana 60, 70 Axle, Rear Axle, Tuff-Cork	P18562TC	1
1957-1966, Dana 60, 70 Axle, Rear Axle	P18562	1	GLADIATOR J200		
1957-1966, Dana 60, 70 Axle, Rear Axle, Tuff-Cork	P18562TC	1	Axle Hsg Cover Gasket		
FC170 HD			1963-1965, Dana 20 Axle, No Bolt Holes, Rear Axle, 10" X 10-3/4"	P37830	1
Axle Hsg Cover Gasket			1963-1965, Dana 20 Axle, Dana 44 Axle, 10 Bolt Holes, Front Axle, Rear Axle	P27768T	1
1963-1966, Dana 20 Axle, No Bolt Holes, Rear Axle, 10" X 10-3/4"	P37830	1	1963-1965, Dana 27 Axle, Front Axle, Rear Axle	P27666	1
1963-1966, Dana 20 Axle, Dana 44 Axle, 10 Bolt Holes, Front Axle, Rear Axle	P27768T	1	1963-1965, Dana 30 Axle, Front Axle	P27603	1
1963-1966, Dana 27 Axle, Front Axle, Rear Axle	P27666	1	1963-1965, Dana 35 Axle, Rear Axle	P27801	1
1963-1966, Dana 30 Axle, Front Axle	P27603	1	1963-1965, Dana 44 Axle, 10 Bolt Holes, Front Axle, Rear Axle, Tuff-Cork	P27768TC	1
1963-1966, Dana 35 Axle, Rear Axle	P27801	1	1963-1965, Dana 53 Axle, Front Axle, Rear Axle	P27934	1
			1963-1965, Dana 60, 70 Axle, Rear Axle	P18562	1

LIGHT TRUCK

Differential Housing Cover Gaskets (cont.)

<i>Model & Application</i>	<i>Part No.</i>	<i>Qty.</i>	<i>Model & Application</i>	<i>Part No.</i>	<i>Qty.</i>
GLADIATOR J200 (cont.)			GLADIATOR J2800 (cont.)		
Axle Hsg Cover Gasket (cont.)			Axle Hsg Cover Gasket (cont.)		
1963-1965, Dana 60, 70 Axle, Rear Axle, Tuff-Cork	P18562TC	1	1965-1968, Dana 44 Axle, 10 Bolt Holes, Front Axle, Rear Axle, Tuff-Cork	P27768TC	1
GLADIATOR J2500			1965-1968, Dana 53 Axle, Front Axle, Rear Axle	P27934	1
Axle Hsg Cover Gasket			1965-1968, Dana 60, 70 Axle, Rear Axle	P18562	1
1965-1970, Dana 20 Axle, No Bolt Holes, Rear Axle, 10" X 10-3/4"	P37830	1	1965-1968, Dana 60, 70 Axle, Rear Axle, Tuff-Cork	P18562TC	1
1965-1970, Dana 20 Axle, Dana 44 Axle, 10 Bolt Holes, Front Axle, Rear Axle	P27768T	1	GLADIATOR J300		
1965-1970, Dana 27 Axle, Front Axle, Rear Axle	P27666	1	Axle Hsg Cover Gasket		
1965-1970, Dana 30 Axle, Front Axle	P27603	1	1963-1965, Dana 20 Axle, No Bolt Holes, Rear Axle, 10" X 10-3/4"	P37830	1
1965-1970, Dana 35 Axle, Rear Axle	P27801	1	1963-1965, Dana 20 Axle, Dana 44 Axle, 10 Bolt Holes, Front Axle, Rear Axle	P27768T	1
1965-1970, Dana 44 Axle, 10 Bolt Holes, Front Axle, Rear Axle, Tuff-Cork	P27768TC	1	1963-1965, Dana 27 Axle, Front Axle, Rear Axle	P27666	1
1965-1970, Dana 53 Axle, Front Axle, Rear Axle	P27934	1	1963-1965, Dana 30 Axle, Front Axle	P27603	1
1965-1970, Dana 60, 70 Axle, Rear Axle	P18562	1	1963-1965, Dana 35 Axle, Rear Axle	P27801	1
1965-1970, Dana 60, 70 Axle, Rear Axle, Tuff-Cork	P18562TC	1	1963-1965, Dana 44 Axle, 10 Bolt Holes, Front Axle, Rear Axle, Tuff-Cork	P27768TC	1
GLADIATOR J2600			1963-1965, Dana 53 Axle, Front Axle, Rear Axle	P27934	1
Axle Hsg Cover Gasket			1963-1965, Dana 60, 70 Axle, Rear Axle	P18562	1
1965-1970, Dana 20 Axle, No Bolt Holes, Rear Axle, 10" X 10-3/4"	P37830	1	1963-1965, Dana 60, 70 Axle, Rear Axle, Tuff-Cork	P18562TC	1
1965-1970, Dana 20 Axle, Dana 44 Axle, 10 Bolt Holes, Front Axle, Rear Axle	P27768T	1	GLADIATOR J3500		
1965-1970, Dana 27 Axle, Front Axle, Rear Axle	P27666	1	Axle Hsg Cover Gasket		
1965-1970, Dana 30 Axle, Front Axle	P27603	1	1965-1970, Dana 20 Axle, No Bolt Holes, Rear Axle, 10" X 10-3/4"	P37830	1
1965-1970, Dana 35 Axle, Rear Axle	P27801	1	1965-1970, Dana 20 Axle, Dana 44 Axle, 10 Bolt Holes, Front Axle, Rear Axle	P27768T	1
1965-1970, Dana 44 Axle, 10 Bolt Holes, Front Axle, Rear Axle, Tuff-Cork	P27768TC	1	1965-1970, Dana 27 Axle, Front Axle, Rear Axle	P27666	1
1965-1970, Dana 53 Axle, Front Axle, Rear Axle	P27934	1	1965-1970, Dana 30 Axle, Front Axle	P27603	1
1965-1970, Dana 60, 70 Axle, Rear Axle	P18562	1	1965-1970, Dana 35 Axle, Rear Axle	P27801	1
1965-1970, Dana 60, 70 Axle, Rear Axle, Tuff-Cork	P18562TC	1	1965-1970, Dana 44 Axle, 10 Bolt Holes, Front Axle, Rear Axle, Tuff-Cork	P27768TC	1
GLADIATOR J2700			1965-1970, Dana 53 Axle, Front Axle, Rear Axle	P27934	1
Axle Hsg Cover Gasket			1965-1970, Dana 60, 70 Axle, Rear Axle	P18562	1
1965-1970, Dana 20 Axle, No Bolt Holes, Rear Axle, 10" X 10-3/4"	P37830	1	1965-1970, Dana 60, 70 Axle, Rear Axle, Tuff-Cork	P18562TC	1
1965-1970, Dana 20 Axle, Dana 44 Axle, 10 Bolt Holes, Front Axle, Rear Axle	P27768T	1	GLADIATOR J3600		
1965-1970, Dana 27 Axle, Front Axle, Rear Axle	P27666	1	Axle Hsg Cover Gasket		
1965-1970, Dana 30 Axle, Front Axle	P27603	1	1965-1970, Dana 20 Axle, No Bolt Holes, Rear Axle, 10" X 10-3/4"	P37830	1
1965-1970, Dana 35 Axle, Rear Axle	P27801	1	1965-1970, Dana 20 Axle, Dana 44 Axle, 10 Bolt Holes, Front Axle, Rear Axle	P27768T	1
1965-1970, Dana 44 Axle, 10 Bolt Holes, Front Axle, Rear Axle, Tuff-Cork	P27768TC	1	1965-1970, Dana 27 Axle, Front Axle, Rear Axle	P27666	1
1965-1970, Dana 53 Axle, Front Axle, Rear Axle	P27934	1	1965-1970, Dana 30 Axle, Front Axle	P27603	1
1965-1970, Dana 60, 70 Axle, Rear Axle	P18562	1	1965-1970, Dana 35 Axle, Rear Axle	P27801	1
1965-1970, Dana 60, 70 Axle, Rear Axle, Tuff-Cork	P18562TC	1	1965-1970, Dana 44 Axle, 10 Bolt Holes, Front Axle, Rear Axle, Tuff-Cork	P27768TC	1
GLADIATOR J2800			1965-1970, Dana 53 Axle, Front Axle, Rear Axle	P27934	1
Axle Hsg Cover Gasket			1965-1970, Dana 60, 70 Axle, Rear Axle	P18562	1
1965-1968, Dana 20 Axle, No Bolt Holes, Rear Axle, 10" X 10-3/4"	P37830	1	1965-1970, Dana 60, 70 Axle, Rear Axle, Tuff-Cork	P18562TC	1
1965-1968, Dana 20 Axle, Dana 44 Axle, 10 Bolt Holes, Front Axle, Rear Axle	P27768T	1	GLADIATOR J3700		
1965-1968, Dana 27 Axle, Front Axle, Rear Axle	P27666	1	Axle Hsg Cover Gasket		
1965-1968, Dana 30 Axle, Front Axle	P27603	1	1965-1970, Dana 20 Axle, No Bolt Holes, Rear Axle, 10" X 10-3/4"	P37830	1
1965-1968, Dana 35 Axle, Rear Axle	P27801	1			

LIGHT TRUCK

Jeep (cont.)

Differential Housing Cover Gaskets (cont.)

Model & Application	Part No.	Qty.	Model & Application	Part No.	Qty.
GLADIATOR J3700 (cont.)			GRAND CHEROKEE (cont.)		
Axle Hsg Cover Gasket (cont.)			Axle Hsg Cover Gasket (cont.)		
1965-1970, Dana 20 Axle, Dana 44 Axle, 10 Bolt Holes, Front Axle, Rear Axle	P27768T	1	1993-1998, Dana 35 Axle, Rear Axle	P27801	1
1965-1970, Dana 27 Axle, Front Axle, Rear Axle	P27666	1	1993-1998, Dana 44 Axle, 10 Bolt Holes, Front Axle, Rear Axle	P27768T	1
1965-1970, Dana 30 Axle, Front Axle	P27603	1	1993-1998, Dana 44 Axle, 10 Bolt Holes, Front Axle, Rear Axle, Tuff-Cork	P27768TC	1
1965-1970, Dana 35 Axle, Rear Axle	P27801	1	GRAND WAGONEER		
1965-1970, Dana 44 Axle, 10 Bolt Holes, Front Axle, Rear Axle, Tuff-Cork	P27768TC	1	Axle Hsg Cover Gasket		
1965-1970, Dana 53 Axle, Front Axle, Rear Axle	P27934	1	1984-1991, Dana 44 Axle, 10 Bolt Holes, Front Axle, Rear Axle	P27768T	1
1965-1970, Dana 60, 70 Axle, Rear Axle	P18562	1	1984-1991, Dana 44 Axle, 10 Bolt Holes, Front Axle, Rear Axle, Tuff-Cork	P27768TC	1
1965-1970, Dana 60, 70 Axle, Rear Axle, Tuff-Cork	P18562TC	1	1984-1991, Dana 60, 70 Axle, Rear Axle	P18562	1
GLADIATOR J3800			1984-1991, Dana 60, 70 Axle, Rear Axle, Tuff-Cork	P18562TC	1
Axle Hsg Cover Gasket			1984-1986, Dana 20 Axle, No Bolt Holes, Rear Axle, 10" X 10-3/4"	P37830	1
1965-1970, Dana 20 Axle, No Bolt Holes, Rear Axle, 10" X 10-3/4"	P37830	1	1984-1986, Dana 30 Axle, 10 Bolt Holes, Front Axle	P27603	1
1965-1970, Dana 20 Axle, Dana 44 Axle, 10 Bolt Holes, Front Axle, Rear Axle	P27768T	1	J10		
1965-1970, Dana 27 Axle, Front Axle, Rear Axle	P27666	1	Axle Hsg Cover Gasket		
1965-1970, Dana 30 Axle, Front Axle	P27603	1	1974-1988, Dana 35 Axle, Rear Axle	P27801	1
1965-1970, Dana 35 Axle, Rear Axle	P27801	1	1974-1988, Dana 44 Axle, 10 Bolt Holes, Front Axle, Rear Axle	P27768T	1
1965-1970, Dana 44 Axle, 10 Bolt Holes, Front Axle, Rear Axle, Tuff-Cork	P27768TC	1	1974-1988, Dana 44 Axle, 10 Bolt Holes, Front Axle, Rear Axle, Tuff-Cork	P27768TC	1
1965-1970, Dana 53 Axle, Front Axle, Rear Axle	P27934	1	1974-1988, Dana 60, 70 Axle, Rear Axle	P18562	1
1965-1970, Dana 60, 70 Axle, Rear Axle	P18562	1	1974-1988, Dana 60, 70 Axle, Rear Axle, Tuff-Cork	P18562TC	1
1965-1970, Dana 60, 70 Axle, Rear Axle, Tuff-Cork	P18562TC	1	1974-1986, Dana 20 Axle, No Bolt Holes, Rear Axle, 10" X 10-3/4"	P37830	1
GLADIATOR J4500			1974-1978, Dana 27 Axle, Front Axle, Rear Axle	P27666	1
Axle Hsg Cover Gasket			1974-1978, Dana 53 Axle, Front Axle, Rear Axle	P27934	1
1970, Dana 20 Axle, No Bolt Holes, Rear Axle, 10" X 10-3/4"	P37830	1	J20		
1970, Dana 20 Axle, Dana 44 Axle, 10 Bolt Holes, Front Axle, Rear Axle	P27768T	1	Axle Hsg Cover Gasket		
1970, Dana 27 Axle, Front Axle, Rear Axle	P27666	1	1974-1988, Dana 35 Axle, Rear Axle	P27801	1
1970, Dana 30 Axle, Front Axle	P27603	1	1974-1988, Dana 44 Axle, 10 Bolt Holes, Front Axle, Rear Axle	P27768T	1
1970, Dana 35 Axle, Rear Axle	P27801	1	1974-1988, Dana 44 Axle, 10 Bolt Holes, Front Axle, Rear Axle, Tuff-Cork	P27768TC	1
1970, Dana 44 Axle, 10 Bolt Holes, Front Axle, Rear Axle, Tuff-Cork	P27768TC	1	1974-1988, Dana 60, 70 Axle, Rear Axle	P18562	1
1970, Dana 53 Axle, Front Axle, Rear Axle	P27934	1	1974-1988, Dana 60, 70 Axle, Rear Axle, Tuff-Cork	P18562TC	1
1970, Dana 60, 70 Axle, Rear Axle	P18562	1	1974-1986, Dana 20 Axle, No Bolt Holes, Rear Axle, 10" X 10-3/4"	P37830	1
1970, Dana 60, 70 Axle, Rear Axle, Tuff-Cork	P18562TC	1	1974-1978, Dana 27 Axle, Front Axle, Rear Axle	P27666	1
GLADIATOR J4600			1974-1978, Dana 53 Axle, Front Axle, Rear Axle	P27934	1
Axle Hsg Cover Gasket			J2500		
1970, Dana 20 Axle, No Bolt Holes, Rear Axle, 10" X 10-3/4"	P37830	1	Axle Hsg Cover Gasket		
1970, Dana 20 Axle, Dana 44 Axle, 10 Bolt Holes, Front Axle, Rear Axle	P27768T	1	1973, Dana 30 Axle, Front Axle	P27603	1
1970, Dana 27 Axle, Front Axle, Rear Axle	P27666	1	1971-1973, Dana 20 Axle, No Bolt Holes, Rear Axle, 10" X 10-3/4"	P37830	1
1970, Dana 30 Axle, Front Axle	P27603	1	1971-1973, Dana 35 Axle, Rear Axle	P27801	1
1970, Dana 35 Axle, Rear Axle	P27801	1	1971-1973, Dana 44 Axle, 10 Bolt Holes, Front Axle, Rear Axle	P27768T	1
1970, Dana 44 Axle, 10 Bolt Holes, Front Axle, Rear Axle, Tuff-Cork	P27768TC	1	1971-1973, Dana 44 Axle, 10 Bolt Holes, Front Axle, Rear Axle, Tuff-Cork	P27768TC	1
1970, Dana 53 Axle, Front Axle, Rear Axle	P27934	1	1971-1973, Dana 53 Axle, Front Axle, Rear Axle	P27934	1
1970, Dana 60, 70 Axle, Rear Axle	P18562	1	1971-1973, Dana 60, 70 Axle, Rear Axle	P18562	1
1970, Dana 60, 70 Axle, Rear Axle, Tuff-Cork	P18562TC	1	GRAND CHEROKEE		
GRAND CHEROKEE			Axle Hsg Cover Gasket		
Axle Hsg Cover Gasket			1993-1998, Dana 30 Axle, Front Axle	P27603	1

LIGHT TRUCK

Differential Housing Cover Gaskets (cont.)

Model & Application	Part No.	Qty.	Model & Application	Part No.	Qty.
J2500 (cont.)			J4700		
Axle Hsg Cover Gasket (cont.)			Axle Hsg Cover Gasket		
1971-1973, Dana 60, 70 Axle, Rear Axle, Tuff-Cork	P18562TC	1	1973, Dana 30 Axle, Front Axle	P27603	1
J2600			1971-1973, Dana 20 Axle, No Bolt Holes, Rear Axle, 10" X 10-3/4"	P37830	1
Axle Hsg Cover Gasket			1971-1973, Dana 35 Axle, Rear Axle	P27801	1
1973, Dana 30 Axle, Front Axle	P27603	1	1971-1973, Dana 44 Axle, 10 Bolt Holes, Front Axle, Rear Axle	P27768T	1
1972-1973, Dana 20 Axle, No Bolt Holes, Rear Axle, 10" X 10-3/4"	P37830	1	1971-1973, Dana 44 Axle, 10 Bolt Holes, Front Axle, Rear Axle, Tuff-Cork	P27768TC	1
1972-1973, Dana 35 Axle, Rear Axle	P27801	1	1971-1973, Dana 53 Axle, Front Axle, Rear Axle	P27934	1
1972-1973, Dana 44 Axle, 10 Bolt Holes, Front Axle, Rear Axle	P27768T	1	1971-1973, Dana 60, 70 Axle, Rear Axle	P18562	1
1972-1973, Dana 44 Axle, 10 Bolt Holes, Front Axle, Rear Axle, Tuff-Cork	P27768TC	1	1971-1973, Dana 60, 70 Axle, Rear Axle, Tuff-Cork	P18562TC	1
1972-1973, Dana 53 Axle, Front Axle, Rear Axle	P27934	1	J4800		
1972-1973, Dana 60, 70 Axle, Rear Axle	P18562	1	Axle Hsg Cover Gasket		
1972-1973, Dana 60, 70 Axle, Rear Axle, Tuff-Cork	P18562TC	1	1973, Dana 30 Axle, Front Axle	P27603	1
J3800			1971-1973, Dana 20 Axle, No Bolt Holes, Rear Axle, 10" X 10-3/4"	P37830	1
Axle Hsg Cover Gasket			1971-1973, Dana 35 Axle, Rear Axle	P27801	1
1971, Dana 20 Axle, No Bolt Holes, Rear Axle, 10" X 10-3/4"	P37830	1	1971-1973, Dana 44 Axle, 10 Bolt Holes, Front Axle, Rear Axle	P27768T	1
1971, Dana 35 Axle, Rear Axle	P27801	1	1971-1973, Dana 44 Axle, 10 Bolt Holes, Front Axle, Rear Axle, Tuff-Cork	P27768TC	1
1971, Dana 44 Axle, 10 Bolt Holes, Front Axle, Rear Axle	P27768T	1	1971-1973, Dana 53 Axle, Front Axle, Rear Axle	P27934	1
1971, Dana 44 Axle, 10 Bolt Holes, Front Axle, Rear Axle, Tuff-Cork	P27768TC	1	1971-1973, Dana 60, 70 Axle, Rear Axle	P18562	1
1971, Dana 53 Axle, Front Axle, Rear Axle	P27934	1	1971-1973, Dana 60, 70 Axle, Rear Axle, Tuff-Cork	P18562TC	1
1971, Dana 60, 70 Axle, Rear Axle	P18562	1	JEEPSTER		
1971, Dana 60, 70 Axle, Rear Axle, Tuff-Cork	P18562TC	1	Axle Hsg Cover Gasket		
J4500			1971-1973, Dana 44 Axle, 10 Bolt Holes, Front Axle, Rear Axle	P27768T	1
Axle Hsg Cover Gasket			1966-1973, Dana 20 Axle, No Bolt Holes, Rear Axle, 10" X 10-3/4"	P37830	1
1973, Dana 30 Axle, Front Axle	P27603	1	1966-1973, Dana 30 Axle, Front Axle	P27603	1
1971-1973, Dana 20 Axle, No Bolt Holes, Rear Axle, 10" X 10-3/4"	P37830	1	1966-1973, Dana 35 Axle, Rear Axle	P27801	1
1971-1973, Dana 35 Axle, Rear Axle	P27801	1	1966-1973, Dana 44 Axle, 10 Bolt Holes, Front Axle, Rear Axle, Tuff-Cork	P27768TC	1
1971-1973, Dana 44 Axle, 10 Bolt Holes, Front Axle, Rear Axle	P27768T	1	1966-1973, Dana 53 Axle, Front Axle, Rear Axle	P27934	1
1971-1973, Dana 44 Axle, 10 Bolt Holes, Front Axle, Rear Axle, Tuff-Cork	P27768TC	1	1966-1973, Dana 60, 70 Axle, Rear Axle	P18562	1
1971-1973, Dana 53 Axle, Front Axle, Rear Axle	P27934	1	1966-1973, Dana 60, 70 Axle, Rear Axle, Tuff-Cork	P18562TC	1
1971-1973, Dana 60, 70 Axle, Rear Axle	P18562	1	1966-1971, Dana 27 Axle, Front Axle, Rear Axle	P27666	1
1971-1973, Dana 60, 70 Axle, Rear Axle, Tuff-Cork	P18562TC	1	1966-1970, Dana 20 Axle, Dana 44 Axle, 10 Bolt Holes, Front Axle, Rear Axle	P27768T	1
J4600			L6-226		
Axle Hsg Cover Gasket			Axle Hsg Cover Gasket		
1973, Dana 30 Axle, Front Axle	P27603	1	1955-1964, Dana 20 Axle, Dana 44 Axle, 10 Bolt Holes, Front Axle, Rear Axle	P27768T	1
1971-1973, Dana 20 Axle, No Bolt Holes, Rear Axle, 10" X 10-3/4"	P37830	1	1955-1964, Dana 27 Axle, Front Axle, Rear Axle	P27666	1
1971-1973, Dana 35 Axle, Rear Axle	P27801	1	1955-1964, Dana 30 Axle, Front Axle	P27603	1
1971-1973, Dana 44 Axle, 10 Bolt Holes, Front Axle, Rear Axle	P27768T	1	1955-1964, Dana 35 Axle, Rear Axle	P27801	1
1971-1973, Dana 44 Axle, 10 Bolt Holes, Front Axle, Rear Axle, Tuff-Cork	P27768TC	1	1955-1964, Dana 44 Axle, 10 Bolt Holes, Front Axle, Rear Axle, Tuff-Cork	P27768TC	1
1971-1973, Dana 53 Axle, Front Axle, Rear Axle	P27934	1	1955-1964, Dana 53 Axle, Front Axle, Rear Axle	P27934	1
1971-1973, Dana 60, 70 Axle, Rear Axle	P18562	1	1955-1964, Dana 60, 70 Axle, Rear Axle	P18562	1
1971-1973, Dana 60, 70 Axle, Rear Axle, Tuff-Cork	P18562TC	1	1955-1964, Dana 60, 70 Axle, Rear Axle, Tuff-Cork	P18562TC	1

Jeep (cont.)

Differential Housing Cover Gaskets (cont.)

<i>Model & Application</i>	<i>Part No.</i>	<i>Qty.</i>	<i>Model & Application</i>	<i>Part No.</i>	<i>Qty.</i>
WAGONEER			WRANGLER		
Axle Hsg Cover Gasket			Axle Hsg Cover Gasket		
1984-1990, Dana 27 Axle, Front Axle, Rear Axle	P27666	1	1997-1998, 10 Bolt, Dana 44 Axle, Front Axle, Rear Axle	P27768T	1
1984-1990, Dana 30 Axle, Front Axle	P27603	1	1997-1998, 10 Bolt, Dana 44 Axle, 10 Bolt Holes, Front Axle, Rear Axle, Tuff-Cork	P27768TC	1
1974-1978, Dana 27 Axle, Front Axle, Rear Axle	P27666	1	1997-1998, Dana 27 Axle, Front Axle, Rear Axle	P27666	1
1972-1973, Dana 30 Axle, Front Axle	P27603	1	1997-1998, Dana 30 Axle, Front Axle	P27603	1
1963-1990, 10 Bolt, Dana 44 Axle, Front Axle, Rear Axle	P27768T	1	1997-1998, Dana 35 Axle, Rear Axle	P27801	1
1963-1990, 10 Bolt, Dana 44 Axle, 10 Bolt Holes, Front Axle, Rear Axle, Tuff-Cork	P27768TC	1	1987-1995, 10 Bolt, Dana 44 Axle, Front Axle, Rear Axle	P27768T	1
1963-1990, Dana 35 Axle, Rear Axle	P27801	1	1987-1995, 10 Bolt, Dana 44 Axle, 10 Bolt Holes, Front Axle, Rear Axle, Tuff-Cork	P27768TC	1
1963-1983, Dana 20 Axle, No Bolt Holes, Rear Axle, 10" X 10-3/4"	P37830	1	1987-1995, Dana 27 Axle, Front Axle, Rear Axle	P27666	1
1963-1983, Dana 60, 70 Axle, Rear Axle	P18562	1	1987-1995, Dana 30 Axle, Front Axle	P27603	1
1963-1983, Dana 60, 70 Axle, Rear Axle, Tuff-Cork	P18562TC	1	1987-1995, Dana 35 Axle, Rear Axle	P27801	1
1963-1978, Dana 53 Axle, Front Axle, Rear Axle	P27934	1			
1963-1970, Dana 27 Axle, Front Axle, Rear Axle	P27666	1			
1963-1970, Dana 30 Axle, Front Axle	P27603	1			

Transmission Gaskets

<i>Model & Application</i>	<i>Part No.</i>	<i>Qty.</i>	<i>Model & Application</i>	<i>Part No.</i>	<i>Qty.</i>
4 X 2			454 (cont.)		
P.T.O. Cover Gasket			P.T.O. Mounting Gasket (cont.)		
1948-1950, 6 Bolt, Chelsea Power Take Off	H36080	1	1954, .020" Thickness, 8 Bolt, Chelsea Power Take Off	H26208	1
1948-1950, 8 Bolt, Chelsea Power Take Off	H36124	1			
P.T.O. Mounting Gasket			473		
1948-1950, .010" Thickness, 6 Bolt, Chelsea Power Take Off	H26205	1	P.T.O. Cover Gasket		
1948-1950, .010" Thickness, 8 Bolt, Chelsea Power Take Off	H26207	1	1951-1952, 6 Bolt, Chelsea Power Take Off	H36080	1
1948-1950, .020" Thickness, 6 Bolt, Chelsea Power Take Off	H26206	1	1951-1952, 8 Bolt, Chelsea Power Take Off	H36124	1
1948-1950, .020" Thickness, 8 Bolt, Chelsea Power Take Off	H26208	1	P.T.O. Mounting Gasket		
			1951-1952, .010" Thickness, 6 Bolt, Chelsea Power Take Off	H26205	1
			1951-1952, .010" Thickness, 8 Bolt, Chelsea Power Take Off	H26207	1
			1951-1952, .020" Thickness, 6 Bolt, Chelsea Power Take Off	H26206	1
			1951-1952, .020" Thickness, 8 Bolt, Chelsea Power Take Off	H26208	1
4 X 4			Transmission Gasket Set		
P.T.O. Cover Gasket			1951-1952, 4 Speed Transmission, 4 Wheel Drive, Station Wagon.		
1947-1950, 6 Bolt, Chelsea Power Take Off	H36080	1		TS26290	1
1947-1950, 8 Bolt, Chelsea Power Take Off	H36124	1			
P.T.O. Mounting Gasket			475		
1947-1950, .010" Thickness, 6 Bolt, Chelsea Power Take Off	H26205	1	P.T.O. Cover Gasket		
1947-1950, .010" Thickness, 8 Bolt, Chelsea Power Take Off	H26207	1	1955-1956, 6 Bolt, Chelsea Power Take Off	H36080	1
1947-1950, .020" Thickness, 6 Bolt, Chelsea Power Take Off	H26206	1	1955-1956, 8 Bolt, Chelsea Power Take Off	H36124	1
1947-1950, .020" Thickness, 8 Bolt, Chelsea Power Take Off	H26208	1	1953, 6 Bolt, Chelsea Power Take Off	H36080	1
			1953, 8 Bolt, Chelsea Power Take Off	H36124	1
454			P.T.O. Mounting Gasket		
P.T.O. Cover Gasket			1955-1956, .010" Thickness, 6 Bolt, Chelsea Power Take Off		
1954, 6 Bolt, Chelsea Power Take Off	H36080	1		H26205	1
1954, 8 Bolt, Chelsea Power Take Off	H36124	1	1955-1956, .010" Thickness, 8 Bolt, Chelsea Power Take Off	H26207	1
P.T.O. Mounting Gasket			1955-1956, .020" Thickness, 6 Bolt, Chelsea Power Take Off		
1954, .010" Thickness, 6 Bolt, Chelsea Power Take Off	H26205	1		H26206	1
1954, .010" Thickness, 8 Bolt, Chelsea Power Take Off	H26207	1	1955-1956, .020" Thickness, 8 Bolt, Chelsea Power Take Off	H26208	1
1954, .020" Thickness, 6 Bolt, Chelsea Power Take Off	H26206	1	1953, .010" Thickness, 6 Bolt, Chelsea Power Take Off	H26205	1

LIGHT TRUCK

Transmission Gaskets (cont.)

<i>Model & Application</i>	<i>Part No.</i>	<i>Qty.</i>	<i>Model & Application</i>	<i>Part No.</i>	<i>Qty.</i>
475 (cont.)			CJ3A		
P.T.O. Mounting Gasket (cont.)			P.T.O. Cover Gasket		
1953, .010" Thickness, 8 Bolt, Chelsea Power Take Off	H26207	1	1949-1953, 6 Bolt, Chelsea Power Take Off . . .	H36080	1
1953, .020" Thickness, 6 Bolt, Chelsea Power Take Off	H26206	1	1949-1953, 8 Bolt, Chelsea Power Take Off . . .	H36124	1
1953, .020" Thickness, 8 Bolt, Chelsea Power Take Off	H26208	1	P.T.O. Mounting Gasket		
Transmission Gasket Set			1949-1953, .010" Thickness, 6 Bolt, Chelsea Power Take Off		
1955-1956, 4 Speed Transmission, Station Wagon	TS26290	1	1949-1953, .010" Thickness, 8 Bolt, Chelsea Power Take Off		
1953, 4 Speed Transmission, 4 Wheel Drive, Station Wagon	TS26290	1	1949-1953, .020" Thickness, 6 Bolt, Chelsea Power Take Off		
6-230			1949-1953, .020" Thickness, 8 Bolt, Chelsea Power Take Off		
P.T.O. Cover Gasket			H26208 1		
1962-1965, 6 Bolt, Chelsea Power Take Off . . .	H36080	1	Transfer Case Gasket Set		
1962-1965, 8 Bolt, Chelsea Power Take Off . . .	H36124	1	1962-1966, Dual Range, Spicer 20 Transfer Case		
P.T.O. Mounting Gasket			TS26290Z 1		
1962-1965, .010" Thickness, 6 Bolt, Chelsea Power Take Off	H26205	1	Transmission Pan Gasket		
1962-1965, .010" Thickness, 8 Bolt, Chelsea Power Take Off	H26207	1	1965-1966, Automatic Transmission		
1962-1965, .020" Thickness, 6 Bolt, Chelsea Power Take Off	H26206	1	1965-1966, Automatic Transmission, Tuff-Cork		
1962-1965, .020" Thickness, 8 Bolt, Chelsea Power Take Off	H26208	1	1962-1965, Automatic Transmission		
Transfer Case Gasket Set			W39341 1		
1962-1965, Dual Range, Spicer 20 Transfer Case	TS26290Z	1	W39341TC 1		
Transmission Pan Gasket			W38987 1		
1965, Automatic Transmission	W39341	1	654		
1965, Automatic Transmission, Tuff-Cork . . .	W39341TC	1	P.T.O. Cover Gasket		
1962-1965, Automatic Transmission	W38987	1	1954, 6 Bolt, Chelsea Power Take Off		
654			1954, 8 Bolt, Chelsea Power Take Off		
P.T.O. Cover Gasket			H36080 1		
1954, 6 Bolt, Chelsea Power Take Off	H36080	1	H36124 1		
1954, 8 Bolt, Chelsea Power Take Off	H36124	1	P.T.O. Mounting Gasket		
P.T.O. Mounting Gasket			1954, .010" Thickness, 6 Bolt, Chelsea Power Take Off		
1954, .010" Thickness, 6 Bolt, Chelsea Power Take Off	H26205	1	1954, .010" Thickness, 8 Bolt, Chelsea Power Take Off		
1954, .010" Thickness, 8 Bolt, Chelsea Power Take Off	H26207	1	1954, .020" Thickness, 6 Bolt, Chelsea Power Take Off		
1954, .020" Thickness, 6 Bolt, Chelsea Power Take Off	H26206	1	1954, .020" Thickness, 8 Bolt, Chelsea Power Take Off		
1954, .020" Thickness, 8 Bolt, Chelsea Power Take Off	H26208	1	CJ2A		
CJ2A			P.T.O. Cover Gasket		
P.T.O. Cover Gasket			1946-1949, 6 Bolt, Chelsea Power Take Off . . .		
1946-1949, 6 Bolt, Chelsea Power Take Off . . .	H36080	1	1946-1949, 8 Bolt, Chelsea Power Take Off . . .		
1946-1949, 8 Bolt, Chelsea Power Take Off . . .	H36124	1	P.T.O. Mounting Gasket		
P.T.O. Mounting Gasket			1946-1949, .010" Thickness, 6 Bolt, Chelsea Power Take Off		
1946-1949, .010" Thickness, 6 Bolt, Chelsea Power Take Off	H26205	1	1946-1949, .010" Thickness, 8 Bolt, Chelsea Power Take Off		
1946-1949, .010" Thickness, 8 Bolt, Chelsea Power Take Off	H26207	1	1946-1949, .020" Thickness, 6 Bolt, Chelsea Power Take Off		
1946-1949, .020" Thickness, 6 Bolt, Chelsea Power Take Off	H26206	1	1946-1949, .020" Thickness, 8 Bolt, Chelsea Power Take Off		
1946-1949, .020" Thickness, 8 Bolt, Chelsea Power Take Off	H26208	1	Transmission Gasket Set		
Transmission Gasket Set			1946-1948, 4 Speed Transmission		
1946-1948, 4 Speed Transmission	TS26290	1	CJ5		
CJ3A			P.T.O. Cover Gasket		
P.T.O. Cover Gasket			1955-1983, 6 Bolt, Chelsea Power Take Off . . .		
1949-1953, 6 Bolt, Chelsea Power Take Off . . .	H36080	1	1955-1983, 8 Bolt, Chelsea Power Take Off . . .		
1949-1953, 8 Bolt, Chelsea Power Take Off . . .	H36124	1	P.T.O. Mounting Gasket		
P.T.O. Mounting Gasket			1955-1983, .010" Thickness, 6 Bolt, Chelsea Power Take Off		
1949-1953, .010" Thickness, 6 Bolt, Chelsea Power Take Off	H26205	1	1955-1983, .010" Thickness, 8 Bolt, Chelsea Power Take Off		
1949-1953, .010" Thickness, 8 Bolt, Chelsea Power Take Off	H26207	1	1955-1983, .020" Thickness, 6 Bolt, Chelsea Power Take Off		
1949-1953, .020" Thickness, 6 Bolt, Chelsea Power Take Off	H26206	1	1955-1983, .020" Thickness, 8 Bolt, Chelsea Power Take Off		
1949-1953, .020" Thickness, 8 Bolt, Chelsea Power Take Off	H26208	1	Transfer Case Gasket Set		
Transfer Case Gasket Set			1962-1980, Dual Range, Spicer 20 Transfer Case		
1962-1980, Dual Range, Spicer 20 Transfer Case	TS26290Z	1	Transmission Gasket Set		
Transmission Gasket Set			1969-1972, T90 Transmission		
1969-1972, T90 Transmission	TS26290	1	1969-1972, T96 Transmission		
1969-1972, T96 Transmission	TS27576	1	Transmission Pan Gasket		
Transmission Pan Gasket			1979, 999 Transmission		
1979, 999 Transmission	W38031	1	1975-1981, A727 Automatic Transmission		
1975-1981, A727 Automatic Transmission	W39003	1	1975-1981, A727 Automatic Transmission, Tuff-Cork		
1975-1981, A727 Automatic Transmission, Tuff-Cork	W39003TC	1	1975-1977, 999 Transmission		
1975-1977, 999 Transmission	W38031	1	1965-1974, Automatic Transmission		
1965-1974, Automatic Transmission	W39341	1	1965-1974, Automatic Transmission, Tuff-Cork		
1965-1974, Automatic Transmission, Tuff-Cork	W39341TC	1	1962-1965, Automatic Transmission		
1962-1965, Automatic Transmission	W38987	1			

Jeep (cont.)

Transmission Gaskets (cont.)

<i>Model & Application</i>	<i>Part No.</i>	<i>Qty.</i>	<i>Model & Application</i>	<i>Part No.</i>	<i>Qty.</i>
CJ5A			CJ6A		
P.T.O. Cover Gasket			P.T.O. Cover Gasket		
1964-1968, 6 Bolt, Chelsea Power Take Off . . .	H36080	1	1964-1968, 6 Bolt, Chelsea Power Take Off . . .	H36080	1
1964-1968, 8 Bolt, Chelsea Power Take Off . . .	H36124	1	1964-1968, 8 Bolt, Chelsea Power Take Off . . .	H36124	1
P.T.O. Mounting Gasket			P.T.O. Mounting Gasket		
1964-1968, .010" Thickness, 6 Bolt, Chelsea Power Take Off	H26205	1	1964-1968, .010" Thickness, 6 Bolt, Chelsea Power Take Off	H26205	1
1964-1968, .010" Thickness, 8 Bolt, Chelsea Power Take Off	H26207	1	1964-1968, .010" Thickness, 8 Bolt, Chelsea Power Take Off	H26207	1
1964-1968, .020" Thickness, 6 Bolt, Chelsea Power Take Off	H26206	1	1964-1968, .020" Thickness, 6 Bolt, Chelsea Power Take Off	H26206	1
1964-1968, .020" Thickness, 8 Bolt, Chelsea Power Take Off	H26208	1	1964-1968, .020" Thickness, 8 Bolt, Chelsea Power Take Off	H26208	1
Transfer Case Gasket Set			Transfer Case Gasket Set		
1964-1968, Dual Range, Spicer 20 Transfer Case	TS26290Z	1	1964-1968, Dual Range, Spicer 20 Transfer Case	TS26290Z	1
Transmission Pan Gasket			Transmission Pan Gasket		
1965-1968, Automatic Transmission	W39341	1	1965-1968, Automatic Transmission	W39341	1
1965-1968, Automatic Transmission, Tuff-Cork	W39341TC	1	1965-1968, Automatic Transmission, Tuff-Cork	W39341TC	1
1964-1965, Automatic Transmission	W38987	1	1964-1965, Automatic Transmission	W38987	1
CJ6			CJ7		
P.T.O. Cover Gasket			P.T.O. Cover Gasket		
1971-1975, 6 Bolt, Chelsea Power Take Off . . .	H36080	1	1975-1986, 6 Bolt, Chelsea Power Take Off . . .	H36080	1
1971-1975, 8 Bolt, Chelsea Power Take Off . . .	H36124	1	1975-1986, 8 Bolt, Chelsea Power Take Off . . .	H36124	1
1956-1968, 6 Bolt, Chelsea Power Take Off . . .	H36080	1			
1956-1968, 8 Bolt, Chelsea Power Take Off . . .	H36124	1			
P.T.O. Mounting Gasket			P.T.O. Mounting Gasket		
1971-1975, .010" Thickness, 6 Bolt, Chelsea Power Take Off	H26205	1	1975-1986, .010" Thickness, 6 Bolt, Chelsea Power Take Off	H26205	1
1971-1975, .010" Thickness, 8 Bolt, Chelsea Power Take Off	H26207	1	1975-1986, .010" Thickness, 8 Bolt, Chelsea Power Take Off	H26207	1
1971-1975, .020" Thickness, 6 Bolt, Chelsea Power Take Off	H26206	1	1975-1986, .020" Thickness, 6 Bolt, Chelsea Power Take Off	H26206	1
1971-1975, .020" Thickness, 8 Bolt, Chelsea Power Take Off	H26208	1	1975-1986, .020" Thickness, 8 Bolt, Chelsea Power Take Off	H26208	1
1956-1968, .010" Thickness, 6 Bolt, Chelsea Power Take Off	H26205	1			
1956-1968, .010" Thickness, 8 Bolt, Chelsea Power Take Off	H26207	1			
1956-1968, .020" Thickness, 6 Bolt, Chelsea Power Take Off	H26206	1			
1956-1968, .020" Thickness, 8 Bolt, Chelsea Power Take Off	H26208	1			
Transfer Case Gasket Set			Transfer Case Gasket Set		
1971-1975, Dual Range, Spicer 20 Transfer Case	TS26290Z	1	1975-1980, Dual Range, Spicer 20 Transfer Case	TS26290Z	1
1962-1968, Dual Range, Spicer 20 Transfer Case	TS26290Z	1			
Transmission Gasket Set			Transmission Gasket Set		
1971-1972, T90 Transmission	TS26290	1	1975-1979, 4 Speed Transmission	TS27576	1
1971-1972, T96 Transmission	TS27576	1			
Transmission Pan Gasket			Transmission Pan Gasket		
1975, 999 Transmission	W38031	1	1981-1986, A904 Automatic Transmission, A999 Automatic Transmission	W38031	1
1975, A727 Automatic Transmission	W39003	1	1975-1985, A727 Automatic Transmission	W39003	1
1975, A727 Automatic Transmission, Tuff-Cork	W39003TC	1	1975-1985, A727 Automatic Transmission	W39003TC	1
1971-1974, Automatic Transmission	W39341	1	1975-1980, 999 Transmission	W38031	1
1971-1974, Automatic Transmission, Tuff-Cork	W39341TC	1			
1965-1968, Automatic Transmission	W39341	1			
1965-1968, Automatic Transmission, Tuff-Cork	W39341TC	1			
1962-1965, Automatic Transmission	W38987	1			
CJ8			CJ8		
P.T.O. Cover Gasket			P.T.O. Cover Gasket		
			1981-1985, 6 Bolt, Chelsea Power Take Off . . .	H36080	1
			1981-1985, 8 Bolt, Chelsea Power Take Off . . .	H36124	1
P.T.O. Mounting Gasket			P.T.O. Mounting Gasket		
			1981-1985, .010" Thickness, 6 Bolt, Chelsea Power Take Off	H26205	1
			1981-1985, .010" Thickness, 8 Bolt, Chelsea Power Take Off	H26207	1
			1981-1985, .020" Thickness, 6 Bolt, Chelsea Power Take Off	H26206	1
			1981-1985, .020" Thickness, 8 Bolt, Chelsea Power Take Off	H26208	1
Transmission Pan Gasket			Transmission Pan Gasket		
			1981-1985, A727 Automatic Transmission	W39003	1
			1981-1985, A727 Automatic Transmission, Tuff-Cork	W39003TC	1
			1981-1985, A904 Automatic Transmission, A999 Automatic Transmission	W38031	1

LIGHT TRUCK

Transmission Gaskets (cont.)				
Model & Application	Part No.	Qty.	Model & Application	Part No. Qty.
CHEROKEE			DJ3A (cont.)	
P.T.O. Cover Gasket			Transmission Pan Gasket (cont.)	
1974-1998, 6 Bolt, Chelsea Power Take Off . . .	H36080	1	1962-1965, Automatic Transmission	W38987 1
1974-1998, 8 Bolt, Chelsea Power Take Off . . .	H36124	1		
P.T.O. Mounting Gasket			DJ5	
1974-1998, .010" Thickness, 6 Bolt, Chelsea Power Take Off	H26205	1	P.T.O. Cover Gasket	
1974-1998, .010" Thickness, 8 Bolt, Chelsea Power Take Off	H26207	1	1965-1973, 6 Bolt, Chelsea Power Take Off . . .	H36080 1
1974-1998, .020" Thickness, 6 Bolt, Chelsea Power Take Off	H26206	1	1965-1973, 8 Bolt, Chelsea Power Take Off . . .	H36124 1
1974-1998, .020" Thickness, 8 Bolt, Chelsea Power Take Off	H26208	1	P.T.O. Mounting Gasket	
Transfer Case Gasket Set			1965-1973, .010" Thickness, 6 Bolt, Chelsea Power Take Off	
1974-1980, Dual Range, Spicer 20 Transfer Case	TS26290Z	1	1965-1973, .010" Thickness, 8 Bolt, Chelsea Power Take Off	H26205 1
Transmission Gasket Set			1965-1973, .020" Thickness, 6 Bolt, Chelsea Power Take Off	
1974-1979, 4 Speed Transmission	TS27576	1	1965-1973, .020" Thickness, 8 Bolt, Chelsea Power Take Off	H26206 1
Transmission Pan Gasket			1965-1973, .020" Thickness, 6 Bolt, Chelsea Power Take Off	
1994-2000, 30RH Automatic Transmission . . .	W38031	1	1965-1973, .020" Thickness, 8 Bolt, Chelsea Power Take Off	H26208 1
1981-1986, A904 Automatic Transmission, A999 Automatic Transmission	W38031	1	Transfer Case Gasket Set	
1975-1983, A727 Automatic Transmission	W39003	1	1965-1973, Dual Range, Spicer 20 Transfer Case	TS26290Z 1
1975-1983, A727 Automatic Transmission, Tuff-Cork	W39003TC	1	Transmission Gasket Set	
1975-1980, 999 Transmission	W38031	1	1969-1972, T90 Transmission	TS26290 1
1974, Automatic Transmission	W39341	1	1969-1972, T96 Transmission	TS27576 1
1974, Automatic Transmission, Tuff-Cork . . .	W39341TC	1	Transmission Pan Gasket	
COMANCHE			1965-1973, Automatic Transmission	
P.T.O. Cover Gasket			1965-1973, Automatic Transmission, Tuff-Cork	
1986-1992, 6 Bolt, Chelsea Power Take Off . . .	H36080	1	1965, Automatic Transmission	W38987 1
1986-1992, 8 Bolt, Chelsea Power Take Off . . .	H36124	1		
P.T.O. Mounting Gasket			DJ6	
1986-1992, .010" Thickness, 6 Bolt, Chelsea Power Take Off	H26205	1	P.T.O. Cover Gasket	
1986-1992, .010" Thickness, 8 Bolt, Chelsea Power Take Off	H26207	1	1965-1971, 6 Bolt, Chelsea Power Take Off . . .	H36080 1
1986-1992, .020" Thickness, 6 Bolt, Chelsea Power Take Off	H26206	1	1965-1971, 8 Bolt, Chelsea Power Take Off . . .	H36124 1
1986-1992, .020" Thickness, 8 Bolt, Chelsea Power Take Off	H26208	1	P.T.O. Mounting Gasket	
Transmission Pan Gasket			1965-1971, .010" Thickness, 6 Bolt, Chelsea Power Take Off	
1986, A904 Automatic Transmission, A999 Automatic Transmission	W38031	1	1965-1971, .010" Thickness, 8 Bolt, Chelsea Power Take Off	H26205 1
			1965-1971, .010" Thickness, 6 Bolt, Chelsea Power Take Off	H26207 1
			1965-1971, .020" Thickness, 6 Bolt, Chelsea Power Take Off	H26206 1
			1965-1971, .020" Thickness, 8 Bolt, Chelsea Power Take Off	H26208 1
			Transfer Case Gasket Set	
			1965-1971, Dual Range, Spicer 20 Transfer Case	TS26290Z 1
			Transmission Gasket Set	
			1969-1971, T90 Transmission	TS26290 1
			1969-1971, T96 Transmission	TS27576 1
			Transmission Pan Gasket	
			1965-1971, Automatic Transmission	W39341 1
			1965-1971, Automatic Transmission, Tuff-Cork	W39341TC 1
			1965, Automatic Transmission	W38987 1
			F4-134	
			P.T.O. Cover Gasket	
			1957-1965, 6 Bolt, Chelsea Power Take Off . . .	H36080 1
			1957-1965, 8 Bolt, Chelsea Power Take Off . . .	H36124 1
			P.T.O. Mounting Gasket	
			1957-1965, .010" Thickness, 6 Bolt, Chelsea Power Take Off	H26205 1
			1957-1965, .010" Thickness, 8 Bolt, Chelsea Power Take Off	H26207 1
			1957-1965, .020" Thickness, 6 Bolt, Chelsea Power Take Off	H26206 1
			1957-1965, .020" Thickness, 8 Bolt, Chelsea Power Take Off	H26208 1

LIGHT TRUCK

Jeep (cont.)

Transmission Gaskets (cont.)

<i>Model & Application</i>	<i>Part No.</i>	<i>Qty.</i>	<i>Model & Application</i>	<i>Part No.</i>	<i>Qty.</i>
F4-134 (cont.)			FC170 HD (cont.)		
P.T.O. Mounting Gasket (cont.)			P.T.O. Mounting Gasket (cont.)		
1957-1965, .020" Thickness, 8 Bolt, Chelsea Power Take Off	H26208	1	1963-1966, .010" Thickness, 8 Bolt, Chelsea Power Take Off	H26207	1
Transfer Case Gasket Set			Transfer Case Gasket Set		
1962-1965, Dual Range, Spicer 20 Transfer Case	TS26290Z	1	1963-1966, .020" Thickness, 6 Bolt, Chelsea Power Take Off	H26206	1
Transmission Gasket Set			Transmission Pan Gasket		
1957, 4 Speed Transmission, Station Wagon	TS26290	1	1965-1966, Automatic Transmission	W39341	1
Transmission Pan Gasket			Transmission Pan Gasket		
1965, Automatic Transmission	W39341	1	1965-1966, Automatic Transmission, Tuff-Cork	W39341TC	1
1965, Automatic Transmission, Tuff-Cork	W39341TC	1	1963-1965, Automatic Transmission	W38987	1
1962-1965, Automatic Transmission	W38987	1			
FC150			FJ3		
P.T.O. Cover Gasket			P.T.O. Cover Gasket		
1957-1966, 6 Bolt, Chelsea Power Take Off	H36080	1	1964, 6 Bolt, Chelsea Power Take Off	H36080	1
1957-1966, 8 Bolt, Chelsea Power Take Off	H36124	1	1964, 8 Bolt, Chelsea Power Take Off	H36124	1
P.T.O. Mounting Gasket			P.T.O. Mounting Gasket		
1957-1966, .010" Thickness, 6 Bolt, Chelsea Power Take Off	H26205	1	1961-1962, 6 Bolt, Chelsea Power Take Off	H36080	1
1957-1966, .010" Thickness, 8 Bolt, Chelsea Power Take Off	H26207	1	1961-1962, 8 Bolt, Chelsea Power Take Off	H36124	1
1957-1966, .020" Thickness, 6 Bolt, Chelsea Power Take Off	H26206	1	P.T.O. Mounting Gasket		
1957-1966, .020" Thickness, 8 Bolt, Chelsea Power Take Off	H26208	1	1964, .010" Thickness, 6 Bolt, Chelsea Power Take Off	H26205	1
Transfer Case Gasket Set			Transfer Case Gasket Set		
1962-1966, Dual Range, Spicer 20 Transfer Case	TS26290Z	1	1964, .010" Thickness, 8 Bolt, Chelsea Power Take Off	H26207	1
Transmission Pan Gasket			Transfer Case Gasket Set		
1965-1966, Automatic Transmission	W39341	1	1964, Dual Range, Spicer 20 Transfer Case	TS26290Z	1
1965-1966, Automatic Transmission, Tuff-Cork	W39341TC	1	1962, Dual Range, Spicer 20 Transfer Case	TS26290Z	1
1962-1965, Automatic Transmission	W38987	1	Transmission Pan Gasket		
			1964, Automatic Transmission	W38987	1
			1962, Automatic Transmission	W38987	1
FC170			GLADIATOR		
P.T.O. Cover Gasket			P.T.O. Cover Gasket		
1957-1966, 6 Bolt, Chelsea Power Take Off	H36080	1	1962-1973, 6 Bolt, Chelsea Power Take Off	H36080	1
1957-1966, 8 Bolt, Chelsea Power Take Off	H36124	1	1962-1973, 8 Bolt, Chelsea Power Take Off	H36124	1
P.T.O. Mounting Gasket			P.T.O. Mounting Gasket		
1957-1966, .010" Thickness, 6 Bolt, Chelsea Power Take Off	H26205	1	1962-1973, .010" Thickness, 6 Bolt, Chelsea Power Take Off	H26205	1
1957-1966, .010" Thickness, 8 Bolt, Chelsea Power Take Off	H26207	1	1962-1973, .010" Thickness, 8 Bolt, Chelsea Power Take Off	H26207	1
1957-1966, .020" Thickness, 6 Bolt, Chelsea Power Take Off	H26206	1	1962-1973, .020" Thickness, 6 Bolt, Chelsea Power Take Off	H26206	1
1957-1966, .020" Thickness, 8 Bolt, Chelsea Power Take Off	H26208	1	1962-1973, .020" Thickness, 8 Bolt, Chelsea Power Take Off	H26208	1
Transfer Case Gasket Set			Transfer Case Gasket Set		
1962-1966, Dual Range, Spicer 20 Transfer Case	TS26290Z	1	Transmission Gasket Set		
Transmission Pan Gasket			1969-1972, T90 Transmission		
1965-1966, Automatic Transmission	W39341	1	1969-1972, T96 Transmission		
1965-1966, Automatic Transmission, Tuff-Cork	W39341TC	1			
1962-1965, Automatic Transmission	W38987	1			
FC170 HD					
P.T.O. Cover Gasket					
1963-1966, 6 Bolt, Chelsea Power Take Off	H36080	1			
1963-1966, 8 Bolt, Chelsea Power Take Off	H36124	1			
P.T.O. Mounting Gasket					
1963-1966, .010" Thickness, 6 Bolt, Chelsea Power Take Off	H26205	1			

LIGHT TRUCK

Transmission Gaskets (cont.)

<i>Model & Application</i>	<i>Part No.</i>	<i>Qty.</i>	<i>Model & Application</i>	<i>Part No.</i>	<i>Qty.</i>
GLADIATOR (cont.)			GLADIATOR J2600 (cont.)		
Transmission Pan Gasket			Transfer Case Gasket Set		
1965-1973, Automatic Transmission	W39341	1	1965-1970, Dual Range, Spicer 20 Transfer Case	TS26290Z	1
1965-1973, Automatic Transmission, Tuff-Cork	W39341TC	1	Transmission Gasket Set		
1962-1965, Automatic Transmission	W38987	1	1969-1970, T90 Transmission	TS26290	1
GLADIATOR J200			1969-1970, T96 Transmission	TS27576	1
P.T.O. Cover Gasket			Transmission Pan Gasket		
1963-1965, 6 Bolt, Chelsea Power Take Off	H36080	1	1965-1970, Automatic Transmission	W39341	1
1963-1965, 8 Bolt, Chelsea Power Take Off	H36124	1	1965-1970, Automatic Transmission, Tuff-Cork	W39341TC	1
P.T.O. Mounting Gasket			1965, Automatic Transmission	W38987	1
1963-1965, .010" Thickness, 6 Bolt, Chelsea Power Take Off	H26205	1	GLADIATOR J2700		
1963-1965, .010" Thickness, 8 Bolt, Chelsea Power Take Off	H26207	1	P.T.O. Cover Gasket		
1963-1965, .020" Thickness, 6 Bolt, Chelsea Power Take Off	H26206	1	1965-1970, 6 Bolt, Chelsea Power Take Off	H36080	1
1963-1965, .020" Thickness, 8 Bolt, Chelsea Power Take Off	H26208	1	1965-1970, 8 Bolt, Chelsea Power Take Off	H36124	1
Transfer Case Gasket Set			P.T.O. Mounting Gasket		
1963-1965, Dual Range, Spicer 20 Transfer Case	TS26290Z	1	1965-1970, .010" Thickness, 6 Bolt, Chelsea Power Take Off	H26205	1
Transmission Pan Gasket			1965-1970, .010" Thickness, 8 Bolt, Chelsea Power Take Off	H26207	1
1965, Automatic Transmission	W39341	1	1965-1970, .020" Thickness, 6 Bolt, Chelsea Power Take Off	H26206	1
1965, Automatic Transmission, Tuff-Cork	W39341TC	1	1965-1970, .020" Thickness, 8 Bolt, Chelsea Power Take Off	H26208	1
1963-1965, Automatic Transmission	W38987	1	Transfer Case Gasket Set		
GLADIATOR J2500			1965-1970, Dual Range, Spicer 20 Transfer Case	TS26290Z	1
P.T.O. Cover Gasket			Transmission Gasket Set		
1965-1970, 6 Bolt, Chelsea Power Take Off	H36080	1	1969-1970, T90 Transmission	TS26290	1
1965-1970, 8 Bolt, Chelsea Power Take Off	H36124	1	1969-1970, T96 Transmission	TS27576	1
P.T.O. Mounting Gasket			Transmission Pan Gasket		
1965-1970, .010" Thickness, 6 Bolt, Chelsea Power Take Off	H26205	1	1965-1970, Automatic Transmission	W39341	1
1965-1970, .010" Thickness, 8 Bolt, Chelsea Power Take Off	H26207	1	1965-1970, Automatic Transmission, Tuff-Cork	W39341TC	1
1965-1970, .020" Thickness, 6 Bolt, Chelsea Power Take Off	H26206	1	1965, Automatic Transmission	W38987	1
1965-1970, .020" Thickness, 8 Bolt, Chelsea Power Take Off	H26208	1	GLADIATOR J2800		
Transfer Case Gasket Set			P.T.O. Cover Gasket		
1965-1970, Dual Range, Spicer 20 Transfer Case	TS26290Z	1	1965-1968, 6 Bolt, Chelsea Power Take Off	H36080	1
Transmission Gasket Set			1965-1968, 8 Bolt, Chelsea Power Take Off	H36124	1
1969-1970, T90 Transmission	TS26290	1	P.T.O. Mounting Gasket		
1969-1970, T96 Transmission	TS27576	1	1965-1968, .010" Thickness, 6 Bolt, Chelsea Power Take Off	H26205	1
Transmission Pan Gasket			1965-1968, .010" Thickness, 8 Bolt, Chelsea Power Take Off	H26207	1
1965-1970, Automatic Transmission	W39341	1	1965-1968, .020" Thickness, 6 Bolt, Chelsea Power Take Off	H26206	1
1965-1970, Automatic Transmission, Tuff-Cork	W39341TC	1	1965-1968, .020" Thickness, 8 Bolt, Chelsea Power Take Off	H26208	1
1965, Automatic Transmission	W38987	1	Transfer Case Gasket Set		
GLADIATOR J2600			1965-1968, Dual Range, Spicer 20 Transfer Case	TS26290Z	1
P.T.O. Cover Gasket			Transmission Pan Gasket		
1965-1970, 6 Bolt, Chelsea Power Take Off	H36080	1	1965-1968, Automatic Transmission	W39341	1
1965-1970, 8 Bolt, Chelsea Power Take Off	H36124	1	1965-1968, Automatic Transmission, Tuff-Cork	W39341TC	1
P.T.O. Mounting Gasket			1965, Automatic Transmission	W38987	1
1965-1970, .010" Thickness, 6 Bolt, Chelsea Power Take Off	H26205	1	GLADIATOR J300		
1965-1970, .010" Thickness, 8 Bolt, Chelsea Power Take Off	H26207	1	P.T.O. Cover Gasket		
1965-1970, .020" Thickness, 6 Bolt, Chelsea Power Take Off	H26206	1	1963-1965, 6 Bolt, Chelsea Power Take Off	H36080	1
1965-1970, .020" Thickness, 8 Bolt, Chelsea Power Take Off	H26208	1	1963-1965, 8 Bolt, Chelsea Power Take Off	H36124	1

LIGHT TRUCK

Jeep (cont.)

Transmission Gaskets (cont.)

<i>Model & Application</i>	<i>Part No.</i>	<i>Qty.</i>	<i>Model & Application</i>	<i>Part No.</i>	<i>Qty.</i>
GLADIATOR J300 (cont.)			GLADIATOR J3600 (cont.)		
P.T.O. Mounting Gasket			Transmission Pan Gasket (cont.)		
1963-1965, .010" Thickness, 6 Bolt, Chelsea Power Take Off	H26205	1	1965, Automatic Transmission	W38987	1
1963-1965, .010" Thickness, 8 Bolt, Chelsea Power Take Off	H26207	1	GLADIATOR J3700		
1963-1965, .020" Thickness, 6 Bolt, Chelsea Power Take Off	H26206	1	P.T.O. Cover Gasket		
1963-1965, .020" Thickness, 8 Bolt, Chelsea Power Take Off	H26208	1	1965-1970, 6 Bolt, Chelsea Power Take Off . . .	H36080	1
Transfer Case Gasket Set			1965-1970, 8 Bolt, Chelsea Power Take Off . . .	H36124	1
1963-1965, Dual Range, Spicer 20 Transfer Case	TS26290Z	1	P.T.O. Mounting Gasket		
Transmission Pan Gasket			1965-1970, .010" Thickness, 6 Bolt, Chelsea Power Take Off	H26205	1
1965, Automatic Transmission	W39341	1	1965-1970, .010" Thickness, 8 Bolt, Chelsea Power Take Off	H26207	1
1965, Automatic Transmission, Tuff-Cork . . .	W39341TC	1	1965-1970, .020" Thickness, 6 Bolt, Chelsea Power Take Off	H26206	1
1963-1965, Automatic Transmission	W38987	1	1965-1970, .020" Thickness, 8 Bolt, Chelsea Power Take Off	H26208	1
GLADIATOR J3500			Transfer Case Gasket Set		
P.T.O. Cover Gasket			1965-1970, Dual Range, Spicer 20 Transfer Case	TS26290Z	1
1965-1970, 6 Bolt, Chelsea Power Take Off . . .	H36080	1	Transmission Gasket Set		
1965-1970, 8 Bolt, Chelsea Power Take Off . . .	H36124	1	1969-1970, T90 Transmission	TS26290	1
P.T.O. Mounting Gasket			1969-1970, T96 Transmission	TS27576	1
1965-1970, .010" Thickness, 6 Bolt, Chelsea Power Take Off	H26205	1	Transmission Pan Gasket		
1965-1970, .010" Thickness, 8 Bolt, Chelsea Power Take Off	H26207	1	1965-1970, Automatic Transmission	W39341	1
1965-1970, .020" Thickness, 6 Bolt, Chelsea Power Take Off	H26206	1	1965-1970, Automatic Transmission, Tuff-Cork	W39341TC	1
1965-1970, .020" Thickness, 8 Bolt, Chelsea Power Take Off	H26208	1	1965, Automatic Transmission	W38987	1
Transfer Case Gasket Set			GLADIATOR J3800		
1965-1970, Dual Range, Spicer 20 Transfer Case	TS26290Z	1	P.T.O. Cover Gasket		
Transmission Gasket Set			1965-1970, 6 Bolt, Chelsea Power Take Off . . .	H36080	1
1969-1970, T90 Transmission	TS26290	1	1965-1970, 8 Bolt, Chelsea Power Take Off . . .	H36124	1
1969-1970, T96 Transmission	TS27576	1	P.T.O. Mounting Gasket		
Transmission Pan Gasket			1965-1970, .010" Thickness, 6 Bolt, Chelsea Power Take Off	H26205	1
1965-1970, Automatic Transmission	W39341	1	1965-1970, .010" Thickness, 8 Bolt, Chelsea Power Take Off	H26207	1
1965-1970, Automatic Transmission, Tuff-Cork	W39341TC	1	1965-1970, .020" Thickness, 6 Bolt, Chelsea Power Take Off	H26206	1
1965, Automatic Transmission	W38987	1	1965-1970, .020" Thickness, 8 Bolt, Chelsea Power Take Off	H26208	1
GLADIATOR J3600			Transfer Case Gasket Set		
P.T.O. Cover Gasket			1965-1970, Dual Range, Spicer 20 Transfer Case	TS26290Z	1
1965-1970, 6 Bolt, Chelsea Power Take Off . . .	H36080	1	Transmission Gasket Set		
1965-1970, 8 Bolt, Chelsea Power Take Off . . .	H36124	1	1969-1970, T90 Transmission	TS26290	1
P.T.O. Mounting Gasket			1969-1970, T96 Transmission	TS27576	1
1965-1970, .010" Thickness, 6 Bolt, Chelsea Power Take Off	H26205	1	Transmission Pan Gasket		
1965-1970, .010" Thickness, 8 Bolt, Chelsea Power Take Off	H26207	1	1965-1970, Automatic Transmission	W39341	1
1965-1970, .020" Thickness, 6 Bolt, Chelsea Power Take Off	H26206	1	1965-1970, Automatic Transmission, Tuff-Cork	W39341TC	1
1965-1970, .020" Thickness, 8 Bolt, Chelsea Power Take Off	H26208	1	1965, Automatic Transmission	W38987	1
Transfer Case Gasket Set			GLADIATOR J4500		
1965-1970, Dual Range, Spicer 20 Transfer Case	TS26290Z	1	P.T.O. Cover Gasket		
Transmission Gasket Set			1970, 6 Bolt, Chelsea Power Take Off	H36080	1
1969-1970, T90 Transmission	TS26290	1	1970, 8 Bolt, Chelsea Power Take Off	H36124	1
1969-1970, T96 Transmission	TS27576	1	P.T.O. Mounting Gasket		
Transmission Pan Gasket			1970, .010" Thickness, 6 Bolt, Chelsea Power Take Off	H26205	1
1965-1970, Automatic Transmission	W39341	1	1970, .010" Thickness, 8 Bolt, Chelsea Power Take Off	H26207	1
1965-1970, Automatic Transmission, Tuff-Cork	W39341TC	1	1970, .020" Thickness, 6 Bolt, Chelsea Power Take Off	H26206	1

LIGHT TRUCK

Transmission Gaskets (cont.)

<i>Model & Application</i>	<i>Part No.</i>	<i>Qty.</i>	<i>Model & Application</i>	<i>Part No.</i>	<i>Qty.</i>
GLADIATOR J4500 (cont.)			GRAND WAGONEER (cont.)		
P.T.O. Mounting Gasket (cont.)			P.T.O. Mounting Gasket		
1970, .020" Thickness, 8 Bolt, Chelsea Power Take Off	H26208	1	1989-1991, .010" Thickness, 6 Bolt, Chelsea Power Take Off	H26205	1
Transfer Case Gasket Set			1989-1991, .010" Thickness, 8 Bolt, Chelsea Power Take Off	H26207	1
1970, Dual Range, Spicer 20 Transfer Case	TS26290Z	1	1989-1991, .020" Thickness, 6 Bolt, Chelsea Power Take Off	H26206	1
Transmission Gasket Set			1989-1991, .020" Thickness, 8 Bolt, Chelsea Power Take Off	H26208	1
1970, T90 Transmission	TS26290	1	1984-1986, .010" Thickness, 6 Bolt, Chelsea Power Take Off	H26205	1
1970, T96 Transmission	TS27576	1	1984-1986, .010" Thickness, 8 Bolt, Chelsea Power Take Off	H26207	1
Transmission Pan Gasket			1984-1986, .020" Thickness, 6 Bolt, Chelsea Power Take Off	H26206	1
1970, Automatic Transmission	W39341	1	1984-1986, .020" Thickness, 8 Bolt, Chelsea Power Take Off	H26208	1
1970, Automatic Transmission, Tuff-Cork	W39341TC	1			
GLADIATOR J4600			Transmission Pan Gasket		
P.T.O. Cover Gasket			1984-1991, A727 Automatic Transmission		
1970, 6 Bolt, Chelsea Power Take Off	H36080	1	1984-1991, A727 Automatic Transmission, Tuff-Cork	W39003TC	1
1970, 8 Bolt, Chelsea Power Take Off	H36124	1	1984-1986, A904 Automatic Transmission, A999 Automatic Transmission	W38031	1
P.T.O. Mounting Gasket			J10		
1970, .010" Thickness, 6 Bolt, Chelsea Power Take Off	H26205	1	P.T.O. Cover Gasket		
1970, .010" Thickness, 8 Bolt, Chelsea Power Take Off	H26207	1	1974-1988, 6 Bolt, Chelsea Power Take Off		
1970, .020" Thickness, 6 Bolt, Chelsea Power Take Off	H26206	1	1974-1988, 8 Bolt, Chelsea Power Take Off		
1970, .020" Thickness, 8 Bolt, Chelsea Power Take Off	H26208	1	P.T.O. Mounting Gasket		
Transfer Case Gasket Set			1974-1988, .010" Thickness, 6 Bolt, Chelsea Power Take Off		
1970, Dual Range, Spicer 20 Transfer Case	TS26290Z	1	1974-1988, .010" Thickness, 8 Bolt, Chelsea Power Take Off		
Transmission Gasket Set			1974-1988, .020" Thickness, 6 Bolt, Chelsea Power Take Off		
1970, T90 Transmission	TS26290	1	1974-1988, .020" Thickness, 8 Bolt, Chelsea Power Take Off		
1970, T96 Transmission	TS27576	1	Transfer Case Gasket Set		
Transmission Pan Gasket			1974-1980, Dual Range, Spicer 20 Transfer Case		
1970, Automatic Transmission	W39341	1 TS26290Z 1		
1970, Automatic Transmission, Tuff-Cork	W39341TC	1	Transmission Gasket Set		
GRAND CHEROKEE			1974-1979, 4 Speed Transmission		
P.T.O. Cover Gasket		 TS27576 1		
1993-1998, 6 Bolt, Chelsea Power Take Off	H36080	1	Transmission Pan Gasket		
1993-1998, 8 Bolt, Chelsea Power Take Off	H36124	1	1981-1988, A904 Automatic Transmission, A999 Automatic Transmission		
P.T.O. Mounting Gasket		 W38031 1		
1993-1998, .010" Thickness, 6 Bolt, Chelsea Power Take Off	H26205	1	1975-1988, A727 Automatic Transmission		
1993-1998, .010" Thickness, 8 Bolt, Chelsea Power Take Off	H26207	1 W39003 1		
1993-1998, .020" Thickness, 6 Bolt, Chelsea Power Take Off	H26206	1	1975-1988, A727 Automatic Transmission, Tuff-Cork		
1993-1998, .020" Thickness, 8 Bolt, Chelsea Power Take Off	H26208	1 W39003TC 1		
Transmission Pan Gasket			1975-1980, 999 Transmission		
1998, 46RE Automatic Overdrive Transmission.	W39003	1 W38031 1		
1998, 46RE Automatic Overdrive Transmission, Tuff-Cork	W39003TC	1	1974, Automatic Transmission		
1994-1998, 44RE Automatic Overdrive Transmission.	W38031	1 W39341 1		
1993-2001, 42RE Automatic Overdrive Transmission.	W38031	1	1974, Automatic Transmission, Tuff-Cork		
GRAND WAGONEER		 W39341TC 1		
P.T.O. Cover Gasket			J20		
1989-1991, 6 Bolt, Chelsea Power Take Off	H36080	1	P.T.O. Cover Gasket		
1989-1991, 8 Bolt, Chelsea Power Take Off	H36124	1	1974-1988, 6 Bolt, Chelsea Power Take Off		
1984-1986, 6 Bolt, Chelsea Power Take Off	H36080	1	1974-1988, 8 Bolt, Chelsea Power Take Off		
1984-1986, 8 Bolt, Chelsea Power Take Off	H36124	1	P.T.O. Mounting Gasket		
			1974-1988, .010" Thickness, 6 Bolt, Chelsea Power Take Off		
		 H26205 1		
			1974-1988, .010" Thickness, 8 Bolt, Chelsea Power Take Off		
		 H26207 1		
			1974-1988, .020" Thickness, 6 Bolt, Chelsea Power Take Off		
		 H26206 1		
			1974-1988, .020" Thickness, 8 Bolt, Chelsea Power Take Off		
		 H26208 1		

LIGHT TRUCK

Jeep (cont.)

Transmission Gaskets (cont.)

<i>Model & Application</i>	<i>Part No.</i>	<i>Qty.</i>	<i>Model & Application</i>	<i>Part No.</i>	<i>Qty.</i>
J20 (cont.)			J3800		
Transfer Case Gasket Set			P.T.O. Cover Gasket		
1974-1980, Dual Range, Spicer 20 Transfer Case	TS26290Z	1	1971, 6 Bolt, Chelsea Power Take Off	H36080	1
Transmission Gasket Set			1971, 8 Bolt, Chelsea Power Take Off	H36124	1
1974-1979, 4 Speed Transmission	TS27576	1	P.T.O. Mounting Gasket		
Transmission Pan Gasket			1971, .010" Thickness, 6 Bolt, Chelsea Power Take Off	H26205	1
1981-1988, A904 Automatic Transmission, A999 Automatic Transmission	W38031	1	1971, .010" Thickness, 8 Bolt, Chelsea Power Take Off	H26207	1
1975-1988, A727 Automatic Transmission	W39003	1	1971, .020" Thickness, 6 Bolt, Chelsea Power Take Off	H26206	1
1975-1988, A727 Automatic Transmission, Tuff-Cork	W39003TC	1	1971, .020" Thickness, 8 Bolt, Chelsea Power Take Off	H26208	1
1975-1980, 999 Transmission	W38031	1	Transfer Case Gasket Set		
1974, Automatic Transmission	W39341	1	1971, Dual Range, Spicer 20 Transfer Case	TS26290Z	1
1974, Automatic Transmission, Tuff-Cork	W39341TC	1	Transmission Gasket Set		
J2500			1971, T90 Transmission	TS26290	1
P.T.O. Cover Gasket			1971, T96 Transmission	TS27576	1
1971-1973, 6 Bolt, Chelsea Power Take Off	H36080	1	Transmission Pan Gasket		
1971-1973, 8 Bolt, Chelsea Power Take Off	H36124	1	1971, Automatic Transmission	W39341	1
P.T.O. Mounting Gasket			1971, Automatic Transmission, Tuff-Cork	W39341TC	1
1971-1973, .010" Thickness, 6 Bolt, Chelsea Power Take Off	H26205	1	J4500		
1971-1973, .010" Thickness, 8 Bolt, Chelsea Power Take Off	H26207	1	P.T.O. Cover Gasket		
1971-1973, .020" Thickness, 6 Bolt, Chelsea Power Take Off	H26206	1	1971-1973, 6 Bolt, Chelsea Power Take Off	H36080	1
1971-1973, .020" Thickness, 8 Bolt, Chelsea Power Take Off	H26208	1	1971-1973, 8 Bolt, Chelsea Power Take Off	H36124	1
Transfer Case Gasket Set			P.T.O. Mounting Gasket		
1971-1973, Dual Range, Spicer 20 Transfer Case	TS26290Z	1	1971-1973, .010" Thickness, 6 Bolt, Chelsea Power Take Off	H26205	1
Transmission Gasket Set			1971-1973, .010" Thickness, 8 Bolt, Chelsea Power Take Off	H26207	1
1971-1972, T90 Transmission	TS26290	1	1971-1973, .020" Thickness, 6 Bolt, Chelsea Power Take Off	H26206	1
1971-1972, T96 Transmission	TS27576	1	1971-1973, .020" Thickness, 8 Bolt, Chelsea Power Take Off	H26208	1
Transmission Pan Gasket			Transfer Case Gasket Set		
1971-1973, Automatic Transmission	W39341	1	1971-1973, Dual Range, Spicer 20 Transfer Case	TS26290Z	1
1971-1973, Automatic Transmission, Tuff-Cork	W39341TC	1	Transmission Gasket Set		
J2600			1971-1972, T90 Transmission	TS26290	1
P.T.O. Cover Gasket			1971-1972, T96 Transmission	TS27576	1
1972-1973, 6 Bolt, Chelsea Power Take Off	H36080	1	Transmission Pan Gasket		
1972-1973, 8 Bolt, Chelsea Power Take Off	H36124	1	1971-1973, Automatic Transmission	W39341	1
P.T.O. Mounting Gasket			1971-1973, Automatic Transmission, Tuff-Cork	W39341TC	1
1972-1973, .010" Thickness, 6 Bolt, Chelsea Power Take Off	H26205	1	J4600		
1972-1973, .010" Thickness, 8 Bolt, Chelsea Power Take Off	H26207	1	P.T.O. Cover Gasket		
1972-1973, .020" Thickness, 6 Bolt, Chelsea Power Take Off	H26206	1	1971-1973, 6 Bolt, Chelsea Power Take Off	H36080	1
1972-1973, .020" Thickness, 8 Bolt, Chelsea Power Take Off	H26208	1	1971-1973, 8 Bolt, Chelsea Power Take Off	H36124	1
Transfer Case Gasket Set			P.T.O. Mounting Gasket		
1972-1973, Dual Range, Spicer 20 Transfer Case	TS26290Z	1	1971-1973, .010" Thickness, 6 Bolt, Chelsea Power Take Off	H26205	1
Transmission Gasket Set			1971-1973, .010" Thickness, 8 Bolt, Chelsea Power Take Off	H26207	1
1972, T90 Transmission	TS26290	1	1971-1973, .020" Thickness, 6 Bolt, Chelsea Power Take Off	H26206	1
1972, T96 Transmission	TS27576	1	1971-1973, .020" Thickness, 8 Bolt, Chelsea Power Take Off	H26208	1
Transmission Pan Gasket			Transfer Case Gasket Set		
1972-1973, Automatic Transmission	W39341	1	1971-1973, Dual Range, Spicer 20 Transfer Case	TS26290Z	1
1972-1973, Automatic Transmission, Tuff-Cork	W39341TC	1	Transmission Gasket Set		
Transfer Case Gasket Set			1971-1972, T90 Transmission	TS26290	1
1972-1973, Dual Range, Spicer 20 Transfer Case	TS26290Z	1	1971-1972, T96 Transmission	TS27576	1
Transmission Gasket Set			Transmission Pan Gasket		
1972, T90 Transmission	TS26290	1	1971-1973, Automatic Transmission	W39341	1
1972, T96 Transmission	TS27576	1	1971-1973, Automatic Transmission, Tuff-Cork	W39341TC	1
Transmission Pan Gasket			Transfer Case Gasket Set		
1972-1973, Automatic Transmission	W39341	1	1971-1973, Dual Range, Spicer 20 Transfer Case	TS26290Z	1
1972-1973, Automatic Transmission, Tuff-Cork	W39341TC	1	Transmission Gasket Set		
Transfer Case Gasket Set			1971-1972, T90 Transmission	TS26290	1
1972-1973, Dual Range, Spicer 20 Transfer Case	TS26290Z	1	1971-1972, T96 Transmission	TS27576	1
Transmission Gasket Set			Transmission Pan Gasket		
1971-1972, T90 Transmission	TS26290	1	1971-1973, Automatic Transmission	W39341	1
1971-1972, T96 Transmission	TS27576	1	1971-1973, Automatic Transmission, Tuff-Cork	W39341TC	1

LIGHT TRUCK

Transmission Gaskets (cont.)									
Model & Application		Part No.	Qty.		Model & Application		Part No.	Qty.	
J4600 (cont.)					JEEPSTER (cont.)				
Transmission Pan Gasket					P.T.O. Mounting Gasket (cont.)				
1971-1973, Automatic Transmission		W39341	1		1966-1973, .020" Thickness, 8 Bolt, Chelsea Power Take Off		H26208	1	
1971-1973, Automatic Transmission, Tuff-Cork		W39341TC	1		Transfer Case Gasket Set				
					1966-1973, Dual Range, Spicer 20 Transfer Case		TS26290Z	1	
J4700					Transmission Gasket Set				
P.T.O. Cover Gasket					1969-1972, T90 Transmission		TS26290	1	
1971-1973, 6 Bolt, Chelsea Power Take Off		H36080	1		1969-1972, T96 Transmission		TS27576	1	
1971-1973, 8 Bolt, Chelsea Power Take Off		H36124	1		Transmission Pan Gasket				
P.T.O. Mounting Gasket					1966-1973, Automatic Transmission		W39341	1	
1971-1973, .010" Thickness, 6 Bolt, Chelsea Power Take Off		H26205	1		1966-1973, Automatic Transmission, Tuff-Cork		W39341TC	1	
1971-1973, .010" Thickness, 8 Bolt, Chelsea Power Take Off		H26207	1		L6-226				
1971-1973, .020" Thickness, 6 Bolt, Chelsea Power Take Off		H26206	1		P.T.O. Cover Gasket				
1971-1973, .020" Thickness, 8 Bolt, Chelsea Power Take Off		H26208	1		1955-1964, 6 Bolt, Chelsea Power Take Off		H36080	1	
Transfer Case Gasket Set					1955-1964, 8 Bolt, Chelsea Power Take Off		H36124	1	
1971-1973, Dual Range, Spicer 20 Transfer Case		TS26290Z	1		P.T.O. Mounting Gasket				
Transmission Gasket Set					1955-1964, .010" Thickness, 6 Bolt, Chelsea Power Take Off		H26205	1	
1971-1972, T90 Transmission		TS26290	1		1955-1964, .010" Thickness, 8 Bolt, Chelsea Power Take Off		H26207	1	
1971-1972, T96 Transmission		TS27576	1		1955-1964, .020" Thickness, 6 Bolt, Chelsea Power Take Off		H26206	1	
Transmission Pan Gasket					1955-1964, .020" Thickness, 8 Bolt, Chelsea Power Take Off		H26208	1	
1971-1973, Automatic Transmission		W39341	1		Transmission Gasket Set				
1971-1973, Automatic Transmission, Tuff-Cork		W39341TC	1		1955-1957, 4 Speed Transmission, Station Wagon		TS26290	1	
J4800					WAGONEER				
P.T.O. Cover Gasket					P.T.O. Cover Gasket				
1971-1973, 6 Bolt, Chelsea Power Take Off		H36080	1		1963-1990, 6 Bolt, Chelsea Power Take Off		H36080	1	
1971-1973, 8 Bolt, Chelsea Power Take Off		H36124	1		1963-1990, 8 Bolt, Chelsea Power Take Off		H36124	1	
P.T.O. Mounting Gasket					P.T.O. Mounting Gasket				
1971-1973, .010" Thickness, 6 Bolt, Chelsea Power Take Off		H26205	1		1963-1990, .010" Thickness, 6 Bolt, Chelsea Power Take Off		H26205	1	
1971-1973, .010" Thickness, 8 Bolt, Chelsea Power Take Off		H26207	1		1963-1990, .010" Thickness, 8 Bolt, Chelsea Power Take Off		H26207	1	
1971-1973, .020" Thickness, 6 Bolt, Chelsea Power Take Off		H26206	1		1963-1990, .020" Thickness, 6 Bolt, Chelsea Power Take Off		H26206	1	
1971-1973, .020" Thickness, 8 Bolt, Chelsea Power Take Off		H26208	1		1963-1990, .020" Thickness, 8 Bolt, Chelsea Power Take Off		H26208	1	
Transfer Case Gasket Set					Transfer Case Gasket Set				
1971-1973, Dual Range, Spicer 20 Transfer Case		TS26290Z	1		1963-1980, Dual Range, Spicer 20 Transfer Case		TS26290Z	1	
Transmission Gasket Set					Transmission Gasket Set				
1971-1972, T90 Transmission		TS26290	1		1969-1972, T90 Transmission		TS26290	1	
1971-1972, T96 Transmission		TS27576	1		1969-1972, T96 Transmission		TS27576	1	
Transmission Pan Gasket					Transmission Pan Gasket				
1971-1973, Automatic Transmission		W39341	1		1981-1985, A904 Automatic Transmission, A999 Automatic Transmission		W38031	1	
1971-1973, Automatic Transmission, Tuff-Cork		W39341TC	1		1975-1983, A727 Automatic Transmission		W39003	1	
JEEPSTER					1975-1983, A727 Automatic Transmission, Tuff-Cork		W39003TC	1	
P.T.O. Cover Gasket					1975-1980, 999 Transmission		W38031	1	
1966-1973, 6 Bolt, Chelsea Power Take Off		H36080	1		1965-1974, Automatic Transmission		W39341	1	
1966-1973, 8 Bolt, Chelsea Power Take Off		H36124	1		1965-1974, Automatic Transmission, Tuff-Cork		W39341TC	1	
P.T.O. Mounting Gasket					1963-1965, Automatic Transmission		W38987	1	
1966-1973, .010" Thickness, 6 Bolt, Chelsea Power Take Off		H26205	1		WRANGLER				
1966-1973, .010" Thickness, 8 Bolt, Chelsea Power Take Off		H26207	1		P.T.O. Cover Gasket				
1966-1973, .020" Thickness, 6 Bolt, Chelsea Power Take Off		H26206	1		1997-1998, 6 Bolt, Chelsea Power Take Off		H36080	1	

Jeep (cont.)

Transmission Gaskets (cont.)

<i>Model & Application</i>	<i>Part No.</i>	<i>Qty.</i>	<i>Model & Application</i>	<i>Part No.</i>	<i>Qty.</i>
WRANGLER (cont.)			WRANGLER (cont.)		
P.T.O. Cover Gasket (cont.)			P.T.O. Mounting Gasket (cont.)		
1997-1998, 8 Bolt, Chelsea Power Take Off . . .	H36124	1	1987-1995, .010" Thickness, 8 Bolt, Chelsea Power Take Off	H26207	1
1987-1995, 6 Bolt, Chelsea Power Take Off . . .	H36080	1	1987-1995, .020" Thickness, 6 Bolt, Chelsea Power Take Off	H26206	1
1987-1995, 8 Bolt, Chelsea Power Take Off . . .	H36124	1	1987-1995, .020" Thickness, 8 Bolt, Chelsea Power Take Off	H26208	1
P.T.O. Mounting Gasket			Transmission Pan Gasket		
1997-1998, .010" Thickness, 6 Bolt, Chelsea Power Take Off	H26205	1	1997-2000, 30RH, 32RH Automatic Transmission.	W38031	1
1997-1998, .010" Thickness, 8 Bolt, Chelsea Power Take Off	H26207	1	1992-1995, 30RH, 32RH Automatic Transmission.	W38031	1
1997-1998, .020" Thickness, 6 Bolt, Chelsea Power Take Off	H26206	1	1987-1991, A999 Automatic Transmission	W38031	1
1997-1998, .020" Thickness, 8 Bolt, Chelsea Power Take Off	H26208	1			
1987-1995, .010" Thickness, 6 Bolt, Chelsea Power Take Off	H26205	1			

Mazda Truck

Differential Housing Cover Gaskets

<i>Model & Application</i>	<i>Part No.</i>	<i>Qty.</i>	<i>Model & Application</i>	<i>Part No.</i>	<i>Qty.</i>
B2300			B2300 (cont.)		
Axle Hsg Cover Gasket			Diff. Carrier Gasket		
1994-1997, Ford WDC, WFG Axles, Ford WDR, WFL Axles, Rear Axle, Tuff-Cork	P27608TC	1	1994-1997, Ford WAC, WFM Axles, Rear Axle, Tuff-Cork	P38154TC	1

Transmission Gaskets

<i>Model & Application</i>	<i>Part No.</i>	<i>Qty.</i>	<i>Model & Application</i>	<i>Part No.</i>	<i>Qty.</i>
B2300					
Transmission Pan Gasket					
1994-1997, A4LD Automatic Transmission . . .	W38144TC	1			

Mitsubishi Truck

Differential Housing Cover Gaskets

<i>Model & Application</i>	<i>Part No.</i>	<i>Qty.</i>	<i>Model & Application</i>	<i>Part No.</i>	<i>Qty.</i>
MIGHTY MAX			MONTERO		
Diff. Hsg. Cover Gasket			Diff. Hsg. Cover Gasket		
1983-1989, Rear Axle	P27682	1	1983-1989, Rear Axle	P27682	1
1983-1989, Front Axle	P38147	1	1983-1989, Front Axle	P38147	1

Transmission Gaskets

<i>Model & Application</i>	<i>Part No.</i>	<i>Qty.</i>	<i>Model & Application</i>	<i>Part No.</i>	<i>Qty.</i>
2300			MIGHTY MAX		
Transmission Pan Gasket			Transmission Pan Gasket		
1983-1985, Automatic Transmission	W39081	1	1987-1989, Automatic Transmission, Tuff-Cork	W39372	1
2600			1983-1986, Automatic Transmission		
Transmission Pan Gasket				W39081	1
1983-1986, Automatic Transmission	W39081	1	MONTERO		
			Transmission Pan Gasket		
			1987-1989, Automatic Transmission, Tuff-Cork		
				W39372	1

LIGHT TRUCK

Mitsubishi Truck (cont.)

Transmission Gaskets (cont.)					
<i>Model & Application</i>	<i>Part No.</i>	<i>Qty.</i>	<i>Model & Application</i>	<i>Part No.</i>	<i>Qty.</i>
MONTERO (cont.)			WAGON		
Transmission Pan Gasket (cont.)			Transmission Pan Gasket		
1983-1986, Automatic Transmission	W39081	1	1987-1990, Automatic Transmission, Tuff-Cork	W39372	1
SPX					
Transmission Pan Gasket					
1987-1989, Automatic Transmission, Tuff-Cork	W39372	1			
VAN					
Transmission Pan Gasket					
1987-1990, Automatic Transmission, Tuff-Cork	W39372	1			

Navistar/International

Differential Housing Cover Gaskets					
<i>Model & Application</i>	<i>Part No.</i>	<i>Qty.</i>	<i>Model & Application</i>	<i>Part No.</i>	<i>Qty.</i>
1100A			1100D		
Axle Hsg Cover Gasket			Axle Hsg Cover Gasket		
1966, FA16 Axle, FA17 Axle, FA46 Axle, RA1 Axle, RA18 Axle, RA28 Axle, RA3 Axle, Front Axle, Rear Axle	P27768T	1	1969-1971, FA16 Axle, FA17 Axle, FA46 Axle, RA1 Axle, RA18 Axle, RA28 Axle, RA3 Axle, Front Axle, Rear Axle	P27768T	1
1966, FA16 Axle, FA17 Axle, FA46 Axle, RA1 Axle, RA18 Axle, RA28 Axle, RA3 Axle, 10 Bolt Holes, Front Axle, Rear Axle, Tuff-Cork	P27768TC	1	1969-1971, FA16 Axle, FA17 Axle, FA46 Axle, RA1 Axle, RA18 Axle, RA28 Axle, RA3 Axle, 10 Bolt Holes, Front Axle, Rear Axle, Tuff-Cork	P27768TC	1
1966, RA53 Axle, RA54 Axle, RA83 Axle, RA84 Axle, Rear Axle	P18562	1	1969-1971, RA53 Axle, RA54 Axle, RA83 Axle, RA84 Axle, Rear Axle	P18562	1
1966, RA53 Axle, RA54 Axle, RA83 Axle, RA84 Axle, Rear Axle, Tuff-Cork	P18562TC	1	1969-1971, RA53 Axle, RA54 Axle, RA83 Axle, RA84 Axle, Rear Axle, Tuff-Cork	P18562TC	1
1100B			1200A		
Axle Hsg Cover Gasket			Axle Hsg Cover Gasket		
1967, FA16 Axle, FA17 Axle, FA46 Axle, RA1 Axle, RA18 Axle, RA28 Axle, RA3 Axle, Front Axle, Rear Axle	P27768T	1	1966, FA15 Axle, FA18 Axle, FA25 Axle, FA45 Axle, Front Axle	P27768T	1
1967, FA16 Axle, FA17 Axle, FA46 Axle, RA1 Axle, RA18 Axle, RA28 Axle, RA3 Axle, 10 Bolt Holes, Front Axle, Rear Axle, Tuff-Cork	P27768TC	1	1966, FA15 Axle, FA18 Axle, FA25 Axle, FA45 Axle, 10 Bolt Holes, Front Axle, Tuff-Cork	P27768TC	1
1967, RA53 Axle, RA54 Axle, RA83 Axle, RA84 Axle, Rear Axle	P18562	1	1966, RA16 Axle, RA17 Axle, Rear Axle	P18562	1
1967, RA53 Axle, RA54 Axle, RA83 Axle, RA84 Axle, Rear Axle, Tuff-Cork	P18562TC	1	1966, RA16 Axle, RA17 Axle, Rear Axle, Tuff-Cork	P18562TC	1
1100C			1200B		
Axle Hsg Cover Gasket			Axle Hsg Cover Gasket		
1968, FA16 Axle, FA17 Axle, FA46 Axle, RA1 Axle, RA18 Axle, RA28 Axle, RA3 Axle, Front Axle, Rear Axle	P27768T	1	1967, FA15 Axle, FA18 Axle, FA25 Axle, FA45 Axle, Front Axle	P27768T	1
1968, FA16 Axle, FA17 Axle, FA46 Axle, RA1 Axle, RA18 Axle, RA28 Axle, RA3 Axle, 10 Bolt Holes, Front Axle, Rear Axle, Tuff-Cork	P27768TC	1	1967, FA15 Axle, FA18 Axle, FA25 Axle, FA45 Axle, 10 Bolt Holes, Front Axle, Tuff-Cork	P27768TC	1
1968, RA53 Axle, RA54 Axle, RA83 Axle, RA84 Axle, Rear Axle	P18562	1	1967, FA16 Axle, RA17 Axle, Rear Axle	P18562	1
1968, RA53 Axle, RA54 Axle, RA83 Axle, RA84 Axle, Rear Axle, Tuff-Cork	P18562TC	1	1967, RA16 Axle, RA17 Axle, Rear Axle, Tuff-Cork	P18562TC	1
			1200C		
			Axle Hsg Cover Gasket		
			1968, FA15 Axle, FA18 Axle, FA25 Axle, FA45 Axle, Front Axle	P27768T	1
			1968, FA15 Axle, FA18 Axle, FA25 Axle, FA45 Axle, 10 Bolt Holes, Front Axle, Tuff-Cork	P27768TC	1
			1968, RA16 Axle, RA17 Axle, Rear Axle	P18562	1
			1968, RA16 Axle, RA17 Axle, Rear Axle, Tuff-Cork	P18562TC	1

LIGHT TRUCK

Navistar/International (cont.)

Differential Housing Cover Gaskets (cont.)

<i>Model & Application</i>	<i>Part No.</i>	<i>Qty.</i>	<i>Model & Application</i>	<i>Part No.</i>	<i>Qty.</i>
1200D			A120		
Axle Hsg Cover Gasket			Axle Hsg Cover Gasket		
1969-1971, FA15 Axle, FA18 Axle, FA25 Axle, FA45 Axle, Front Axle	P27768T	1	1957-1958, FA15 Axle, FA18 Axle, FA62 Axle, FA63 Axle, RA18 Axle, RA28 Axle, Front Axle, Rear Axle	P27768T	1
1969-1971, FA15 Axle, FA18 Axle, FA25 Axle, FA45 Axle, 10 Bolt Holes, Front Axle, Tuff-Cork	P27768TC	1	1957-1958, FA15 Axle, FA18 Axle, FA62 Axle, FA63 Axle, RA18 Axle, RA28 Axle, 10 Bolt Holes, Front Axle, Rear Axle, Tuff-Cork	P27768TC	1
1969-1971, RA16 Axle, RA17 Axle, Rear Axle	P18562	1	1957-1958, FA52 Axle, RA63 Axle, Front Axle, Rear Axle	P18562	1
1969-1971, RA16 Axle, RA17 Axle, Rear Axle, Tuff-Cork	P18562TC	1	1957-1958, FA52 Axle, RA63 Axle, Front Axle, Rear Axle, Tuff-Cork	P18562TC	1
1300A			A130		
Axle Hsg Cover Gasket			Axle Hsg Cover Gasket		
1966, FA52 Axle, RA63 Axle, Front Axle, Rear Axle	P18562	1	1957-1958, FA15 Axle, FA18 Axle, FA62 Axle, FA63 Axle, RA18 Axle, RA28 Axle, Front Axle, Rear Axle	P27768T	1
1966, FA52 Axle, RA63 Axle, Front Axle, Rear Axle, Tuff-Cork	P18562TC	1	1957-1958, FA15 Axle, FA18 Axle, FA62 Axle, FA63 Axle, RA18 Axle, RA28 Axle, 10 Bolt Holes, Front Axle, Rear Axle, Tuff-Cork	P27768TC	1
1300B			1300C		
Axle Hsg Cover Gasket			Axle Hsg Cover Gasket		
1967, FA52 Axle, RA63 Axle, Front Axle, Rear Axle	P18562	1	1967, FA52 Axle, RA63 Axle, Front Axle, Rear Axle, Tuff-Cork	P18562TC	1
1967, FA52 Axle, RA63 Axle, Front Axle, Rear Axle, Tuff-Cork	P18562TC	1	1300C		
1300C			Axle Hsg Cover Gasket		
Axle Hsg Cover Gasket			1968, FA52 Axle, RA63 Axle, Front Axle, Rear Axle	P18562	1
1300D			1968, FA52 Axle, RA63 Axle, Front Axle, Rear Axle, Tuff-Cork	P18562TC	1
Axle Hsg Cover Gasket			1300D		
1969-1971, FA52 Axle, RA63 Axle, Front Axle, Rear Axle	P18562	1	Axle Hsg Cover Gasket		
1969-1971, FA52 Axle, RA63 Axle, Front Axle, Rear Axle, Tuff-Cork	P18562TC	1	Axle Hsg Cover Gasket		
A100			1957-1958, FA15 Axle, FA18 Axle, FA62 Axle, FA63 Axle, RA18 Axle, RA28 Axle, Front Axle, Rear Axle		
Axle Hsg Cover Gasket			P27768T		
Axle Hsg Cover Gasket			1957-1958, FA15 Axle, FA18 Axle, FA62 Axle, FA63 Axle, RA18 Axle, RA28 Axle, 10 Bolt Holes, Front Axle, Rear Axle, Tuff-Cork		
Axle Hsg Cover Gasket			P27768TC		
Axle Hsg Cover Gasket			1957-1958, FA52 Axle, RA63 Axle, Front Axle, Rear Axle		
Axle Hsg Cover Gasket			P18562		
Axle Hsg Cover Gasket			1957-1958, FA52 Axle, RA63 Axle, Front Axle, Rear Axle, Tuff-Cork		
Axle Hsg Cover Gasket			P18562TC		
A110			B100		
Axle Hsg Cover Gasket			Axle Hsg Cover Gasket		
1957-1958, FA15 Axle, FA18 Axle, FA62 Axle, FA63 Axle, RA18 Axle, RA28 Axle, Front Axle, Rear Axle	P27768T	1	1959-1960, FA15 Axle, FA18 Axle, FA62 Axle, FA63 Axle, RA18 Axle, RA28 Axle, Front Axle, Rear Axle	P27768T	1
1957-1958, FA15 Axle, FA18 Axle, FA62 Axle, FA63 Axle, RA18 Axle, RA28 Axle, 10 Bolt Holes, Front Axle, Rear Axle, Tuff-Cork	P27768TC	1	1959-1960, FA15 Axle, FA18 Axle, FA62 Axle, FA63 Axle, RA18 Axle, RA28 Axle, 10 Bolt Holes, Front Axle, Rear Axle, Tuff-Cork	P27768TC	1
1957-1958, FA52 Axle, RA63 Axle, Front Axle, Rear Axle	P18562	1	1959-1960, FA52 Axle, RA63 Axle, Front Axle, Rear Axle	P18562	1
1957-1958, FA52 Axle, RA63 Axle, Front Axle, Rear Axle, Tuff-Cork	P18562TC	1	1959-1960, FA52 Axle, RA63 Axle, Front Axle, Rear Axle, Tuff-Cork	P18562TC	1
Axle Hsg Cover Gasket			B110		
Axle Hsg Cover Gasket			Axle Hsg Cover Gasket		
1957-1958, FA15 Axle, FA18 Axle, FA62 Axle, FA63 Axle, RA18 Axle, RA28 Axle, Front Axle, Rear Axle	P27768T	1	1959-1960, FA15 Axle, FA18 Axle, FA62 Axle, FA63 Axle, RA18 Axle, RA28 Axle, Front Axle, Rear Axle	P27768T	1
1957-1958, FA15 Axle, FA18 Axle, FA62 Axle, FA63 Axle, RA18 Axle, RA28 Axle, 10 Bolt Holes, Front Axle, Rear Axle, Tuff-Cork	P27768TC	1	1959-1960, FA15 Axle, FA18 Axle, FA62 Axle, FA63 Axle, RA18 Axle, RA28 Axle, 10 Bolt Holes, Front Axle, Rear Axle, Tuff-Cork	P27768TC	1
1957-1958, FA52 Axle, RA63 Axle, Front Axle, Rear Axle	P18562	1	1959-1960, FA52 Axle, RA63 Axle, Front Axle, Rear Axle	P18562	1
1957-1958, FA52 Axle, RA63 Axle, Front Axle, Rear Axle, Tuff-Cork	P18562TC	1	1959-1960, FA52 Axle, RA63 Axle, Front Axle, Rear Axle, Tuff-Cork	P18562TC	1
Axle Hsg Cover Gasket			B120		
Axle Hsg Cover Gasket			Axle Hsg Cover Gasket		
1957-1958, FA15 Axle, FA18 Axle, FA62 Axle, FA63 Axle, RA18 Axle, RA28 Axle, Front Axle, Rear Axle	P27768T	1	1959-1960, FA15 Axle, FA18 Axle, FA62 Axle, FA63 Axle, RA18 Axle, RA28 Axle, Front Axle, Rear Axle	P27768T	1
1957-1958, FA15 Axle, FA18 Axle, FA62 Axle, FA63 Axle, RA18 Axle, RA28 Axle, 10 Bolt Holes, Front Axle, Rear Axle, Tuff-Cork	P27768TC	1	1959-1960, FA15 Axle, FA18 Axle, FA62 Axle, FA63 Axle, RA18 Axle, RA28 Axle, 10 Bolt Holes, Front Axle, Rear Axle, Tuff-Cork	P27768TC	1
1957-1958, FA52 Axle, RA63 Axle, Front Axle, Rear Axle	P18562	1	1959-1960, FA52 Axle, RA63 Axle, Front Axle, Rear Axle	P18562	1
1957-1958, FA52 Axle, RA63 Axle, Front Axle, Rear Axle, Tuff-Cork	P18562TC	1	1959-1960, FA52 Axle, RA63 Axle, Front Axle, Rear Axle, Tuff-Cork	P18562TC	1

LIGHT TRUCK

Differential Housing Cover Gaskets (cont.)

<i>Model & Application</i>	<i>Part No.</i>	<i>Qty.</i>	<i>Model & Application</i>	<i>Part No.</i>	<i>Qty.</i>
B120 (cont.)			C1200		
Axle Hsg Cover Gasket (cont.)			Axle Hsg Cover Gasket		
1959-1960, FA52 Axle, RA63 Axle, Front Axle, Rear Axle, Tuff-Cork	P18562TC	1	1963-1964, FA15 Axle, FA18 Axle, FA25 Axle, FA45 Axle, Front Axle	P27768T	1
B130			1963-1964, FA15 Axle, FA18 Axle, FA25 Axle, FA45 Axle, 10 Bolt Holes, Front Axle, Tuff-Cork	P27768TC	1
Axle Hsg Cover Gasket			1963-1964, RA16 Axle, RA17 Axle, Rear Axle	P18562	1
1959-1960, FA15 Axle, FA18 Axle, FA62 Axle, FA63 Axle, RA18 Axle, RA28 Axle, Front Axle, Rear Axle	P27768T	1	1963-1964, RA16 Axle, RA17 Axle, Rear Axle, Tuff-Cork	P18562TC	1
1959-1960, FA15 Axle, FA18 Axle, FA62 Axle, FA63 Axle, RA18 Axle, RA28 Axle, 10 Bolt Holes, Front Axle, Rear Axle, Tuff-Cork	P27768TC	1	C130		
1959-1960, FA52 Axle, RA63 Axle, Front Axle, Rear Axle	P18562	1	Axle Hsg Cover Gasket		
1959-1960, FA52 Axle, RA63 Axle, Front Axle, Rear Axle, Tuff-Cork	P18562TC	1	1961-1962, FA15 Axle, FA18 Axle, FA62 Axle, FA63 Axle, RA18 Axle, RA28 Axle, Front Axle, Rear Axle	P27768T	1
1959-1960, RA184 Axle, 12 Bolt Holes, Rear Axle	P39196	1	1961-1962, FA15 Axle, FA18 Axle, FA62 Axle, FA63 Axle, RA18 Axle, RA28 Axle, 10 Bolt Holes, Front Axle, Rear Axle, Tuff-Cork	P27768TC	1
Diff. Carrier Gasket			1961-1962, FA52 Axle, RA63 Axle, Front Axle, Rear Axle	P18562	1
1959-1960, RA184 Axle, 12 Bolt Holes, Rear Axle	P29122	1	1961-1962, FA52 Axle, RA63 Axle, Front Axle, Rear Axle, Tuff-Cork	P18562TC	1
C110			1961-1962, RA184 Axle, 12 Bolt Holes, Rear Axle	P39196	1
Axle Hsg Cover Gasket			Diff. Carrier Gasket		
1961-1962, FA15 Axle, FA18 Axle, FA62 Axle, FA63 Axle, RA18 Axle, RA28 Axle, Front Axle, Rear Axle	P27768T	1	1961-1962, RA184 Axle, 12 Bolt Holes, Rear Axle	P29122	1
1961-1962, FA15 Axle, FA18 Axle, FA62 Axle, FA63 Axle, RA18 Axle, RA28 Axle, 10 Bolt Holes, Front Axle, Rear Axle, Tuff-Cork	P27768TC	1	C1300		
1961-1962, FA52 Axle, RA63 Axle, Front Axle, Rear Axle	P18562	1	Axle Hsg Cover Gasket		
1961-1962, FA52 Axle, RA63 Axle, Front Axle, Rear Axle, Tuff-Cork	P18562TC	1	1963-1964, FA52 Axle, RA63 Axle, Front Axle, Rear Axle	P18562	1
C1100			1963-1964, FA52 Axle, RA63 Axle, Front Axle, Rear Axle, Tuff-Cork	P18562TC	1
Axle Hsg Cover Gasket			CM75		
1963-1964, FA16 Axle, FA17 Axle, FA46 Axle, RA1 Axle, RA18 Axle, RA28 Axle, RA3 Axle, Front Axle, Rear Axle	P27768T	1	Axle Hsg Cover Gasket		
1963-1964, FA16 Axle, FA17 Axle, FA46 Axle, RA1 Axle, RA18 Axle, RA28 Axle, RA3 Axle, 10 Bolt Holes, Front Axle, Rear Axle, Tuff-Cork	P27768TC	1	1963-1965, RA14 Axle, RA4 Axle, Rear Axle	P27603	1
1963-1964, RA53 Axle, RA54 Axle, RA83 Axle, RA84 Axle, Rear Axle	P18562	1	1963-1965, RA23 Axle, RA9 Axle, Rear Axle	P27768T	1
1963-1964, RA53 Axle, RA54 Axle, RA83 Axle, RA84 Axle, Rear Axle, Tuff-Cork	P18562TC	1	1963-1965, RA23 Axle, RA9 Axle, 10 Bolt Holes, Rear Axle, Tuff-Cork	P27768TC	1
C120			CM80		
Axle Hsg Cover Gasket			Axle Hsg Cover Gasket		
1961-1962, FA15 Axle, FA18 Axle, FA62 Axle, FA63 Axle, RA18 Axle, RA28 Axle, Front Axle, Rear Axle	P27768T	1	1963-1965, RA14 Axle, RA4 Axle, Rear Axle	P27603	1
1961-1962, FA15 Axle, FA18 Axle, FA62 Axle, FA63 Axle, RA18 Axle, RA28 Axle, 10 Bolt Holes, Front Axle, Rear Axle, Tuff-Cork	P27768TC	1	1963-1965, RA23 Axle, RA9 Axle, Rear Axle	P27768T	1
1961-1962, FA52 Axle, RA63 Axle, Front Axle, Rear Axle	P18562	1	1963-1965, RA23 Axle, RA9 Axle, 10 Bolt Holes, Rear Axle, Tuff-Cork	P27768TC	1
1961-1962, FA52 Axle, RA63 Axle, Front Axle, Rear Axle, Tuff-Cork	P18562TC	1	D1100		
C1200			Axle Hsg Cover Gasket		
Axle Hsg Cover Gasket			1965, FA16 Axle, FA17 Axle, FA46 Axle, RA1 Axle, RA18 Axle, RA28 Axle, RA3 Axle, Front Axle, Rear Axle	P27768T	1
1963-1964, FA15 Axle, FA18 Axle, FA25 Axle, FA45 Axle, Front Axle	P27768T	1	1965, FA16 Axle, FA17 Axle, FA46 Axle, RA1 Axle, RA18 Axle, RA28 Axle, RA3 Axle, 10 Bolt Holes, Front Axle, Rear Axle, Tuff-Cork	P27768TC	1
1963-1964, FA15 Axle, FA18 Axle, FA25 Axle, FA45 Axle, 10 Bolt Holes, Front Axle, Tuff-Cork	P27768TC	1	1965, RA53 Axle, RA54 Axle, RA83 Axle, RA84 Axle, Rear Axle	P18562	1
1963-1964, RA16 Axle, RA17 Axle, Rear Axle	P18562	1			
1963-1964, RA16 Axle, RA17 Axle, Rear Axle, Tuff-Cork	P18562TC	1			

LIGHT TRUCK

Navistar/International (cont.)

Differential Housing Cover Gaskets (cont.)

<i>Model & Application</i>	<i>Part No.</i>	<i>Qty.</i>	<i>Model & Application</i>	<i>Part No.</i>	<i>Qty.</i>
D1100 (cont.)			R130		
Axle Hsg Cover Gasket (cont.)			Axle Hsg Cover Gasket		
1965, RA53 Axle, RA54 Axle, RA83 Axle, RA84 Axle, Rear Axle, Tuff-Cork	P18562TC	1	1953-1955, FA15 Axle, FA18 Axle, FA62 Axle, FA63 Axle, RA18 Axle, RA28 Axle, Front Axle, Rear Axle	P27768T	1
D1200			1953-1955, FA15 Axle, FA18 Axle, FA62 Axle, FA63 Axle, RA18 Axle, RA28 Axle, 10 Bolt Holes, Front Axle, Rear Axle, Tuff-Cork	P27768TC	1
Axle Hsg Cover Gasket			1953-1955, FA52 Axle, RA63 Axle, Front Axle, Rear Axle	P18562	1
1965, FA15 Axle, FA18 Axle, FA25 Axle, FA45 Axle, Front Axle	P27768T	1	1953-1955, FA52 Axle, RA63 Axle, Front Axle, Rear Axle, Tuff-Cork	P18562TC	1
1965, FA15 Axle, FA18 Axle, FA25 Axle, FA45 Axle, 10 Bolt Holes, Front Axle, Tuff-Cork	P27768TC	1	1953-1955, RA184 Axle, 12 Bolt Holes, Rear Axle	P39196	1
1965, RA16 Axle, RA17 Axle, Rear Axle	P18562	1	Diff. Carrier Gasket		
1965, RA16 Axle, RA17 Axle, Rear Axle, Tuff-Cork	P18562TC	1	1953-1955, RA184 Axle, 12 Bolt Holes, Rear Axle	P29122	1
D1300			S100		
Axle Hsg Cover Gasket			Axle Hsg Cover Gasket		
1965, FA52 Axle, RA63 Axle, Front Axle, Rear Axle	P18562	1	1956-1957, FA15 Axle, FA18 Axle, FA62 Axle, FA63 Axle, RA18 Axle, RA28 Axle, Front Axle, Rear Axle	P27768T	1
1965, FA52 Axle, RA63 Axle, Front Axle, Rear Axle, Tuff-Cork	P18562TC	1	1956-1957, FA15 Axle, FA18 Axle, FA62 Axle, FA63 Axle, RA18 Axle, RA28 Axle, 10 Bolt Holes, Front Axle, Rear Axle, Tuff-Cork	P27768TC	1
R100			1956-1957, FA52 Axle, RA63 Axle, Front Axle, Rear Axle	P18562	1
Axle Hsg Cover Gasket			1956-1957, FA52 Axle, RA63 Axle, Front Axle, Rear Axle, Tuff-Cork	P18562TC	1
1953-1955, FA15 Axle, FA18 Axle, FA62 Axle, FA63 Axle, RA18 Axle, RA28 Axle, Front Axle, Rear Axle	P27768T	1	S110		
1953-1955, FA15 Axle, FA18 Axle, FA62 Axle, FA63 Axle, RA18 Axle, RA28 Axle, 10 Bolt Holes, Front Axle, Rear Axle, Tuff-Cork	P27768TC	1	Axle Hsg Cover Gasket		
1953-1955, FA52 Axle, RA63 Axle, Front Axle, Rear Axle	P18562	1	1956-1957, FA15 Axle, FA18 Axle, FA62 Axle, FA63 Axle, RA18 Axle, RA28 Axle, Front Axle, Rear Axle	P27768T	1
1953-1955, FA52 Axle, RA63 Axle, Front Axle, Rear Axle, Tuff-Cork	P18562TC	1	1956-1957, FA15 Axle, FA18 Axle, FA62 Axle, FA63 Axle, RA18 Axle, RA28 Axle, 10 Bolt Holes, Front Axle, Rear Axle, Tuff-Cork	P27768TC	1
R110			1956-1957, FA52 Axle, RA63 Axle, Front Axle, Rear Axle	P18562	1
Axle Hsg Cover Gasket			1956-1957, FA52 Axle, RA63 Axle, Front Axle, Rear Axle, Tuff-Cork	P18562TC	1
1953-1955, FA15 Axle, FA18 Axle, FA62 Axle, FA63 Axle, RA18 Axle, RA28 Axle, Front Axle, Rear Axle	P27768T	1	S120		
1953-1955, FA15 Axle, FA18 Axle, FA62 Axle, FA63 Axle, RA18 Axle, RA28 Axle, 10 Bolt Holes, Front Axle, Rear Axle, Tuff-Cork	P27768TC	1	Axle Hsg Cover Gasket		
1953-1955, FA52 Axle, RA63 Axle, Front Axle, Rear Axle	P18562	1	1956-1957, FA15 Axle, FA18 Axle, FA62 Axle, FA63 Axle, RA18 Axle, RA28 Axle, Front Axle, Rear Axle	P27768T	1
1953-1955, FA52 Axle, RA63 Axle, Front Axle, Rear Axle, Tuff-Cork	P18562TC	1	1956-1957, FA15 Axle, FA18 Axle, FA62 Axle, FA63 Axle, RA18 Axle, RA28 Axle, 10 Bolt Holes, Front Axle, Rear Axle, Tuff-Cork	P27768TC	1
R120			1956-1957, FA52 Axle, RA63 Axle, Front Axle, Rear Axle	P18562	1
Axle Hsg Cover Gasket			1956-1957, FA52 Axle, RA63 Axle, Front Axle, Rear Axle, Tuff-Cork	P18562TC	1
1953-1955, FA15 Axle, FA18 Axle, FA62 Axle, FA63 Axle, RA18 Axle, RA28 Axle, Front Axle, Rear Axle	P27768T	1	S130		
1953-1955, FA15 Axle, FA18 Axle, FA62 Axle, FA63 Axle, RA18 Axle, RA28 Axle, 10 Bolt Holes, Front Axle, Rear Axle, Tuff-Cork	P27768TC	1	Axle Hsg Cover Gasket		
1953-1955, FA52 Axle, RA63 Axle, Front Axle, Rear Axle	P18562	1	1956-1957, FA15 Axle, FA18 Axle, FA62 Axle, FA63 Axle, RA18 Axle, RA28 Axle, Front Axle, Rear Axle	P27768T	1
1953-1955, FA52 Axle, RA63 Axle, Front Axle, Rear Axle, Tuff-Cork	P18562TC	1			

LIGHT TRUCK

Differential Housing Cover Gaskets (cont.)

<i>Model & Application</i>	<i>Part No.</i>	<i>Qty.</i>	<i>Model & Application</i>	<i>Part No.</i>	<i>Qty.</i>
S130 (cont.)			SCOUT XLC		
Axle Hsg Cover Gasket (cont.)			Axle Hsg Cover Gasket		
1956-1957, FA15 Axle, FA18 Axle, FA62 Axle, FA63 Axle, RA18 Axle, RA28 Axle, 10 Bolt Holes, Front Axle, Rear Axle, Tuff-Cork	P27768TC	1	1975-1980, FA11 Axle, FA13 Axle, FA14 Axle, FA21 Axle, FA24 Axle, RA14 Axle, RA4 Axle, Front Axle, Rear Axle	P27603	1
1956-1957, FA52 Axle, RA63 Axle, Front Axle, Rear Axle	P18562	1	1975-1980, FA43 Axle, FA44 Axle, RA18 Axle, RA23 Axle, RA28 Axle, RA9 Axle, Front Axle, Rear Axle	P27768T	1
1956-1957, FA52 Axle, RA63 Axle, Front Axle, Rear Axle, Tuff-Cork	P18562TC	1	1975-1980, FA43 Axle, FA44 Axle, RA18 Axle, RA23 Axle, RA28 Axle, RA9 Axle, 10 Bolt Holes, Front Axle, Rear Axle, Tuff-Cork	P27768TC	1
1956-1957, RA184 Axle, 12 Bolt Holes, Rear Axle	P39196	1	TRAVELALL 1110		
Diff. Carrier Gasket			Axle Hsg Cover Gasket		
1956-1957, RA184 Axle, 12 Bolt Holes, Rear Axle	P29122	1	1972-1973, FA16 Axle, FA17 Axle, FA46 Axle, RA1 Axle, RA18 Axle, RA28 Axle, RA3 Axle, Front Axle, Rear Axle	P27768T	1
SCOUT			1972-1973, FA16 Axle, FA17 Axle, FA46 Axle, RA1 Axle, RA18 Axle, RA28 Axle, RA3 Axle, 10 Bolt Holes, Front Axle, Rear Axle, Tuff-Cork	P27768TC	1
Axle Hsg Cover Gasket			1972-1973, RA53 Axle, RA54 Axle, RA83 Axle, RA84 Axle, Rear Axle	P18562	1
1961-1971, FA11 Axle, FA13 Axle, FA14 Axle, FA21 Axle, FA24 Axle, RA14 Axle, RA4 Axle, Front Axle, Rear Axle	P27603	1	1972-1973, RA53 Axle, RA54 Axle, RA83 Axle, RA84 Axle, Rear Axle, Tuff-Cork	P18562TC	1
1961-1971, FA43 Axle, FA44 Axle, RA18 Axle, RA23 Axle, RA28 Axle, RA9 Axle, Front Axle, Rear Axle	P27768T	1	TRAVELALL 1210		
1961-1971, FA43 Axle, FA44 Axle, RA18 Axle, RA23 Axle, RA28 Axle, RA9 Axle, 10 Bolt Holes, Front Axle, Rear Axle, Tuff-Cork	P27768TC	1	Axle Hsg Cover Gasket		
SCOUT II			1972-1973, FA15 Axle, FA18 Axle, FA25 Axle, FA45 Axle, Front Axle	P27768T	1
Axle Hsg Cover Gasket			1972-1973, FA15 Axle, FA18 Axle, FA25 Axle, FA45 Axle, 10 Bolt Holes, Front Axle, Tuff-Cork	P27768TC	1
1971-1974, FA11 Axle, FA13 Axle, FA14 Axle, FA21 Axle, FA24 Axle, RA14 Axle, RA4 Axle, Front Axle, Rear Axle	P27603	1	1972-1973, RA16 Axle, RA17 Axle, Rear Axle	P18562	1
1971-1974, FA43 Axle, FA44 Axle, RA18 Axle, RA23 Axle, RA28 Axle, RA9 Axle, Front Axle, Rear Axle	P27768T	1	1972-1973, RA16 Axle, RA17 Axle, Rear Axle, Tuff-Cork	P18562TC	1
1971-1974, FA43 Axle, FA44 Axle, RA18 Axle, RA23 Axle, RA28 Axle, RA9 Axle, 10 Bolt Holes, Front Axle, Rear Axle, Tuff-Cork	P27768TC	1			

Transmission Gaskets

<i>Model & Application</i>	<i>Part No.</i>	<i>Qty.</i>	<i>Model & Application</i>	<i>Part No.</i>	<i>Qty.</i>
100			1000A (cont.)		
P.T.O. Cover Gasket			P.T.O. Mounting Gasket (cont.)		
1974, 6 Bolt, Chelsea Power Take Off	H36080	1	1966, .010" Thickness, 8 Bolt, Chelsea Power Take Off	H26207	1
1974, 8 Bolt, Chelsea Power Take Off	H36124	1	1966, .020" Thickness, 6 Bolt, Chelsea Power Take Off	H26206	1
P.T.O. Mounting Gasket			1966, .020" Thickness, 8 Bolt, Chelsea Power Take Off	H26208	1
1974, .010" Thickness, 6 Bolt, Chelsea Power Take Off	H26205	1	1000B		
1974, .010" Thickness, 8 Bolt, Chelsea Power Take Off	H26207	1	P.T.O. Cover Gasket		
1974, .020" Thickness, 6 Bolt, Chelsea Power Take Off	H26206	1	1967, 6 Bolt, Chelsea Power Take Off	H36080	1
1974, .020" Thickness, 8 Bolt, Chelsea Power Take Off	H26208	1	1967, 8 Bolt, Chelsea Power Take Off	H36124	1
1000A			P.T.O. Mounting Gasket		
P.T.O. Cover Gasket			1967, .010" Thickness, 6 Bolt, Chelsea Power Take Off	H26205	1
1966, 6 Bolt, Chelsea Power Take Off	H36080	1	1967, .010" Thickness, 8 Bolt, Chelsea Power Take Off	H26207	1
1966, 8 Bolt, Chelsea Power Take Off	H36124	1	1967, .020" Thickness, 6 Bolt, Chelsea Power Take Off	H26206	1
P.T.O. Mounting Gasket					
1966, .010" Thickness, 6 Bolt, Chelsea Power Take Off	H26205	1			

LIGHT TRUCK

Navistar/International (cont.)

Transmission Gaskets (cont.)

<i>Model & Application</i>	<i>Part No.</i>	<i>Qty.</i>	<i>Model & Application</i>	<i>Part No.</i>	<i>Qty.</i>
1000B (cont.)			1100B		
P.T.O. Mounting Gasket (cont.)			P.T.O. Cover Gasket		
1967, .020" Thickness, 8 Bolt, Chelsea Power Take Off.	H26208	1	1967, 6 Bolt, Chelsea Power Take Off	H36080	1
			1967, 8 Bolt, Chelsea Power Take Off	H36124	1
1000C			P.T.O. Mounting Gasket		
P.T.O. Cover Gasket			1967, .010" Thickness, 6 Bolt, Chelsea Power Take Off.		
1968, 6 Bolt, Chelsea Power Take Off	H36080	1		H26205	1
1968, 8 Bolt, Chelsea Power Take Off	H36124	1	1967, .010" Thickness, 8 Bolt, Chelsea Power Take Off.	H26207	1
P.T.O. Mounting Gasket			1967, .020" Thickness, 6 Bolt, Chelsea Power Take Off.		
1968, .010" Thickness, 6 Bolt, Chelsea Power Take Off.	H26205	1		H26206	1
1968, .010" Thickness, 8 Bolt, Chelsea Power Take Off.	H26207	1	1967, .020" Thickness, 8 Bolt, Chelsea Power Take Off.	H26208	1
1968, .020" Thickness, 6 Bolt, Chelsea Power Take Off.	H26206	1	1100C		
1968, .020" Thickness, 8 Bolt, Chelsea Power Take Off.	H26208	1	P.T.O. Cover Gasket		
1000D			1968, 6 Bolt, Chelsea Power Take Off		
P.T.O. Cover Gasket				H36080	1
1969-1971, 6 Bolt, Chelsea Power Take Off	H36080	1	1968, 8 Bolt, Chelsea Power Take Off	H36124	1
1969-1971, 8 Bolt, Chelsea Power Take Off	H36124	1	P.T.O. Mounting Gasket		
P.T.O. Mounting Gasket			1968, .010" Thickness, 6 Bolt, Chelsea Power Take Off.		
1969-1971, .010" Thickness, 6 Bolt, Chelsea Power Take Off	H26205	1		H26205	1
1969-1971, .010" Thickness, 8 Bolt, Chelsea Power Take Off	H26207	1	1968, .010" Thickness, 8 Bolt, Chelsea Power Take Off.	H26207	1
1969-1971, .020" Thickness, 6 Bolt, Chelsea Power Take Off	H26206	1	1968, .020" Thickness, 6 Bolt, Chelsea Power Take Off.	H26206	1
1969-1971, .020" Thickness, 8 Bolt, Chelsea Power Take Off	H26208	1	1968, .020" Thickness, 8 Bolt, Chelsea Power Take Off.	H26208	1
Transmission Pan Gasket			1100D		
1971, T407 Transmission	W39003	1	P.T.O. Cover Gasket		
1971, T407 Transmission, Tuff-Cork	W39003TC	1	1969-1971, 6 Bolt, Chelsea Power Take Off		
1010				H36080	1
P.T.O. Cover Gasket			1969-1971, 8 Bolt, Chelsea Power Take Off		
1973, 6 Bolt, Chelsea Power Take Off	H36080	1		H36124	1
1973, 8 Bolt, Chelsea Power Take Off	H36124	1	P.T.O. Mounting Gasket		
P.T.O. Mounting Gasket			1969-1971, .010" Thickness, 6 Bolt, Chelsea Power Take Off		
1973, .010" Thickness, 6 Bolt, Chelsea Power Take Off.	H26205	1		H26205	1
1973, .010" Thickness, 8 Bolt, Chelsea Power Take Off.	H26207	1	1969-1971, .010" Thickness, 8 Bolt, Chelsea Power Take Off	H26207	1
1973, .020" Thickness, 6 Bolt, Chelsea Power Take Off.	H26206	1	1969-1971, .020" Thickness, 6 Bolt, Chelsea Power Take Off	H26206	1
1973, .020" Thickness, 8 Bolt, Chelsea Power Take Off.	H26208	1	1969-1971, .020" Thickness, 8 Bolt, Chelsea Power Take Off	H26208	1
Transmission Pan Gasket			Transmission Pan Gasket		
1973, T407 Transmission	W39003	1	1971, T407 Transmission	W39003	1
1973, T407 Transmission, Tuff-Cork	W39003TC	1	1971, T407 Transmission, Tuff-Cork	W39003TC	1
1100A			1110		
P.T.O. Cover Gasket			P.T.O. Cover Gasket		
1966, 6 Bolt, Chelsea Power Take Off	H36080	1	1972-1973, 6 Bolt, Chelsea Power Take Off		
1966, 8 Bolt, Chelsea Power Take Off	H36124	1		H36080	1
P.T.O. Mounting Gasket			1972-1973, 8 Bolt, Chelsea Power Take Off		
1966, .010" Thickness, 6 Bolt, Chelsea Power Take Off.	H26205	1		H36124	1
1966, .010" Thickness, 8 Bolt, Chelsea Power Take Off.	H26207	1	P.T.O. Mounting Gasket		
1966, .020" Thickness, 6 Bolt, Chelsea Power Take Off.	H26206	1	1972-1973, .010" Thickness, 6 Bolt, Chelsea Power Take Off		
1966, .020" Thickness, 8 Bolt, Chelsea Power Take Off.	H26208	1		H26205	1
Transmission Pan Gasket			1972-1973, .010" Thickness, 8 Bolt, Chelsea Power Take Off		
1972-1973, T407 Transmission	W39003	1		H26207	1
1972-1973, T407 Transmission, Tuff-Cork	W39003TC	1	1972-1973, .020" Thickness, 6 Bolt, Chelsea Power Take Off	H26206	1
1200A			1972-1973, .020" Thickness, 8 Bolt, Chelsea Power Take Off		
P.T.O. Cover Gasket				H26208	1
1966, 6 Bolt, Chelsea Power Take Off	H36080	1	Transmission Pan Gasket		
1966, 8 Bolt, Chelsea Power Take Off	H36124	1	1972-1973, T407 Transmission		
1172				W39003	1
			1972-1973, T407 Transmission, Tuff-Cork		
				W39003TC	1

LIGHT TRUCK

Transmission Gaskets (cont.)				
Model & Application	Part No.	Qty.	Model & Application	Part No. Qty.
1200A (cont.)			1210 (cont.)	
P.T.O. Mounting Gasket			P.T.O. Mounting Gasket (cont.)	
1966, .010" Thickness, 6 Bolt, Chelsea Power Take Off	H26205	1	1972-1973, .020" Thickness, 8 Bolt, Chelsea Power Take Off	H26208 1
1966, .010" Thickness, 8 Bolt, Chelsea Power Take Off	H26207	1	Transmission Pan Gasket	
1966, .020" Thickness, 6 Bolt, Chelsea Power Take Off	H26206	1	1972-1973, T407 Transmission	W39003 1
1966, .020" Thickness, 8 Bolt, Chelsea Power Take Off	H26208	1	1972-1973, T407 Transmission, Tuff-Cork	W39003TC 1
1200B			1300A	
P.T.O. Cover Gasket			P.T.O. Cover Gasket	
1967, 6 Bolt, Chelsea Power Take Off	H36080	1	1966, 6 Bolt, Chelsea Power Take Off	H36080 1
1967, 8 Bolt, Chelsea Power Take Off	H36124	1	1966, 8 Bolt, Chelsea Power Take Off	H36124 1
P.T.O. Mounting Gasket			P.T.O. Mounting Gasket	
1967, .010" Thickness, 6 Bolt, Chelsea Power Take Off	H26205	1	1966, .010" Thickness, 6 Bolt, Chelsea Power Take Off	H26205 1
1967, .010" Thickness, 8 Bolt, Chelsea Power Take Off	H26207	1	1966, .010" Thickness, 8 Bolt, Chelsea Power Take Off	H26207 1
1967, .020" Thickness, 6 Bolt, Chelsea Power Take Off	H26206	1	1966, .020" Thickness, 6 Bolt, Chelsea Power Take Off	H26206 1
1967, .020" Thickness, 8 Bolt, Chelsea Power Take Off	H26208	1	1966, .020" Thickness, 8 Bolt, Chelsea Power Take Off	H26208 1
1200C			1300B	
P.T.O. Cover Gasket			P.T.O. Cover Gasket	
1968, 6 Bolt, Chelsea Power Take Off	H36080	1	1967, 6 Bolt, Chelsea Power Take Off	H36080 1
1968, 8 Bolt, Chelsea Power Take Off	H36124	1	1967, 8 Bolt, Chelsea Power Take Off	H36124 1
P.T.O. Mounting Gasket			P.T.O. Mounting Gasket	
1968, .010" Thickness, 6 Bolt, Chelsea Power Take Off	H26205	1	1967, .010" Thickness, 6 Bolt, Chelsea Power Take Off	H26205 1
1968, .010" Thickness, 8 Bolt, Chelsea Power Take Off	H26207	1	1967, .010" Thickness, 8 Bolt, Chelsea Power Take Off	H26207 1
1968, .020" Thickness, 6 Bolt, Chelsea Power Take Off	H26206	1	1967, .020" Thickness, 6 Bolt, Chelsea Power Take Off	H26206 1
1968, .020" Thickness, 8 Bolt, Chelsea Power Take Off	H26208	1	1967, .020" Thickness, 8 Bolt, Chelsea Power Take Off	H26208 1
1200D			1300C	
P.T.O. Cover Gasket			P.T.O. Cover Gasket	
1969-1971, 6 Bolt, Chelsea Power Take Off	H36080	1	1968, 6 Bolt, Chelsea Power Take Off	H36080 1
1969-1971, 8 Bolt, Chelsea Power Take Off	H36124	1	1968, 8 Bolt, Chelsea Power Take Off	H36124 1
P.T.O. Mounting Gasket			P.T.O. Mounting Gasket	
1969-1971, .010" Thickness, 6 Bolt, Chelsea Power Take Off	H26205	1	1968, .010" Thickness, 6 Bolt, Chelsea Power Take Off	H26205 1
1969-1971, .010" Thickness, 8 Bolt, Chelsea Power Take Off	H26207	1	1968, .010" Thickness, 8 Bolt, Chelsea Power Take Off	H26207 1
1969-1971, .020" Thickness, 6 Bolt, Chelsea Power Take Off	H26206	1	1968, .020" Thickness, 6 Bolt, Chelsea Power Take Off	H26206 1
1969-1971, .020" Thickness, 8 Bolt, Chelsea Power Take Off	H26208	1	1968, .020" Thickness, 8 Bolt, Chelsea Power Take Off	H26208 1
Transmission Pan Gasket			1300D	
1971, T407 Transmission	W39003	1	P.T.O. Cover Gasket	
1971, T407 Transmission, Tuff-Cork	W39003TC	1	1969-1971, 6 Bolt, Chelsea Power Take Off	H36080 1
1210			1969-1971, 8 Bolt, Chelsea Power Take Off	
P.T.O. Cover Gasket			H36124 1	
1972-1973, 6 Bolt, Chelsea Power Take Off	H36080	1	P.T.O. Mounting Gasket	
1972-1973, 8 Bolt, Chelsea Power Take Off	H36124	1	1969-1971, .010" Thickness, 6 Bolt, Chelsea Power Take Off	H26205 1
P.T.O. Mounting Gasket			1969-1971, .010" Thickness, 8 Bolt, Chelsea Power Take Off	
1972-1973, .010" Thickness, 6 Bolt, Chelsea Power Take Off	H26205	1	H26207 1	
1972-1973, .010" Thickness, 8 Bolt, Chelsea Power Take Off	H26207	1	1969-1971, .020" Thickness, 6 Bolt, Chelsea Power Take Off	
1972-1973, .020" Thickness, 6 Bolt, Chelsea Power Take Off	H26206	1	H26206 1	
1972-1973, .020" Thickness, 8 Bolt, Chelsea Power Take Off	H26208	1	1969-1971, .020" Thickness, 8 Bolt, Chelsea Power Take Off	
Transmission Pan Gasket			H26208 1	
1971, T407 Transmission	W39003	1	1300D	
1971, T407 Transmission, Tuff-Cork	W39003TC	1	P.T.O. Cover Gasket	

Navistar/International (cont.)

Transmission Gaskets (cont.)

<i>Model & Application</i>	<i>Part No.</i>	<i>Qty.</i>	<i>Model & Application</i>	<i>Part No.</i>	<i>Qty.</i>
1310			908B (cont.)		
P.T.O. Cover Gasket			P.T.O. Mounting Gasket		
1972-1973, 6 Bolt, Chelsea Power Take Off . . .	H36080	1	1967, .010" Thickness, 6 Bolt, Chelsea Power Take Off	H26205	1
1972-1973, 8 Bolt, Chelsea Power Take Off . . .	H36124	1	1967, .010" Thickness, 8 Bolt, Chelsea Power Take Off	H26207	1
P.T.O. Mounting Gasket			1967, .020" Thickness, 6 Bolt, Chelsea Power Take Off	H26206	1
1972-1973, .010" Thickness, 6 Bolt, Chelsea Power Take Off	H26205	1	1967, .020" Thickness, 8 Bolt, Chelsea Power Take Off	H26208	1
1972-1973, .010" Thickness, 8 Bolt, Chelsea Power Take Off	H26207	1	908C		
1972-1973, .020" Thickness, 6 Bolt, Chelsea Power Take Off	H26206	1	P.T.O. Cover Gasket		
1972-1973, .020" Thickness, 8 Bolt, Chelsea Power Take Off	H26208	1	1968, 6 Bolt, Chelsea Power Take Off	H36080	1
Transmission Pan Gasket			1968, 8 Bolt, Chelsea Power Take Off	H36124	1
1972-1973, T407 Transmission	W39003	1	P.T.O. Mounting Gasket		
1972-1973, T407 Transmission, Tuff-Cork . . .	W39003TC	1	1968, .010" Thickness, 6 Bolt, Chelsea Power Take Off	H26205	1
150			1968, .010" Thickness, 8 Bolt, Chelsea Power Take Off	H26207	1
P.T.O. Cover Gasket			1968, .020" Thickness, 6 Bolt, Chelsea Power Take Off	H26206	1
1975, 6 Bolt, Chelsea Power Take Off	H36080	1	1968, .020" Thickness, 8 Bolt, Chelsea Power Take Off	H26208	1
1975, 8 Bolt, Chelsea Power Take Off	H36124	1	A100		
P.T.O. Mounting Gasket			P.T.O. Cover Gasket		
1975, .010" Thickness, 6 Bolt, Chelsea Power Take Off	H26205	1	1957-1958, 6 Bolt, Chelsea Power Take Off . . .	H36080	1
1975, .010" Thickness, 8 Bolt, Chelsea Power Take Off	H26207	1	1957-1958, 8 Bolt, Chelsea Power Take Off . . .	H36124	1
1975, .020" Thickness, 6 Bolt, Chelsea Power Take Off	H26206	1	P.T.O. Mounting Gasket		
1975, .020" Thickness, 8 Bolt, Chelsea Power Take Off	H26208	1	1957-1958, .010" Thickness, 6 Bolt, Chelsea Power Take Off	H26205	1
Transmission Pan Gasket			1957-1958, .010" Thickness, 8 Bolt, Chelsea Power Take Off	H26207	1
1975, T407 Transmission	W39003	1	1957-1958, .020" Thickness, 6 Bolt, Chelsea Power Take Off	H26206	1
1975, T407 Transmission, Tuff-Cork	W39003TC	1	1957-1958, .020" Thickness, 8 Bolt, Chelsea Power Take Off	H26208	1
200			A110		
P.T.O. Cover Gasket			P.T.O. Cover Gasket		
1974-1975, 6 Bolt, Chelsea Power Take Off . . .	H36080	1	1957-1958, 6 Bolt, Chelsea Power Take Off . . .	H36080	1
1974-1975, 8 Bolt, Chelsea Power Take Off . . .	H36124	1	1957-1958, 8 Bolt, Chelsea Power Take Off . . .	H36124	1
P.T.O. Mounting Gasket			P.T.O. Mounting Gasket		
1974-1975, .010" Thickness, 6 Bolt, Chelsea Power Take Off	H26205	1	1957-1958, .010" Thickness, 6 Bolt, Chelsea Power Take Off	H26205	1
1974-1975, .010" Thickness, 8 Bolt, Chelsea Power Take Off	H26207	1	1957-1958, .010" Thickness, 8 Bolt, Chelsea Power Take Off	H26207	1
1974-1975, .020" Thickness, 6 Bolt, Chelsea Power Take Off	H26206	1	1957-1958, .020" Thickness, 6 Bolt, Chelsea Power Take Off	H26206	1
1974-1975, .020" Thickness, 8 Bolt, Chelsea Power Take Off	H26208	1	1957-1958, .020" Thickness, 8 Bolt, Chelsea Power Take Off	H26208	1
900A			A120		
P.T.O. Cover Gasket			P.T.O. Cover Gasket		
1966-1967, 6 Bolt, Chelsea Power Take Off . . .	H36080	1	1957-1958, 6 Bolt, Chelsea Power Take Off . . .	H36080	1
1966-1967, 8 Bolt, Chelsea Power Take Off . . .	H36124	1	1957-1958, 8 Bolt, Chelsea Power Take Off . . .	H36124	1
P.T.O. Mounting Gasket			P.T.O. Mounting Gasket		
1966-1967, .010" Thickness, 6 Bolt, Chelsea Power Take Off	H26205	1	1957-1958, .010" Thickness, 6 Bolt, Chelsea Power Take Off	H26205	1
1966-1967, .010" Thickness, 8 Bolt, Chelsea Power Take Off	H26207	1	1957-1958, .010" Thickness, 8 Bolt, Chelsea Power Take Off	H26207	1
1966-1967, .020" Thickness, 6 Bolt, Chelsea Power Take Off	H26206	1	1957-1958, .020" Thickness, 6 Bolt, Chelsea Power Take Off	H26206	1
1966-1967, .020" Thickness, 8 Bolt, Chelsea Power Take Off	H26208	1	1957-1958, .020" Thickness, 8 Bolt, Chelsea Power Take Off	H26208	1
908B			P.T.O. Cover Gasket		
P.T.O. Cover Gasket			1957-1958, 6 Bolt, Chelsea Power Take Off . . .	H36080	1
1967, 6 Bolt, Chelsea Power Take Off	H36080	1	1957-1958, 8 Bolt, Chelsea Power Take Off . . .	H36124	1
1967, 8 Bolt, Chelsea Power Take Off	H36124	1	P.T.O. Mounting Gasket		
			1957-1958, .010" Thickness, 6 Bolt, Chelsea Power Take Off	H26205	1
			1957-1958, .010" Thickness, 8 Bolt, Chelsea Power Take Off	H26207	1
			1957-1958, .020" Thickness, 6 Bolt, Chelsea Power Take Off	H26206	1
			1957-1958, .020" Thickness, 8 Bolt, Chelsea Power Take Off	H26208	1

LIGHT TRUCK

Transmission Gaskets (cont.)				
Model & Application	Part No.	Qty.	Model & Application	Part No. Qty.
A130			AM80 (cont.)	
P.T.O. Cover Gasket			P.T.O. Mounting Gasket (cont.)	
1957-1958, 6 Bolt, Chelsea Power Take Off . . .	H36080	1	1957-1962, .020" Thickness, 8 Bolt, Chelsea Power Take Off	H26208 1
1957-1958, 8 Bolt, Chelsea Power Take Off . . .	H36124	1		
P.T.O. Mounting Gasket			B100	
1957-1958, .010" Thickness, 6 Bolt, Chelsea Power Take Off	H26205	1	P.T.O. Cover Gasket	
1957-1958, .010" Thickness, 8 Bolt, Chelsea Power Take Off	H26207	1	1959-1960, 6 Bolt, Chelsea Power Take Off . . .	H36080 1
1957-1958, .020" Thickness, 6 Bolt, Chelsea Power Take Off	H26206	1	1959-1960, 8 Bolt, Chelsea Power Take Off . . .	H36124 1
1957-1958, .020" Thickness, 8 Bolt, Chelsea Power Take Off	H26208	1	P.T.O. Mounting Gasket	
			1959-1960, .010" Thickness, 6 Bolt, Chelsea Power Take Off	H26205 1
			1959-1960, .010" Thickness, 8 Bolt, Chelsea Power Take Off	H26207 1
			1959-1960, .020" Thickness, 6 Bolt, Chelsea Power Take Off	H26206 1
			1959-1960, .020" Thickness, 8 Bolt, Chelsea Power Take Off	H26208 1
AB120			B110	
P.T.O. Cover Gasket			P.T.O. Cover Gasket	
1957-1965, 6 Bolt, Chelsea Power Take Off . . .	H36080	1	1959-1960, 6 Bolt, Chelsea Power Take Off . . .	H36080 1
1957-1965, 8 Bolt, Chelsea Power Take Off . . .	H36124	1	1959-1960, 8 Bolt, Chelsea Power Take Off . . .	H36124 1
P.T.O. Mounting Gasket			P.T.O. Mounting Gasket	
1957-1965, .010" Thickness, 6 Bolt, Chelsea Power Take Off	H26205	1	1959-1960, .010" Thickness, 6 Bolt, Chelsea Power Take Off	H26205 1
1957-1965, .010" Thickness, 8 Bolt, Chelsea Power Take Off	H26207	1	1959-1960, .010" Thickness, 8 Bolt, Chelsea Power Take Off	H26207 1
1957-1965, .020" Thickness, 6 Bolt, Chelsea Power Take Off	H26206	1	1959-1960, .020" Thickness, 6 Bolt, Chelsea Power Take Off	H26206 1
1957-1965, .020" Thickness, 8 Bolt, Chelsea Power Take Off	H26208	1	1959-1960, .020" Thickness, 8 Bolt, Chelsea Power Take Off	H26208 1
AM120			B120	
P.T.O. Cover Gasket			P.T.O. Cover Gasket	
1957-1965, 6 Bolt, Chelsea Power Take Off . . .	H36080	1	1959-1960, 6 Bolt, Chelsea Power Take Off . . .	H36080 1
1957-1965, 8 Bolt, Chelsea Power Take Off . . .	H36124	1	1959-1960, 8 Bolt, Chelsea Power Take Off . . .	H36124 1
P.T.O. Mounting Gasket			P.T.O. Mounting Gasket	
1957-1965, .010" Thickness, 6 Bolt, Chelsea Power Take Off	H26205	1	1959-1960, .010" Thickness, 6 Bolt, Chelsea Power Take Off	H26205 1
1957-1965, .010" Thickness, 8 Bolt, Chelsea Power Take Off	H26207	1	1959-1960, .010" Thickness, 8 Bolt, Chelsea Power Take Off	H26207 1
1957-1965, .020" Thickness, 6 Bolt, Chelsea Power Take Off	H26206	1	1959-1960, .020" Thickness, 6 Bolt, Chelsea Power Take Off	H26206 1
1957-1965, .020" Thickness, 8 Bolt, Chelsea Power Take Off	H26208	1	1959-1960, .020" Thickness, 8 Bolt, Chelsea Power Take Off	H26208 1
AM130			B130	
P.T.O. Cover Gasket			P.T.O. Cover Gasket	
1957-1965, 6 Bolt, Chelsea Power Take Off . . .	H36080	1	1959-1960, 6 Bolt, Chelsea Power Take Off . . .	H36080 1
1957-1965, 8 Bolt, Chelsea Power Take Off . . .	H36124	1	1959-1960, 8 Bolt, Chelsea Power Take Off . . .	H36124 1
P.T.O. Mounting Gasket			P.T.O. Mounting Gasket	
1957-1965, .010" Thickness, 6 Bolt, Chelsea Power Take Off	H26205	1	1959-1960, .010" Thickness, 6 Bolt, Chelsea Power Take Off	H26205 1
1957-1965, .010" Thickness, 8 Bolt, Chelsea Power Take Off	H26207	1	1959-1960, .010" Thickness, 8 Bolt, Chelsea Power Take Off	H26207 1
1957-1965, .020" Thickness, 6 Bolt, Chelsea Power Take Off	H26206	1	1959-1960, .020" Thickness, 6 Bolt, Chelsea Power Take Off	H26206 1
1957-1965, .020" Thickness, 8 Bolt, Chelsea Power Take Off	H26208	1	1959-1960, .020" Thickness, 8 Bolt, Chelsea Power Take Off	H26208 1
AM80			C1	
P.T.O. Cover Gasket			P.T.O. Cover Gasket	
1957-1962, 6 Bolt, Chelsea Power Take Off . . .	H36080	1	1936-1937, 6 Bolt, Chelsea Power Take Off . . .	H36080 1
1957-1962, 8 Bolt, Chelsea Power Take Off . . .	H36124	1	1936-1937, 8 Bolt, Chelsea Power Take Off . . .	H36124 1
P.T.O. Mounting Gasket				
1957-1962, .010" Thickness, 6 Bolt, Chelsea Power Take Off	H26205	1		
1957-1962, .010" Thickness, 8 Bolt, Chelsea Power Take Off	H26207	1		
1957-1962, .020" Thickness, 6 Bolt, Chelsea Power Take Off	H26206	1		
1957-1962, .020" Thickness, 8 Bolt, Chelsea Power Take Off	H26208	1		

Navistar/International (cont.)

Transmission Gaskets (cont.)

<i>Model & Application</i>	<i>Part No.</i>	<i>Qty.</i>	<i>Model & Application</i>	<i>Part No.</i>	<i>Qty.</i>
C1 (cont.)			C1100 (cont.)		
P.T.O. Mounting Gasket			P.T.O. Mounting Gasket (cont.)		
1936-1937, .010" Thickness, 6 Bolt, Chelsea Power Take Off	H26205	1	1963-1964, .020" Thickness, 8 Bolt, Chelsea Power Take Off	H26208	1
1936-1937, .010" Thickness, 8 Bolt, Chelsea Power Take Off	H26207	1	C12		
1936-1937, .020" Thickness, 6 Bolt, Chelsea Power Take Off	H26206	1	P.T.O. Cover Gasket		
1936-1937, .020" Thickness, 8 Bolt, Chelsea Power Take Off	H26208	1	1936, 6 Bolt, Chelsea Power Take Off	H36080	1
C100			1936, 8 Bolt, Chelsea Power Take Off	H36124	1
P.T.O. Cover Gasket			P.T.O. Mounting Gasket		
1961-1962, 6 Bolt, Chelsea Power Take Off	H36080	1	1936, .010" Thickness, 6 Bolt, Chelsea Power Take Off	H26205	1
1961-1962, 8 Bolt, Chelsea Power Take Off	H36124	1	1936, .010" Thickness, 8 Bolt, Chelsea Power Take Off	H26207	1
P.T.O. Mounting Gasket			1936, .020" Thickness, 6 Bolt, Chelsea Power Take Off	H26206	1
1961-1962, .010" Thickness, 6 Bolt, Chelsea Power Take Off	H26205	1	1936, .020" Thickness, 8 Bolt, Chelsea Power Take Off	H26208	1
1961-1962, .010" Thickness, 8 Bolt, Chelsea Power Take Off	H26207	1	C120		
1961-1962, .020" Thickness, 6 Bolt, Chelsea Power Take Off	H26206	1	P.T.O. Cover Gasket		
1961-1962, .020" Thickness, 8 Bolt, Chelsea Power Take Off	H26208	1	1961-1962, 6 Bolt, Chelsea Power Take Off	H36080	1
C1000			1961-1962, 8 Bolt, Chelsea Power Take Off	H36124	1
Elec. Shift Cover Gasket			P.T.O. Mounting Gasket		
1963-1964, 10 Bolt, Eaton 2 Speed Axle	H36328	1	1961-1962, .010" Thickness, 6 Bolt, Chelsea Power Take Off	H26205	1
1963-1964, 11 Bolt, Eaton 2 Speed Axle	H36329	1	1961-1962, .010" Thickness, 8 Bolt, Chelsea Power Take Off	H26207	1
P.T.O. Cover Gasket			1961-1962, .020" Thickness, 6 Bolt, Chelsea Power Take Off	H26206	1
1963-1964, 6 Bolt, Chelsea Power Take Off	H36080	1	1961-1962, .020" Thickness, 8 Bolt, Chelsea Power Take Off	H26208	1
1963-1964, 8 Bolt, Chelsea Power Take Off	H36124	1	C1200		
P.T.O. Mounting Gasket			P.T.O. Cover Gasket		
1963-1964, .010" Thickness, 6 Bolt, Chelsea Power Take Off	H26205	1	1963-1964, 6 Bolt, Chelsea Power Take Off	H36080	1
1963-1964, .010" Thickness, 8 Bolt, Chelsea Power Take Off	H26207	1	1963-1964, 8 Bolt, Chelsea Power Take Off	H36124	1
1963-1964, .020" Thickness, 6 Bolt, Chelsea Power Take Off	H26206	1	P.T.O. Mounting Gasket		
1963-1964, .020" Thickness, 8 Bolt, Chelsea Power Take Off	H26208	1	1963-1964, .010" Thickness, 6 Bolt, Chelsea Power Take Off	H26205	1
C110			1963-1964, .010" Thickness, 8 Bolt, Chelsea Power Take Off	H26207	1
P.T.O. Cover Gasket			1963-1964, .020" Thickness, 6 Bolt, Chelsea Power Take Off	H26206	1
1961-1962, 6 Bolt, Chelsea Power Take Off	H36080	1	1963-1964, .020" Thickness, 8 Bolt, Chelsea Power Take Off	H26208	1
1961-1962, 8 Bolt, Chelsea Power Take Off	H36124	1	C130		
P.T.O. Mounting Gasket			P.T.O. Cover Gasket		
1961-1962, .010" Thickness, 6 Bolt, Chelsea Power Take Off	H26205	1	1961-1962, 6 Bolt, Chelsea Power Take Off	H36080	1
1961-1962, .010" Thickness, 8 Bolt, Chelsea Power Take Off	H26207	1	1961-1962, 8 Bolt, Chelsea Power Take Off	H36124	1
1961-1962, .020" Thickness, 6 Bolt, Chelsea Power Take Off	H26206	1	P.T.O. Mounting Gasket		
1961-1962, .020" Thickness, 8 Bolt, Chelsea Power Take Off	H26208	1	1961-1962, .010" Thickness, 6 Bolt, Chelsea Power Take Off	H26205	1
C1100			1961-1962, .010" Thickness, 8 Bolt, Chelsea Power Take Off	H26207	1
P.T.O. Cover Gasket			1961-1962, .020" Thickness, 6 Bolt, Chelsea Power Take Off	H26206	1
1963-1964, 6 Bolt, Chelsea Power Take Off	H36080	1	1961-1962, .020" Thickness, 8 Bolt, Chelsea Power Take Off	H26208	1
1963-1964, 8 Bolt, Chelsea Power Take Off	H36124	1	C1300		
P.T.O. Mounting Gasket			P.T.O. Cover Gasket		
1963-1964, .010" Thickness, 6 Bolt, Chelsea Power Take Off	H26205	1	1963-1964, 6 Bolt, Chelsea Power Take Off	H36080	1
1963-1964, .010" Thickness, 8 Bolt, Chelsea Power Take Off	H26207	1	1963-1964, 8 Bolt, Chelsea Power Take Off	H36124	1
1963-1964, .020" Thickness, 6 Bolt, Chelsea Power Take Off	H26206	1			
1963-1964, .020" Thickness, 8 Bolt, Chelsea Power Take Off	H26208	1			

LIGHT TRUCK

Transmission Gaskets (cont.)

<i>Model & Application</i>	<i>Part No.</i>	<i>Qty.</i>	<i>Model & Application</i>	<i>Part No.</i>	<i>Qty.</i>
C1300 (cont.)			CM110 (cont.)		
P.T.O. Mounting Gasket			P.T.O. Mounting Gasket (cont.)		
1963-1964, .010" Thickness, 6 Bolt, Chelsea Power Take Off	H26205	1	1963-1965, .010" Thickness, 8 Bolt, Chelsea Power Take Off	H26207	1
1963-1964, .010" Thickness, 8 Bolt, Chelsea Power Take Off	H26207	1	1963-1965, .020" Thickness, 6 Bolt, Chelsea Power Take Off	H26206	1
1963-1964, .020" Thickness, 6 Bolt, Chelsea Power Take Off	H26206	1	1963-1965, .020" Thickness, 8 Bolt, Chelsea Power Take Off	H26208	1
1963-1964, .020" Thickness, 8 Bolt, Chelsea Power Take Off	H26208	1			
C15			CM112		
P.T.O. Cover Gasket			P.T.O. Cover Gasket		
1936-1937, 6 Bolt, Chelsea Power Take Off	H36080	1	1963, 6 Bolt, Chelsea Power Take Off	H36080	1
1936-1937, 8 Bolt, Chelsea Power Take Off	H36124	1	1963, 8 Bolt, Chelsea Power Take Off	H36124	1
P.T.O. Mounting Gasket			P.T.O. Mounting Gasket		
1936-1937, .010" Thickness, 6 Bolt, Chelsea Power Take Off	H26205	1	1963, .010" Thickness, 6 Bolt, Chelsea Power Take Off	H26205	1
1936-1937, .010" Thickness, 8 Bolt, Chelsea Power Take Off	H26207	1	1963, .010" Thickness, 8 Bolt, Chelsea Power Take Off	H26207	1
1936-1937, .020" Thickness, 6 Bolt, Chelsea Power Take Off	H26206	1	1963, .020" Thickness, 6 Bolt, Chelsea Power Take Off	H26206	1
1936-1937, .020" Thickness, 8 Bolt, Chelsea Power Take Off	H26208	1	1963, .020" Thickness, 8 Bolt, Chelsea Power Take Off	H26208	1
C5			CM75		
P.T.O. Cover Gasket			P.T.O. Cover Gasket		
1936-1937, 6 Bolt, Chelsea Power Take Off	H36080	1	1963-1965, 6 Bolt, Chelsea Power Take Off	H36080	1
1936-1937, 8 Bolt, Chelsea Power Take Off	H36124	1	1963-1965, 8 Bolt, Chelsea Power Take Off	H36124	1
P.T.O. Mounting Gasket			P.T.O. Mounting Gasket		
1936-1937, .010" Thickness, 6 Bolt, Chelsea Power Take Off	H26205	1	1963-1965, .010" Thickness, 6 Bolt, Chelsea Power Take Off	H26205	1
1936-1937, .010" Thickness, 8 Bolt, Chelsea Power Take Off	H26207	1	1963-1965, .010" Thickness, 8 Bolt, Chelsea Power Take Off	H26207	1
1936-1937, .020" Thickness, 6 Bolt, Chelsea Power Take Off	H26206	1	1963-1965, .020" Thickness, 6 Bolt, Chelsea Power Take Off	H26206	1
1936-1937, .020" Thickness, 8 Bolt, Chelsea Power Take Off	H26208	1	1963-1965, .020" Thickness, 8 Bolt, Chelsea Power Take Off	H26208	1
C900			CM80		
Elec. Shift Cover Gasket			P.T.O. Cover Gasket		
1964, 10 Bolt, Eaton 2 Speed Axle	H36328	1	1963-1965, 6 Bolt, Chelsea Power Take Off	H36080	1
1964, 11 Bolt, Eaton 2 Speed Axle	H36329	1	1963-1965, 8 Bolt, Chelsea Power Take Off	H36124	1
P.T.O. Cover Gasket			P.T.O. Mounting Gasket		
1964, 6 Bolt, Chelsea Power Take Off	H36080	1	1963-1965, .010" Thickness, 6 Bolt, Chelsea Power Take Off	H26205	1
1964, 8 Bolt, Chelsea Power Take Off	H36124	1	1963-1965, .010" Thickness, 8 Bolt, Chelsea Power Take Off	H26207	1
P.T.O. Mounting Gasket			P.T.O. Mounting Gasket		
1964, .010" Thickness, 6 Bolt, Chelsea Power Take Off	H26205	1	1963-1965, .020" Thickness, 6 Bolt, Chelsea Power Take Off	H26206	1
1964, .010" Thickness, 8 Bolt, Chelsea Power Take Off	H26207	1	1963-1965, .020" Thickness, 8 Bolt, Chelsea Power Take Off	H26208	1
1964, .020" Thickness, 6 Bolt, Chelsea Power Take Off	H26206	1			
1964, .020" Thickness, 8 Bolt, Chelsea Power Take Off	H26208	1			
Transmission Pan Gasket			D1000		
1964	W39003	1	P.T.O. Cover Gasket		
1964, Tuff-Cork	W39003TC	1	1965, 6 Bolt, Chelsea Power Take Off		
			1965, 8 Bolt, Chelsea Power Take Off		
			P.T.O. Mounting Gasket		
			1965, .010" Thickness, 6 Bolt, Chelsea Power Take Off		
			1965, .010" Thickness, 8 Bolt, Chelsea Power Take Off		
			1965, .020" Thickness, 6 Bolt, Chelsea Power Take Off		
			1965, .020" Thickness, 8 Bolt, Chelsea Power Take Off		
			D1100		
			P.T.O. Cover Gasket		
			1965, 6 Bolt, Chelsea Power Take Off		

LIGHT TRUCK

Navistar/International (cont.)

Transmission Gaskets (cont.)

<i>Model & Application</i>	<i>Part No.</i>	<i>Qty.</i>	<i>Model & Application</i>	<i>Part No.</i>	<i>Qty.</i>
D1100 (cont.)			D5 SERIES (cont.)		
P.T.O. Cover Gasket (cont.)			P.T.O. Mounting Gasket (cont.)		
1965, 8 Bolt, Chelsea Power Take Off	H36124	1	1937-1940, .020" Thickness, 8 Bolt, Chelsea Power Take Off	H26208	1
P.T.O. Mounting Gasket			D900		
1965, .010" Thickness, 6 Bolt, Chelsea Power Take Off	H26205	1	P.T.O. Cover Gasket		
1965, .010" Thickness, 8 Bolt, Chelsea Power Take Off	H26207	1	1965, 6 Bolt, Chelsea Power Take Off	H36080	1
1965, .020" Thickness, 6 Bolt, Chelsea Power Take Off	H26206	1	1965, 8 Bolt, Chelsea Power Take Off	H36124	1
1965, .020" Thickness, 8 Bolt, Chelsea Power Take Off	H26208	1	P.T.O. Mounting Gasket		
D1200			1965, .010" Thickness, 6 Bolt, Chelsea Power Take Off		
P.T.O. Cover Gasket			1965, .010" Thickness, 8 Bolt, Chelsea Power Take Off		
1965, 6 Bolt, Chelsea Power Take Off	H36080	1	1965, .020" Thickness, 6 Bolt, Chelsea Power Take Off		
1965, 8 Bolt, Chelsea Power Take Off	H36124	1	1965, .020" Thickness, 8 Bolt, Chelsea Power Take Off		
P.T.O. Mounting Gasket			1965, .010" Thickness, 6 Bolt, Chelsea Power Take Off		
1965, .010" Thickness, 8 Bolt, Chelsea Power Take Off	H26205	1	1965, .010" Thickness, 8 Bolt, Chelsea Power Take Off		
1965, .020" Thickness, 6 Bolt, Chelsea Power Take Off	H26207	1	1965, .020" Thickness, 6 Bolt, Chelsea Power Take Off		
1965, .020" Thickness, 8 Bolt, Chelsea Power Take Off	H26206	1	1965, .020" Thickness, 8 Bolt, Chelsea Power Take Off		
1965, .020" Thickness, 8 Bolt, Chelsea Power Take Off	H26208	1	K1 SERIES		
D1300			P.T.O. Cover Gasket		
P.T.O. Cover Gasket			1941-1946, 6 Bolt, Chelsea Power Take Off . . .		
1965, 6 Bolt, Chelsea Power Take Off	H36080	1	1941-1946, 8 Bolt, Chelsea Power Take Off . . .		
1965, 8 Bolt, Chelsea Power Take Off	H36124	1	P.T.O. Mounting Gasket		
P.T.O. Mounting Gasket			1941-1946, .010" Thickness, 6 Bolt, Chelsea Power Take Off		
1965, .010" Thickness, 6 Bolt, Chelsea Power Take Off	H26205	1	1941-1946, .010" Thickness, 8 Bolt, Chelsea Power Take Off		
1965, .010" Thickness, 8 Bolt, Chelsea Power Take Off	H26207	1	1941-1946, .020" Thickness, 6 Bolt, Chelsea Power Take Off		
1965, .020" Thickness, 6 Bolt, Chelsea Power Take Off	H26206	1	1941-1946, .020" Thickness, 8 Bolt, Chelsea Power Take Off		
1965, .020" Thickness, 8 Bolt, Chelsea Power Take Off	H26208	1	K2 SERIES		
D2 SERIES			P.T.O. Cover Gasket		
P.T.O. Cover Gasket			1941-1946, 6 Bolt, Chelsea Power Take Off . . .		
1938-1941, 6 Bolt, Chelsea Power Take Off . . .	H36080	1	1941-1946, 8 Bolt, Chelsea Power Take Off . . .		
1938-1941, 8 Bolt, Chelsea Power Take Off . . .	H36124	1	P.T.O. Mounting Gasket		
P.T.O. Mounting Gasket			1941-1946, .010" Thickness, 6 Bolt, Chelsea Power Take Off		
1938-1941, .010" Thickness, 6 Bolt, Chelsea Power Take Off	H26205	1	1941-1946, .010" Thickness, 8 Bolt, Chelsea Power Take Off		
1938-1941, .010" Thickness, 8 Bolt, Chelsea Power Take Off	H26207	1	1941-1946, .020" Thickness, 6 Bolt, Chelsea Power Take Off		
1938-1941, .020" Thickness, 6 Bolt, Chelsea Power Take Off	H26206	1	1941-1946, .020" Thickness, 8 Bolt, Chelsea Power Take Off		
1938-1941, .020" Thickness, 8 Bolt, Chelsea Power Take Off	H26208	1	K3 SERIES		
D5 SERIES			P.T.O. Cover Gasket		
P.T.O. Cover Gasket			1941-1946, 6 Bolt, Chelsea Power Take Off . . .		
1937-1940, 6 Bolt, Chelsea Power Take Off . . .	H36080	1	1941-1946, 8 Bolt, Chelsea Power Take Off . . .		
1937-1940, 8 Bolt, Chelsea Power Take Off . . .	H36124	1	P.T.O. Mounting Gasket		
P.T.O. Mounting Gasket			1941-1946, .010" Thickness, 6 Bolt, Chelsea Power Take Off		
1937-1940, .010" Thickness, 6 Bolt, Chelsea Power Take Off	H26205	1	1941-1946, .010" Thickness, 8 Bolt, Chelsea Power Take Off		
1937-1940, .010" Thickness, 8 Bolt, Chelsea Power Take Off	H26207	1	1941-1946, .020" Thickness, 6 Bolt, Chelsea Power Take Off		
1937-1940, .020" Thickness, 6 Bolt, Chelsea Power Take Off	H26206	1	1941-1946, .020" Thickness, 8 Bolt, Chelsea Power Take Off		
1937-1940, .020" Thickness, 8 Bolt, Chelsea Power Take Off	H26208	1	KB1		
D5 SERIES (cont.)			P.T.O. Cover Gasket		
P.T.O. Mounting Gasket (cont.)			1947-1949, 6 Bolt, Chelsea Power Take Off . . .		
P.T.O. Mounting Gasket (cont.)			1947-1949, 8 Bolt, Chelsea Power Take Off . . .		
P.T.O. Mounting Gasket (cont.)			1947-1949, 8 Bolt, Chelsea Power Take Off . . .		

LIGHT TRUCK

Navistar/International (cont.)

Transmission Gaskets (cont.)

<i>Model & Application</i>	<i>Part No.</i>	<i>Qty.</i>	<i>Model & Application</i>	<i>Part No.</i>	<i>Qty.</i>
LB-140 (cont.)			M1200 (cont.)		
P.T.O. Mounting Gasket (cont.)			P.T.O. Cover Gasket (cont.)		
1950-1952, .010" Thickness, 8 Bolt, Chelsea Power Take Off	H26207	1	1968-1971, 8 Bolt, Chelsea Power Take Off	H36124	1
1950-1952, .020" Thickness, 6 Bolt, Chelsea Power Take Off	H26206	1	P.T.O. Mounting Gasket		
1950-1952, .020" Thickness, 8 Bolt, Chelsea Power Take Off	H26208	1	1968-1971, .010" Thickness, 6 Bolt, Chelsea Power Take Off	H26205	1
LB14			1968-1971, .010" Thickness, 8 Bolt, Chelsea Power Take Off	H26207	1
P.T.O. Cover Gasket			1968-1971, .020" Thickness, 6 Bolt, Chelsea Power Take Off	H26206	1
1951-1952, 6 Bolt, Chelsea Power Take Off	H36080	1	1968-1971, .020" Thickness, 8 Bolt, Chelsea Power Take Off	H26208	1
1951-1952, 8 Bolt, Chelsea Power Take Off	H36124	1	M1210		
P.T.O. Mounting Gasket			P.T.O. Cover Gasket		
1951-1952, .010" Thickness, 6 Bolt, Chelsea Power Take Off	H26205	1	1975, 6 Bolt, Chelsea Power Take Off	H36080	1
1951-1952, .010" Thickness, 8 Bolt, Chelsea Power Take Off	H26207	1	1975, 8 Bolt, Chelsea Power Take Off	H36124	1
1951-1952, .020" Thickness, 6 Bolt, Chelsea Power Take Off	H26206	1	P.T.O. Mounting Gasket		
1951-1952, .020" Thickness, 8 Bolt, Chelsea Power Take Off	H26208	1	1975, .010" Thickness, 6 Bolt, Chelsea Power Take Off	H26205	1
LM12			1975, .010" Thickness, 8 Bolt, Chelsea Power Take Off	H26207	1
P.T.O. Cover Gasket			1975, .020" Thickness, 6 Bolt, Chelsea Power Take Off	H26206	1
1950-1952, 6 Bolt, Chelsea Power Take Off	H36080	1	1975, .020" Thickness, 8 Bolt, Chelsea Power Take Off	H26208	1
1950-1952, 8 Bolt, Chelsea Power Take Off	H36124	1	M700		
P.T.O. Mounting Gasket			P.T.O. Cover Gasket		
1950-1952, .010" Thickness, 6 Bolt, Chelsea Power Take Off	H26205	1	1966-1967, 6 Bolt, Chelsea Power Take Off	H36080	1
1950-1952, .010" Thickness, 8 Bolt, Chelsea Power Take Off	H26207	1	1966-1967, 8 Bolt, Chelsea Power Take Off	H36124	1
1950-1952, .020" Thickness, 6 Bolt, Chelsea Power Take Off	H26206	1	P.T.O. Mounting Gasket		
1950-1952, .020" Thickness, 8 Bolt, Chelsea Power Take Off	H26208	1	1966-1967, .010" Thickness, 6 Bolt, Chelsea Power Take Off	H26205	1
LM15			1966-1967, .010" Thickness, 8 Bolt, Chelsea Power Take Off	H26207	1
P.T.O. Cover Gasket			1966-1967, .020" Thickness, 6 Bolt, Chelsea Power Take Off	H26206	1
1950-1952, 6 Bolt, Chelsea Power Take Off	H36080	1	1966-1967, .020" Thickness, 8 Bolt, Chelsea Power Take Off	H26208	1
1950-1952, 8 Bolt, Chelsea Power Take Off	H36124	1	M800		
P.T.O. Mounting Gasket			P.T.O. Cover Gasket		
1950-1952, .010" Thickness, 6 Bolt, Chelsea Power Take Off	H26205	1	1966-1968, 6 Bolt, Chelsea Power Take Off	H36080	1
1950-1952, .010" Thickness, 8 Bolt, Chelsea Power Take Off	H26207	1	1966-1968, 8 Bolt, Chelsea Power Take Off	H36124	1
1950-1952, .020" Thickness, 6 Bolt, Chelsea Power Take Off	H26206	1	P.T.O. Mounting Gasket		
1950-1952, .020" Thickness, 8 Bolt, Chelsea Power Take Off	H26208	1	1966-1968, .010" Thickness, 6 Bolt, Chelsea Power Take Off	H26205	1
M1100			1966-1968, .010" Thickness, 8 Bolt, Chelsea Power Take Off	H26207	1
P.T.O. Cover Gasket			1966-1968, .020" Thickness, 6 Bolt, Chelsea Power Take Off	H26206	1
1966-1971, 6 Bolt, Chelsea Power Take Off	H36080	1	1966-1968, .020" Thickness, 8 Bolt, Chelsea Power Take Off	H26208	1
1966-1971, 8 Bolt, Chelsea Power Take Off	H36124	1	MA1200		
P.T.O. Mounting Gasket			P.T.O. Cover Gasket		
1966-1971, .010" Thickness, 6 Bolt, Chelsea Power Take Off	H26205	1	1968-1970, 6 Bolt, Chelsea Power Take Off	H36080	1
1966-1971, .010" Thickness, 8 Bolt, Chelsea Power Take Off	H26207	1	1968-1970, 8 Bolt, Chelsea Power Take Off	H36124	1
1966-1971, .020" Thickness, 6 Bolt, Chelsea Power Take Off	H26206	1	P.T.O. Mounting Gasket		
1966-1971, .020" Thickness, 8 Bolt, Chelsea Power Take Off	H26208	1	1968-1970, .010" Thickness, 6 Bolt, Chelsea Power Take Off	H26205	1
M1200			1968-1970, .010" Thickness, 8 Bolt, Chelsea Power Take Off	H26207	1
P.T.O. Cover Gasket			1968-1970, .020" Thickness, 6 Bolt, Chelsea Power Take Off	H26206	1
1968-1971, 6 Bolt, Chelsea Power Take Off	H36080	1			

LIGHT TRUCK

Transmission Gaskets (cont.)				
Model & Application	Part No.	Qty.	Model & Application	Part No. Qty.
MA1200 (cont.)			R120 (cont.)	
P.T.O. Mounting Gasket (cont.)			P.T.O. Cover Gasket (cont.)	
1968-1970, .020" Thickness, 8 Bolt, Chelsea Power Take Off	H26208	1	1953-1955, 8 Bolt, Chelsea Power Take Off	H36124 1
MS1200			P.T.O. Mounting Gasket	
P.T.O. Cover Gasket			1953-1955, .010" Thickness, 6 Bolt, Chelsea Power Take Off	
1973-1974, 6 Bolt, Chelsea Power Take Off	H36080	1		H26205 1
1973-1974, 8 Bolt, Chelsea Power Take Off	H36124	1	1953-1955, .010" Thickness, 8 Bolt, Chelsea Power Take Off	H26207 1
P.T.O. Mounting Gasket			1953-1955, .020" Thickness, 6 Bolt, Chelsea Power Take Off	
1973-1974, .010" Thickness, 6 Bolt, Chelsea Power Take Off	H26205	1		H26206 1
1973-1974, .010" Thickness, 8 Bolt, Chelsea Power Take Off	H26207	1	1953-1955, .020" Thickness, 8 Bolt, Chelsea Power Take Off	H26208 1
1973-1974, .020" Thickness, 6 Bolt, Chelsea Power Take Off	H26206	1	R130	
1973-1974, .020" Thickness, 8 Bolt, Chelsea Power Take Off	H26208	1	P.T.O. Cover Gasket	
R-140			1953-1955, 6 Bolt, Chelsea Power Take Off	
Elec. Shift Cover Gasket			1953-1955, 8 Bolt, Chelsea Power Take Off	
1953-1955, 10 Bolt, Eaton 2 Speed Axle	H36328	1		H36080 1
1953-1955, 11 Bolt, Eaton 2 Speed Axle	H36329	1		H36124 1
P.T.O. Cover Gasket			P.T.O. Mounting Gasket	
1953-1955, 6 Bolt, Chelsea Power Take Off	H36080	1	1953-1955, .010" Thickness, 6 Bolt, Chelsea Power Take Off	
1953-1955, 8 Bolt, Chelsea Power Take Off	H36124	1		H26205 1
P.T.O. Mounting Gasket			1953-1955, .010" Thickness, 8 Bolt, Chelsea Power Take Off	
1953-1955, .010" Thickness, 6 Bolt, Chelsea Power Take Off	H26205	1		H26207 1
1953-1955, .010" Thickness, 8 Bolt, Chelsea Power Take Off	H26207	1	1953-1955, .020" Thickness, 6 Bolt, Chelsea Power Take Off	
1953-1955, .020" Thickness, 6 Bolt, Chelsea Power Take Off	H26206	1		H26206 1
1953-1955, .020" Thickness, 8 Bolt, Chelsea Power Take Off	H26208	1	1953-1955, .020" Thickness, 8 Bolt, Chelsea Power Take Off	
R100			RA120	
P.T.O. Cover Gasket			P.T.O. Cover Gasket	
1953-1955, 6 Bolt, Chelsea Power Take Off	H36080	1	1953-1955, 6 Bolt, Chelsea Power Take Off	
1953-1955, 8 Bolt, Chelsea Power Take Off	H36124	1		H36124 1
P.T.O. Mounting Gasket			P.T.O. Mounting Gasket	
1953-1955, .010" Thickness, 6 Bolt, Chelsea Power Take Off	H26205	1	1953-1955, .010" Thickness, 6 Bolt, Chelsea Power Take Off	
1953-1955, .010" Thickness, 8 Bolt, Chelsea Power Take Off	H26207	1		H26205 1
1953-1955, .020" Thickness, 6 Bolt, Chelsea Power Take Off	H26206	1	1953-1955, .010" Thickness, 8 Bolt, Chelsea Power Take Off	
1953-1955, .020" Thickness, 8 Bolt, Chelsea Power Take Off	H26208	1		H26207 1
R110			1953-1955, .020" Thickness, 6 Bolt, Chelsea Power Take Off	
P.T.O. Cover Gasket				H26206 1
1953-1955, 6 Bolt, Chelsea Power Take Off	H36080	1	1953-1955, .020" Thickness, 8 Bolt, Chelsea Power Take Off	
1953-1955, 8 Bolt, Chelsea Power Take Off	H36124	1		H26208 1
P.T.O. Mounting Gasket			RM120	
1953-1955, .010" Thickness, 6 Bolt, Chelsea Power Take Off	H26205	1	P.T.O. Cover Gasket	
1953-1955, .010" Thickness, 8 Bolt, Chelsea Power Take Off	H26207	1	1953-1955, 6 Bolt, Chelsea Power Take Off	
1953-1955, .020" Thickness, 6 Bolt, Chelsea Power Take Off	H26206	1		H36124 1
1953-1955, .020" Thickness, 8 Bolt, Chelsea Power Take Off	H26208	1	P.T.O. Mounting Gasket	
R120			1953-1955, .010" Thickness, 6 Bolt, Chelsea Power Take Off	
P.T.O. Cover Gasket				H26205 1
1953-1955, 6 Bolt, Chelsea Power Take Off	H36080	1	1953-1955, .010" Thickness, 8 Bolt, Chelsea Power Take Off	
1953-1955, 8 Bolt, Chelsea Power Take Off	H36124	1		H26207 1
P.T.O. Mounting Gasket			1953-1955, .020" Thickness, 6 Bolt, Chelsea Power Take Off	
1953-1955, .010" Thickness, 6 Bolt, Chelsea Power Take Off	H26205	1		H26206 1
1953-1955, .010" Thickness, 8 Bolt, Chelsea Power Take Off	H26207	1	1953-1955, .020" Thickness, 8 Bolt, Chelsea Power Take Off	
1953-1955, .020" Thickness, 6 Bolt, Chelsea Power Take Off	H26206	1		H26208 1
1953-1955, .020" Thickness, 8 Bolt, Chelsea Power Take Off	H26208	1	S-140	
R110			Elec. Shift Cover Gasket	
P.T.O. Cover Gasket			1955-1956, 10 Bolt, Eaton 2 Speed Axle	
1953-1955, 6 Bolt, Chelsea Power Take Off	H36080	1		H36328 1
1953-1955, 8 Bolt, Chelsea Power Take Off	H36124	1		H36329 1
P.T.O. Mounting Gasket			P.T.O. Cover Gasket	
1953-1955, .010" Thickness, 6 Bolt, Chelsea Power Take Off	H26205	1	1955-1956, 6 Bolt, Chelsea Power Take Off	
1953-1955, .010" Thickness, 8 Bolt, Chelsea Power Take Off	H26207	1		H36080 1
1953-1955, .020" Thickness, 6 Bolt, Chelsea Power Take Off	H26206	1	1955-1956, 8 Bolt, Chelsea Power Take Off	
1953-1955, .020" Thickness, 8 Bolt, Chelsea Power Take Off	H26208	1		H36124 1
R120			P.T.O. Mounting Gasket	
P.T.O. Cover Gasket			1955-1956, .010" Thickness, 6 Bolt, Chelsea Power Take Off	
1953-1955, 6 Bolt, Chelsea Power Take Off	H36080	1		H26205 1
1953-1955, 8 Bolt, Chelsea Power Take Off	H36124	1	1955-1956, .010" Thickness, 8 Bolt, Chelsea Power Take Off	
P.T.O. Mounting Gasket				H26207 1
1953-1956, .010" Thickness, 6 Bolt, Chelsea Power Take Off	H26205	1		
1953-1956, .010" Thickness, 8 Bolt, Chelsea Power Take Off	H26207	1		

Navistar/International (cont.)

Transmission Gaskets (cont.)

<i>Model & Application</i>	<i>Part No.</i>	<i>Qty.</i>	<i>Model & Application</i>	<i>Part No.</i>	<i>Qty.</i>
S-140 (cont.)			SA120 (cont.)		
P.T.O. Mounting Gasket (cont.)			P.T.O. Mounting Gasket		
1955-1956, .020" Thickness, 6 Bolt, Chelsea Power Take Off	H26206	1	1956-1957, .010" Thickness, 6 Bolt, Chelsea Power Take Off	H26205	1
1955-1956, .020" Thickness, 8 Bolt, Chelsea Power Take Off	H26208	1	1956-1957, .010" Thickness, 8 Bolt, Chelsea Power Take Off	H26207	1
S100			1956-1957, .020" Thickness, 6 Bolt, Chelsea Power Take Off		
P.T.O. Cover Gasket			H26206 1		
1956-1957, 6 Bolt, Chelsea Power Take Off . . .	H36080	1	1956-1957, .020" Thickness, 8 Bolt, Chelsea Power Take Off	H26208	1
1956-1957, 8 Bolt, Chelsea Power Take Off . . .	H36124	1	SM120		
P.T.O. Mounting Gasket			P.T.O. Cover Gasket		
1956-1957, .010" Thickness, 6 Bolt, Chelsea Power Take Off	H26205	1	1956-1957, 6 Bolt, Chelsea Power Take Off . . .	H36080	1
1956-1957, .010" Thickness, 8 Bolt, Chelsea Power Take Off	H26207	1	1956-1957, 8 Bolt, Chelsea Power Take Off . . .	H36124	1
1956-1957, .020" Thickness, 6 Bolt, Chelsea Power Take Off	H26206	1	P.T.O. Mounting Gasket		
1956-1957, .020" Thickness, 8 Bolt, Chelsea Power Take Off	H26208	1	1956-1957, .010" Thickness, 6 Bolt, Chelsea Power Take Off	H26205	1
S110			1956-1957, .010" Thickness, 8 Bolt, Chelsea Power Take Off	H26207	1
P.T.O. Cover Gasket			1956-1957, .020" Thickness, 6 Bolt, Chelsea Power Take Off	H26206	1
1956-1957, 6 Bolt, Chelsea Power Take Off . . .	H36080	1	1956-1957, .020" Thickness, 8 Bolt, Chelsea Power Take Off	H26208	1
1956-1957, 8 Bolt, Chelsea Power Take Off . . .	H36124	1	SM130		
P.T.O. Mounting Gasket			P.T.O. Cover Gasket		
1956-1957, .010" Thickness, 6 Bolt, Chelsea Power Take Off	H26205	1	1956-1957, 6 Bolt, Chelsea Power Take Off . . .	H36080	1
1956-1957, .010" Thickness, 8 Bolt, Chelsea Power Take Off	H26207	1	1956-1957, 8 Bolt, Chelsea Power Take Off . . .	H36124	1
1956-1957, .020" Thickness, 6 Bolt, Chelsea Power Take Off	H26206	1	P.T.O. Mounting Gasket		
1956-1957, .020" Thickness, 8 Bolt, Chelsea Power Take Off	H26208	1	1956-1957, .010" Thickness, 6 Bolt, Chelsea Power Take Off	H26205	1
S120			1956-1957, .010" Thickness, 8 Bolt, Chelsea Power Take Off	H26207	1
P.T.O. Cover Gasket			1956-1957, .020" Thickness, 6 Bolt, Chelsea Power Take Off	H26206	1
1956-1957, 6 Bolt, Chelsea Power Take Off . . .	H36080	1	1956-1957, .020" Thickness, 8 Bolt, Chelsea Power Take Off	H26208	1
1956-1957, 8 Bolt, Chelsea Power Take Off . . .	H36124	1	SCOUT		
P.T.O. Mounting Gasket			P.T.O. Cover Gasket		
1956-1957, .010" Thickness, 6 Bolt, Chelsea Power Take Off	H26205	1	1961-1971, 6 Bolt, Chelsea Power Take Off . . .	H36080	1
1956-1957, .010" Thickness, 8 Bolt, Chelsea Power Take Off	H26207	1	1961-1971, 8 Bolt, Chelsea Power Take Off . . .	H36124	1
1956-1957, .020" Thickness, 6 Bolt, Chelsea Power Take Off	H26206	1	P.T.O. Mounting Gasket		
1956-1957, .020" Thickness, 8 Bolt, Chelsea Power Take Off	H26208	1	1961-1971, .010" Thickness, 6 Bolt, Chelsea Power Take Off	H26205	1
S130			1961-1971, .010" Thickness, 8 Bolt, Chelsea Power Take Off	H26207	1
P.T.O. Cover Gasket			1961-1971, .020" Thickness, 6 Bolt, Chelsea Power Take Off	H26206	1
1956-1957, 6 Bolt, Chelsea Power Take Off . . .	H36080	1	1961-1971, .020" Thickness, 8 Bolt, Chelsea Power Take Off	H26208	1
1956-1957, 8 Bolt, Chelsea Power Take Off . . .	H36124	1	Transmission Gasket Set		
P.T.O. Mounting Gasket			1961-1971, TC144 Transfer Case		
1956-1957, .010" Thickness, 6 Bolt, Chelsea Power Take Off	H26205	1	TS26290 1		
1956-1957, .010" Thickness, 8 Bolt, Chelsea Power Take Off	H26207	1	Transmission Pan Gasket		
1956-1957, .020" Thickness, 6 Bolt, Chelsea Power Take Off	H26206	1	1971, T407 Transmission		
1956-1957, .020" Thickness, 8 Bolt, Chelsea Power Take Off	H26208	1	1971, T407 Transmission, Tuff-Cork		
SA120			W39003 1		
P.T.O. Cover Gasket			W39003TC 1		
1956-1957, 6 Bolt, Chelsea Power Take Off . . .	H36080	1	SCOUT II		
1956-1957, 8 Bolt, Chelsea Power Take Off . . .	H36124	1	P.T.O. Cover Gasket		
P.T.O. Mounting Gasket			1971-1974, 6 Bolt, Chelsea Power Take Off . . .		
1971-1974, .010" Thickness, 6 Bolt, Chelsea Power Take Off	H26205	1	1971-1974, 8 Bolt, Chelsea Power Take Off . . .		
1971-1974, .010" Thickness, 8 Bolt, Chelsea Power Take Off	H26207	1	P.T.O. Mounting Gasket		
H26207 1			1971-1974, .010" Thickness, 6 Bolt, Chelsea Power Take Off		
H26205 1			1971-1974, .010" Thickness, 8 Bolt, Chelsea Power Take Off		
H26206 1			H26205 1		
H26208 1			H26207 1		

LIGHT TRUCK

Transmission Gaskets (cont.)				
Model & Application	Part No.	Qty.	Model & Application	Part No. Qty.
SCOUT II (cont.)			TRAVELALL 1110 (cont.)	
P.T.O. Mounting Gasket (cont.)			P.T.O. Mounting Gasket	
1971-1974, .020" Thickness, 6 Bolt, Chelsea Power Take Off	H26206	1	1972-1973, .010" Thickness, 6 Bolt, Chelsea Power Take Off	H26205 1
1971-1974, .020" Thickness, 8 Bolt, Chelsea Power Take Off	H26208	1	1972-1973, .010" Thickness, 8 Bolt, Chelsea Power Take Off	H26207 1
Transmission Pan Gasket			Transmission Pan Gasket	
1971-1974, T407 Transmission	W39003	1	1972-1973, .020" Thickness, 6 Bolt, Chelsea Power Take Off	H26206 1
1971-1974, T407 Transmission, Tuff-Cork . .	W39003TC	1	1972-1973, .020" Thickness, 8 Bolt, Chelsea Power Take Off	H26208 1
SCOUT XLC			TRAVELALL 1210	
P.T.O. Cover Gasket			P.T.O. Cover Gasket	
1975-1980, 6 Bolt, Chelsea Power Take Off . .	H36080	1	1972-1973, 6 Bolt, Chelsea Power Take Off . .	H36080 1
1975-1980, 8 Bolt, Chelsea Power Take Off . .	H36124	1	1972-1973, 8 Bolt, Chelsea Power Take Off . .	H36124 1
P.T.O. Mounting Gasket			P.T.O. Mounting Gasket	
1975-1980, .010" Thickness, 6 Bolt, Chelsea Power Take Off	H26205	1	1972-1973, .010" Thickness, 6 Bolt, Chelsea Power Take Off	H26205 1
1975-1980, .010" Thickness, 8 Bolt, Chelsea Power Take Off	H26207	1	1972-1973, .010" Thickness, 8 Bolt, Chelsea Power Take Off	H26207 1
1975-1980, .020" Thickness, 6 Bolt, Chelsea Power Take Off	H26206	1	1972-1973, .020" Thickness, 6 Bolt, Chelsea Power Take Off	H26206 1
1975-1980, .020" Thickness, 8 Bolt, Chelsea Power Take Off	H26208	1	1972-1973, .020" Thickness, 8 Bolt, Chelsea Power Take Off	H26208 1
Transmission Pan Gasket			Transmission Pan Gasket	
1975-1980, T407 Transmission	W39003	1	1972-1973, T407 Transmission	W39003 1
1975-1980, T407 Transmission, Tuff-Cork . .	W39003TC	1	1972-1973, T407 Transmission, Tuff-Cork . .	W39003TC 1
TRAVELALL 100			TRAVELALL 150	
P.T.O. Cover Gasket			P.T.O. Cover Gasket	
1974, 6 Bolt, Chelsea Power Take Off	H36080	1	1975, 6 Bolt, Chelsea Power Take Off	H36080 1
1974, 8 Bolt, Chelsea Power Take Off	H36124	1	1975, 8 Bolt, Chelsea Power Take Off	H36124 1
P.T.O. Mounting Gasket			P.T.O. Mounting Gasket	
1974, .010" Thickness, 6 Bolt, Chelsea Power Take Off	H26205	1	1975, .010" Thickness, 6 Bolt, Chelsea Power Take Off	H26205 1
1974, .010" Thickness, 8 Bolt, Chelsea Power Take Off	H26207	1	1975, .010" Thickness, 8 Bolt, Chelsea Power Take Off	H26207 1
1974, .020" Thickness, 6 Bolt, Chelsea Power Take Off	H26206	1	1975, .020" Thickness, 6 Bolt, Chelsea Power Take Off	H26206 1
1974, .020" Thickness, 8 Bolt, Chelsea Power Take Off	H26208	1	1975, .020" Thickness, 8 Bolt, Chelsea Power Take Off	H26208 1
Transmission Pan Gasket			Transmission Pan Gasket	
1974, T407 Transmission	W39003	1	1975, T407 Transmission	W39003 1
1974, T407 Transmission, Tuff-Cork	W39003TC	1	1975, T407 Transmission, Tuff-Cork	W39003TC 1
TRAVELALL 1010			TRAVELALL 200	
P.T.O. Cover Gasket			P.T.O. Cover Gasket	
1972-1973, 6 Bolt, Chelsea Power Take Off . .	H36080	1	1974-1975, 6 Bolt, Chelsea Power Take Off . .	H36080 1
1972-1973, 8 Bolt, Chelsea Power Take Off . .	H36124	1	1974-1975, 8 Bolt, Chelsea Power Take Off . .	H36124 1
P.T.O. Mounting Gasket			P.T.O. Mounting Gasket	
1972-1973, .010" Thickness, 6 Bolt, Chelsea Power Take Off	H26205	1	1974-1975, .010" Thickness, 6 Bolt, Chelsea Power Take Off	H26205 1
1972-1973, .010" Thickness, 8 Bolt, Chelsea Power Take Off	H26207	1	1974-1975, .010" Thickness, 8 Bolt, Chelsea Power Take Off	H26207 1
1972-1973, .020" Thickness, 6 Bolt, Chelsea Power Take Off	H26206	1	1974-1975, .020" Thickness, 6 Bolt, Chelsea Power Take Off	H26206 1
1972-1973, .020" Thickness, 8 Bolt, Chelsea Power Take Off	H26208	1	1974-1975, .020" Thickness, 8 Bolt, Chelsea Power Take Off	H26208 1
Transmission Pan Gasket			Transmission Pan Gasket	
1972-1973, T407 Transmission	W39003	1	1974-1975, T407 Transmission	W39003 1
1972-1973, T407 Transmission, Tuff-Cork . .	W39003TC	1	1974-1975, T407 Transmission, Tuff-Cork . .	W39003TC 1
TRAVELALL 1110			TRAVELALL 1110 (cont.)	
P.T.O. Cover Gasket			P.T.O. Cover Gasket	
1972-1973, 6 Bolt, Chelsea Power Take Off . .	H36080	1	1972-1973, 6 Bolt, Chelsea Power Take Off . .	H36080 1
1972-1973, 8 Bolt, Chelsea Power Take Off . .	H36124	1	1972-1973, 8 Bolt, Chelsea Power Take Off . .	H36124 1

Nissan Truck

Differential Housing Cover Gaskets

<i>Model & Application</i>	<i>Part No.</i>	<i>Qty.</i>	<i>Model & Application</i>	<i>Part No.</i>	<i>Qty.</i>
520			620 (cont.)		
Diff. Hsg. Cover Gasket			Diff. Hsg. Cover Gasket (cont.)		
1966-1968, H190 Differential	P29105	1	1972-1979, H190 Differential	P29105	1
1965, From 4/65, H190 Differential	P29105	1			
521			720		
Diff. Hsg. Cover Gasket			Diff. Hsg. Cover Gasket		
1968-1972, H190 Differential	P29105	1	1984-1985, C200 4 Wheel Drive Differential, H190 Differential	P38145	1
620			1983, C200 4 Wheel Drive Differential, From 1/83, H190 Differential	P38145	1
Diff. Hsg. Cover Gasket			1980-1985, H190 Differential	P29105	1
1979, From 6/79, R180 Differential	P29074	1	1980-1985, R180 Differential	P29074	1

Transmission Gaskets

<i>Model & Application</i>	<i>Part No.</i>	<i>Qty.</i>	<i>Model & Application</i>	<i>Part No.</i>	<i>Qty.</i>
521			D21		
Transmission Gasket Set			Transmission Pan Gasket		
1969-1972, 4 Speed Transmission	TS29064	1	1988-1992, Automatic Transmission, Tuff-Cork	W31183TC	1
620			PATHFINDER		
Transmission Pan Gasket			Transmission Pan Gasket		
1972-1979, Automatic Transmission	W29051	1	1988-1992, Automatic Transmission, Tuff-Cork	W31183TC	1
720			QUEST		
Transfer Case Gasket Set			Transmission Pan Gasket		
1980-1983, 4 Wheel Drive	TS29085	1	1993-1996, RE4F04A Automatic Overdrive Transmission	W39380	1
Transmission Gasket Set					
1980-1983, 4 Speed Transmission, 5 Speed Transmission	TS29065	1			
Transmission Pan Gasket					
1980-1983, Automatic Transmission	W29051	1			

Subaru Truck

Transmission Gaskets

<i>Model & Application</i>	<i>Part No.</i>	<i>Qty.</i>	<i>Model & Application</i>	<i>Part No.</i>	<i>Qty.</i>
BRAT					
Transaxle Pan Gasket					
1983-1984, Automatic Transmission, Turbocharged	W29101	1			

Toyota Truck

Differential Housing Cover Gaskets

<i>Model & Application</i>	<i>Part No.</i>	<i>Qty.</i>	<i>Model & Application</i>	<i>Part No.</i>	<i>Qty.</i>
VAN					
Diff. Hsg. Cover Gasket					
1984-1985	P29078	1			

LIGHT TRUCK

Toyota Truck (cont.)

Transmission Gaskets					
<i>Model & Application</i>	<i>Part No.</i>	<i>Qty.</i>	<i>Model & Application</i>	<i>Part No.</i>	<i>Qty.</i>
PICKUP			RAV 4 (cont.)		
Transaxle Pan Gasket			Transaxle Pan Gasket (cont.)		
1972-1995, A40 Transmission, A40D Transmission, A43D Transmission, Tuff-Cork			1996, 2 Wheel Drive, A241E Transaxle, Thru Serial Numbers SXA10-0170454, SXA11-0154875 And SXA11-7074879, Tuff-Cork		
	W39370TC	1		W31173TC	1
RAV 4			TACOMA		
Transaxle Pan Gasket			Transaxle Pan Gasket		
1999-2000, 4 Wheel Drive, A540H Transaxle, Tuff-Cork			1995-2001, A43D Transmission, Tuff-Cork		
	W31172TC	1		W39370TC	1
1997, 2 Wheel Drive, A241E Transaxle, Thru 9/97, Thru Serial Numbers SXA10-0170454, SXA11-0154875 And SXA11-7074879, Tuff-Cork			VAN		
	W31173TC	1	Transaxle Pan Gasket		
1996-1997, 4 Wheel Drive, A540H Transaxle, Tuff-Cork			1984-1990, Automatic Transmission, Tuff-Cork		
	W31172TC	1		W39370TC	1

Volkswagen Truck

Transmission Gaskets					
<i>Model & Application</i>	<i>Part No.</i>	<i>Qty.</i>	<i>Model & Application</i>	<i>Part No.</i>	<i>Qty.</i>
RABBIT			RABBIT (cont.)		
Transmission Gasket Set			Transmission Pan Gasket		
1980-1983, Manual Transaxle			1980-1983, Automatic Transmission		
	TS27917	1		W29080	1

Collector and Muffler Gasket

Triangular - 3 Bolt

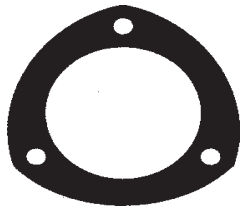

Inside Dia.	Bolt Circle	Bolt Hole	Part Number	Material	Application
2-3/8"	3-1/2"	3/8"	F20412SG	Nitroseal	Hush Thrush Muffler #510
2-1/2"	3-1/2"	3/8"	F20410SG	Nitroseal	Hooker, Hedman
2-3/4"	3-1/2"	3/8"	F12381SG	Nitroseal	Hooker, Hedman
3"	3-3/4"	3/8"	F20417SG	Nitroseal	Thorley, Hooker, Hedman
3-1/2"	4-7/16"	3/8"	F20416SG	Nitroseal	Thorley, Hooker, Hedman

Square - 4 Bolt

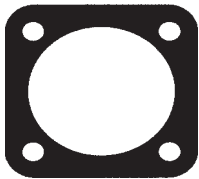

Inside Dia.	Bolt Circle	Bolt Hole	Part Number	Material	Application
2-1/2"	3-5/16"	3/8"	F20411SG	Nitroseal	Blackjack and Others
3"	4-1/16"	3/8"	F20421SG	Nitroseal	Blackjack and Others
3"	4-1/16"	7/16"	F20418SG	Nitroseal	Blackjack and Others
3-1/2"	4-9/16"	3/8"	F20422SG	Nitroseal	Blackjack and Others
3-1/2"	5"	3/8"	F20419SG	Nitroseal	Blackjack and Others

Round - 4 Bolt

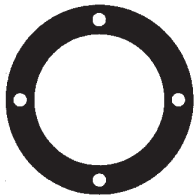

Inside Dia.	Bolt Circle	Bolt Hole	Part Number	Material	Application
3"	3-5/8"	3/8"	F20415SG	Nitroseal	---
3-1/2"	4-1/8"	3/8"	F20420SG	Nitroseal	---

Round - Multi-Bolt



Inside Dia.	Bolt Circle	Bolt Hole	Part Number	Material	Application
2-7/8"	3-3/4"	7/16"	F20413SG	Nitroseal	Hush Thrush Muffler #513
2-7/8"	4"	7/16"	F20413SG	Nitroseal	Hush Thrush Muffler #513
3-3/8"	4-3/8"	3/8"	F20414SG	Nitroseal	Hush Thrush Muffler #514
3-3/8"	4-1/2"	3/8"	F20414SG	Nitroseal	Hush Thrush Muffler #514

Axle Nomenclature

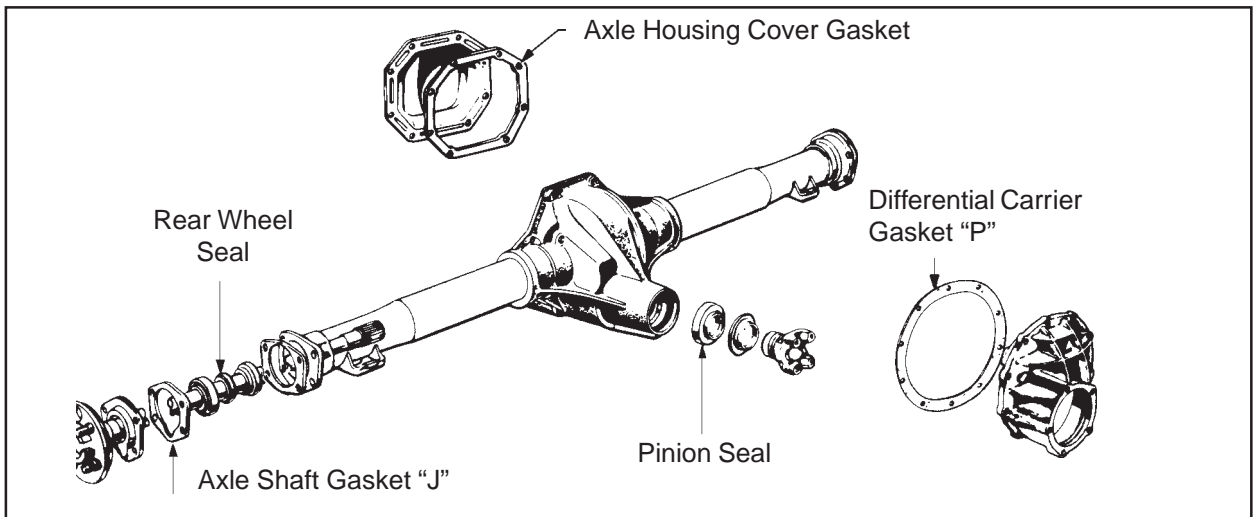

Typical Axle Identification Tag Locations

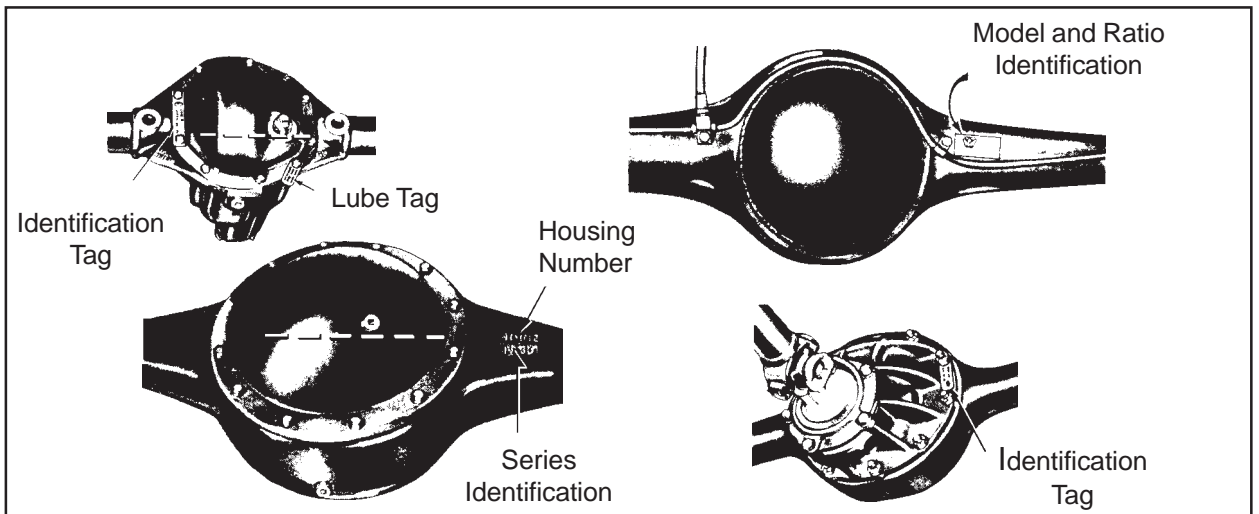

General Motors Axle Identification

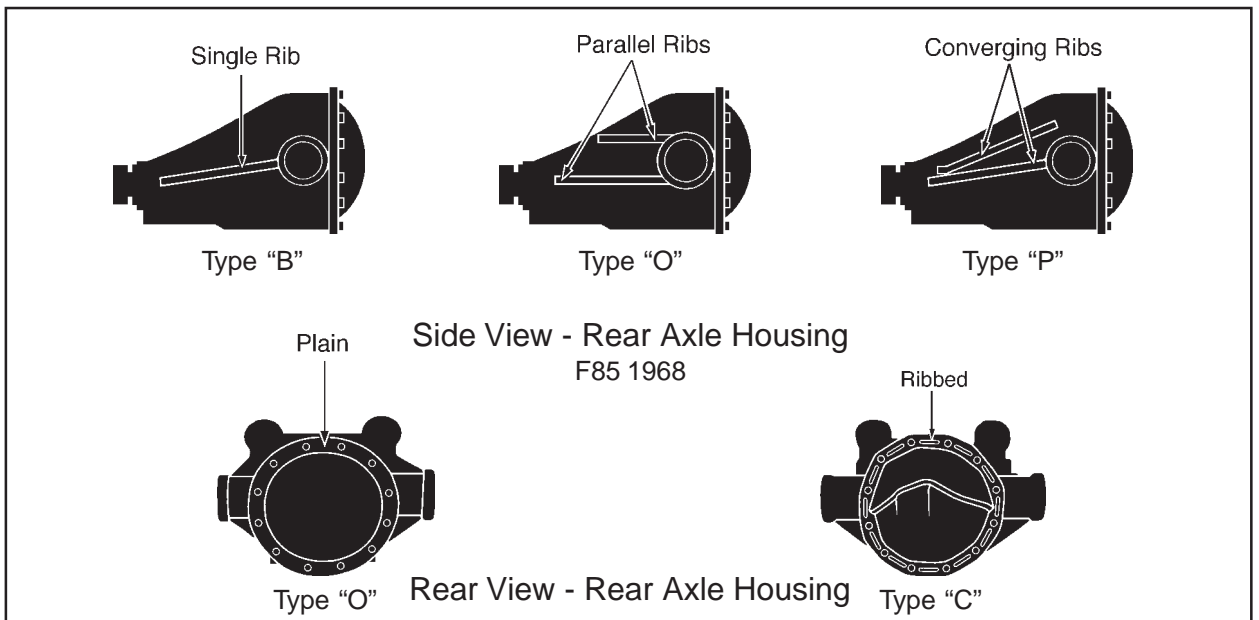

Identification Charts For Axle Shaft Gaskets

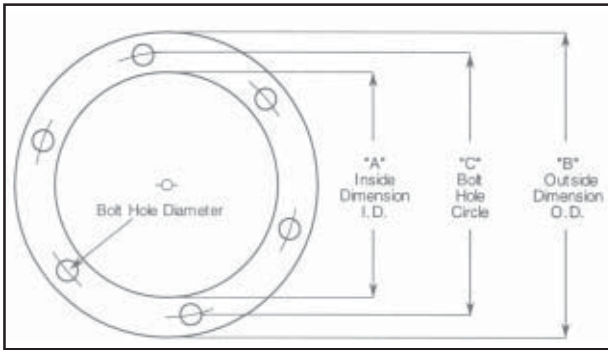

This chart is arranged by the number of bolt holes, then in size sequence by diameter. For those applications that are different

than the typical axle shaft gasket as illustrated to the left, special illustrations have been provided for visual identification. (See following page for illustrations.)

The proper gaskets can be determined by counting the number of bolt holes or studs, measuring the inside diameter, outside diameter, bolt hole circle and measuring the bolt hole or stud. Read down the columns until correct size is located. The proper gasket number will be found on the same line in the adjoining column.

Note: Gaskets without bolt holes are generally used on oil bath hub cap applications. Some materials have a natural tendency to shrink or distort. This should be taken into consideration when measuring. Caution should be exercised to match the material and thickness being replaced.

"A"	"B"	"C"	"D"	Part Number	Remarks	"A"	"B"	"C"	"D"	Part Number	Remarks
NO BOLT HOLES						SIX BOLT HOLES - Continued					
2 9/16	3			J27971		3 11/16	5 13/32	4 7/16	1/2	J26969	
3 9/16	4 1/16			J27239		4 1/4	6 3/4	5 7/8	17/32	J27972	
THREE BOLT HOLES						4 3/8	5 3/4	5 3/16	3/8	J27127	
4 1/8	5 5/8	5	9/32	J27244		4 3/8	6	5 1/4	11/32	J27122	
4 3/8	6	5 1/4	3/8	J27586		4 3/8	6 1/4	5 5/8	1/4	J27202	
4 1/2	6 3/8	5 9/16	11/32	J27970		4 9/16	6 1/4	5 1/2	7/16	J27950	
4 3/4	6 1/8	5 3/8	13/32	J27283		4 27/32	6 1/4	5 1/2	11/32	J27951	
FOUR BOLT HOLES						4 15/16	6 15/16	6 1/16	13/32	J27280	
2 11/16			7/16	J26542	See Fig. 2	5	6 1/2	5 7/8	11/32	J27123	
2 11/16			7/16	J26569	See Fig. 3	5	7 3/4	6 7/8	9/32	J27282	
2 25/32			13/32	J26245	See Fig. 6 (M)	5 1/2	7 1/8	6 5/8	9/32	J27245	
2 13/16			13/32	J24083	See Fig. 4	SEVEN BOLT HOLES					
2 13/16		3 7/8	3/8	J26095	See Fig. 3 (M)	5 3/16	7 3/4	6 7/8	15/32	J27294	
2 7/8			13/32	J26623	See Fig. 5	EIGHT BOLT HOLES					
2 7/8			7/16	J26374	See Fig. 2	2 3/4	4 7/16	3 9/16	1/2	J17829	(.020 Alumn.)
2 7/8			7/16	J26568	See Fig. 3	3	4 11/16	4	7/16	J26027	
2 7/8		3 5/8	7/16	J26079	See Fig. 6	3	4 11/16	4	29/64	J26212	(M)
3	4 1/2	3 5/8	5/16	J27965		3 1/8	4 15/32	3 23/32	15/32	J27043	(M)
3	4 1/2	3 7/8	17/64	J27967		3 7/32	4 23/32	4	13/32	J27966	
3 1/8		4 1/4	17/32	J26115	See Fig. 5 (M)	3 1/4	4 11/16	3 15/16	15/32	J27198	
3 5/8			13/32	J26108	See Fig. 5 (M)	3 1/4	4 11/16	4	7/16	J26347	(M)
3 3/16		4 1/4	13/32	J26102	See Fig. 3 (M)	3 3/8	4 11/16	3 15/16	15/32	J26253	
3 11/32			15/32	J26638	See Fig. 5	4	5 17/32	4 3/4	15/32	J26758	
3 13/32			3/8	J26424	See Fig. 11	4	5 9/16	4 3/4	17/32	J26193	
3 13/32	5 1/16		15/32	J26123	See Fig. 8	4 1/4	5 7/8	5 1/8	7/16	J26831	
3 1/2	5 1/8	4 3/8	9/32	J27124		4 15/32	6 5/8	5 1/2	5/8	J27385	
3 3/4	5 3/4	5	9/32	J27126		4 1/2	5 7/8	5 1/8	15/32	J27076	
3 7/8	4 13/16	4 3/8	7/32	J27351		4 9/16	6 3/16	5 5/16	9/16	J14713	
4	5 7/8	5 1/8	13/32	J27128		4 9/16	6 3/16	5 5/16	9/16	J26133	
4 1/4	6 1/4	5 1/4	17/32	J27337	See Fig. 12	5 3/4	8 7/16	7 1/8	5/8	J27974	
FIVE BOLT HOLES						5 13/16	8 1/2	7 1/8	11/16	J27352	
2 19/21	4 5/16		13/32	J27961	See Fig. 13 (M)	6	8 3/8	7	21/32	J26077	
2 15/16	4 3/4	3 13/16		J27962	See Fig. 13 (P)	6	8 1/2	7 3/16	3/4	J27754	
3 5/32			17/32	J26640	See Fig. 14	6 7/8	8 5/8	7 5/8	13/32	J27188	
3 1/4	5 1/4		15/32	J27070	See Fig. 13	NINE BOLT HOLES					
4 1/16	5 3/8	4 13/16	11/32	J27251		5 3/4	8		9/16	J27184A	See Fig. 18
4 3/4	6 1/4	5 1/2	3/8	J27946		TEN BOLT HOLES					
SIX BOLT HOLES						5 5/8	8 1/2	7 1/8	3/4	J27602	See Fig. 19
2 15/16	4 3/32	3 7/16	13/32	J27042	See Fig. 15	TWELVE BOLT HOLES					
3	4 1/2	3 7/8	9/32	J27958		4 1/4	6 1/8	5 1/4	17/32	J27417	
3 3/16	4 7/16	3 3/4	13/32	J26024	See Fig. 15	4 3/4	6 1/4	5 1/2	11/32	J27963	
3 5/16	4 1/2	4 3/32	7/32	J27956		5 1/16	6 11/16	5 3/4	17/32	J27442	
3 5/16	4 3/4	4	7/16	J26288		5 11/16	7 7/16	6 1/2	17/32	J27575	
3 5/16	5	4 3/8	9/32	J27957		FIFTEEN BOLT HOLES					
3 3/8	4 3/4	4 1/32	7/16	J27018		6	8 1/4		5/8	J27624	See Fig. 20
3 1/2	5 1/4	4 1/2	11/32	J27125							

Axle Shaft Gaskets



Figure 2



Figure 3



Figure 4

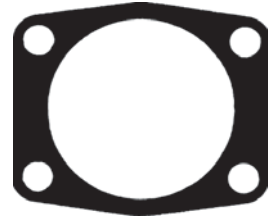

Figure 5

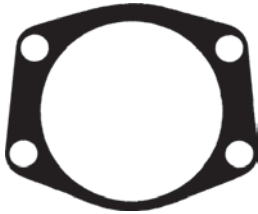

Figure 6



Figure 7

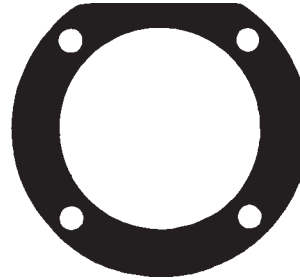

Figure 8

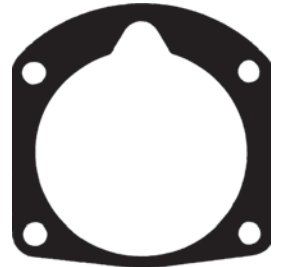

Figure 11

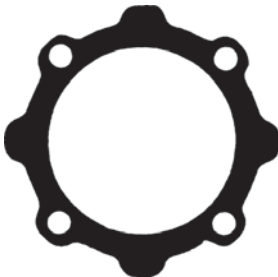

Figure 12



Figure 13

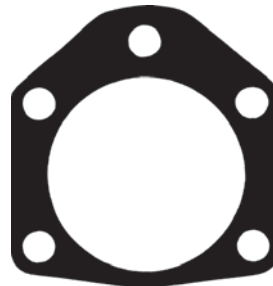

Figure 14

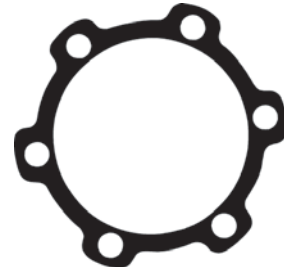

Figure 15

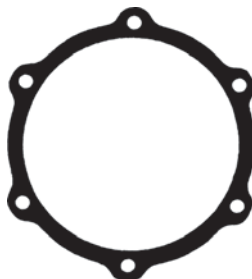

Figure 16



Figure 17

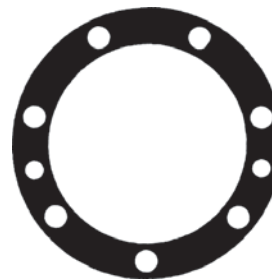

Figure 18

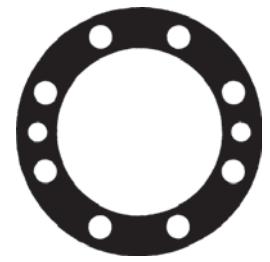

Figure 19

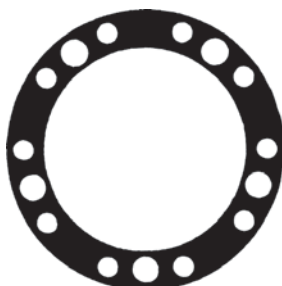

Figure 20

Axle Model Identification

Ford - Ford Light Truck - Lincoln - Mercury

Axle Model Prefix	Ring Gear O.D.	Figure Number	Part Number	Axle Model Prefix	Ring Gear O.D.	Figure Number	Part Number
WCD	9	10	P27929	WEE	9	10	P27929
WCL	7 3/4	9	P27807	WEF	9 3/8	10	P27929
WCL	8	9	P27807	WER	8.7	7A	P18561
WCU	9	10	P27929	WES	9	10	P27929
WCY	9	10	P27929	WEV	9	10	P27929
WCZ	8	9	P27807	WFA	9	10	P27929
WDC	9	10	P27929	WFB	9	10	P27929
WDD	9	10	P27929	WFC	9	10	P27929
WDE	9	10	P27929	WFD	9	10	P27929
WDJ	8	9	P27807	WFE	9	10	P27929
WDK	8	9	P27807	WFG	9	10	P27929
WDL	9	10	P27929	WFH	9 3/8	10	P27929
WDM	9	10	P27929	WFJ	8	9	P27807
WDO	9	10	P27929	WFK	8	9	P27807
WDT	8	9	P27807	WFL	8	9	P27807
WDT	9 3/8	10	P27929	WFN	9 3/8	10	P27929
WDV	6 3/4	8	P27592	WFS	8	45	P27603
WDW	8	9	P27807	WFT	9	10	P27929
WDY	8	9	P27807	WFU	9	10	P27929
WDZ	8	9	P27807	WJV	9	10	P27929
WEA	8	9	P27807	WFZ	6 3/4	8	P27592
WEB	9	10	P27929	WGA	9 3/8	10	P27929
WEC	9	10	P27929	WGB	9	10	P27929
WED	9	10	P27929	WGF	6 3/4	8	P27592

Passenger Car Axle Gaskets ("P" Series)

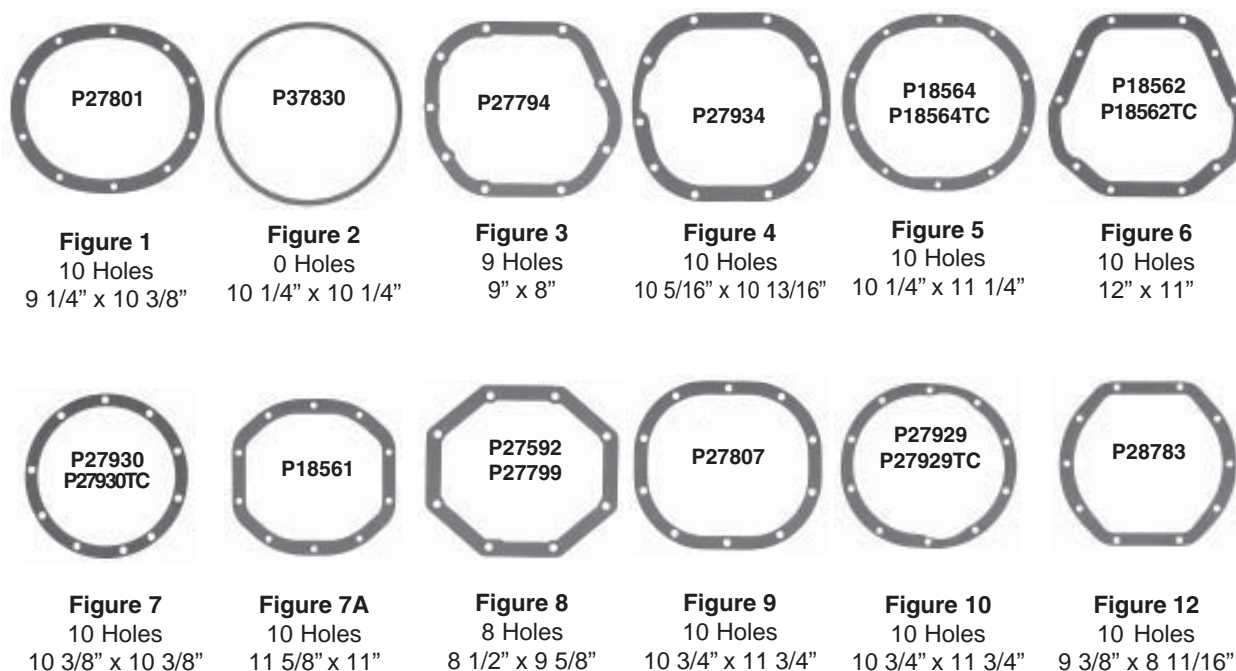

Passenger Car Axle Gaskets ("P" Series)



P38146
Figure 13
 8 Holes
 7 7/8" x 6 1/4"



P27643
Figure 14
 12 Holes
 10 3/4" x 10 1/8"



P27768T
P27768TC
Figure 15
 10 Holes
 10 7/16" x 9 3/8"



P27938
Figure 16
 8 Holes
 10" x 10"



P28784
Figure 18
 10 Holes
 8 5/8" x 10 1/4"



P28883
Figure 19
 9 Holes
 8 7/8" x 12"



P27820
Figure 20
 10 Holes
 10 1/16" x 10 7/16"



P27939
Figure 21
 10 Holes
 11 x 10 1/8"



P27857
P27857TC
Figure 22
 10 Holes
 11" x 10 1/4"



P27943
Figure 23
 10 Holes
 10 3/4" x 10 3/4"



P18560
Figure 24
 10 Holes
 11" x 11 3/8"



P38147
Figure 25
 8 Holes
 8" x 8 1/2"



P27944
P27944TC
Figure 26
 12 Holes
 10 5/8" x 10 15/16"



P18563
Figure 27
 12 Holes
 11 1/8" x 10 3/4"



P27850
Figure 28
 12 Holes
 10 7/8" x 11"



P27853
Figure 29
 12 Holes
 11 3/4" x 11 3/4"



P28909
Figure 30
 12 Holes
 11 1/2" x 11 1/8"



P27933
Figure 31
 14 Holes
 10 7/8" x 10 7/8"



P27870
Figure 32
 10 Holes
 10 1/4" x 9 5/8"



P27871
Figure 33
 10 Holes
 9 7/8" x 8 5/8"



P27872
Figure 34
 10 Holes
 10 9/16" x 9 9/16"



P37572
Figure 35
 6 Holes
 7 1/2" x 8"



P29352
P29352TC
Figure 41
 12 Holes
 11 3/8" x 12 1/8"



P27603
Figure 45
 10 Holes
 9 1/8" x 8 3/4"



P29105
Figure 61
 10 Holes
 9 1/8" x 9 1/8"



P27994
P27994TC
Figure 63
 10 Holes
 10 3/4" x 11 3/4"



P27782TC
Figure 67
 10 Holes
 9 13/16" x 11 3/8"



P27659
P37659
Figure 68
 10 Holes
 9 13/16" x 10 3/8"



P29325
Figure 69
 10 Holes
 11 7/8" x 11 7/8"



P27846
Figure 70
 10 Holes
 10 3/4" x 10 3/4"

Passenger Car Axle Gaskets ("P" Series)



P27629

Figure 72
8 Holes
8 1/8" x 8 1/8"



P27637

Figure 73
13 Holes
10 3/4" x 8"



P29078

Figure 74
10 Holes
9 3/8" x 8 3/8"



P29068

Figure 75
8 Holes
7 3/8" x 7 3/8"



P29071

Figure 77
8 Holes
7 1/4" x 7 1/4"



P29072

Figure 78
8 Holes
7 7/8" x 7 7/8"



P29073

Figure 79
8 Holes
8 1/8" x 8 1/8"



P29074

Figure 80
8 Holes
8 1/2" x 6 1/2"



P29075

Figure 81
8 Holes
8 3/4" x 9 1/2"



P29076

Figure 82
10 Holes
9 1/2" x 8"



P29082

Figure 85
10 Holes
8 3/4" x 8 3/4"



P27139TC

Figure 88
10 Holes
9 11/16" x 10 7/8"



P27609TC

Figure 89
8 Holes
8 3/8" x 8 3/4"



P27608TC

Figure 90
10 Holes
10 9/16" x 11"



P38148TC

Figure 91
9 Holes
9 5/8" x 8 7/16"



P38156

Figure 92
10 Holes
9 7/16" x 10 1/4"



P38149

Figure 94
8 Holes
8" x 9"



P38150

Figure 95
8 Holes
8" x 8 1/4"



P38151TC

Figure 96
10 Holes
9 11/16" x 10 3/4"

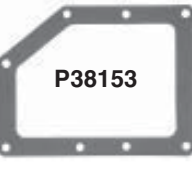

P38153

Figure 98
8 Holes
5 3/8" x 7"



P38164TC

Figure 109
10 Holes
9 5/8" x 9 7/8"



P38165TC

Figure 110
10 Holes
10 5/8" x 10 7/8"

Ford Transmission Identification

All Ford vehicles have a Vehicle Certification Label located on the driver's door or post frame. Refer to the code stamped in the space marked

"TRANS" and use this chart to identify the transmission.

"TRANS" CODE	YEAR	TRANSMISSION	"TRANS" CODE	YEAR	TRANSMISSION
4	1966	C-6	S	1977-80	JATCO
4	1963-65	AUTO DUAL RANGE	T	1980-85	AUTOMATIC
6	1966	C-4	U	1966-80	C-6
6	1963-65	C-4 DUAL RANGE	V	1974-85	C-3
7	1966	FX	W	1967-81	C-4
8	1966	MX	X	1967-81	FX, FMX
B	1981-85	ATX	Y	1968	MX
C	1982-85	C-5	Z	1967-79	C-6 POLICE
O	1984-87	ATX			

Transmission Nomenclature Chart

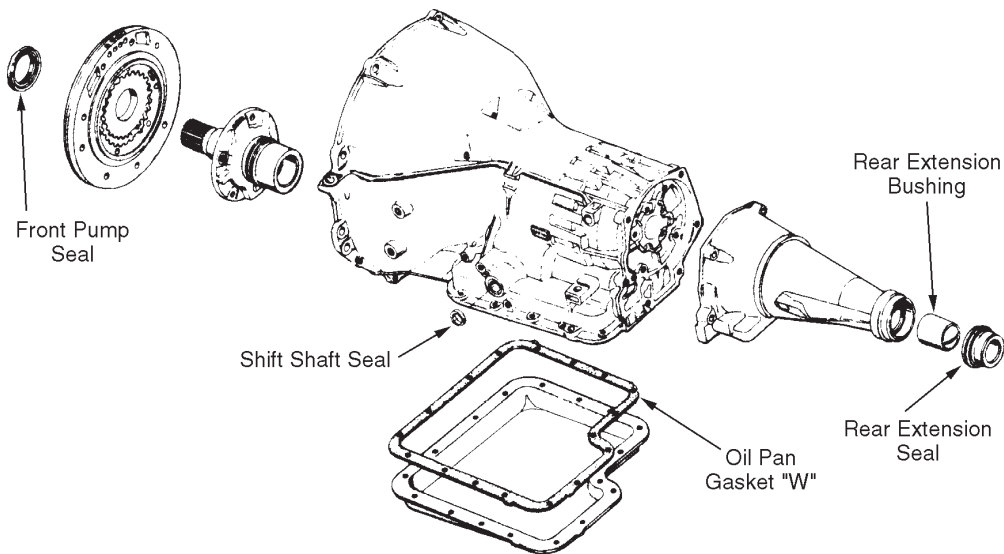

Passenger Car Automatic Transmission Oil Pan Gaskets

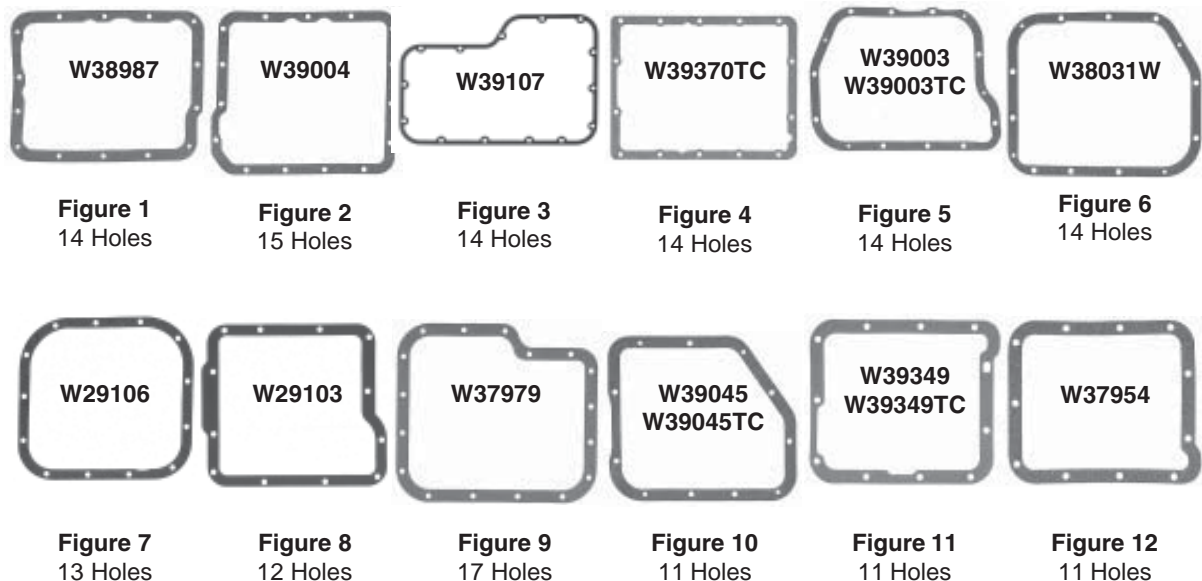

Passenger Car Automatic Transmission Oil Pan Gaskets



W37953

Figure 13
11 Holes



W29102

Figure 14
10 Holes



W39346
W39346TC

Figure 15
17 Holes



W38986

Figure 16
14 Holes



W29101
W39109

Figure 18
13 Holes



W29099TC

Figure 19
15 Holes



W39007

Figure 20
14 Holes



W38765

Figure 21
14 Holes



W39108

Figure 22
14 Holes



W39341
W39341TC

Figure 23
13 Holes



W39347

Figure 24
13 Holes



W39012

Figure 25
13 Holes



W39348
W39348TC

Figure 26
13 Holes

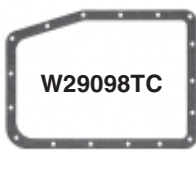

W29098TC

Figure 27
17 Holes



W29097

Figure 28
16 Holes



W37978

Figure 29
13 Holes



W39081

Figure 30
14 Holes



W29051

Figure 31
14 Holes



W38429TC

Figure 32
13 Holes



W38430

Figure 33
14 Holes



W39355

Figure 34
14 Holes



W39356TC

Figure 35
16 Holes



W39357

Figure 36
12 Holes



W39361TC

Figure 37
16 Holes



W39365
W39365TC

Figure 38
16 Holes



W38795TC

Figure 40
14 Holes



W39368TC

Figure 41
11 Holes



W37731TC

Figure 48
10 Holes



W37347TC

Figure 49
10 Holes



W39369TC

Figure 50
19 Holes



W38139TC

Figure 51
10 Holes



W29080

Figure 52
0 Holes

Passenger Car Automatic Transmission Oil Pan Gaskets

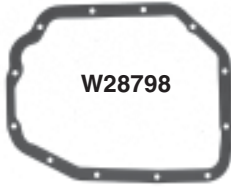

W28798

Figure 54
12 Holes



W39110
W39110TC

Figure 55
17 Holes



W39111
W39111TC

Figure 56
12 Holes



W31127TC

Figure 62
17 Holes



W31128TC

Figure 63
17 Holes



W31129TC

Figure 64
17 Holes



W31130TC

Figure 65
17 Holes



W31131TC

Figure 66
19 Holes



W31170TC

Figure 67
17 Holes



W31171TC

Figure 68
14 Holes



W31172TC

Figure 69
17 Holes



W31174TC

Figure 71
17 Holes



W31175TC

Figure 72
17 Holes



W39373TC

Figure 74
17 Holes



W39375TC

Figure 75
14 Holes



W39376TC

Figure 76
12 Holes



W39377TC

Figure 77
10 Holes



W31182TC

Figure 78
19 Holes

Axle Model Identification

Ford - Ford Light Truck - Lincoln - Mercury

Axle Model Prefix	Ring Gear O.D.	Figure Number	Part Number	Axle Model Prefix	Ring Gear O.D.	Figure Number	Part Number
WCD	9	10	P27929	WEE	9	10	P27929
WCL	7 3/4	9	P27807	WEF	9 3/8	10	P27929
WCL	8	9	P27807	WER	8.7	7A	P18561
WCU	9	10	P27929	WES	9	10	P27929
WCY	9	10	P27929	WEV	9	10	P27929
WCZ	8	9	P27807	WFA	9	10	P27929
WDC	9	10	P27929	WFB	9	10	P27929
WDD	9	10	P27929	WFC	9	10	P27929
WDE	9	10	P27929	WFD	9	10	P27929
WDJ	8	9	P27807	WFE	9	10	P27929
WDK	8	9	P27807	WFG	9	10	P27929
WDL	9	10	P27929	WFH	9 3/8	10	P27929
WDM	9	10	P27929	WFJ	8	9	P27807
WDO	9	10	P27929	WFK	8	9	P27807
WDT	8	9	P27807	WFL	8	9	P27807
WDT	9 3/8	10	P27929	WFN	9 3/8	10	P27929
WDV	6 3/4	8	P27592	WFS	8	45	P27603
WDW	8	9	P27807	WFT	9	10	P27929
WDY	8	9	P27807	WFU	9	10	P27929
WDZ	8	9	P27807	WFO	9	10	P27929
WEA	8	9	P27807	WFZ	6 3/4	8	P27592
WEB	9	10	P27929	WGA	9 3/8	10	P27929
WEC	9	10	P27929	WGB	9	10	P27929
WED	9	10	P27929	WGF	6 3/4	8	P27592

Truck Axle Gaskets ("P" Series)

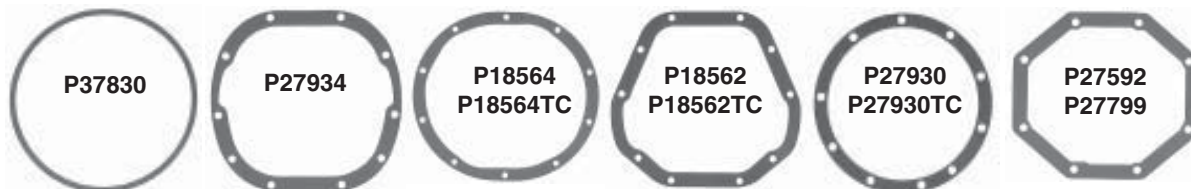

Figure 2 0 Holes 10 1/4" X 10 1/4"	Figure 4 10 Holes 10 5/16" X 10 13/16"	Figure 5 10 Holes 10 1/4" X 11 1/4"	Figure 6 10 Holes 12" X 11"	Figure 7 10 Holes 10 3/8" X 10 3/8"	Figure 8 8 Holes 8 1/2" X 9 5/8"
---	---	--	--	--	---

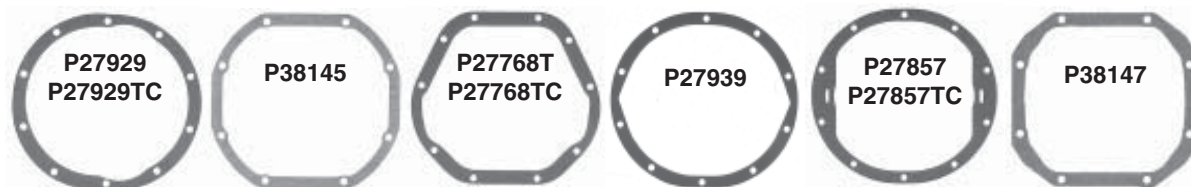

Figure 10 10 Holes 10 3/4" X 11 3/4"	Figure 11 8 Holes 9 1/2" X 8 3/4"	Figure 15 10 Holes	Figure 21 10 Holes 11" X 10 1/8"	Figure 22 10 Holes 11" X 10 1/4"	Figure 25 8 Holes 8" X 8 1/2"
---	--	------------------------------	---	---	--

Truck Axle Gaskets ("P" Series)



P27944
P27944TC

Figure 26

12 Holes
10 5/8" X 10 15/16"

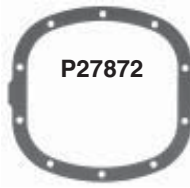

P27872

Figure 34

10 Holes
10 9/16" X 9 9/16"



P27940
P27940TC

Figure 36

12 Holes
10 7/8" X 10 7/8"



P29313A

Figure 37

10 Holes
15 5/8" X 17 1/2"

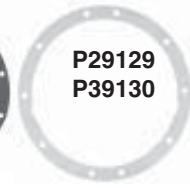

P29129
P39130

Figure 39

10 Holes
12 1/4" X 12 1/4"



P29248

Figure 40

10 Holes
13 3/4" X 13 3/4"



P29352
P29352TC

Figure 41

12 Holes
11 3/8" X 12 1/8"

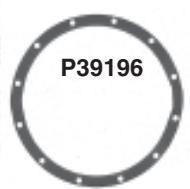

P39196

Figure 42

12 Holes
15 1/2" X 15 1/2"

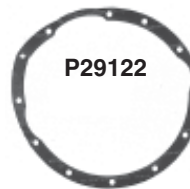

P29122

Figure 42B

12 Holes
15 3/4" X 15 1/2"

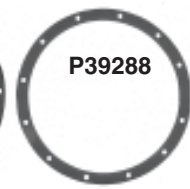

P39288

Figure 43

12 Holes
19 1/8" X 19 1/8"

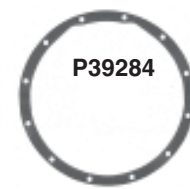

P39284

Figure 44

12 Holes
16 7/8" X 16 7/8"



P29013

Figure 44A

10 Holes
13 3/4" X 13 3/4"



P29476

Figure 44B

14 Holes
18 3/8" X 18 3/8"



P27603

Figure 45

10 Holes
9 1/8" X 8 3/4"



P28128

Figure 46

14 Holes
13" X 13"

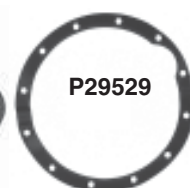

P29529

Figure 47

12 Holes
18 3/8" X 18 3/8"



P29475

Figure 49

13 Holes
17 1/2" X 17 1/4"

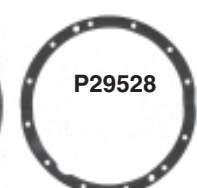

P29528

Figure 50

14 Holes
18 7/8" X 18 7/8"



P29532

Figure 51

16 Holes
16 3/4" X 16 3/4"



P29531

Figure 52

14 Holes
18" X 18"

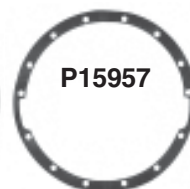

P15957

Figure 53

14 Holes
20 3/8" X 20 3/8"



P15910

Figure 54

10 Holes
14 1/2" X 14 1/2"

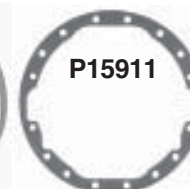

P15911

Figure 55

16 Holes
14 5/8" X 14 5/8"



P15917

Figure 58

14 Holes
16 1/8" X 16 1/8"



P29105

Figure 61

10 Holes
9 1/8" X 9 1/8"



P27994
P27994TC

Figure 63

10 Holes
10 3/4" X 11 3/4"



P27848

Figure 65

10 Holes
10 3/8" X 10 3/4"



P27846

Figure 70

10 Holes
10 3/4" X 10 3/4"

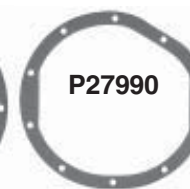

P27990

Figure 71

10 Holes
11" X 10 1/4"

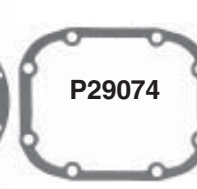

P29074

Figure 80

8 Holes
8 1/2" X 6 1/2"

Truck Axle Gaskets ("P" Series)



P27682

Figure 83
10 Holes
9 1/4" X 9 1/4"



P27880

Figure 86
8 Holes
8 1/8" X 8 1/8"



P27897

Figure 87
10 Holes
8 5/8" X 8 5/8"



P27609TC

Figure 89
8 Holes
8 3/8" X 8 3/4"



P27608TC

Figure 90
10 Holes
10 9/16" X 11"



P38156

Figure 92
10 Holes
9 7/16" X 10 1/4"

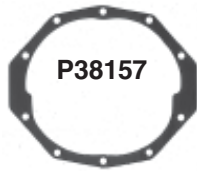

P38157

Figure 93
10 Holes
9 1/4" X 10 13/16"



P38151TC

Figure 96
10 Holes
9 11/16" X 10 3/4"



P38152TC

Figure 97
10 Holes
8 3/4" X 9"



P38154TC

Figure 99
10 Holes
9 7/8" X 10 7/8"



P38155TC

Figure 100
12 Holes
12 5/8" X 12 1/8"



P39156

Figure 102
10 Holes
13 1/2" X 13 1/2"



P27666

Figure 103
10 Holes
8 3/4" X 9 1/8"



P29139TC

Figure 104
14 Holes
12" X 13 1/4"



P29283

Figure 105
12 Holes
17 1/2" X 17 1/2"

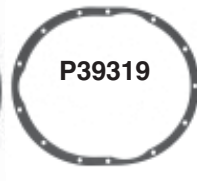

P39319

Figure 106
13 Holes
15" X 17 1/8"



P38162TC

Figure 107
10 Holes
12" X 11"

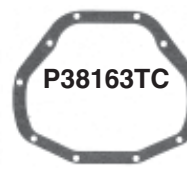

P38163TC

Figure 108
10 Holes
13 9/16" X 11 1/16"

Ford Transmission Identification

All Ford vehicles have a **Vehicle Certification Label** located on the driver's door or post frame. Refer to the code stamped in the space marked

"TRANS" and use this chart to identify the transmission.

"TRANS" CODE	YEAR	TRANSMISSION	"TRANS" CODE	YEAR	TRANSMISSION
4	1966	C-6	S	1977-80	JATCO
4	1963-65	AUTO DUAL RANGE	T	1980-85	AUTOMATIC
6	1966	C-4	U	1966-80	C-6
6	1963-65	C-4 DUAL RANGE	V	1974-85	C-3
7	1966	FX	W	1967-81	C-4
8	1966	MX	X	1967-81	FX, FMX
B	1981-85	ATX	Y	1968	MX
C	1982-85	C-5	Z	1967-79	C-6 POLICE
O	1984-87	ATX			

Transmission Nomenclature Chart

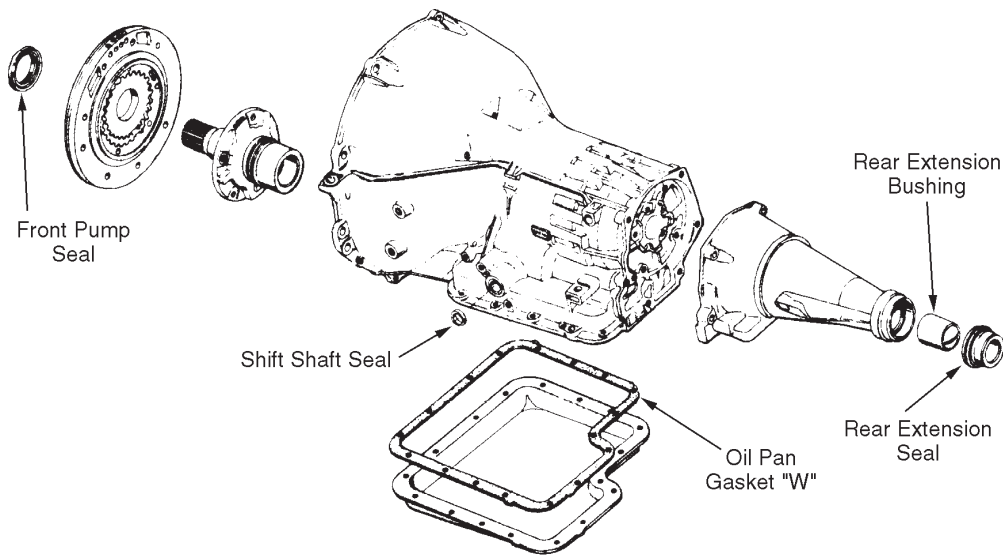

Truck Automatic Transmission Oil Pan Gaskets

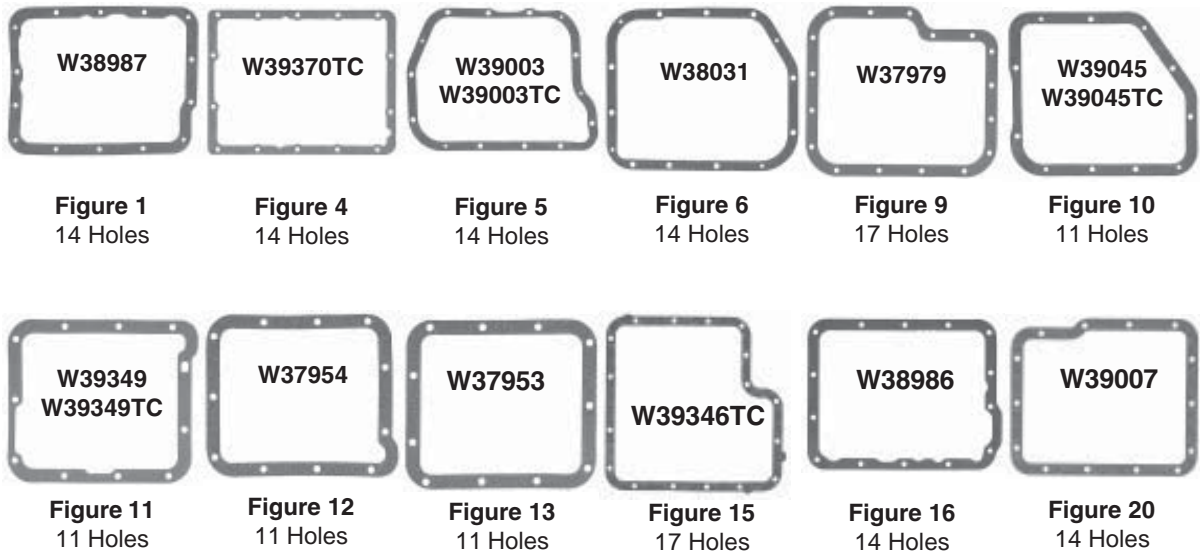

Truck Automatic Transmission Oil Pan Gaskets



Figure 23
13 Holes



Figure 26
13 Holes



Figure 29
13 Holes



Figure 30
14 Holes



Figure 31
14 Holes



Figure 33
14 Holes



Figure 38
16 Holes



Figure 40
14 Holes



Figure 48
10 Holes



Figure 49
10 Holes



Figure 52
0 Holes



Figure 57
18 Holes

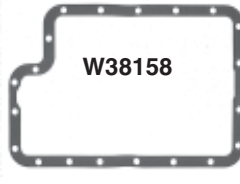

Figure 60
20 Holes



Figure 61
14 Holes



Figure 73
20 Holes



Figure 75
14 Holes



Figure 76
12 Holes



Figure 77
10 Holes

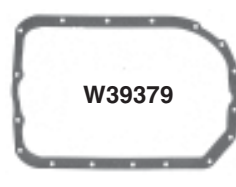

Figure 79
17 Holes

Power Take Off Gaskets



Figure 42
10 Holes



Figure 43
11 Holes



Figure 44
6 Holes



Figure 45
6 Holes

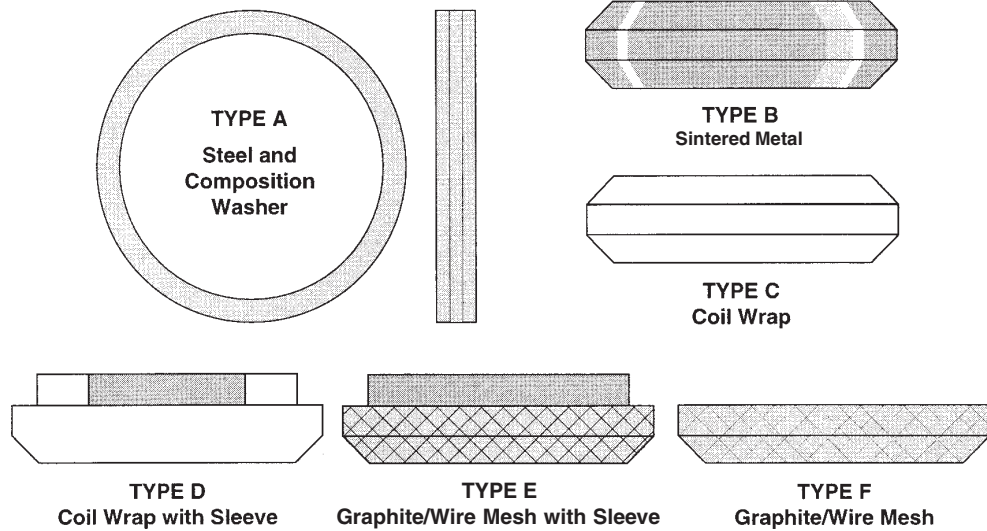

Figure 46
8 Holes



Figure 47
10 Holes

Exhaust Pipe Gaskets



Part No.	I.D.	O.D.	Width	Style	Part No.	I.D.	O.D.	Width	Style
F7130	2.275	2.880	0.125	TYPE A	F7387	1.800	2.495	0.625	TYPE B
F7139	2.531	3.000	0.600	TYPE C	F7390	1.686	2.239	0.550	TYPE B
F7139S	2.531	3.000	0.500	TYPE B	F7394	2.104	2.825	0.780	TYPE E
F7140	1.406	1.875	0.640	TYPE C	F7395	2.020	2.840	0.550	TYPE F
F7171	1.805	2.415	0.685	TYPE D	F7398	1.765	2.335	0.515	TYPE F
F7186	2.270	2.755	0.575	TYPE C	F7399	2.335	2.895	0.675	TYPE E
F7187	2.075	2.745	0.695	TYPE D	F7407	1.494	2.270	0.754	TYPE E
F7197	2.110	2.735	0.770	TYPE C	F7412	2.070	2.390	0.167	TYPE A
F7199	2.275	2.750	0.563	TYPE B	F7413	2.020	2.370	0.167	TYPE A
F7201	2.150	2.755	0.561	TYPE B	F7417	2.300	3.760	0.070	TYPE A
F7202	1.980	2.658	0.560	TYPE B	F7419	2.560	4.180	0.070	TYPE A
F7207	2.345	2.895	0.680	TYPE E	F7424	2.244	2.795	0.472	TYPE F
F7208	1.910	2.460	0.673	TYPE D	F7428	1.860	2.322	0.490	TYPE F
F7209	1.765	2.335	0.515	TYPE F	F7437	1.772	2.323	0.591	TYPE F
F7210	2.020	2.580	0.515	TYPE F	F7442	2.838	3.622	0.512	TYPE F
F7211	1.670	2.345	0.590	TYPE F	F7447	1.726	2.530	0.860	TYPE E
F7212	1.820	2.475	0.680	TYPE E	F7448	1.940	2.609	0.787	TYPE F
F7215	2.600	2.960	0.170	TYPE A	F7452	2.110	2.789	0.750	TYPE B
F7218	1.595	2.250	0.655	TYPE D	F7454	5.085	5.650	0.200	TYPE A
F7219	2.104	2.750	0.635	TYPE E	F7458	1.750	2.575	0.100	TYPE A
F7267	1.700	2.340	0.875	TYPE E	F7459	2.760	3.220	0.100	TYPE A
F7269	1.742	2.542	0.850	TYPE E	F7460	2.450	3.085	0.100	TYPE A
F7270	1.702	2.342	0.970	TYPE E	F7461	2.150	2.640	0.195	TYPE A
F7271	1.954	2.585	0.790	TYPE E	F7463	1.715	2.255	0.205	TYPE A
F7273	1.550	2.154	0.205	TYPE A	F7466	2.520	3.400	0.780	TYPE F
F7274	1.385	1.712	0.394	TYPE C	F7467	1.942	2.285	0.180	TYPE A
F7275	2.305	3.128	0.768	TYPE F	F7468	1.965	2.350	0.157	TYPE A
F7276	1.735	2.093	0.434	TYPE B	F7469	2.000	2.252	0.590	TYPE F
F7281	1.780	2.109	0.161	TYPE A	F7479	2.435	2.758	0.158	TYPE A
F7282	2.135	2.454	0.161	TYPE A	F7481	1.900	2.250	0.713	TYPE A
F7283	1.688	2.010	0.165	TYPE A	F7482	2.225	2.558	0.165	TYPE A
F7355	1.778	2.265	0.538	TYPE C	F7493	1.740	2.100	0.186	TYPE A

Exhaust Pipe Gaskets

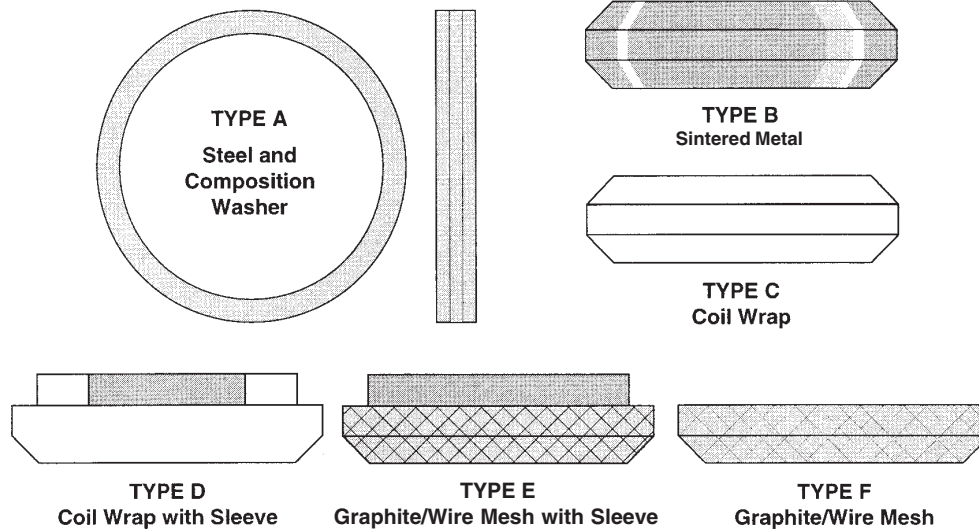

Part No.	I.D.	O.D.	Width	Style	Part No.	I.D.	O.D.	Width	Style
F7505	2.259	2.790	0.658	TYPE F	F10148	2.122	2.700	0.630	TYPE F
F7507	2.126	2.778	0.710	TYPE E	F10151	1.962	2.400	0.200	TYPE A
F7514	2.269	3.226	0.600	TYPE F	F12298	2.020	2.694	0.625	TYPE F
F7515	2.300	3.000	0.778	TYPE F	F12329	1.693	2.008	0.157	TYPE A
F7516	2.000	2.580	0.515	TYPE F	F12330	1.772	2.325	0.591	TYPE F
F7517	2.030	2.590	0.531	TYPE F	F12331	2.008	2.559	0.591	TYPE F
F7519	2.500	2.972	0.512	TYPE F	F12368	2.200	2.520	0.460	TYPE F
F7520	3.012	3.730	0.571	TYPE F	F12387	2.067	2.400	0.165	TYPE A
F7521	2.460	3.052	0.857	TYPE E	F12433	2.336	3.048	0.699	TYPE F
F7523	2.273	2.859	0.571	TYPE F	F12434	2.128	2.720	0.699	TYPE F
F7549	2.275	2.726	0.500	TYPE F	F14592	1.765	2.260	0.230	TYPE A
F7572	1.920	2.450	0.200	TYPE A	F14594	2.205	2.705	0.210	TYPE A
F7573	1.720	2.350	0.200	TYPE A	F14595	1.450	1.937	0.230	TYPE A
F9835K	2.312	2.625	0.100	TYPE A	F14596	1.570	2.095	0.230	TYPE A
F9999	2.500	3.310	0.075	TYPE A	F14615	1.384	1.705	0.165	TYPE A
F10038	2.430	2.940	0.215	TYPE A	F14616	2.350	2.728	0.205	TYPE A
F10039	1.969	2.559	0.200	TYPE A	F14617	1.629	1.942	0.157	TYPE A
F10082	1.814	2.314	0.747	TYPE B	F14618	1.506	1.807	0.157	TYPE A
F10085	2.275	2.700	0.605	TYPE F	F14619	1.400	1.735	0.165	TYPE A
F10091	2.260	2.570	0.160	TYPE A	F17250	2.018	2.510	0.630	TYPE C
F10105	1.790	2.040	0.100	TYPE A	F17250S	2.018	2.510	0.630	TYPE B
F10106	1.665	1.922	0.098	TYPE A	F17251	1.560	2.015	0.655	TYPE C
F10107	1.800	2.258	0.534	TYPE B	F17355	1.719	2.375	0.625	TYPE C
F10108	1.975	1.280	0.165	TYPE A	F17945	1.860	2.745	0.790	TYPE B
F10109	1.822	2.367	0.522	TYPE B	F17946	2.135	3.120	0.775	TYPE B
F10111	1.766	2.270	1.000	TYPE B	F17947	2.400	3.120	0.800	TYPE B
F10115	2.170	2.529	0.573	TYPE F	F17990	1.734	2.632	1.217	TYPE B
F10119	1.980	2.332	0.573	TYPE F	F17991	2.962	3.710	0.539	TYPE F
F10121	1.500	1.845	0.165	TYPE A	F20223	2.040	2.395	0.435	TYPE B
F10139	2.600	3.300	0.675	TYPE F	F20252	1.960	2.565	0.190	TYPE A
F10140	1.933	2.500	0.860	TYPE E	F20257	2.585	3.115	0.193	TYPE A
F10143	2.165	2.862	0.675	TYPE F	F20371	2.060	2.475	0.205	TYPE A
F10144	2.165	2.862	0.866	TYPE E	F20423	2.225	2.905	0.755	TYPE E

Valve Stem Seal Specification Chart

Contains Popular Valve Seal Dimensions and Material Types

O - Ring Type

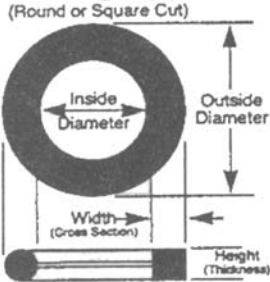

Shedder Type

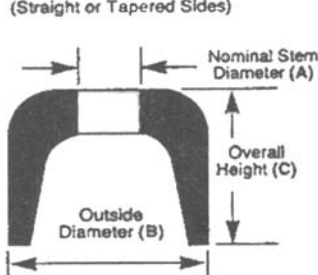

Positive Type

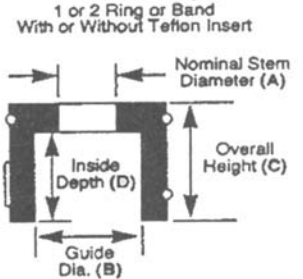

O-Ring Type

Part No.	Inside Dia.	Outside Dia.	Width	Height	Material	Detail
B20212	.250	.502	.126	.126	Nitrile	O Ring
B45229	.280	.404	.062	.084	Nitrile	Square Cut
B45429	.272	.472	.100	.102	Polyacrylic	Square Cut
B45562	.306	.465	.084	.084	Nitrile	O Ring

Shedder Type

Part No.	Stem Dia. (A)	Outside Dia. (B)	Overall Height (C)	Material	Detail
B45320	.311	.860	.700	Nitrile	Includes Spring Retainer
B45483	.312	.710	.490	Silicone	
B45405	.341	.650	1.180	Nylon	
B45264	.341	.760	.580	Nitrile	
B45779	.341	.760	.580	Silicone	Orange
B45416	.341	.840	.370	Nylon	
B45298	.341	.900	.690	Nitrile	
B45399	.341	.900	.700	Polyacrylic	
B45373	.341	.900	.560	Polyacrylic	
B45283	.341	.900	.460	Nitrile	Orange
B45662	.372	.820	.545	Nylon	
B45690	.372	.850	.735	Nylon	
B45296	.372	.870	.810	Silicone	
B45323	.372	.900	.735	Nitrile	
B45343	.372	.900	.800	Polyacrylic	
B45327	.372	.900	.315	Nitrile	
B45624	.372	.900	.315	Fluoroelastom	
B45436	.372	.900	.615	Polyacrylic	
B45390	.372	.900	.700	Nitrile	
B45377	.435	.830	1.150	Nitrile	
B45387	.435	.940	.800	Polyacrylic	

Valve Stem Seal Material Maximum Operating Temperatures

Nitrile.....250°F Fluoroelastomer400°F
 Polyacrylic.....325°F Teflon550°F

Valve Stem Seal Specification Chart

Positive Type

Part No.	Perfect Circle Ref#	Nominal Stem Diameter (A)		Guide Outside Diameter (B)		Overall Height (C)	Inside Depth (D)	Material	Detail
B45471		.167	4.25mm	.295	7.5mm	.295	.150	Polyacrylic	Metal Jacket
B45627		.175		.430		.395	.275		Metal Jacket
B45630		.175		.430		.395	.275		Metal Jacket
B45722		.178		.363		.456	.306		Metal Jacket
B45626		.185		.431		.400	.275		Metal Jacket
B45629		.185		.431		.400	.275		Metal Jacket
B45866		.194		.420		.417	.272		Metal Jacket
B45735		.195		.425		.320	.220		Metal Jacket
B45677		.203		.425		.410	.265		Metal Jacket
B45792		.203		.426		.409	.268		Metal Jacket
B45549		.203		.427		.395	.258		Metal Jacket
B45556		.203		.427		.395	.258		Metal Jacket
B45657		.203		.427		.395	.258		Metal Jacket
B45830		.203		.433		.403	.258		Metal Jacket
B45845		.205		.425		.400	.285		Metal Jacket
B45736		.205		.430		.318	.220		
B45831		.205		.430		.386	.252		Metal Jacket
B45791		.210		.425		.385	.251		Metal Jacket
B45622		.214		.466		.469	.320		Metal Jacket
B45870		.215		.420		.420	.285		Metal Jacket
B45440		.216	5.5 mm	.346	8.8 mm	.345	.220	Fluoroelast.	
B45658		.216		.397		.455	.300		Metal Jacket
B45595		.217		.465		.395	.262		Metal Jacket
B45883		.219		.463		.467	.317		Metal Jacket
B45776		.225		.365		.355	.300		Metal Jacket
B45498		.225		.370		.375	.281		Metal Jacket
B45618		.225		.370		.375	.281		Metal Jacket
B45594		.225		.435		.335	.216		
B45564		.230		.457		.509	.377		Metal Jacket
B45678		.231		.463		.396	.266		Metal Jacket
B45475		.234		.423		.445	.311		Metal Jacket
B45454		.236		.368		.375	.269		Metal Jacket
B45563		.236		.465		.425	.300		Metal Jacket
B45733		.237		.465		.585	.455		Metal Jacket
B45746	D1208	.248		.385		.510	.330	Teflon	
B45814		.249		.456		.482	.339		
B45448		.259	6.6 mm	.393	10.0 mm	.310	.190	Polyacrylic Polyacrylic	
B45524		.259	6.6 mm	.393	10.0 mm	.320	.190		
B45544		.259		.415		.400	.335		Metal Jacket
B45472		.259		.415		.400	.335		Metal Jacket
B45459		.259	6.6 mm	.476	12.1 mm	.340	.210	Polyacrylic	Silver Ring
B45460		.259	6.6 mm	.476	12.1 mm	.340	.210	Polyacrylic	Black Ring
B45521		.259	6.6 mm	.476	12.1 mm	.345	.210	Fluoroelast.	Black Ring
B45499		.259	6.6 mm	.476	12.1 mm	.345	.210	Fluoroelast.	Black Ring
B45438		.259	6.6 mm	.476	12.1 mm	.370	.230	Nitrile	Silver Ring
B45439		.259	6.6 mm	.476	12.1 mm	.370	.230	Nitrile	Black Ring
B45442		.259	6.6 mm	.476	12.1 mm	.470	.300	Polyacrylic	Metal Jacket
B45857	T1307M	.260		.491		.507	.333	Teflon	
B45790		.260		.506		.507	.380	Viton	Metal Jacket
B45806		.260		.506		.507	.380	Viton	Metal Jacket

Valve Stem Seal Specification Chart

O - Ring Type (Round or Square Cut)

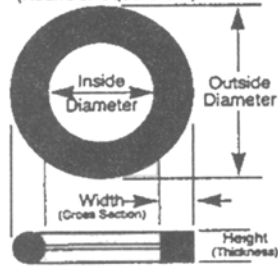

Shedder Type (Straight or Tapered Sides)

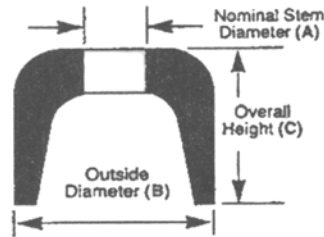

Positive Type

1 or 2 Ring or Band
With or Without Teflon Insert

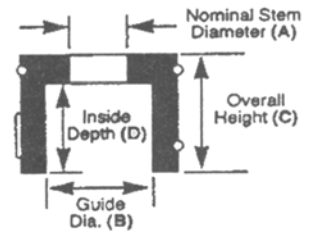

Positive Type (Cont'd)

Part No.	Perfect Circle Ref#	Nominal Stem Diameter (A)		Guide Outside Diameter (B)		Overall Height	Inside Depth	Material	Detail
B45445		.271		.535		.535	.385		Metal Jacket
B45545		.273		.467		.539	.420		
B45480		.275	7.0 mm	.406		.375	.200	Teflon	
B45625		.275	7.0 mm	.433	11.0 mm	.390	.270	Fluoroelast.	Metal Jacket
B45571		.275	7.0 mm	.455	11.6 mm	.400	.210	Polyacrylic	Metal Jacket
B45476		.275	7.0 mm	.465	11.6 mm	.395	.235	Polyacrylic	Metal Jacket
B45474		.275	7.0 mm	.472	12.0 mm	.610	.445	Polyacrylic	Metal Jacket
B45588		.275	7.0 mm	.476	12.1 mm	.500	.360	Polyacrylic	Metal Jacket
B45590		.275	7.0 mm	.476	12.1 mm	.390	.220	Polyacrylic	Metal Jacket
B45465		.275	7.0 mm	.476	12.1 mm	.460	.325	Polyacrylic	Metal Jacket
B45447		.275	7.0 mm	.476	12.1 mm	.460	.325	Polyacrylic	Metal Jacket
B45672		.275	7.0 mm	.511	13.0 mm	.515	.355	Fluoroelast.	Metal Jacket
B45799		.275		.515		.515	.376		Metal Jacket
B45799A		.275		.515		.515	.376		Metal Jacket
B45799B		.275		.515		.515	.376		Metal Jacket
B45799C		.275		.515		.515	.376		Metal Jacket
B20192		.276		.413		.399	.279		Metal Jacket
B45683		.278		.465		.455	.305		Metal Jacket
B45839		.278		.498		.537	.421		Metal Jacket
B45798		.278		.521		.521	.380		Metal Jacket
B45798A		.278		.521		.521	.380		Metal Jacket
B45798B		.278		.521		.521	.380		Metal Jacket
B45798C		.278		.521		.521	.380		Metal Jacket
B45458		.278		.547		.619	.481		
B45840		.280		.495		.540	.418		Metal Jacket
B45679		.281		.505		.400	.259		Metal Jacket
B45900		.283		.459		.381	.295		Metal Jacket
B45674		.290		.357		.373	.260		Metal Jacket
B45888	D1610	.290		.463		.515	.350	Teflon	Silver Band
B45457		.290		.545		.475	.251		
B45796		.293		.545		.500	.359		Metal Jacket
B45601		.295		.385		.437	.300		Metal Jacket
B45485		.297		.533		.369	.221		Metal Jacket
B20169		.305		.460		.438	.339		
B45904		.306		.548		.588	.450		Metal Jacket
B45602		.309		.573		.548	.335		Metal Jacket
B45567		.310		.432		.349	.232		
B45767	9010	.311		.415		.510	.330	Teflon	

Valve Stem Seal Specification Chart

Positive Type (Cont'd)

Part No.	Perfect Circle Ref#	Nominal Stem Diameter (A)		Guide Outside Diameter (B)		Overall Height	Inside Depth	Material	Detail
B45546	RDDYR	.311		.428		.362	.200	Fluoroelast.	w/Teflon Insert
B45423	9110	.311		.428		.375	.200	Teflon	
B20311	1610	.311		.500		.500	.330	Nitrile	
B45753	D1710	.311		.531		.510	.330	Teflon	
B45613	RDDZR	.312		.472		.380	.210	Fluoroelast.	
B45612		.312	8.0 mm	.512		.480	.310	Fluoroelast.	Orange
B45611		.312	8.0 mm	.512		.480	.310	Fluoroelast.	Black
B45576		.312	8.0 mm	.543		.480	.310	Fluoroelast.	Red Band
B45575		.312	8.0 mm	.543		.480	.310	Fluoroelast.	Silver Band
B20183		.314	8.0 mm	.474	12.0 mm	.545	.310	Polyacrylic	
B45449		.314	8.0 mm	.492	12.5 mm	.545	.350	Fluoroelast.	No Band or Ring
B45437		.314	8.0 mm	.500	12.7 mm	.585	.480	Polyacrylic	Metal Jacket
B45565		.314	8.0 mm	.500	12.7 mm	.645	.460	Polyacrylic	Metal Jacket
B20219		.314	8.0 mm	.512	13.0 mm	.364	.230	Polyacrylic	Metal Jacket
B45441		.314	8.0 mm	.512	13.0 mm	.510	.350	Polyacrylic	Metal Jacket
B45434		.314	8.0 mm	.512	13.0 mm	.650	.480	Polyacrylic	Metal Jacket
B20211		.314	8.0 mm	.512	13.0 mm	.760	.630	Polyacrylic	Metal Jacket
B45548		.314	8.0 mm	.551	14.0 mm	.430	.290	Polyacrylic	Metal Jacket
B45490		.314	8.0 mm	.551	14.0 mm	.510	.360	Polyacrylic	Metal Jacket
B45747	D12MS08	.315	8.0 mm	.472	12.0 mm	.375	.200	Teflon	
B45531		.315	8.0 mm	.514	13.1 mm	.395	.240	Polyacrylic	Metal Jacket
B45410	D18H08M	.315	8.0 mm	.562		.480	.310	Fluoroelast.	Silver Band
B45411	R18L08M	.315	8.0 mm	.562		.480	.310	Fluoroelast.	Exh – Red Band
B45411A	R18L08M	.315	8.0 mm	.562		.480	.310	Fluoroelast.	Silver Band
B45568		.320		.950		.422	.387		Metal Jacket
B45603		.322		.572		.595	.305		Metal Jacket
B45773		.326		.479		.380	.210	Fluoroelast.	
B20218		.334	8.5 mm	.551	14.0 mm	.467	.315	Polyacrylic	Metal Jacket
B45623		.338		.541		.560	.420		
B45770		.341	8.7mm	.500	12.7mm	.390	.240	Fluoroelast.	Metal Jacket
B45749	1611	.341		.500		.500	.330	Nitrile	w/Teflon Insert
B45473	D1611	.341		.500		.510	.330	Teflon	
B45547	RDCWR	.341		.500		.530	.360	Fluoroelast.	
B45299		.341		.531		.430	.310	Nitrile	
B45739	1711	.341		.531		.500	.330	Nitrile	w/Teflon Insert
B45754	D1711	.341		.531		.510	.330	Teflon	
B45484	RGBYR	.341		.552		.480	.310	Fluoroelast.	Orange
B45404	R18B11D	.341		.562		.485	.310	Nitrile	Blue Ring
B45418	RE18E11	.341		.562		.480	.310	Fluoroelast.	Blue Band
B45591	RDCDR-C	.341		.562		.480	.310	Fluoroelast.	Pink Band
B45591A	RDCDR-C	.341		.562		.480	.310	Fluoroelast.	Blue Band
B45756	1811	.341		.562		.500	.350	Nitrile	w/Teflon Insert
B45737		.341		.562		.510	.330	Teflon	
B45566		.341	8.65mm	.575	14.6mm	.770	.470	Polyacrylic	Metal Jacket
B45758	1911	.341		.594		.500	.330	Nitrile	w/Teflon Insert
B45497	RDBZR	.341		.600		.480	.310	Fluoroelast.	Green Band
B45581		.341		.660		.480	.310	Fluoroelast.	
B45580		.341		.660		.490	.310	Fluoroelast.	Blue Band
B45748	D12M09M	.354	9.0mm	.472	12.0mm	.510	.330	Teflon	
B45752	1709M	.354	9.0mm	.531		.500	.330	Nitrile	w/Teflon Insert

Valve Stem Seal Specification Chart

O - Ring Type (Round or Square Cut)

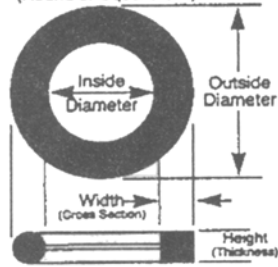

Shedder Type (Straight or Tapered Sides)

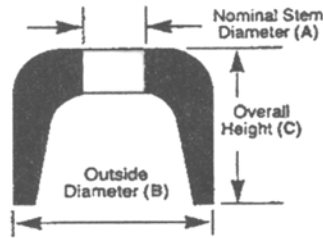

Positive Type 1 or 2 Ring or Band With or Without Teflon Insert

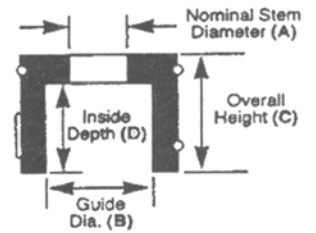

Positive Type (Cont'd)

Part No.	Perfect Circle Ref#	Nominal Stem Diameter (A)		Guide Outside Diameter (B)		Overall Height	Inside Depth	Material	Detail	
B45604		.356		.571		.595	.395	Fluoroelast.	Metal Jacket	
B45768		.357		.562		.480	.310			
B45605		.357		.575		.595	.300			
B45750	1612	.372		.500		.500	.330			
B45751	D1612	.372		.500		.510	.330	Nitrile	w/Teflon Insert	
B45755	D1712	.372		.531		.510	.330	Teflon	w/Teflon Insert	
B45740	1812	.372		.562		.500	.330	Nitrile		
B45757	R18G11H	.372		.562		.480	.310	Fluoroelast.		Blue Band
B45759	1912	.372		.594		.500	.330	Nitrile		w/Teflon Insert
B45761	20A12	.372		.620		.500	.330	Nitrile		w/Teflon Insert
B45403	R2012	.372		.625		.475	.300	Nitrile	Two Ring	
B45560	RDCLR	.372		.625		.480	.310	Fluoroelast.	w/Teflon Insert	
B45760	2012	.372		.625		.500	.330	Nitrile		
B45583		.372		.625		.540	.350	Polyacrylic		No Band/Ring
B45623		.372		.625		.570	.325	Fluoroelast.		No Band/Ring
B45631		.372		.660		.480	.310	Fluoroelast.	Int – Green	
B45632		.372		.660		.480	.310	Fluoroelast.	Exh – Black	
B45675		.374	9.5mm	.641	16.3mm	.689	.492	Fluoroelast.	Int – Metal	
B45676		.374	9.5mm	.641	16.3mm	.689	.492	Fluoroelast.	Exh – Metal	
B45420	1810M	.393	10.0mm	.562		.500	.330	Nitrile	w/Teflon Insert	
B45762	2013	.404		.625		.500	.330	Nitrile	w/Teflon Insert	
B45764	20A14	.434		.620		.500	.330	Nitrile	w/Teflon Insert	
B45763	2014	.434		.625		.500	.330	Nitrile	w/Teflon Insert	
B45765	2214	.434		.687		.500	.330	Nitrile	w/Teflon Insert	
B45766	6040	.450		.660		.500	.330	Nitrile	w/Teflon Insert	
B45741	2216	.500		.687		.500	.330	Nitrile	w/Teflon Insert	

Valve Stem Seal Specification Chart Numerical List

Part No.	Std. Pkg.	Type	Nominal Stem Dia.	Part No.	Std. Pkg.	Type	Nominal Stem Dia.
B20169	8	Positive	.305	B45480	8	Positive	.275
B20183	8	Positive	.314	B45483	4	Shedder	.312
B20184	8	O-Ring	.245	B45484	6	Positive	.341
B20192	8	Positive	.276	B45485	8	Positive	.297
B20211	8	Positive	.314	B45490	8	Positive	.314
B20212	8	O-Ring	.250	B45492	16	Positive	.341
B20216	8	Square Cut	.302	B45493	8	O-Ring	.155
B20217	12	Shredder	.268	B45497	6	Positive	.341
B20218	12	Positive	.334	B45498	12	Positive	.225
B20219	8	Positive	.314	B45499	8	Positive	.259
B20311	8	Positive	.311	B45521	4	Positive	.259
B45229	8	O-Ring	.280	B45524	4	Positive	.259
B45233	16	O-Ring	.264	B45531	8	Positive	.315
B45264	16	Shedder	.341	B45544	12	Positive	.259
B45283	8	Shedder	.341	B45545	8	Positive	.273
B45296	8	Shedder	.372	B45546	8	Positive	.312
B45298	8	Shedder	.341	B45547	6	Positive	.341
B45299	8	Positive	.341	B45548	8	Positive	.314
B45320	12	Shedder	.311	B45549	16	Positive	.203
B45323	12	Shedder	.372	B45552	8	Square Cut	.277
B45327	8	Shedder	.372	B45556	8	Positive	.203
B45343	16	Shedder	.372	B45560	8	Positive	.372
B45356	6	Shredder	.310	B45562	8	O-Ring	.306
B45373	12	Shedder	.341	B45563	4	Positive	.236
B45377	8	Shedder	.435	B45564	4	Positive	.230
B45387	16	Shedder	.435	B45565	8	Positive	.314
B45390	8	Shedder	.372	B45566	8	Positive	.341
B45399	16	Shedder	.341	B45567	4	Positive	.310
B45403	8	Positive	.372	B45568	8	Positive	.320
B45404	8	Positive	.341	B45571	8	Positive	.275
B45405	8	Shedder	.341	B45575	6	Positive	.312
B45410	4	Positive	.315	B45576	6	Positive	.312
B45411	4	Positive	.315	B45580	8	Positive	.341
B45411A	6	Positive	.315	B45581	8	Positive	.341
B45416	8	Shedder	.341	B45583	6	Positive	.372
B45418	4	Positive	.341	B45588	16	Positive	.275
B45420	8	Shedder	.393	B45590	8	Positive	.275
B45423	8	Positive	.311	B45591	6	Positive	.341
B45429	8	O-Ring	.272	B45591A	8	Positive	.341
B45434	4	Shedder	.314	B45594	12	Positive	.225
B45436	16	Positive	.372	B45595	12	Positive	.217
B45437	8	Positive	.314	B45601	16	Positive	.295
B45438	4	Positive	.259	B45602	6	Positive	.309
B45439	4	Positive	.259	B45603	6	Positive	.322
B45440	4	Positive	.216	B45604	6	Positive	.356
B45441	8	Positive	.314	B45605	6	Positive	.357
B45442	8	Positive	.259	B45611	6	Positive	.312
B45443	8	Shredder	.275	B45612	6	Positive	.312
B45445	12	Positive	.271	B45613	8	Positive	.312
B45447	4	Positive	.275	B45618	16	Positive	.225
B45448	4	Positive	.259	B45622	16	Positive	.214
B45449	8	Positive	.314	B45623	8	Positive	.338
B45454	8	Positive	.236	B45624	8	Shredder	.372
B45457	12	Positive	.290	B45625	8	Positive	.275
B45458	8	Positive	.278	B45626	8	Positive	.185
B45459	4	Positive	.259	B45627	8	Positive	.175
B45460	4	Positive	.259	B45629	4	Positive	.185
B45465	4	Positive	.275	B45630	4	Positive	.175
B45471	4	Positive	.167	B45631	8	Positive	.372
B45472	8	Positive	.259	B45632	8	Positive	.372
B45473	8	Positive	.341	B45657	24	Positive	.203
B45474	8	Positive	.275	B45658	4	Positive	.216
B45475	8	Positive	.234	B45662	8	Shredder	.372
B45476	8	Positive	.275	B45672	16	Positive	.275

Valve Stem Seal Specification Chart Numerical List

Part No.	Std. Pkg.	Type	Nominal Stem Dia.	Part No.	Std. Pkg.	Type	Nominal Stem Dia.
B45674	6	Positive	.290	B45766	8	Positive	.450
B45675	8	Positive	.374	B45767	8	Positive	.311
B45676	8	Positive	.374	B45768	8	Positive	.357
B45677	8	Positive	.203	B45770	8	Positive	.341
B45678	8	Positive	.231	B45773	8	Positive	.326
B45679	8	Positive	.281	B45776	16	Positive	.225
B45683	4	Positive	.278	B45779	16	Shredder	.341
B45690	16	Shredder	.372	B45790	12	Positive	.260
B45722	16	Positive	.178	B45791	8	Positive	.210
B45733	6	Positive	.237	B45792	4	Positive	.203
B45735	8	Positive	.195	B45796	16	Positive	.293
B45736	8	Positive	.205	B45798	6	Positive	.278
B45737	8	Positive	.341	B45798A	8	Positive	.278
B45739	8	Positive	.341	B45798B	4	Positive	.278
B45740	8	Positive	.372	B45798C	10	Positive	.278
B45741	8	Positive	.500	B45799	6	Positive	.275
B45746	8	Positive	.248	B45799A	8	Positive	.275
B45747	8	Positive	.315	B45799B	4	Positive	.275
B45748	8	Positive	.354	B45799C	10	Positive	.275
B45749	8	Positive	.341	B45804	16	Shredder	.352
B45750	8	Positive	.372	B45806	8	Positive	.260
B45751	8	Positive	.372	B45814	8	Positive	.249
B45752	8	Positive	.354	B45830	12	Positive	.203
B45753	8	Positive	.311	B45831	12	Positive	.205
B45754	8	Positive	.341	B45839	6	Positive	.278
B45755	8	Positive	.372	B45840	6	Positive	.280
B45756	8	Positive	.341	B45845	16	Positive	.205
B45757	8	Positive	.372	B45857	8	Positive	.260
B45758	8	Positive	.341	B45866	24	Positive	.194
B45759	8	Positive	.372	B45870	16	Positive	.215
B45760	8	Positive	.372	B45874	8	Shredder	.362
B45761	8	Positive	.372	B45883	12	Positive	.219
B45762	8	Positive	.404	B45888	8	Positive	.290
B45763	8	Positive	.434	B45900	6	Positive	.283
B45764	8	Positive	.434	B45904	4	Positive	.306
B45765	8	Positive	.434				

Harmonic Balancer and Crankshaft Oil Seal Groove Repair Sleeves

1. No need to weld and regrind worn seal surface area.
2. Maximum 0.013" thick sleeve accommodates dual lip oil seals and standard seal lip diameters.
3. 0.0003" - 0.0009" nickel plating protects against corrosion and adds strength for ease of installation.
4. Steel stamped sleeve is swedged on one end for strength and flared on the other end for ease of installation.
5. 0.002" press-fit fixes the sleeve firmly on the shaft.

The 66000RS-Series are .020" thick ground steel. The "A" Series are .013" nickel plated formed steel. An interchange from the ground steel to formed steel version is listed for your convenience.

INTERCHANGE

Ground Steel Number	Nickel Plated Form Steel Number
66590RS	A222
66592RS	A224-1
66593RS	A223-1
66594RS	A225
66595RS	A226-2
66597RS	A228
66598RS	A230
66601RS	A229-1

Harmonic Balancer and Crankshaft Repair Sleeve Installation Tools

Professional type repair sleeve installation tools are available. They are made of durable polyethylene to accommodate each of the sleeve sizes as indicated.

Repair Sleeve Installation Tool

Sleeve Sizes

A500	Installs	A222, A231, A238
A501	Installs	A222-1, A224, A224-1
A502	Installs	A226, A226-1, A226-2, A229-1, A235
A503	Installs	A227, A230, A232
A504	Installs	A221, A225, A228, A228-1, A228-2, A233
A505	Installs	A331, A342
A506	Installs	A332, A336, A338
A507	Installs	A333, A340, A343
A508	Installs	A334, A334G, A344, A345
A509	Installs	A335
A510	Installs	A337, A339
A511	Installs	A341
A512	Installs	A346

Both the harmonic balancer and the crankshaft repair sleeve can be installed using a soft block of wood to absorb the impact of hammer blows. A circular hose in the wooden block is required to accommodate the protrusion on the crankshaft flange which centers the flywheel.

Interchange

The following interchanges GS cylinder head bolt gasket part numbers to the corresponding 216 cylinder head bolt engine part numbers and vice versa.

GS to 216			216 to GS				
GS Nos.	216 Nos.	GS Nos.216 Nos.	216 Nos.	GS Nos.	216 Nos.	GS Nos.	
GS33163	216-7017	GS33267	216-7110	216-7012	GS33357	216-7052.....	GS33225
GS33184	216-7015	GS33269.....	216-7099	216-7014	GS33193	216-7053.....	GS33234
GS33185	216-7016	GS33270.....	216-7112	216-7015	GS33184	216-7054.....	GS33221
GS33189	216-7020	GS33284.....	216-7023	216-7016	GS33185	216-7056.....	GS33240
GS33190	216-7019	GS33285.....	216-7026	216-7017	GS33163	216-7057.....	GS33233
GS33193	216-7014	GS33286.....	216-7027	216-7019	GS33190	216-7058.....	GS33237
GS33194	216-7043	GS33287.....	216-7032	216-7020	GS33189	216-7097.....	GS33347
GS33219	216-7036	GS33292.....	216-7039	216-7021	GS33220	216-7098.....	GS33348
GS33220	216-7021	GS33294.....	216-7127	216-7023	GS33284	216-7099.....	GS33269
GS33221	216-7054	GS33295.....	216-7128	216-7024	GS33242	216-7102.....	GS33349
GS33222	216-7106	GS33314.....	216-7120	216-7025	GS33244	216-7103.....	GS33350
GS33223	216-7034	GS33316.....	216-7038	216-7026	GS33285	216-7104.....	GS33250
GS33224	216-7033	GS33326.....	216-7111	216-7027	GS33286	216-7106.....	GS33222
GS33225	216-7052	GS33328.....	216-7040	216-7032	GS33287	216-7107.....	GS33251
GS33229	216-7050	GS33342.....	216-7121	216-7033	GS33224	216-7109.....	GS33351
GS33232	216-7051	GS33344.....	216-7035	216-7034	GS33223	216-7110.....	GS33267
GS33233	216-7057	GS33345.....	216-7041	216-7035	GS33344	216-7111.....	GS33326
GS33234	216-7053	GS33346.....	216-7042	216-7036	GS33219	216-7112.....	GS33270
GS33237	216-7058	GS33347.....	216-7097	216-7038	GS33316	216-7117.....	GS33353
GS33239	216-7123	GS33348.....	216-7098	216-7039	GS33292	216-7118.....	GS33354
GS33240	216-7056	GS33349.....	216-7102	216-7040	GS33328	216-7120.....	GS33314
GS33242	216-7024	GS33350.....	216-7103	216-7041	GS33345	216-7121.....	GS33342
GS33244	216-7025	GS33351.....	216-7109	216-7042	GS33346	216-7122.....	GS33266
GS33250	216-7104	GS33353.....	216-7117	216-7043	GS33194	216-7123.....	GS33239
GS33251	216-7107	GS33354.....	216-7118	216-7044	GS33255	216-7124.....	GS33355
GS33255	216-7044	GS33355.....	216-7124	216-7050	GS33229	216-7127.....	GS33294
GS33266	216-7122	GS33357.....	216-7012	216-7051	GS33232	216-7128.....	GS33295

TK-950 11-Piece Gasket Hole Punch Set

This set is designed to cut holes and internal radii in gaskets and other soft material such as rubber, lead foil, linoleum, felt fiber and other similar materials. Not suited for metal.

Set contains 5-3/8" long drive mandrel.

Ten punches sized:

1/4"	9/16"
5/16"	5/8"
3/8"	3/4"
7/16"	7/8"
1/2"	1"



TK950 11-Piece Gasket Hole Punch Set

Packed in an attractive molded plastic storage box for protection and easy use.

Gasket Materials



JV6 Bead-N-Seal® Silicone Gasketing (Aluminum)

JV6 is a high temperature resistant, low volatile RTV-gasket material developed specifically for use on engines. It meets the low volatility specifications required of engines equipped with oxygen sensors. The temperature rating for JV6 is -75° to 500° intermittent service. JV6 can be used as a supplement to conventional gaskets, such as oil pan and manifold end seals. Or it can be used as a replacement for most paper type gaskets, such as timing cover and water outlet. It's aluminum color more closely matches today's engine components while providing higher temperature capabilities. JV6 comes in an 80ml syringe style applicator which is packaged in a blister pack for display in retail sales area.



JV66B and JV66S Perfect Seal Sealing Compound

Perfect Seal is available in a 4 oz. brush top can and a 12 oz. spray can. It is recommended as a sealing aid on all steel faced gaskets and cylinder head shims. Perfect Seal is a non-hardening sealer which re-

mains flexible from -30° to +400°F. It helps prevent oil, water, gasoline and vacuum leaks. JV66B and JV66S can also be used as a sealing supplement on bolts, studs and threaded fittings.

Bulk Material

CORAMIC 29®

Coramic 29® is an organically treated facing material mechanically clinched to both sides of a perforated steel core. It has good resistance to oil and gasoline. Applications include exhaust manifold, carburetor and turbocharger gaskets.

FLAT PACKED (One Sheet Per Package)

JV222	1/16" x 10-1/4" x 36"
JV224	1/16" x 24" x 36"

*

CORAMIC 129®

Coramic 129® is the same as Coramic 29® except the facing material is only on one side of the perforated steel core.

FLAT PACKED (One Sheet Per Package)

JV225	1/16" x 12" x 28-1/2"
--------------	-----------------------

*

VICTOCOR®

Victocor® is a hard gasket material composed of a fibrous based sheet with a nitrile binder mechanically clinched to both sides of a perforated steel core. It is resistant to oil, gasoline, water and antifreeze solutions. It's most common usage is as a head gasket and intake manifold gasket material.

FLAT PACKED (One Sheet Per Packaged)

JV222VC	1/16" x 10-1/4" x 36"
----------------	-----------------------

*

NITROSEAL®

Nitroseal® is a pure non-oxidizing graphite facing material on a pierced steel core designed specifically for use on exhaust applications. It has a temperature rating of 1300°F in the clamped state.

FLAT PACKED (One Sheet Per Package)

JV222SG	1/32" x 10-1/4" x 36"
JV313SG	3/64" x 10-1/4" x 36"
JV314SG	1/16" x 10-1/4" x 36"
JV315SG	3/64" x 20" x 40"
JV316SG	1/16" x 20" x 40"

BRASS SHIM STOCK

Roll Packaged – 6" x 200"

9014N	.005"
9015N	.010"

*

CORK-RUBBER SHEETS

ROLL PACKED – 12" X 24" SHEETS

JV121 (One Sheet)	1/16"
JV122 (One Sheet)	3/32"
JV123 (One Sheet)	1/8"

FLAT PACKED – 12" x 36" SHEETS (PRICED PER SHEET)

32504 (Ten Sheets)	1/16"
32505 (Ten Sheets)	3/32"
32506 (Ten Sheets)	1/8"
32507 (Five Sheets)	1/4"

FLAT PACKED – 18" X 36" SHEETS (PRICED PER SHEET)

32607 (Ten Sheets)	1/16"
32608 (Ten Sheets)	3/32"
32609 (Ten Sheets)	1/8"

*

TUFF-CORK®

Cork Composition on a solid steel core.
(One Sheet Per Package)

JV300TC	3/32" x 12" x 24"
JV301TC	3/32" x 18" x 36"

*

CARBONLESS IMPRESSION PAPER

There is an easy and accurate method to check the flatness of mating surfaces sealed by gaskets - carbonless impression paper. This method is particularly useful for checking the flatness of the cylinder head and block where the sealing is critical.

JV311 (Two Sheets)	10" x 30" Sheet
JV312 (Twelve Sheets)	10" x 30" Sheet

Bulk Material

MINERAL BOARD	VICTOPAC®
<p>JV310 1/16" x 10" x 36"</p> <p style="text-align: center;">*</p> <p style="text-align: center;">WIRE WOVEN PACKING</p> <p>Wire inserted woven Flextra cloth. Flextra is a unique yarn and fabric and is a blend of fiberglass and aramid fibers.</p> <p>JV80F 1/16" x 10" x 40"</p> <p style="text-align: center;">*</p> <p style="text-align: center;">VICTOLEX®</p> <p>Latex bound cellulose fiber sheet. A general purpose medium compressibility material. Recommended maximum temperature 300°F. For applications such as gear case covers, water pump mounting, water outlets and timing covers.</p> <p style="text-align: center;">ROLL PACKED – 18" ROLLS</p> <p>JV11F 1/64" x 30 feet JV12F 1/32" x 30 feet JV13F 1/16" x 45 feet (Replacement Rolls for MA10)</p> <p style="text-align: center;">ROLL PACKED – 36" ROLLS</p> <p>JV94F 1/64" x 75 feet JV95F 1/32" x 75 feet JV96F 1/16" x 45 feet (Replacement Rolls for MA93C)</p> <p style="text-align: center;">ROLL PACKED – 12" X 24" SHEETS</p> <p>JV124 (One Sheet) 1/64" JV125 (One Sheet) 1/32" JV126 (One Sheet) 1/16"</p> <p style="text-align: center;">ROLL PACKED – 18" X 36" SHEETS</p> <p>JV100 (One Sheet) 1/64" JV101 (One Sheet) 1/32" JV102 (One Sheet) 1/16"</p>	<p>A high density compressed sheet material with excellent sealability and resistance to fuel, oil and engine coolants. Recommended maximum temperature 500°F. Victopac® is for general purpose applications.</p> <p style="text-align: center;">ROLL PACKED VICTOPAC® (12" x 24" Sheets)</p> <p>JV127 (One Sheet) 1/32" JV128 (One Sheet) 1/16"</p> <p style="text-align: center;">ROLL PACKED VICTOPAC® (25" x 25" Sheets)</p> <p>JV85 (One Sheet) 1/32" JV86 (One Sheet) 1/16"</p> <p style="text-align: center;">ROLL PACKED VICTOPAC® (10" x 50" Sheets)</p> <p>JV210 (One Sheet) 1/32" JV213 (One Sheet) 1/16"</p> <p style="text-align: center;">*</p> <p style="text-align: center;">WATER PUMP PACKING (1/4 lb. Spools)</p> <p>JV231F (Approx. 25 feet) 1/8" Thick JV234F (Approx. 11-1/4 feet) 3/16" Thick JV237F (Approx. 7-1/2 feet) 1/4" Thick</p>

Assortments

“SINGLE PREFIX” Jobber Stocking Assortments

MA51EV, MA52EV and **FR25B** are intended to aid in the initial stocking and replenishment of miscellaneous “single prefix” gaskets. These assortments contain 20% of the single prefix part numbers, all of which have nationwide usage.

MA51EV contains water outlet “C”, fuel pump “D”, exhaust flange “F”, carburetor “G”, axle flange “J”, water pump “K” and differential “P” series gaskets (210 part numbers).

MA52EV contains valve stem seals “B” and automatic transmission pan gaskets “W” series (70 part numbers).

FR25B contains exhaust packing ring “donut” gaskets “F” series (25 part numbers).

These three assortments will give breadth to your inventory.

“O” Ring Assortments

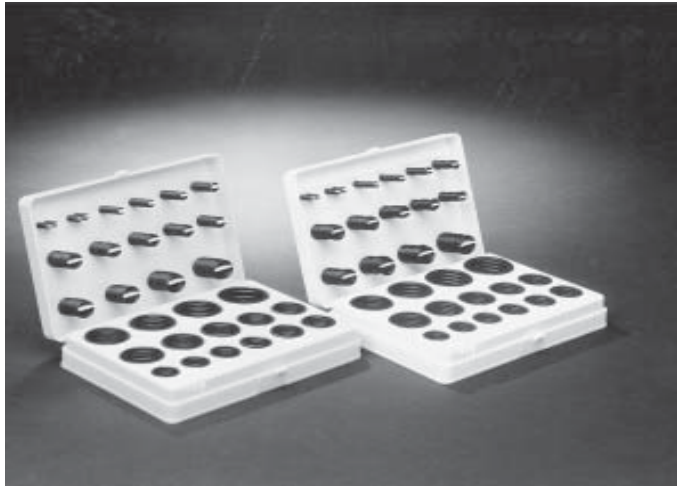

Each assortment contains the 30 most popular “O” rings in a sturdy plastic case. Detailed dimension information is attached to each one. Durable “O” ring material is made to be compatible with petroleum base lubricants, hydraulic oil, gasoline alcohol, LP gas and water. Available in standard and metric size assortments.

72502 Standard “O” Ring Assortment

72503 Metric “O” Ring Assortment

72502 STANDARD KIT CONTENTS			72503 METRIC KIT CONTENTS		
Part No.	Size in Inches (“) I.D. x O.D. x Width	Quantity	Part No.	Size in Metrics (mm) I.D. x Width	Quantity
72006	1/8 x 1/4 x 1/16	20	72600	3 x 2	16
72007	5/32 x 9/32 x 1/16	20	72601	4 x 2	16
72008	3/16 x 5/16 x 1/16	20	72602	5 x 2	16
72009	7/32 x 11/32 x 1/16	20	72603	6 x 2	16
72010	1/4 x 3/8 x 1/16	20	72604	7 x 2	16
72011	5/16 x 7/16 x 1/16	20	72605	8 x 2	16
72012	3/8 x 1/2 x 1/16	20	72606	10 x 2	16
72110	3/8 x 9/16 x 3/32	13	72607	10 x 2.5	13
72111	7/16 x 5/8 x 3/32	13	72608	11 x 2.5	13
72112	1/2 x 11/16 x 3/32	13	72609	12 x 2.5	13
72113	9/16 x 3/4 x 3/32	13	72610	14 x 2.5	13
72114	5/8 x 3/4 x 3/32	13	72611	16 x 2.5	13
72115	11/16 x 7/8 x 3/32	13	72612	17 x 2.5	13
72116	3/4 x 5/16 x 3/32	13	72613	19 x 2.5	13
72210	3/4 x 1 x 1/8	10	72614	19 x 3	12
72211	13/16 x 1-1/16 x 1/8	10	72615	20 x 3	12
72212	7/8 x 1-1/8 x 1/8	10	72616	22 x 3	12
72213	15/16 x 1-3/16 x 1/8	10	72617	24 x 3	12
72214	1 x 1-1/4 x 1/8	10	72618	25 x 3	12
72215	1-1/16 x 1-5/16 x 1/8	10	72619	27 x 3	12
72216	1-1/8 x 1-3/8 x 1/8	10	72620	28 x 3	12
72217	1-3/16 x 1-7/16 x 1/8	10	72621	30 x 3	12
72218	1-1/4 x 1-1/2 x 1/8	10	72622	32 x 3	12
72219	1-5/16 x 1-9/16 x 1/8	10	72623	33 x 3	12
72220	1-3/8 x 1-5/8 x 1/8	10	72624	35 x 3	12
72221	1-7/16 x 1-11/16 x 1/8	10	72625	36 x 3	12
72222	1-1/2 x 1-3/4 x 1/8	10	72626	38 x 3	12
72325	1-1/2 x 1-7/8 x 3/16	7	72627	38 x 4	9
72326	1-5/8 x 2 x 3/16	7	72628	41 x 4	9
72327	1-3/4 x 2-1/8 x 3/16	7	72629	44 x 4	9

“O” Ring Size Listing

Part Number	Actual Size		Nominal Size I.D. X O.D. X W.	Part Number	Actual Size		Nominal Size I.D. X O.D. X W.
	Width	Inside Diameter			Width	Inside Diameter	
72001	.040 ± .003	.029 ± .004	1/32 X 3/32 X 1/32	72127	.103 ± .003	1.424 ± .006	1 7/16 X 1 5/8 X 3/32
72002	.050 ± .003	.042 ± .004	3/64 X 9/64 X 3/64	72128	.103 ± .003	1.487 ± .006	1 1/2 X 1 11/16 X 3/32
72003	.060 ± .003	.056 ± .004	1/16 X 3/16 X 1/16	72129	.103 ± .003	1.549 ± .010	1 9/16 X 1 3/4 X 3/32
72004	.070 ± .003	.070 ± .004	5/64 X 13/64 X 1/16	72130	.103 ± .003	1.612 ± .010	1 5/8 X 1 13/16 X 3/32
72005	.070 ± .003	.100 ± .005	3/32 X 7/32 X 1/16	72131	.103 ± .003	1.674 ± .010	1 11/16 X 1 7/8 X 3/32
* 72006	.070 ± .003	.114 ± .005	1/8 X 1/4 X 1/16	72132	.103 ± .003	1.737 ± .010	1 3/4 X 1 15/16 X 3/32
* 72007	.070 ± .003	.145 ± .005	5/32 X 9/32 X 1/16	72133	.103 ± .003	1.799 ± .010	1 13/16 X 2 X 3/32
* 72008	.070 ± .003	.176 ± .005	3/16 X 5/16 X 1/16	72134	.103 ± .003	1.862 ± .010	1 7/8 X 2 1/16 X 3/32
* 72009	.070 ± .003	.208 ± .005	7/32 X 11/32 X 1/16	72136	.103 ± .003	1.987 ± .010	2 X 2 3/16 X 3/32
* 72010	.070 ± .003	.239 ± .005	1/4 X 3/8 X 1/16	72137	.103 ± .003	2.050 ± .010	2 1/16 X 2 1/4 X 3/32
* 72011	.070 ± .003	.301 ± .005	5/16 X 7/16 X 1/16	72138	.103 ± .003	2.112 ± .010	2 1/8 X 2 5/16 X 3/32
* 72012	.070 ± .003	.364 ± .005	3/8 X 1/2 X 1/16	72139	.103 ± .003	2.175 ± .010	2 3/16 X 2 3/8 X 3/32
72013	.070 ± .003	.426 ± .005	7/16 X 9/16 X 1/16	72140	.103 ± .003	2.237 ± .010	2 1/4 X 2 7/16 X 3/32
72014	.070 ± .003	.489 ± .005	1/2 X 5/8 X 1/16	72141	.103 ± .003	2.300 ± .010	2 5/16 X 2 1/2 X 3/32
72015	.070 ± .003	.551 ± .005	9/16 X 11/16 X 1/16	72142	.103 ± .003	2.362 ± .010	2 3/8 X 2 9/16 X 3/32
72016	.070 ± .003	.614 ± .005	5/8 X 3/4 X 1/16	72143	.103 ± .003	2.425 ± .010	2 7/16 X 2 5/8 X 3/32
72017	.070 ± .003	.676 ± .005	11/16 X 13/16 X 1/16	72144	.103 ± .003	2.487 ± .010	2 1/2 X 2 11/16 X 3/32
72018	.070 ± .003	.739 ± .005	3/4 X 7/8 X 1/16	72146	.103 ± .003	2.612 ± .010	2 5/8 X 2 13/16 X 3/32
72019	.070 ± .003	.801 ± .006	13/16 X 15/16 X 1/16	72148	.103 ± .003	2.737 ± .015	2 3/4 X 2 15/16 X 3/32
72020	.070 ± .003	.864 ± .006	7/8 X 1 X 1/16	72149	.103 ± .003	2.800 ± .015	2 13/16 X 3 X 3/32
72021	.070 ± .003	.926 ± .006	15/16 X 1 1/16 X 1/16	72151	.103 ± .003	2.987 ± .015	3 X 3 3/16 X 3/32
72022	.070 ± .003	.989 ± .006	1 X 1 1/8 X 1/16	72152	.103 ± .003	3.237 ± .015	3 1/4 X 3 7/16 X 3/32
72023	.070 ± .003	1.051 ± .006	1 1/16 X 1 3/16 X 1/16	72153	.103 ± .003	3.487 ± .015	3 1/2 X 3 11/16 X 3/32
72024	.070 ± .003	1.114 ± .006	1 1/8 X 1 1/4 X 1/16	72158	.103 ± .003	4.737 ± .015	4 3/4 X 4 15/16 X 3/32
72025	.070 ± .003	1.176 ± .006	1 3/16 X 1 5/16 X 1/16	* 72210	.139 ± .004	.734 ± .006	3/4 X 1 X 1/8
72026	.070 ± .003	1.239 ± .006	1 1/4 X 1 3/8 X 1/16	* 72211	.139 ± .004	.796 ± .006	13/16 X 1 1/16 X 1/8
72027	.070 ± .003	1.301 ± .006	1 5/16 X 1 7/16 X 1/16	* 72212	.139 ± .004	.859 ± .006	7/8 X 1 1/8 X 1/8
72028	.070 ± .003	1.364 ± .006	1 3/8 X 1 1/2 X 1/16	* 72213	.139 ± .004	.921 ± .006	15/16 X 1 3/16 X 1/8
72029	.070 ± .003	1.489 ± .010	1 1/2 X 1 5/8 X 1/16	* 72214	.139 ± .004	.984 ± .006	1 X 1 1/4 X 1/8
72030	.070 ± .003	1.614 ± .010	1 5/8 X 1 3/4 X 1/16	* 72215	.139 ± .004	1.046 ± .006	1 1/16 X 1 5/16 X 1/8
72031	.070 ± .003	1.739 ± .010	1 3/4 X 1 7/8 X 1/16	* 72216	.139 ± .004	1.109 ± .006	1 1/8 X 1 3/8 X 1/8
72032	.070 ± .003	1.864 ± .010	1 7/8 X 2 X 1/16	* 72217	.139 ± .004	1.171 ± .006	1 3/16 X 1 7/16 X 1/8
72034	.070 ± .003	2.114 ± .010	2 1/8 X 2 1/4 X 1/16	* 72218	.139 ± .004	1.234 ± .006	1 1/4 X 1 1/2 X 1/8
72035	.070 ± .003	2.239 ± .010	2 1/4 X 2 3/8 X 1/16	* 72219	.139 ± .004	1.296 ± .006	1 5/16 X 1 9/16 X 1/8
72039	.070 ± .003	2.739 ± .015	2 3/4 X 2 7/8 X 1/16	* 72220	.139 ± .004	1.359 ± .006	1 3/8 X 1 5/8 X 1/8
72040	.070 ± .003	2.864 ± .015	2 7/8 X 3 X 1/16	* 72221	.139 ± .004	1.421 ± .006	1 7/16 X 1 11/16 X 1/8
72042	.070 ± .003	3.239 ± .015	3 1/4 X 3 3/8 X 1/16	* 72222	.139 ± .004	1.484 ± .006	1 1/2 X 1 3/4 X 1/8
72043	.070 ± .003	3.489 ± .015	3 1/2 X 3 5/8 X 1/16	72223	.139 ± .004	1.609 ± .010	1 5/8 X 1 7/8 X 1/8
* 72110	.103 ± .003	.362 ± .005	3/8 X 9/16 X 3/32	72224	.139 ± .004	1.734 ± .010	1 3/4 X 2 X 1/8
* 72111	.103 ± .003	.424 ± .005	7/16 X 5/8 X 3/32	72225	.139 ± .004	1.859 ± .010	1 7/8 X 2 1/8 X 1/8
* 72112	.103 ± .003	.487 ± .005	1/2 X 11/16 X 3/32	72226	.139 ± .004	1.984 ± .010	2 X 2 1/4 X 1/8
* 72113	.103 ± .003	.549 ± .005	9/16 X 3/4 X 3/32	72228	.139 ± .004	2.234 ± .010	2 1/4 X 2 1/2 X 1/8
* 72114	.103 ± .003	.612 ± .005	5/8 X 13/16 X 3/32	72229	.139 ± .004	2.359 ± .010	2 3/8 X 2 5/8 X 1/8
* 72115	.103 ± .003	.674 ± .005	11/16 X 7/8 X 3/32	72230	.139 ± .004	2.484 ± .010	2 1/2 X 2 3/4 X 1/8
* 72116	.103 ± .003	.737 ± .005	3/4 X 15/16 X 3/32	72231	.139 ± .004	2.609 ± .010	2 5/8 X 2 7/8 X 1/8
72117	.103 ± .003	.799 ± .006	13/16 X 1 X 3/32	72232	.139 ± .004	2.734 ± .015	2 3/4 X 3 X 1/8
72118	.103 ± .003	.862 ± .006	7/8 X 1 1/16 X 3/32	72234	.139 ± .004	2.984 ± .015	3 X 3 1/4 X 1/8
72119	.103 ± .003	.924 ± .006	15/16 X 1 1/8 X 3/32	72235	.139 ± .004	3.109 ± .015	3 1/8 X 3 3/8 X 1/8
72120	.103 ± .003	.987 ± .006	1 X 1 3/16 X 3/32	72236	.139 ± .004	3.234 ± .015	3 1/4 X 3 1/2 X 1/8
72121	.103 ± .003	1.049 ± .006	1 1/16 X 1 1/2 X 3/32	72237	.139 ± .004	3.359 ± .024	3 3/8 X 3 5/8 X 1/8
72122	.103 ± .003	1.112 ± .006	1 1/8 X 1 5/16 X 3/32	72238	.139 ± .004	3.484 ± .015	3 1/2 X 3 3/4 X 1/8
72123	.103 ± .003	1.174 ± .006	1 3/16 X 1 3/8 X 3/32	72239	.139 ± .004	3.609 ± .015	3 5/8 X 3 7/8 X 1/8
72124	.103 ± .003	1.237 ± .006	1 1/4 X 1 7/16 X 3/32	72242	.139 ± .004	3.984 ± .015	4 X 4 1/4 X 1/8
72125	.103 ± .003	1.299 ± .006	1 5/16 X 1 1/2 X 3/32	72248	.139 ± .004	4.734 ± .015	4 3/4 X 5 X 1/8
72126	.103 ± .003	1.362 ± .006	1 3/8 X 1 9/16 X 3/32	72249	.139 ± .004	4.859 ± .015	4 7/8 X 5 1/8 X 1/8

* In O-Ring Assortment 72502

“O” Ring Size Listing

Part Number	Actual Size		Nominal Size I.D. X O.D. X W.	Part Number	Actual Size		Nominal Size I.D. X O.D. X W.
	Width	Inside Diameter			Width	Inside Diameter	
72252	.139 ± .004	5.234 ± .023	5 1/4 X 5 1/2 X 1/8	72342	.210 ± .005	3.600 ± .015	3 5/8 X 4 X 3/16
72265	.139 ± .004	7.734 ± .030	7 3/4 X 8 X 1/8	72343	.210 ± .005	3.725 ± .015	3 3/4 X 4 1/8 X 3/16
* 72325	.210 ± .005	1.475 ± .010	1 1/2 X 1 7/8 X 3/16	72345	.210 ± .005	3.975 ± .015	4 X 4 3/8 X 3/16
* 72326	.210 ± .005	1.600 ± .010	1 5/8 X 2 X 3/16	72426	.275 ± .006	4.600 ± .015	4 5/8 X 5 1/8 X 1/4
* 72327	.210 ± .005	1.725 ± .010	1 3/4 X 2 1/8 X 3/16	72433	.275 ± .006	5.475 ± .023	5 1/2 X 6 X 1/4
72329	.210 ± .005	1.975 ± .010	2 X 2 3/8 X 3/16	72443	.275 ± .006	7.475 ± .030	7 1/2 X 8 X 1/4
72330	.210 ± .005	2.100 ± .010	2 1/8 X 2 1/2 X 3/16	72446	.275 ± .006	8.475 ± .030	8 1/2 X 9 X 1/4
72331	.210 ± .005	2.225 ± .010	2 1/4 X 2 5/8 X 3/16				
72332	.210 ± .005	2.350 ± .010	2 3/8 X 2 3/4 X 3/16				
72333	.210 ± .005	2.475 ± .010	2 1/2 X 2 7/8 X 3/16				
72334	.210 ± .005	2.600 ± .010	2 5/8 X 3 X 3/16				
72335	.210 ± .005	2.725 ± .015	2 3/4 X 3 1/8 X 3/16				
72336	.210 ± .005	2.850 ± .015	2 7/8 X 3 1/4 X 3/16				
72337	.210 ± .005	2.975 ± .015	3 X 3 3/8 X 3/16				
72340	.210 ± .005	3.350 ± .015	3 3/8 X 3 3/4 X 3/16				

* In O-Ring Assortment 72502

“O” Ring Sealing Fluid Check

The chemicals in many fluids used in industry can have a harmful effect upon the synthetic compound in an “O” Ring. To guide you in the use of “O” Rings, check the type of fluid you will be sealing against this list.

May Be Used To Seal	Should Not Be Used To Seal
<ul style="list-style-type: none"> • Acetylene • Air Oxygen • Alcohols - Methyl and Ethyl • All Inert Gases • Ammonia Gas • Chemical Salt Solutions • Coolant Fluids, Ethylene Glycols • Diesel Fuels • Diesel Lubrication Oils • Formaldehyde • Freon 12, 14 • Gases • Gasolines up to 30% Aromatic Content • Glucose • Glycerol • Greases • Linseed Oil • L. P. Gas • Mild Acids • Mild Alkalies 	<ul style="list-style-type: none"> • Petroleum Hydraulic Fluids • Petroleum Lubricating Fluids • Soap and Detergent Solutions • Turpentine • Acids over 10% Concentration • Castor Oil Base Automotive Brake Fluids • Chlorinated Solvents • E. P. Lubricants containing additives which liberate free sulfur or chlorine (Use with caution) • Furfural • Lacquers • Nitric Acid (Any concentrations) • Organic Ester Base Fluids • Pydraul • Skydrol

Stocking and Merchandising Aids

MA54F Small Gasket Service Center

- Easy to stock - Easy to use.
- Stocks all your small gasket needs.
- Extra-heavy duty construction.
- P & W series gaskets can be stocked in the easy to use rack on the bottom shelf.
- Drawers are mounted on rollers (with stops) for your convenience.
- Stock control cards not included. Order **MA54FIC** for stock control cards.

Order **MA51EV**, **MA52EV** and **FR25B** stocking assortments for complete breadth of stock. Order the "Top-Ten" assortments for added depth of inventory.



MA10 Dispenser For 18" Victolex® Rolls

This assortment contains the three most popular Victolex® roll thickness and a wire display/dispensing rack with color header. Victolex® is a general purpose sheet cellulose fiber gasket material recommended for use where temperatures do not exceed 300° F.

Rolls are also available separately for replenishing stock:

JV11F	1/64" x 18" x 30 feet
JV12F	1/32" x 18" x 30 feet
JV13F	1/16" x 18" x 10 feet



Stocking and Merchandising Aids

MA147P Dealer Assortment Board

Consists of pegboard, hooks and decal sheets listing for all exhaust pipe and water outlet gaskets for both domestic and imported vehicles. Order Silhouette separately (*See below*).

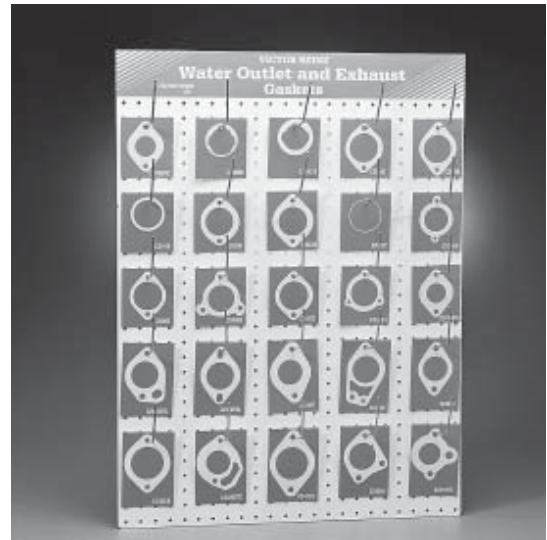

MA147SE MA147SW MA147BL Silhouette For Dealer Assortment Board

Order **MA147SE** for exhaust pipe gasket silhouettes and **MA147SW** for water outlet gasket silhouettes. Order **MA147BL** for blank cards (10 per package).



JV-1 Handi-Pak®

The Handi-Pak® is an assortment of cork/rubber, Victolex® and Victopac® gasket materials in small, easy-to-use sheets. It's perfect for homeowners' DIY projects or for small repair jobs in auto shops.



Stocking and Merchandising Aids

Jobber Stocking Boxes

These sturdy, white corrugated display/stocking boxes are made to organize small gaskets on stockroom shelves or in retail displays. The chart below will help you determine the sizes you need.

Part No.	Size (Inches)	Series
BX1	5-1/2h x 6-1/8w x 12d	B, C and D
BX2	7-1/2h x 7-1/2w x 12d	F, G and H
BX3	9-3/4h x 10w x 12d	J, K and L
BX4	14-3/4h x 14-1/2w x 12d	P,T and W



Jobber Stocking Envelopes

Ploy bags and Insert Cars (EN1, EN2 and EN3) or Envelopes (EN4). Ideal for repackaging gaskets to freshen stock.

Part Series	No.	Size (Inches)	Qty.
EN1	4-1/2" x 6-3/4"	20	B, C and D
EN2	7" x 8"	20	F, G and H
EN3	9" x 10-1/2"	10	J, K and L
EN4	14-3/4" x 17-7/8"	5	N, P, T and W



MA159 Wire Stocking Rack

Perfect for stocking larger flat gaskets like valve cover, manifold and head gaskets. Organize your inventory, maximize space and keep popular stock numbers in an easy-to-access file system. Consists of five enameled wire racks. (Color: Gray)

Dimensions: 5"h x 12 1/8"w x 46" l

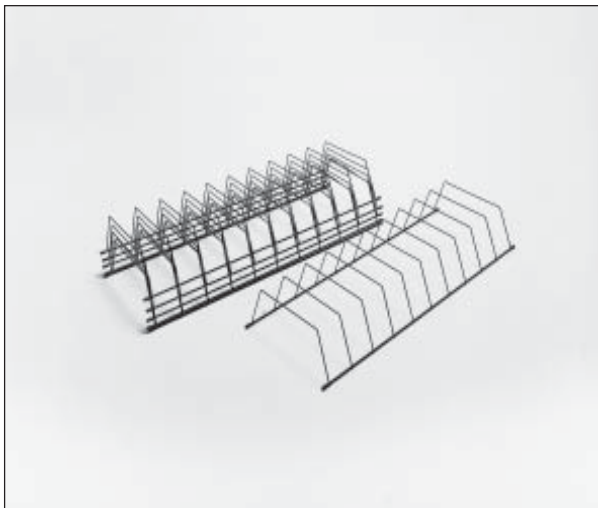

Measurement Equivalents

FRACTION	DECIMAL	MILLIMETERS
1/64	.01563	.3969
1/32	.03125	.7938
	.03937	1.0000
3/64	.04688	1.1906
1/16	.06250	1.5875
5/64	.07813	1.9844
	.07874	2.0000
3/32	.09375	2.3813
7/64	.10938	2.7781
	.11811	3.0000
1/8	.12500	3.1750
9/64	.14063	3.5719
5/32	.15625	3.9688
	.15748	4.0000
11/64	.17188	4.3656
3/16	.18750	4.7625
	.19685	5.0000
13/64	.20313	5.1594
7/32	.21875	5.5563
15/64	.23438	5.9531
	.23622	6.0000
1/4	.25000	6.3500
17/64	.26563	6.7469
	.27559	7.0000
9/32	.28125	7.1438
19/64	.29688	7.5406
5/16	.31250	7.9375
	.31496	8.0000
21/64	.32813	8.3344
11/32	.34375	8.7313
	.35433	9.0000
23/64	.35938	9.1281
3/8	.37500	9.5250
25/64	.39063	9.9219
	.39370	10.0000
13/32	.40625	10.3188
27/64	.42188	10.7156
	.43307	11.0000
7/16	.43750	11.1125
29/64	.45313	11.5094
15/32	.46875	11.9063
	.47244	12.0000
31/64	.48438	12.3031
1/2	.50000	12.7000

FRACTION	DECIMAL	MILLIMETERS
	.51181	13.0000
33/64	.51563	13.0969
17/32	.53125	13.4938
35/64	.54688	13.8906
	.55118	14.0000
9/16	.56250	14.2875
37/64	.57813	14.6844
	.59055	15.0000
19/32	.59375	15.0813
39/64	.60938	15.4781
5/8	.62500	15.8750
	.62992	16.0000
41/64	.64063	16.2719
21/32	.65625	16.6688
	.66929	17.0000
43/64	.67188	17.0656
11/16	.68750	17.4625
45/64	.70313	17.8594
	.70866	18.0000
23/32	.71875	18.2563
47/64	.73438	18.6531
	.74803	19.0000
3/4	.75000	19.0500
49/64	.76563	19.4469
25/32	.78125	19.8438
	.78740	20.0000
51/64	.79688	20.2406
13/16	.81250	20.6375
	.82677	21.0000
53/64	.82813	21.0344
27/32	.84375	21.4313
55/64	.85938	21.8281
	.86614	22.0000
7/8	.87500	22.2250
57/64	.89063	22.6219
	.90551	23.0000
29/32	.90625	23.0188
59/64	.92188	23.4156
15/16	.93750	23.8125
	.94488	24.0000
61/64	.95313	24.2094
31/32	.96875	24.6063
	.98425	25.0000
63/64	.98438	25.0031
1	1.00000	25.4000

